



kitchen think

Instructions for Installation and Use

Electric Multifunction Oven
Models SD97PEI, SD97PEH

To the Installer

Before installation fill in the product details on the back cover this book.
The information can be found on the rating plate.

To the User

You must read the instructions prior to installing and using the appliance and
then retain them for future reference.

CONTENTS

INTRODUCTION	3
FOR YOUR SAFETY	4
KNOW YOUR OVEN	5
HOW TO USE YOUR APPLIANCE	6
PROGRAMMING THE COOKING MODE	8
AUTOMATIC CLEANING WITH THE FAST CLEAN FUNCTION	9
DO NOT WORRY IF	9
FAST CLEAN PROGRAMMING	10
PRACTICAL COOKING ADVICE	11
HOW TO KEEP YOUR OVEN IN SHAPE	14
INSTALLATION	15
TROUBLESHOOTING	16
INSTALLATION	16
ELECTRICAL CONNECTION	17
After Sales Service	18
Guarantee	19
Key Contacts	Back Cover

Retention of this Instruction Book

This Instruction Book must be kept handy for reference as it contains important details on the safe and proper use of the appliance.

If you sell or pass the appliance to someone else, or move house and leave it behind, make sure this Book is also provided so the new owner can become familiar with the appliance and safety warnings.

If the Book is lost or damaged a copy may be obtained from:
INDESIT Company UK LTD, Morley Way, Peterborough, PE2 9JB



Introduction

Your new electric oven is guaranteed* and will give lasting service. This guarantee is only applicable if the appliance has been installed in accordance with the installation instructions detailed in this booklet.

To help make best use of your cooking equipment, please read this booklet carefully.

The oven is designed specifically for domestic use and responsibility will not be accepted for use in any other installation.

Note: When the oven is first used, an odour may be omitted - this will cease after a short period of use.

To help remove the 'new' smell, heat the empty oven to maximum temperature for a minimum of two to three hours, keeping the door/s closed. Ensure that the room is well ventilated (eg. open a window or use an extractor fan) and that persons who may be sensitive to the odour avoid any fumes. It is suggested that any pets be removed from the room until the smell has ceased.

This odour is due to any temporary finish on oven linings and elements and any moisture absorbed by the insulation.

*** The guarantee is subject to the provisions that the appliance:**

- (a) Has been used solely in accordance with this booklet.**
- (b) Has been properly connected to a suitable supply voltage as stated on the rating plate, attached to the appliance.**
- (c) Has not been subjected to misuse or accident or been modified or repaired by any person other than the manufacturers authorised employee or agent.**
- (d) Has been correctly installed.**

For Your Safety

When used properly your appliance is completely safe but as with any electrical product there are certain precautions that must be observed.

PLEASE READ THE BELOW PRECAUTIONS BEFORE USING YOUR APPLIANCE.

To maintain the efficiency and safety of this appliance, we recommend you do the following:

- only call the Service Centres authorised by the manufacturer.
- always use genuine spare parts.

ALWAYS:

- make sure you remove all packaging and literature from inside the appliance before switching on for the first time.
- check the soundness of the appliance after it has been unpacked.
- make sure you understand the controls before using the appliance.
- keep children away from the appliance during use, as surfaces will get extremely hot during and after cooking. Care should be taken to avoid touching the heating elements inside the oven during use.
- make sure the controls are turned off when you have finished cooking and when not in use.
- grip the handle in the centre when opening the door.
- stand back when opening the door to allow any build up of steam or heat to disperse.
- use dry, good quality oven gloves when removing items.
- take care to avoid heat/steam burns when operating the controls.
- switch off the electricity supply at the wall switch, and allow to cool, before cleaning or performing maintenance..
- make sure the shelves are in the correct position before switching on the oven.
- keep the door closed when the appliance is not in use.
- keep the appliance clean as a build up of grease or fat from cooking can cause a fire.
- follow the basic principles of food handling and hygiene to prevent the possibility of bacterial growth.
- keep any ventilation slots clear of obstructions.

NEVER:

- attempt to install or repair the appliance without the assistance of qualified personnel.
- remove the oven shelves whilst the oven is hot.
- allow anyone to sit or stand on any part of the appliance.
- store items above the appliance that children may attempt to reach.
- heat up unopened food containers, as pressure can build up causing the container to burst.
- use the appliance to heat up anything other than food.
- use the appliance as a room heater.
- use the grill to warm plates.
- dry items on the oven doors.
- install the appliance next to curtains of other soft furnishings.
- allow children to play with or tamper with the controls.
- use steam cleaners.
- use the oven for storage purposes.
- use flammable liquids near the appliance.
- use adapters, multiple sockets and/or extension leads.
- pull on the appliance or the supply cable to unplug it from the electrical outlet.
- allow power cables of other appliances to come into contact with hot parts of this appliance.
- expose the appliance to atmospheric agents, such as rain or sunlight.
- operate the appliance with wet hands.
- operate the appliance when barefoot.

Know your Oven

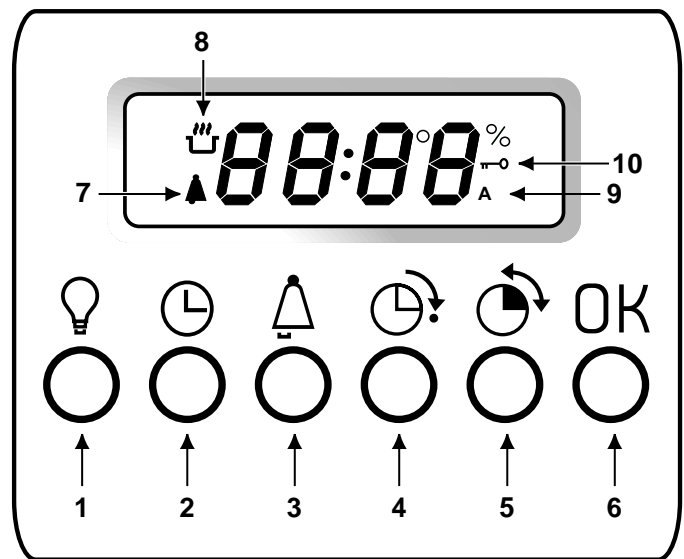
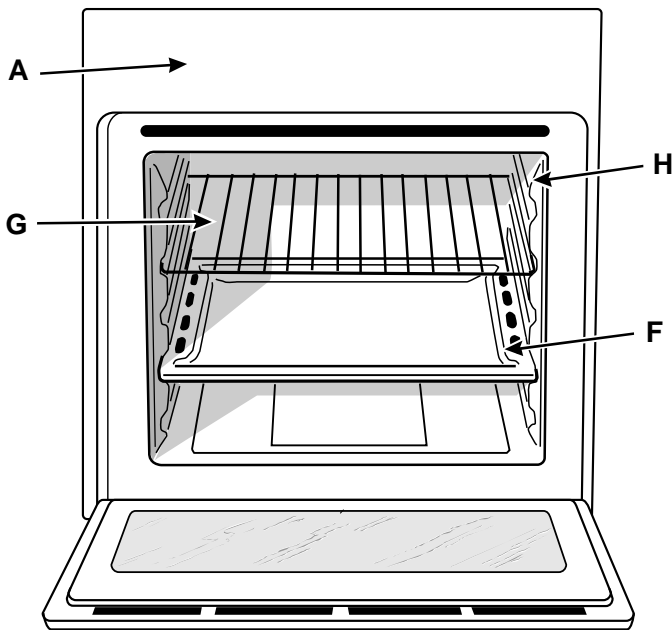
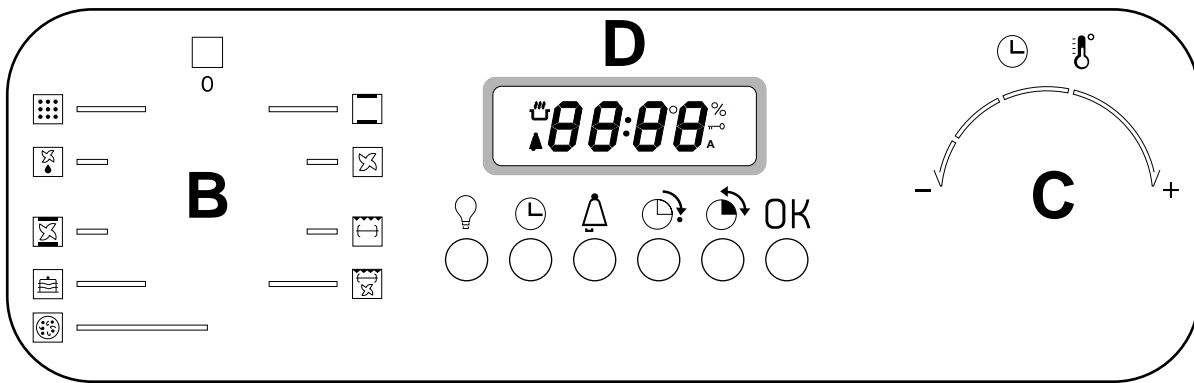

- A. **Control Panel**
- B. **Cooking mode selection knob**
- C. **Cooking temperature selection knob**
- D. **Electronic programmer** - Allows you to programme the desired cooking mode by selecting the cooking time and the end cooking time. It can also be used as a timer.
- F. **Dripping Pan or Baking Sheet**
- G. **Oven Rack**
- H. **Guides for sliding the racks or dripping pan in and out**

- 1. **Oven Light**
- 2. **Clock adjustment**
- 3. **Timer adjustment**
- 4. **End cooking time**
- 5. **Cooking time**
- 6. **Setting confirmation**
- 7. **Timer indicator**
- 8. **Pre-heating (flashing) or cooking (on) under way indicator**
- 9. **Programming complete indicator**
- 10. **Door lock indicator**

How to use your appliance

The **7 Cuochi** oven combines the advantages of traditional convection ovens with those of the more modern fan assisted models in a single appliance.

It is an extremely versatile appliance that allows you to choose easily and safely between 7 different cooking modes. The various features offered by the oven are selected by means of selector knob “**B**” situated on the control panel.

Notice: The first time you use your appliance, we recommend that you set the thermostat to the highest setting and leave the oven on for at least half an hour with nothing in it, with the oven door shut. Then, open the oven door and let the room air. The odour that is often detected during this initial use is due to the evaporation of substances used to protect the oven during storage and until it is installed.

Setting the digital clock

The time can only be set on the clock when knob “**B**” is in position **0**.

After the appliance has been connected to the power supply, or when the power has gone out, the clock display will automatically reset to 0:00 and begin to blink. **0.00**.

Turn knob **C** to set the hours and then press **OK** to confirm. Turn knob **C** again to set the minutes and then press **OK** to confirm the time definitively. Any changes can be made by pressing button **2** and following the above procedure.

Timer Feature

The timer does not control the starting or stopping of the oven, it merely sounds a buzzer when the time is up and can be interrupted at any time just by pressing a button. To set the timer, press button **3**, adjust it using knob **C** and then press the **OK** button to confirm. The  icon will remind you the timer is on.

Once the countdown is over, a buzzer will sound, and will stop doing so after 1 minute or if you press any button whatsoever.

The oven light

It can be turned on at any time with the oven turned off, simply by pressing button **1** or by opening the oven door.

Cooling ventilation

In order to reduce the temperature of the exterior of the oven, a cooling fan generates a flow of air that can be heard exiting between the oven door and the control panel.

Note: When cooking is done, the fan stays on until the oven cools down sufficiently.

Note: In “Fast cooking” mode, the fan comes on automatically only when the oven is hot.

Reminder: the appliance is fitted with a diagnosis system which detects any malfunctions. The user is informed of the latter by messages such as “Fn m” that come up on the display (*n* and *m* = single digit numbers). In these cases, you need to call for technical assistance as the oven is faulty.

How To Use Your Oven

Turn knob **B** to select the desired cooking mode. The oven will immediately start the pre-heating phase, during which the icon  will flash on the display, and the cooking temperature associated with the mode selected will be displayed: should this value not be the one you desire, you can modify it simply by turning knob **C**.

Once pre-heating is complete, an acoustic signal will sound and the icon  will come on permanently, and at this stage you can place the food to be cooked inside the pre-heated oven.

Note: the **FAST COOKING** and **GRILL** modes do not include a pre-heating phase. Please remember that you can always do the following when cooking is under way:

- change the cooking mode by turning knob “**B**”;
- change the temperature by turning knob “**C**”;
- programme the cooking time and end cooking time (see paragraph entitled “Programming the cooking mode”).
- stop it at any time by setting knob “**B**” back to **0**.

Note: For safety reasons, a cooking time of 2 hours is set for each cooking mode by default. Should this time fail to be adjusted, the oven will be automatically turned off once this time is up.

Notice: Place the oven tray provided on the bottom shelf of the oven to prevent any sauce and/or grease from dripping onto the bottom of the oven only when grilling food or when using the turnspit (only available on certain models). For all other types of cooking, never use the bottom shelf and never place anything on the bottom of the oven when it is in operation because this could damage the enamel coating. Always place your cookware (dishes, aluminium foil, etc. etc.) on the grid provided with the appliance inserted especially along the oven guides.

Convection Oven

Position of thermostat knob “**C**”: Between **40°C** and **250°C**. On this setting, the top and bottom heating elements come on. This is the classic, traditional type of oven which has been perfected, with exceptional heat distribution and reduced energy consumption. The convection oven is still unequalled when it comes to cooking dishes made up of several ingredients, e.g. cabbage with ribs, local stockfish recipes, tender veal with rice, etc. Excellent results are achieved when preparing meat-based dishes as well: braised meats, stew, goulash, game, ham etc. which need to cook slowly and require basting or the addition of liquid. It nonetheless remains the best system for baking cakes and pastries as well as fruit and cooking casseroles. When cooking in convection mode, use only one rack, as the temperature would not be distributed evenly on several racks. Using the different rack heights available, you can balance the amount of heat between the top and the bottom of the oven. Select from among the various rack heights based on whether the dish needs more or less heat from the top.

Multi-Cooking Mode

Position of thermostat knob “**C**”: Between **40°C** and **250°C**. The heating elements and the fan come on alternately. Since the heat remains constant and uniform throughout the oven, the air cooks and browns food uniformly over its entire surface. With this mode, you can also cook various dishes at the same time, as long as their respective cooking temperatures are the same. A maximum of 2 racks can be used at the same time, following the instructions in the section entitled: “Cooking On More Than One Rack”.

This cooking mode is particularly recommended for dishes requiring a gratin finish or for those requiring considerably prolonged cooking times, such as for example: lasagne, pasta

bakes, roast chicken and potatoes, etc... Moreover, the excellent heat distribution makes it possible to use lower temperatures when cooking roasts. This results in less loss of juices, meat which is more tender and a decrease in the loss of weight for the roast. The Multi-cooking mode is especially suited for cooking fish, which can be prepared with the addition of a limited amount of condiments, thus maintaining their flavour and appearance. Excellent results can be attained when cooking vegetable-based side dishes like courgettes, aubergines, peppers, etc.

Desserts: this mode is also perfect for baking leavened cakes. Moreover, this mode can also be used to thaw quickly white or red meat and bread by setting the temperature to 80 °C. To thaw more delicate foods, set the thermostat to 60°C or use only the cold air circulation feature by setting the thermostat to 0°C.

Grill

Position of thermostat knob "C": Between **50%** and **100%**. The top heating element and the turnspit (where present) come on.

The extremely high and direct temperature of the grill makes it possible to brown the surface of meats and roasts while locking in the juices to keep them tender. The grill is also highly recommended for dishes that require a high temperature on the surface: such as beef steaks, veal, rib steak, filets, hamburgers etc...

Always leave the oven door ajar during cooking, except when using the turnspit.

Some grilling examples are included in the "Practical Cooking Advice" paragraph.

Turn knob "C" and the display will indicate the different energy percentages which represent the minimum (50%) and maximum (100%) settings.

Gratin

Position of thermostat knob "C": Between **40°C** and **250°C**. The top heating element, the fan and the turnspit (where present) come on.

This combination of features increases the effectiveness of the unidirectional thermal radiation of the heating elements through forced circulation of the air throughout the oven. This helps prevent food from burning on the surface, allowing the heat to penetrate right into the food. Excellent results are achieved with kebabs made with meats and vegetables, sausages, ribs, lamb chops, chicken in a spicy sauce, quail, pork chops, etc.

All "gratin" cooking must be done with the oven door shut. The "gratin" mode is ideal for cooking grouper steaks, tuna, swordfish, stuffed cuttlefish etc.

Pizza Mode

Position of thermostat knob "C": Between **40°C** and **250°C**. The bottom and circular heating elements, as well as the fan, will come on. This combination rapidly heats the oven due to the large amounts of power used by the appliance (2800 W), which results in the production of considerable heat coming prevalently from the bottom.

The pizza mode is ideal for foods requiring high temperatures to cook, like pizzas and large roasts. Only use one oven tray or rack at a time. However, if more than one is used, these must be switched halfway through the cooking process.

Baking Mode

Position of thermostat knob "C": Between **40°C** and **250°C**. The rear heating element and the fan come on, guaranteeing delicate heat distributed uniformly throughout the oven.

This mode is ideal for baking and cooking delicate foods - especially cakes that need to rise - and for the preparation of certain tartlets on 3 shelves at the same time. Here are a few examples: cream puffs, sweet and savoury biscuits, savoury puffs, Swiss rolls and small portions of vegetables au gratin, etc.....

"Fast cooking" Mode

Position of thermostat knob "C": Between **40°C** and **250°C**. The heating elements and the fan come on, guaranteeing constant heat distributed uniformly throughout the oven.

This mode is especially recommended for cooking pre-packed food quickly (as pre-heating is not necessary), such as for example: frozen or pre-cooked food) as well as for a few "home-made" dishes.

The best results when cooking using the "Fast cooking" mode are obtained if you use one cooking rack only (the second from the bottom), please see the table entitled "Practical Cooking Advice".

"Defrosting" Mode

Position of thermostat knob "C": **any**



The fan located on the bottom of the oven makes the air circulate at room temperature around the food. This is recommended for the defrosting of all types of food, but in particular for delicate types of food which do not require heat, such as for example: ice cream cakes, cream or custard desserts, fruit cakes. By using the fan, the defrosting time is approximately halved. In the case of meat, fish and bread, it is possible to accelerate the process using the "multi-cooking" mode and setting the temperature to 80° - 100°C.

Automatic cleaning with the fast clean function

This function is designed to clean your oven thoroughly. For details on the fast clean function, please refer to the paragraph entitled "Automatic cleaning with the fast clean function".

The turnspit (only available on certain models)

To start the turnspit, proceed as follows:

- place the oven tray on the 1st rack;
- insert the special turnspit support on the 3rd rack and position the spit by inserting it through the special hole into the turnspit at the back of the oven;
- start the turnspit using knob "B" to select setting  / .

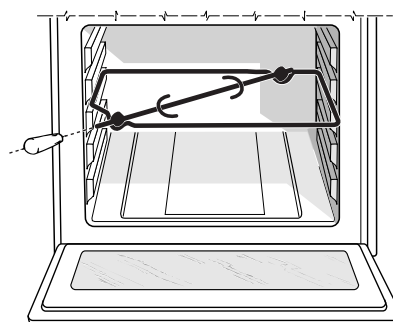

Programming the cooking mode

The cooking time and/or end cooking time can be programmed after the desired cooking mode has been selected.

Programming the cooking time

Press button 5 and then adjust the cooking time by turning knob **C**. Press the **OK** button to store the setting. The temperature selected (which can be adjusted using knob **C**) and the amount of time left until cooking is complete will be displayed alternately.

Once this time is up, the word “end” will be displayed and a sequence of acoustic signals will be emitted to indicate that cooking is complete.

- Press any button to silence the acoustic signal.
- Turn knob **B** back to position 0 to remove the word “end” from the display.

For example

It is 9:00 a.m. and a cooking time of 1 hour and 15 minutes is programmed. Cooking will stop automatically at 10:15 a.m..

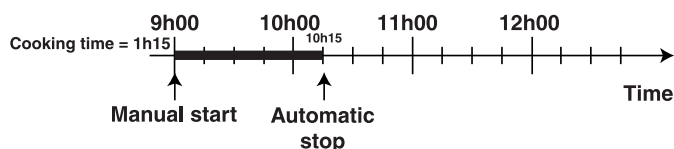

Programming the end cooking time

Press button 4 and then adjust by turning knob **C**. Press the **OK** button to store the setting. The display will remind you alternately of the temperature selected and the amount of time left until cooking is complete.

When the end cooking time selected previously is up, the word “end” will be displayed and a sequence of acoustic signals will be emitted to indicate that cooking is complete.

- Press any button to silence the acoustic signal.
- Turn knob **B** back to position 0 to remove the word “end” from the display.

For example

It is 9:00 a.m. and the end cooking time is set at 10:15 a.m.. Cooking will last 1 hour and 15 minutes.

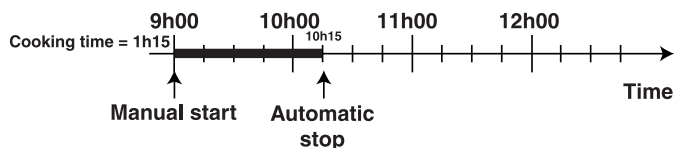

Delayed cooking programming

Press button 5 and then adjust the cooking time by turning knob **C**. Press the **OK** button to store the setting. The temperature and the time set previously will be displayed alternately.

Press button 4 and then adjust the end cooking time by turning knob **C**. Press the **OK** button to store the setting and the display will remind you of the end cooking time and of the temperature set alternately.

For example

It is 9:00 a.m. and a cooking time of 1 hour and 15 minutes and 12:20 as the end cooking time are programmed. Cooking will start automatically at 11:15 a.m..

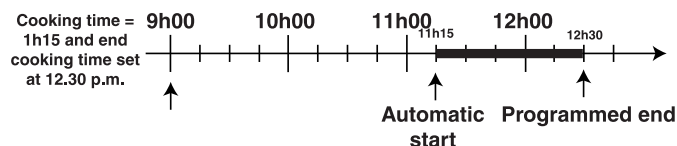

The icon **A** will remind you that you have programmed the cooking time and/or the end cooking time.

To cancel a programmed time

To cancel any programming you have made, set knob “**B**” to position “**0**”.

Automatic cleaning with the fast clean function

When the **fast clean** function has been enabled, the temperature inside the oven reaches 500 °C, which is necessary to burn all food residue that has built up inside it. If you look through the oven glass, you may notice some particles that **light up** as they are destroyed by pyrolysis upon contact with the heating elements: this is simply spontaneous combustion: **it is perfectly normal and hazard-free.**

A few useful tips before automatic cleaning begins

1- Try to **remove large** scraps of food and caked-on dirt with a damp sponge. Avoid using detergents or any other special products recommended for oven cleaning.

2- **Remove all the accessories from the oven**, as these are not designed to withstand such high temperatures. In addition, some accessories could affect the efficiency of the automatic cleaning cycle by obstructing the circulation of heat along all the interior walls of the oven. The accessories can easily be washed like everyday crockery (even in your dishwasher).

3- Do not place tea towels over the oven handle.

Notice: during the automatic cleaning cycle, the surfaces may become very hot. Keep children well away.

How to enable the fast clean function

- Shut the oven door.
- Set the **selector knob** to .
- To programme the fast clean cycle time and/or cycle end time, follow the instructions provided in the paragraph entitled "Fast clean programming". Please note that you can choose a cycle time of between 60 and 120 minutes, depending on the degree of soil in your oven.

Safety devices

Given the high temperatures reached inside it, the oven is fitted with several safety devices:

- the door is **locked automatically** as soon as the temperature exceeds a certain value, to avoid all risk of burns;
- **the heating elements are no longer electrically powered**, as a precautionary measure, should a fault occur.
- Once the oven door has been locked, you cannot make any changes to the cycle time, cycle end and timer settings.

What happens at the end of an automatic cleaning cycle?

At the end of the automatic cleaning cycle, the word "**end**" is displayed and an acoustic signal is sounded, which can be silenced just by pressing any one of the buttons. Turn knob "**B**" to the "**0**" setting and the word "end" will disappear. To open the oven door, you will have to wait until the temperature inside it has dropped to a suitable value.

You will notice some white dust deposits on the bottom and sides of your oven; remove them with a damp sponge once the oven has cooled down completely.

You may on the other hand prefer to take advantage of the heat accumulated to start cooking immediately; in this case the dust can stay where it is: it is completely harmless and will not affect your food in any way.

DO NOT WORRY IF

- 1 the cooling fan is operating at low speed at the start of the fast clean cycle;
- 2 the electrical system limiter blows when Fast Clean is in use: this is due to a mains overload (too many electric household appliances used at the same time);
- 3 the oven door is locked during the Fast Clean programme: this is an appliance safety device; the door will only open when the oven has cooled completely;
- 4 small stains are left on the interior surface of the oven after the Fast Clean cycle: we recommend you remove the toughest grease spots and large scraps of food before the self-cleaning cycle and that you set the cycle time in accordance with the degree of soil in your oven;
- 5 you see ventilated air exiting the oven for a while when cooking is complete: it is due to the normal cooling phase of the oven interior;
- 6 when using the "grill" mode, the top heating element isn't always on (red in colour): its operation is controlled by a thermostat;
- 7 a blast of hot steam exits the oven when you open the door during cooking;
- 8 drops of water or steam form inside the oven if you leave food inside the oven after cooking is complete;

Fast clean programming

The fast clean cycle time and/or cycle end time can be programmed after selecting the fast clean mode.

Programming the fast clean cycle time

Press button 5 and then adjust the cycle time by turning knob **C**. Press the **OK** button to store the setting. The time left until the end of the fast clean cycle will be displayed. Once this time is up, the word “end” will be displayed and a sequence of acoustic signals will be sounded to indicate that the cleaning cycle is complete.

- Press any button to silence the acoustic signal.
- Turn knob **B** back to position 0 to remove the word “end” from the display.

For example

It is 9:00 a.m. and a fast clean cycle time of 1 hour and 15 minutes is programmed. The fast clean cycle will end automatically at 10:15 a.m..

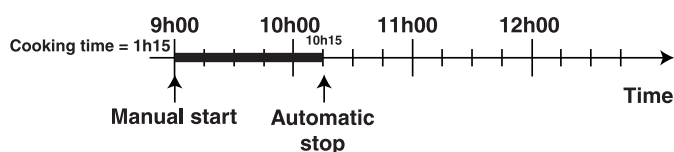

Programming the fast clean cycle end time

Press button 4 and then adjust by turning knob **C**. Press the **OK** button to store the setting. The time left until the end of the fast clean cycle will be displayed.

When the fast clean cycle time previously selected is up, the word “end” will be displayed and a sequence of acoustic signals will be sounded to indicate that the fast clean cycle is complete.

- Press any button to silence the acoustic signal.
- Turn knob **B** back to position 0 to remove the word “end” from the display.

For example

It is 9:00 a.m. and the fast clean cycle end time is set at 10:15 a.m.. Fast clean will last 1 hour and 15 minutes.

Delayed fast clean cycle programming

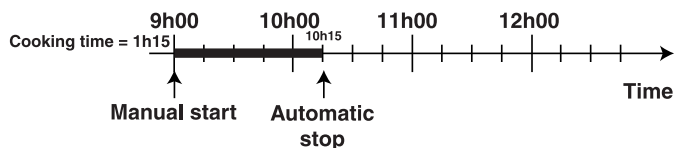

Press button 5 and then adjust the cycle time by turning knob **C**. Press the **OK** button to store the setting and display it.

Press button **4** and then adjust the cycle end time by turning knob **C**. Press the **OK** button to store the setting and the display will remind you of the cycle end time and of the actual cycle time set alternately.

For example

It is 9:00 a.m. and a fast clean cycle time of 1 hour and 15 minutes and 12:20 as the cycle end time are programmed. The fast clean cycle will start automatically at 11:15 a.m..

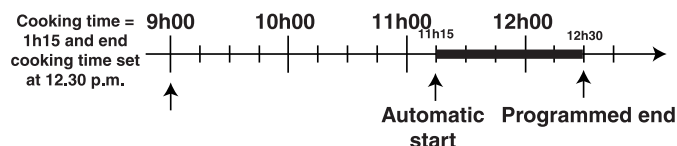

The icon **A** will remind you that you have programmed the fast clean cycle time and/or the cycle end time.



To cancel a programmed time

To cancel any programming you have made, set knob “**B**” to position “**0**”.

Practical Cooking Advice

The oven offers a wide range of alternatives which allow you to cook any type of food in the best possible way. With time you will learn to make the best use of this versatile cooking appliance and the following directions are only a guideline which may be varied according to your own personal experience.

Cooking on More Than One Rack

If you have to cook food using several racks, use either the “baking” mode  or the “Multi-cooking” mode , as these are the only modes that allow you to do so.

When cooking delicate food on more than one rack, use the “baking” mode , which allows you to cook on 3 racks at the same time (the 1st, 3rd and 5th from the bottom). Some examples are included in the “Practical Cooking Advice” table.

When cooking other food on several racks, use the “Multi-cooking” mode  keeping the following suggestions in mind:

- The oven is fitted with 5 racks. During fan assisted cooking, use two of the three central racks; the lowest and highest racks receive the hot air directly and therefore delicate foodstuffs could be burnt on these racks.
- As a general rule, use the 2nd and 4th rack from the bottom, placing the foodstuffs that require greater heat on the 2nd rack from the bottom. For example, when cooking meat roasts together with other food, place the roast on the 2nd rack from the bottom and the more delicate food on the 4th rack from the bottom.
- When cooking food that requires differing times and temperatures, set a temperature that is somewhere between the two temperatures required, place the more delicate food on the 4th rack from the bottom and take the food requiring less time out of the oven first.
- Use the dripping pan on the lower rack and the grid on the upper;

Using the “Fast Cooking” Mode

Functional, fast and practical for those of you who use pre-packed products (such as for example: frozen or pre-cooked food) along with other food items. You will find useful suggestions in the “Practical Cooking Advice” table.

Using the Grill

The “7 Cuochi” oven offers you several different grilling modes.

Use the “grill” mode  with the oven door ajar, placing the food under the centre of the grill (situated on the 3rd or 4th rack from the bottom).

To catch any fat and/or grease that may drip from the rack, place the dripping pan provided on the first rack from the bottom.

When using this mode, we recommend you set the energy level to the highest setting, even though lower levels can be set, simply by adjusting the thermostat knob to the desired level.

In models fitted with a rotisserie , you can use the spit kit provided when using the “grill” mode. In this case, cook with the oven door shut, placing the spit kit on the third

oven rack from the bottom and the dripping pan on the bottom rack to collect any sauce and /or dripping fat.

The “Gratin” mode  **only with the oven door shut**, is extremely useful for grilling foods rapidly, as the distribution of heat makes it possible not only to brown the surface, but also to cook the bottom part.

Moreover, it can also be used for browning foods at the end of the cooking process, such as adding that gratin finish to pasta bakes, for example.

When using this mode, place the grid on the 2nd or 3rd oven rack from the bottom (see cooking table) then, to prevent fat and grease from dripping onto the bottom of the oven and thus smoke from forming, place a dripping-pan on the 1st rack from the bottom.

Important: always cook in “Gratin” mode with the oven door shut. This will allow you both to obtain excellent results and to save on energy (approximately 10%).

When using this mode, we advise you to set the thermostat to 200°C, as it is the most efficient way to use the grill, which is based on the use of infrared rays. However, this does not mean you cannot use lower temperatures, simply by adjusting the thermostat knob to the desired temperature.

In models fitted with a rotisserie , you can use the spit kit provided when using the “gratin” mode. In this case, place the spit kit on the third oven rack from the bottom and the dripping pan on the bottom rack to collect any sauce and /or dripping fat.

Therefore the best results when using the grill modes are obtained by placing the grid on the lower racks (see cooking table) then, to prevent fat and grease from dripping onto the bottom of the oven and smoke from forming, place a dripping-pan on the 1st oven rack from the bottom.

Baking Cakes

When baking cakes, always place them in a preheated oven. Do not open the oven door during baking to prevent the cake from dropping. In general:

Pastry is too dry

Increase the temperature by 10°C and reduce the cooking time.

Pastry dropped

Use less liquid or lower the temperature by 10°C.

Pastry is too dark on top

Place it on a lower rack, lower the temperature, and increase the cooking time.

Cooked well on the inside but sticky on the outside

Use less liquid, lower the temperature, and increase the cooking time.

The pastry sticks to the pan



Grease the pan well and sprinkle it with a dusting of flour or use greaseproof paper.

I used more than one level (in the function "ventilated oven") and they are not all at the same cooking point

Use a lower temperature setting. It is not necessary to remove the food from all the racks at the same time.

Cooking Pizza

For best results when cooking pizza, use the "Pizza Mode" .

- Preheat the oven for at least 10 minutes
- Use a light aluminium pizza pan, placing it on the rack supplied with the oven. If the dripping pan is used, this will extend the cooking time, making it difficult to get a crispy crust;
- Do not open the oven door frequently while the pizza is cooking;
- If the pizza has a lot of toppings (three or four), we recommend you add the mozzarella cheese on top halfway through the cooking process.
- If cooking on more than one rack (up to 2), we advise you to use the Multi-cooking Mode , as the Pizza Mode  would heat the bottom rack more than the others.









Cooking Fish and Meat

When cooking white meat, fowl and fish, use temperature settings from 180 °C to 200 °C.

For red meat that should be well done on the outside while tender and juicy in the inside, it is a good idea to start with a high temperature setting (200°C-220°C) for a short time, then turn the oven down afterwards.

In general, the larger the roast, the lower the temperature setting. Place the meat on the centre of the grid and place the dripping pan beneath it to catch the fat.

Make sure that the grid is inserted so that it is in the centre of the oven. If you would like to increase the amount of heat from below, use the low rack heights. For savoury roasts (especially duck and wild game), dress the meat with lard or bacon on the top.

Setting made	Type of food	Weight (in kg)	Position of the rack from the oven bottom	Preheating time (min.)	Thermostat setting	Cooking time (min.)	
1 Convection mode 	Duck	1	3	15	200	65-75	
	Roast veal or beef	1	3	15	200	70-75	
	Pork roast	1	3	15	200	70-80	
	Biscuits (short pastry)	-	3	15	180	15-20	
	Tarts	1	3	15	180	30-35	
2 Multicottura 	Pizza (on 2 racks)	1	2-4	15	230	15-20	
	Lasagne	1	3	10	180	30-35	
	Lamb	1	2	10	180	40-45	
	Roast chicken + potatoes	1+1	2-4	15	200	60-70	
	Mackerel	1	2	10	180	30-35	
	Fruitcake	1	2	10	170	40-50	
	Cream puffs (on 2 racks)	0.5	2-4	10	190	20-25	
	Biscuits (on 2 racks)	0.5	2-4	10	180	10-15	
	Sponge cake (on 1 rack)	0.5	2	10	170	15-20	
	Sponge cake (on 2 racks)	1.0	2-4	10	170	20-25	
	Savoury pies	1.5	3	15	200	25-30	
3 Grill 	Soles and cuttlefish	0.7	4	-	100%	10-12	
	Squid and prawn kebabs	0.6	4	-	100%	8-10	
	Cuttlefish	0.6	4	-	100%	10-15	
	Cod filet	0.8	4	-	100%	10-15	
	Grilled vegetables	0.4	3/4	-	100%	15-20	
	Veal steak	0.8	4	-	100%	15-20	
	Sausages	0.6	4	-	100%	15-20	
	Hamburger	0.6	4	-	100%	10-12	
	Mackerels	1	4	-	100%	15-20	
	Toasted sandwiches (or toast)	n.° 4-6	4	-	100%	3-5	
	With rotisserie (where present)						
	Veal on the spit	1.0	-	-	100%	80-90	
	Chicken on the spit	1.5	-	-	100%	70-80	
	Lamb on the spit	1.0	-	-	100%	70-80	
4 Gratin 	Grilled chicken	1.5	2	10	200	55-60	
	Cuttlefish	1.5	2	10	200	30-35	
	With rotisserie (where present)						
	Veal on the spit	1.5	-	10	200	70-80	
	Lamb on the spit	1.5	-	10	200	70-80	
	Chicken (on the spit) + potatoes (roasted)	1.5	-	10	200	70-75	
5 Pizza 	Pizza	0.5	3	15	220	15-20	
	Roast veal or beef	1	2	10	220	25-30	
	Chicken	1	2/3	10	180	60-70	
6 Baking 	Tarts	0.5	3	15	180	20-30	
	Fruit cakes	1	2/3	15	180	40-45	
	Fruitcake	0.7	3	15	180	40-50	
	Sponge cake	0.5	3	15	160	25-30	
	Stuffed pancakes (on 2 racks)	1.2	2-4	15	200	30-35	
	Small cakes (on 2 racks)	0.6	2-4	15	190	20-25	
	Cheese puffs (on 2 racks)	0.4	2-4	15	210	15-20	
	Cream puffs (on 3 racks)	0.7	1-3-5	15	180	20-25	
	Biscuits (on 3 racks)	0.7	1-3-5	15	180	20-25	
	Meringues (on 3 racks)	0.5	1-3-5	15	90	180	
	7 Fast cooking 	Frozen food					
Pizza		0.3	2	-	250	12	
Courgette and prawn pie		0.4	2	-	200	20	
Country style spinach pie		0.5	2	-	220	30-35	
Turnovers		0.3	2	-	200	25	
Lasagne		0.5	2	-	200	35	
Golden Rollsi		0.4	2	-	180	25-30	
Chicken morsels		0.4	2	-	220	15-20	
Pre-cooked food							
Golden chicken wings		0.4	2	-	200	20-25	
Fresh Food							
Biscuits (short pastry)		0.3	2	-	200	15-18	
Fruitcake		0.6	2	-	180	45	
Cheese puffs		0.2	2	-	210	10-12	
8 Defrosting 	All frozen food						

NB: cooking times are approximate and may vary according to personal taste. When cooking using the Grill or Gratin mode, the dripping pan must always be placed on the 1st oven rack from the bottom.

How to Keep Your Oven in Shape

Before cleaning your oven, or performing maintenance, disconnect it from the power supply.

To extend the life of your oven, it must be cleaned frequently, keeping in mind that:

- **Do not use steam equipment to clean the appliance.**
- the enamelled or stainless steel parts should be washed with lukewarm water without using any abrasive powders or corrosive substances which could ruin them; Stainless steel could get stained. If these stains are difficult to remove, use special products available on the market. After cleaning, it is advisable to rinse thoroughly and dry.
- the inside of the oven should preferably be cleaned immediately after use, when it is still warm, with hot water and soap; the soap should be rinsed away and the interior dried thoroughly. Avoid using abrasive detergents (for example cleaning powders, etc...) and abrasive sponges for dishes or acids (such as limescale-remover, etc...) as these could damage the enamel. If the grease spots and dirt are particularly tough to remove, use a special product for oven cleaning, following the instructions provided on the packet.
- if you use your oven for an extended period of time, condensation may form. Dry it using a soft cloth.
- it is important to ensure that the seal around the oven door opening is not damaged. Should it be damaged, please contact your nearest After-sales Service Centre. We recommend you avoid using the oven until it has been repaired.
- never line the oven bottom with aluminium foil, as the consequent accumulation of heat could compromise the cooking and even damage the enamel.
- clean the glass door using non-abrasive products or sponges and dry it with a soft cloth.

How to remove the oven door

For a more thorough clean, you can remove the oven door. Proceed as follows:

- open the door fully;
 - lift up and turn the small levers situated on the two hinges;
 - grip the door on the two external sides, shut it slowly but not completely;
 - pull the door towards you, pulling it out of its seat;
- Reassemble the door by following the above procedures backwards.

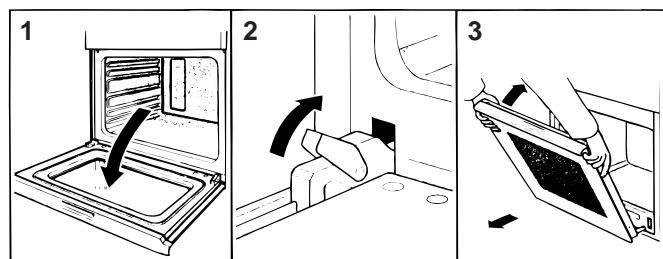
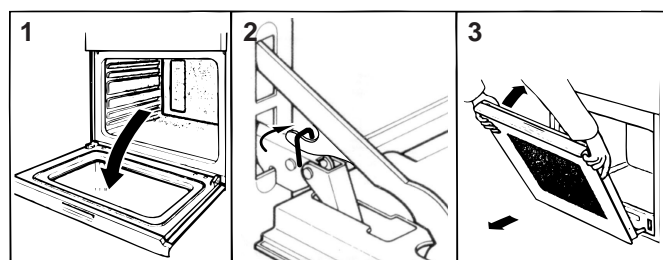

Replacing the oven lamp

- Always unplug the appliance from the mains or switch off the main switch before all operations.
- With the aid of a narrow, flat item (such as a screwdriver or a spoon handle, etc...), remove the glass cover.
- Unscrew the lamp and replace it with another featuring the same characteristics:
 - voltage 230/240 V
 - wattage 15 W
 - type E 14
- Replace the glass cover and ensure you reposition the seal correctly.

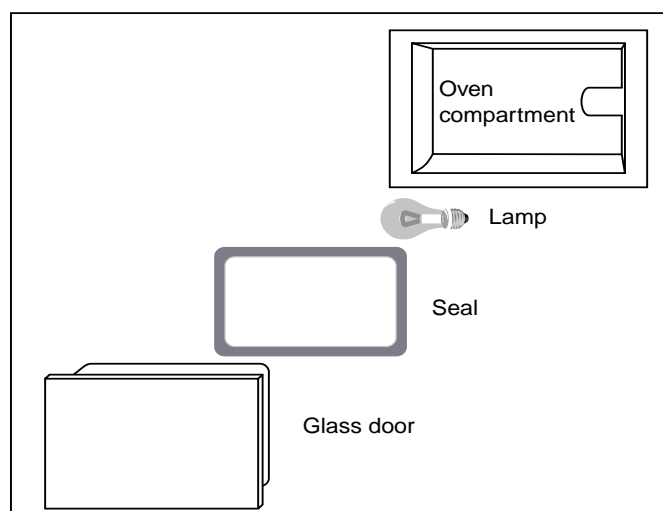

INSTALLATION

The appliance must be installed only by a qualified person in compliance with the instructions provided. The manufacturer declines all responsibility for improper installation which may harm persons and animals and damage property.

Important: The power supply to the appliance must be cut off before any adjustments or maintenance work is done on it.

Installation of Built-in Ovens

In order to ensure that the built-in appliance functions properly, the cabinet containing it must be appropriate. The figure below gives the dimensions of the cut-out for installation (N.B.: Installation in compliance with the consumption declaration) under the counter or in a wall cabinet unit.

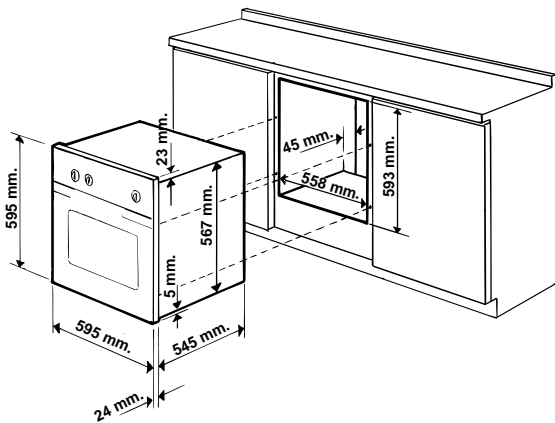

N.B.: Installation in compliance with the consumption declaration

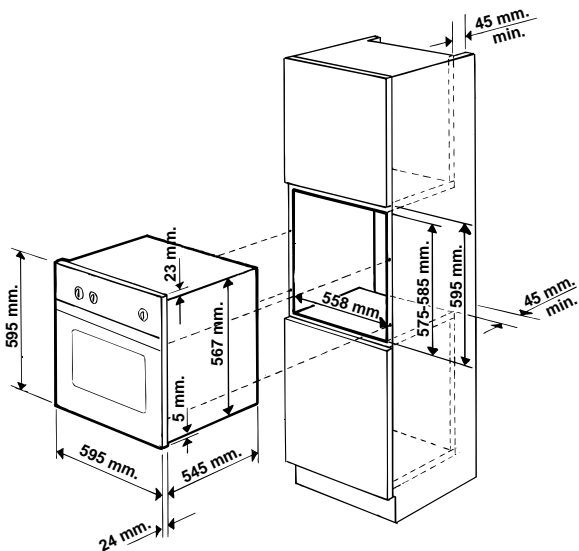

In order to ensure adequate ventilation, the back panel of the cabinet unit must be removed. Installing the oven so that it rests on two strips of wood is preferable. If the oven rests on a continuous, flat surface, there must be an aperture of at least 45x560mm.

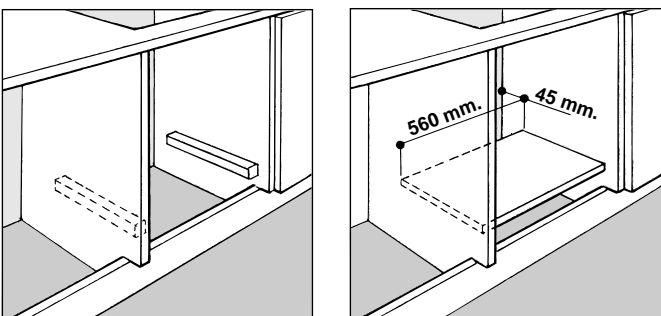

The panels of the adjacent cabinets must be made of heat-resistant material. In particular, cabinets with a veneer exterior must be assembled with glues which can withstand temperatures of up to 100 °C.

In compliance with current safety standards, contact with the electrical parts of the oven must not be possible once it has been installed.

All parts which ensure the safe operation of the appliance must be removable only with the aid of a tool.

For the correct centring of your appliance, position the 4 tabs on the sides of the oven in correspondence with the 4 holes on the perimeter of the frame. In particular, if the cabinet side panel:

- is 20 mm thick: the removable part of the tab must be removed (Fig. A);
- is 18 mm thick: use the first groove, which is factory-set (Fig. B);
- is 16 mm thick: use the second groove (Fig. C).

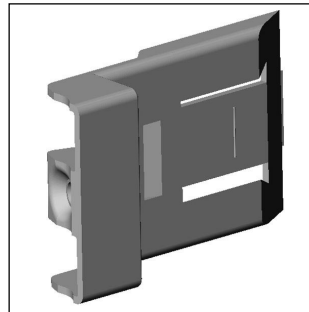

Fig. A

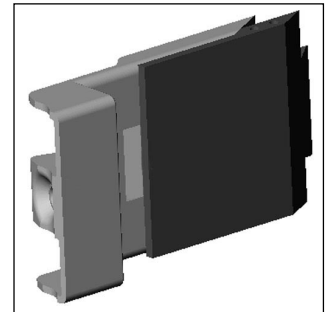

Fig. B

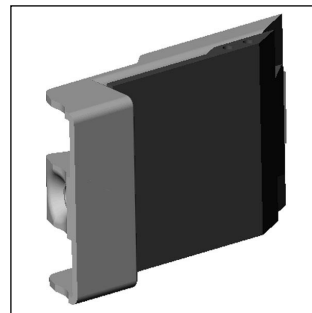
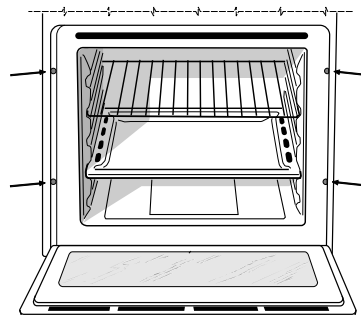

Fig. C

To fasten the oven to the cabinet, open the door of the oven and attach it by inserting the 4 screws (supplied with the appliance) into the 4 holes located on the perimeter of the frame.



INSTALLATION

Fastening the oven to the cabinet

1. Place brackets "A" up against the oven support "B".
2. Place the tabs "C" up against brackets "A". In particular,
 - is 16 mm thick: mount the tab so that the number 16 it features is facing you;
 - is 18 mm thick: mount the tab so that the part without any wording is facing you;
 - is 20 mm thick: do not mount the tab.
3. Fasten the brackets and tabs on the oven cabinet side panel using screws "D".
4. Fasten the oven to the cabinet using the screws and plastic washers "E".

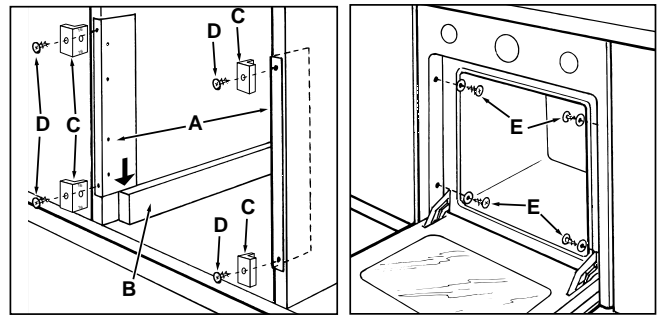

Troubleshooting

If your oven releases a lot of smoke during cooking:

- Make sure you have selected the correct cooking mode for the type of dish you want to prepare and that you have selected the right accessories and put the dish in the oven at the recommended rack height.
- Check the temperature selected: is it too high for the type of cooking required.
- Check the degree of soil of the oven, and whether it needs to be cleaned. Food residue encrusted onto the enamel coating inside the oven becomes charred and creates both smoke and pungent smells.
- Splashes of grease or overflows onto very hot surfaces could create smoke.

Electrical Connection

Electrical connection

The electrical connection to the mains must be made on the appliance. The power voltage and frequency are as indicated on the rating plate.

WARNING: THIS APPLIANCE MUST BE EARTHED.

Mounting the power supply cable

To open the terminal board:

- Using a screwdriver, press on the tabs situated on each side of the terminal board cover.
- Pull open the terminal board cover.

To mount the power supply cable, proceed as follows:

- Unscrew the cable clamp screw and the contact screws L-N- \perp .
- Fasten the wires beneath the screwheads using the following colour scheme: **Blue (N) Brown (L) Yellow-Green \perp**
- Fasten the power supply cable in the corresponding cable clamp and close the cover.

Electrical Connection:

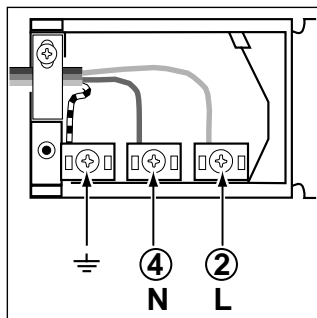

Voltage Frequency: 230 V-1+N 50Hz

Fuse Section: 16A

Supply cable: 3x1.5mm²

You can connect your oven to the system means of a terminal board. Refer to above information for the minimal cable sections and the calibration of the protective elements according to the connection. If the appliance is installed **with a junction box**, an **omnipolar circuit breaker** - with a minimum contact opening of 3mm - should be installed between the appliance and the mains.

ENERGY LABEL

Directive 2002/40/EC on the label of electric ovens

Norm EN 50304

Energy consumption for Natural convection

heating mode: Convection

Declared energy consumption for Forced convection Class

heating mode: Baking

Power cable supply connection to the electrical mains:

We recommend you use a power supply cable which is long enough to allow you to take the oven out of its recess in the event of maintenance operations (only use HAR - H 05 - RRF quality cables fitted with a plug conforming to the regulations in force.

The plug must be accessible at all times.

Unplug the appliance before all operations, even when replacing the oven lamp.

Using the appliance without correct earthing is highly dangerous.

IMPORTANT:

After connecting the appliance to the flexible cable, tighten all the screws on the terminal board.



This appliance conforms with the following European Community Directives:

- 73/23/EEC of 19/02/73 (Low Voltage) and subsequent amendments;
- 89/336/EEC of 03/05/89 (Electromagnetic compatibility) and subsequent amendments;
- 93/68/EEC of 22/07/93 and subsequent amendments;
- 2002/96/EC

The European Directive 2002/96/EC on Waste Electrical and Electronic Equipment (WEEE), requires that old household electrical appliances must not be disposed of in the normal unsorted municipal waste stream. Old appliances must be collected separately in order to optimise the recovery and recycling of the materials they contain and reduce the impact on human health and the environment. The crossed out "wheeled bin" symbol on the product reminds you of your obligation, that when you dispose of the appliance it must be separately collected. Consumers should contact their local authority or retailer for information concerning the correct disposal of their old appliance.

Inner dimensions of the oven:

width	43.5cm
depth	40.0cm
height	32.0cm

Inner volume of the oven: 54 litres

Voltage and frequency of power supply:

230-240V

50-60Hz

2250-2400W



After Sales Service

"No company is better positioned to offer an after sales service on a Hotpoint appliance than us - the manufacturer"

As part of our commitment to you, all Hotpoint appliances have the added benefit of a fully inclusive parts and labour guarantee for the first 12 months. In addition to this you also have the advantage of **free replacement parts for the first 5 years** when fitted by a Hotpoint engineer. When the 12 months parts and labour guarantee expires we offer the following after sales service options:

Repair Service and Information Help Desk

UK: 08709 066066

www.theservicecentre.co.uk

Republic of Ireland: 1850 302 200

Note: Our operators will require the Model number and the Serial number of your appliance

Available 364 days a year with a fast, effective and value for money service. We have the largest white goods repair service in the UK with over 1200 of our own fully trained engineers. All repairs include a parts and labour guarantee for 12 months from the date of the repair.

If you require any information or have any questions about your appliance, our operators are on hand with help and advice.

All this ensures that you will receive the best available after sales service possible.

Extended Warranties

UK: 08709 088 088

www.theservicecentre.co.uk

Republic of Ireland: 1850 502 200

Whether you have just one or a number of Hotpoint appliances in your kitchen, we offer two service cover plans to give you total peace of mind.

- Repair Protection Plan - FREE service repairs for a single Hotpoint appliance during the period of cover.
- Kitchen Cover - FREE service repairs for all your Hotpoint appliances less than 8 years old.

Genuine Parts and Accessories UK: 08709 077 077

www.theservicecentre.co.uk

Republic of Ireland: (01) 842 6836

A wide range of genuine parts and accessories are available from our hotline or through our web site.

Genuine parts and accessories, extended warranties and service repairs are all available on our web-site at:



www.theservicecentre.co.uk



Guarantee

"Satisfaction guaranteed or your money back"

We give you a unique 'satisfaction guaranteed' promise - **valid for 90 days** - after you have purchased your Hotpoint appliance. If there is a technical problem simply call Hotpoint Repair service or visit our web-site at www.theservicecentre.co.uk and where necessary, we will arrange for an engineer to call. If the technical problem is not resolved under this guarantee, **we will replace your machine or, if you prefer, give you your money back.**

All Hotpoint appliances carry a fully inclusive 12 month parts and labour guarantee as well as free replacement parts for the first 5 years (except microwaves, selected integrated appliances and cooker hoods, which have a one year guarantee) provided that they are fitted by a Hotpoint engineer.

Guarantee terms and conditions

Your guarantee is only applicable in the United Kingdom or Republic of Ireland and is subject to the following provisions that your appliance:

- Has been installed and used correctly in accordance with this instruction booklet.
- Has been used solely for domestic purposes and is located on domestic premises (ie. not for commercial or trade use).
- Has been properly connected to a suitable electrical supply voltage as stated on the appliance rating plate.
- Has not been subject to misuse, accident, modified or repaired by anyone other than one of our own service engineers.



For pre purchase information on any other Hotpoint product call: 08701 50 60 70
or visit: www.hotpoint.co.uk



Recycling & Disposal Information

As part of Hotpoint's continued commitment to helping the environment, Hotpoint reserves the right to use quality recycled components to keep down customer costs and minimise material wastage.

Please dispose of packaging and old appliances carefully.

To minimise risk of injury to children, remove the door, plug and cut mains cable off flush with the appliance. Dispose of these parts separately to ensure that the appliance can no longer be plugged into a mains socket, and the door cannot be locked shut.



Key Contacts

After Sales Service

Over 1200 trained specialists, directly employed by us, ensure that you can have complete confidence in both the appliances and services we offer.



Repair Service and Information Desk

UK: 08709 066 066

(Open 8 to 8 Mon - Fri, 8 to 6 Sat, 10 to 4 Sun & Bank Holidays)

www.theservicecentre.co.uk

Republic of Ireland: 1850 302 200

Note: Our operators will require the following information:

Model number:

Serial number:

Extended Warranties

UK: 08709 088 088

(Open 8 to 8 Mon - Sun)

www.theservicecentre.co.uk

Republic of Ireland: 1850 502 200

Genuine Parts and Accessories

UK: 08709 077 077

(Open 8-30 to 5-30 Mon - Fri & 9 to 12 Sat)

www.theservicecentre.co.uk

Republic of Ireland: (01) 842 6836