



Instructions for Installation and Use

BS62

BS72

Note: Timer must be set to 'Time of Day' and 'Manual' before the oven can be used.

Note: Ensure that the oven is securely fixed to the cabinet before use.

To the Installer

Before installation fill in the product details on the back cover of this booklet. The information can be found on the rating plate.

To the User

You must read the instructions prior to installing and using the appliance and then retain them for future reference.

CONTENTS

Introduction	3
For Your Safety – Always	4
For Your Safety – Never	5
Know Your Oven	6
The Controls	7-8
Oven Timer Operation	9
Know Your Timer	10
Electronic Clock & Automatic Oven Timer Operation	11-14
Solarplus Grill	15-16
Using the Oven as a Fan Oven	17-18
Using the Fan Oven for Circulaire Roasting	19
Circulaire Roasting Chart	20
Using the Oven for Other Functions	21-26
Temperature Conversion Scale	27
Oven Temperature Charts	28-29
Cooking Results Not Satisfactory	30
Care & Cleaning	31-34
Installation	35-39
Something Wrong?	40-41
Service	Back Cover

INTRODUCTION

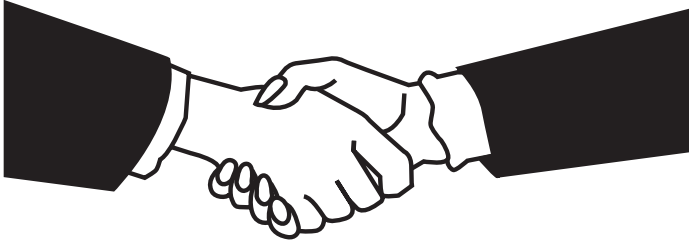

Your new cooker is guaranteed* and will give lasting service. This guarantee is only applicable if the appliance has been installed in accordance with the installation instructions detailed in this booklet.

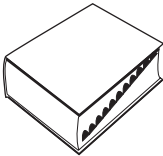

To help make best use of your cooking equipment, please read this booklet carefully.

The cooker is designed specifically for domestic use and responsibility will not be accepted for use in any other installation.

Note: When the cooker is first used, an odour may be emitted - this will cease after a short period of use

To help remove the 'new' smell, heat up the empty oven(s) to maximum for a minimum of two to three hours keeping the oven doors closed. Ensure that the room is well ventilated (e.g. open a window or use an extractor fan) and that persons who may be sensitive to the odour avoid any fumes. It is suggested that any pets be removed from the room until the smell has ceased. This odour is due to any temporary finish on oven linings and elements and also any moisture absorbed by the insulation.

*** The guarantee is subject to the provisions that the appliance:**

- (a) **Has been used solely in accordance with the Users Instruction Book.**
- (b) **Has been properly connected to a suitable supply voltage as stated on the rating plate attached to this equipment.**
- (c) **Has not been subjected to misuse or accident or been modified or repaired by any person other than the authorised employee or agent.**
- (d) **Has been correctly installed.**

This appliance conforms to the following EEC Directives:



Low Voltage Equipment
73/23/EEC
93/68/EEC

Electromagnetic Compatibility
89/336/EEC
92/31/EEC93/68/EEC

FOR YOUR SAFETY

When used properly your appliance is completely safe but as with any electrical product there are certain precautions that must be observed.

PLEASE READ THE PRECAUTIONS BELOW BEFORE USING YOUR APPLIANCE.

Always

- Always make sure you remove all packaging and literature from inside the oven/grill compartment before switching on for the first time.
- Always make sure you understand the controls prior to using the appliance.
- Always keep children away from the appliance when in use as the surfaces will get extremely hot during and after cooking.
- Always make sure all controls are turned off when you have finished cooking and when not in use.
- Always stand back when opening an oven door to allow any build up of steam or heat to disperse.
- Always use dry, good quality oven gloves when removing items from the oven/grill.
- Always take care to avoid heat/steam burns when operating the controls.
- Always turn off the electricity supply at the wall switch before cleaning and allow the appliance to cool.
- Always make sure the shelves are in the correct position before switching on the oven.
- Always keep the oven/grill door closed when the appliance is not in use.
- Always keep the appliance clean as a build up of grease or fat from cooking can cause a fire.
- Always follow the basic principles of food handling and hygiene to prevent the possibility of bacterial growth.
- Always keep ventilation slots clear of obstructions.
- Always refer servicing to a qualified appliance service engineer.
- Always during use the oven becomes hot. Care should be taken to avoid touching heating elements inside the oven.

SAFETY ADVICE

IN THE EVENT OF A CHIP PAN OR ANY OTHER PAN FIRE:

1. TURN OFF THE COOKER APPLIANCE AT THE WALL SWITCH.
2. COVER THE PAN WITH A FIRE BLANKET OR DAMP CLOTH, this will smother the flames and extinguish the fire.
3. LEAVE THE PAN TO COOL FOR AT LEAST 60 MINUTES BEFORE MOVING IT. Injuries are often caused by picking up a hot pan and rushing outside with it.
NEVER USE A FIRE EXTINGUISHER TO PUT OUT A PAN FIRE as the force of the extinguisher is likely to tip the pan over. Never use water to extinguish oil or fat fires.

FOR YOUR SAFETY

Never

- Never leave children unsupervised where a cooking appliance is installed as all cooking surfaces will be hot during and after use.
- Never allow anyone to sit or stand on any part of the appliance.
- Never store items above the appliance that children may attempt to reach.
- Never remove the oven shelves whilst the oven is hot.
- Never heat up unopened food containers as pressure can build up causing the container to burst.
- Never store chemicals, food stuffs or pressurised containers in or on the appliance, or in cabinets immediately above or next to the appliance.
- Never operate the grill with the door closed as this may cause the appliance to overheat.
- Never use the appliance as a room heater.
- Never use the grill to warm plates.
- Never dry any items on the oven doors.
- Never install the appliance next to curtains or other soft furnishings.
- Never allow children to play with the oven controls.
- Never use steam cleaners.

KNOW YOUR OVEN

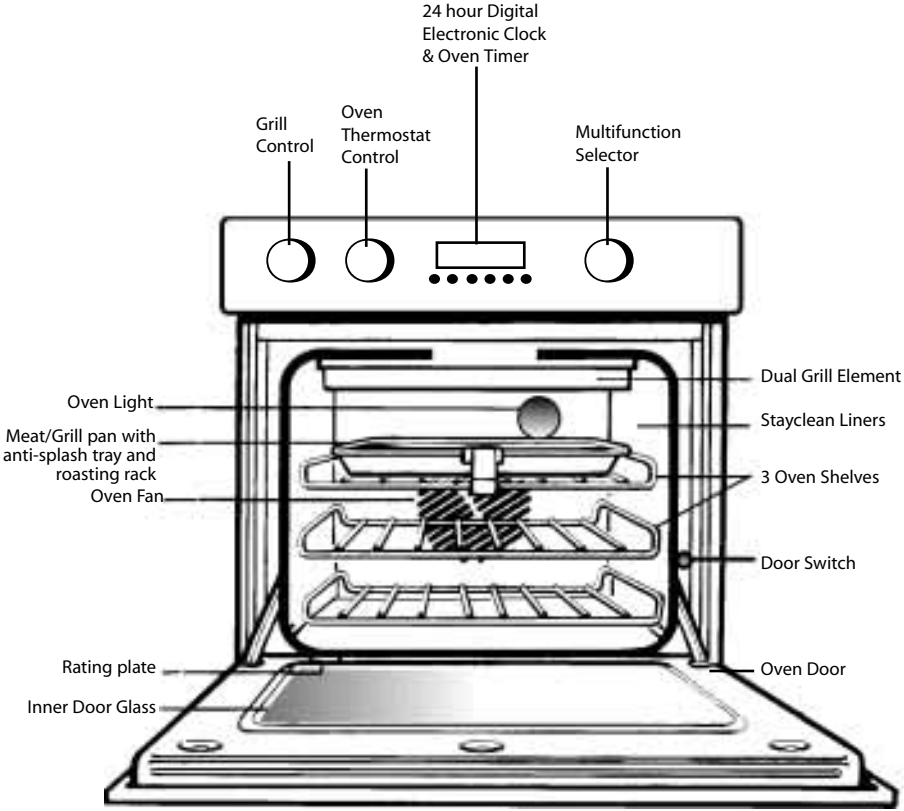

THE CONTROLS

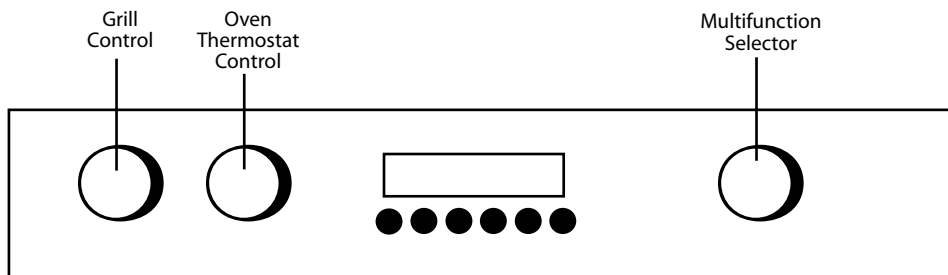

Important

Before using your oven ALWAYS make sure that the timer has been set to MANUAL operation. Unless this is done, the oven cannot heat up. So before seeking assistance, make sure this is done (refer to Timer section)

To release any control knob simply press its centre.

Multifunction Selector

Rotate the control knob in either direction to the required function. Many of the functions will also require the oven thermostat or grill control to be set before the appliance will heat up.

After use knobs can be returned to the storage position by pressing them in at the centre.

Oven Thermostat

This is used in addition to the multifunction selector. This is used for the functions (fan oven, fan grill and top and base heat). Turn the control clockwise to set the oven thermostat to the required temperature. If the timer is set correctly and the selector switch set to a suitable function an indicator light will illuminate. This will remain on until the oven reaches the required temperature. This light will then cycle on and off as the thermostat maintains control of the oven temperature.

Grill Control

This is used in addition to the multifunction selector. This is used for the functions (full grill and half grill). Turn the control in either direction to the required setting. If the selector switch is set to either full grill or half grill and the oven door is in its grilling position then the grill will heat up. After use return all controls to "O" (Off) position.

Cooling Fan

A gentle flow of air will be detected, coming from beneath the control panel when the oven or grill is switched on. This is a safety feature that ensures the control panel surface and control knobs are kept cool.

Note: It is advisable to check that all oven controls have been switched off after you have finished using the appliance.

THE CONTROLS

- **Off** With the selector in this position the oven will be Off, with the exception of the clock display.
- Oven Light** In this position the oven light will illuminate (this applies to all positions other than Off).
- Fan Oven** The oven fan and a rear element are controlled when this function is selected.
Use the oven thermostat control to set the required temperature.
- Conv. Oven** Top and base elements are controlled when this function is selected.
Use the oven thermostat control to set the required temperature.
- Fan Only** The oven fan will operate when this function is selected.
The oven thermostat control **must** be set to the **Off** position.
- Fan Grill** The oven fan and grill element are controlled when this function is selected.
Use the oven thermostat control to set the required temperature.
Oven door must be closed for fan grilling.
- Full Grill** The full width of the grill is controlled when this function is selected.
In addition use the grill control to set the required temperature.
Oven door must be open for grilling.
- Half Grill** The left hand side of the grill element will come on when Half Grill is selected.
In addition use the grill control to set the required temperature.
Oven door must be open for grilling.

OVEN TIMER OPERATION

Note: Timer must be set to 'Time of Day' and 'Manual' before the oven can be used.

AUTOMATIC COOKING

The Oven can be controlled by the Automatic Timer.

HINTS ON AUTOMATIC COOKING

1. Select foods which will require the same cooking time and temperature.
2. To ensure food does not cool down and require reheating, set the end time so the food is ready when you require it.
3. Always ensure that meat and poultry is defrosted before placing in the oven.
4. Whenever possible, take food out of the refrigerator and keep it as cool as possible.
5. If cooking food that requires frying before placing in the oven for automatic cooking, keep the delay time to a minimum.
6. Never place hot or warm food in the oven for delay start cooking as it could cause the oven to be warm and produce harmful bacteria in the food.
7. We advise that dishes containing left-over cooked poultry or meat, e.g. Shepherd's Pie, should not be cooked automatically if there is to be a delay period.
8. Ensure that delay start times are kept to a minimum to prevent bacterial growth in food.
9. Wine or beer may ferment and cream may curdle during the delay period so it is best to add these ingredients just before serving.
10. Foods which discolour should be protected by coating in fat or tossing in water to which lemon juice has been added, prior to placing food in the oven.
11. Dishes containing liquid should not be filled too full to prevent boiling over.
12. Food should be well sealed (but not airtight) in a container to prevent the loss of liquid during cooking. Aluminium foil gives a good seal.
13. Always ensure that food is piping hot and cooked thoroughly before serving.
14. Only reheat food once.

KNOW YOUR TIMER

CLOCKFACE

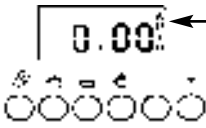

The timer incorporates a 24 hour clock.



Ensure the correct time of day is always set, before using your cooker.

PLEASE NOTE THAT THE DISPLAY WILL DIM BETWEEN 22.00 HOURS AND 06.00 HOURS TO PREVENT GLARE.

However, should you operate the timer during these hours the display will return to normal brightness for a few seconds and then dim again.

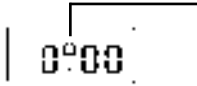
SYMBOLS



 will light up when you select a Minute Minder Period and will remain lit for the period set. At the end of the Minute Minder Period, the timer will emit an audible tone for 2 minutes, the  symbol will start to flash and will continue to flash until the Minute Minder function is cancelled.

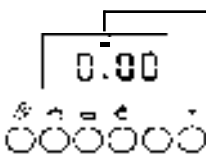

 This "Cookpot" symbol will light up either:-

- When you press  the Cook Period Button and set a length of time for an Auto Cooking Programme. (It will go out again a few seconds after you release the timer buttons).
- During the actual Cook Period.

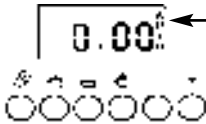

"AUTO" will light up:-

- When the timer is first turned on it will flash. (It will go out when a time of day is set).
- When an Auto Cooking Programme has been set.

The "Auto" symbol will flash at the end of an Auto Cooking programme to indicate that the programme has finished.

(When the "Auto" symbol is flashing, to return the oven to Manual operation, turn the oven controls off, ensure that the correct time of day is set, and press the "Manual" button twice - The "Auto" symbol will go out).

Note: If at any time the display shows a 'KEY' symbol, it is likely that the timer has been set incorrectly. OVEN COOKING IS NOT POSSIBLE. The 'KEY' symbol can be deleted and the cooker returned to manual operation by:

- Simultaneously pressing the Minute Minder and the Cook Period buttons for a period of approximately 8 seconds.
- Releasing the buttons and pressing the '+' button.

TIMER FUNCTION BUTTONS



Here you can set a time period of up to 23 hours 59 minutes, that will count down. When it reaches zero, the timer will emit an audible tone.

For Example: If you set 20 minutes, the audible tone will occur 20 minutes later.

AUTO COOKING PROGRAMME



Cook Period is the actual length of time for which, the timer will switch the oven(s) on as part of an "Auto Cooking" programme.

(e.g. If you set 2 hours, the food will be cooked for 2 hours).



The time of day at which you want an "Auto Cooking" programme to **end**.

For Example: If you set a "Cook Period" for 2 hours, and "End Time" of 11:00. The timer will switch the oven(s) on at 9:00 and turn the oven(s) off at 11:00. You will hear a audible tone at 11:00, to indicate that the Auto Cooking Programme has finished.

Notes:

- When setting an Auto Cooking programme you will need to set the oven controls(s) to the required temperature(s) when you set the timer.
- If an Auto Cooking programme has been set the oven(s) will only operate during the pre-programmed time.



Needs to be pressed to cancel an Auto Cooking programme and return the oven(s) to Manual operation.

"+" and "-" Buttons Used to adjust the various timer function settings.

ELECTRONIC CLOCK & AUTOMATIC OVEN TIMER OPERATION

SETTING THE TIME OF DAY

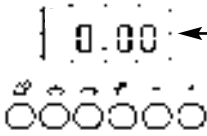

- Step 1** Make sure all oven controls are turned Off.
- Step 2** Check the electricity supply to the cooker is turned on.
- Step 3** When switched on the display will show 0.00 and Auto symbol will be flashing intermittently.

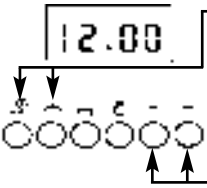

- Step 4** Press & hold in both the & buttons together.
- Step 5** With the & buttons still held in, press either the "+" or "-" buttons to set the correct time of day.
- Step 6** Release all the buttons simultaneously.

THE TIME OF DAY IS NOW SET.

To change the time of day repeat Steps 4, 5 & 6 above.

Note: You cannot adjust the time of day if the timer has been set for an Auto Cooking Programme.

SETTING THE MINUTE MINDER

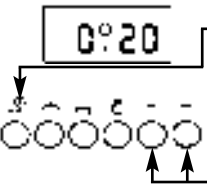

- Step 1** Ensure the time of day is set correctly.
- Step 2** Press and hold the button, a symbol will light up.
- Step 3** With the button held in, set the required Minute Minder time using the "+" and "-" buttons.

Release all buttons and the timer display will revert back to the time of day. Bell symbol will remain lit to signify that a Minute Minder period has been set.

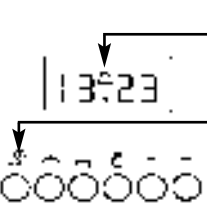

At the end of the set time a beeping sound will be heard, and the symbol will flash for approximately 2 minutes. After approximately 2 minutes the beeping sound will stop and the symbol will go out automatically.

- Step 4** To cancel the beeping sound within the two minutes press the button.

Note 1 When the Minute Minder has been set, the time remaining can be checked at any time by simply pressing the Minute Minder button.

Note 2 If necessary the Minute Minder can be cancelled before the tone sounds by pressing and holding the Minute Minder button and then at the same time pressing the "-" button until 0.00 appears in the display window.

ELECTRONIC CLOCK & AUTOMATIC OVEN TIMER OPERATION

AUTO COOKING PROGRAMMES

There are two Auto Cooking programmes that can be selected using your timer:-

- (a) To set the timer to switch the oven(s) On and Off Automatically
- (b) To set timer to switch on immediately and OFF automatically after a set cook period.

a) TO SET THE TIMER TO SWITCH THE OVEN(S) ON AND OFF AUTOMATICALLY

This allows you to cook at a specified time for a chosen period before the oven switches off Automatically.

- Step 1** Check that the correct time of day is set, if not follow instructions for setting the time of day.
- Step 2** Place food onto the correct shelf position in the oven and close the oven door(s).

Step 3 Press and hold in the button. The display will read 0.00 with the cookpot () symbol lit.

Step 4 With the button still held in, set the required Cook Period using the "+" and "-" buttons.

Release the buttons and the timer display will revert to the time of day with the Auto symbol and Cookpot () symbol lit.

Step 5 Press and hold in the button. The display will read the earliest possible end time for the Cook Period that you have set above. The Auto symbol and Cookpot () symbol lit.

Step 6 With the button still held in, use the "+" and "-" buttons to set the "End Time" (i.e. The time you require the oven to switch off).

Release all the buttons and the timer will revert back to the time of day.

The "Auto" symbol will remain lit to signify that an Auto Cooking Programme has been set. The () symbol will go out.

Step 7 Turn the oven control(s) to the required temperature, and if necessary select the appropriate oven function.

Note: If your appliance has two ovens: When the timer has been set for one oven it is possible to use the other oven only during the same Automatic programme.

At the end of the Automatic Cook Period the Auto Symbol will flash and an intermittent beeping sound will be heard. The beeping sound will continue for approximately 2 minutes unless cancelled. The "Auto" symbol will continue to flash until the timer is returned to Manual operation (see below).

Step 8 Press the button to cancel the beeping sound. (If 2 minutes has not elapsed).

Step 9 Turn the oven control(s) to the OFF position.

Step 10 Press the button again to return the oven(s) to Manual Operation. (The Auto symbol will go out)

ELECTRONIC CLOCK & AUTOMATIC OVEN TIMER OPERATION

Note 1 When cooking automatically the Cook Period can be checked at any time by simply pressing the Cook Period button.

Note 2 When cooking automatically the End Time can be checked at any time by simply pressing the End Time button.

b) TO SET TIMER TO SWITCH ON IMMEDIATELY AND OFF AUTOMATICALLY AFTER A SET COOK PERIOD

- Step 1** Check that the correct time of day is set, if not follow instructions for setting the time of day.
Step 2 Place food onto the correct shelf position in the oven and close the oven door(s).
Step 3 Turn the oven control(s) to the required temperature, and if necessary select the appropriate oven function.

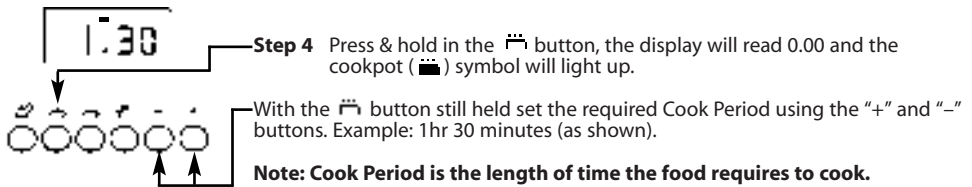

Step 5 Release all buttons.

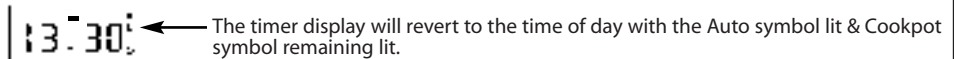

NOTE: The Cookpot symbol disappears

At the end of the Cook Period the "Auto" symbol will flash and an intermittent bleeping sound will be heard. The bleeping sound will continue for approximately 2 minutes unless cancelled. The "Auto" symbol will continue to flash until the timer is returned to Manual operation (see below).

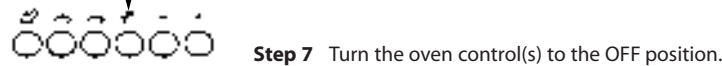
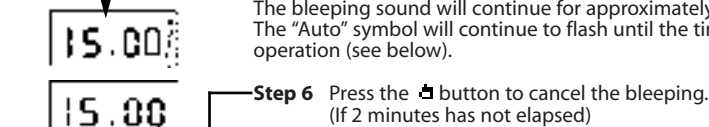

ELECTRONIC CLOCK & AUTOMATIC OVEN TIMER OPERATION

TO CANCEL AN AUTO COOKING PROGRAMME BEFORE THE COOK PERIOD HAS FINISHED.

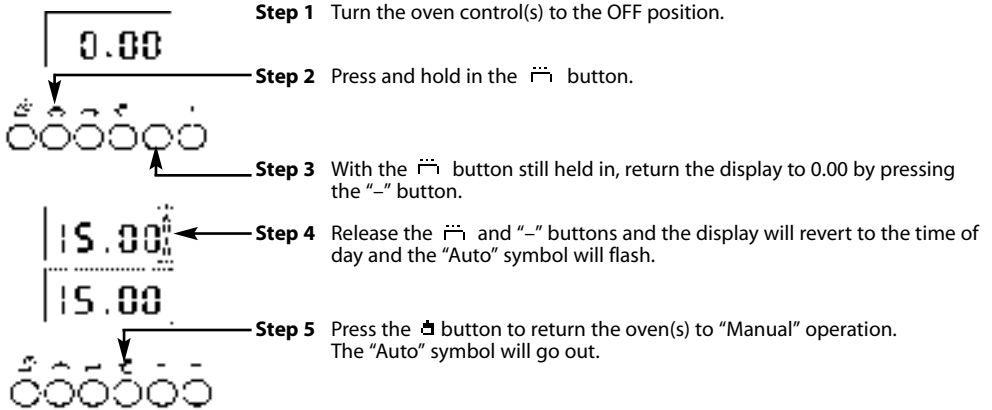

Note 1 When cooking automatically the Cook Period can be checked at any time by simply pressing the Cook Period button.

OTHER NOTES ON TIMER OPERATION

- When cooking Automatically the Cook Period can be checked at any time simply by pressing the Cook Period button.
- When cooking Automatically the End Time can be checked at any time by simply pressing the End Time button.
- Having set a Cook Period and End Time an electronic device stores the information. The device within the timer will switch the oven(s) on and off at the required times.
- When setting an Auto Cooking Programme and a mistake is made, to clear:-
 - Press and hold in the button.
 - With the Cook Period button still held in, return the display to by pressing the “-” button.
 - Release the & “-” buttons, and the display will revert to the time of day and the “Auto” symbol will flash.
 - Press & release the button.
 - Start the sequence again.
- If at any time the display shows three flashing zero's 0.00. It is likely that the electricity supply to the oven has been interrupted. Reset the timer to the correct time of day.
Food in the oven may, therefore, not have been cooked, before serving check food is thoroughly heated and completely cooked.
- To set each function always press and hold the required function button and at the same time press “+” or “-” buttons.

Note: Between the hours of 22.00 & 06.00 the display dims to prevent glare. However, if you should operate a button during this period, the timer will return to normal brightness for a few seconds and then dim again.

SOLARPLUS GRILL

CAUTION:ACCESSIBLE PARTS MAY BECOME HOT WHEN GRILL IS IN USE. CHILDREN SHOULD BE KEPT AWAY.

Your cooker is not fitted with a conventional type of grill. The **Solarplus high speed** grill which is designed to reduce your grilling times. It is quicker because it takes less time to warm up from cold. Conventional grills require 5 minutes preheat before food is placed beneath them, but for normal grilling the **Solarplus** grill can be used directly from cold without any preheat. However, when toasting, optimum performance is achieved by preheating the grill for about 1 minute.

You will notice that the grill elements are protected by a wire mesh. Under no circumstances should pointed objects be inserted into the mesh. During use the mesh may become soiled. **DO NOT** attempt to clean it while the grill is on. Turn the cooker off at the control unit and wait until it has cooled down before cleaning.

Care must be taken to ensure the grill mesh is not distorted - **DO NOT** store the grill pan handle on the grill pan grid when the rod shelf is in the top runner position.

There are two halves to the grill, one on the left and one on the right. You can choose to have both sides on or just the left side on. Select full grill or half grill on the multi function selector, then turn the grill control to the required setting. The numbers which are displayed indicate the heat setting. Number **6** is the hottest and number **1** is the coolest.

GRILLING SHOULD NEVER BE UNDERTAKEN WITH THE GRILL/OVEN DOOR CLOSED. This will cause overheating.

The grill will not operate unless the Oven control is in the off position.

Grilling procedure:

1. Ensure the **TIMER** is set to **MANUAL**.
2. Open the grill/oven door to its grilling position.
3. Turn the multifunction selector switch to either the half grill or the full grill function..
4. Turn the grill control clockwise to the required setting (1-6).
5. Never line the grill pan with aluminium foil as this may cause over heating of fat in the grill pan.

SOLARPLUS GRILL

Guide to grilling successfully: Note, position 1 is with the rod shelf directly on oven floor.

For solarplus grill in single ovens always grill food with the anti splash tray and food grid in position unless stated in the chart:

Food	Pre-heat	Shelf Position from base of oven	Setting required for cooking	Approx. Cooking Time
Toasting of Bread Products	1 min.	5 or 6	6	3 - 6 mins.
Small cuts of meat – Sausages, Bacon	None	5 or 6	6 for 5-10 mins reduced to 5	10 - 20 mins
Chops, etc. Gammon Steaks	None	5	6 reduced 5 after 8-10 mins	25 - 35 mins
Fish: Whole, Fillets, Fish Fingers.	None	5 or 6	6 reduced 5 after 8-10mins	10 - 20 mins.
Pre-cooked Potato Products	None	5 or 6	5	8 - 15 mins
Pizzas	None	5 or 6	4 or 5	15 - 25 mins
Browning of Food e.g. cauliflower cheese	1 min.	5 or 6	6	10 - 20 mins

The numbers on the grill control relate to heat setting recommended on food packs.:

- No. 6 = High
- No. 5 = Medium High
- No. 4 = Medium
- No. 3 = Medium Low
- No. 2 = Low
- No. 1 = Very Gentle Heat

Grill Pan Handle

The grill pan handle is detachable from the pan, to facilitate cleaning and storage. The handle can be either detached from or fixed to the pan.

For a fixed handle remove the screw and washers from the grill pan bracket, tilt the handle over the recess adjacent to the bracket (A), slide it towards the centre of the pan (B) and let the handle locate over the bracket (C). Replace the screw and washers and ensure that they are fully tightened up.

For a detachable handle remove screw and washers from the grill pan and keep safe.

Warning: Ensure when using the grill pan handle in the detachable manner it is centralised and secure.

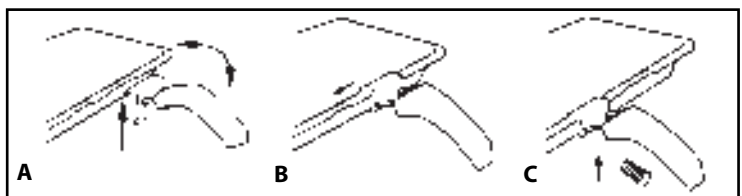

USING THE OVEN FOR FAN COOKING

Fan
Oven

Since a circulaire fan oven heats up more quickly, and generally cooks food at a lower temperature than a conventional oven, pre-heating is often unnecessary. For guides on “pre-heating”, “cooking temperatures” and “cooking times”, see “Oven Temperature Charts” later in book.

NOTE: Charts are a guide only, to suit personal taste and requirements, it may be necessary to increase or decrease temperatures by 10°C. It may also be necessary to increase or decrease cooking times.

OVEN SHELF POSITIONING FOR FAN OVEN

Most foods will cook satisfactorily on any shelf position, due to even distribution of heat in the oven, but the shelves must be evenly spaced.

Food or utensils should never be placed directly on the floor of the oven for cooking as air circulation is restricted.

DO NOT allow young children near to the appliance when the oven is in use as the surfaces get extremely hot.

OVEN UTENSILS

Do not use: Meat pans larger than 375mm x 300mm (15" x 12")

Baking Trays larger than 325mm x 250mm (13" x 10")

TEMPERATURE & TIME

If three shelves are in use to cook large quantities of food, it may be necessary to increase the cooking times given in the temperature charts by a few minutes, to allow for the loss of heat due to extra time taken to load the oven, and the larger mass of food. Baking trays should have an even gap around the oven.

USING THE OVEN FOR FAN COOKING

FAN OVEN OPERATION

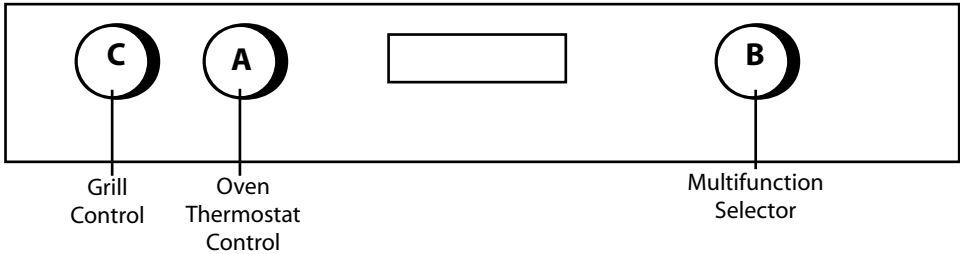

- Step 1** Ensure oven timer is set to manual.
Ensure that the oven shelf is in the correct position.
Place food centrally on the shelf ensuring the oven door is fully closed.
Turn knob (B) clockwise to the Fan Oven function.
- Step 2** Turn knob (A) clockwise and select the required cooking temperature .
The pilot light (●) will immediately come on, and remain on until the oven reaches the required temperature. The light will then automatically go off and on during cooking as the oven thermostat maintains the correct temperature.
- Step 3** After use turn controls (A) and (B) to their Off (O) position.

NOTE: At the end of a cooking period there may be a momentary puff of steam when the door is opened. This will disperse in a few seconds and is a perfectly normal characteristic of an oven with a good door seal.

USING THE OVEN FOR CIRCULAIRE ROASTING

CIRCULAIRE ROASTING

Circulaire roasting - food is placed on the roasting rack, this allows the oven fan to circulate the hot air around the food, making it suitable for thin foods, such as chops, steaks, sausages as well as meat joints and poultry, as it will cook both sides at the same time. It is possible to cook on any shelf position, as the temperature in the oven is evenly distributed. Also, the oven heats up more quickly and generally will cook food at a lower temperature than a conventional oven, so pre-heating is not necessary for most foods. For a guide on “cooking times” and “cooking temperatures” see “Circulaire Roasting Chart”. If required, circulaire roasting can be timed using the Oven Timer. Follow the timer instructions before selecting Fan Oven function and the required temperature.

Note: It is also possible to cook food on the roasting rack on one shelf, while cooking different types of food at the same temperature, on other shelf positions (three shelves maximum).

Operating Instructions:

- STEP 1. Ensure the Oven Timer is set to manual.
Ensure that the oven shelf is in the position you require.
Place the food centrally on the roasting rack.
Position the roasting rack on top of the grill/meat pan and anti-splash tray.
Place the grill/meat pan centrally on the oven shelf.
Ensure the oven door is fully closed.
- STEP 2. Turn the control knob (B) clockwise to the fan oven function.
Turn the control knob (A) clockwise and select the required cooking temperature. The pilot light (●) will immediately come on and will remain on until the oven reaches the required temperature. The light will then automatically go off and on during cooking as the oven thermostat maintains the correct temperature.
- STEP 3. After use, turn controls (A) and (B) to the Off (O) position.

Note: At the end of a cooking period there may be a momentary puff of steam when the door is opened. This will disperse in a few seconds and is a perfectly normal characteristic of an oven with a good door seal.

CIRCUAIRE ROASTING CHART

Type of Meat & Poultry	Temperature °C	Time Approximate	PLACE FOOD ON ROASTING RACK, THEN POSITION ABOVE THE MEAT PAN & ANTI-SPLASH TRAY.
BEEF Beef - any type of joint	160 - 180°C	20 - 25 mins / 450g (1lb) + 20 mins extra	
PORK Pork - any type of joint	160 - 180°C	25 mins / 450g (1lb) + 25 mins extra	
Pork - chops	170°C	30 - 45 minutes	
LAMB Lamb - any type of joint	160 - 180°C	25 mins / 450g (1lb) + 25 mins extra	
Lamb - chops	170°C	20 - 30 minutes	
CHICKEN / TURKEY Up to 4kg (8lb)	160 - 180°C	18 - 20 mins / 450g (1lb) + 20 mins extra	
STEAKS	170°C	30 - 45 minutes	
GAMMON STEAKS	170°C	30 - 45 minutes	
SAUSAGES	170°C	30 - 45 minutes	

Note: The above chart is only a guideline. The times and temperatures may be increased or decreased depending on personal taste.

USING THE OVEN FOR OTHER FUNCTIONS

'S' "SLOW" SETTING

This is used for slow cooking, keeping food warm and warming plates for short periods. Extra care should be taken when warming bone china, as it may be damaged in a hot oven.

DO NOT place food or plates directly on the oven floor as this could damage both the oven lining and the plates which are being warmed.

ADVANTAGES OF SLOW COOKING ARE:

The oven stays cleaner because there is less splashing.
Timing of food is not as critical, so there is less fear of overcooking.
Inexpensive joints of meat are tenderised.
Fully loading the oven can be economical.
Cooking times can be extended in some cases by up to 2 hours.

OPERATION:

1. Place the prepared food in the main oven and ensure the door is fully closed.
2. Turn knob B to Fan Oven function.
3. Turn knob A to 'S' (Slow Cooking temperature).

STORAGE & RE-HEATING OF FOOD:

1. If food is to be frozen or not used immediately, place it in a clean container and cool as soon as possible.
2. Always thaw frozen food completely in the refrigerator before re-heating.
3. Always reheat food thoroughly and ensure it is piping hot before serving.
4. Only re-heat food **once**.

POINTS TO CONSIDER WHEN PREPARING FOOD FOR SLOW COOKING

1. Make sure that the dishes to be used will fit into the oven ensuring enough room for air to circulate.
2. All dishes cooked on the slow setting will require a minimum of 6 hours, however, if they are cooked for 1-2 hours longer then deterioration in their appearance may be noticed.
3. Never cook joints of meat over 2.7kg (6 lb) or poultry over 2.0kg (4lb 8oz). We do not recommend that joints of meat or poultry are stuffed before cooking on the slow setting.
4. To seal in the meat juices, always cook meat or poultry at 170°C for 30 minutes before wrapping in foil and placing on a rack over a tin (to allow good air circulation) turning the control to the slow setting and cooking immediately.
5. Always ensure that joints of pork and poultry are thoroughly cooked by checking with a meat thermometer before serving.
6. Always thaw frozen foods completely before cooking. We do not recommend placing frozen food in the oven to cook.
7. Always bring soups, liquids and casseroles to the boil before placing in the oven.
8. Ensure that casserole dishes have a good seal (not airtight) and cover to the top with foil to prevent loss of moisture.
9. Ensure that fruit and vegetables are cut into even sized small pieces to cook properly.
10. Always adjust seasoning before serving.
11. If using dried red kidney beans it is important that the beans are soaked and then boiled for a minimum of 10 minutes before using in any dish to destroy any toxins.
12. When cooking fish or egg dishes it may be necessary to check during cooking to avoid overcooking.

USING THE OVEN FOR OTHER FUNCTIONS

FAN GRILLING

Fan grilling is a combination of heat from the grill element and the oven fan circulating the hot air around the food.

Joints of meat and poultry will be browned as if they were cooked on a rotisseries or spit but more economically as the door is left closed.

If required, fan grilling can be timed using the Oven Auto Timer. Follow the Timer instructions before selecting Fan Grill and the required temperature.

If Manual fan grilling is required, always ensure the Timer is set to Manual.

Operating Instructions:

1. Open the Oven door.
2. Select the correct shelf position.
3. Turn the selector switch (B) to the Fan Grill position.
4. Turn the oven thermostat control (A) to the required temperature (see Fan Grilling Roasting Chart).
5. Position the meat pan centrally under the grill elements (if using the grill pan always remove the grill pan handle).
6. Close the oven door. Fan grilling will not begin until the door is fully closed.
7. After use always return both controls to the Off position.
8. If the oven timer was used, reset it to Manual.

USING THE OVEN FOR OTHER FUNCTIONS

FAN GRILLING

As with the fan oven cooking there is no need to pre-heat the oven – yet another economy feature. Also you can cook more than one thing at a time – even up to 4 small chickens.

Temperatures

These will be similar to those used for the more traditional form of roasting but the guide will give you an indication of which temperature to set the Thermostat. But remember that because of the way the oven is heated this is a more economical way of roasting.

General recommendations

Most types of meat and poultry cooked by this method will have an all over brownness and crispness on the outside. The only exceptions are very lean joints, such as veal, which, because of its low fat content, is better cooked using conventional heating.

1. **Always** place the pan on the shelf position recommended. (See Chart).
2. There is no need to preheat the oven before cooking and all fan grilling should be carried out with the oven door closed, this saves energy. The cooking temperatures and times are calculated from a cold oven.
3. After rinsing and drying meat, place on the roasting rack over the pan supplied with the anti-splash tray in position. It is important that the anti-splash tray is used, as it will stop the splashing of fat and help keep the oven clean.
4. Position meat in oven as recommended in the roasting chart.
5. Fan grilling is ideally suited for cooking all types of poultry and larger joints of meat (e.g. stuffed, rolled joints and legs of pork and lamb). Results will be as if you had cooked the food on a rotisserie. If you use frozen meat or poultry it must be completely defrosted before it is cooked.
6. When cooking a joint always grill it with the fat side uppermost in order to crisp it. For bigger joints or where there is little bone, grill at the lower temperature given in the table and cook for a longer time per kg.
7. When cooking any type of poultry, start grilling the underside uppermost and turn breast uppermost about a third to halfway through the cooking period. If cooking stuffed poultry allow slightly longer cooking time.



Grill / meat pan, anti-splash tray and roasting rack.

Fan Grilling Roasting Chart

Shelf positions are counted from the base upwards ie: lowest shelf position is 1.

Type of Meat or Poultry	Weight kg	Temp °C	Time (min/kg)	Plus Extra Time (mins)	Total Cooking Time (mins)	Tips
PORK Pork Chop - thick		170	25		Dependent on size	Season. Grill on shelf position 3. Turn over after 15 mins. Grill on shelf position 3 Turn after 15 mins. Score fat with sharp knife and rub on salt. Pork should always be thoroughly cooked. So overcook rather than undercook. Grill on shelf position 1.
Gammon Steaks		160	30		Dependent on size	
Pork - any type of joint	1.0	160-170	60-70	45	105-120	
	1.5	150-170	60-70	45	130-150	
	2.0	140-150	65-75	50	180-230	
	2.5	140-150	65-75	50	220-240	
over 2.5	140	70-75	50	-		
LAMB Lamb chop - thick		170	25		Dependent on size	Season. Grill on shelf position 3. Turn over after 15 mins. Score fat. Season with pepper and rosemary. If you prefer the lamb pink choose the shorter time Grill on shelf position 1.
Lamb - any type of joint	1.0	160-170	30-40	45	78-88	
	1.5	160-170	35-40	45	90-110	
	2.0	150-160	35-45	50	120-140	
	2.5	150-160	40-45	50	150-170	
	over 2.5	150	45-50	50	-	
BEEF Beef - joints which have an outside layer of fat eg. Rib, Rolled, Sirloin	1.0 1.5 2.0 2.5 over 2.5	170-180 170-180 160-170 160-170 160	40-50 40-50 40-50 45-50 45-50	20 20 20 30 40	60-70 80-90 100-110 140-150 -	Season. If joint preferred rare grill for the shorter time. If preferred well done grill for the longer time. Grill on shelf position 1.
CHICKEN	1.0 1.5 2.0 2.5 over 2.5	180 180 170 170 160-170	30 30 35 35 40	30 30 30 30 30	60 75 100 115 -	Season and brush over with melted butter to give nicely browned skin. Grill on shelf position 1. Shelf 1.
Chicken joints less than 1kg each	180	30	30	60		
DUCK	1.5 2.0 2.5	180 180 180	30 30 35	30 30 30	75 90 115-130	Dry thoroughly and lightly salt. Grill on shelf position 1.
GOOSE	up to 4 4-5	170-190 160-170	40 45	40 40	- -	Can be stuffed. Grill on shelf position 1
TURKEY	up to 5 6-8	170 150	- -	- -	150-165 165-175	Season and brush over with melted butter to give nicely browned skin. Grill on shelf position 1
GAME Grouse Partridge Pheasant	Any Any Any	170-180 170-180 170-180	30-50 40-50 40-50	- - -	- - -	Well hung meat will require less cooking time. grill on position 1.
Beefburgers	450g(lb)	170	20-30 mins			Shelf 2.
Sausages	450g (lb)	170	20-30 mins			Shelf 2. Prick sausages before cooking.
Bacon	450g (lb)	170	20-30 mins			Shelf 2.
Mixed Grill		170			30	Roll up bacon before cooking. 4 pieces of steak, sausages, chops, bacon, tomatoes & mushrooms. Cook sausages, chops, bacon for 10 mins. add steak, cook for further 20 mins. Tomatoes & mushrooms should be placed on trivet under roasting rack for total cooktime.

USING THE OVEN FOR OTHER FUNCTIONS

FAN ONLY

The oven has a fan only position, which can be used to assist defrosting by circulating unheated air around the food.

Time to defrost will depend on the type and size of the food and the room temperature.

Operating Instructions:

1. Turn the selector switch (B) to the Fan only position.
2. The oven light will remain on.
3. After use always return the controls to the Off position and close the oven door.

DO NOT turn the oven thermostat control on.

DO NOT defrost meat and poultry by warming the food through.

Foods ideally suited for fan defrosting (without heat) are those which are normally served cold eg. cream/cream cakes, butter cream filled cakes, gateaux, cheese cakes, iced cakes, quiches, pastries, biscuits, bread croissants, fruit and many delicate frozen foods.

If fish, meat and poultry are to be 'fan only' defrosted, then where possible the items should be thin eg. fish fillets, peeled shrimp, cubed or ground meat, sliced meat, thin chops, steaks or liver.

The items should be placed so the maximum amount of surface area is exposed to the circulating air and turned to ensure even defrosting.

Fan defrosting without heat is only suitable for meat and poultry joints up to a maximum weight of 1.8kg (4lb).

It is important to wash both roast and cooking utensils immediately after defrosting, before cooking.

It is vitally important to strictly adhere to the basic principles of food handling and hygiene to prevent the possibility of bacterial growth.

USING THE OVEN FOR OTHER FUNCTIONS

CONV. HEAT

The oven is heated by elements at the top of the oven and underneath the floor of the oven.

The oven door is fitted with a switch which will automatically turn off the elements when the door is opened.

Food should not be placed on the floor of the oven.

Operating Instructions:

1. Ensure oven Timer is set to Manual.
2. Position the rod shelf as recommended in the chart for food being cooked.
3. Position the food centrally under the grill elements.
4. Turn selector (B) to the conv. oven position.
5. Turn the oven thermostat control (A) to the required temperature setting (see oven temperature charts). The oven light will remain on. The oven indicator light will remain on until the oven reaches the set temperature. The light will then automatically cycle on and off during cooking as the oven temperature is controlled.
6. After use always return both controls to 'O' the Off position and close the oven door.

TEMPERATURE CONVERSION SCALE

Gas Mark	°F	Main Conventional Oven	Main Fan Oven
1/2	250	120	100
1	275	140	120
2	300	150	130
3	325	160	140
4	350	180	160
5	375	190	170
6	400	200	180
7	425	220	200
8	450	–	210
9	475	–	220

Oven Temperature Charts – Meat

Conv. Oven				Fan Oven				
Meat	Pre-heat	Temperature °C	Time (approx.)	Position in Oven	Meat	Pre-heat	Temperature °C	Time (approx.)
Beef/ Lamb (slow roasting)	Yes	170/180	35 mins per 450g (1lb) + 35 mins over.	Runner 3 from the bottom of the oven.	Beef	No	160/180	20-25 mins per 450g (1lb) + 20 mins extra
Beef/ Lamb (foil covered)	Yes	190/200	35-40 mins per 450g (1lb)		Lamb	No	160/180	25 mins per 450g (1lb) + 25 mins extra
Pork (slow roasting)	Yes	170/180	40 mins per 450g (1lb) + 40 mins over		Pork	No	160/180	25 mins per 450g (1lb) + 25 mins extra
Pork (foil covered)	Yes	190/200	40 mins per 450g (1lb)		Veal	No	160/170	25-30 mins per 450g (1lb) + 25 mins extra
Veal (slow roasting)	Yes	170/180	40-45 mins per 450g (1lb) + 40 mins over		Chicken/ Turkey up to 4kg (8lb)	No	160/180	18-20 mins per 450g (1lb) + 20 mins extra
Veal (foil covered)	Yes	190/200	40-45 mins per 450g (1lb)		Turkey 4 to 5.5kg (8 to 12lb)	No	150/160	12-14 mins per 450g (1lb) + 12 mins extra per every 450g (1lb) over 5.5kg (12lb) allow 10mins per 450g (1lb) and roast at 150°C
Poultry/Game (slow roasting)	Yes	170/180	25-30 mins per 450g (1lb) + 25 mins over		Casserole Stews	No	140-150	1 1/2 - 2 Hrs
Poultry/Game (foil covered)	Yes	190/200	25-30 mins per 450g (1lb)					
Casserole Cooking	Yes	150	2-2 1/2 hrs					

if using aluminium foil, never: 1. Allow foil to touch sides of oven. 2. Cover oven interior with foil. 3. Cover shelves with foil.

The most accurate method of testing the readiness of joints of meat or whole poultry is to insert a meat thermometer into the thickest part of a joint, or the thickest part of poultry thighs, during the cooking period. The meat thermometer will indicate when the required internal temp has been reached.

Beef -	Rare:	60°C	Lamb:	80°C	Poultry:	90°C
	Medium:	70°C	Pork:	90°C		
	Well Done:	75°C	Veal:	75°C		

Oven Temperature Charts – Baking

Baking	Conv. Oven					Fan Oven Cooking		
	Pre-heat	Temperature °C	Time in mins.	Position In Oven	Pre-heat	Temperature °C	Time in mins.	
Food								
Scones	Yes	220	10-15	Runner 2 from bottom of oven	Yes	210	10-15 approx	
Small Cakes	Yes	180	15-25	Runner 3 from bottom of oven		170	15-25 approx	
Victoria Sandwich	Yes	160	20-30	Runner 3 from bottom of oven		190	20-30 approx	
Sponge Sandwich (fatless)	Yes	170/180	15-20	Runner 3 from bottom of oven	Yes	180/190	15-20 approx	
Swiss Roll	Yes	190/200	10-15	Runner 3 from bottom of oven	Yes	190/200	10-15 approx	
Semi-rich Fruit cakes	Yes	150/160	1 1/4 - 1 1/2 hrs 7"	Runner 2 from bottom of oven	Yes	160	1 1/4 - 1 1/2 hrs approx	
Rich Fruit Cakes	Yes	130	Depending on recipe and size	Runner 2 from bottom of oven		130/140	Depending on size	
Shortcrust Pastry	Yes	190	Depending on use	Runner 2 from bottom of oven		180/190	Depending on size	
Puff Pastry	Yes	190/200	Depending on use	Runner 2 from bottom of oven	Yes	190/200	Depending on size	
Yorkshire Pudding	Yes	190/200	35-45	Runner 3 from bottom of oven	Yes	180/190	30-40 approx	
Individual Yorkshire Puddings	Yes	210/220	20-30	Runner 3 from bottom of oven	Yes	190/200	20-30 approx	
Milk Pudding	Yes	140/150	1 1/2 - 2 hrs	Runner 2 from bottom of oven		150/160	1 1/2 - 2hrs approx	
Baked Custard	Yes	130/140	40-50	Runner 3 from bottom of oven		140/150	40-50 approx	
Bread	Yes	190/200	25-35	Runner 3 from bottom of oven	Yes	200	25-35 approx	
Meringues	Yes	80/90	3 - 3 1/2 hrs	Runner 3 from bottom of oven		80-90	3 - 3 1/2 hrs approx	

Note: If soft margarine is used for cake making, temperatures recommended by the manufacturers should be followed. Temperatures recommended in this chart refer to cakes made with block margarines or butter only.

When using more than two shelves for baking in the fan oven, best results are achieved if - before placing the food in the oven, it is preheated to the required temperature.

Note: Where times are stated - they are approximate only.

COOKING RESULTS NOT SATISFACTORY

GRILL

Uneven cooking front to back

Ensure that the grill pan is positioned centrally below the grill element.

Fat splattering

Ensure that the grill pan is not lined with foil.
Ensure that the grill setting is not too high.

BAKING GENERAL

Uneven rising of cakes

Ensure that the oven shelves are level.

Sinking of cakes

The following may cause cakes to sink:

1. Pre-heating of fan ovens – not always necessary.
2. Cooking at too high a temperature – reduce standard temperatures by 25°C for fan ovens.
3. Using normal creaming method with a soft margarine. If using soft margarine, use an all in one method instead of the traditional creaming of the margarine and sugar. Remember when using a food mixer or processor not to over-cream soft margarine.

Over/undercooking

Refer to the cooking times and temperatures given in the Oven Temperature Charts provided, however, it may be necessary to increase or decrease temperatures by 10°C to suit personal taste.

Do not use utensils greater than 56mm (2¼") in height for roasting.

CARE AND CLEANING

Warning: Before cleaning, please ensure that the electricity supply to the appliance is switched off and the appliance is fully cold.

1. "STAYCLEAN" OVEN LINERS

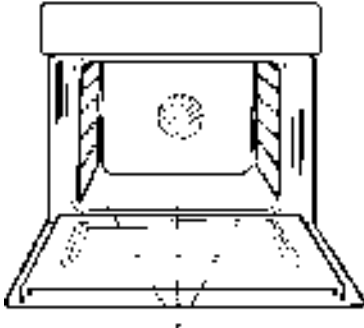

MAIN OVEN SIDE LINERS
AND REAR PANEL

(a) How "Stayclean" works.

The surfaces of the "Stayclean" oven liners are treated with a special vitreous enamel which absorbs cooking soils. At temperatures of 220°C (425°F) or above, the special surface enables these soils to be slowly destroyed. The higher the temperature the more effective it is.

(b) Cleaning.

In most cases normal cooking operations at 220°C (425°F) will permit this cleaning operation to proceed during cooking. However if higher cooking temperatures are not used regularly, it may be necessary, in order to prevent heavy soiling, to run the ovens without shelves or meat pan, at a maximum setting for a couple of hours (in Fan Oven mode only).

It should not normally be necessary to clean the "Stayclean" panels with water. If the user feels it is desirable to do so, wipe them over with a clean, soapy cloth, followed by a wipe with a clean damp cloth.

DO NOT use biological washing powder, harsh abrasives or chemical oven cleaners of any kind as this could damage the "Stayclean" oven liners.

CARE AND CLEANING

2. CLEANING THE OVEN

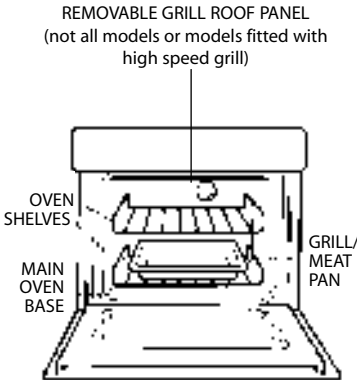

(a) Base of Main Oven.

Wipe out the oven with a damp soapy cloth. For more stubborn stains on the base of the oven use a well soaped fine steel wool soap pad.

(b) Grill/Meat Pan & Oven Shelves.

To prevent stains from being burnt on to the grill pan, food support and rod shelf, always wash immediately after use in warm soapy water.

Use a well soaped fine steel wool soap pad to remove stubborn stains from the rod shelves, grill/meat pan and the base of the oven.

DO NOT use aerosol cleaners on this oven as they could adversely affect the fan motor unit, and cannot be wiped off the fan blade.

(c) Removable Grill Roof Panel (not all models).

Pull the grill roof panel out slowly, being careful not to damage the elements. Clean using a damp soapy cloth, if stubborn stains remain gently clean with a well soaped fine steel wool soap pad and soapy water and then wipe over with a damp cloth.

(d) Solarplus Grill (not all models).

To clean the Solarplus grill, use a clean, damp, soapy cloth and wipe over. If stubborn stains remain, gently clean with a well soaped nylon scouring pad and wipe over with a damp cloth.

DO NOT use metal cleaning utensils, wire wool or proprietary oven cleaners on the grill element mesh.

CARE AND CLEANING

3. CONTROL PANEL / TRIMS / INNER DOOR PANEL & GLASS

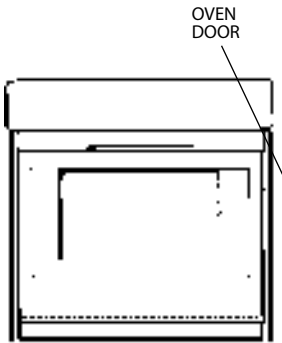

TRIMS

(a) Control Panel

Regularly wipe with a clean, damp cloth and polish with a clean, dry cloth.

(b) Trims

It is advisable to clean the trims regularly to prevent any build up of soiling which may detract from the appearance of the cooker. The recommended method of cleaning is to wipe over the trims with a clean, soft cloth wrung out in warm water, or mild non abrasive cleaner. (If in doubt try the cleaner on a small area of trim which is not noticeable in normal use), then after wiping with a cloth wrung out in clear water, dry with a clean, soft cloth.

(c) Inner Door Panels & Glass

Open the door fully. The glass panel may now be washed. Stubborn stains can be removed by using a well soaped, fine steel wool soap pad.

DO NOT use scouring pads, or abrasive powder, which will scratch the glass.

4. REPLACEMENT OF THE OVEN LAMP

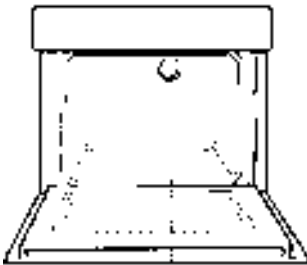

OVEN LAMP

Warning: To avoid electric shock - please ensure that the electricity supply to the appliance is switched off and the appliance is fully cold, before removing the lamp lens,.

Open the oven door and remove the oven shelves. Using a thick cloth, grip the lamp lens, unscrew anti-clockwise and remove the lens. Carefully unscrew the bulb anti-clockwise. Fit replacement bulb (15W 300°C SES). Fit replacement bulb and refit lens.

5. HOW TO CLEAN THE LAMP LENS



OVEN LAMP

Warning: To avoid electric shock - please ensure that the electricity supply to the appliance is switched off and the appliance is fully cold, before cleaning the lamp lens.

Open the oven door and remove the oven shelves. Using a thick cloth, grip the lamp lens, unscrew anti-clockwise and remove. Clean with a non-abrasive cleansing cream and refit lamp lens.

DO NOT use scouring pads, or abrasive powder, which will scratch the glass lens

CARE AND CLEANING

Take particular care not to damage the inner surface of the door inner glass that is coated with a heat reflective layer. Do not use scouring pads, or abrasive powder, which will scratch the glass. Ensure that the glass panel is not subjected to any sharp mechanical blows.

Stubborn stains can be removed by using a fine steel wool pad. For slight soiling the inner glass panel may be cleaned, while still warm, without removing it from the door. After cleaning, rinse and dry with a soft cloth.

CLEANING THE DOORS

SIDE OPENING DOORS

Cleaning the door glass is the same as the drop down doors, except take care to support the weight of the inner glass when removing and refitting.

DROP DOWN DOORS

Remove the door inner glass as follows.

1. Open the door fully and unscrew the two screws securing the glass panel so that the securing brackets can be turned. There is no need to remove the screws completely.
2. Turn the brackets so that the glass can be removed and cleaned at the sink (Fig. 1.)

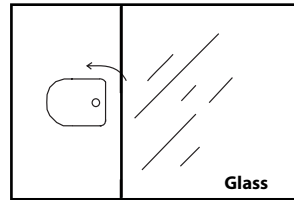

Fig. 1.

3. The inside of the outer door glass can now be cleaned while still fitted to the cooker.

NEVER OPERATE THE COOKER WITHOUT THE INNER DOOR GLASS IN POSITION.

Refit the door inner glass as follows.

1. **NOTE:** The inner door glass has a special reflective coating on one side. Replace the door inner glass so that the statement: **“IMPORTANT THIS FACE TOWARDS THE OVEN”** can be read from the inner side of the door.
2. Turn the two securing brackets back to their original position to retain the glass and tighten the screws. (Fig. 2.)

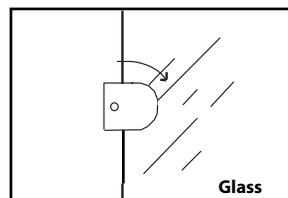

Fig. 2.

INSTALLATION INSTRUCTIONS

IMPORTANT

This equipment is designed specifically for domestic purposes and Hotpoint Ltd cannot accept responsibility if used in any other type of installation.

This appliance must not be installed over any appliance that generates heat.

For your own safety, we recommend that your appliance is installed by a competent person – such as one who is registered with NICEIC (National Inspection Council for Electrical Installation Contracting). The cooker should be installed in accordance with the latest Edition of the IEE Regulations.

1. GENERAL

WARNING: THIS APPLIANCE MUST BE EARTHED.

- (a) The oven unit is designed for mounting at a safe level into an oven housing which must be secured to the backing wall, or alternatively, in the case of the single oven unit, under a worktop with or without a hob unit above.
- (b) In an oven/hob arrangement where it is proposed to install the oven directly below the hob. It is advisable that only slimline hobs are used which have the following maximum depths.

Kitchen Worktop thickness	Maximum hob depth (from worktop surface vertically down)
30mm	55mm
40mm	65mm
40mm +	Worktop thickness + 25mm

It is most important that the hob installation instructions are strictly observed.

INSTALLATION INSTRUCTIONS

2. OVEN UNIT HOUSING CABINETS

- (a) The oven unit housing cabinet dimensions must comply with Fig. 3 and Fig. 4.
- (b) An air gap of 50mm minimum must be provided at the rear of any top or bottom cupboards or shelves for ventilation.
- (c) Do not obstruct the ventilation slots provided on the oven trim. This is found adjacent to the bottom of the oven door.

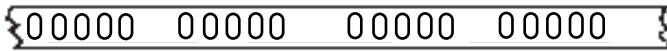

- (d) The air gap at the rear allows the warmed air to pass out of the cabinet. If cabinets extend up to the ceiling, the warm air must be exhausted through to the front. Fig. 1.
- (e) If an oven unit is installed adjacent to a tall cabinet, steam escaping from the oven when the door is opened could condense on, and perhaps stain the adjacent surface. To prevent permanent staining, the adjacent surface should be made of a material that is heat resisting and easy to clean. Adjacent tall cabinets should not be deeper than the oven housing cabinet.

IMPORTANT

It is essential that the lower cupboard is constructed in the manner illustrated i.e. having side, back and roof panels so joined as to provide no apertures which could permit access to the oven unit when installed.

3. ELECTRICAL INSTALLATION

Mains Supply

A 20 amp Double Pole control switch with a minimum contact clearance of 3mm must be fitted on or recessed in the wall adjacent to the oven housing cabinetry and should be accessible after installation. If the oven is to be wired into a connector unit this may be positioned behind the oven providing:-

- i. The top of the connector unit is not more than 30cm above the base of the oven recess – see Fig. 4.
- ii. The depth of the connector unit does not reduce the depth of the oven recess to less than 55cm.

We recommend that 4mm² twin and earth PVC insulated cable is used to connect the cooker to the control unit. This power supply cable must conform to BS 6004.

Alternatively the mains supply can be taken from a household 13 amp switched fused spur, having a minimum contact clearance of 3mm which must be fitted adjacent to the oven housing cabinetry and accessible after installation. The oven must be fitted with a 3 core cable having a minimum cross sectional area of 1.5mm² and must conform to BS6500.

The oven **must not** be connected using a 3 pin 13 amp plug.

INSTALLATION INSTRUCTIONS

Any spare cable must be coiled either behind the oven (not more than 30cm above the base of the oven recess) or pushed into the air gap below the oven after installation.

Where a hob is fitted adjacent to or above an oven a 32 amp or 45 amp double pole switch with a minimum contact clearance of 3mm should be used to feed both units via separate suitably rated cables.

Where a hob unit is fitted above the oven unit we recommend that 85°C High Temperature PVC with insulated 3 core flexible cord to table 15 of BS 6141:1991 with a conductor size of 2.5mm² must be used to connect the hob to the control unit.

Where a hob unit is fitted adjacent to the oven unit, then 4mm² twin and earth cable to BS 6004 is recommended to connect the hob unit to the control unit.

In all cases adhere to routing details (see fig. 5).

Your cooker should have been checked to ensure that the voltage corresponds with your supply voltage, this is stated on the rating plate which is located on the oven front frame (lower).

CONDUIT BOX TO MAINS TERMINAL BLOCK

- (a) The oven unit should be placed on the floor on its carton base in front of the housing cabinet. The rear of the unit should be in line with the conduit box.
- (b) Ensure there is sufficient cable for any future servicing.
- (c) Remove the terminal cover. Prepare the cable, pass it through the cable entry hole in the oven rear panel and fit to terminal block. Secure the cable clamp and replace the terminal cover.

4. FINAL INSTALLATION

- (a) Using a spirit level, check that the housing cabinet is level from side to side and from front to back in its installed position.
- (b) Correct any unevenness by placing spacers under the bottom of the cabinet. Make sure that the cabinet rests firmly on the floor without rocking.
- (c) Before the oven is fitted the cabinet must be firmly secured to the backing wall for stability.
- (d) The oven unit should now be lifted (this requires two people) into the cabinet and pushed fully home.
- (e) Finally the oven unit must be secured to the cabinet. Position the oven side trims equally about the cabinet sides. This should give an overlap of approx. 1.5mm per side (see Fig. 2). Secure the oven unit to the cabinet, through the side trims, by means of the four screws provided, two each side trim.
- (f) Remove all packing material from the grill and oven interior.

LIST OF LOOSE ITEMS

4 x No.6 Pozi Head screws

INSTALLATION INSTRUCTIONS

Ventilation Slot
51 x 457mm minimum area
if cabinet doesn't fit to ceiling

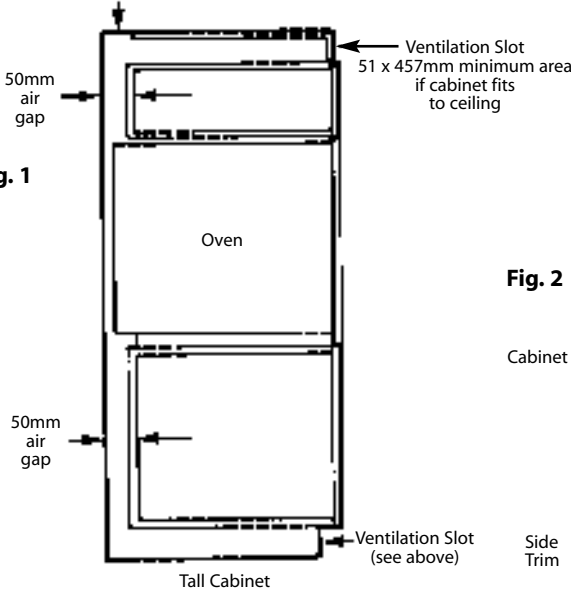

Fig. 1

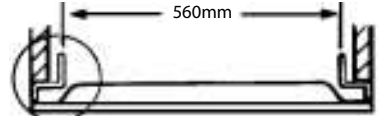
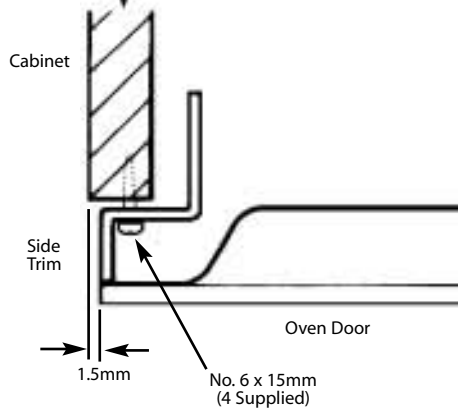

Fig. 2

Viewed down through cabinet



When fitting a hob above an oven always use these installation instructions in conjunction with the hob instructions. Use 2.5mm² High Temp Cable. Refer to Electrical Installation.

Fig. 3

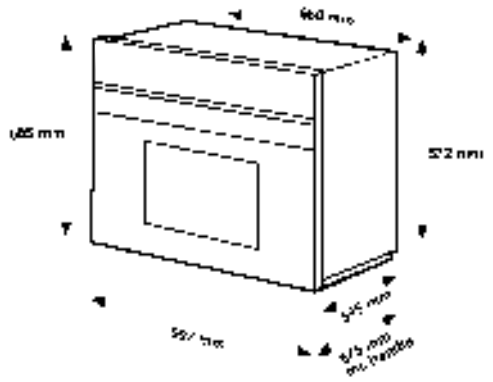
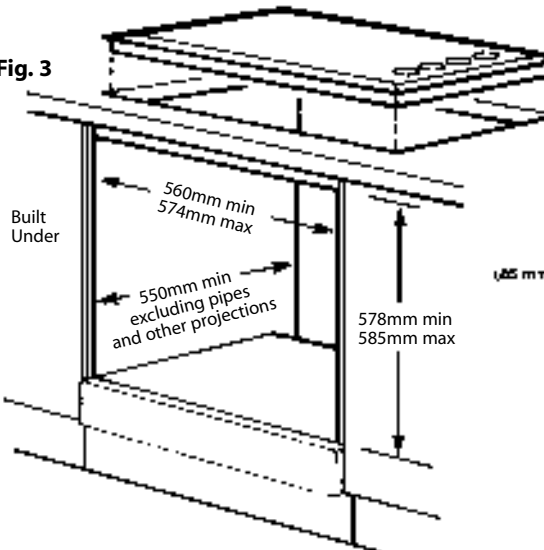

INSTALLATION INSTRUCTIONS

Fig. 4

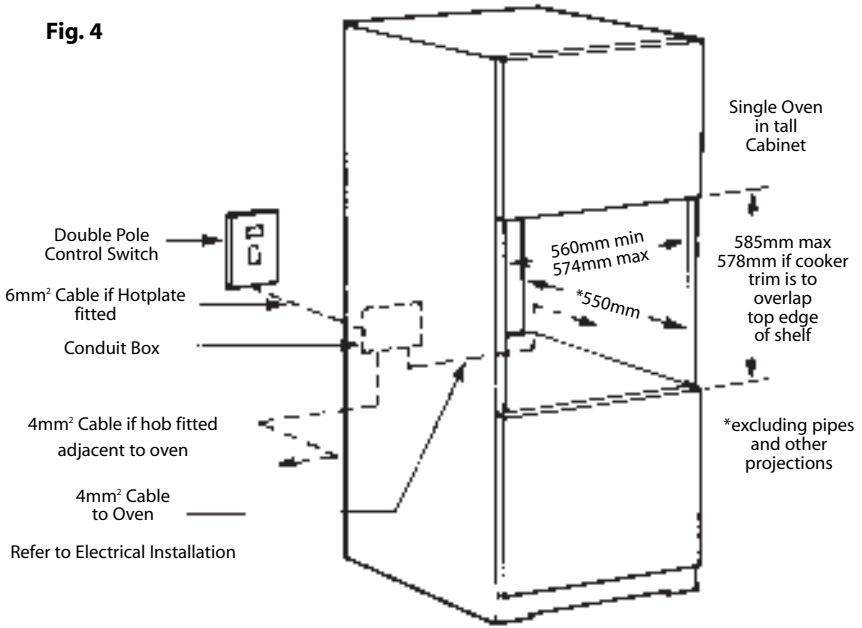
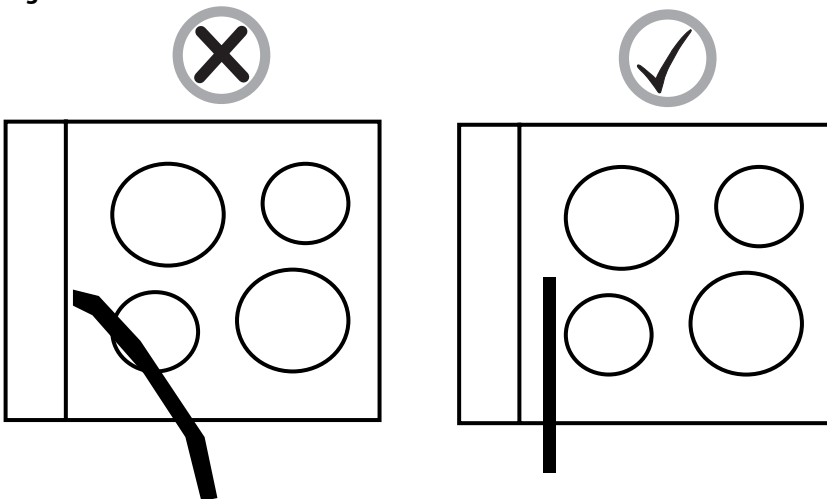

Fig. 5



SOMETHING WRONG?

Before calling a Service Engineer, please check through the following lists.

THERE MAY BE NOTHING WRONG.

Problem	Check
Slight odour or small amount of smoke when grill / oven used first time	This is normal and should cease after a short period.
Nothing Works	If you find that the timer display is blank, then it is likely that there is no electricity supply to your oven. Check: (i) That the main cooker wall is switched on (ii) Other appliances, to see if you have had a power cut (iii) The main circuit breaker for the property (iv) With the selector (B) turned, the oven light does not illuminate.
Oven and Grill do not work	Check to ensure the Timer is in Manual mode. Check that the 'Auto' symbol is not lit up and is not flashing. See Timer section for instructions on how to return the Timer to Manual.
Oven and Grill do not work	Operating the appliance under the following conditions may cause a safety device to operate. (a) Grilling with the door closed - always grill with the door open. (b) Grilling for excessively long period at maximum setting. (c) Grilling with inadequate ventilation in the cabinet.
Timer Display shows "0:00" "Auto"	The power supply to your oven has possibly been interrupted, but has now come back on again. Reset the timer to the correct day and "Manual" operation using the instructions given in the timer section of the book.
Grill does not work	Check that the selector switch is set to 'Full Grill' or 'Half Grill', and that the grill control is turned on. Check that the door is in its grilling position.
Oven does not work	Check that the selector switch (B) is set and that the temperature control (A) is set to the correct temperature.
Draught from beneath control panel	A gentle flow of air will be blown from beneath the control panel when the appliance is used. If the appliance is still warm, this cooling fan may run on, or restart itself when all controls have been turned off. The fan will stop once the appliance has been cooled. This is normal and not a fault.
Grill keeps turning on and off.	When the temperature control (C) is operating at less than 6, the grill will cycle on and off, this is normal and is not a fault.
Cannot set an "Auto Cook" programme	Remember: "Cook Period" is the actual length of time for which the Timer will switch the oven on, as part of an "Auto Cook" programme.

SOMETHING WRONG?

Timer buzzer/bleeper operates continually

Buzzer/Beeper should stop automatically after 2 minutes, if not - press the minute minder button to silence.

Oven lamp does not work

The oven lamp is not covered by the guarantee. The part is easily changed (see the section on oven lamp replacement) A new lamp may be obtained from our Genuine Parts & Accessories Mail Order Hotline (see KEY CONTACTS, back page).

Condensation on the wall at the rear of the cooker.

Steam and / or condensation may appear from the vent at the rear of the appliance when using an oven particularly for foods with a high water content e.g. frozen chips, roast chicken etc. This is normal, and any excess should be wiped off.

Steam / Condensation in the oven after use.

Steam is a by - product of cooking any food with a high water content. To help minimise always:

- a) Try to avoid leaving food in the oven to cool after being cooked.
- b) Use a covered container, wherever possible.

If you have been through the above list and there is still a problem, contact Service (see KEY CONTACTS, back page) .

DISPOSAL OF YOUR PRODUCT

To minimise the risk of injury to children please dispose of your product carefully and safely. Remove all doors and lids (where fitted). Remove the mains cable (where fitted) by cutting off flush with the appliance and always ensure that no plug is left in a condition where it could be connected to the electricity supply. To help the environment, Local Authority instructions should be followed for the disposal of your product.

Key Contacts

Service

Hotpoint has the largest appliance manufacturer's service team in Europe, trained specialists directly employed by us to ensure your complete confidence.

Repair Service

UK: 08709 066 066

Republic of Ireland: 1850 302 200

You will be asked for the following information:-

Name, address and postcode.

Telephone number

Model / Serial number of the appliance

Clear and concise details of the query or fault

Place and Date of purchase

(Please keep the receipt as evidence will be required when the engineer calls).

Extended Warranty

To join: UK 08709 088 088

Republic of Ireland: 1850 502 200

Genuine Parts & Accessories Mail Order Hotline

UK: 08709 077 077

Republic of Ireland: (01) 842 6836

For further product information 08701 506070

All Hotpoint Services are offered as an extra benefit and do not affect your statutory rights.



General Domestic Appliances Limited, Morley Way, Peterborough, PE2 9JB