

Fisher & Paykel

Multifunction pyrolytic oven
OB60S9DEP, OB60S9DECP models

**Installation instructions
and User guide**

NZ AU GB IE SG

| | |
|---------------------------------|----|
| Safety and warnings | 2 |
| Installation instructions | 5 |
| Introduction | 10 |
| The control panel | 11 |
| Setting the clock and first use | 12 |
| Using your oven | 13 |
| Oven functions | 14 |
| Using the timer | 15 |
| Automatic cooking | 16 |
| Baking chart | 18 |
| User preference settings | 19 |
| Sabbath setting | 21 |
| Care and cleaning | 23 |
| Using the Self Clean function | 29 |
| Troubleshooting | 32 |
| Alert codes | 35 |
| Warranty and service | 37 |

Important!

SAVE THESE INSTRUCTIONS

The models shown in this user guide may not be available in all markets and are subject to change at any time. For current details about model and specification availability in your country, please visit our local website listed on the back cover or contact your local Fisher & Paykel dealer.

2 Safety and warnings

Installation

WARNING!



Electrical Shock Hazard

Always disconnect the appliance from the mains power supply before carrying out any maintenance or repairs.

Connection to a good earth wiring system is essential and mandatory. Alterations to the domestic wiring system must only be made by a qualified electrician.

Failure to follow this advice may result in death or electrical shock.

WARNING!



Fire Hazard

Do not use adapters, reducers, or branching devices to connect this appliance to the mains power supply.

Failure to follow this advice may result in overheating, burning, or fire.

WARNING!



Cut Hazard

Take care - panel edges are sharp.

Failure to use caution could result in injury or cuts.

Important safety instructions

- *To avoid hazard, follow these instructions carefully before installing or using this appliance.*
- *Please make this information available to the person installing the appliance - doing so could reduce your installation costs.*
- *This appliance must be installed and connected to the mains power supply only by a suitably qualified person according to these installation instructions and in compliance with any applicable local building and electricity regulations. Failure to install the appliance correctly could invalidate any warranty or liability claims.*

Operation

Your oven has been carefully designed to operate safely during normal cooking procedures. Please keep the following safety instructions in mind when you are using it:

WARNING!



Electrical Shock Hazard

Disconnect the oven from the power supply before replacing the oven light bulb. Failure to follow this advice may result in death or electrical shock.

WARNING!



Fire Hazard

Follow the instructions on starting a Self Clean cycle carefully. Items made from combustible materials (for example: wood, fabric, plastic) may catch fire if left in the oven during a Self Clean cycle.

Do not place aluminium foil, dishes, trays, water or ice on the oven floor during cooking, as doing so will irreversibly damage the enamel; lining the oven with aluminium foil may even cause fire.

Never use your appliance for warming or heating the room. Persons could be burned or injured or a fire could start.

Storage in or on appliance: flammable materials should not be stored in an oven or near its surface.

Failure to follow this advice may result in overheating, burning, and injury.

WARNING!



Hot Surface Hazard

Accessible parts may become hot when in use.

To avoid burns and scalds, keep children away.

Use oven mitts or other protection when handling hot surfaces such as oven shelves or dishes.

Use care when opening the oven door. Let hot air or steam escape before removing or replacing food.

Do not touch heating elements or interior surfaces of the oven. Heating elements may be hot even though they are dark in colour. Interior surfaces of an oven become hot enough to cause burns. During and after use, do not touch, or let clothing or other flammable materials contact heating elements or interior surfaces of the oven until they have had sufficient time to cool.

Other surfaces of the appliance may become hot enough to cause burns - among these surfaces are the oven vent, the surface near the oven vent, and the oven door.

Failure to follow this advice could result in burns and scalds.

WARNING!



Cut Hazard

Take care - some edges are sharp.

Failure to use caution could result in injury or cuts.

Important safety instructions

To reduce the risk of fire, electrical shock, injury to persons, or damage when using the oven, follow the important safety instructions listed below:

- *Read all the instructions before using the oven. Use the oven only for its intended purpose as described in these instructions.*
- *Proper installation: be sure your appliance is properly installed and earthed by a qualified technician.*
- *Isolating switch: make sure this oven is connected to a circuit which incorporates an isolating switch providing full disconnection from the power supply.*
- *Household appliances are not intended to be played with by children.*
- *Do not leave children alone. Children should not be left alone or unattended in the area where the appliance is in use. They should never be allowed to sit or stand on any part of the appliance.*
- *Children or persons with a disability which limits their ability to use the appliance, should have a responsible person to instruct them in its use. The instructor should be satisfied that they can use the appliance without danger to themselves or their surroundings.*
- *Do not place heavy objects on the oven door.*
- *Wear proper apparel. Do not wear loose fitting or hanging garments when using the appliance. They could ignite or melt if they touch an element or hot surface and you could be burned.*
- *User servicing: do not repair or replace any part of the appliance unless specifically recommended in the manual. All other servicing should be referred to a qualified technician.*
- *Do not use water on grease fires. Smother the fire or flame or use a dry chemical or foam type extinguisher.*
- *Use only dry oven mitts or potholders. Moist or damp potholders on hot surfaces could result in burns from steam. Do not let potholders touch hot areas or heating elements. Do not use a towel or a bulky cloth for a potholder. It could catch fire.*
- *Do not heat unopened food containers. They can build up pressure that may cause the container to burst and result in injury.*
- *Safe food handling: leave food in the oven for as short a time as possible before and after cooking. This is to avoid contamination by organisms which may cause food poisoning. Take particular care during warm weather.*
- *Always keep oven vents unobstructed.*
- *Do not operate your appliance by means of an external timer or separate remote-control system.*
- *If the power supply cable is damaged, it must be replaced by the manufacturer, its service agent or similarly qualified person in order to avoid a hazard.*
- *Under unfavourable electrical supply conditions, the appliance may cause temporary voltage drops.*

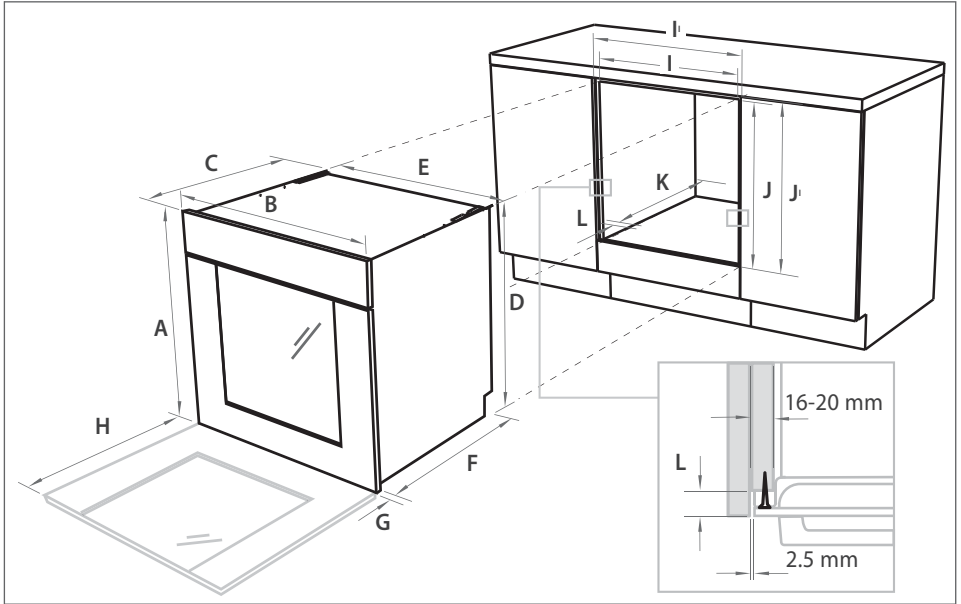

Fig. 1 Product and cabinetry dimensions

Product and cabinetry dimensions (mm)

| | OB60S9DEP | OB60S9DECP |
|--|-----------|------------|
| A overall height* of product | 597 | 597 |
| B overall width of product | 595 | 595 |
| C overall depth of product (excluding handle and knobs) | 567 | 567 |
| D height of chassis | 582 | 582 |
| E width of chassis | 556 | 556 |
| F depth of chassis | 545 | 545 |
| G depth of oven frame and control panel (=distance between front of chassis and front of oven door, excl. knobs) | 22 | 22 |
| H depth of oven door when fully open (measured from front of control panel) | 435 | 435 |
| I minimum inside width of cavity | 560 | 560 |
| I' overall width of cavity | 600 | 600 |
| J inside height of cavity | 585 | 585 |
| J' overall height of cavity | 600 | 600 |
| K minimum inside depth of cavity | 550 | 550 |
| L flush fitting cabinetry clearance | 22 | 22 |

Note: If installing a cooktop above the oven, ensure adequate clearance is provided for the cooktop as per the cooktop manufacturer's instructions.

*All height measurements include mounted feet.

Installation instructions

Before you install the oven, make sure that

- the benchtop and oven cavity are square and level, and are the required dimensions
- the installation will comply with all clearance requirements and applicable standards and regulations
- a suitable isolating switch providing full disconnection from the mains power supply is incorporated in the permanent wiring, mounted and positioned to comply with the local wiring rules and regulations. The isolating switch must be of an approved type and provide a 3 mm air gap contact separation in all poles (or in all active [phase] conductors if the local wiring rules allow for this variation of the requirements)
- the isolating switch will be easily accessible to the customer with the oven installed
- there is at least 1.5 m (and not more than 2 m) free length of power supply cable within the cavity for ease of installation and servicing
- the oven connection socket (if fitted) is outside the cavity if the oven is flush to the rear wall
- the oven will rest on a surface that can support its weight
- the height from the floor suits the customer
- you consult local building authorities and by-laws if in doubt regarding installation.

When you have installed the oven, make sure that

- the oven door can open fully without obstruction
- the power supply cable does not touch any hot metal parts
- the isolating switch is easily accessible by the customer
- you complete the 'Final checklist' at the end of these installation instructions.

Unpacking the oven

- Remove all packaging and dispose of it responsibly. Recycle items that you can.
- When you remove the oven from the carton, place it onto wooden blocks or similar supports to prevent damaging the lower trim.

Important!

Please take extra care not to damage the lower trim of the oven. It is important for correct air circulation and allows the door to open and close without obstruction. The manufacturer does not accept any responsibility for damage resulting from incorrect installation.

- You may remove the feet but ensure that the oven does not sit on the lower trim.

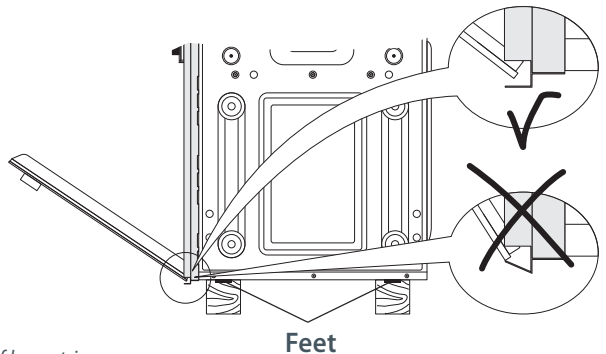
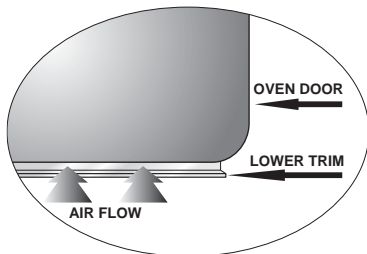

Fig. 2 Correct and incorrect placement of lower trim

Connecting the oven to the mains power supply

Important!

- *This oven must be connected to the mains power supply only by a suitably qualified person.*
- *This oven must be earthed.*

Before connecting the oven to the mains power supply, check that

- the domestic wiring system is suitable for the power drawn by the oven (as specified on the rating plate)
- the voltage corresponds to the value given on the rating plate.

| Model code | Power | Voltage |
|--------------|--------|--------------|
| OB60S9DEP.. | 3400 W | 220 - 240 V~ |
| OB60S9DECP.. | 3400 W | 220 - 240 V~ |

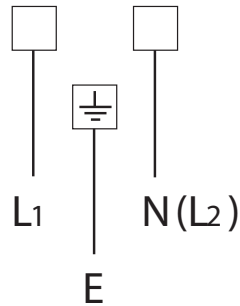
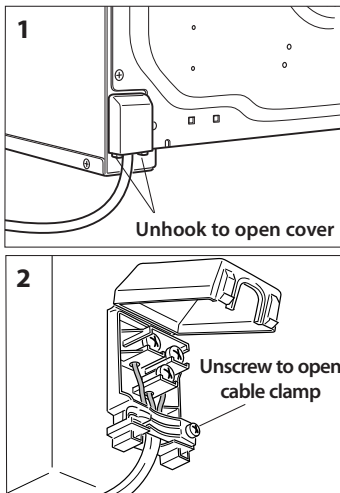

Fig. 3 Connecting the oven to the mains power supply

Securing the oven to the cabinetry

- 1 Position the oven in the prepared cavity.

Important!

Do not lift the oven by the door handle.

- 2 Open the oven door fully.
- 3 Use the supplied screws to secure the oven to the cabinetry.

Important!

- *Do not over-tighten the screws.*
- *Do not seal the oven into the cabinetry with silicone or glue. This makes future servicing difficult. Fisher & Paykel will not cover the costs of removing the oven, or of damage caused by this removal.*

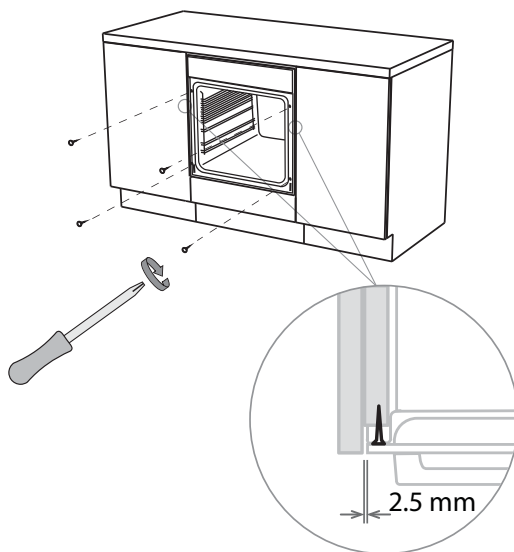

Fig. 4 Securing the oven to the cabinetry

Final checklist

TO BE COMPLETED BY THE INSTALLER



- Make sure the oven is level and securely fitted to the cabinetry.
- Check the lower trim is still undamaged.
- Open the oven door slowly to its fully open position and check if there is adequate clearance between the bottom of the door and the lower trim. This is to ensure correct air circulation. Should the lower trim become damaged, straighten the trim and ensure the oven door opens fully without obstruction.
- Make sure all the internal packaging has been removed from the oven cavity.
- Make sure all oven vents and openings are clear and are free of any obstruction/damage.

Important!

Failure to make sure all oven vents are unobstructed may result in poor product performance.

- Make sure that the isolating switch is accessible by the customer.
- Turn the power to the oven on. The display should light up and show **0-00**.
- Turn the oven function dial to 'Bake'. Air should blow out of the vent at the top of the oven. Inside the oven cavity, the oven light should come on. After five minutes, open the oven door: the air inside should feel warm.
- Turn the oven function dial back to OFF.
- Advise the customer to set the clock and condition the oven, following the instructions under 'Setting the clock and first use' in the user guide.

Installer's name: _____

Installer's signature: _____

Installation company: _____

Date of installation: _____

LEAVE THESE INSTRUCTIONS WITH THE CUSTOMER

10 Introduction

Congratulations on your new purchase. Your Fisher & Paykel multifunction pyrolytic oven has a number of features to make cooking a great experience for you:

- a choice of eight oven functions
- a convenient, no-mess, pyrolytic Self Clean function – see ‘Using the Self Clean function’
- intuitive electronic controls and displays
- illuminated halos around the dials for visual feedback
- preference settings – see ‘User preference settings’ and ‘Sabbath setting’.

Before you start

- Make sure the installer has completed the ‘Final checklist’ in the Installation instructions.
- Read this guide, taking special note of the ‘Safety and warnings’ section.
- Remove all the packaging and dispose of it responsibly. Recycle items that you can.
- Make sure you follow the instructions under ‘Setting the clock and first use’ before using your oven for cooking or baking.

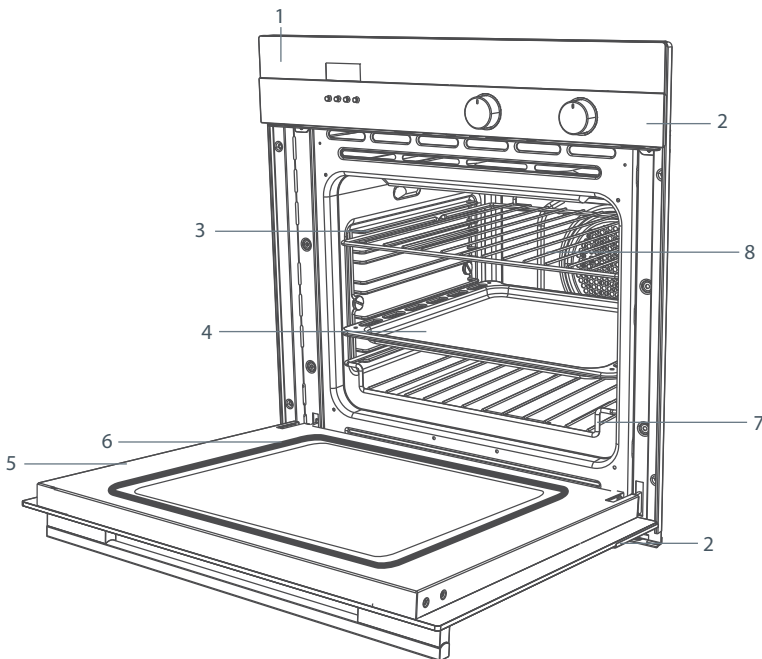

- 1 Control panel
- 2 Stainless steel strips
- 3 Side racks
- 4 Grill tray
- 5 Oven door and handle
- 6 Oven seal

- 7 Step-down oven shelf

- 8 Oven shelf

Not illustrated:

- Sliding shelf supports
- Grill rack
- Baking tray

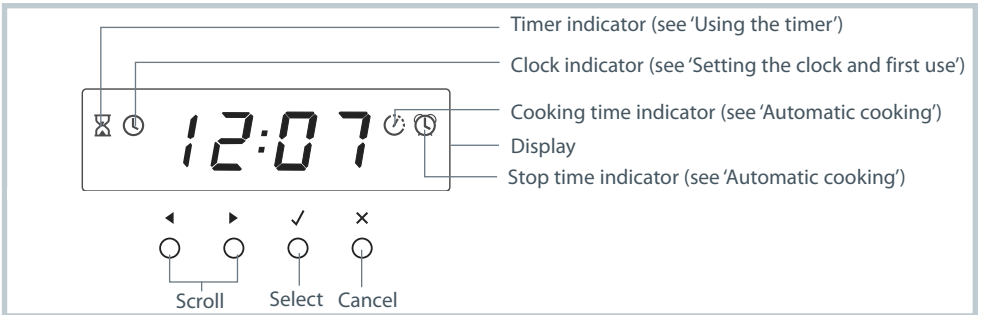
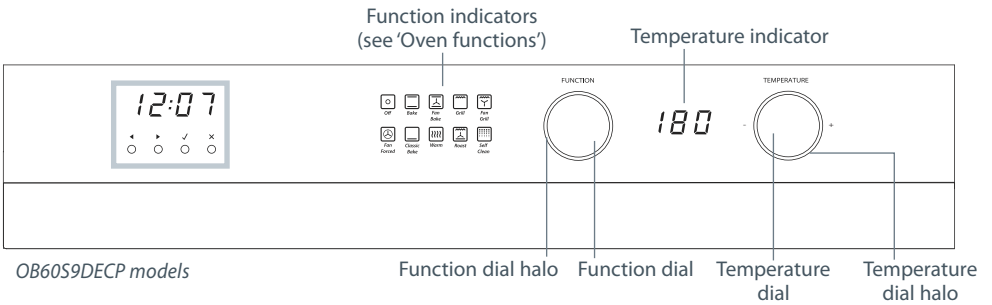
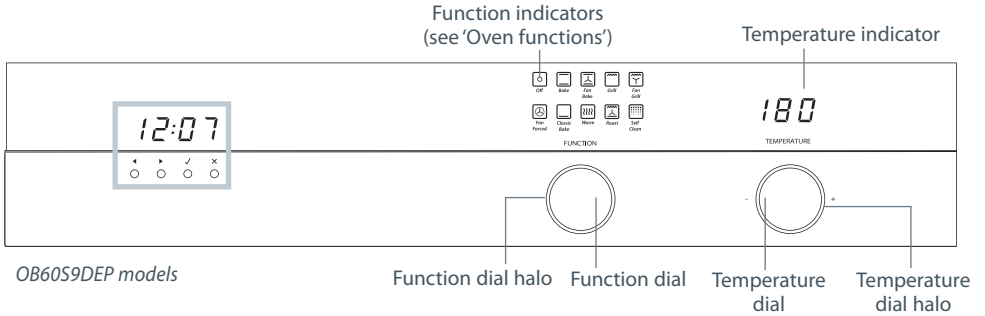

Locking the control panel

You can lock the control panel to prevent unintended use (eg children playing with the oven). Doing so will disable the dials and all the buttons.

To lock the control panel

- 1 Make sure the oven is not in use (the function dial is turned to **Off**) and neither automatic cooking nor the timer is set (no indicator is lit in the display).
- 2 Press and hold the select button until you hear a beep and --- appears in the temperature indicator.

To unlock the control panel

Press and hold the select or cancel button until you hear a beep and the temperature indicator becomes blank.

12 Setting the clock and first use



Setting the clock

You will need to set the clock to make full use of your oven.



- 1 Ensure the power supply to the oven is on.





- 2 Select the clock  by pressing the right scroll  button twice.
 - The clock  indicator will appear and the colon will flash.





- 3 Press the select  button to confirm.
 - The display will flash to indicate the clock is ready to be set.





- 4 Set the time by pressing the scroll   buttons. Holding the buttons down will speed up the scrolling.



- 5 Press the select  button to confirm.
 - The clock  indicator will soon disappear but the clock is now set.

First use: conditioning the oven

It is important to condition your oven before using it for cooking and baking. Conditioning will burn off any manufacturing residues and ensure that you get the best results right from the start.

- 1 Make sure you have set the clock.
- 2 Slide in the shelves and the grill tray.
 - See 'Using your oven' for instructions. If the sliding shelf supports are not already fitted, see 'Care and cleaning' for instructions on fitting them.
- 3 Heat the oven for:
 - 30 minutes at 200 °C using **Bake**  then
 - 15 minutes at 200 °C using **Fan Grill** 
 - See 'Using your oven' for instructions.
 - There will be a distinctive smell while you are conditioning the oven. This is normal, but make sure the kitchen is well ventilated during the conditioning.

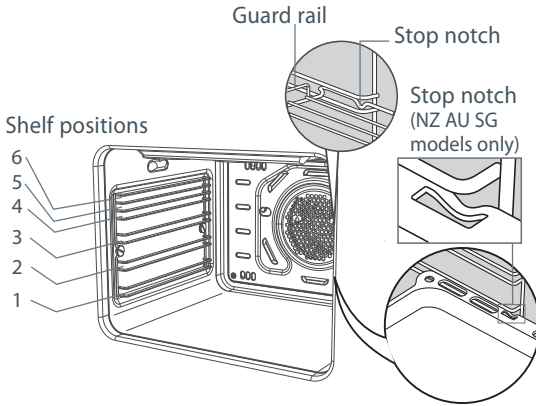

- 1 Slide in the shelves you will need, making sure that:
 - they are between the two wires of a shelf position or on the sliding shelf supports
 - the stop notches point down
 - the guard rail is at the back.
 - Note: the grill tray should be positioned between the two wires of a shelf position or on the sliding shelf supports, and orientated as shown.

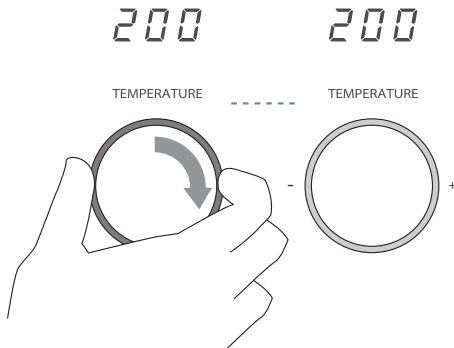

- 3 Adjust the temperature.
 - While the oven is heating up, the halo will glow red and the temperature indicator will alternately show the actual and set temperatures.
 - When the oven has reached the set temperature, a long tone will sound and the halo will turn white.
 - Note: **Grill** provides instant radiant heat, so the halo will stay red and there will be no tone.

Note: OB60S9DEP control panel illustrated

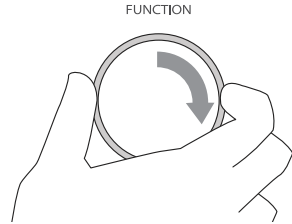

- 2 Select a function.
 - The halo will glow white.
 - The oven will start heating at the temperature preset for the function.

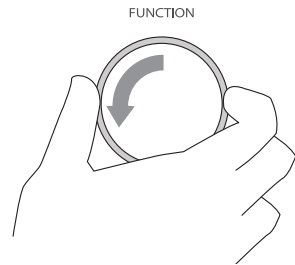

- 4 When you have finished cooking, turn the function dial to **Off** .

14 Oven functions



Off

Selecting this will turn the oven off.



Bake

This is the traditional method of baking. It is best to bake on only one shelf at a time in this function. Ideal for large cakes and dishes that bake for several hours.



Fan Bake

Ideal for dishes like lasagne that need to brown on top and also single trays of small cakes or biscuits that bake in less than an hour.



Grill

Grill is the most suitable function for 'finishing off' many meals, for example browning the top of potato gratin and frittata. Use Grill to toast bread or to grill your favourite chicken, fish and steak. Note: heat levels are from LO (50% power) to HI (100% power), with settings from 1 to 9 in between. Grill provides instant radiant heat, so the temperature dial halo will stay red.



Fan Grill

Fan Grill does not require preheating. Ideal for roasting tender cuts of meat and poultry. Use the lower shelf positions for larger items eg a whole chicken.



Fan Forced

Great for multi-shelf cooking. The consistent temperature ensures baking is well risen. Cookies baked on Fan Forced are crisp on the outside and chewy in the middle.



Classic Bake

This traditional baking function is suitable for recipes developed in older ovens. It is perfect for anything that does not require browning on the top, such as foods with a pastry base: custard tart, pie, quiche, cheesecake.



Warm

Use this function to keep cooked food hot and to warm plates and serving dishes. To reheat food from cold, use a cooking function at 150°C, then switch to Warm set between 70-90°C only when the food is piping hot. Note: this function is not for cooking food and the temperature cannot be set higher than 90°C.



Roast

Roast does not require preheating. The meat is seared during an initial 20-minute grilling stage, then baked at the set temperature for the rest of the time, producing a tender, juicy, and flavourful roast. Great for roasting vegetables too.



Self Clean

The Self Clean cycle takes care of the mess and grime that is traditionally associated with oven cleaning. See 'Using the Self Clean function' for details. Note: this is NOT a cooking function.

Important!

Use all the functions with the oven door closed.

- You can use the timer at any time, even if you are not using the oven.
- If the time is more than an hour, the display will count down in minutes (hr:min). If it is less than an hour, it will count down in seconds (min:sec).
- You can set the timer for up to 23 hours 59 minutes.

Important!

The timer does NOT turn the oven off.

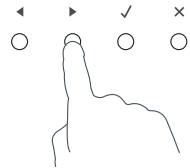
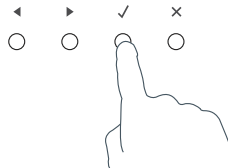
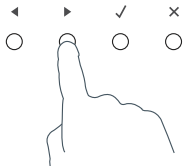

- 1 Select the timer by pressing the right scroll button once.
 - The timer indicator will appear and the colon will flash.
- 2 Press the select button to confirm.
 - The display will flash to indicate the timer is ready to be set.
- 3 Set the time by pressing the scroll buttons.
 - Holding the buttons down will speed up the scrolling.

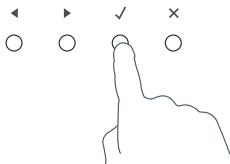
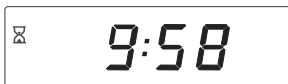

- 4 Press the select button to confirm.
 - The timer will then begin to count down.

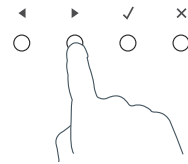
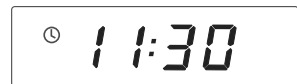

- 5 If you want to check the time of day, you can toggle between this and the timer countdown by pressing the scroll buttons.

To modify the timer setting

- 1 Make sure the display shows the remaining time counting down.
- 2 Press the select button.
- 3 Press the scroll buttons to set a new time.
- 4 Press the select button to confirm.

To cancel the timer setting

- 1 Make sure the display shows the remaining time counting down.
- 2 Press the cancel button until the display shows the time of day and the timer indicator disappears.

When the set time is up

- The display will show and a tone will sound every 15 seconds.
- Press any button to stop the tone sounding. The display will revert to showing the time of day.

16 Automatic cooking

- You can set the oven to automatically turn on later, cook for a preset time (cooking time), then automatically turn off at a preset stop time. See the example and instructions below (steps 1 to 7).
- If you start cooking manually and only want the oven to turn off automatically after a set cooking time: simply set the cooking time following steps 1 to 3 below. The oven will automatically turn off when the cooking time is over.

Important!

Safe food handling: leave food in the oven for as short a time as possible before and after cooking or defrosting. This is to avoid contamination by organisms which may cause food poisoning. Take particular care during warmer weather.

Example: It is 11:05 a.m. You want your food to cook for 1 hour, and you would like it to be ready by lunchtime (12:30 p.m.)

Set the cooking time



- 1 Check the clock shows the correct time of day.
- 2a Press the right scroll ► button three times to scroll to the cooking time ⌚ indicator.
- 2b Press the select ✓ button to confirm.
- 3a Press the right scroll ► button to set the cooking time. Make sure you allow for preheat time in your calculation.
- 3b Press the select ✓ button to confirm.

Set the stop time



- 4a Press the right scroll ► button once to scroll to the stop time ⌚ indicator.
- 4b Press the select ✓ button to confirm.
- 5a Press the right scroll ► button to set the time you would like your food to be ready by (ie the stop time).
- 5b Press the select ✓ button to confirm.

Select function and temperature

Note: OB60S9DEP control panel illustrated



FUNCTION

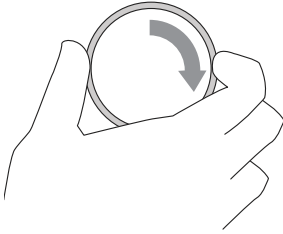

6 Select a function.

180

TEMPERATURE

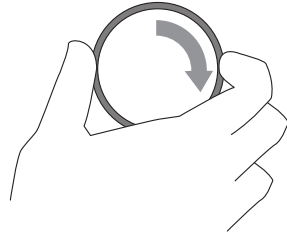

7 Adjust the temperature.

When automatic cooking is set

- The oven and the light will stay off, the halos will be unlit, but your oven is now set for automatic cooking. It will automatically turn on at the required time.
- In a few seconds, the display will show the time of day with the cooking time ⌚ and stop time ⌚ indicators lit.
- Note: you can modify the function and temperature while the oven is waiting to start cooking.

When the stop time is reached

The oven will automatically turn off and a long tone will sound.

To check the set cooking time and stop time

Use the scroll ◀ ▶ buttons.

To cancel automatic cooking

Turn the function dial to **Off** .

18 Baking chart

Please note:

- The settings in the following chart are guidelines only. Follow the instructions in your recipe or on food packaging and be prepared to adjust the oven settings and baking times to achieve the best possible results for you.
- Shelf positions are counted from the base up (1 is the lowest, 6 the highest).
- Position the flat oven shelf before you turn the oven on, then preheat the oven to the required temperature. Place items in the oven only when the long tone has sounded and the temperature dial halo has turned from red to white.*

| Food | Shelf position | Best function | Temperature (°C) | Time |
|------------------|----------------|---------------------|------------------|---|
| Sponge | 2 | <i>Fan Forced</i> | 160 | 30 mins |
| Small cakes | 2 | <i>Bake</i> | 175-185 | 16-23 mins |
| Scones | 2 | <i>Fan Bake</i> | 200-210 | 10-15 mins |
| Custard tart | 1 | <i>Classic Bake</i> | 220, then 180** | 10, then 25-30 mins** |
| Light fruit cake | 2 | <i>Fan Forced</i> | 150-160 | 1 hr 30 mins |
| Cookies | 2 | <i>Fan Bake</i> | 155-165 | 15-20 mins |
| Meringues | 1 | <i>Bake</i> | 90-120 | 1 hr |
| Muffins | 2 | <i>Bake</i> | 180-190 | 20-25 mins |
| Pizza | 2 | <i>Fan Bake</i> | 210 | 15-20 mins |
| Rich fruit cake | 2 | <i>Fan Forced</i> | 130-140 | 3-5 hrs (time will vary depending on size) |
| Bread rolls | 1 | <i>Fan Forced</i> | 180-190 | 15-20 mins |
| Pastry case | 2 | <i>Bake</i> | 180-190 | 15 + 5 mins (baked 'blind') |
| Apple pie | 1 | <i>Bake</i> | 175-185 | 35-45 mins |

* Note: the colour change and tone may occur some time after the set temperature has been reached. This is because—when heating up from cold—your oven is designed to initially heat to a temperature somewhat higher than what you have set. This is to provide optimal baking conditions right from the start.

** This is a two-stage baking process: adjust the temperature after the first stage.

You can set your oven to:

- display the temperature in degrees Celsius or Fahrenheit
- give audio feedback (tones and beeps) or operate quietly
- display time as 12-hr or 24-hr
- operate with the display off
- have its light on or off during cooking
- operate in Sabbath setting (see 'Sabbath setting' following).

How to change preference settings



- 1 Check the display shows the time of day.
- If you're unsure, press the cancel × button twice.

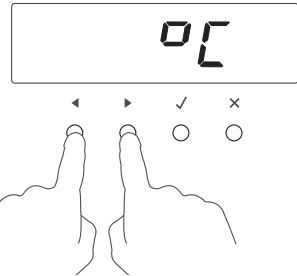

- 2 Press and hold the scroll ◀ ▶ buttons together for 3 seconds to enter the user preference menu.



- 3 Press the right scroll ▶ button to scroll to the setting you want to change. Refer to the table following.

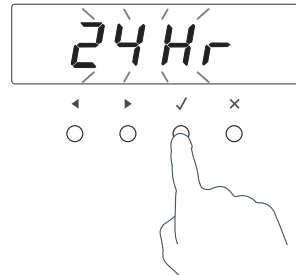

- 4 Press the select ✓ button to select the particular setting.
 - The display will flash.

20 User preference settings

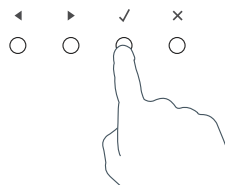
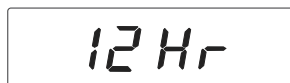
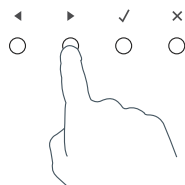
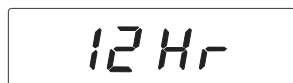

5 Press the right scroll ► button to scroll through the options for that particular setting. Refer to the table below.

6a Press the select ✓ button to save the new option .

6b For all options except 'Display off' : press the cancel × button to quit the user preference menu.

| Setting | Default option | Alternative option(s) | |
|---|--|---|---|
| TEMPERATURE SCALE <i>Select between degrees Celsius or Fahrenheit.</i> | CELSIUS 0C | FAHRENHEIT 0F | |
| AUDIO FEEDBACK <i>Turn the beeps and tones on or off.*</i> | BEEPS/TONES ON bP on | BEEPS/TONES OFF bP oF | |
| TIME SCALE & 'DISPLAY OFF' OPTION <i>Select between 24-hr or 12-hr clock display or set 'Display off' option if you only need the basic functionalities of your oven.</i> | 24 HR 24 Hr | 12 HR 12 Hr | DISPLAY OFF ** oFF |
| OVEN LIGHT <i>Have the light off during cooking if you want to save power or want the food to be a surprise for others!</i> | LIGHT ON DURING COOKING Lt on | LIGHT OFF DURING COOKING Lt oF | |
| SABBATH SETTING | SABBATH OFF 5b oF | See 'Sabbath setting' for instructions. | |

* The timer tone and alert beeps will sound even if you save the **BEEPS/TONES OFF** option.

** With this option saved, you can still use the oven but the display will be unlit and the buttons will be unresponsive. To quit this option and enable the display, press and hold the cancel × button.

This setting is designed for religious faiths that observe a 'no work' requirement on the Sabbath.

While your oven is in Sabbath setting

- The display, dial halos and indicators will be unlit, the buttons will be unresponsive.
- No tones or beeps will sound.
- No alert codes or temperature changes will be displayed.
- The oven light will stay on. If you want the oven light to be off during Sabbath setting, first select the 'Light off' option as described in 'User preference settings', and only then set Sabbath setting.
- **Bake**  is the only function available in Sabbath setting.

How to set Sabbath setting

Note: OB60S9DEP control panel illustrated

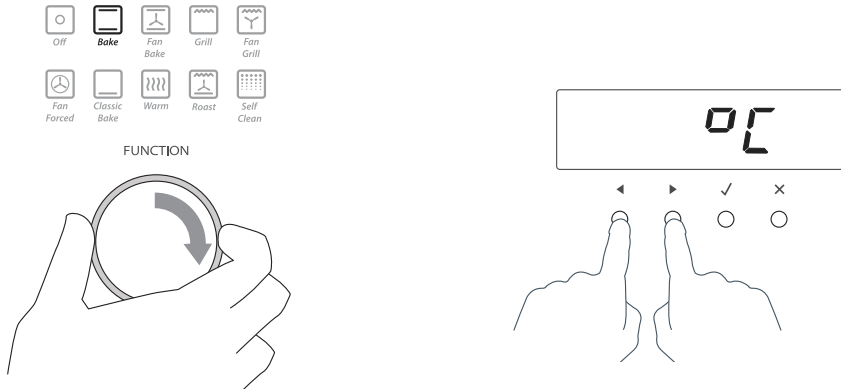

- 1a Select the **Bake**  function.
- 1b Set the desired temperature.
- 1c Wait until the oven starts up.

- 2 Press and hold the scroll ◀ ▶ buttons together for 3 seconds to enter the user preference menu.

22 Sabbath setting

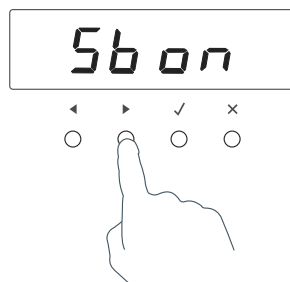
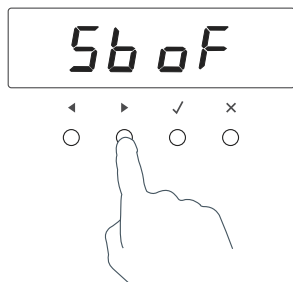

- 3a Press the right scroll ► button to scroll to the Sabbath setting.
- 3b Press the select ✓ button to select the Sabbath setting. The default option is 'Sabbath off'.
 - The display will flash.

- 4a Press the right scroll ► button to scroll to the 'Sabbath on' option.
- 4b Press the select ✓ button to activate the new option.

The display, indicators and dial halos will be unlit and unresponsive, but the oven will bake until you quit Sabbath setting.

To quit Sabbath setting

Press and hold the cancel × button until the time of day appears in the display and the oven turns off.

Manual cleaning

| DOs | DON'Ts |
|---|--|
| <ul style="list-style-type: none"> ▪ <i>Before any manual cleaning or maintenance, first wait for the oven to cool down to a safe temperature to touch, then disconnect it from the power supply.</i> ▪ <i>Read these cleaning instructions and the 'Safety and warnings' section before you start cleaning your oven.</i> ▪ <i>See the following pages for instructions on removing and refitting different parts of the oven for cleaning.</i> ▪ <i>To prevent soiling from becoming 'baked on' and stubborn, we recommend removing any easy-to-reach spills, food or grease stains from the oven cavity enamel after each use. Doing so will reduce the need for using the Self Clean function frequently.</i> | <ul style="list-style-type: none"> ▪ <i>Don't use a steam cleaner.</i> ▪ <i>Don't keep flammable substances in the oven.</i> ▪ <i>Don't use oven cleaners or any abrasive or harsh cleaners, cloths, scouring pads or steel wool.</i> ▪ <i>Don't leave alkaline (salty spills) or acidic substances (such as lemon juice or vinegar) on the oven surfaces.</i> ▪ <i>Don't use cleaning products with a chlorine or acidic base.</i> ▪ <i>Don't clean the oven seal (see 'Introduction' for illustration of this part) or use any oven cleaning products on it.</i> |

| What? | How? | Important! |
|--|--|--|
| <p><i>Glass surfaces (oven door glass, control panel)</i></p> | <ol style="list-style-type: none"> 1 Clean these using a soft cloth with a solution of mild detergent or baking soda and hot water, then wipe dry. 2 Wipe with a glass cleaner and dry with a soft, lint-free cloth. <ul style="list-style-type: none"> ▪ Note: the inside of the oven door glass will be cleaned during a Self Clean cycle. However, for best results, we recommend cleaning stubborn stains manually before a Self Clean cycle. | <ul style="list-style-type: none"> ▪ <i>Don't use oven cleaners or any other harsh/abrasive cleaners, cloths, scouring pads, steel wool or sharp metal scrapers to clean the glass surfaces. These scratch the glass, which in turn could result in the glass cracking or shattering.</i> ▪ <i>Take particular care when cleaning the control panel glass.</i> |
| <p><i>Dials</i></p> | <p>Clean with a solution of mild detergent and hot water, then wipe dry.</p> | <p><i>Do not use stainless steel or oven cleaner on the dials, as doing so may damage their coating.</i></p> |

Manual cleaning

| What? | How? | <i>Important!</i> |
|--|---|--|
| Stainless steel strip on the front of the oven door and the control panel | <ul style="list-style-type: none"> ■ Clean with a solution of mild detergent and hot water, then wipe dry with a microfibre cloth. ■ If necessary, use a suitable stainless steel cleaner and polish. | <ul style="list-style-type: none"> ■ <i>Always read the label to make sure that your stainless steel cleaner does not contain chlorine compounds as these are corrosive and may damage the appearance of your oven.</i> ■ <i>Always rub the stainless steel in the direction of the grain.</i> |
| Oven cavity | <ul style="list-style-type: none"> ■ To clean light soiling off the enamelled surfaces: <ol style="list-style-type: none"> 1 Wipe with a damp cloth and a solution of hot water and mild detergent. 2 Wipe dry with a soft cloth. ■ To clean stubborn, 'baked on' soiling or the whole oven cavity: use the Self Clean function. See 'Using the Self Clean function' for instructions. | <ul style="list-style-type: none"> ■ <i>To prevent soiling from becoming 'baked on' and stubborn, we recommend removing any easy -to -reach spills, food or grease stains from the enamelled surfaces after each use. Doing so will reduce the need for using the Self Clean function frequently.</i> ■ <i>To make wiping out the oven cavity easier, you can remove the side racks and the oven door. See the pages following for instructions.</i> |
| Grill tray Grill rack Side racks Oven shelves Baking tray | <ul style="list-style-type: none"> ■ Clean with a solution of mild detergent and hot water. ■ Pre-soak stubborn burnt-on stains in a solution of dishwasher or laundry powder and hot water.. ■ Except for the baking tray, these parts are also dishwasher safe. | <p><i>Never leave these parts in the oven during a Self Clean cycle. They will get discoloured or damaged.</i></p> |
| Oven seal | Do not clean this part. | |
| Sliding shelf supports | Wipe with a damp cloth and mild detergent. Do not wipe off or wash away the white lubricating grease(visible when the slides are extended). | <p><i>Do not wash these in the dishwasher, immerse in soapy water, use oven cleaner on them, or leave in the oven during a Self Clean cycle. Doing so will remove the white lubricating grease and prevent the slides from running smoothly.</i></p> |

Removing and refitting the side racks

- Use a flat-head screwdriver or a small coin to loosen the fixing screws in the front.
- When refitting the side racks, make sure that they are the right way up, as in the illustrations, and that you tighten the fixing screws.

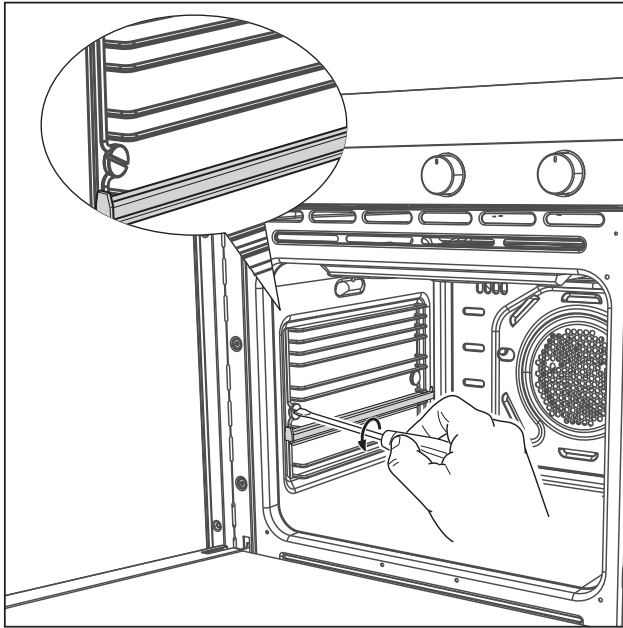

Fig. 5 Removing the side racks

Removing and refitting the sliding shelf supports

Important!

- Remove the side racks first to make removing the sliding shelf supports easier.
- The sliding shelf supports cannot be used on shelf positions 4 and 5.

When refitting the sliding shelf supports, make sure that you fit:

- the side racks first
- the slides to the top wire of a shelf position (1,2,3 or 6)
- both sides of each pair of slides
- both slides on the same level.

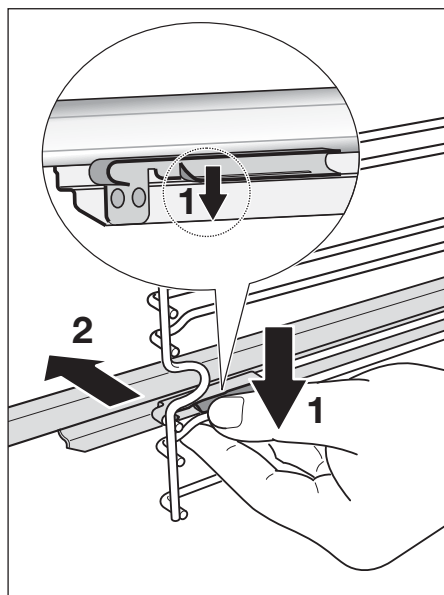

Fig.6 Removing the sliding shelf supports

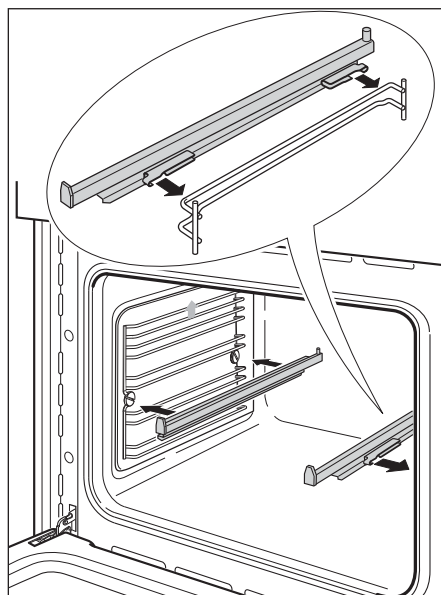

Fig.7 Refitting the sliding shelf supports

Removing and refitting the oven door

You can remove the door to make wiping out the oven cavity or replacing the light bulb easier.

Important!

Take care, the oven door is heavy!

To remove the door

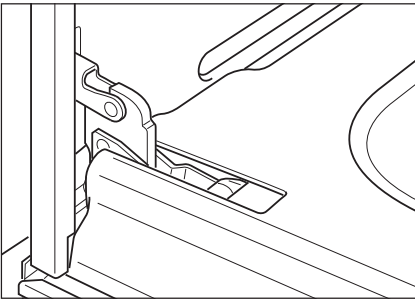

1 Open the door fully.

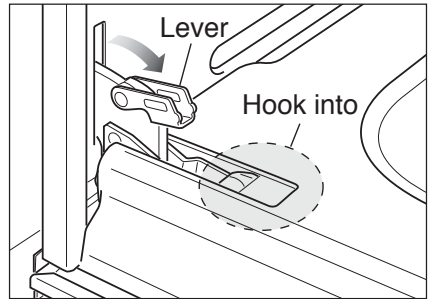

2 Open the levers.

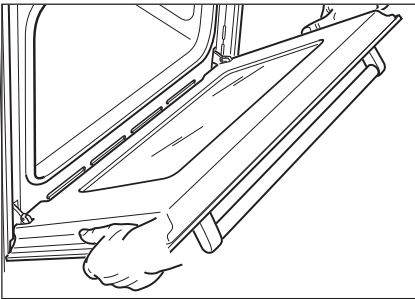

3 Hold the door.

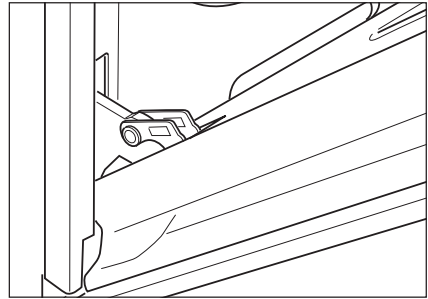

4 Close the door until the levers hook to it.

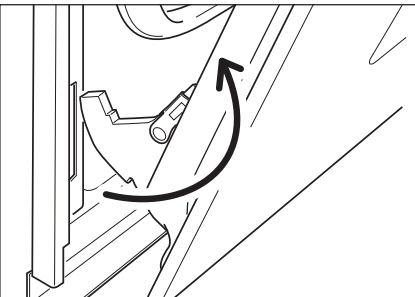

5 Disengage the hinges and remove the door.

To refit the door

Repeat these steps in reverse order.

Replacing the oven light bulb

Note: oven bulb replacement is not covered by your warranty.

- 1 Let the oven cavity and the grill element cool down.
- 2 **Important!**
Disconnect the oven from the power supply before continuing.
- 3 Release the lamp cover by pulling the tab on its left side towards you.
- 4 Unscrew and replace the bulb with a new one suitable for high temperatures (300°C) with the following specifications: 220-240V, 50Hz, E14 and same wattage as the bulb being replaced (check wattage stamped on the bulb).
- 5 Refit the lamp cover by pushing it back into its frame. Check that it is fully inserted.
- 6 Turn the power to the oven back on.
- 7 Set the clock. See 'Setting the clock and first-use'.

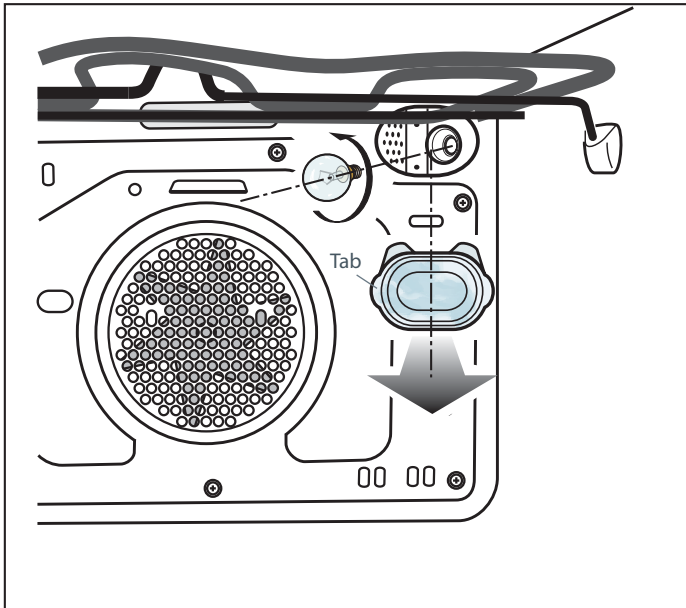

Fig. 8 Replacing the oven light bulb

- This convenient pyrolytic Self Clean function takes care of the mess and grime that is traditionally associated with oven cleaning. The extremely high temperature during a Self Clean cycle burns off and breaks down stubborn soil and grease deposits. All that remains is a clean oven cavity with a little grey ash which you can easily remove.
- A Self Clean cycle lasts about 3 hours.

Important!

- *Do not use oven cleaners, any degreasing cleaners, or oven liners.*
- *Make sure you remove the side racks, oven shelves and trays, and all other bakeware and utensils from the oven before starting a Self Clean cycle. If left in the oven, they will become permanently discoloured or damaged; items made from combustible materials (eg wood, fabric, plastic) may even catch fire.*
- *Do not use your oven to clean miscellaneous parts.*
- *Make sure the room is well ventilated.*
- *Before starting a Self Clean cycle, make sure you move any pet birds to another, closed and well-ventilated room. Some pet birds are extremely sensitive to the fumes given off during a Self Clean cycle, and may die if left in the same room as the oven during such a cycle.*
- *During a Self Clean cycle, the oven reaches higher temperatures than it does for cooking. Under such conditions, the surfaces may get hotter than usual and children should be kept away.*
- *The oven door will be locked during the Self Clean cycle (approximately 3 hours).*
- *If there are cracks or flaws on any of the oven door glass panes, if the oven seal is damaged or worn, or if the door does not close properly, do not start a Self Clean cycle. Call your Authorised Repairer or Customer Care.*

To start a Self Clean cycle

- 1 Remove oven shelves, side racks and all other accessories, bakeware, and utensils.
- 2 Wipe up any spills. Failure to do so may discolour the oven surfaces. For best results, we also recommend cleaning the inside of the oven door glass manually before a Self Clean cycle. See 'Care and cleaning' for instructions.
- 3 **Close the oven door firmly.**

Using the Self Clean function

Note: OB60S9DEP control panel illustrated



FUNCTION

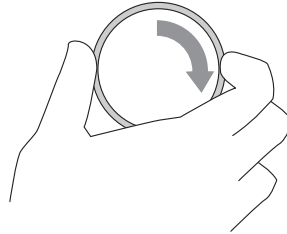

4 Select the **Self Clean**  function.

- The display will flash **3:00**, indicating the duration of a Self Clean cycle (3 hours).
- The temperature indicator will be blank, as temperature cannot be adjusted.

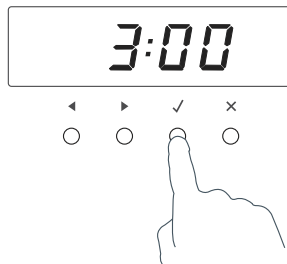

5 Once the display is flashing **3:00**, press the select **✓** button to start the Self Clean cycle.

- The time will start counting down.
- For your safety, the oven door will automatically lock and remain locked during the cycle.
- Note: if the select **✓** button is not pressed within 15 seconds, the oven will automatically turn off. Start from step 4 again.

When a Self Clean cycle has finished

- The oven will:
- emit a long tone
- automatically turn off
- automatically unlock the door.

In a few seconds, the display will show the time of day.

You need to:

- 1 wait for the oven to cool down completely
- 2 remove the grey ash with a small brush or damp cloth
- 3 wipe out the oven with a clean damp cloth
- 4 dry with a clean lint-free cloth
- 5 replace the side racks and shelves.

To cancel a Self Clean cycle

Important!

- *A Self Clean cycle can only be cancelled while the function dial halo is lit.*
- *If the function dial halo is unlit, the Self Clean cycle is in its cool-down phase and cannot be cancelled. Do NOT turn off the mains power supply to the oven. Turning off the power while the oven is too hot may damage the oven and its surrounding cabinetry.*



OR



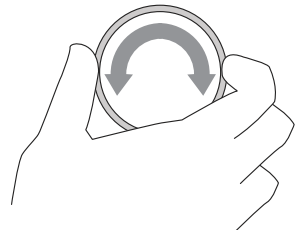

FUNCTION



Note: OB60S9DEP control panel illustrated



To cancel a Self Clean cycle, press the cancel x button or turn the function dial in either direction.

- If the oven needs to cool down, the **Self Clean**  function indicator will stay lit, the display will show the remaining cool-down time, the temperature indicator will show cascading bars  and the door will remain locked.
- When it has cooled down, the oven will turn off, the door will unlock, a long tone will sound and the display will show the time of day.
- We do not recommend cancelling a Self Clean cycle and then immediately starting one again.

Troubleshooting chart

If there is a problem, check the chart below to see if you can fix it. If the problem cannot be fixed or persists, call your Authorised Repairer or Customer Care.

| Problem | Possible causes | What to do |
|--|--|--|
| <i>General</i> | | |
| The oven does not work and the display is dark. | No power. | Check that the mains power supply is turned on and there is no power outage in your area. |
| The oven does not work but the display is lit. | The oven is set for automatic cooking. | See 'Automatic cooking' for information. |
| The light does not come on when I open the oven door. | The oven light bulb has blown. | Replace the light bulb. See 'Care and cleaning' for instructions. |
| | The door is not correctly fitted. | See 'Care and cleaning' for instructions on fitting the door correctly. |
| | The oven is in Sabbath setting and the 'Light off' option has been saved. | To quit Sabbath setting, press and hold the cancel × button. See 'User preference settings' for instructions on changing the 'Light off' option. |
| The temperature indicator shows --- and the dials and buttons are unresponsive. | The control panel is locked. | Press and hold the select ✓ or cancel × button to unlock the control panel. |
| The oven is not heating. | The door is not properly closed or it is opened too frequently during cooking. | The heating elements are disabled while the door is open. Make sure the door is properly closed and avoid opening it frequently during cooking. |
| A glass pane in the oven door has cracked, chipped, or shattered. | Incorrect cleaning. | You must NOT use the oven. Call your Authorised Repairer or Customer Care. |

| Problem | Possible causes | What to do |
|--|--|---|
| <i>General</i> | | |
| The oven has reached the set temperature but the temperature dial halo is still red | This is normal: when heating up from cold, your oven is designed to initially heat to a temperature somewhat higher than what you have set. This is to provide optimal baking conditions right from the start. | |
| The oven is heating but the display is dark. | The oven is set to 'Display off' option. | To quit the 'Display off' option, press and hold the cancel × button until the display shows the time of day. |
| | The oven is in Sabbath setting. | To quit Sabbath setting, press and hold the cancel × button until the display shows the time of day. |
| The oven cancels automatic cooking when I try to adjust the clock setting. | The oven was set for automatic cooking when you were trying to adjust the clock setting. | You can only adjust the clock setting while the oven is not set for automatic cooking. See section 'Setting the clock and first use' for instructions. |
| The oven beeps when I try to turn the temperature dial OFF or below a certain temperature. | This is normal: for food safety reasons, the oven functions have factory-set minimum temperature settings. | The temperature dial itself cannot be 'turned off'. Selecting Off  with the function dial will turn the oven off. |
| The temperature dial halo never turns white when I use Grill . | This is normal: the halo stays red to indicate that the grill element provides instant radiant heat. | |

| Problem | Possible causes | What to do |
|--|---|--|
| <i>Self Clean function</i> | | |
| During a Self Clean cycle, the oven is louder than usual. | This is normal: the oven's cooling fans operate at their highest speed. | |
| The display shows <i>door</i>. | The door has not been properly closed. | Make sure you close the door properly. |
| The display shows <i>0:00</i> but the oven door will not open. | The oven door is locked because the oven is still too hot to be used for cooking. | Wait until the Self Clean cycle has finished. If you cancelled a Self Clean cycle which was already underway, the oven still needs to cool down before it can be used. The oven door will automatically unlock. |
| At a point during a Self Clean cycle, the function dial halo goes out and the temperature indicator starts displaying cascading bars <i>----</i>. | This is normal: the oven is in the last phase of the Self Clean cycle, cooling down. | Wait until the Self Clean cycle has finished. A long tone will sound and the oven door will automatically unlock when the oven is ready to use. |
| I have cancelled a Self Clean cycle but cannot use the oven: <ul style="list-style-type: none"> ■ the oven door will not open ■ the display is still counting down minutes or showing <i>0:00</i> ■ the <i>Self Clean</i>  function indicator is still lit ■ the temperature indicator shows cascading bars <i>----</i> ■ the dials and buttons are unresponsive. | This is normal: if the function dial halo is unlit, you have successfully cancelled the Self Clean cycle. However, the oven is still too hot to be used for cooking and needs to cool down. | Wait until the cool-down phase has finished. A long tone will sound and the oven door will automatically unlock when the oven is ready to use. Note: depending on when the Self Clean cycle was cancelled, the cool-down phase may take up to 45 minutes. |
| The oven is beeping and the display shows <i>A2</i> or <i>A3</i>. | See section 'Alert codes' for instructions. | |

If there is a problem, the oven will:

- automatically suspend all oven functions
- beep five times
- display an alert code.

Important!

Do not turn off the mains power supply to the oven if you get an alert code, unless the instructions in the chart following specifically instruct you to. There are cooling fans within the oven which are needed to cool the oven's components. Turning off the power while the oven is too hot may damage the oven and its surrounding cabinetry.

What to do if an alert code is displayed

- 1 If the beeping hasn't stopped already, press any button to stop it.
- 2 Make a note of the alert code displayed. You may need this information.
- 3 Check the chart following to see if you can fix the problem yourself and follow the instructions.
- 4 *If you can fix the problem* and the alert code does not reappear, you can keep using your oven.

OR

If you can't fix the problem yourself or the alert code reappears and the problem persists: wait until the cooling fans have stopped and the oven has completely cooled down, then turn the power to the oven off and call your Authorised Repairer or Customer Care with the alert code information.

| Alert code | Possible causes | What to do |
|-------------------|---|---|
| <i>A1</i> | The oven has overheated. | <ol style="list-style-type: none"> 1 Allow the oven to cool down. 2 If the door is locked, wait until it automatically unlocks. 3 Once the oven has cooled down and the door has unlocked, the alert code will disappear. You can now use the oven again. |
| <i>A2</i> | Door lock error: the door cannot be locked after you have started a Self Clean cycle. | <ol style="list-style-type: none"> 1 Turn the power to the oven off and on again. 2 Wait approximately 10 seconds. This is to allow the door lock to return to its initial position. 3 Set the clock. See 'Setting the clock and first use' for instructions. 4 Try starting a Self Clean cycle again, making sure that you close the door firmly. See 'Using the Self Clean function'. |
| <i>A3</i> | Door lock error: the door cannot be unlocked after a Self Clean cycle has finished. | <ol style="list-style-type: none"> 1 Turn the power to the oven off and on again. 2 Try pressing on the oven door to help the door lock disengage. 3 If this doesn't help and the alert code reappears, call your Authorised Repairer or Customer Care. |
| <i>F</i> + number | Technical fault. | <ol style="list-style-type: none"> 1 Note down the alert code. 2 Wait until the cooling fans have stopped and the oven has completely cooled down. 3 Turn the power to the oven off. 4 Call your Authorised Repairer or Customer Care with the alert code information. |

Before you call for service or assistance ...

Check the things you can do yourself. Refer to the installation instructions and your user guide and check that:

- 1 your product is correctly installed.
- 2 you are familiar with its normal operation.

If after checking these points you still need assistance or parts, please refer to the Service & Warranty book for warranty details and your nearest Authorised Repairer, or contact us through our local website listed on the back cover.

This oven has been designed and constructed in accordance with the following codes and specifications:

In New Zealand and Australia:

AS/NZS 60335-1 General Requirements for Domestic electrical appliances

AS/NZS 60335-2-6 Particular Requirements for Domestic electrical cooking appliances

AS/NZS 1044 Electromagnetic Compatibility Requirements.

In Europe:

Safety requirements of EEC Directive "Low voltage" 2006/95:

- EN 60335-1 General Requirements for Domestic electrical appliances

- EN 60335-2-6 Particular Requirements for Domestic electrical cooking appliances

Safety requirements of EEC Directive "EMC" 2004/108:

- EN 55014-1, EN 55014-2, EN 61000-3-2, EN 61000-3-3 Electromagnetic Compatibility Requirements



Requirements of EEC Directive 93/68.

European directive 2002/96/EC on Waste Electrical and Electronic Equipment (WEEE)
(for European Union countries only)

GB This appliance is marked according to the European directive 2002/96/EC on Waste Electrical and Electronic Equipment (WEEE). By ensuring this product is disposed of correctly, you will help prevent potential negative consequences for the environment and human health, which could otherwise be caused by inappropriate waste handling of this product.

The symbol  on the product, or on the documents accompanying the product, indicates that this appliance may not be treated as household waste. Instead it shall be handed over to the applicable collection point for the recycling of electrical and electronic equipment. Disposal must be carried out in accordance with local environmental regulations for waste disposal. For more detailed information about treatment, recovery and recycling of this product, please contact your local city office, your household waste disposal service or the shop where you purchased the product.

www.fisherpaykel.co.nz
www.fisherpaykel.com.au
www.fisherpaykel.co.uk
www.fisherpaykel.ie
www.fisherpaykel.com.sg

Fisher & Paykel

Copyright © Fisher & Paykel 2011. All rights reserved.

The product specifications in this booklet apply to the specific products and models described at the date of issue. Under our policy of continuous product improvement, these specifications may change at any time. You should therefore check with your Dealer to ensure this booklet correctly describes the product currently available.