

I N F O

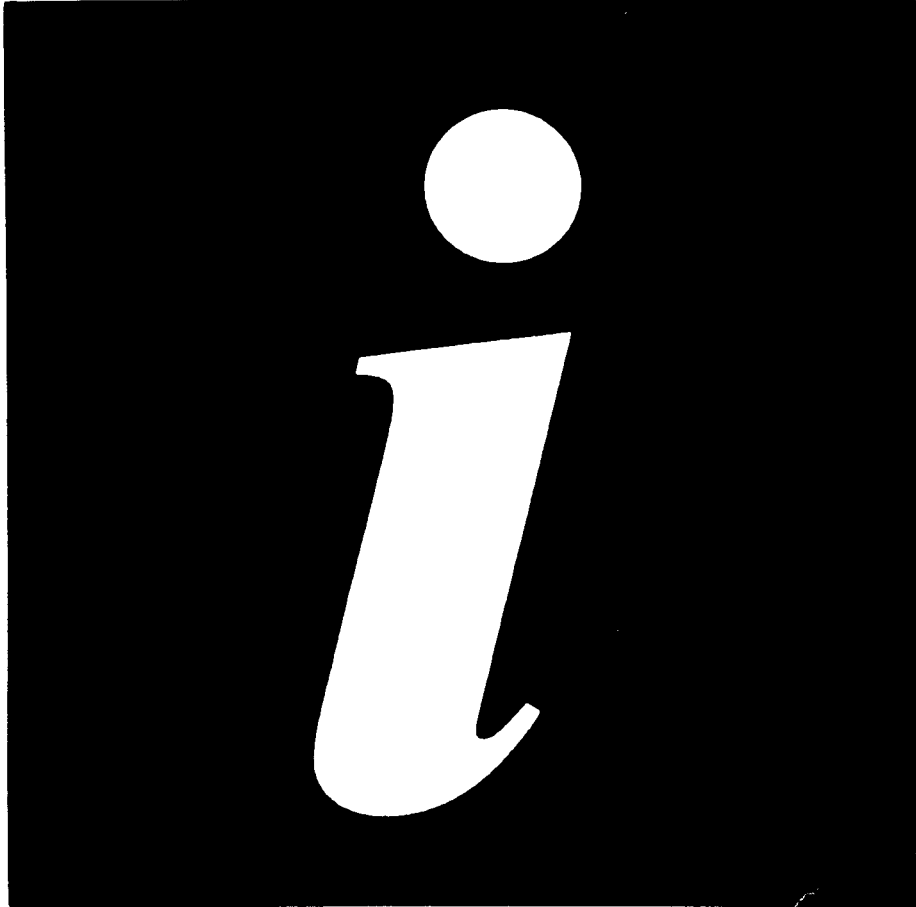

OPERATING AND INSTALLATION MANUAL

EOB846

BUILT-IN OVEN

 **Electrolux**



# Important Safety Instructions



These warnings are provided in the interest of safety. You **MUST** read them carefully before installing or using the appliance. Your safety is of paramount importance. If you are unsure about any of the meanings of these **WARNINGS**, contact the Customer Care Department.

## Installation

- The oven must be installed according to the instructions supplied. Any electrical work must be undertaken by a qualified electrician/competent person.
- This oven is heavy and care must be taken when moving it. Do not try to move the appliance by pulling the door handle.
- Remove **all packaging**, both inside and outside the oven, before using the appliance. After installation, please dispose of the packaging with due regard to safety and the environment.
- **It is dangerous** to alter the specifications or modify the appliance in any way.

## During Use

- This oven has been designed for cooking edible foodstuffs only and **must not** be used for any other purposes.
- Never line any part of the oven with **aluminium foil**. Do not allow heatproof cooking material, e.g. roastings bags, to come into contact with oven elements.
- **Never** place plastic or any other material which may melt in or on the oven.
- **Do not** place sealed cans or aerosols inside the oven. They may explode if they are heated.
- **Do not** hang towels, dishcloths or clothes from the oven or its handle. They are a **safety hazard**.
- **Do not** use this oven if it is in contact with water and never operate it with wet hands.
- Always cook with the oven door closed.
- Use any oven proof cookware which will withstand temperatures of 275°C.
- Take **great care** when heating fats and oils as they will ignite if they become too hot.
- **Always** use oven gloves to remove and replace food in the oven. Similarly always use oven gloves to remove and replace the grill pan handles, before and after grilling.
- **Always** remove the grill pan handles when grilling.

- Ensure that you **support** the grill pan when removing it from the oven.
- **Take care** to follow the recommendations given for tending the food when grilling.
- **Always** stand back from the oven when opening the oven door, to allow any build-up of steam or heat to release.
- Stand clear when opening the drop down oven door. **Do not** allow it to fall open – support the door using the door handle, until it is fully open.
- Ensure that the anti-tip oven shelves are installed in the correct way (see instructions).
- Ensure that all control knobs are in the **OFF** position when not in use.
- **Do not** leave cookware containing foodstuffs, e.g. fat or oil in or on the oven in case it is inadvertently switched **ON**.
- When using other electrical appliances, ensure the cable does not come into contact with the hot surfaces of the cooking appliance.

## Child Safety

- This appliance is designed to be operated by adults. Young children **must not** be allowed to tamper with the controls or play near or with the appliance.
- Accessible parts, especially around the grill area, become hot when the cooker is in use. Children should be **kept away** until it has cooled.

**The front of the oven gets hot during use : always keep small children away.**

- As an additional safety feature a cool door Kit is available as an optional extra from your local Service Force Centre (see Chapter "FOR THE INSTALLER").

## Maintenance and Cleaning

- **Only** clean this oven in accordance with the instructions.
- The oven should be kept clean at all times. A build-up of fats or other foodstuffs could result in a fire, especially in the grill pan.

- Steam and high-pressure cleaning units are not suitable for cleaning because of the requirements of electrical safety.
- Always switch off at the electrical supply prior to carrying out any cleaning or maintenance work.

### **Service**

- You must not attempt to repair the appliance yourself. Repairs carried out by inexperienced persons may cause injury or serious malfunctioning. Refer to your local ELECTROLUX Service Force Centre. Always insist on genuine ELECTROLUX spare parts.

### **Disposal of an old appliance**

- Make the appliance unusable, by cutting off the cable, and remove any door catches, to prevent small children being trapped inside.

It is most important that this instruction book should be retained with the appliance for future reference. Should the appliance be sold or transferred, always ensure that the book is left with the appliance in order that the new owner can get to know the functions of the appliance and the relevant warnings.

# Table of Contents

<b>FOR THE USER</b>		<b>FOR THE INSTALLER</b> .....	<b>26</b>
<b>Important Safety Instructions</b> .....	<b>3</b>	Technical information .....	26
<b>YOUR BUILT-IN OVEN</b> .....	<b>6</b>	Fitting the oven into an "in column" or "under counter" cabinet .....	27
<b>BEFORE THE FIRST USE</b> .....	<b>7</b>	Electrical connections .....	28
<b>THE COUNTDOWN (MINUTE MINDER)</b> .	<b>8</b>	Choice of electrical connections .....	29
<b>OVEN CONTROLS</b> .....	<b>9</b>		
The function selector .....	9		
The temperature control .....	9		
The neon indicator lights .....	9		
<b>THE OVEN CAVITY</b> .....	<b>10</b>		
Oven accessories .....	11		
The cooking levels .....	11		
<b>THE DIFFERENT COOKING SETTINGS</b>	<b>12</b>		
<b>COOKING FUNCTIONS</b> .....	<b>13</b>		
Fan oven .....	13		
Grill .....	15		
<b>HINTS FOR SUCCESSFUL COOKING</b> ..	<b>16</b>		
<b>COOKING GUIDES</b> .....	<b>17</b>		
<b>CLEANING AND CARE</b> .....	<b>19</b>		
<b>REPLACING THE OVEN LIGHT</b> .....	<b>20</b>		
<b>IF SOMETHING DOESN'T WORK ?</b> ....	<b>21</b>		
<b>SERVICE AND SPARE PARTS</b> .....	<b>22</b>		
<b>GUARANTEE CONDITIONS</b> .....	<b>23</b>		
<b>ELECTROLUX SERVICE FORCE</b> .....	<b>24</b>		

## Guide to use the Instruction Book

This section explains standard symbols used throughout to make it easier for the User to find information i.e



Safety instructions

**1.2.3.**

Step by step instructions for an operation



Hints and tips



Environmental information

# YOUR BUILT-IN OVEN

## General view

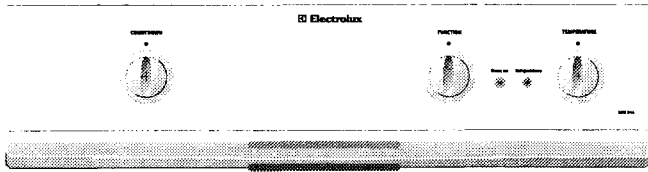

Control panel with minute minder, function selector and temperature control

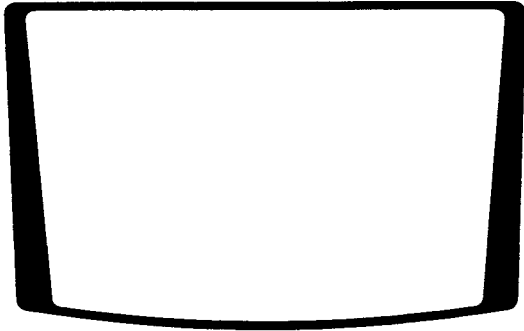

Full glass door with maximum visibility

## Control panel

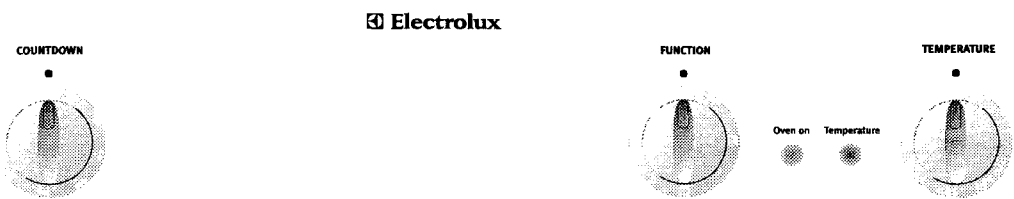

EOB 846

- ① Countdown
- ② Function selector
- ③ Oven on indicator light
- ④ Temperature indicator light
- ⑤ Temperature control

## BEFORE THE FIRST USE

-  Remove **all packaging**, both inside and outside the oven, before using the appliance.

### First cleaning

Remove the accessories and wash in warm and soapy water. Then rinse and dry carefully.

### First heating up

-  In order to remove possible production remnants, clean the appliance and heat up the oven without food once prior to first use. Ensure that the room is well-ventilated.

### How to proceed ?

- Remove all accessories from the oven.
- Remove any labels and protective foils from the front of the oven.
- Set the function selector to fan oven  and the temperature control to 270°C.
- Heat the oven for an hour to dispel the odour from the insulation.

The cooking mode, time and temperature shown in the cooking guides are designed especially for your oven. For best results, follow the guides.

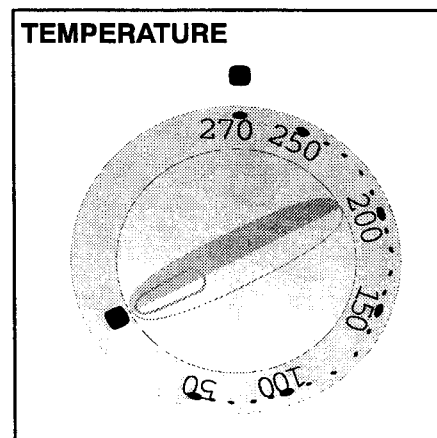
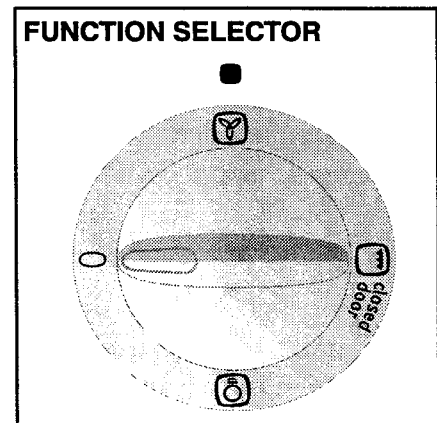

## THE COUNTDOWN (MINUTE MINDER)

This minute minder stops the oven automatically and an audible signal sounds when the time selected at the beginning of cooking has elapsed (maximum 120 minutes).

### 👉 How to proceed ?

- Turn the temperature control and function selector to the desired position depending upon the cooking required.
- Turn the countdown control knob clockwise to indicate the cooking time.
- At the end of cooking, return the countdown control knob to manual position 🖐️ and set the temperature control and function selector to the **Off** position (temperature control to ■ then the function selector to 0).

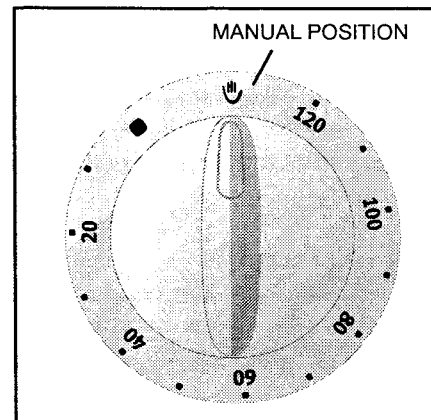

When using your oven without countdown ensure the countdown control knob is in the manual position 🖐️



# OVEN CONTROLS

## The function selector

To obtain the desired cooking mode, turn the function selector :

- Oven light 
- Fan oven 
- Grill 

Once a function has been selected, an appropriate temperature must be set for the oven to heat up.

To stop the oven turn the temperature control to  and then the function selector to **0**.

The oven light comes on as soon as the function selector is turned. The light remains on during cooking.

## The temperature control

The temperature is selected by turning the temperature control knob clockwise. The knob is graduated from 50°C to 270°C.

**Important : the oven will not operate unless the minute minder control knob is in the manual position .**

## The neon indicator lights

### Oven on

The indicator light comes on when the appliance is switched on, and goes out when the function selector is in the Off position (**0**).

### Temperature

The indicator light comes on while the oven is pre-heating and goes out when the required temperature is reached. It switches on and off during cooking to indicate that the temperature is being maintained.

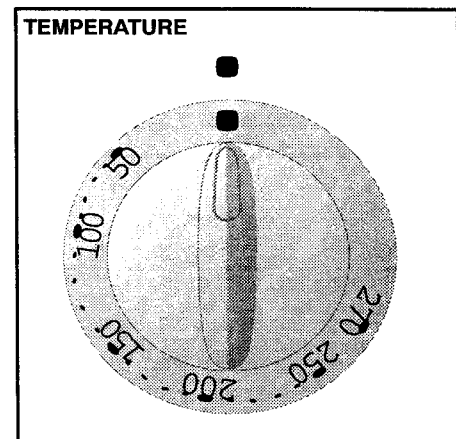
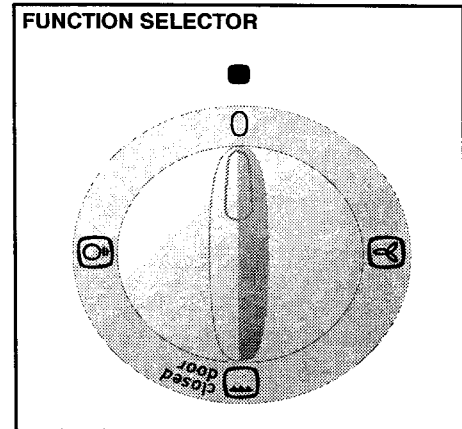

After use ensure the knobs are in Off-position (temperature control to  and function selector to **0**).

## THE OVEN CAVITY

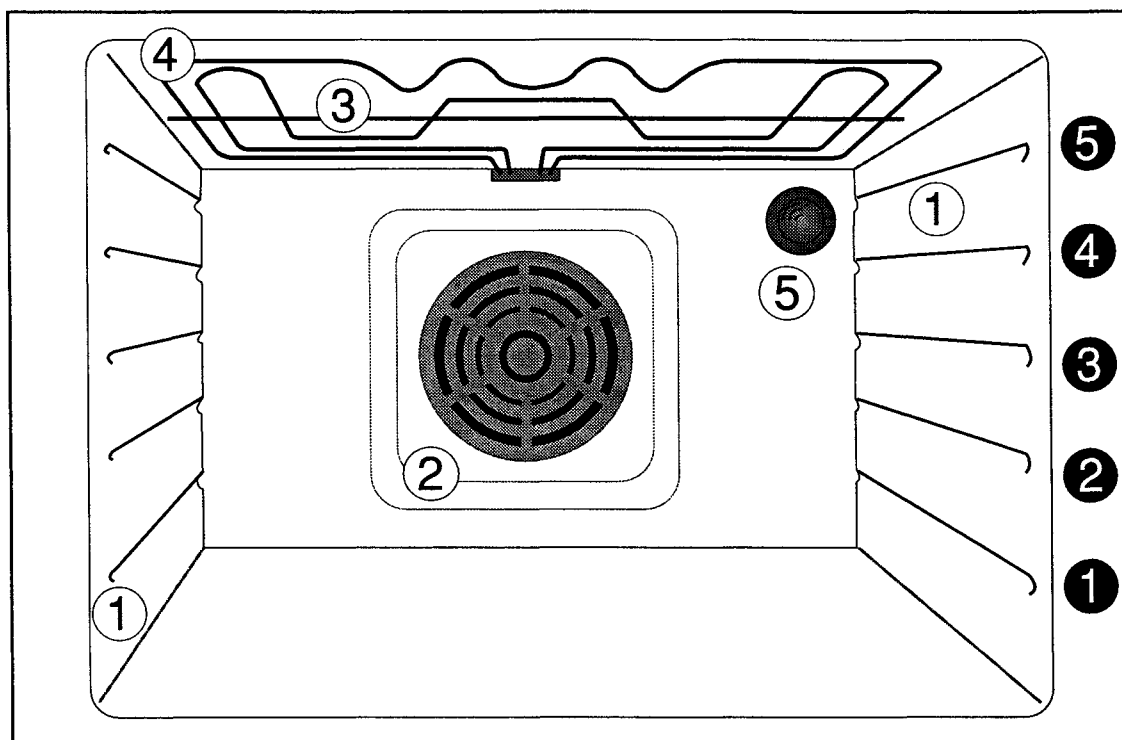

① Shelf runners

② Fan

③ Roof

④ Grill elements

⑤ Oven light

① to ⑤ Cooking levels

## Oven accessories



In addition to the accessories supplied with your oven, use only ovenware that is ovenproof to very high temperatures (follow manufacturers' instructions).

Your oven is equipped with :

- 2 anti-tip wire shelves
- 1 grill pan

### The anti-tip wire shelves

The wire shelves should be fitted with the **forms towards the back of the oven and low side up**. If not fitted correctly the safety stop mechanism will be affected.

### The grill pan

The grill pan is supplied with 1 grid and 2 handles.

### The cooking levels

The oven has five cooking levels which are counted from 1 to 5 (from the bottom upwards).

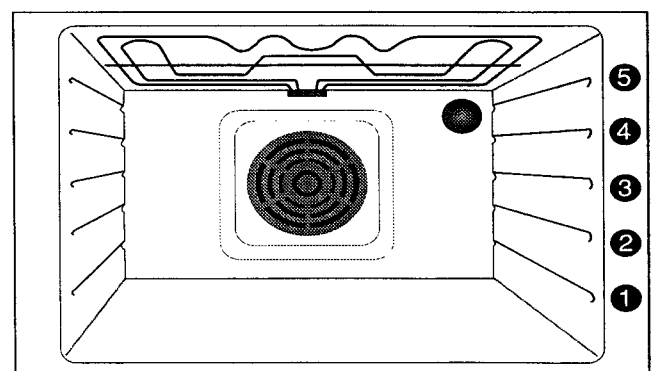
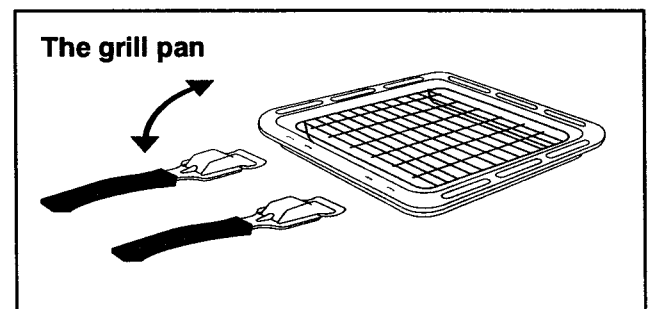
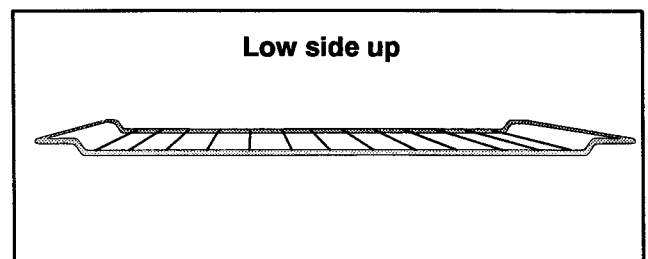
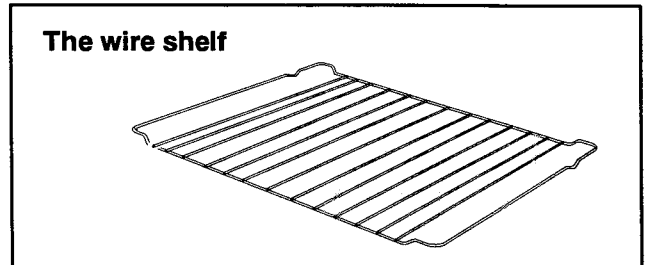

## THE DIFFERENT COOKING SETTINGS

Turn the control either clockwise or anti-clockwise to select the cooking function.

### Fan oven

The air inside the oven is heated by the element around the fan situated behind the back panel. The fan circulates hot air to maintain an even temperature inside the oven. Select any temperature between 50°C and 250°C.

### Grill

For grilling meat, toasting or browning dishes.

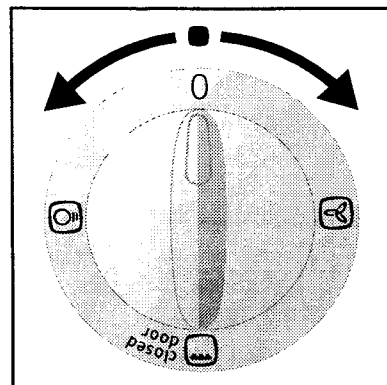

## COOKING FUNCTIONS

### Fan oven

Dishes can be cooked on **one or several levels** using the fan oven. The circulation of hot air produces an even cooking temperature. Fan oven cooking is ideal for all types of dishes.

#### The advantages of fan oven

##### Faster preheating :

- As the fan oven quickly reaches temperature, it is not usually necessary to preheat the oven although you may find that you need to allow an extra 5-7 minutes on cooking times.

##### Lower temperatures :

- Fan oven cooking generally requires lower temperature than conventional cooking. Follow the temperatures recommended in the charts or remember to reduce temperatures by about 20-25° C for your own recipes which use conventional cooking.

##### Even heating for baking :

- The fan oven has uniform heating on all runner positions. This means that batches of the same food can be cooked in the oven at the same time. However, the top shelf may brown slightly quicker than the lower one. This is quite usual. There is no mixing of flavours between dishes.

#### Cooking frozen dishes

- With fan oven cooking, you can put frozen food (ready-cooked food, meat, chicken) straight into the oven **without thawing**. There is no need to preheat the oven in this case : simply reduce the temperature slightly at the start of cooking.

With commercial frozen foods, refer to the cooking instructions for conventional oven cooking on the packaging.

#### How to proceed ?

1. Turn the function selector to  and then the temperature control on the required temperature.

Refer to cooking guides.

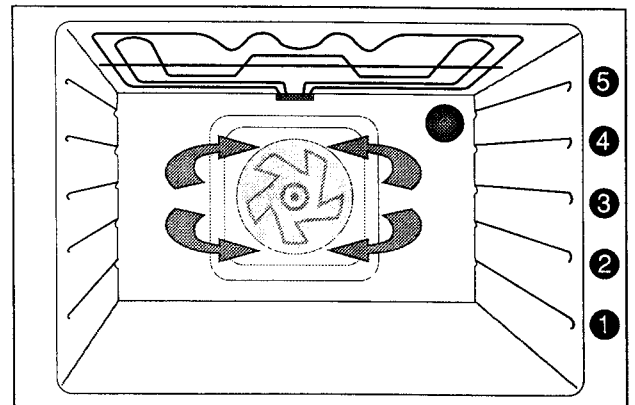

## Cooking the same type of food on two levels

### Which accessories to use ?

In most cases, use wire shelves on runners ① and ③.

See cooking charts.

## Cooking different types of dishes on two levels

The multi-level position makes it possible for you to cook a complete meal at once. To do so, be guided by the following recommendations :

- The various dishes should require similar temperatures.
- Overall cooking time should be the longest cooking required.
- Different dishes may be placed inside or removed from the oven at different times. This depends on the cooking time required for each of them, and possibly on the order in which they are to be served.
- Take care not to open the oven door while another dish could suffer (for instance, a cake starting rising).
- Remember that certain dishes rise in cooking, so leave enough space between shelves.
- Meat and poultry should preferably be placed on shelf ① so as not to spatter other dishes.

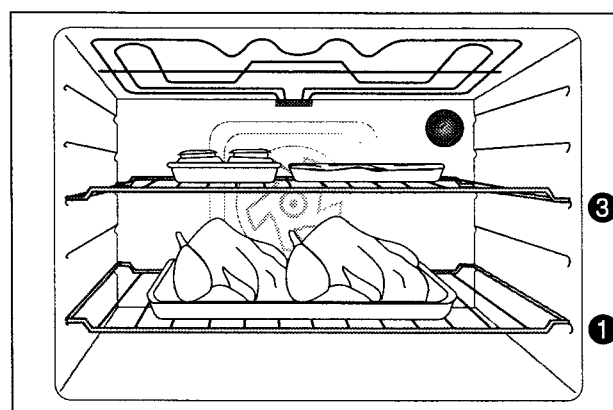
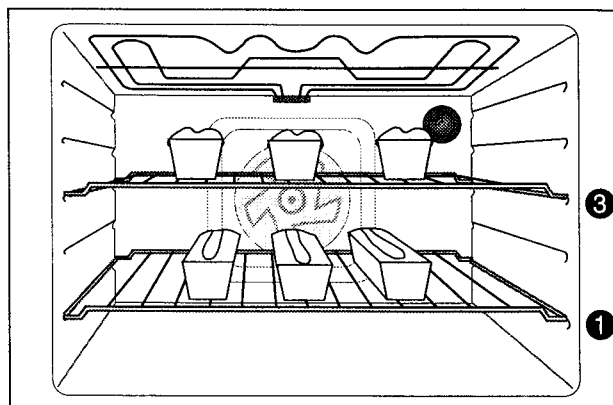



## Defrosting

The fan oven operates without heat and circulates the air, at room temperature, inside the oven. This increases the speed of defrosting. However, please note that the temperature of the kitchen will influence the speed of defrosting.

This function is particularly suitable for delicate food which could be damaged by heat, e.g. cream filled gateaux, iced cakes, pastries, bread and other yeast products.

## How to proceed ?

- Turn the oven function selector to .
- Ensure the temperature control knob is in the Off position .

## Hints and tips

- Cover food with a lid, aluminium foil or plastic film to prevent drying out during defrosting.
- **ALWAYS COOK THOROUGHLY IMMEDIATELY AFTER THAWING.**
- Frozen food should be placed in a single layer when ever possible and turned over half way through the defrosting process.
- Only joints of meat and poultry up to 2 kg (4 lb.) are suitable for defrosting in this way.

## Grill

 Use the grill with the oven door closed to prevent damage to the control panel.

**Never leave the grill unattended when cooking.**

**Preheat for 3 to 5 minutes.**

This cooking mode is ideal for cuts of meat (pork chops, sausages,...) which stay tender and juicy, for toasting or for browning toppings on prepared dishes, preferably hot (e.g. macaroni dishes).

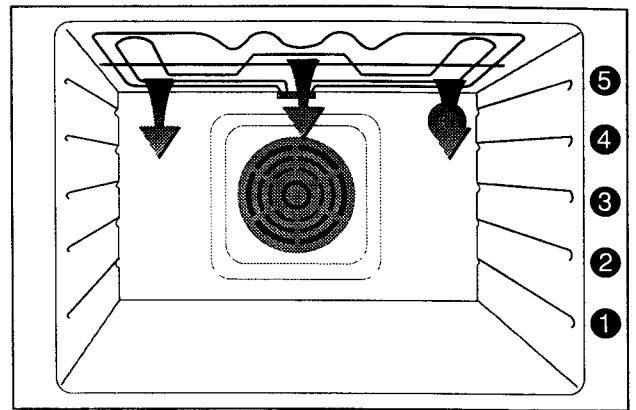

## How to proceed ?

### Grilling

- Prepare the food to be grilled.
- Set the function selector to  and then the temperature control to the required temperature (see cooking guides).

When grill element has become red :

- Put the grill pan on the shelf. Use level shelf ③ or ④ depending on the thickness of the food being grilled.
- When one side is browned, turn the meat over without piercing it to avoid losing juices. For poultry and sausages, piercing before cooking is recommended.
- Cook the other side.
- Season when cooking has finished.

Cooking time depends on the thickness of the meat and not on its weight.

### Browning toppings



- Set the function selector to  and then the temperature control to the required temperature (see cooking guide).
- Place the dish containing the food on the shelf. The closer the food is to grill element the faster the browning will occur.
- Leave the dish under the grill for a few minutes until the food is bubbling and browned.

# HINTS FOR SUCCESSFUL COOKING

## Choice of ovenware

The thickness, conductivity and colour of ovenware affect the cooking results.

- A) Aluminium, earthenware, oven glassware and aluminium with a non-stick interior **reduce** cooking and underneath browning. These materials are recommended for light, soft textured cakes and roasts.
- B) Enamelled cast iron, anodized aluminium, zinc-plated iron, porcelain, aluminium with a non-stick interior and coloured exterior **increase** cooking and underneath browning. These materials are recommended in particular for tarts, quiches and crispy baking that should be browned beneath as well as on top.

If you see	What to do ?
<p>Top too dark Bottom too light not cooked enough</p> 	<p>Use a tin or dish type <b>B</b> or place in lower runner</p>
<p>Top too light Bottom too dark overcooked</p> 	<p>Use a tin or dish type <b>A</b> or place in higher runner</p>

During cooking, certain dishes increase in volume, so remember to choose a container big enough : ideally, the uncooked dish should take up only two thirds of the container, leaving the upper third free for expansion.

To avoid excessive spitting, use high-sided dishes for roasting meat and poultry, or ovenproof glass roasting trays with a lid, appropriate to the size of the joint.

## Condensation and steam

When food is heated it produces steam in the same way as a boiling kettle. The oven is vented to allow some of this steam to escape. However, always stand back from the oven when opening the door to allow any build up of steam or heat to release.

If the steam comes into contact with a cool surface on the outside of the oven, e.g. a trim, it will condense and

produce water droplets. This is quite normal and is not caused by a fault on the oven.

To prevent discolouration, regularly wipe away condensation and also soilage from surfaces.

## Practical tips

- To help keep the oven clean, a baking sheet can be placed on the shelf under the container to protect the base from spillage.
- Pierce the skin of poultry or sausages with a fork before cooking, to avoid the skin swelling and bursting with the heat.
- Leave as little fat as possible around joints of meat to avoid spitting and reduce the fat content.
- For tender joints of meat, turn halfway through cooking and add a little hot water to the dish to produce a tasty gravy and reduce spitting onto the walls of the oven.
- Do not exceed the temperature settings recommended in the cooking guide for meat.

## To save energy

- Cook several dishes one after another, if possible, to save the energy needed to pre-heat the oven each time. Whenever possible, do not hesitate to cook 2 or 3 cakes or tarts, for example, at the same time.



# COOKING GUIDES

Dish	Pre heat	Function selector	Number of levels	Level of cooking (runner)	Shelf position	Temperature selector (°C)	Cook time (minutes)
<b>ROASTING GUIDE : MEAT</b>							
Beef			1	2		150 - 160	20 - 30 per 500 g and 20 - 30 over
Lamb and mutton			1	2		160 - 180	20 - 30 per 500 g and 20 - 30 over
Pork and veal			1	2		160 - 180	20 - 30 per 500 g and 10 - 20 over
Ham			1	2		150 - 170	30 - 40 per 500 g and 30 - 40 over
Chicken			1	2		150 - 170	15 - 20 per 500 g and 20 over
Turkey and Goose			1	1		150 - 170	15 - 20 per 500 g up to 3,5 kg then 10 min per 500g
Duck			1	2		150 - 170	20 - 30 per 500 g and 20 - 30 over
Pheasant			1	2		160 - 180	35 - 40 per 500 g and 35 - 40 over
Rabbit			1	2		160 - 180	35 - 40 per 500 g and 35 - 40 over
Potatoes with or without meat			1	2		160 - 180	according to size
<b>BAKING GUIDE</b>							
Fish			1	2 or 3		160 - 170	30 - 40
Fish fillets			1	2 or 3		160 - 170	15 - 30
Fish pie (potato topped)			1	2 or 3		170 - 180	10 - 15
Pasta, lasagne			1	2 or 3		160 - 180	40 - 50
Baked jacket potatoes			1	3		180 - 190	60 - 90
			2	4 and 2		180 - 190	60 - 90
Roast potatoes			1	3		180 - 190	75 - 90
			2	4 and 2		180 - 190	75 - 90
Stuffed tomatoes			1	3		180 - 190	15 - 20
			2	4 and 2		180 - 190	15 - 20
Yorkshire puddings large			1	2 or 3		180 - 200	10
individuals			1	2 or 3		180 - 200	15 - 20
Biscuits			1	3		140 - 150	10 - 20
Bread			2	4 and 1		210 - 220	25 - 30
Bread rolls/buns			1	3		220 - 230	15 - 20
			2	4 and 2		220 - 230	15 - 20
Cakes : Small & Queen			1	3		160 - 170	20 - 30
			2	4 and 2		160 - 170	20 - 30
Sponges			1	2 or 3		150 - 160	20 - 30
			2	4 and 2		150 - 160	20 - 30
Victoria sandwich			1	3		150 - 160	20 - 30

Dish	Pre heat	Function selector	Number of levels	Level of cooking (runner)	Shelf position	Temperature selector (°C)	Cook time (minutes)
			2	3 and 1		150 - 160	20 - 30
Madeira			1	2		140 - 150	20 - 25
Rich fruit			1	1		125 - 135	150 - 180
Christmas			1	1		125 - 135	150 - 180
Gingerbread			1	3		140 - 150	80 - 90
Meringues			1	3		80 - 90	120 - 180
			2	4 and 2		80 - 90	120 - 180
Flapjacks			1	2 or 3		150 - 160	20 - 30
			2	4 and 2		150 - 160	20 - 30
Shortbread			1	2 or 3		140 - 150	15 - 45
			2	4 and 2		140 - 150	15 - 45

## Cooking guide with grilling

Use the grill with the oven door closed and never leave unattended when cooking.

Dish	Pre heat	Function selector	Number of levels	Level of cooking (runner)	Shelf position	Temperature selector (°C)	Cook time (minutes)
<b>GRILLING 3 minutes of preheating</b>							
Bacon rashers			1	5		250	5 - 6
Beefburgers			1	4		250	15 - 20
Chicken joints			1	4		250	30 - 40
Lamb chops			1	4		270	15 - 20
Pork chops			1	4		270	25 - 30
Fish : Whole trout / Mackerel			1	4		270	10 - 15
Filletts : Plaice / Cod			1	4		270	8 - 12
Kidneys - Lamb / Pig			1	4		250	8 - 12
Liver : Lamb / Pig			1	4		250	10 - 20
Sausages			1	5		250	15 - 25
Rare steaks			1	5		270	8 - 10
Medium steaks			1	4		270	12 - 16
Well done steaks			1	4		270	14 - 20
Toasted sandwiches			1	4		250	3 - 5

**Only your experience will enable you to determine the proper settings for your personal cooking needs. The temperatures are intended as a guide only. It may be necessary to increase or decrease the temperature to suit individual requirements.**

## CLEANING AND CARE



**No heating element must be switched on during the cleaning procedure. Make sure that the oven has cooled down in a way that one may get in touch with interior parts without any danger. Only the function selector may be switched on for oven lighting.**

**Steam and high pressure cleaning units are not suitable for cleaning because of the requirements of electrical safety.**

### Cleaning materials

Before using any cleaning materials on your oven, check that they are suitable and that their use is recommended by the manufacturer.

Cleaners that contain bleach should not be used as they may dull the surface finishes. Harsh abrasives should also be avoided.

### Clean enamelled cavity

The enamelled oven base is best cleaned whilst the oven is still warm.

Wipe the oven over with a soft cloth soaked in warm soapy water after each use. From time to time it may be necessary to do a more thorough cleaning, using a proprietary cleaner.

If the soilage has become set, after the oven has cooled down, the following process will help to soften the splatters to help make cleaning easier :

1. To preheat the oven set the function selector to fan oven  and the temperature control to 50°C for 5 minutes.
2. Heat up water in a saucepan on your hob and remove before boiling.
3. Fill the grill pan to about 12 mm with heated water and add a few drops of washing-up liquid.
4. Place the grill pan on the oven shelf positioned in the lowest runner. Close the oven door.
5. After 15 minutes, turn off the temperature control and allow the fan oven to continue without heat for a further 5 minutes, when the temperature of the water will have cooled down.
6. Carefully remove the grill pan from the oven and use normal oven cleaners to clean away soil residues.
7. Leave a little of soapy water to soak into any burned on spillage on the floor of the oven for a longer time if necessary.

### Cleaning the oven roof

This oven has been fitted with a hinged grill element to enable you to clean the roof of the oven more easily.

Position both thumbs to the left and right on the outside oven frame. With your fingers grip in the front bend of the heating element and draw it off its mounting to the front. The element can now be lowered to allow access to the oven roof.

Wipe the oven roof over with a soft cloth soaked in warm soapy water.

After cleaning gently push the element into position and draw in again to clip the element into the mounting.



**We recommend the interior of the oven is cleaned after every use, as a build up of fats and grease can be a fire hazard.**

From time to time it may be necessary to carry out a more thorough cleaning, using a proprietary oven cleaner.

### Wire shelves, grill pan and shelf runners

Oven accessories should be cleaned with hot soapy water.

### External cleaning

Regularly wipe over the control panel, oven door and door seal using a soft cloth well wrung out in warm water to which a little liquid detergent has been added.



To prevent damaging or weakening the door glass panels avoid the use of the following :

- Household detergent and bleaches.
- Impregnated pads unsuitable for non-stick saucepans.
- Brillo/Ajax pads or steel wool pads.
- Chemical oven pads or aerosols.
- Rust removers.
- Bath/Sink stain removers.

Clean the outer and inner door glass using warm soapy water. Should the inner door glass become heavily soiled it is recommended that a cleaning product such as Hob Brite is used.

### Removal and installation of the runners

For easier cleaning you may remove the entire shelving parts from the oven inside.

For this purpose slightly lift the runners in the middle and take them out of the oven.

Re-location in the reverse sequence : insert the hook and firmly press down.

## REPLACING THE OVEN LIGHT



Ensure the oven is disconnected from the electrical supply before changing the bulb.

The 25 W - E14 (230/240 V) screw-in bulb is **special "heat-resistant" bulb** capable of withstanding temperatures up to 300°C. Replacement bulbs are available through your local Service Centre.

The bulb is located at the back innerside of the oven and can be reached from inside the oven.

### To replace the bulb :

1. Unscrew the bulb protecting cap (turn anti-clockwise).
2. Unscrew the bulb anti-clockwise.
3. Screw in a new bulb.
4. Screw in the bulb protecting cap carefully.

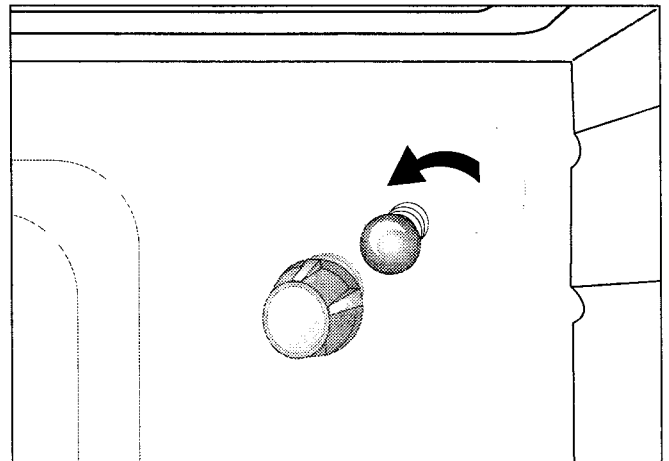

## IF SOMETHING DOESN'T WORK ?

Please carry out the following checks on your appliance before calling a service Engineer. It may be that the problem is a simple one, which you can solve yourself without the expense of a service call.



If the oven shows any sign of a fault, we recommend you do not use it. Disconnect the oven from the mains or remove the fuse on the appropriate circuit.

PROBLEM	POSSIBLE CAUSES	WHAT TO DO ?
<ul style="list-style-type: none"> <li>The oven does not work.</li> </ul>	<ul style="list-style-type: none"> <li>The oven is not wired in or switched on at the wall.</li> <li>There is a power failure.</li> <li>An automatic cooking program has been set.</li> </ul>	<ul style="list-style-type: none"> <li>Switch on at the wall.</li> <li>Check power supply and fuse.</li> </ul>
<ul style="list-style-type: none"> <li>The results of cooking are unsatisfactory.</li> </ul>	<ul style="list-style-type: none"> <li>Insufficient preheating.</li> <li>Temperature is too high or too low.</li> <li>Wrong shelf position.</li> <li>Wrong type of dish.</li> <li>Temperature is incorrectly set.</li> <li>Cooking time is incorrect.</li> <li>Cooking function selector is wrongly positioned.</li> <li>The shelf or oven dish are not in the centre of the oven.</li> </ul>	<ul style="list-style-type: none"> <li>Consult cooking guides.</li> <li>Centre the shelf or oven dish in the oven.</li> </ul>
<ul style="list-style-type: none"> <li>The oven smokes.</li> </ul>	<ul style="list-style-type: none"> <li>The oven is dirty.</li> <li>Food has spilled over.</li> <li>Food (meat) is spitting excessively.</li> </ul>	<ul style="list-style-type: none"> <li>Clean the oven once cooking is finished (see section on cleaning).</li> <li>Use a larger dish.</li> <li>Reduce temperature setting.</li> </ul>
<ul style="list-style-type: none"> <li>Steam and condensation settle on the food and the oven cavity.</li> </ul>	<ul style="list-style-type: none"> <li>The dish has been left inside the oven too long.</li> </ul>	<ul style="list-style-type: none"> <li>Leave dishes inside the oven no longer than 15-20 minutes after the cooking is completed.</li> </ul>

If the problem still persists after these checks, contact ELECTROLUX Service Force Centre.

In-guarantee customers should ensure that the above checks have been made as the engineer will make a charge if the fault is not a mechanical or electrical breakdown.

Please note that it will be necessary to provide proof of purchase for any in-guarantee service calls.

## **SERVICE AND SPARE PARTS**

If you require an engineer or wish to purchase spare parts, contact your local ELECTROLUX Service Force Centre by telephoning :

**0990 929929**

Your call will be routed to the Service Centre covering your post code area. Addresses of ELECTROLUX Service Force Centres can be found on the pages headed ELECTROLUX SERVICE FORCE.

When you contact Service Force they will need the following information :

1. Your name, address and post code,
2. Your telephone number,
3. Clear and concise details of the fault,
4. The model and serial number (which can be found on the rating plate),
5. The date of purchase.

### **Customer Care**

For general enquiries regarding your appliance or for further information on ELECTROLUX products, contact our Customer Care Department :

**ELECTROLUX Customer Care Department**

P.O. Box 47  
NEWBURY  
Berkshire  
RG14 5XL

**Tel : 01635 522 799**

# GUARANTEE CONDITIONS

## ELECTROLUX GUARANTEE CONDITIONS

We, ELECTROLUX, undertake that if, within 12 months of the date of purchase, this ELECTROLUX appliance or any part thereof is proved to be defective by any reason only of faulty workmanship or materials, we will, at our option, repair or replace the same FREE OF ANY CHARGE for labour, materials or carriage on condition that :

- The appliance has been correctly installed and used only on the electricity supply stated on the rating plate.
- The appliance has been used for normal domestic purposes only, and in accordance with the manufacturer's instructions.
- The appliance has not been serviced, maintained, repaired, taken apart or tampered with by any person not authorised by us.
- All service work under this guarantee must be undertaken by an ELECTROLUX Service Force Centre.
- Any appliance or defective part replaced shall become the Company's property.
- This guarantee is in addition to your statutory and other legal rights.
- The guarantee is for the same period and to the same extent for labour and parts as exist in the new country of use for this brand or range of products.
- This guarantee relates to you and cannot be transferred to another user.
- Your new home is within the European Community (EC) or European Free Trade Area.
- The product is installed and used in accordance with our instructions and is only used domestically, i.e. a normal household.
- The electricity supply complies with the specifications given on the rating plate.
- The product is installed taking into account regulations in your new country.

Home visits are made between **8.30am** and **5.30pm** Monday to Friday. Visits may be available outside these hours, in which case a **premium** will be charged.

## Exclusions

### This guarantee does not cover :

- Damage or calls resulting from transportation, improper use or neglect, the replacement of any light bulb or removable parts of glass or plastic.
- Costs incurred for calls to put right an appliance which is improperly installed or calls to appliances outside the United Kingdom.
- Appliances found to be in use within a commercial or similar environment, plus those which are the subject to rental agreements.
- Products of ELECTROLUX manufacture which are not marketed by ELECTROLUX.

## European Guarantee

If you should move to another country within EUROPE then your guarantee moves with you to your new home subject to the following qualifications :

- The guarantee starts from the date you first purchased your product.

Before you move, please contact your nearest Customer Care Centre, listed below, to give them details of your new home. They will then ensure that the Local Service Organisation is aware of your move and able to look after you and your appliances.

France	Senlis	+33 (0)3 44 62 22 22
Germany	Nürnberg	+49 (0)911 323 2600
Italy	Pordenone	+39 (0)1678 47053
Sweden	Stockholm	+46 (0)20 78 77 50
UK	Newbury	+44 (0)1635 522799

To contact your local Electrolux Service Centre telephone **0990 929929**

### MIDLANDS

BIRMINGHAM (M18)	66 Birch Road East, Wyrley Road Industrial Estate Witton Birmingham B6 7DB
BOURNE (M44)	Manning Road Ind Estate Pinfold Road Bourne PE10 9HT
BRIDGNORTH (M72)	1 Underhill Street Bridgnorth Salop WV16 4BB
GLOUCESTER (M23)	101 Rycroft Street Gloucester GL1 4NB
HEREFORD (M31)	Unit 3 Bank Buildings Cattle Market Hereford HE4 9HX
HIGHAM FERRERS (M51)	The Old Barn Westfield Terrace Higham Ferrers NN10 8BB
ILKESTON (M43)	Unit 2 Furnace Road Ilkeston DE7 5EP
LEICESTER (M22)	Unit 23-24 Alliance Business Pk Townsend Drive Nuneaton Warwickshire CV11 6RX
LINCOLN (M40)	Unit 8 Stonefield Park Clifton Street Lincoln LN5 8AA
NEWCASTLE UNDER LYME (M12)	18-21 Croft Road Brampton Industrial Estate Newcastle under Lyme Staffordshire ST5 0TW
NUNEATON (M21)	19 Ptarmigan Place Townsend Drive Nuneaton CV11 6RX
REDDITCH (M20)	Heming Road Washford Redditch Worcestershire B98 0DH
TAMWORTH (M19)	Unit 3 Sterling Park Claymore Tamworth B77 5DO
WORCESTER (M73)	Unit 1 Northbrook Close Gregorys Mill Ind Estate Worcester WR3 8BP

### LONDON & EAST ANGLIA

CANVEY ISLAND	2-4 Sandhurst Kings Road Canvey Island SS8 0QY
CHELMSFORD (M47)	Hanbury Road Widford Ind Estate Chelmsford Essex CM12 3AE
COLINDALE (M53)	UUnit 14 Capital park Capital Way Colindale London NW9 0EQ
ENFIELD (M49)	284 Alma Road Enfield London EN3 7BB
GRAVESEND (M57)	Unit B4, Imperial Business Estate Gravesend Kent DA11 0DL
HARPENDEN (M46)	Unit 4 Riverside Estate Coldharbour Lane Harpenden AL5 4UN
LETCHWORTH (M50)	16-17 Woodside Ind Est. Works Road Letchworth Herts SG6 1LA
LONDON (M76)	66 Paddenswick Road Hammersmith London W6 0UB
MAIDENHEAD (M60)	Reform Road Maidenhead Berkshire SL6 8BY
MOLESEY (M61)	10 Island Farm Avenue West Molesey Surrey KT8 2UZ
NEWBURY (M24)	PO Box 5627 Newbury Berkshire RG14 5GF
IPSWICH (M48)	Unit 2B Elton Park Business Centre Hadleigh Road Ipswich IP2 0DD
NORWICH (M52)	2b Trafalgar Street Norwich NR1 3HN
SUNBURY (M63)	Unit 1a The Summit Hanworth Road Hanworth Ind Estate Sunbury on Thames TW16 5D
SYDENHAM (M62)	Unit 6 Metro Centre Kangley Bridge Road Sydenham SE26

### SOUTH EAST

ASHFORD (M58)	Unit 2 Bridge Road Business Estate Bridge Road Ashford Kent TN2 1BB
FLEET (M59)	Unit 1 Redfields Industrial Estate Church Crookham Fleet Hampshire GU13 0RD
HAYWARDS HEATH (M55)	21-25 Bridge Road Haywards Heath Sussex RH16 1UA
TONBRIDGE (M56)	Unit 30 Deacon Trading Estate Morley Road Tonbridge Kent TN9 1RA

### SOUTH WEST

BARNSTAPLE (M30)	P.O. Box 12 Barnstaple North Devon EX31 2YB
BOURNEMOUTH (M26)	63-65 Curzon Road Bournemouth Dorset BH1 4PW
BRIDGEWATER (M35)	6 Hamp Industrial Estate Bridgewater Somerset TA6 3NT
BRISTOL (M25)	11 Eldon Way Eldonwall Trading Bristol Avon BS4 3QQ
EMSWORTH (M33)	266 Main Road Southbourne Emsworth PO10 8JL
ISLE OF WIGHT (M34)	Unit 8 Enterprise Court Ryde Business Park Ryde Isle of Wight PO33 1DB
NEWTON ABBOT (M29)	Unit 2 Zealley Industrial Estate Kingsteignton Newton Abbot S. Devon TQ12 3TD
PLYMOUTH (M32)	16 Faraday Mill Cattledown Plymouth PL4 0ST
REDRUTH (M36)	Unit 7D Pool Industrial Estate Wilson Way, Redruth, Cornwall TR15 3QW



To contact your local Electrolux Service Centre telephone 0990 929929

### CHANNEL ISLANDS

GUERNSEY	Guernsey Electricity PO Box 4 Vale, Guernsey Channel Islands
JERSEY	Jersey Electricity Company PO Box 45 Queens Road St Helier Jersey Channel Islands JE4 8NY

### SCOTLAND

ABERDEEN (M05)	8 Cornhill Arcade Cornhill Drive Aberdeen AB2 5UT
AUCHTERMUCHY (M03)	33A Burnside Auchtermuchy Fife KY14 7AJ
BLANTYRE (M07)	Unit 5 Block 2 Auchenraith Ind Estate Rosendale Way Blantyre G72 0NJ
DUMFRIES (M01)	93 Irish Street Dumfries Scotland DG1 2PQ
DUNOON (M67)	Briar Hill 7 Hill Street, Dunoon Argyll PA23 7AL
GLASGOW (M04)	20 Cunningham Road Clyde Estate Rutherglen, Glasgow, G73 1PP
INVERNESS (M06)	Unit 3B Smithton Indust. Est. Smithton Inverness IV1 AJ
ISLE OF ARRAN  (OWN SALES)	Arran Domestic Unit 4 The Douglas Centre Brodict Isle of Arran KA27 8AJ
ISLE OF BARRA  (OWN SALES)	J Zerfah 244 Bruernish Isle of Barra Western Islands HS9 5QY
ISLE OF BUTE (M66)	Walker Engineering Glenmhor Upper Serpentine Road Rothesay Isle of Bute PA20 9EH
ISLE OF LEWIS (M69)	ND Macleod 16 James Street Stornoway Isle of Lewis PA87 2QW

SLE OF MULL (M68)	Brian Hogg Braeside Raeric Road Tobermory Isle of Mull PA75 6PU
KELSO (M08)	2-8 Wood Market Kelso Borders TD5 7AX
ORKNEY (M65)	Corsie Domestic 7 King Street Kirkwall Orkney KW15
SHETLAND  (OWN SALES)	Tait Electronic Systems Ltd. Holmsgarth Road Lerwick Shetland ZE1 0PW
SHETLAND  (OWN SALES)	Bolts Shetland Ltd 26 North Road Lerwick Shetland ZE1 0PE
WHALSAY  (OWN SALES)	Leask Electrical Hartsdale Symbister, Whalsay Shetland ZE2 9AA

### NORTHERN IRELAND

BELFAST (M27)	Owenmore House Kilwee Industrial Estate Upper Dunmury Lane Belfast BT17 0HD
------------------	---

### WALES

CARDIFF (M28)	Guardian Industrial Estate Clydesmuir Road Tremorfa, Cardiff CF2 2QS
CLYWD (M14)	Unit 6-7 Coed - Parc Abergele Road Rhuddlan Clwyd Wales LL18 5UG
OSWESTRY (M17)	Plas Funnon Warehouse Middleton Road Oswestry SY11 2PP

### NORTH EAST

GATESHEAD (M39)	Unit 356a Dukesway Court Dukesway Team Valley Gateshead NE11 0BH
GRIMSBY (M42)	Unit 2 Cromwell Road Grimsby South Humberside DN31 2BN
HULL (M41)	Unit 1 Boulevard Industrial Estate Hull HU3 4AY
LEEDS (M37)	64-66 Cross Gates Road Leeds LS15 7NN
NEWTON AYCLIFFE (M45)	Unit 16 Gurney Way Aycliffe Ind Estate Newton Aycliffe DL5 6UJ
SHEFFIELD (M38)	Pennine House Roman Ridge Ind. Roman Ridge Road Sheffield S9 1GB

### NORTH WEST

BIRKENHEAD (M11)	1 Kelvin Park Dock Road Birkenhead L41 1LT
CARLISLE (M10)	Unit 8 South John Street Carlisle CA2 5AJ
ISLE OF MAN (M64)	South Quay Ind Estate Douglas Isle of Man
LIVERPOOL (M15)	Unit 1 Honeys Green Precinct Honeys Green Lane Liverpool L12 9JH
MANCHESTER (M09)	Unit 30, Oakhill Trading Estate Devonshire Road Worsley Manchester M28 3PT
PRESTON (M13)	Unit 250 Dawson Place Walton Summit Bamber Bridge Preston Lancashire PR5 8AL
STOCKPORT (M16)	Unit 20 Haigh Park Haigh Avenue Stockport SK4 1QR

# FOR THE INSTALLER

## Technical information

Oven type .....	See rating plate
Electrical connections .....	230 / 240 V 50 Hz
Required protection fuse for the oven .....	13 Amps

### Oven ratings

Oven .....	Electric
Maximum electrical power .....	3000 W / 3200 W
Oven power .....	2400 W (230 V)
Grilling .....	Electric
Grilling power .....	2900 W (230 V)
Oven lighting .....	25 W (230 V)
Type of cleaning .....	Clean enamel (manual)

### Aperture dimensions of the oven

Height .....	580 mm
Width .....	540 mm
Depth .....	546 mm
Net weight .....	27,0 kg
Internal volume .....	51 l

### Optional extra available from Service Force Centres

As an additional safety feature a cool door kit is available as an optional extra.

Cool door Kit:

Model number : ECD100W1 n° 949918101 (white model)

Model number : ECD100B1 n° 949918201 (brown model)

### The rating plate

The rating plate is situated on the lower front frame of the oven and can be seen upon opening the oven door.

This information (model, product number, serial number) should be quoted in any communication or if the Service Force Centre is contacted.

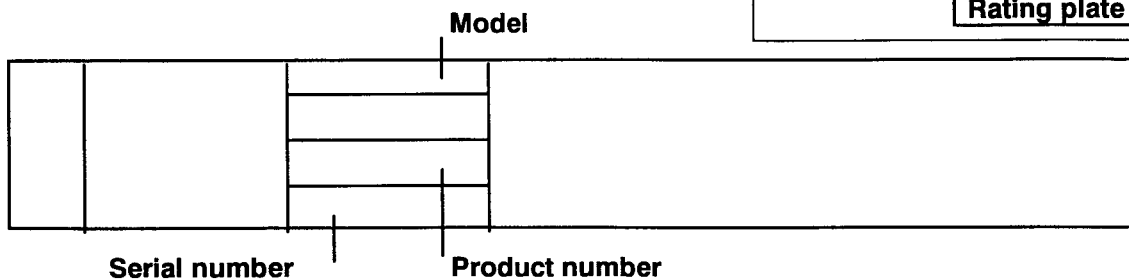
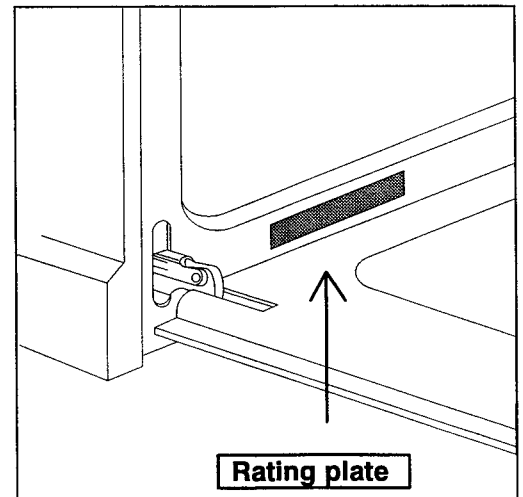

The **CE** mark meets the requirements laid down in directives : electromagnetic compatibility 89/336, **CE** mark 93/68 and low voltage 73/23.

## Fitting the oven into an “in column” or “under counter” cabinet

Please ensure that when the appliance is installed, it is easily accessible for the engineer in the event of a breakdown.

### Building-In :

This appliance is classed as a **type Y** in terms of protection against overheating of surround areas.

The surround or cabinet into which the oven will be built must comply with the following specifications :

- **this oven must be fitted in a closed cabinet to ensure correct air flow for cooling purposes,**
- the dimensions must be as shown in the relevant diagram,
- to avoid overheating a minimum of 5 mm must separate the oven frame from adjacent partitions (doors of furniture, etc...),
- adjacent partitions and their coverings must be capable of resisting a temperature of at least 60°C.

The oven must be correctly installed to ensure electrical safety. During installation and maintenance, the oven must be disconnected from the power supply, and fuses must be removed.

The oven must be installed in a level and stable housing cabinet which must be properly assembled and firmly secured to the wall or floor. The oven is secured to its surrounding unit by two side stability screws. They are supplied in a plastic bag inside the oven.

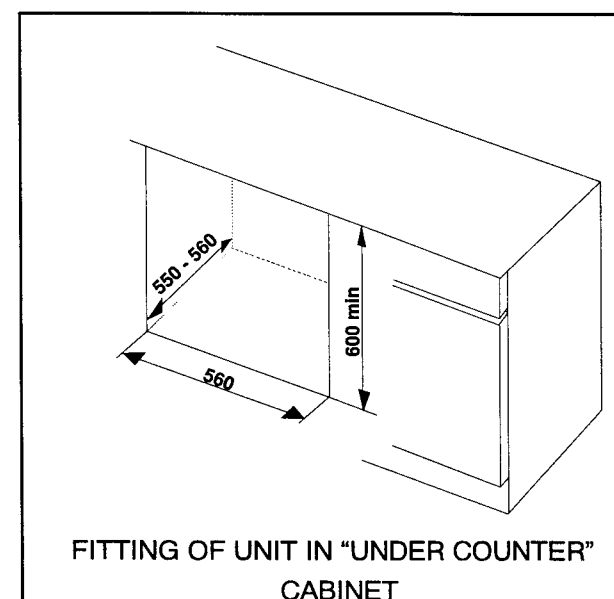
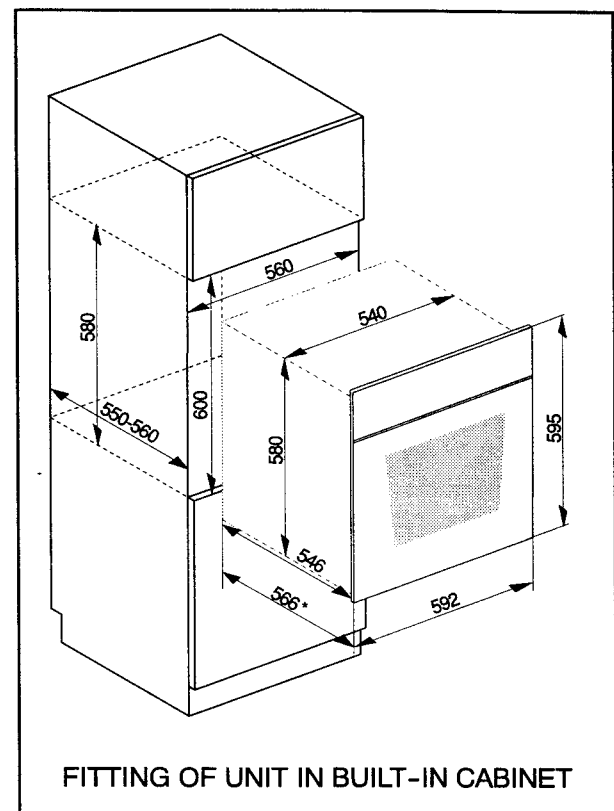
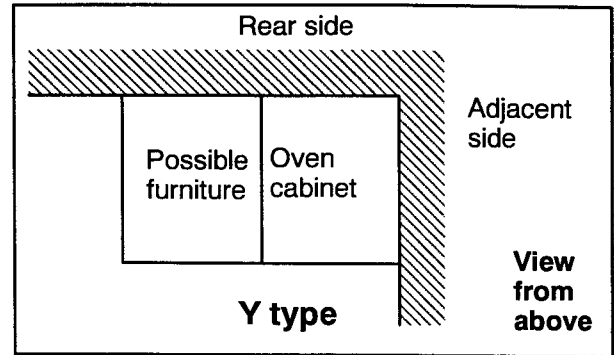

## Electrical connections



**Connecting the appliance to the electricity supply must be carried out by qualified professionals only. The oven must be earthed in accordance with current regulations (Earth = yellow and green).**

### Fuse capacity : 13 Amps

#### Before connecting the oven, check that :

- the electrical wiring is in good condition,
- the fuses and the domestic power supply are of sufficient capacity to support the oven (see rating plate),
- the plug or double pole switch used to connect the oven is accessible once the appliance is installed.

#### Fixed connection :

In the event of a fixed connection, it is necessary that you install a double pole switch between the appliance and the electricity supply (mains), with a minimum gap of 3 mm between the switch contacts and of a type suitable for the required load in compliance with the current rules.

The switch must not break the yellow and green earth cable at any point.

#### Fitting a plug :

If a plug is fitted, the wires in the mains lead are coloured in accordance with the following code :

green and yellow : Earth

blue ..... : Neutral

brown ..... : Live

- The wire coloured green and yellow must be connected to the terminal marked with the letter “E” or by the earth symbol or coloured green and yellow,
- The wire coloured blue must be connected to the terminal “N” or coloured black,
- The wire coloured brown must be connected to the terminal “L” or coloured red,
- Upon completion there must be no cut or stray strands of wire present and the cord clamp must be secure over the outer sheath.

## Connecting cable

Use a H05 RR-F type cable with a minimum cross-section of 2.5 mm<sup>2</sup> or 2.5 mm<sup>2</sup> PVC twin and earth cable .

The cable should be connected according to recommendations and the securing screws should be tight. The protective conduction (Earth cable) should be longer than the wires carrying the current. The power cable should be held firmly in place by the cable clamp.

Whatever method of connection is employed, the appliance must be earthed in accordance with current regulations.

**If the oven is to be connected to an existing cooker control unit, it will be necessary to down rate the protective fuse to 15 amp.**

## Choice of electrical connections

There are two possible ways to connect your cooker, please choose from the most appropriate after reading the descriptions :

- It is recommended that this appliance is wired with suitably rated cable (min 13 A), into fixed wiring using a double pole isolator with at least 3 mm contact separation in all poles and neutral, located within 2 m of the appliance. If this fixed wiring circuit is only supplying the cooker, then a fuse of 13 A (or circuit breaker) should be incorporated. When the circuit combines oven and hob, then wire and fuse rating should be increased accordingly.

Subject to Regional Electricity Company regulations if you wish to connect the oven and hob to the power supply you may use one of the following methods :

- If you wish to connect an oven and a hob to a cooker point you can :
  - by connecting the oven and hob separately to the cooker point. Oven and hob units should be separately connected to a control panel. In this case the cooker should be operated from 6 mm<sup>2</sup> twin core, and earth, PVC insulated multicore cable. See Fig. 1.

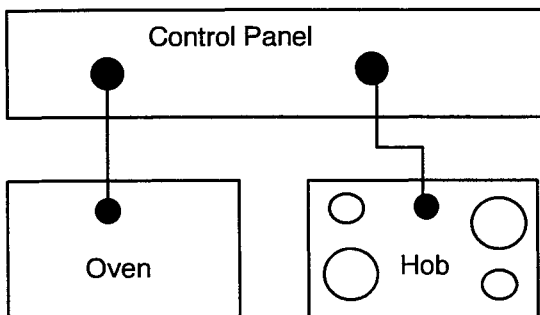
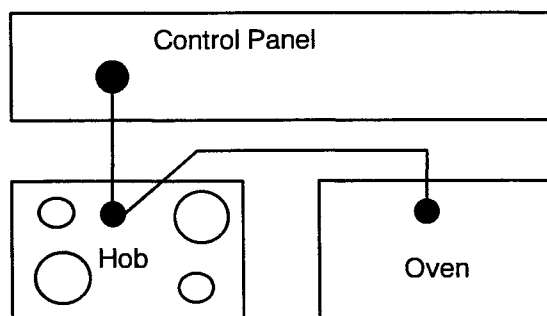

Fig. 1

- by connecting the cooker point to the hob and then connecting the hob to the oven. Provided that the hob manufacturer permits it, connect the oven to the hob and the hob to the cooker point using the same cabling as described above. Check the hob terminal block is large enough to take two cables and is of suitable rating. See Fig. 2.

**NOTE :** 13 amp cable is not suitable for connecting this application.



**Fig. 2**

**NOTE :** it is good practice to :

- fit an Earth Leakage Circuit breaker to your house wiring,
- wire your appliance to the latest IEE regulations.



ELECTROLUX  
PO Box 47  
Newbury  
Berkshire  
RG14 5XL

TEL : 01635 522799

<http://www.electrolux.se>