



user manual

We were thinking of you
when we made this product

GB

Welcome to the world of Electrolux

You've chosen a first class product from Electrolux, which hopefully will provide you with lots of pleasure in the future. Electrolux ambition is to offer a wide variety of quality products that would make your life even more comfortable. You can look at some examples on the cover in this manual. But now it's time to study this manual and start using and enjoying the benefits from your new machine. We promise that it'll make your life a little easier. Good luck!

Contents

Safety information	5
Product description	7
Before using the appliance	8
Operation	10
Programme charts	19
Hints and tips	23
What to do if...	26
Care and cleaning	29
Technical data	34
Installation instructions	35
Connecting to the electricity supply	37
Connecting to the gas supply	38
Environment	40
Guarantee / Customer care	41

The following symbols are used in this user manual:



Important information concerning your personal safety and information on how to avoid damaging the appliance.



General information and tips



Environmental information



Important safety information

These warnings are provided in the interests of your safety. Ensure that you understand them all before installing or using the appliance.

Your safety is of paramount importance. If you are unsure about any of the meanings of these warnings please contact customer care.

Installation

The appliance must be installed according to the instructions supplied. The installation work must be undertaken by a competent person as stated in the Gas Safety (Installation & Use) Regulations current editions and the IEE Wiring Regulations. For appliances installed in the Republic of Ireland please refer to NSAI - Domestic Gas installation IS813 Current Editions.

The appliance should be serviced by an authorised Service Engineer and only genuine approved spare parts should be used.

It is important that the appliance is suitable for your gas supply. Your installer should check the rating plate.

Make sure that a stability chain is fitted.

The appliance must be installed in an adequately ventilated room.

If the appliance is to be placed on a base, measures must be taken to prevent the appliance from slipping from the base.

This appliance is heavy and care must be taken when moving it.

Do not attempt to lift or move this appliance by the handles.

All packaging, both inside and outside the appliance must be removed before the appliance is used.

It is dangerous to alter the specifications or modify the appliance in any way.

Child safety

Do not allow children to play with any part of the packaging.

Do not allow children to sit or climb on the drop down doors.

This appliance is not intended for use by children and other persons whose physical, sensory or mental capabilities or lack of experience and knowledge prevents them from using the appliance safely without supervision or instruction by a responsible person to ensure that they can use the appliance safely.

Children should be supervised to ensure that they do not play with the appliance.



CAUTION: Accessible parts may be hot when the grill is in use. Young children should be kept away.

During use

This appliance is not intended to be operated by means of an external timer or separate remote control system.

This appliance has been designed for domestic use to cook edible foodstuffs only and must not be used for any other purposes.

6 **electrolux** safety information

Take great care when heating fats and oils as they will ignite if they become too hot.

When you are lighting any burner check that it is lit before you leave the appliance. When turning off a burner, do not leave the appliance until the flame has gone out.

Never place plastic or any other material that may melt in or on the oven. Do not leave the grill pan handle in position when grilling as it will become hot.

Always support the grill pan when it is in the withdrawn or partially withdrawn position.

Always use oven gloves to remove and place food in the oven.

Ensure cooking utensils are large enough to contain foods to prevent spillages and boil overs.

During use the appliance becomes hot. Care should be taken to avoid touching the heating elements inside the oven.

Ensure that all vents are not obstructed to ensure ventilation of the oven cavity.

Never line any part of the appliance with foil.

Always stand back from the appliance when opening the oven door to allow any build up of steam or heat to release.



Never leave the appliance unattended when the oven doors are open.

Do not place sealed cans or aerosols inside the oven. They may explode if they are heated.

Ensure that all control knobs are in the OFF position when not in use.

Do not stand on the appliance or on the open oven doors.

Do not hang towels, dishcloths or clothes from the appliance or its handles.

Do not use this appliance if it is in contact with water. Never operate it with wet hands.

Cleaning and maintenance



For hygiene and safety reasons this appliance should be kept clean at all times. A build-up of fat or other foodstuff could result in a fire especially in the grill pan.

Do not leave the cookware containing foodstuff, e.g. fat or oil in the appliance in case it is inadvertently switched on.

Do not disconnect the appliance from the gas supply if the supply pipe does not have a bayonet connection as described in the installation section. If this is the case contact the person who installed the appliance.

Always allow the appliance to cool before switching off at the wall prior to carrying out any cleaning/maintenance work.

Only clean this appliance in accordance with the instructions given in this book.

Never use steam or high-pressure steam cleaners to clean the appliance.

Product description

- 1** Hob
- 2** Control Panel
- 3** Top Oven/Grill
- 4** Main Oven

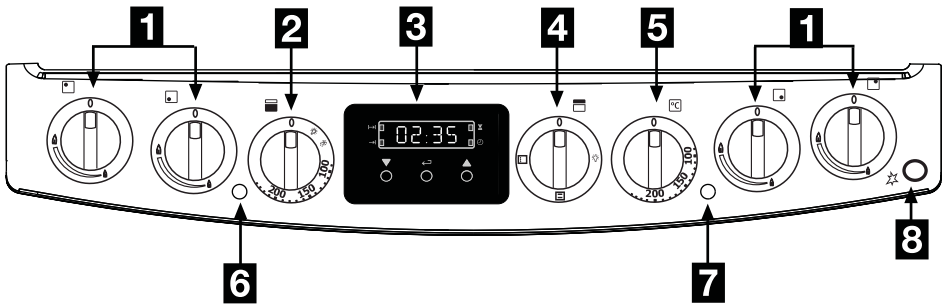
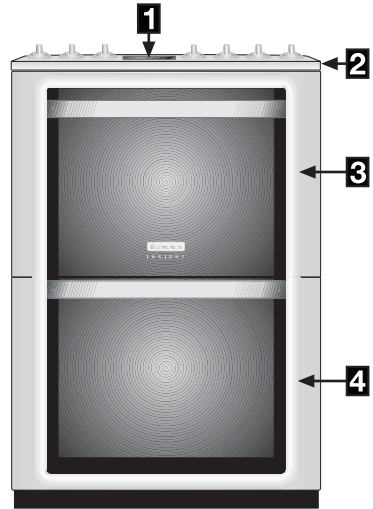

- 1** Hob Control
- 2** Main Oven Temperature Control
- 3** Electronic Timer
- 4** Top Oven/Grill Function Selector Control
- 5** Top Oven/Grill Temperature Control
- 6** Main Oven Indicator Neon
- 7** Top Oven/ Grill Indicator Neon
- 8** Ignition switch

Before using the appliance

Rating plate

This is situated on the lower front frame of the appliance and can be seen upon opening the door. Alternatively the rating plate may also be found on the back or top of some models (where applicable).

The appliance must be protected by a suitably rated fuse or circuit breaker.

The rating of the appliance is given on the rating plate.

Do not remove the rating plate from the appliance as this may invalidate the guarantee.

Preparing to use your appliance

Wipe over the base of the oven(s) with a soft cloth using hot soapy water.

Wash the furniture before use.

We suggest that you run the oven(s) and grill for 10 – 15 minutes at maximum temperature, to burn off any residue from their surfaces. Accessible parts may become hotter than in normal use. Children should be kept away. During this period an odour may be emitted, it is therefore advisable to open a window for ventilation.

The cooling fan for the controls

The cooling fan comes on immediately when the grill/top oven is switched on and after a short time when the main oven is in use. It may run on after the controls are switched off until the appliance has cooled.

During the initial period the cooling fan may turn on and off, this is quite normal.



Always allow the cooling fan to cool the appliance down before switching off at the wall prior to carrying out any cleaning or maintenance work.

Control panel indicator neon(s)

The indicator neon will operate when the grill (where applicable) or oven(s) is switched on. The indicator neon will glow. It may turn on and off during use to show that the setting is being maintained. If the neon does not operate as the instructions indicate the controls have been incorrectly set. Return all controls to zero and reset following the instructions for the required setting.

Condensation and steam

When food is heated it produces steam similar to a boiling kettle. The vents allow some of this steam to escape. However, always stand back from the appliance when opening the door(s) to allow any build up of steam or heat to release.

If the steam comes into contact with a cool surface on the outside of the appliance, e.g. a trim, it will condense and produce water droplets. This is quite normal and is not caused by a fault on the appliance.

To prevent discolouration, regularly wipe away condensation and foodstuff from surfaces.

For your safety wall coverings at the rear of the appliance should be securely fixed to the wall.

Cookware

Baking trays, dishes etc., should not be placed directly against the grid covering the fan at the back of the oven.

Do not use baking trays larger than 30cm x 35cm (12" x 14") as they will restrict the circulation of heat and may affect performance.

Grill and oven furniture

The following items of grill and oven furniture have been supplied with the appliance. If you require replacements of any of the items listed below please contact your local service force centre.

1 grill pan

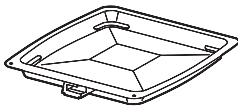

1 grill pan handle

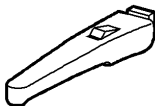

1 grill pan grid

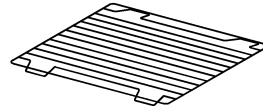

1 cranked shelf (For grilling and top oven cooking)

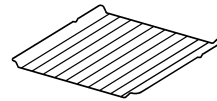

2 cranked shelves (For main oven cooking)

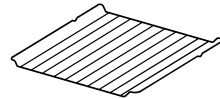
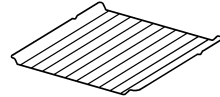

The timer

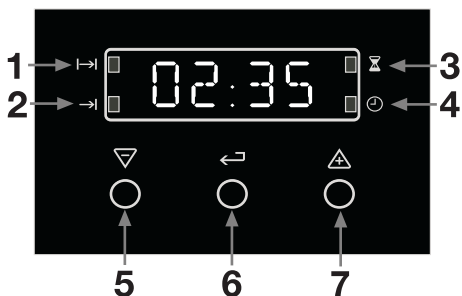

Key



1. Cook time indicator neon
2. End time indicator neon
3. Countdown indicator neon
4. Time indicator neon
5. Decrease control
6. Selector control
7. Increase control



The time of day must be set before the main oven will operate manually.

To set the time of day

The oven has a 24 hour clock. When the electricity supply is first switched on, the display will show 12:00 and the 'Time' indicator neon  will flash.

To set the correct time press the increase control button  and if necessary, the decrease control button  until the correct time on the 24 hour clock is reached. The 'Time' indicator neon  will flash for 5 seconds and then go out.







The increase and decrease control buttons operate slowly at first, and then more rapidly. They should be pressed separately.

To set the countdown

The 'Countdown' gives an audible reminder at the end of any period of cooking.

This cooking period may be up to 2 hrs 30 mins. It is not part of the automatic control.

To set, press the Selector Control button  until the 'Countdown' indicator neon  is illuminated and the display reads 0:00.





To set the required time duration, press the increase control  until the display indicates the interval to be timed. If necessary press the decrease control  to achieve the correct time interval.



This must be completed within 5 seconds of first pressing the Selector Control button.

During the operation of the 'Countdown', the remaining time period will be shown in the display. The 'Countdown' will sound intermittently for up to 2 minutes at the end of the timed period. The sound can be stopped by pressing any button.

To cancel the countdown





If you change your mind and want to cancel the 'Countdown', press the Selector Control button  until the 'Countdown' indicator neon  flashes then depress the decrease control  until  shows in the display. The 'Countdown' indicator neon  will continue to flash for a few seconds and then return to the time of day.

To set the oven timer control

Only the main oven can be automatically timed.

When using the timer control for the very first time, it is advisable to let it operate while you are at home. The display can be checked to show that it is operating correctly and you will feel confident to leave a meal to cook automatically in the future.







To set the timer to switch on and off automatically

1. Ensure the electricity supply is switched on and that the correct time of day is displayed.
2. Place food in oven.
3. To set the length of cooking time. Press the Selector Control button  until the 'Cook Time' indicator neon  is illuminated.
4. Press the increase control  until the required length of cooking time is displayed. If necessary press the decrease control  until the correct time interval is achieved. The maximum cooking time is 10 hours.

5. Release the buttons. The 'Cook Time' indicator neon  will be illuminated.



Remember, this must be completed within 5 seconds of first pressing the Selector Control button.







6. To set the 'End Time'. Press the Selector Control button  until the 'End Time' indicator neon  flashes. Press the increase control button  until the required stop time is displayed. If necessary press the decrease control  until the required time interval is achieved.
7. Release the buttons. The time of day will be displayed after 5 seconds. The 'Cook Time'  and 'End Time'  indicator neons will be illuminated.
8. Set the main oven control to the required temperature. The oven indicator neon should be off.







When the automatic timed period starts, the oven indicator neon will turn on and off periodically during cooking, showing that the temperature is being maintained.

12 electrolux operation

To set the timer to switch off only

1. Ensure the electricity supply is switched on and that the correct time of day is displayed.
2. Place food in the oven.
3. To set the length of cooking time, press the Selector Control button  until the 'Cook Time' indicator neon  is illuminated. Press the increase control  until the required length of cooking time is displayed. Press the decrease control  if necessary.
4. Release the buttons. The 'Cook Time' indicator neon  will illuminate and the time of day will be displayed after 5 seconds.
5. Set the oven temperature. The oven indicator neon should be on.
6. To check the 'End Time' during the cooking period, simply press the Selector Control button  once and the remaining time will be displayed.

To cancel an automatic programme

1. To cancel an automatic programme press the Selector Control button  until the 'Cook Time' indicator neon  flashes. Press the decrease control  until the display reads 000.
2. Release the buttons. The 'Cook Time' indicator neon  will flash and after 5 seconds return to the time of day.
3. Turn off the oven controls.

To return the appliance to manual

At the end of a timed cooking period, the 'End Time' indicator neon  will flash and an alarm will sound for up to 2 minutes.

1. To stop the sound, press any of the three buttons.
2. The display will return to the time of day.
3. Turn off the oven controls.

Things to note

In the event of an interruption of the electricity supply, the timer will reset it self and all programming will be cancelled.

Your timer has an energy save mode which allows you to switch the display off. For setting details please refer to the environmental chapter of this manual.

Automatic cooking

It is advisable to leave food in the oven for as short a time as possible before automatic cooking. Always ensure commercially prepared food is well within its use by date and that home prepared food is fresh and of good quality.

When cooking is complete, **do not** leave food to stand in the oven, but remove and cool it quickly if the food is not to be consumed immediately.

Always ensure food in the oven has been covered before cooking if it is not possible to remove food immediately after cooking.

The gas hob

The gas hob has different burner sizes to suit different types of cooking:

To ensure maximum burner efficiency only use pots and pans with flat bases appropriate to the burner size used.

Larger burner (Rapid or triple crown where applicable) - use a large pan for food such as chips.

Medium burners (Normal) - use for everyday cooking.

Small burner (Simmer) - use for simmering foods such as soups and stews.

The largest pan which you should use on any burner is 230mm (9"). The base of the smallest pan should not measure less than 100mm (4").



Ensure the pan supports are correctly fitted before using the hob.

To light the hob burners

The hob ignition works by means of an electric spark system.

- Lift up the lid. You cannot use the hob when the lid is down.
- Push in and hold the control knob, turn to the large flame symbol .
- Press the ignition button immediately. Keep the control knob depressed for up to 5 seconds, but no longer than 10 seconds. After this time release the controls. The flame should remain alight. If after 10 seconds

the burner has not lit, stop operating the appliance and wait at least 1 min before attempting a further ignition of the burner.

- When the burner has lit release the control and ignition button, adjust the setting as required.



Warning: If the ignition button is not pressed immediately a build up of gas may cause the flame to spread.



When lighting any burner, ensure that it is lit before you leave the appliance.



If you close the lid of the appliance while any of the hob burners are lit, the gas will go out. This is because it would be dangerous if the burners stayed on when the lid was closed.

Always use the control knob to turn off a burner. Do not use the lid as a cut-off device. This will only cut off the gas when the lid is closed. The gas will flow again when the lid is opened.

To turn off any burner

- Turn the control knob to the off position



when turning off any burner, ensure the flame has gone out before leaving the appliance.



In the event of the burner flames being accidentally extinguished, turn off the burner control and do not attempt to re-ignite the burner for at least 1 min.

Things to note

If you are having any difficulty lighting a hob burner turn all the hob controls off and make sure the burner parts have been replaced correctly.



Do not use the lid as a work surface or chopping board. This could damage the glass and reduce its strength.



Place pans on the centre of the burners.

Position pans so the handles cannot be accidentally knocked or overhang the appliance.

Lift pans on and off the pan supports. Do not slide them across the hob.



Take care to avoid burns and scalds when reaching across the hob.



Take extra care when deep fat frying, do not cover the pan with a lid.

Do not leave a pan unattended. If the pan catches fire, leave it where it is and turn off all controls. Place a damp cloth or a fitting lid over the pan to smother the flames. Never put water on the fire. Leave to cool for 30 minutes.

The grill



CAUTION: Accessible parts may be hot when the grill is in use. Young children should be kept away.

The grill on this appliance has been designed to heat up more quickly than conventional grill elements. It provides quick, direct heat and no preheating is necessary.

Using the grill

- To operate the grill select the grill function for full grill. 
- Turn the Grill temperature control knob to the right as far as it will go. This is the hottest setting.
- To use the grill at lower settings, turn the Grill temperature control knob to a lower setting.

Things to note

- The cooling fan for the controls may operate after a time.
- Some smoke from fat splashes may be evident as the grill cleans itself.
- The Top oven cannot be operated when the grill is in use.

To fit the grill pan handle

Press the button on the handle and insert the lip into the widest part of the bracket. Slide the handle towards the left and release the button.

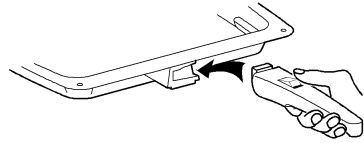

Ensure the handle is correctly located when lifting the grill pan.

To remove the handle, press the button on the handle and slide the handle towards the right. Release the button.

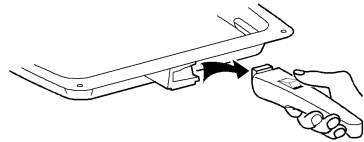

Protect your hands when removing the grill pan handle.

Always remove the grill pan handle during grilling.

Place the grill pan on the shelf so that the pan is positioned centrally beneath the grill. Ensure that the cut out on the underside of the handle bracket locates between the bars of the shelf.

The top oven

The top oven is the smaller of the two ovens. It is heated by elements in the top and bottom of the oven. It is designed for cooking smaller quantities of food. It gives especially good results if used to cook fruitcakes, sweets and savoury flans or quiche.

The top oven is ideal for use as a warming compartment. Use the lowest setting on the top oven temperature control.

Using the top oven

- Turn the top oven/grill selector to top oven .
- Turn the top oven temperature control to the required setting.

Things to note

- The oven light will illuminate.
- The indicator neon will glow. It may turn on and off during use to show that the setting is being maintained.
- The cooling fan for the controls may operate after a time.



Do not place dishes, tins and trays directly on the oven base as it becomes very hot and damage will occur.

To fit the top oven shelf

The shelf should be fitted with the straight rods uppermost on the frame and the forms towards the back of the oven.

To remove a shelf slide the shelf towards you until the shelf stop is reached. Tilt shelf up at the front so that the stops clear the side supports. Lift shelf clear.

To install a shelf, reverse the above steps. Each shelf position has an upper and lower support wire, ensure the shelf is placed between these two support wires.



Do not place cookware and cooking pots with rough bases e.g. cast iron on the oven door as damage to the glass may occur.

The main oven

The fan oven is particularly suitable for cooking larger quantities of food. The advantages of fan oven cooking are:

Preheating

The fan oven quickly reaches its temperature, so it is not usually necessary to preheat the oven. Without preheating however, you may need to add an extra 5 – 10 minutes on the recommended cooking times. For recipes needing high temperatures, e.g. bread, pastries, scones, soufflés etc., best results are achieved if the oven is preheated first. For best results when cooking frozen or cooked chilled ready meals always preheat the oven first.

Cooking temperatures

Fan oven cooking generally requires lower temperatures than conventional cooking. Follow the temperatures recommended in the cooking chart. As a guide reduce temperatures by about 20°C – 25°C for your own recipes, using a conventional oven.

Batch baking

The fan oven cooks evenly on all shelf levels, especially useful when batch baking.

Using the main oven

- Turn the main oven temperature control to the required setting.

Things to note

- The oven light will illuminate.
- The indicator neon will glow. It may turn on and off during use to show that the setting is being maintained.
- The cooling fan for the controls may operate after a time.

To fit the main oven shelves

The shelf should be fitted with the straight rods uppermost on the frame and the forms towards the back of the oven.

To remove a shelf slide the shelf towards you until the shelf stop is reached. Tilt shelf up at the front so that the stops clear the side supports. Lift shelf clear. To install a shelf, reverse the above steps.

Each shelf position has an upper and lower support wire, ensure the shelf is placed between these two support wires.



Do not place cookware and cooking pots with rough bases e.g. cast iron on the oven door as damage to the glass may occur.

Defrost feature

This function defrosts most foods faster than more conventional methods. It is particularly suitable for delicate frozen foods, which are to be served cold e.g. cream filled gateaux, cakes covered with icings or frostings, cheesecakes, biscuits, scones, etc.

Using the defrost feature

- Turn the main oven temperature control to the defrost setting. ❄

Things to note

- The oven fan and interior light will come on.

Grilling chart

FOOD	GRILL TIME (mins in total)
Bacon Rashers	5 - 6
Beef Burgers	10 - 15
Chicken Joints	30 - 40
Lamb Chops	15 - 20
Pork Chops	20 - 30
Whole Trout/Mackerel	15 - 25
Plaice/Cod Fillets	10 - 15
Kebabs	20 - 30
Kidneys – Lamb/Pig	8 - 12
Liver – Lamb/Pig	10 - 20
Sausages	20 - 30
Steak – Rare	6 - 12
Steak – Medium	12 - 16
Steak – Well Done	14 - 20
Toasted Sandwiches	3 - 4

The times quoted above are given as a guide and should be adjusted to suit personal taste.

Adjust the grill setting and the grill pan grid to suite different thicknesses of food.

Oven cooking chart

The oven temperatures are intended as a guide only. It may be necessary to increase or decrease the temperatures to suit individual preferences and requirements.

FOOD	FAN OVEN	TOP OVEN		
	COOKING TEMP °C	POS	COOKING TEMP °C	APPROX COOK TIME (m)
Biscuits	180 - 190	4	170 - 190	10 - 20
Bread	200 - 220	1	200 - 220	25 - 30
Bread rolls/buns	200 - 220	1	200 - 220	15 - 20
Small / Queen Cakes	160 - 170	4	170 - 180	18 - 25
Sponges	160 - 170	3	160 - 170	18 - 20
Victoria Sandwich	160 - 170	3	160 - 170	18 - 25
Madeira Cake	140 - 150	2	140 - 150	1¼ - 1½h
Rich Fruit Cake	130 - 140	2	140 - 150	2¼ - 2½h
Christmas Cake	130 - 140	1	130 - 140	3 - 4½h
Gingerbread	140 - 150	3	140 - 150	1¼ - 1½h
Meringues	80 - 100	2	90 - 100	2½ - 3h
Flapjack	170 - 180	3	170 - 180	25 - 30
Shortbread	130 - 140	3	140 - 150	45 - 65
Fruit Pies, Crumbles	190 - 200	2	190 - 200	40 - 50
Milk Puddings	130 - 140	3	140 - 150	1½ - 2h
Scones	210 - 220	4	220 - 230	8 - 12

Oven cooking chart continued

FOOD	FAN OVEN COOKING TEMP °C	TOP OVEN		
		POS	COOKING TEMP °C	APPROX COOK TIME (m)
Choux Pastry	190 - 200	3	180 - 190	30 - 35
Éclairs / Profiteroles	170 - 180	3	170 - 180	20 - 30
Flaky Pastry	210 - 220	3	210 - 220	25 - 40
Mince Pies	190 - 200	3	190 - 200	15 - 20
Pasta Lasagne etc.	190 - 200	3	170 - 180	40 - 45
Meat Pies	190 - 210	3	190 - 210	25 - 35
Quiche, Tarts, Flans	180 - 210	3	180 - 200	25 - 45
Shepherd's Pie	190 - 200	2	190 - 200	30 - 40
Soufflés	170 - 180	3	170 - 180	20 - 30
Fish	170 - 190	3	170 - 190	20 - 30
Fish Pie	190 - 200	2	190 - 200	20 - 25
Beef Casserole	140 - 160	2	140 - 160	2½ - 3h
Lamb Casserole	140 - 160	2	140 - 160	2½ - 3h
Convenience Foods	Follow manufacturer's instructions			
Baked Potatoes	180 - 190	3	180 - 190	1 - 1½h
Roast Potatoes	180 - 190	4	180 - 190	1 - 1½h
Large Yorkshire Puddings:	210 - 220	4	200 - 210	25 - 40
Individual Yorkshire Puddings	200 - 210	4	200 - 210	15 - 25

Note: Shelf positions are counted from the bottom of the oven.

Note: Main oven shelf positions are not critical but ensure that they are evenly spaced when more than one is used.

Roasting chart

MEAT	TEMPERATURE	COOKING TIME
Beef/ Beef boned	160-180°C	20-35 minutes per ½kg (1lb) and 20-35 minutes over
Mutton/Lamb	160-180°C	25-35 minutes per ½kg (1lb) and 25-35 minutes over
Pork/Veal/Ham	160-180°C	30-40 minutes per ½kg (1lb) and 30-40 minutes over
Chicken	160-180°C	15-20 minutes per ½kg (1lb) and 20 minutes over
Turkey/Goose	160-180°C	15-20 minutes per ½kg (1lb) up to 3½kg (7lb) then 10 minutes per ½kg (1lb) over 3½kg (7lb)
Duck	160-180°C	25-35 minutes per ½kg (1lb) and 25-30 minutes over
Pheasant	160-180°C	35-40 minutes per ½kg (1lb) and 35-40 minutes over
Rabbit	160-180°C	20 minutes per ½kg (1lb) and 20 minutes over

INTERNAL TEMPERATURES –

Rare: 50-60°C; Medium: 60-70°C; Well done: 70-80°C

The roasting temperatures and times given in the chart should be adequate for most joints, but slight adjustments may be required to allow for personal requirements and the shape and texture of the meat. However, lower temperatures and longer cooking times are recommended for less tender cuts or larger joints.

Wrap joints in foil if preferred, for extra browning uncover for the last 20 – 30 min. cooking time.

Hints and tips

Hints and tips when using the hob

- Do not overfill pans or they will boil over.
- Do not use pans with very heavy handles which cause the pan to tip.
- Do not close the lid until the appliance has cooled down.
- Do not leave accidental spillage on the hob or removable parts. The spillage should be wiped up and the parts washed and carefully dried as soon as the hob, pan supports and burner parts are cool enough to touch.
- A flat based Wok will stand stable on the pan supports. If you use a round Wok with a collar support, the collar must be the open wirework type otherwise the performance of the burner will be affected.

Hints and tips when using the grill

- Most foods should be placed on the grid in the grill pan to allow maximum circulation of air and to lift the food out of the fats and juices.
- Adjust the grid and grill pan runner position to allow for different thicknesses of food.
- Position the food close to the element for faster cooking and further away for gentler cooking.

- Food should be thoroughly dried before grilling to minimise splashing. Brush lean meats and fish lightly with a little oil or melted butter to keep them moist during cooking.
- Accompaniments such as tomatoes and mushrooms may be placed underneath the grid when grilling meats.
- When toasting bread, use the shelf in position 5 with the grid in the 'high' position.
- Preheat the grill on a full setting for a few minutes before sealing steaks or toasting. Adjust the heat setting and the shelf as necessary during cooking.
- The food should be turned over during cooking as required.

Hints and tips when using the top oven

- Arrange the shelves in the required positions before switching the oven on. Shelf positions are counted from the bottom upwards.
- There should always be at least 2.5cm (1") between the top of the food and the element. This gives best cooking results and allows room for rise in yeast mixtures, Yorkshire puddings etc. When cooking cakes, pastry, scones bread etc., place the tins or baking trays centrally on the shelf.

24 **electrolux** hints and tips

- Ensure that food is placed centrally on the shelf and there is sufficient room around the baking tray/dish to allow for maximum circulation.
- Stand dishes on a suitably sized baking tray on the shelf to prevent spillage onto the oven base and to help reduce cleaning.
- The material and finish of the baking tray and dishes used affect base browning. Enamelware, dark, heavy or non-stick utensils increase base browning. Shiny aluminium or polished steel trays reflect the heat away and give less base browning.
- Because of the smaller cooking space and lower temperatures, shorter cooking times are sometimes required. Be guided by the recommendations given in the cooking chart.
- Do not place dishes directly on the oven base as it becomes very hot and damage may occur.
- For economy leave the door open for the shortest possible time, particularly when placing food into a pre-heated oven.

Hints and tips when using the main oven

- Arrange the shelves in the required positions before switching the oven on. Shelf positions are counted from the bottom upwards.

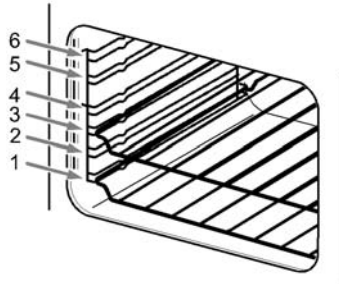

- When cooking more than one dish in the fan oven, place dishes centrally on different shelves rather than cluster several dishes on one shelf, this will allow the heat to circulate freely for the best cooking results.
- When batch baking one type of food, e.g. Victoria sandwich cakes, those of similar size will be cooked in the same time.
- It is recommended that when baking larger quantities the shelf positions should be evenly spaced to suit the load being cooked. A slight increase in cooking time may be necessary.
- Do not place baking trays directly on the oven base as it interferes with the oven air circulation and can lead to base burning; use the lower shelf position.

Hints and tips when defrosting

- Place the frozen food in a single layer where possible and turn it over half way through the defrosting process.
 - The actual speed of defrosting is influenced by room temperature. On warm days defrosting will be faster than on cooler days.
 - It is preferable to thaw fish, meat and poultry slowly in the fridge. However, this process can be accelerated by using the defrost function. Small or thin fish fillets, frozen peeled prawns, cubed or minced meat, liver, thin chops, steaks etc., can be thawed in 1 – 2 hours.
 - A 1kg/2¼lb oven ready chicken will be thawed in approximately 5 hours. Remove the giblets as soon as possible during the thawing process.
 - Joints of meat up to 2kg/4½lb in weight can be thawed using the defrost function.
 - All joints of meat and poultry must be thawed thoroughly before cooking.
 - Always cook thoroughly immediately after thawing.
 - Do not leave food at room temperature once it is defrosted. Cook raw food immediately or store cooked food in the fridge, once it has cooled.
- Care must always be taken when handling foods in the home. Always follow the basic rules of food hygiene to prevent bacterial growth and cross contamination when defrosting, preparing, cooking, cooling and freezing foods.

What to do if...

Maintenance must only be carried out by a competent/qualified person. Do not try to alter/modify the appliance yourself, as this could be dangerous. We recommend that your appliance has an annual gas safety check carried out by our approved service organisation. Please carry out the following checks on your appliance before calling a Service Engineer.

It may be that the problem is a simple one that you can solve yourself without the expense of a service call. **In-guarantee customers should make sure that the checks have been made as the engineer will make a charge if the fault is not a mechanical or electrical breakdown.**

Please note that proof of purchase is required for in-guarantee service calls.

PROBLEM	POSSIBLE SOLUTION
The grill, ovens and timer do not work.	Check that the appliance has been wired in to the appliance supply and is switched on at the wall.
	Check that the main appliance fuse is working.
	If you have checked the above: Allow the appliance to cool for a couple of hours. The appliance should now be working normally.
The grill and top oven work but the main oven does not.	Check that the time of day has been set on the clock. Check that the oven is set for manual cooking.
The grill does not work or cuts out after being used for a long period of time.	Ensure the cooling fan is running when the grill is on. If the cooling fan fails, the grill will not operate correctly. Contact your local service force centre.
	Leave the grill door open and allow the grill to cool. After a couple of hours check that the grill works as normal
The timer does not work.	Check that the instructions for the operation of the timer are being closely followed.
The indicator neons are not working correctly.	Check that you have selected only the function you require. Ensure all other controls are in the off position.

What to do if continued...

PROBLEM	POSSIBLE SOLUTION
The oven is not cooking evenly.	Check that the appliance is correctly installed and is level.
	Check that the recommended temperatures and shelf positions are being used.
The oven light fails to illuminate.	The oven light bulb may need replacing.
	If the Main Oven is set for automatic cooking the light will illuminate when the cook time begins.
The oven fan is noisy.	Check that the oven is level.
	Check that the shelves and bakeware are not vibrating in contact with the oven back panel.
The oven temperature is too high or too low.	Check that the recommended temperatures and shelf positions are being used. Be prepared to adjust the temperature up or down slightly to achieve the results you want.
The hob burners will not light.	Ensure the burner parts have been placed correctly.
	Check that there is not a problem with your gas supply. You can do this by making sure the other gas appliances such as central heating or gas fires are working.
The flame colour is orange/yellow.	Due to the design of the burner the flame can appear to be orange /yellow (flame disturbance) in certain areas of the burner this is a natural occurrence.
The burner is not igniting or only partially lighting.	Check that the burner is dry and that food spillage or cleaning fluids are not present on the burner. This can be dried with a cloth and stubborn marks cleaned away with a dry nylon brush (old toothbrush etc).

What to do if continued...

PROBLEM	POSSIBLE SOLUTION
The burner sounds noisy.	It is natural for the burners to emit noise as the gas is being drawn through the burner and may reduce as they heat up.
The burner is emitting a popping sound.	This is a natural occurrence when the burner is alight and does not affect the performance of the burner.
Noise.	It is normal for some metal parts on the cooker to produce noise when in use, this is due to expansion and contraction when heating up and cooling down.

Care and cleaning



Before cleaning always allow the appliance to cool down before switching off at the electricity supply.

Cleaning materials

Before using any cleaning materials on your appliance, check that they are suitable and that their use is recommended by the manufacturer.

Cleaners that contain bleach should not be used as they may dull the surface finishes. Harsh abrasives and scourers should also be avoided.

Cleaning the outside of the appliance

Do not use abrasive cleaning materials e.g. abrasive cream cleaners, wire wool pads or scourers on painted or printed finishes as damage may occur.

Regularly wipe over the control panel, control knobs, handles, doors and appliance sides using a soft cloth and hot soapy water. To prevent streaking, finish with a soft cloth.

Stainless Steel cream cleaners are abrasive and should be avoided as they may dull the surface finish. **Any spillage on the stainless steel finish must be wiped off immediately.**



Do not attempt to remove any of the control knobs from the appliance as this may cause damage and is a safety hazard.

Removing and replacing the wirework runners

1. Remove all shelves and furniture from the oven.
2. Hold the wirework at the bottom, unclip from the cavity side and gently pull towards the centre of the oven.
3. Unhook the runner at the top and remove from the cavity.
4. To replace the runners, hook the wirework side runner into the cavity, slide back and press into place.

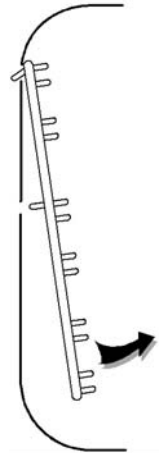

Ensure the wirework runners are firmly in position before replacing the oven shelves.

Cleaning the hob

Clean the hob top using a mild abrasive. Take care not to damage the spark electrodes. If the spark electrodes are damaged the burners will not light.

You can remove the pan supports, burner caps and burner crowns to clean them. Again take care not to damage the spark electrodes.

Clean the burner crowns and pan supports by soaking them in very hot soapy water. Aluminium based saucepans can leave shiny metal marks on the pan supports. You can remove any stubborn stains by scouring with a soap impregnated steel wool pad. If you look after the burner crowns and pan supports in this way they will stay reasonably clean. However the surface will dull with time.

After cleaning the appliance parts, dry them thoroughly before you put them back.

When replacing the hob burner parts

1. Crown to body. (Do not try to force the crown on to the body). Make sure that the hole in the crown is over the electrode. Check that the location pegs sit in the slots in the body. When the crown is in this position let it fall freely on to the body. Check that the crown can be moved slightly from side to side.

2. Cap to crown. Place cap centrally on the top of crown (enamel side up). Move sideways and front to back to check the cap is properly fitted.
3. Check for ignition. If a burner will not light then you need to check the crown and cap positions.

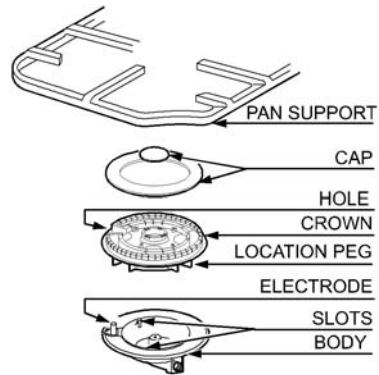

Cleaning the shelves, wire-work runners and grill/oven furniture

All removable parts, except the grill pan handle can be washed in the dishwasher.

The grill pan, grill pan grid, oven shelves and wirework runners may be cleaned using a soap impregnated steel wool pad. Soaking first in hot soapy water will make cleaning easier.

Cleaning inside the grill and oven compartments

The sides and back of the grill/second oven and main oven compartments are coated with a special Stay-clean coating. They should not be cleaned manually.

The vitreous enamel main oven base and grill compartment base can be cleaned using normal oven cleaners with care. Ensure that the manufacturers instructions are followed and that all parts are well rinsed afterwards.



Aerosol cleaners must not come into contact with elements, the door seal, or any painted finishes as this may cause damage.



Aerosol cleaners must not be used on Stay-clean surfaces.

- Use minimal, if any, extra oil or fat when roasting meat, potatoes only require brushing with fat before cooking. Extra fat in the oven during roasting will increase splashing and staining of the cavity.
- It is not necessary to add water to a meat tin when roasting. The water and the fat juices from the joint create excessive splattering during cooking – even at normal temperatures, as well as causing condensation.
- Covering joints during cooking will also prevent splashing onto the interior surfaces. Removing the covering for the last 20-30 minutes will allow extra browning if required. Some large joints and turkeys especially benefit by this method of cooking, allowing the joint to cook through before the outside is over-browned.
- To carry out the cleaning cycle, remove the oven shelves and set the oven to 220°C.
- It is a good idea to run the oven for an hour or two per week to ensure continued good performance from the Stay-clean finish.
- Slight discolouration and polishing of the Stay-clean surfaces may occur in time. This does not affect the Stay-clean properties in any way.

Cleaning the door(s)



To prevent damaging or weakening the door glass panels avoid the use of the following:

- **Household detergents and bleaches**
- **Soap impregnated pads unsuitable for non-stick saucepans**
- **Abrasive cleaning pads, scourers and steel wool pads.**
- **Chemical oven pads or aerosols**
- **Rust removers**
- **Bath/Sink stain removers**

Cleaning between the outer and inner door glass

The inner door glass is removable for cleaning.

Clean the outer and inner glass using hot soapy water or hob cleaner may be used. **Do not** use hob cleaner on the Stainless Steel or painted finishes.

Ensure that all parts are well rinsed and thoroughly dried before attempting to replace the outer door.



Please note that the door glass on your product may differ in type and shape from that shown in the diagrams.

To remove the Inner glass

Open the oven door to gain access to the top of the oven door.

Top Oven:

1. Carefully pull the trim away from the door and lift off.
2. Hold the door glass securely in place with one hand before sliding the glass out with the other hand.

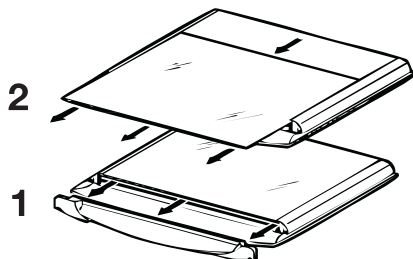

Main Oven:

1. Carefully push the trim towards the oven.
2. Remove the seal.
3. Hold the door glass securely in place with one hand before sliding the glass out with the other hand.

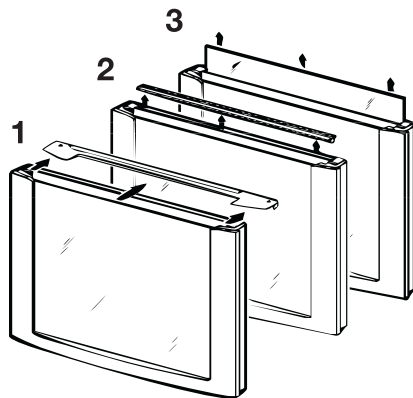



If the door glass panel becomes chipped or has deep scratches the glass will be weakened and must be replaced to prevent the possibility of the panel shattering. Please contact your local service force centre who will be pleased to advise further.

To replace the inner door glass

To ensure the glass is properly located the text 'This side up' should be facing towards you at the top edge of the door and facing into the cavity.

Holding the glass with both hands, gently slide the glass into the side trims of the oven door. Always ensure that the glass is returned to the same side trim it was removed from.

Replace the seal on the main oven door if removed. To replace the trim, line up the clips on the underside of the trim with the connectors at the top of the door.

Carefully slide the trim towards the door.

Ensure the trim is securely in place before closing the oven door.



Do not attempt to use the oven without the glass being in place.

Replacing an oven light bulb

The type of bulb required is a 300°C 25 watt small Edison Screw.



Disconnect the appliance from the electricity supply before replacing the bulb.

1. Make sure the appliance is cool before replacing the bulb.
2. Open the door and remove the shelves and wirework runners.
3. Remove the glass cover by turning it to the left.
4. Unscrew the bulb by turning it to the left.
5. Fit a new bulb and then replace the glass bulb cover.
6. Refit the wirework runners and replace the shelves.
7. Restore the electricity supply and reset the time of day.

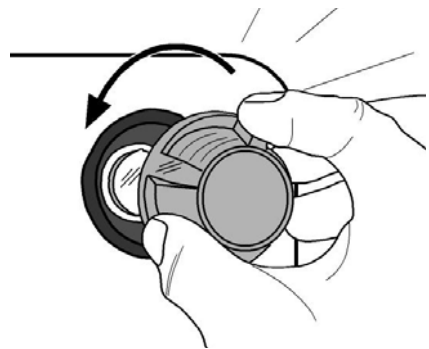

Technical data

Dimensions	
Height:	900mm
Width:	600mm
Depth: (excluding handles and knobs)	600mm
Weight	66kg

- Space for fixing at hob level 2mm minimum clearance
- Space for fixing above hob level See important note 'Location of Appliance'.
- Minimum space above hob 750mm (if cooker hood is fitted refer to the cooker hood installation instructions.
- Minimum distance from rear wall 5mm (spacer given by pressed spacer on vent panel)

Connections	
Gas connection	Rear left hand side of appliance at hob level. Rc ½ (½" B.S.P. female)
Electrical connection	230 - 240 V 50 Hz Mains connected at rear centre of appliance using at least 6mm ² multi core PVC insulated cable.

Loading info: Electric ovens	
Voltage	230-240 Volts AC 50Hz
Wattage	4.4 – 4.8kW

Loading info: Gas hob				
Natural Gas	R.H.F	R.H.R	L.H.R	L.H.F
Heat input	1.0kW (3412 Btu/h)	1.9kW (6483 Btu/h)	1.9kW (6483 Btu/h)	3.4kW (11600 Btu/h)
Injector marking	070	096	096	136
L.P. Gas	R.H.F	R.H.R	L.H.R	L.H.F
Heat input	1.0kW (71.8g/h)	2.0kW (136.5g/h)	2.0kW (136.5g/h)	3.4kW (244.12g/h)
Injector marking	050	071	071	93

General	
Ignition	(H.T. Spark)
Spark gap	3 – 4 mm
Gas Category	Countries of destination
CAT. I _{2h}	GB, IE
CAT. I ₃₊	GB, IE



This appliance complies with:

European Council Directives Low Voltage Directive 73/23/EEC

Gas Directive 90/396/EEC, EMC Directive 89/336/EEC

CE Marking Directive 93/68/EEC Energy Label Directive 2002/40/EC

Installation instructions

IMPORTANT – Safety requirements

Where applicable Natural Gas and L.P Gas versions of this appliance are available. Check that this model is suitable for the type of supply available.

This appliance must be installed and/or serviced by a competent person in accordance with the Gas Safety (Installation and Use) Regulations Current Editions and the I.E.E. Wiring Regulations.

For appliances installed in the Republic of Ireland please refer to NSAI - Domestic Gas Installation IS813 Current Editions and the ETCI Rules for Electrical Installations.

In the Republic of Ireland a signed Declaration of Conformity is issued by the installer (IS813 Currents Editions Annex D.1). Detailed recommendations are contained in the following British Standard Codes of Practice – BS.6172, BS.5440: Part 2 and B.S.6891. All British Standards must be 'Current Editions'.



This appliance must be installed by a qualified electrician / competent person (CORGI Registered). Safety may be impaired if installation is not carried out in accordance with these instructions.

Before connecting the appliance make sure that the voltage of your electricity supply is the same as that indicated on the rating plate.

This is situated on the lower front frame of the appliance and can be seen upon opening the door.

Alternatively the rating plate may

also be found on the back or top of some models (where applicable).

Do not alter the electrical circuitry of this appliance.

Provision for ventilation

This appliance is not connected to a combustion products evacuation device. It shall be installed and connected in accordance with the current installation regulations. Particular attention shall be given to the relevant requirements regarding ventilation.

The room containing the appliance should have an air supply in accordance with BS.5440: Part 2 Current Edition. All rooms require an openable window or equivalent and some rooms will require a permanent vent as well. For room volumes up to 5m³ an air vent of 100cm² is required; for room volumes between 5m³ and 10m³ an air vent of 50cm² is required. If the room has a door that opens directly to the outside, no air vent is required.

For room volumes that exceed 11m³ no air vent is required. If there are other fuel burning appliances in the same room, BS.5440: Part 2 Current Edition should be consulted to determine the requisite air vent requirements.

Prolonged intensive use of the appliance may call for additional ventilation, for example opening a window, or more effective ventilation, for example increasing the level of mechanical ventilation where present.

Moving your appliance

You may damage some soft or badly fitted floor coverings when you move the appliance. The floor covering under the appliance should be securely fixed so it does not ruck up when you move the appliance across it.

Alternatively you could remove the floor covering. This appliance is heavy and care must be taken when moving it. Do not try to move the appliance by pulling the door handles.

To move the appliance open the grill door. Raise the appliance off its front feet by lifting it from inside the oven. Pull the appliance forward. When you replace the appliance push it back to the stop and make sure there is the same gap at each rear corner.

For your safety

Do not try to disconnect the appliance from the gas supply if the supply pipe does not have a bayonet connection, as described in the installation instructions. If this is the case contact the person who installed the appliance.

Location of the appliance

This appliance must not be installed in a bed-sitting room of volume less than 20m³ or in a bathroom, shower room or garage. It is essential that the appliance is positioned as shown.

Shelves, wall cabinets and cooker hoods must be fitted a minimum of 750mm directly above the top of the hob (or greater for cooker hoods if recommended by manufacturers instructions) and 400mm above the hob when fitted in line with the outside of the appliance. If the units are intended to be fitted adjacent to the appliance but less than 400mm above the hob, then a minimum space of 50mm must be maintained between the sides of the unit and the appliance. Curtains must not be fitted immediately behind the appliance or within 150mm of the sides of the hob. If fitted next to or between two base units a minimum space of 2mm must be left between each unit and the sides of the appliance. The levelling feet fitted to the appliance will achieve a nominal height to hob of 900mm + 20mm.

For appliances installed in the Republic of Ireland please refer to NSAI-Domestic Gas Installation IS813 Current Edition Section7 Permitted Locations of appliance Table4---Locations and Permanent Ventilation requirements- flueless appliances.

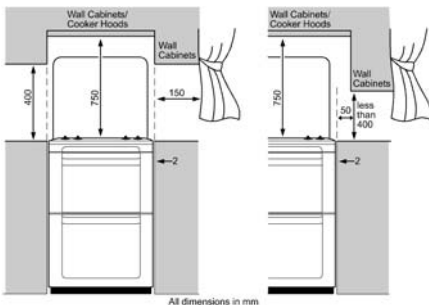

L.P.G. cookers must not be installed below ground level i.e. in a basement or aboard any boat, yacht or other vessel.

Levelling the appliance

Adjustment to suit floor conditions or height is obtained by rotating clockwise or anti clockwise the feet at the front and rear of the appliance. A spirit level should be placed on one of the shelves to confirm the appliance is correctly levelled.

Connecting to the electricity supply



Warning: This appliance must be earthed. Do not earth this appliance to gas supply piping. Connect to 230 - 240V AC supply only.

Connection to the electricity supply must be carried out by a qualified electrician/competent person.

- The electrical connection should be made using a double pole isolating switch (cooker socket) with at least 3mm contact separation in all poles. The cable must have conductors of sufficiently high cross-sectional area to prevent overheating and deterioration.
- We recommend you use a new length of 6mm² twin core earthed cable to ensure your safety.
- Make connection by proceeding as follows: -

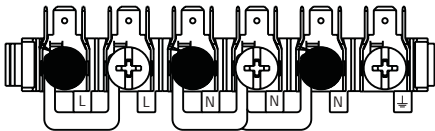

Note: Blanking plates not to be removed.

Ensure that the links are fitted as shown

- Pre-form wires to the appropriate shape to suit fitting into the mains terminal block.
- Strip inner insulation on wires using wire strippers.

- Twist the bared wires using pliers.
- Cut bared wires 10mm away from the end of the inner insulation.
- Where uninsulated Earth wires are used ensure they are suitably sheathed to leave 10mm bare wire to fit into the terminal.
- Clamp bare wires into the relevant terminal and check they are held by tugging each one in turn.
- Ensure **all** screws are securely tightened.
- Clamp the mains cable securely ensuring 5mm of the outer insulation is inside the terminal block and that the wires are not taut but not so slack as to cause any fouling.
- Connect the remaining end of the mains cable to the appliance to the appliance point / junction box.
- Place fuse / miniature circuit breaker in circuit and switch on at mains.
- When refitting the mains terminal cover, ensure that the lower tabs are located inside the bottom edge of the aperture, before fixing the two screws into the top edge of the mains terminal cover.
- Ensure that the cover is securely fastened.

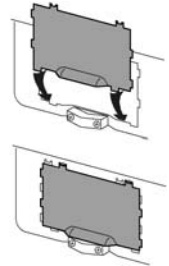

Note: House circuit

Earth leakage / continuity tests must be carried out before the appliance is connected to the mains supply and re-checked after fitting.

Connecting to the gas supply

This appliance is designed to be installed with an appliance flexible connection only. Supply piping should not be less than R3/8. Connection is made to the Rc 1/2 (1/2" B.S.P.) female threaded entry pipe located just below the hob level on the rear left hand side of the appliance.

NOTE: ONLY LIQUID SEALANTS TO BE USED WHEN INLET GAS PIPE IS FITTED I.E.: DO NOT USE P.T.F.E.

SEALANT TAPE. Carry out a gas tightness test after connecting to the gas supply. The gas bayonet connector must be fitted in the shaded area indicated.

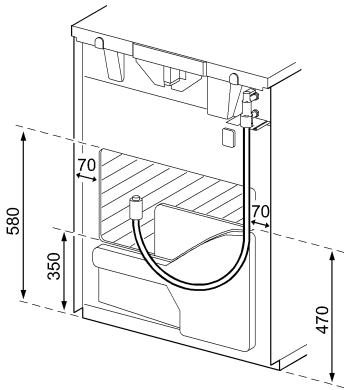

Take into account that it must be possible to pull the appliance forward sufficiently. Ensure the hose does not become trapped when pushing the appliance into position.

IMPORTANT: FLEXIBLE TUBING USED MUST COMPLY WITH BS.669 CURRENT EDITION.

LPG Flexible connections must be a type suitable for L.P.G and capable of operation up to 50 mbar and carry a red stripe, band or label.

Fitting the stability chain

It is recommended that if the appliance is to be installed with a flexible supply pipe, a stability chain be fitted and is available from your supplier (see Important Safety Requirements). These instructions should be read in conjunction with any leaflet packed with the stability chain.

1. Place the appliance in its intended position and level appliance.
2. Mark a position 100mm from the top of the rear right hand corner.
3. Measure down 150mm from this point. This gives the position of the wall anchor point for the stability chain.
4. The stability chain anchor point on the appliance is shown below.

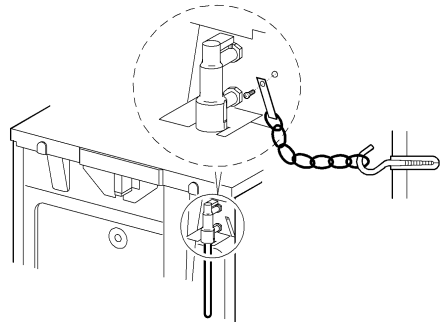

Pressure testing

1. The Rapid injector is used as a pressure test point.
2. Connect the pressure gauge to the Rapid injector.
3. Check the supply pressure by turning the Rapid burner on and one other hob burner full on and light the appropriate burner. The pressure should be either:-
 - (i) For Natural Gas 20mbar
 - (ii) For LP. Gas. The pressure must be set to 29 mbar for use on butane or 37 mbar for use on propane.
4. Turn off the taps, disconnect the pressure gauge.
5. Check operation of each hob burner.

Checking the hob

1. Lift the lid. Fit the burner crowns and caps ensuring that they are correctly seated. Fit the pan supports.
2. To light the hob burners push in and hold the control knob, turn to large flame symbol (highest setting) and press the ignition button immediately. Keep the control knob depressed for up to 5 seconds, but no longer than 10 seconds. After this time release the controls. The flame should remain alight.
3. Turn off the hob and wait 1 minute. Turn the hob control knob to large flame symbol (highest setting).
4. Do not depress or attempt to ignite the burner. No gas should flow.

Checking the lid shut-off device

1. Lift the lid
2. Turn one hob tap to its full on position and push the ignition button.
3. Close the lid. There should now be no gas supply to the hob and the burner will go out.
4. Turn off the hob and lift the lid. The gas supply should now be restored to the hob, when the tap is turned on.

To set the time of day

Please refer to the Timer section.

General note

Instruct the user on how to use the appliance and its ignition system. Refer the user to the wording inside this user manual which gives advice on the safe operation of the appliance.

Environment



After installation please dispose of the packaging with due regard for safety and the environment. Your local authority can arrange this.

At the end of the appliances life

The symbol  on the product or on its packaging indicates that this product may not be treated as household waste. Instead it shall be handed over to the applicable collection point for the recycling of electrical and electronic equipment. By ensuring this product is disposed of correctly, you will help prevent potential negative consequences for the environment and human health, which could otherwise be caused by inappropriate waste handling of this product. For more detailed information about recycling of this product, please contact your local city office, your household waste disposal service or the shop where you purchased the product.

Energy save mode

By switching off the time display you can save energy.

Switching off the time display

Press and hold any two buttons until the display switches off.

Switching on the time display

Press any button to switch on the display.



The display can only be switched off if none of the timer functions, 'Cooktime', 'Endtime', or 'Countdown', is in use.

Guarantee / Customer care

Standard guarantee conditions

We, Electrolux, undertake that if within 12 months of the date of the purchase this Electrolux appliance or any part thereof is proved to be defective by reason only of faulty workmanship or materials, we will, at our option repair or replace the same FREE OF CHARGE for labour, materials or carriage on condition that:

- The appliance has been correctly installed and used only on the electricity supply stated on the rating plate.
- The appliance has been used for normal domestic purposes only, and in accordance with the manufacturer's instructions.
- The appliance has not been serviced, maintained, repaired, taken apart or tampered with by any person not authorised by us.
- Electrolux Service Force Centre must undertake all service work under this guarantee
- Any appliance or defective part replaced shall become the Company's property.
- This guarantee is in addition to your statutory and other legal rights.

Exclusions

- Damage or calls resulting from transportation, improper use or neglect, the replacement of any light bulbs or removable parts of glass or plastic.
- Costs incurred for calls to put right an appliance which is improperly installed or calls to appliances outside the United Kingdom.
- Appliances found to be in use within a commercial environment, plus those which are subject to rental agreements.
- Products of Electrolux manufacturer that are not marketed by Electrolux

Service and Spare Parts

In the event of your appliance requiring service, or if you wish to purchase spare parts, please contact your local Service Force Centre by telephoning

+353 (0) 1 4090753

Your telephone call will be automatically routed to the Service Force Centre covering your postcode area.

For the address of your local Service Force Centre and further information about Service Force, please visit the website at

www.serviceforce.co.uk

Before calling out an engineer, please ensure you have read the details under the heading "What to do if..."

When you contact the Service Force Centre you will need to give the following details:

1. Your name, address and postcode.
2. Your telephone number.
3. Clear concise details of the fault.
4. The model and Serial number of the appliance (found on the rating plate).
5. The purchase date.

Please note a valid purchase receipt or guarantee documentation is required for in guarantee service calls.

Customer Care

For general enquiries concerning your Electrolux appliance, or for further information on Electrolux products please contact our Customer Care Department by letter or telephone at the address below or visit our website at www.electrolux.co.uk

Customer Care Department
Electrolux Group (Irl) Ltd
Long Mile Road
Dublin 12

Republic of Ireland

Tel: +353 (0) 1 4090753 (*)

Email: service.eid@electrolux.ie

(*) Calls may be recorded for training purposes

www.electrolux.com

www.electrolux.co.uk