

E4401-5

User manual

Built-In Electric Oven

## Dear Customer

Thank you for choosing one of our high-quality products.

With this appliance you will experience the perfect combination of functional design and cutting edge technology.

Convince yourself that our appliances are engineered to deliver the best performance and control - indeed we are setting the highest standards of excellence.

In addition to this you find environmental and energy saving aspects as an integral part of our products.

To ensure optimal and regular performance of your appliance please read this instruction manual carefully. It will enable you to navigate all processes perfectly and most efficiently.

To refer to this manual any time you need to, we recommend you to keep it in a safe place. And please pass it to any future owner of the appliance.

We wish you much joy with your new appliance.

The following symbols are used in this user manual:



Important information concerning your personal safety and information on how to avoid damaging the appliance.



General information and tips



Environmental information

# Contents

<b>Operating Instructions</b>	<b>5</b>
Safety instructions	5
Description of the Appliance	7
General Overview	7
Control Panel	8
Oven Features	9
Oven accessories	10
Before Using for the first time	11
Initial Cleaning	11
Using the Rings	12
Setting the heat setting	13
Using the Oven	14
Switching the Oven On and Off	14
Oven Functions	15
Inserting the Oven Shelf, Baking Tray and Roasting Pan	16
Inserting/Removing the Grease Filter	17
Additional functions	18
Countdown	19
Meat probe	20
Mechanical Door Lock	22
Uses, Tables and Tips	23
Cooking table	23
Baking	24
Baking table	26
Table for Bakes and Gratins	32
Frozen Ready Meals Table	33
Roasting	34
Roasting table	35
Meat probe Table	37
Grill Sizes	38
Grilling table	38
Defrosting	39
Defrosting table	39
Drying	40
Making Preserves	41

Cleaning and Care	42
Outside of the appliance	42
Oven interior	42
Accessories	42
Fat Filter	42
Shelf Support Rails	43
Oven Lighting	44
Oven Ceiling	45
Oven door	46
Oven door glass	48
What to do if ...	52
Disposal	54
<b>Installation Instructions</b>	<b>55</b>
Safety information for the installer	55
<b>Guarantee/Customer Service</b>	<b>60</b>
<b>Service</b>	<b>63</b>

---

# Operating Instructions



## Safety instructions

### Electrical safety

- This appliance must be only connected by a **registered electrician**.
- In the event of a fault or damage to the appliance: Take the fuses out or switch off.
- **Repairs** to the appliance must only be carried out by **qualified service engineers**. Considerable danger may result from improper repairs. If repairs become necessary, please contact our Customer Services or your dealer.

### Child Safety

- Never leave children unsupervised when the appliance is in use.

### Safety whilst Using

- People (including children) who, because of their physical, sensory or mental capabilities or their inexperience or ignorance are not able to use the device safely, should not use this device without supervision or instruction by a responsible person.
- This appliance is intended to be used for cooking, roasting and baking food in the home.
- Take care when connecting electric appliances to sockets nearby. Do **not** allow connecting leads to come into contact with or to catch beneath the hot oven door.
- **Warning: Risk of burns!** The interior of the oven becomes hot during use.
- Using ingredients containing alcohol in the oven may create an alcohol-air mixture that is easily ignited. In this case, open the door carefully. Do not have embers, sparks or naked flames in the vicinity when opening the door.



### Information on acrylamides

According to the latest scientific knowledge, intensive browning of food, especially in products containing starch, can constitute a health risk due to acrylamides. Therefore we recommend cooking at the lowest possible temperatures and not browning foods too much.

## How to avoid damage to the appliance

- Do not line the oven with aluminium foil and do not place baking trays, pots, etc. on the oven floor, as the heat that builds up will damage the oven enamel.
- Fruit juices dripping from the baking tray will leave stains, which you will not be able to remove. For very moist cakes, use a deep tray.
- Do not put any strain on the oven door when open.
- Never pour water directly into the oven when it is hot. This could cause damage to or discoloration of the enamel.
- Rough handling, especially around the edges of the front panel, can cause the glass to break.
- Do not store any flammable materials inside the oven. These could ignite when the oven is switched on.
- Do not store any moist foods inside the oven. This could damage the oven enamel.
- After switching off the cooling fan, do not keep uncovered dishes in the oven. Moisture may condense in the oven interior or on the glass doors and may get into the units.



### Note on enamel coating

Changes in the colour of the oven's enamel coating as a result of use do not affect the appliance's suitability for normal and correct use. They therefore do not constitute a defect in the sense of the warranty law.

# Description of the Appliance

## General Overview

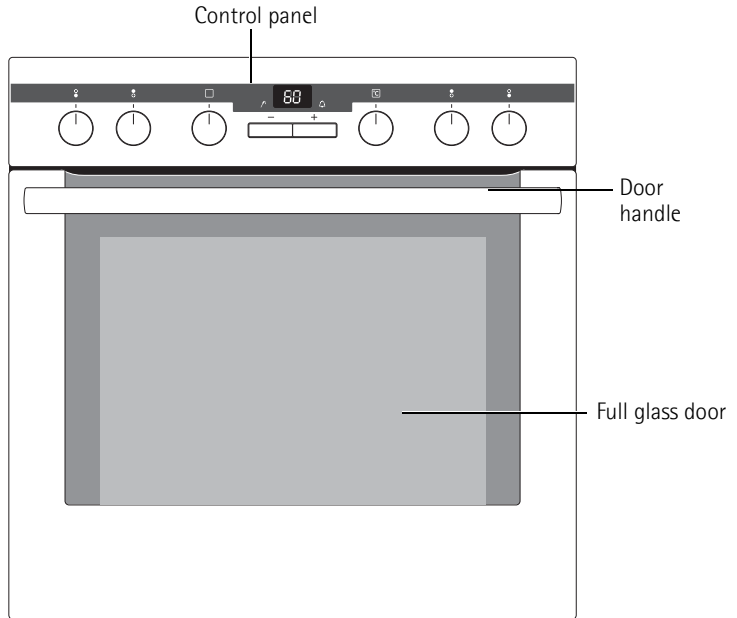

## Control Panel

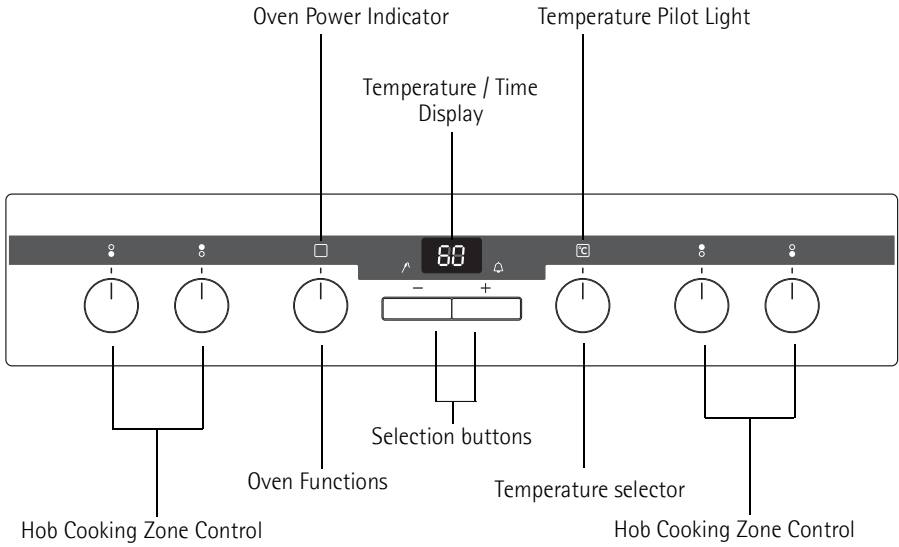



## Oven Features

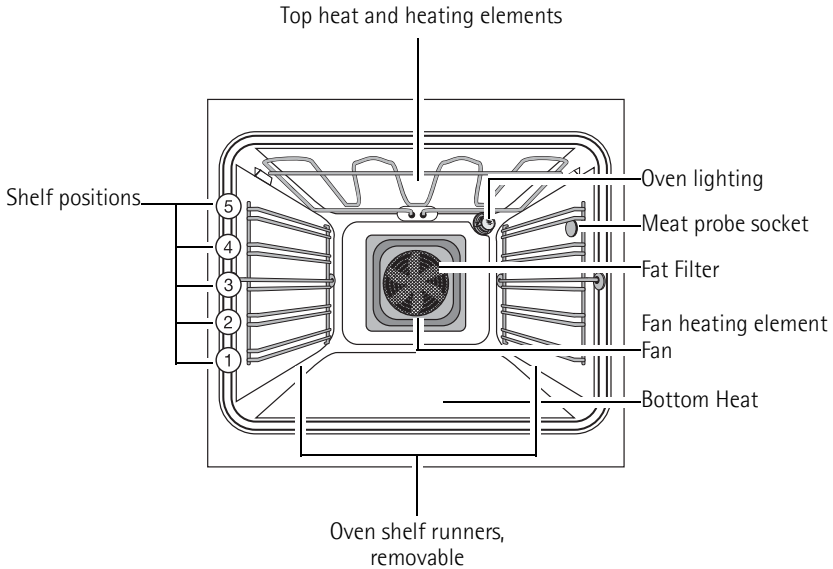

### Oven steam vent

The steam from the oven is fed directly upwards via the duct in the rear of the cooking surface.

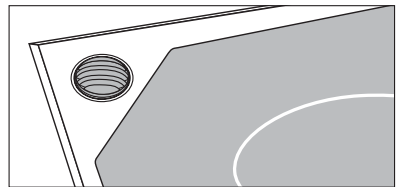

### Inside of door

On the inside of the oven door you will find the numbers of the different oven shelves. You will also find some brief information about the oven's functions, recommended shelves and temperatures for cooking the most popular dishes.

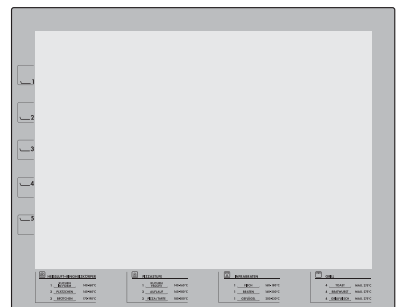

## Oven accessories

### Oven shelf

For cookware, cake tins, roasts and grilled foods.

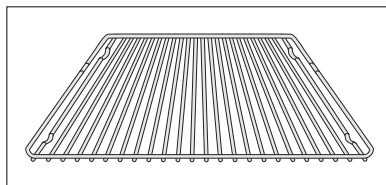

### Baking tray

For cakes and biscuits.

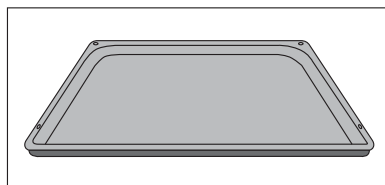

### Roasting Pan

For baking and roasting or as a pan for collecting fat.

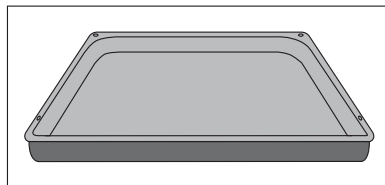

### Meat probe

For determining exactly how far joints of meat are cooked.

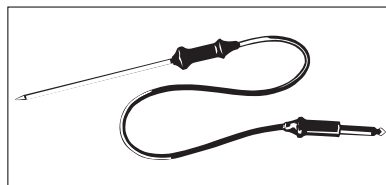

# Before Using for the first time

## Initial Cleaning

Before using the oven for the first time you should clean it thoroughly.



**Caution:** Do not use any caustic, abrasive cleaners! The surface could be damaged.



To clean metal fronts use commercially available cleaning agents.

1. Turn the oven function switch to oven lighting .
2. Remove all accessories and the shelf support rails and wash them with warm water and washing up liquid.
3. Then wash out the oven with warm water and washing-up liquid, and dry.
4. Wipe the front of the appliance with a damp cloth.

## Using the Rings

**i** Also refer to the operating instructions for your built-in hob. It contains important information on ovenware, operation, cleaning and care.

### Heat settings

- You may select the heat settings within the range of settings 1-9.
- Intermediate positions may be selected between settings 2 and 7.

1 = lowest heat setting

9 = highest heat setting

**🌿** Switch the cooking zone off approx. 5-10 minutes before cooking is finished to make use of the residual heat. This saves electricity.

**i** The cooker has **pop-up ring switches**. Press the ring switch to use it. The switch will then pop up.

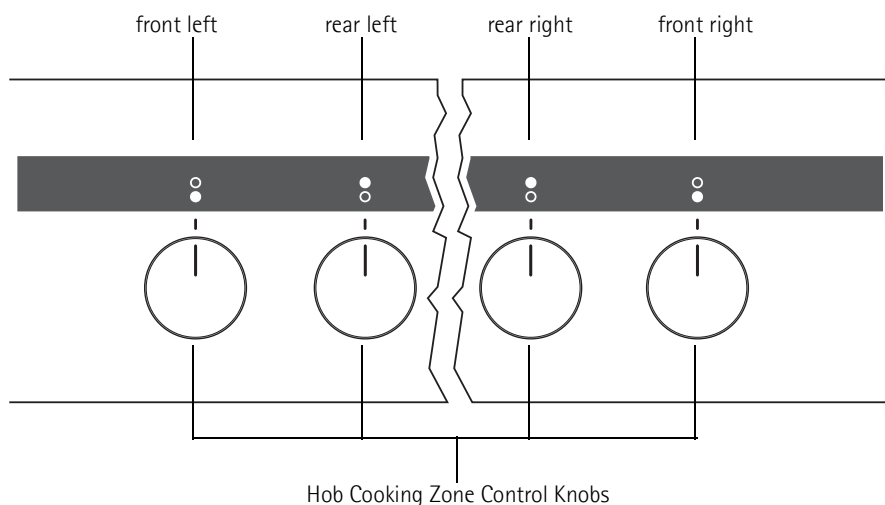

## Setting the heat setting

1. Select the heat setting.

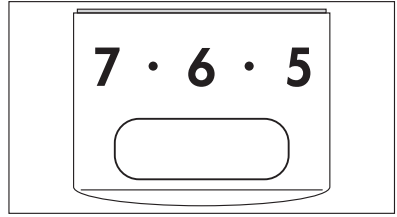

2. To end the cooking process, turn back to the Off position.

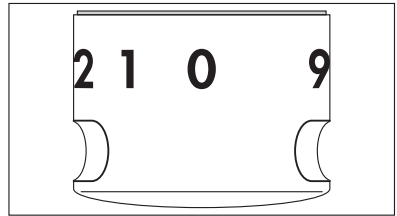

The corresponding ring pilot light is lit while the ring is operating.

# Using the Oven

## Switching the Oven On and Off

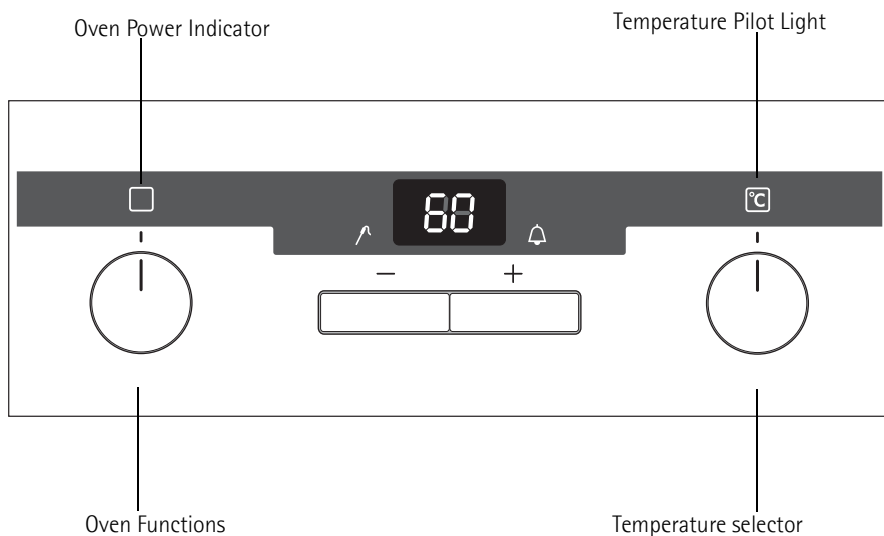

1. Turn the oven functions dial to the desired function.
2. Turn the temperature selector to the desired temperature.  
The power indicator is lit as long as the oven is in operation.  
The temperature pilot light is lit as long as the oven is heating up.
3. To turn the oven off, turn the oven functions dial and the temperature selector to the Off position.











### Cooling fan

The fan switches on automatically in order to keep the appliance's surfaces cool. When the oven is switched off, the fan continues to run to cool the appliance down, then switches itself off automatically.

## Oven Functions

The oven has the following functions:

	Oven function	Application
	<b>Light</b>	Using this function you can <b>light up</b> the oven interior, e.g. for cleaning.
	<b>Convection with ring heating element</b>	For <b>baking on up to three oven levels</b> at the same time. Set the oven temperatures 20-40 °C lower than when using Conventional.
	<b>Pizza setting</b>	For baking on one oven level dishes that require <b>more intensive browning and a crispy base</b> . Set the oven temperatures 20-40 °C lower than when using Conventional.
	<b>Conventional</b>	For <b>baking and roasting on one oven level</b> .
	<b>Bottom heat</b>	For <b>baking cakes with crispy or crusty bases</b> .
	<b>Defrost</b>	For <b>defrosting</b> e. g. flans and gateaux, butter, bread, fruit or other <b>frozen foods</b> .
	<b>Grill</b>	For <b>grilling</b> flat foodstuffs placed in the <b>middle of the grill</b> and for <b>toasting</b> .
	<b>Dual grill</b>	For <b>grilling</b> flat foodstuffs in <b>large quantities</b> and for <b>toasting</b> .
	<b>Rotitherm</b>	For <b>roasting</b> larger joints of meat or poultry on one level. The function is also suitable for <b>gratinating</b> and <b>browning</b> .

## Inserting the Oven Shelf, Baking Tray and Roasting Pan

### **i** Shelf runner safety and anti-tip device

As a shelf runner safety device, all insertable components have a small curved indentation at the bottom on the right and left-hand edge.

Always insert insertable components so that this indentation is at the back of the oven interior. This indentation is also important for preventing the insertable components from tipping.

#### **Inserting the baking tray or roasting pan**

Push the baking tray or roasting pan between the guide bars of the selected oven level.

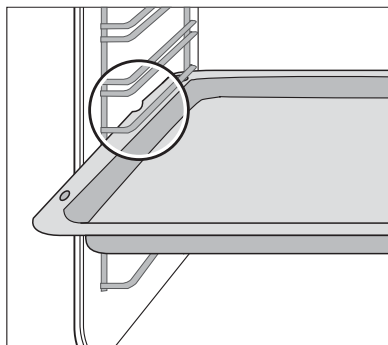

#### **Inserting the oven shelf:**

Insert the oven shelf so that the feet point downwards.

Push the oven shelf between the guide bars of the selected oven level.

**i** The high rim around the oven shelf is an additional device to prevent cookware from slipping.

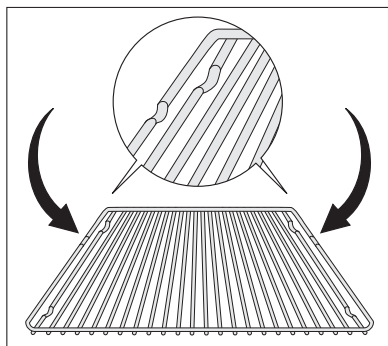



### Inserting the oven shelf and roasting pan together

Lay the oven shelf on the roasting pan.  
Push the roasting pan **between** the guide bars of the selected oven level.

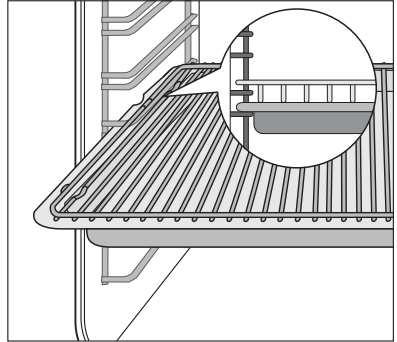

### Inserting/Removing the Grease Filter

**Only use the grease filter when roasting** to protect the rear heating elements from fat splashes.

#### Inserting the grease filter

Hold the grease filter by the grip and insert the two mounts downwards into the opening on the rear wall of the oven (fan opening).

#### Taking out the grease filter

Hold the grease filter by the grip and unhook it.

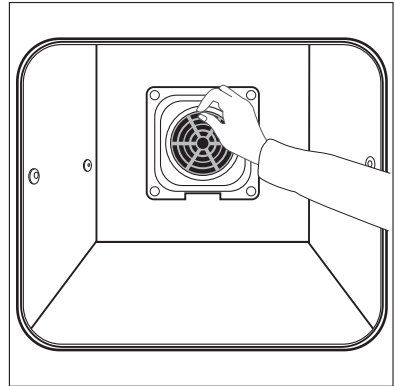

## Additional functions

Either Countdown 🔔 or Meat probe 🍖 can be set.

### Countdown 🔔

To set a countdown.

### Meat probe 🍖

To set a core temperature.

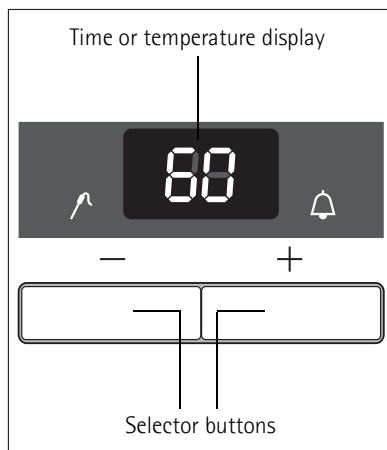

## General Hints

- After a function has been selected, the display flashes for about 5 seconds. While it flashes, the desired time can be set using the + or − buttons.
- When the desired time has been set, the display flashes for another 5 seconds. The set time begins to run.
- Press any of the buttons to stop the signal.
- The desired oven function and temperature can be selected before or after setting the clock functions.
- When cooking is finished, turn the oven and temperature selectors back to zero.

## Countdown



This function has no effect on the operation of the oven.

1. Press any button.  
"0:00" flashes in the display.

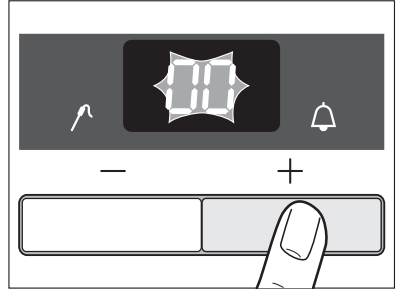

2. Within 5 seconds, set the desired count-down using the  $+$  or  $-$  buttons (max. 99 minutes).  
After 5 seconds the display shows the time remaining.

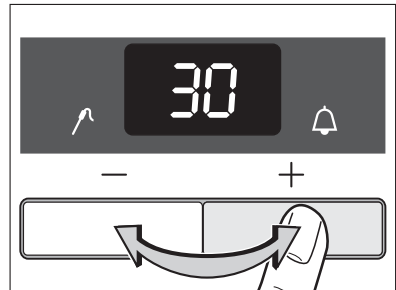

When the time has elapsed, "0.00" is displayed and an audible signal sounds for 2 minutes.

3. The signal can be stopped by pressing any button.

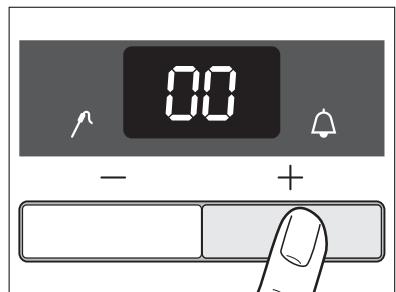

## Meat probe

After a set core temperature is reached, an audible signal sounds.



**The oven is not switched off!**

**There are two temperatures to consider:**

- The oven temperature: see Roasting Table
- Core temperature: see Meat probe Table



**Important:** Only the meat probe supplied may be used. If replacing, only use genuine spare parts.

1. Push the tip of the meat probe right into the meat so that the tip is in the centre of the meat.
2. Insert the meat probe plug into the socket on the side wall of the oven as far as it will go
3. Select desired oven function and temperature.

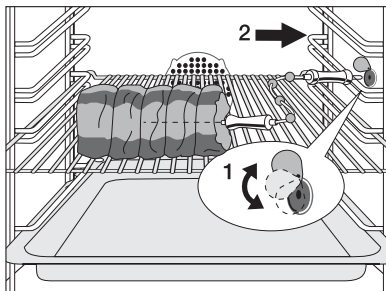

The suggested temperature appears in the display.



The core temperature is displayed once it reaches 30°C and thereafter.

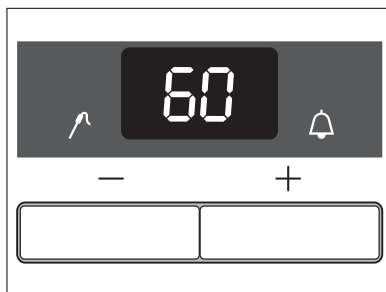

4. Using the  $+$  or  $-$  button, set the desired core temperature.

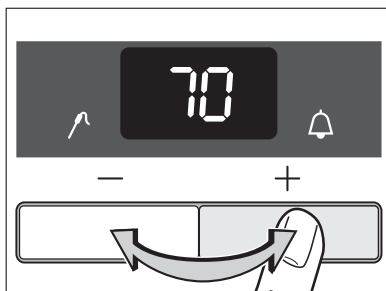

After approx. 5 seconds, the current core temperature is shown in the display.

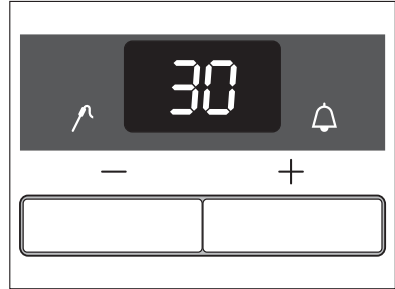

As soon as the actual core temperature has reached the set temperature, an audible signal sounds.

Press any button to switch off the signal.

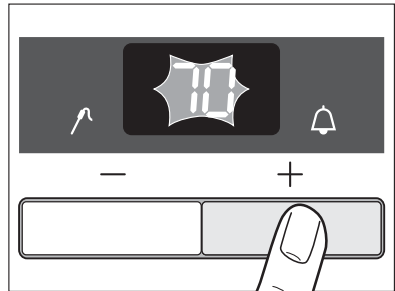

**Warning:** The meat probe is hot! There is a risk of being burned when removing the plug and the tip of the meat probe.



**The oven is not switched off!**

5. Remove the meat probe's plug from the socket and take the meat with the meat probe still inserted out of the oven.
6. Switch off oven functions and temperature.

**Checking or changing the meat core temperature:**

- If you press the **+** or **–** buttons once, the set core temperature is displayed.
- By pressing **+** or **–** several times, it is possible to change the selected temperature subsequently.

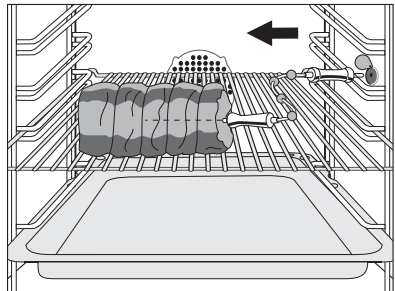

## Mechanical Door Lock

When the appliance is delivered, the door lock is deactivated.

### Activate the door lock

Pull the safety catch forwards until it locks in place.

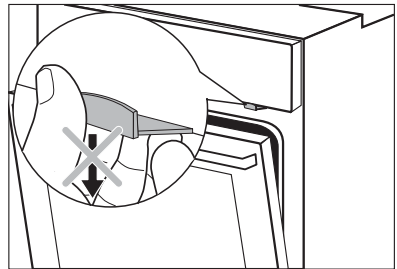
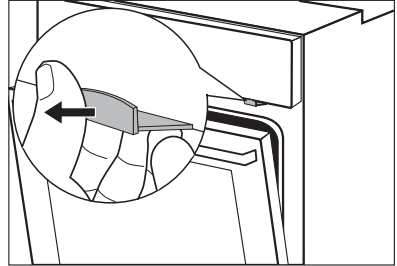

### Open the oven door:

1. Shut the door.
2. Press the safety catch and keep it depressed.
3. Open the doors.

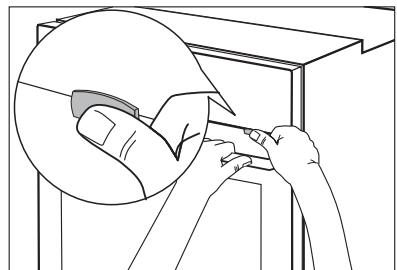

### Close the oven door

Close the door without pressing the safety catch.

### Deactivating the door lock

Press the safety catch back into the panel.



Switching off the appliance does not cancel the mechanical door lock.

# Uses, Tables and Tips

## Cooking table

The information given in the following table is for guidance only.

Heat setting	Cooking-process	suitable for	Cooking time	Tips/Hints
0		Residual heat, Off position		
1	<b>Keeping food warm</b>	Keeping cooked foods warm	as required	Cover
1-2	<b>Melting</b>	Hollandaise sauce, melting butter, chocolate, gelatine	5-25 mins.	Stir occasionally
	<b>Solidifying</b>	Fluffy omelettes, baked eggs	10-40 mins.	Cook with lid on
2-3	<b>Simmering on low heat</b>	Simmering rice and milk-based dishes Heating up ready-cooked meals	25-50 mins.	Add at least twice as much liquid as rice, stir milk dishes part way through cooking
3-4	<b>Steaming Braising</b>	Steaming vegetables, fish braising meat	20-45 mins.	With vegetables add only a little liquid (a few table-spoons)
4-5	<b>Boiling</b>	Steaming potatoes	20-60 mins.	Use only a little liquid, e. g.: max. 1/4 l water for 750 g potatoes
		Cooking larger quantities of food, stews and soups	60-150 mins.	Up to 3 l liquid plus ingredients
6-7	<b>Gentle Frying</b>	Frying escalopes, veal cordon bleu, cutlets, rissoles, sausages, liver, roux, eggs, pancakes, doughnuts	Steady frying	Turn halfway through cooking
7-8	<b>Heavy Frying</b>	Hash browns, loin steaks, steaks, Flädle (pancakes for garnishing soup)	5-15 mins. per pan	Turn halfway through cooking
9	<b>Boiling Searing Deep frying</b>	Boiling large quantities of water, cooking pasta, searing meat (goulash, pot roast), deep frying chips		



We recommend when boiling or searing foods using the highest heat setting at first and then letting foods requiring a longer cooking time finish cooking on the desired heat setting.





Overheated fats and oils can ignite very quickly. Warning! Fire hazard!



## Baking

**Oven function: Convection with ring heating element**  or **Conventional** 

### Baking tins

- For Conventional  dark metal and non-stick tins are suitable.
- For Convection with ring heating element  bright metal tins are also suitable.

### Oven levels

- Baking with Conventional  is possible on one oven level.
- With Convection with ring heating element  you can bake on up to 3 baking trays at the same time:

1 baking tray:

e.g. oven level 3

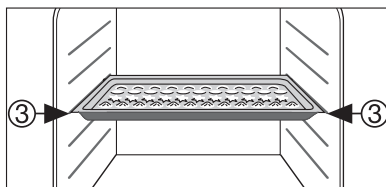

1 cake tin:

e.g. oven level 1

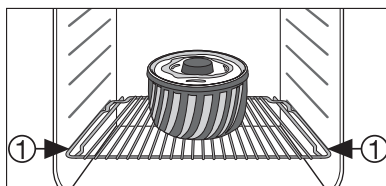

2 baking trays:

z. g., oven levels 1 and 3

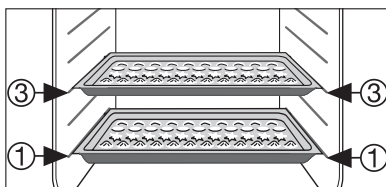

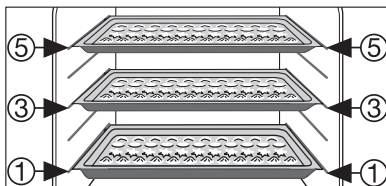

3 baking trays:

oven levels 1, 3 and 5





## General Instructions

- Insert the tray with the bevel at the front.
- With Conventional  or Convection with ring heating element  you can also bake with two tins next to one another on the oven shelf at the same time. This does not significantly increase baking time.



When frozen foods are used the trays inserted may distort during cooking. This is due to the large difference in temperature between the freezing temperature and the temperature in the oven. Once the trays have cooled the distortion will disappear again.

## How to use the Baking Tables

The tables give the required temperature settings, baking times and oven shelf levels for a selection of typical dishes.

- Temperatures and baking times are for guidance only, as these will depend on the consistency of pastry, dough or mixture, the amount and the type of baking tin.
- We recommend using the lower temperature the first time and then if necessary, for example, if a deeper browning is required, or baking time is too long, selecting a higher temperature.
- If you cannot find the settings for a particular recipe, look for the one that is most similar.
- If baking cakes on baking trays or in tins on more than one level, baking time may be extended by 10-15 minutes.
- Moist recipes (for example, pizzas, fruit flans, etc.) are baked on one level.
- Cakes and pastries at different heights may brown at an uneven rate at first. If this occurs, **please do not change the temperature setting**. Different rates of browning even out as baking progresses.
- Your new oven may bake or roast differently to your previous appliance. So adapt your normal settings (temperature, cooking times) and oven shelf levels to the recommendations in the following tables.

































With longer baking times, the oven can be switched off about 10 minutes before the end of baking time, to make use of the residual heat.









Unless otherwise stated, the values given in the tables assume that cooking is started with the oven cold.

## Baking table

### Baking on one oven level

Type of baking	Oven function	Oven level	Temperature °C	Time Hr: Mins.	
<b>Baking in tins</b>					
Ring cake or brioche		Convection with ring heating element	1	150-160	0:50-1:10
Madeira cake/fruit cakes		Convection with ring heating element	1	140-160	1:10-1:30
Sponge cake		Convection with ring heating element	1	140	0:25-0:40
Sponge cake		Conventional	1	160	0:25-0:40
Flan base - short pastry		Convection with ring heating element	3	170-180 <sup>1)</sup>	0:10-0:25
Flan base - sponge mixture		Convection with ring heating element	3	150-170	0:20-0:25
Apple pie		Conventional	1	170-190	0:50-1:00
Apple pie (2 tins Ø20cm, diagonally off set)		Convection with ring heating element	1	160	1:10-1:30
Apple pie (2 tins Ø20cm, diagonally off set)		Conventional	1	180	1:10-1:30
Savoury flan (e. g. quiche lorraine)		Convection with ring heating element	1	160-180	0:30-1:10
Cheesecake		Conventional	1	170-190	1:00-1:30
<b>Cakes/pastries/breads on baking trays</b>					
Plaited bread/bread crown		Conventional	3	170-190	0:30-0:40
Christmas stollen		Conventional	3	160-180 <sup>1)</sup>	0:40-1:00
Bread (rye bread) -first of all -then		Conventional	1	230 <sup>1)</sup> 160-180	0:25 0:30-1:00
Cream puffs/eclairs		Conventional	3	160-170 <sup>1)</sup>	0:15-0:30
Swiss roll		Conventional	3	180-200 <sup>1)</sup>	0:10-0:20



Type of baking		Oven function	Oven level	Temperature °C	Time Hr: Mins.
Cake with crumble topping (dry)		Convection with ring heating element	3	150-160	0:20-0:40
Buttered almond cake/sugar cakes		Conventional	3	190-210 <sup>1)</sup>	0:15-0:30
Fruit flans (made with yeast dough/sponge mixture) <sup>2)</sup>		Convection with ring heating element	3	150	0:35-0:50
Fruit flans (made with yeast dough/sponge mixture) <sup>2)</sup>		Conventional	3	170	0:35-0:50
Fruit flans made with short pastry		Convection with ring heating element	3	160-170	0:40-1:20
Yeast cakes with delicate toppings (e. g, quark, cream, custard)		Conventional	3	160-180 <sup>1)</sup>	0:40-1:20
Pizza (with a lot of topping) <sup>2)</sup>		Convection with ring heating element	1	180-200 <sup>1)</sup>	0:30-1:00
Pizza (thin crust)		Convection with ring heating element	1	200-220 <sup>1)</sup>	0:10-0:25
Unleavened bread		Convection with ring heating element	1	200-220	0:08-0:15
Tarts (CH)		Convection with ring heating element	1	180-200	0:35-0:50
<b>Biscuits</b>					
Short pastry biscuits		Convection with ring heating element	3	150-160	0:06-0:20
Viennese whirls		Convection with ring heating element	3	140	0:20-0:30
Viennese whirls		Conventional	3	160 <sup>1)</sup>	0:20-0:30
Biscuits made with sponge mixture		Convection with ring heating element	3	150-160	0:15-0:20

Type of baking		Oven function	Oven level	Temperature °C	Time Hr: Mins.
Pastries made with egg white, meringues		Convection with ring heating element	3	80-100	2:00-2:30
Macaroons		Convection with ring heating element	3	100-120	0:30-0:60
Biscuits made with yeast dough		Convection with ring heating element	3	150-160	0:20-0:40
Puff pastries		Convection with ring heating element	3	170-180 <sup>1)</sup>	0:20-0:30
Rolls		Convection with ring heating element	3	160 <sup>1)</sup>	0:20-0:35
Rolls		Conventional	3	180 <sup>1)</sup>	0:20-0:35
Small cakes (20 per tray)		Convection with ring heating element	3	140 <sup>1)</sup>	0:20-0:30
Small cakes (20 per tray)		Conventional	3	170 <sup>1)</sup>	0:20-0:30

1) Pre-heat the oven

2) Use the drip tray or roasting tray

## Baking on more than one oven level

Type of baking	Convection with ring heating element 	Convection with ring heating element 	Temperature in °C	Time Hours: Mins.
	Shelf positions from bottom			
	2 levels	3 levels		
<b>Cakes/pastries/breads on baking trays</b>				
Cream puffs/Eclairs	1 / 4	---	160-180 <sup>1)</sup>	0:35-0:60
Dry streusel cake	1 / 3	---	140-160	0:30-0:60
<b>Biscuits/small cakes/pastries/rolls</b>				
Short pastry biscuits	1 / 3	1 / 3 / 5	150-160	0:15-0:35
Viennese whirls	1 / 3	1 / 3 / 5	140	0:20-0:60
Biscuits made with sponge mixture	1 / 3	---	160-170	0:25-0:40
Biscuits made with egg white, meringues	1 / 3	---	80-100	2:10-2:50
Macaroons	1 / 3	---	100-120	0:40-1:20
Biscuits made with yeast dough	1 / 3	---	160-170	0:30-0:60
Puff pastries	1 / 3	---	170-180 <sup>1)</sup>	0:30-0:50
Rolls	1 / 4	---	160	0:30-0:55
Small cakes (20 per tray)	1 / 4	---	140 <sup>1)</sup>	0:25-0:40

1) Pre-heat the oven

## Tips on Baking







Baking results	Possible cause	Remedy
The cake is not browned enough underneath	Wrong oven level	Place cake lower
The cake sinks (becomes soggy, lumpy, streaky)	Oven temperature too high	Use a slightly lower setting
	Baking time too short	Set a longer baking time <b>Baking times cannot be reduced by setting higher temperatures</b>
	Too much liquid in the mixture	Use less liquid. Pay attention to mixing times, especially if using mixing machines
Cake is too dry	Oven temperature too low	Set oven temperature higher.
	Baking time too long	Set a shorter baking time
Cake browns unevenly	Oven temperature too high and baking time too short	Set a lower oven temperature and a longer baking time
	Mixture is unevenly distributed	Spread the mixture evenly on the baking tray
	Grease filter is inserted	Take out the grease filter
Cake does not cook in the baking time given	Temperature too low	Use a slightly higher oven setting
	Grease filter is inserted	Take out the grease filter

## Table Pizza setting

Type of baking	Shelf position	Temperature °C	Time Hr: Mins.
Pizza (thin crust)	1	180 - 200 <sup>1)</sup>	20 - 30
Pizza (with a lot of topping)	1	180 - 200	20 - 30
Tarts	1	180 - 200	45 - 60
Spinach flan	1	160 - 180	45 - 60
Quiche Lorraine	1	170 - 190	40 - 50
Quark flan, round	1	140 - 160	60 - 90
Quark flan on tray	1	140 - 160	50 - 60
Apple cake, covered	1	150 - 170	50 - 70
Vegetable pie	1	160 - 180	50 - 60
Unleavened bread	1	250 - 270 <sup>1)</sup>	10 - 20
Puff pastry flan	1	160 - 180 <sup>1)</sup>	40 - 50
Flammekuchen (Pizza-like dish from Alsace)	1	250 - 270 <sup>1)</sup>	12 - 20
Piroggen (Russian version of calzone)	1	180 - 200 <sup>1)</sup>	15 - 25

1) Pre-heat the oven





## Table for Bakes and Gratins

Dish	Oven function	Shelf position	Temperature °C	Time Hr: Mins.
Pasta bake	 Conventional	1	180-200	0:45-1:00
Lasagne	 Conventional	1	180-200	0:25-0:40
Vegetables au gratin <sup>1)</sup>	 Convection with ring heating element	1	160-170	0:15-0:30
Baguettes topped with melted cheese <sup>1)</sup>	 Convection with ring heating element	1	160-170	0:15-0:30
Sweet bakes	 Conventional	1	180-200	0:40-0:60
Fish bakes	 Conventional	1	180-200	0:30-1:00
Stuffed vegetables	 Convection with ring heating element	1	160-170	0:30-1:00

1) Pre-heat the oven



## Frozen Ready Meals Table

Food to be cooked	Oven function	Shelf position	Temperature °C	Time
Frozen pizza	 Conventional	3	as per manufacturer's instructions	as per manufacturer's instructions
Chips <sup>1)</sup> (500 g)	 Convection with ring heating element	3	200-220	as per manufacturer's instructions
Baguettes	 Conventional	3	as per manufacturer's instructions	as per manufacturer's instructions
Fruit flans	 Conventional	3	as per manufacturer's instructions	as per manufacturer's instructions

1) Comments: Turn chips 2 or 3 times during cooking

## Roasting

Oven function: Conventional  or Rotitherm 

### Roasting dishes

- Any heat-resistant ovenware is suitable to use for roasting (please read the manufacturer's instructions).
- Large roasting joints can be roasted **directly in the roasting tray or on the oven shelf with the roasting tray placed below it.**
- For all lean meats, we recommend **roasting these in a roasting tin with a lid.** This will keep the meat more succulent.
- All types of meat, that can be browned or have crackling, can be roasted in the **roasting tin without the lid.**

























### Tips on using the roasting chart

The information given in the following table is for guidance only.

- We recommend cooking meat and fish **weighing 1 kg and above in the oven.**
- To prevent escaping meat juices or fat from burning on to the pan, we recommend placing some liquid in the roasting pan.
- If required, turn the roast (after 1/2 - 2/3 of the cooking time).
- Baste large roasts and poultry with their juices several times during roasting. This will give better roasting results.
- You can switch the oven off about 10 minutes before the end of the roasting time, in order to utilise the residual heat.

## Roasting table

Type of meat	Quantity	Ovenfunction	Shelf position	Temperature °C	Time Hours mins.	
<b>Beef</b>						
Pot roast	1-1.5 kg		Conventional	1	200-250	2:00-2:30
Roast beef or fillet	per cm. of thickness		Rotitherm	1	190-200 <sup>1)</sup>	per cm. of thickness
- rare						0:05-0:06
- medium						0:06-0:08
- well done	per cm. of thickness		Rotitherm	1	170-180	0:08-0:10
<b>Pork</b>						
Shoulder, neck, ham joint	1-1.5 kg		Rotitherm	1	160-180	1:30-2:00
Chop, spare rib	1-1.5 kg		Rotitherm	1	170-180	1:00-1:30
Meat loaf	750 g-1 kg		Rotitherm	1	160-170	0:45-1:00
Porkknuckle (pre-cooked)	750 g-1 kg		Rotitherm	1	150-170	1:30-2:00
<b>Veal</b>						
Roast veal	1 kg		Rotitherm	1	160-180	1:30-2:00
Knuckle of veal	1.5-2 kg		Rotitherm	1	160-180	2:00-2:30
<b>Lamb</b>						
Leg of lamb, roast lamb	1-1.5 kg		Rotitherm	1	150-170	1:15-2:00
Saddle of lamb	1-1.5 kg		Rotitherm	1	160-180	1:00-1:30
<b>Game</b>						
Saddle of hare, leg of hare	up to 1 kg		Conventional	3	220-250 <sup>1)</sup>	0:25-0:40
Saddle of venison	1.5-2 kg		Conventional	1	210-220	1:15-1:45
Haunch of venison	1.5-2 kg		Conventional	1	200-210	1:30-2:15

Type of meat	Quantity	Ovenfunction	Shelf position	Temperature °C	Time Hours mins.
<b>Poultry</b>					
Poultry portions	200-250g each	 Rotitherm	1	200-220	0:35-0:50
Half chicken	400-500g each	 Rotitherm	1	190-210	0:35-0:50
Chicken, poulard	1-1.5 kg	 Rotitherm	1	190-210	0:45-1:15
Duck	1.5-2 kg	 Rotitherm	1	180-200	1:15-1:45
Goose	3.5-5 kg	 Rotitherm	1	160-180	2:30-3:30
Turkey	2.5-3.5 kg	 Rotitherm	1	160-180	1:45-2:30
Turkey	4-6 kg	 Rotitherm	1	140-160	2:30-4:00
<b>Fish (steamed)</b>					
Whole fish	1-1.5 kg	 Conventional	1	210-220	0:45-1:15

1) Pre-heat the oven

## Meat probe Table

Food to be Cooked	Meat Core Temperature
<b>Beef</b>	
Rib steak or fillet steak rare	45 - 50 °C
medium	60 - 65 °C
well done	75 - 80 °C
<b>Pork</b>	
Shoulder of pork, ham joint, neck	80 - 82 °C
Chop (saddle), smoked pork loin	75 - 80 °C
Meat loaf	75 - 80 °C
<b>Veal</b>	
Roast veal	75 - 80 °C
Knuckle of veal	85 - 90 °C
<b>Mutton / lamb</b>	
Leg of mutton	80 - 85 °C
Saddle of mutton	80 - 85 °C
Roast lamb, leg of lamb	75 - 80 °C
<b>Game</b>	
Saddle of hare	70 - 75 °C
Leg of hare	70 - 75 °C
Whole hare	70 - 75 °C
Saddle of venison	70 - 75 °C
Leg of venison	70 - 75 °C

## Grill Sizes

Oven function: Grill  or Dual grill  with maximum temperature setting



**Important:** Always grill with the oven door closed.



The empty oven should **always be pre-heated with the grill functions for 5 minutes.**

- For grilling, place the **shelf** in the **recommended shelf position.**
- Always insert the **tray for collecting the fat** into the **first shelf position** from the bottom.
- The grilling times are guidelines.
- Grilling is particularly suitable for flat pieces of meat or fish.

## Grilling table

Food to be grilled	Oven level	Grilling time	
		1st side	2nd side
Burgers	4	8-10 mins.	6-8 mins.
Pork fillet	4	10-12 mins.	6-10 mins.
Sausages	4	8-10 mins.	6-8 mins.
Fillet steaks, veal steaks	4	6-7 mins.	5-6 mins.
Fillet of beef, roast beef (approx. 1 kg)	3	10-12 mins.	10-12 mins.
Toast <sup>1)</sup>	3	4-6 mins.	3-5 mins.
Toast with topping	3	6-8 mins.	---

1) Do not pre-heat

## Defrosting

Oven function: Defrost  (no temperature setting)

- Unwrap the food and place it on a plate on the oven shelf.
- Do not cover with a plate or bowl, as these can substantially lengthen the defrosting time.
- For defrosting, place the shelf in the **1st oven level from the bottom**.

## Defrosting table

Dish	Defrosting time mins.	Further defrosting time (mins.)	Comments
Chicken, 1000 g	100-140	20-30	Place the chicken on an upturned saucer placed on a large plate Turn halfway through
Meat, 1000 g	100-140	20-30	Turn halfway through
Meat, 500 g	90-120	20-30	Turn halfway through
Trout, 150g	25-35	10-15	---
Strawberries, 300g	30-40	10-20	---
Butter, 250g	30-40	10-15	---
Cream, 2 x 200g	80-100	10-15	Cream can also be whipped when still slightly frozen in places
Gateau, 1400g	60	60	---

## Drying

### Oven function: Convection with ring heating element

- Use oven shelves covered with greaseproof paper or baking parchment.
- You get a better result if you switch the oven off halfway through the drying time, open the door and leave the oven to cool down overnight.
- After this finish drying the food to be dried.

Food to be dried	Temperature in °C	Oven level		Time in hours (Guideline)
		1 level	2 levels	
<b>Vegetables</b>				
Beans	60-70	3	1 / 4	6-8
Peppers (strips)	60-70	3	1 / 4	5-6
Vegetables for soup	60-70	3	1 / 4	5-6
Mushrooms	50-60	3	1 / 4	6-8
Herbs	40-50	3	1 / 4	2-3
<b>Fruit</b>				
Plums	60-70	3	1 / 4	8-10
Apricots	60-70	3	1 / 4	8-10
Apple slices	60-70	3	1 / 4	6-8
Pears	60-70	3	1 / 4	6-9



## Making Preserves

### Oven function: Bottom heat

- For preserving, use only commercially available preserve jars of the same size.
- **Jars with twist-off or bayonet type lids and metal tins are not suitable.**
- When making preserves, the **first shelf position from the bottom** is the one most used.
- Use the shelf for making preserves. There is enough room on this for up to six 1-litre preserving jars.
- The jars should all be filled to the same level and clamped shut.
- Place the jars on the baking tray in such a way that they are not touching each other.
- Pour approx. 1/2 litre of water into the baking tray so that sufficient moisture is produced in the oven.
- As soon as the liquid starts to pearl in the first jars (after about 35-60 minutes with 1 litre jars), switch the oven off or reduce the temperature to 100 °C (see table).

## Preserves table

The times and temperatures for making preserves are for guidance only.

Preserve	Temperature in °C	Cooking time until simmering in mins.	Continue to cook at 100 °C in mins.
<b>Soft fruit</b>			
Strawberries, blueberries, raspberries, ripe gooseberries	160-170	35-45	---
Unripe gooseberries	160-170	35-45	10-15
<b>Stone fruit</b>			
Pears, quinces, plums	160-170	35-45	10-15
<b>Vegetables</b>			
Carrots <sup>1)</sup>	160-170	50-60	5-10
Mushrooms <sup>1)</sup>	160-170	40-60	10-15
Cucumbers	160-170	50-60	---
Mixed pickles	160-170	50-60	15
Kohlrabi, peas, asparagus	160-170	50-60	15-20
Beans	160-170	50-60	---

1) Leave standing in oven when switched off

## Cleaning and Care



**Warning:** First switch off the appliance and let it cool down before carrying out any cleaning.

**Warning:** For safety reasons, do **not** clean the appliance with steam blasters or high-pressure cleaners.

**Attention:** Do not use any corrosive cleaning fluids, sharp objects or stain removers.

Do not clean the glass oven door with abrasive fluids or metal scrapers, which could scratch the surface. The glass could crack and shatter.

### Outside of the appliance

- Wipe the front of the appliance with a soft cloth and a solution of hot water and washing up liquid.
- For metal fronts, use normal commercially available cleaning agents.
- Please do not use scouring agents and abrasive sponges.

### Oven interior

Clean the appliance after each use. In this way, dirt is easier to clean off and is not allowed to burn on.

1. For cleaning, turn the oven light on.
2. After every use, wipe the oven with a solution of washing-up liquid and allow to dry.



Clean stubborn dirt with a special oven cleaner.



**Important:** If using an oven spray, please follow the manufacturer's instructions exactly.

### Accessories

Wash all slide-in units (shelf unit, baking tray, shelf support rails etc.) after each use and dry well. Soak briefly to make them easier to clean.

### Fat Filter

1. Clean the fat filter in hot water and washing up liquid or in the dishwasher.
2. Badly burned on soiling can be removed by boiling the filter in a little water to which 2-3 tablespoonsful of dishwasher cleaner has been added.

## Shelf Support Rails

The shelf support rails on the left and right hand sides of the oven can be removed for cleaning the side walls.

### Removing the shelf support rails

First pull the front of the rail away from the oven wall (1) and then unhitch at the back (2).

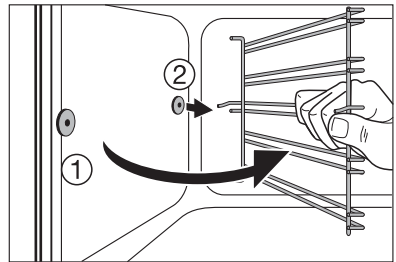
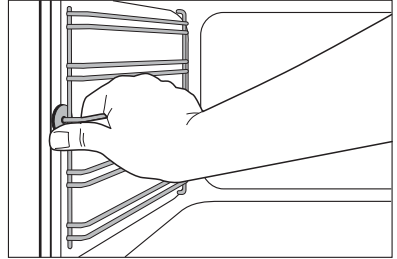

### Fitting the shelf support rails



**Important!** The rounded ends of the guide rails must be pointing forwards!

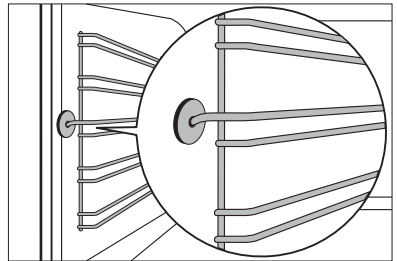

To re-insert, first hook the rail into place at the back (1) and then insert the front and press into place (2).

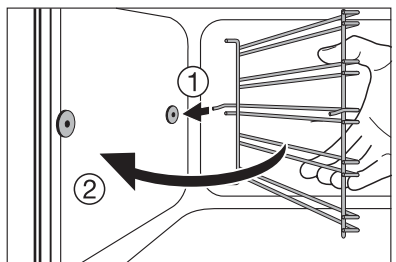

## Oven Lighting



**Warning:** There is a danger of electric shock! Prior to changing the oven light bulb:

- Switch off the oven!
- Remove the fuses in the fuse box or switch off the circuit breaker.



Place a cloth on the oven floor to protect the oven light and glass cover.

### Replacing the oven light bulb/cleaning the glass cover

1. Remove the glass cover by turning it anti-clockwise and then clean it.
2. If necessary:  
**Replace bulb with a 40 watt, 230 V, 300 °C heat-resistant oven light bulb.**
3. Refit the glass cover.

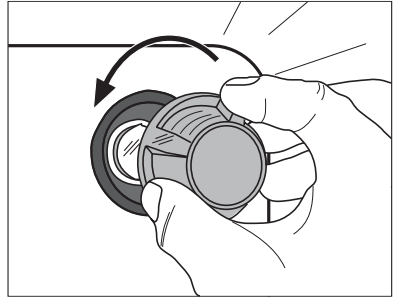

## Oven Ceiling

The upper heating element can be folded down to make it easier to clean the oven ceiling.

### Folding down the heating element



**Warning:** Only fold down the heating element when the oven is switched off and there is no risk of being burnt!

1. Remove the side shelf support rails.
2. Grip the heating element at the front and pull it forwards and out over the support lug on the inner wall of the oven.
3. The heating element will now fold down.



**Caution:** Do not use force to press the heating element down! The heating element might break.

### Cleaning the oven ceiling

#### Repositioning the heating element

1. Move the heating element back up towards the oven ceiling.
2. Pull the heating element forwards against the spring pressure and guide it over the oven support lug.
3. Settle it onto the support.
4. Insert shelf support rail.



**Important:** The heating element must be positioned correctly and securely on both sides above the support lug on the inner wall of the oven.

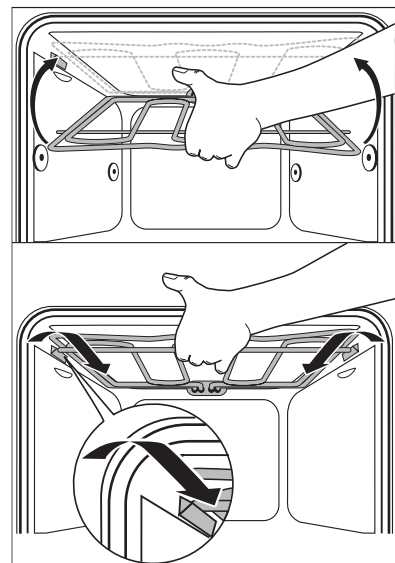
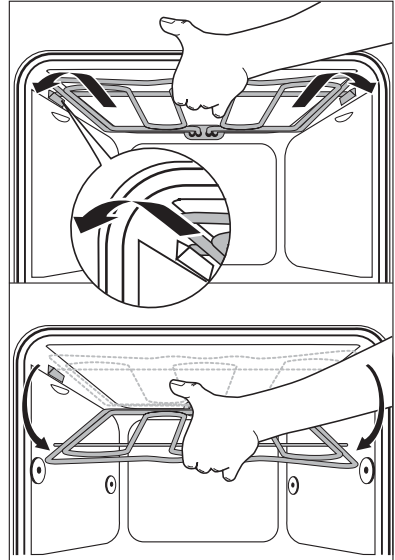

## Oven door

For easier cleaning of the oven interior the oven door of your appliance can be taken off its hinges.

### Removing the oven door from its hinges

1. Open the oven door as far as it will go.

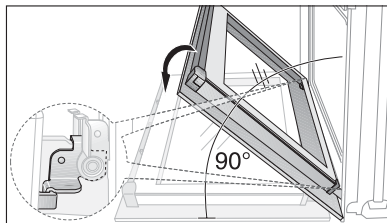

2. Undo the **clamping levers (A)** on both door hinges **fully**.

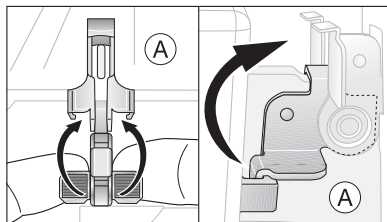

3. Close the oven door as far as the first position (approx. 45°).

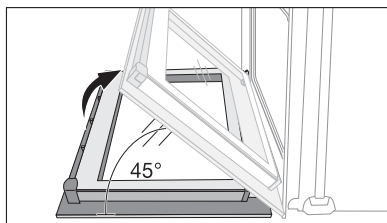

4. Take hold of the oven door with a hand on each side and pull it away from the oven at an upwards angle (**Take care:** It is heavy).

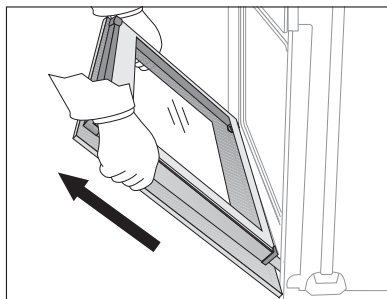

Lay the oven door with the outer side facing downwards on something soft and level, for example, a blanket in order to prevent scratches.

## Hanging the oven door back on its hinges

1. From the handle side take hold of the oven door with a hand on each side and hold at an angle of approx. 45°. Position the recesses on the bottom of the oven door on the hinges on the oven. Let the door slide down as far as it will go.

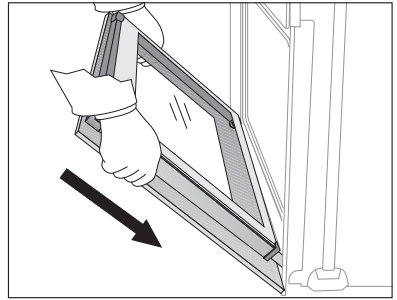

2. Open the oven door as far as it will go.

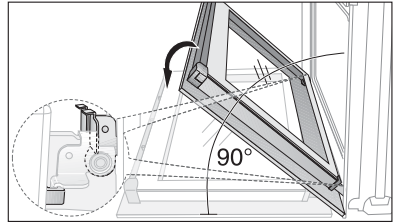

3. Fold up the clamping levers (A) on both door hinges back into their original positions.

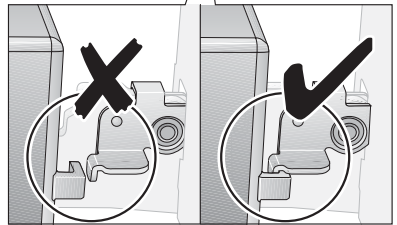
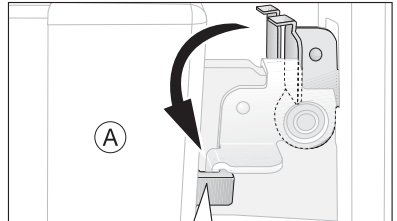

4. Close the oven door.

## Oven door glass

The oven door is fitted with three panels of glass mounted one behind the other. The inner panels can be removed for cleaning.



**Important!** Rough handling, especially around the edges of the front panel, can cause the glass to break.

### Removing the door glass panels

1. Open the oven door as far as it will go.

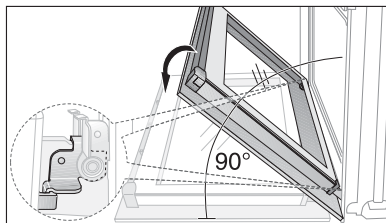

2. Undo the **clamping levers (A)** on both **door hinges** fully

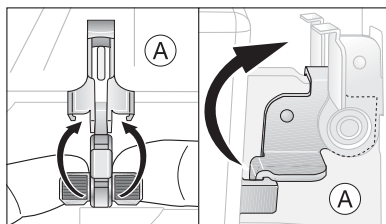

3. Close the oven door as far as the first position (approx. 45°).

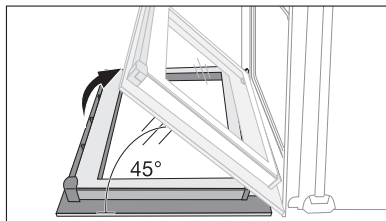



4. Take hold of the door trim (B) on the upper edge of the door at both sides and press inwards to release the clip seal. Then remove the door trim by pulling it upwards.

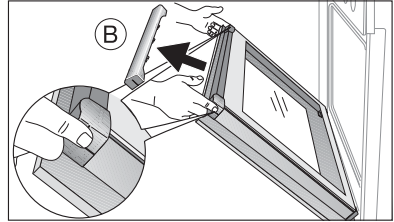

5. Take hold of the door glass panels on their upper edge one after the other and take them out of the guide by pulling them upwards.

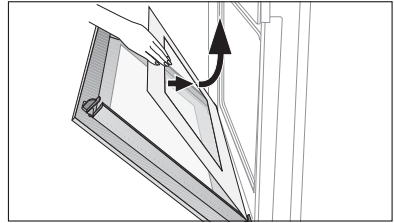

### Cleaning the door glass panels

Clean the door glass panels thoroughly with a solution of water and washing up liquid. Then dry them carefully

### Putting the door glass panels back.

1. From above insert the door glass panels at an angle into the door profile at the bottom edge of the door one after the other and lower them.

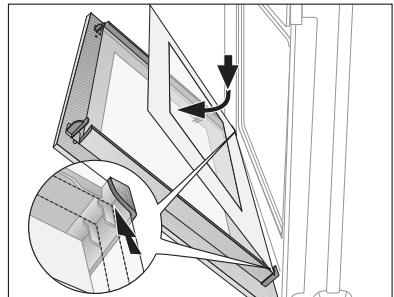

Insert the smaller panel first, then the larger panel.

2. Take hold of the door trim (B) at each side, position it on the inside edge of the door and plug the door trim (B) into the upper edge of the door

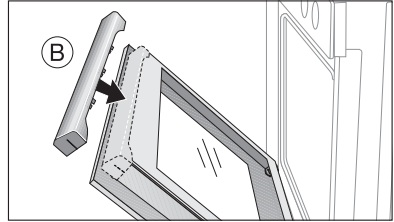

On the open side of the door trim (B) there is a guide bar (C). This must be pushed between the outer door panel and the guide corner (D). The clip seal (E) must be snapped in.

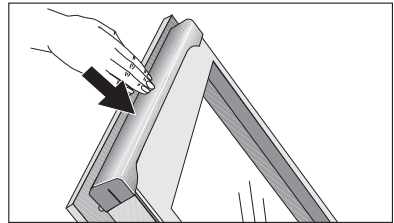
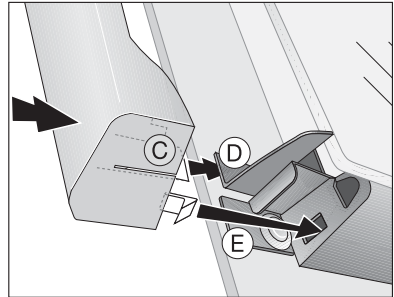

3. Open the oven door as far as it will go

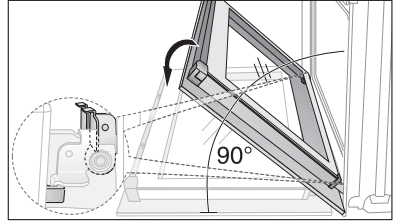

4. Fold up the clamping levers (A) on both door hinges back into their original positions

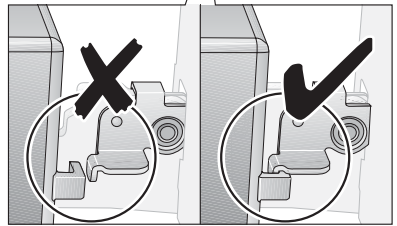
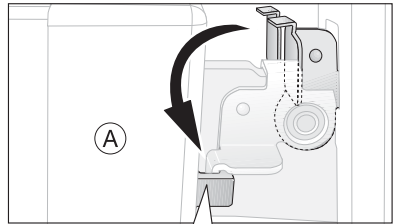

5. Close the oven door.

## What to do if ...

Problem	Possible cause	Remedy
The cooking zones are not working	Consult the instruction manual for the built-in range	
The oven does not heat	The oven has not been switched on	Switch the oven on
	The required settings have not been made	Check the settings
	The domestic electrical protection device (fuse) has been tripped	Check the fuses or protection devices. If these are tripped repeatedly, you should call a qualified electrician.
"F2" appears in the display	The meat probe plug is not fitted properly into the socket	Insert the meat probe plug as far as it will go into the socket on the side wall of the oven.
The oven light does not come on	The bulb has blown	Replace the bulb

**If you are unable to remedy the problem by following the above suggestions, please contact your dealer or the Customer Care Department.**



**Warning!** Repairs to the appliance are only to be carried out by qualified service engineers. Considerable danger to the user may result from improper repairs.



If the appliance has been wrongly operated, the visit from the customer service technician or dealer may not take place free of charge, even during the warranty period.



### Advice on cookers with metal fronts:

Because of the cold surface at the front of the cooker, opening the oven door during (or just after) baking or roasting may cause the glass to steam up.

# Disposal



## Packaging material

The packaging materials are environmentally friendly and can be recycled. The plastic components are identified by markings, e.g. >PE<, >PS<, etc. Please dispose of the packaging materials in the appropriate container at the community waste disposal facilities.



## Old appliance

The symbol  on the product or on its packaging indicates that this product may not be treated as household waste. Instead it shall be handed over to the applicable collection point for the recycling of electrical and electronic equipment. By ensuring this product is disposed of correctly, you will help prevent potential negative consequences for the environment and human health, which could otherwise be caused by inappropriate waste handling of this product. For more detailed information about recycling of this product, please contact your local city office, your household waste disposal service or the shop where you purchased the product.



**Warning:** So that the old appliance can no longer cause any danger, make it unusable before disposing of it.

**To do this, disconnect the appliance from the mains supply and remove the mains cable from the appliance.**

# Installation Instructions



**Attention:** The new appliance may only be installed and connected by a **registered expert**.

Please comply with this. If you do not, any damage resulting is not covered by the warranty.



## Safety information for the installer

- The electrical installation is to be set up so that the appliance can be isolated from the mains with a minimum 3mm all-pole contact separation. Suitable separation devices include e.g. cut-outs, fuses (screw fuses are to be taken out of the holder), RCD's and contactors.
- Anti-shock protection must be provided by the installation.
- The built-in unit must meet the stability requirements of DIN 68930.
- Built-in ovens and built-in cooking surfaces are fitted with special connection systems. For safety reasons, they must only be combined with appliances from the same manufacturer.

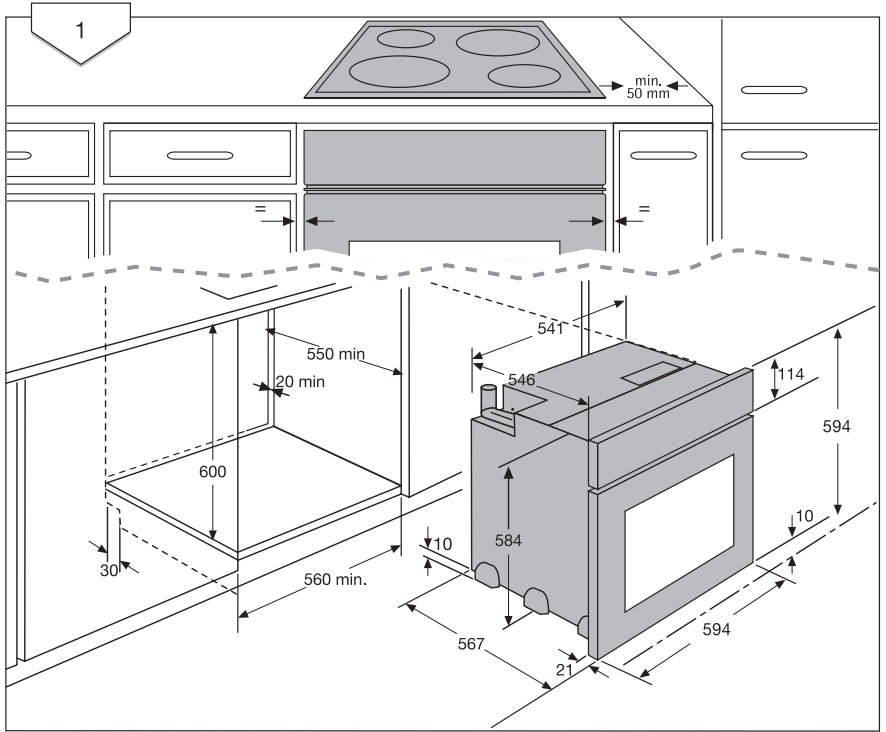



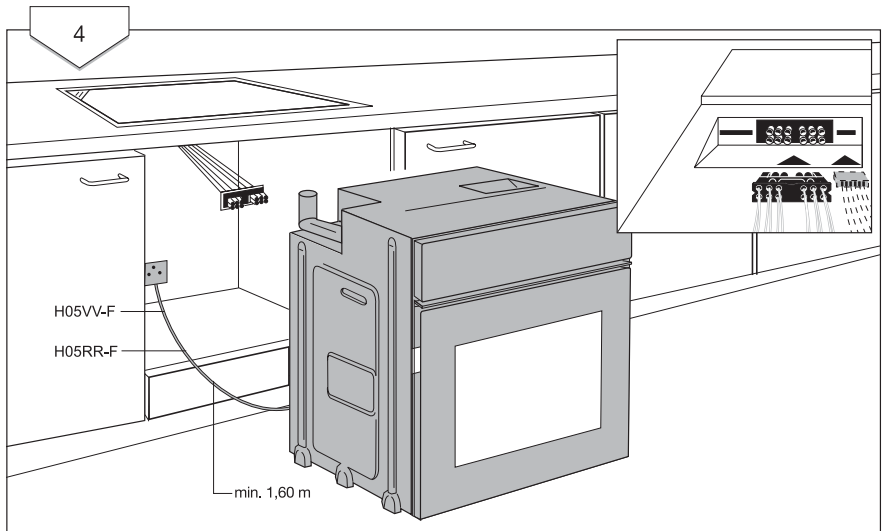
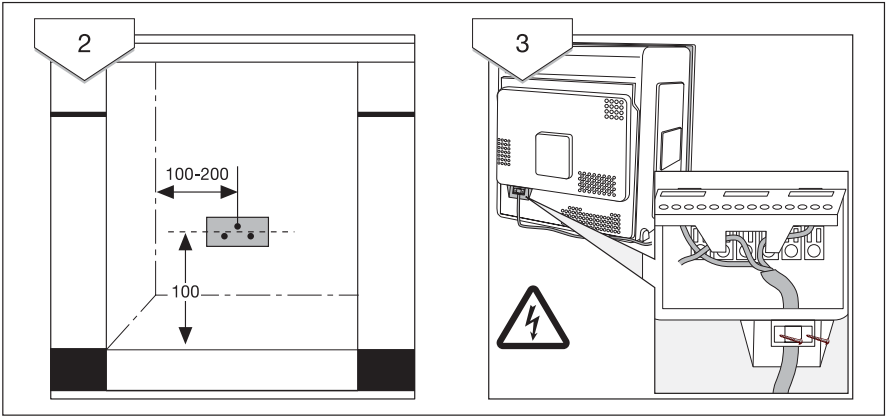

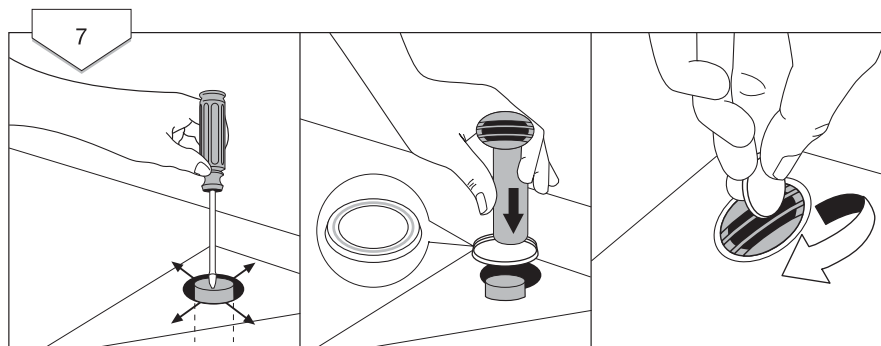
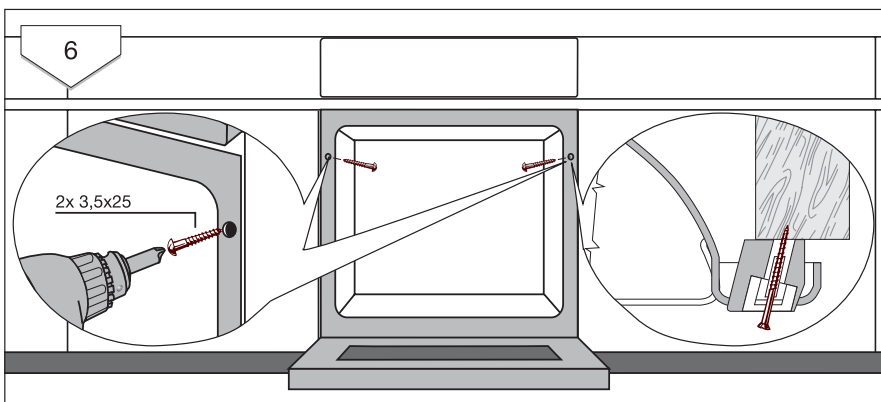
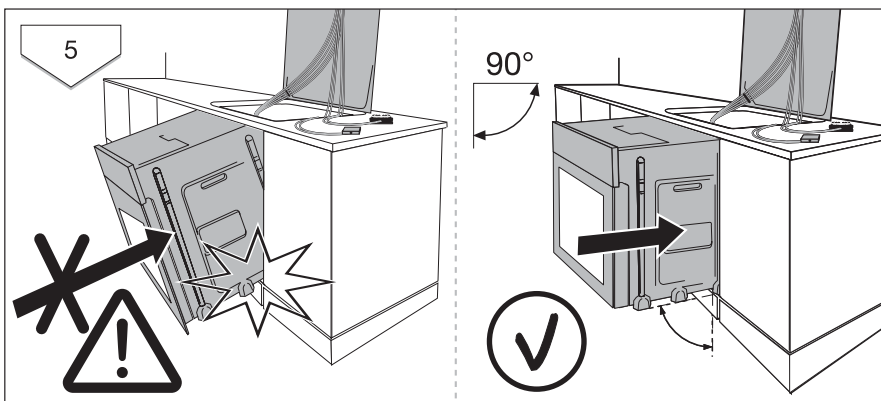

Ausbau/Removal

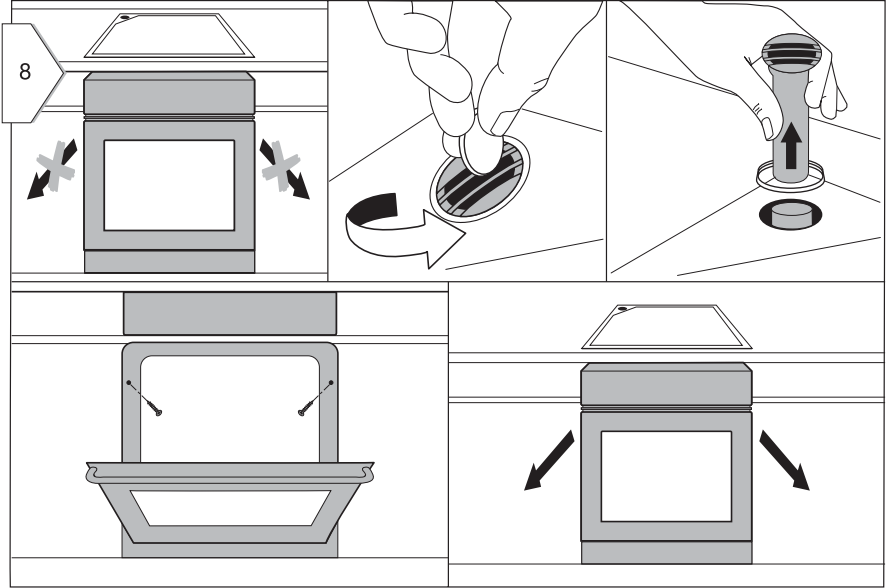

# Guarantee/Customer Service

## European Guarantee

This appliance is guaranteed by Electrolux in each of the countries listed at the back of this user manual, for the period specified in the appliance guarantee or otherwise by law. If you move from one of these countries to another of the countries listed below the appliance guarantee will move with you subject to the following qualifications:

- The appliance guarantee starts from the date you first purchased the appliance which will be evidenced by production of a valid purchase document issued by the seller of the appliance.
- The appliance guarantee is for the same period and to the same extent for labour and parts as exists in your new country of residence for this particular model or range of appliances.
- The appliance guarantee is personal to the original purchaser of the appliance and cannot be transferred to another user.
- The appliance is installed and used in accordance with instructions issued by Electrolux and is only used within the home, i.e. is not used for commercial purposes.
- The appliance is installed in accordance with all relevant regulations in force within your new country of residence.

The provisions of this European Guarantee do not affect any of the rights granted to you by law.

www.electrolux.com

		
Albania	+35 5 4 261 450	Rr. Pjeter Bogdani Nr. 7 Tirane
Belgique/België/ Belgien	+32 2 363 04 44	Bergensesteenweg 719, 1502 Lembeek
Česká republika	+420 2 61 12 61 12	Budějovická 3, Praha 4, 140 21
Danmark	+45 70 11 74 00	Sjællandsgade 2, 7000 Fredericia
Deutschland	+49 180 32 26 622	Muggenhofer Str. 135, 90429 Nürnberg
Eesti	+37 2 66 50 030	Mustamäe tee 24, 10621 Tallinn
España	+34 902 11 63 88	Carretera M-300, Km. 29,900 Alcalá de Henares Madrid
France	www.electrolux.fr	
Great Britain	+44 8705 929 929	Addington Way, Luton, Bedfordshire LU4 9QQ
Hellas	+30 23 10 56 19 70	4 Limnou Str., 54627 Thessaloniki
Hrvatska	+385 1 63 23 338	Slavonska avenija 3, 10000 Zagreb
Ireland	+353 1 40 90 753	Long Mile Road Dublin 12
Italia	+39 (0) 434 558500	C.so Lino Zanussi, 26 - 33080 Porcia (PN)
Latvija	+37 17 84 59 34	Kr. Barona iela 130/2, LV-1012, Riga
Lithuania	+3702780607	<b>Žirmūnų 67, LT-09001 Vilnius</b>
Luxembourg	+352 42 431 301	Rue de Bittbourg, 7, L-1273 Hamm
Magyarország	+36 1 252 1773	H-1142 Budapest XIV, Erzsébet királyné útja 87
Nederland	+31 17 24 68 300	Vennootsweg 1, 2404 CG - Alphen aan den Rijn
Norge	+47 81 5 30 222	Risløkkvn. 2 , 0508 Oslo
Österreich	+43 18 66 400	Herziggasse 9, 1230 Wien
Polska	+48 22 43 47 300	ul. Kolejowa 5/7, Warszawa
Portugal	+35 12 14 40 39 39	Quinta da Fonte - Edifício Gonçalves Zarco - Q 35 2774 - 518 Paço de Arcos
Romania	+40 21 451 20 30	Str. Garii Progresului 2, S4, 040671 RO
Schweiz/Suisse/ Svizzera	+41 62 88 99 111	Industriestrasse 10, CH-5506 Mägenwil
Slovenija	+38 61 24 25 731	Electrolux Ljubljana d.o.o. Gerbičeva 98, 1000 Ljubljana
Slovensko	+421 2 43 33 43 22	Electrolux Slovakia s.r.o., Electrolux Domáce spot- rebiče SK, Seberínho 1, 821 03 Bratislava
Suomi	www.electrolux.fi	

		
Sverige	+46 (0)771 76 76 76	Electrolux Service, S:t Göransgatan 143, S-105 45 Stockholm
Türkiye	+90 21 22 93 10 25	Tarlabası caddesi no : 35 Taksim Istanbul
Россия	+7 495 937 7837	129090 Москва, Олимпийский проспект, 16, БЦ „Олимпик“

# Service

In the event of technical faults, please first check whether you can remedy the problem yourself with the help of the operating instructions (section "What to do if...").

If you were not able to remedy the problem yourself, please contact the Customer Care Department or one of our service partners.

In order to be able to assist you quickly, we require the following information:

- Model description
- Product number (PNC)
- Serial number (S No.)  
(for numbers see rating plate)
- Type of fault
- Any error messages displayed by the appliance

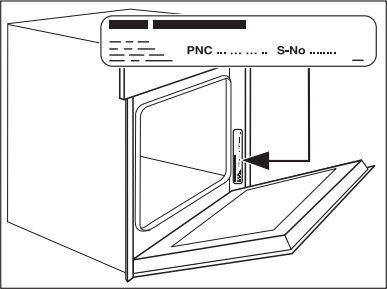

So that you have the necessary reference numbers from your appliance at hand, we recommend that you write them in here:

Model description: .....

PNC: .....

S No: .....

822 929 732-M-170707-01 Subject to change without notice