

# COMPETENCE D5701-5

Built-in Electric Multifunction Double Oven

Installation and Operating Instructions

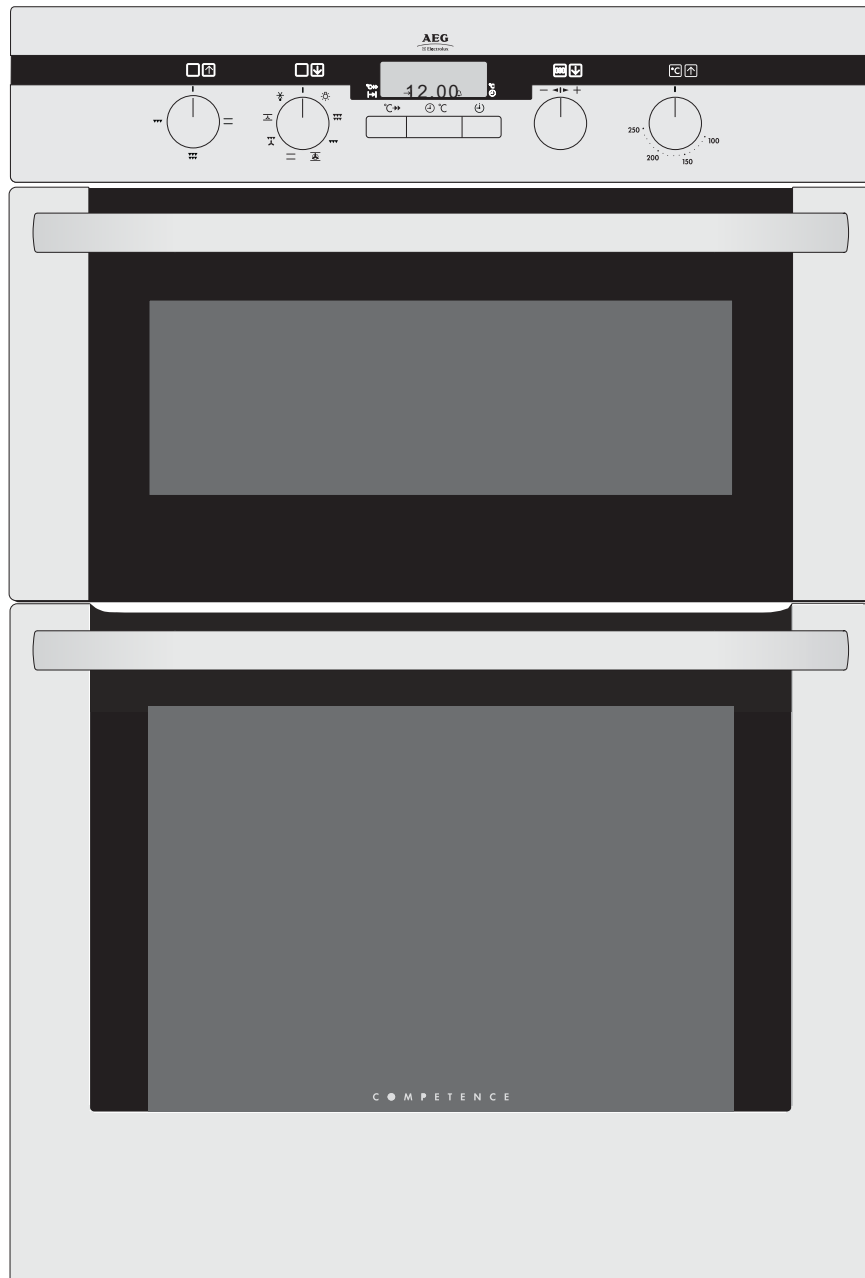

PERFEKT IN FORM UND FUNKTION

**AEG**  
Electrolux

## IMPORTANT SAFETY INFORMATION

These warnings are provided in the interests of your safety. Ensure that you understand them all before installing or using the appliance. Your safety is of paramount importance. If you are unsure about any of the information in this book contact the Customer Care Department.

### INSTALLATION

The appliance **must** be installed according to the instructions supplied. The installation work must be undertaken by a qualified electrician or competent person.

The appliance should be serviced by an authorised Service Engineer and only genuine approved spare parts should be used.

The appliance **must** be installed in an adequately ventilated room.

It is imperative that the appliance is left in the base to protect both the appliance and the floor.

This appliance is heavy and care **must** be taken when moving it.

**Do not** attempt to lift or move this appliance by the handles.

All packaging, both inside and outside the appliance **must** be removed before the appliance is used.

It is dangerous to alter the specifications or modify the appliance in any way.

After installation please dispose of the packaging with due regard for safety and the environment. Your local authority can arrange this.

### CHILD SAFETY

**Do not** allow children to play with any part of the packaging.

**Do not** allow children to sit or climb on the drop down doors.

This appliance is not intended for use by children and other persons whose physical, sensory or mental capabilities or lack of experience and knowledge prevents them from using the appliance safely without supervision or instruction by a responsible person to ensure that they can use the appliance safely.

Children should be supervised to ensure that they do not play with the appliance.

**CAUTION: Accessible parts may be hot when the grill is in use. Young children should be kept away.**

### DURING USE

This appliance is not intended to be operated by means of an external timer or separate remote control system.

This appliance has been designed for domestic use to cook edible foodstuffs only and **must not** be used for any other purposes.

Take great care when heating fats and oils as they will ignite if they become too **hot**.

Never place plastic or any other material which may melt in or on the oven.

Always use oven gloves to remove and place food in the oven.

Do not leave the grill pan handle in position when grilling as it will become **hot**.

Always support the grill pan when it is in the withdrawn or partially withdrawn position.

During use the appliance becomes hot. Care should be taken to avoid touching heating elements inside the oven.

Ensure that all vents are not obstructed to ensure ventilation of the oven cavity.

**Never** line any part of the appliance with foil.

**Always** stand back from the appliance when opening the doors to allow any build up of steam or heat to release.

**Do not** stand too close to the oven or grill while in use as warm air will exhaust from the grill cavity and the vents on the front frame of the appliance.

Stand clear when opening the drop down doors. Support the doors using the handles until fully open.

**Never leave the appliance unattended when the oven door is open.**

**Do not** place sealed cans or aerosols inside the oven. They may explode if they are heated.

Ensure that all control knobs are in the OFF position when not in use.

**Do not** stand on the appliance or on the open oven doors.

**Do not** hang towels, dishcloths or clothes from the appliance or its handles. They are a safety hazard.

**Do not** use this appliance if it is in contact with water. **Never** operate it with wet hands.

### CLEANING AND MAINTENANCE

**For hygiene and safety reasons this appliance should be kept clean at all times. A build-up of fats or other foodstuffs could result in a fire especially in the grill pan.**

**Do not** leave the cookware containing foodstuffs, e.g. fat or oil in the appliance in case it is inadvertently switched on.

Always allow the appliance to cool before switching off at the wall prior to carrying out any cleaning / maintenance work.

Only clean this appliance in accordance with the instructions given in this book.

Never use steam or high pressure steam cleaners to clean the appliance.

### AT THE END OF THE APPLIANCE'S LIFE



The symbol  on the product or on its packaging indicates that this product may not be treated as household waste. Instead it shall be handed over to the applicable collection point for the recycling of electrical and electronic equipment. By ensuring this product is disposed of correctly, you will help prevent potential negative consequences for the environment and human health, which could otherwise be caused by inappropriate waste handling of this product. For more detailed information about recycling of this product, please contact your local city office, your household waste disposal service or the shop where you purchased the product.

# CONTENTS

## FOR THE USER

<b>Important Safety Information</b>	2
<b>Description Of The Appliance</b>	4
Getting To Know Your Appliance	5
Grill And Oven Furniture	6
Telescopic Runners	6
Before Using The Appliance	7
Rating Plate	7
Preparing To Use Your Appliance	7
When First Switching On	7
The Cooling Fan For The Controls	7
Control Panel Indicator Neon(s)	7
Pop In Pop Out Controls	7
Condensation And Steam	7
Cookware	7
Helpful Hints When Buying And Preparing Food	7
<b>Electronic Timer</b>	8
<b>Other Functions</b>	12
<b>Full Width Dual Grill</b>	13
Using Full Width Dual Grill	13
Things To Note	13
The Grill Pan and Handles	14
Hints And Tips	14
Grilling Chart	15
<b>Second Oven</b>	16
Using Second Oven	16
Things to Note	16
To Fit The Second Oven Shelf	16
Hints And Tips	17
<b>Second Oven Cooking Chart</b>	18
<b>Ventitherm® Precision Fan Cooking</b>	19
Using Ventitherm® Precision Fan Cooking	19
Things To Note	19
To Fit The Main Oven Shelves	19
Using the Telescopic Runners (Where Fitted)	20
Hints And Tips	20
<b>Conventional Cooking</b>	21
Using Conventional Cooking	21
Things To Note	21
Hints And Tips	22
<b>Main Oven Cooking Chart</b>	23
<b>Roasting Chart</b>	24
<b>Main Oven Full Width Grill</b>	25
Using Full Width Grill	25
Things to Note	25
Hints And Tips	26
Grilling Chart	26
<b>Pizza</b>	27
Using Pizza	27
Things To Note	27
Hints And Tips	27

<b>Rotitherm Roasting</b>	28
Using Rotitherm Roasting	28
Things To Note	28
Hints And Tips	29
<b>Rotitherm Roasting Chart</b>	29
<b>Speedcook</b>	30
Using Speedcook	30
Selecting Speedcook	30
Things To Note	30
<b>Fan Controlled Defrosting</b>	31
Using Fan Controlled Defrosting	31
Things To Note	31
Hints And Tips	31
<b>Care and Cleaning</b>	32
Cleaning Materials	32
Cleaning The Outside Of The Appliance	32
Removing And Replacing Wirework Runners	32
Cleaning Inside The Ovens	33
Cleaning The Door(s)	34
To Remove The Inner Glass	34
To Clean The Inner Glass Door Panel	34
To Replace the Inner Glass Door Panel	35
Cleaning The Grill And Oven Furniture	35
Replacing An Oven Light Bulb	35
<b>Something Not Working</b>	37
<b>Service and Spare Parts</b>	38
<b>Guarantee Conditions</b>	39

## FOR THE INSTALLER

<b>Technical Details</b>	40
<b>Installation Instructions</b>	41
Warnings	41
Things To Note	41
Choice Of Electrical Connection	42
Preparing Cabinet For Fitting Of Oven	42
Recommended Cabinet Dimensions	43
How To Finish Unpacking	44
To Remove Cover Of Mains Terminal	44
Connecting To The Mains Terminal	45
Checking Electrical Connections	45
Connecting To A Hob Or Cooker Point	45
Fitting Into The Cabinet	46
Notes	47

To help you the following symbols will be found in the text.



Hints and Tips



Safety Instructions

**Please read the instruction book carefully before use and retain for future reference.**

# DESCRIPTION OF THE APPLIANCE

## BUILT-IN ELECTRIC MULTIFUNCTION DOUBLE OVEN

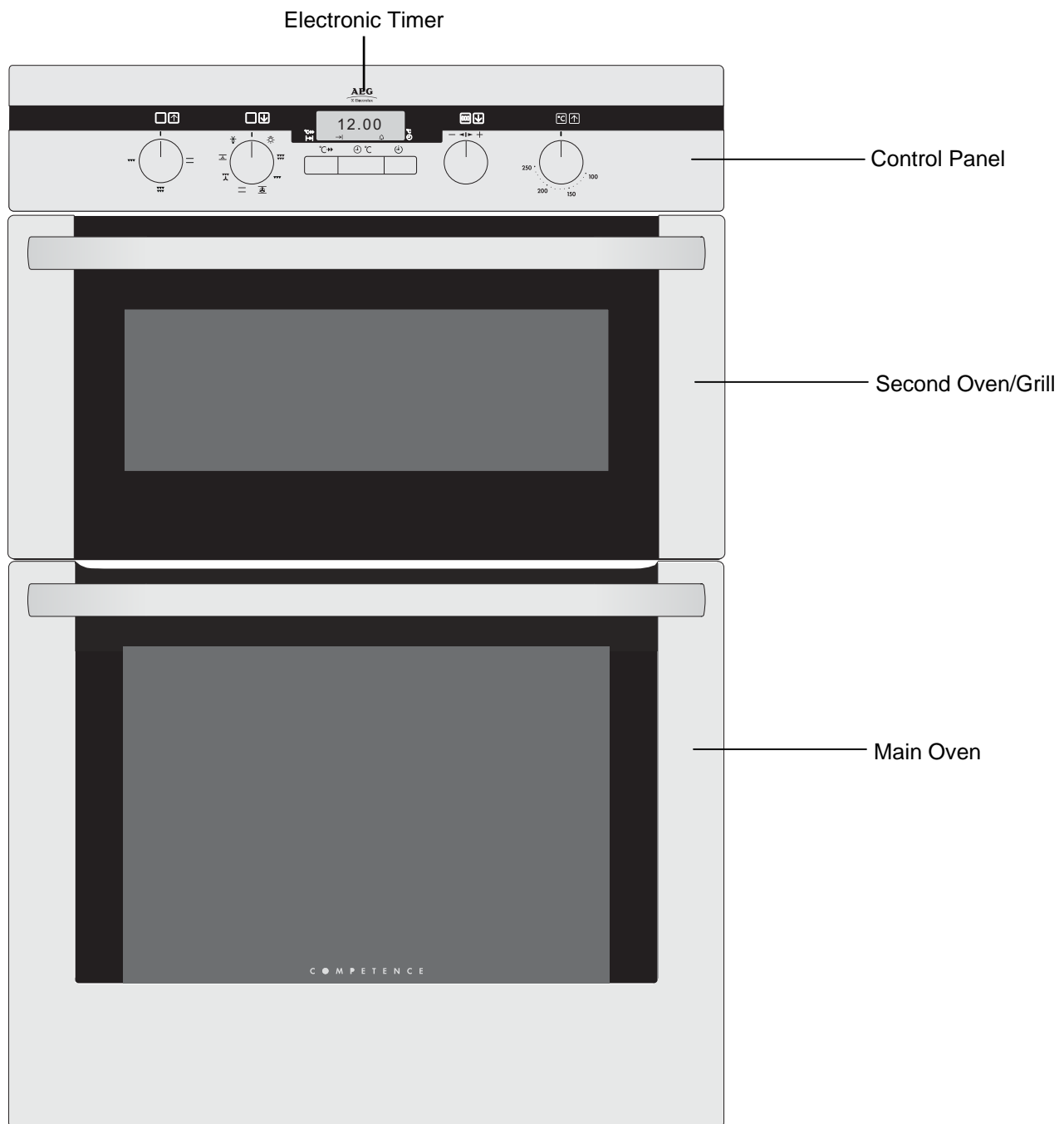

Your built-in oven comprises of a conventional second oven and dual grill in the top compartment. The multifunction oven can be automatically controlled by the electronic timer.

# GETTING TO KNOW YOUR APPLIANCE

## THE CONTROL PANEL

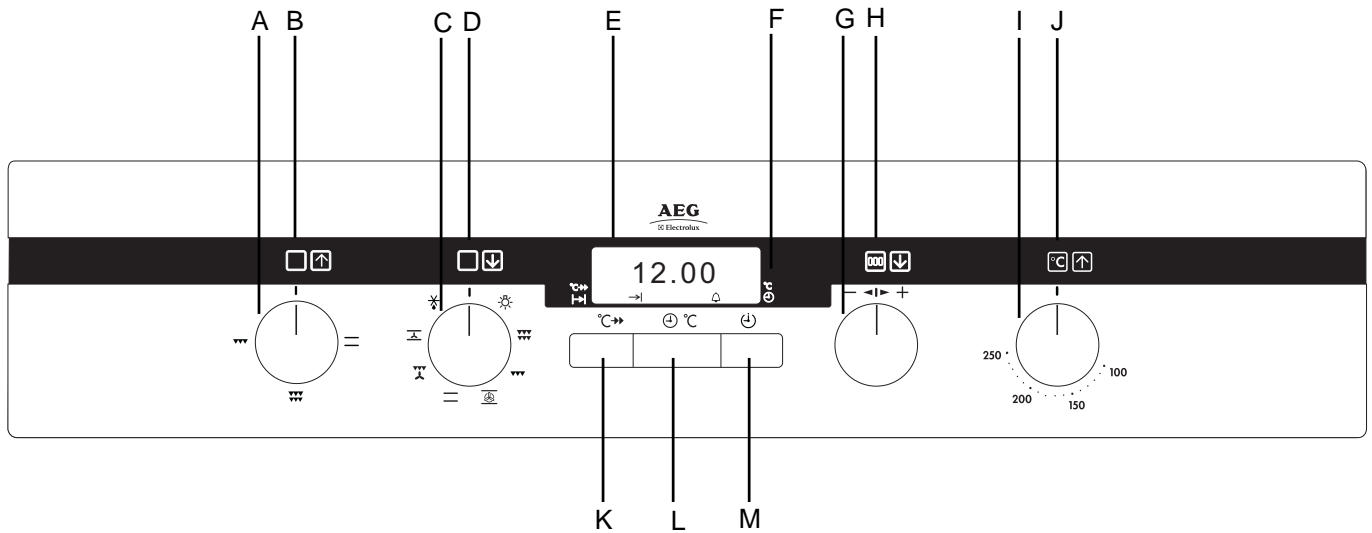

- A - Second Oven/Grill Function Selector
- B - Second Oven/Grill Function Selector Neon
- C - Multifunction Selector



Oven Light



Full Width Grill



Single Economy Grill



Ventitherm® Precision Fan Cooking



Conventional Cooking



Rotitherm Roasting



Pizza



Fan Controlled Defrosting

- D - Multifunction Selector Neon
- E - Electronic Timer
- F - Main Oven Temperature Neons
- G - Main Oven Increase/Decrease Selector
- H - Main Oven Increase/Decrease Selector Neon
- I - Second Oven Temperature Control
- J - Second Oven Temperature Control Neon
- K - Speedcook Button
- L - Time/Temperature Button
- M - Time Selector Button

## GRILL AND OVEN FURNITURE

The following items of oven furniture have been supplied with the appliance:-

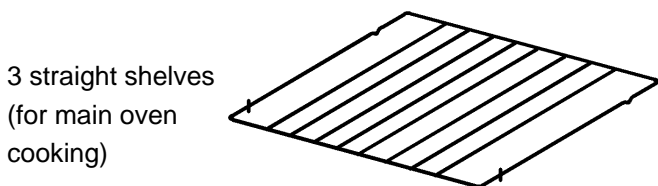
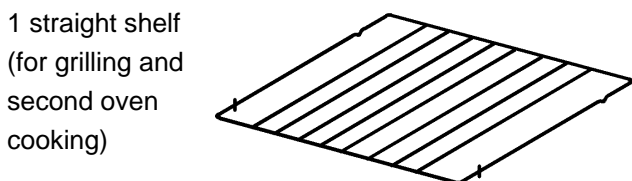
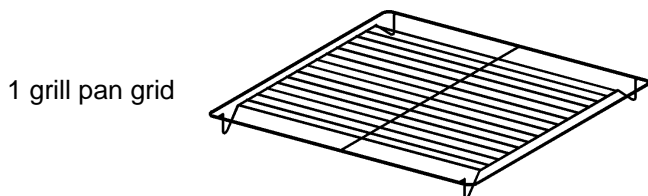
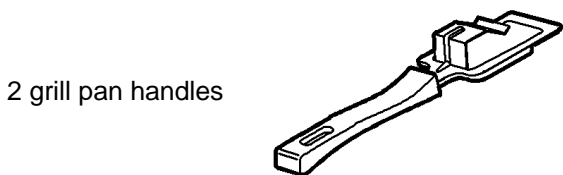
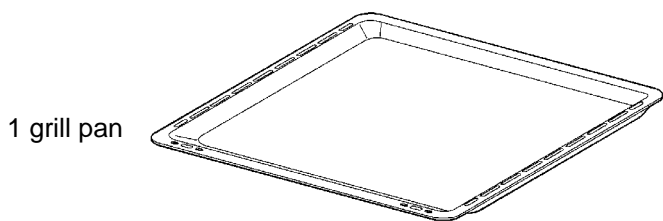

## TELESCOPIC RUNNERS

Your appliance may be fitted with telescopic runners in the grill and main oven.

To fit the shelf into the telescopic runner,

1. Ensure the telescopic runners are pushed back into the oven cavity before fitting the shelf.
2. Holding the front edge of the shelf with both hands, place the rear shelf forms over the telescopic runners.
3. Slide the shelf into position, lifting slightly at the front so that the shelf locates into the retaining hooks.

To remove, raise the front edge and withdraw the shelf.

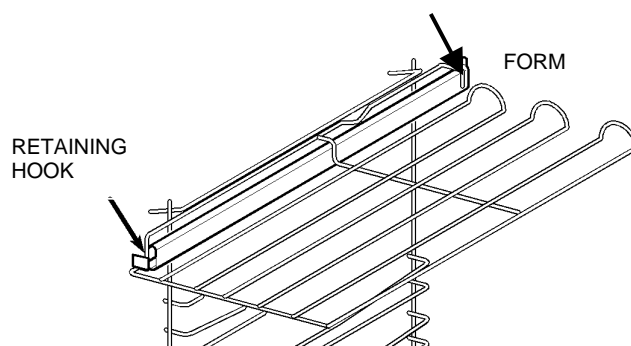

# BEFORE USING THE APPLIANCE

## RATING PLATE

This is situated on the lower front frame of the appliance and can be seen upon opening the door. Alternatively the rating plate may also be found on the back or top of some models (where applicable).

The appliance must be protected by a suitably rated fuse or circuit breaker. The rating of the appliance is given on the rating plate.

**Do not remove the rating plate from the appliance as this may invalidate the guarantee.**

## PREPARING TO USE YOUR APPLIANCE

Wipe over the base of the oven(s) with a soft cloth and hot soapy water and wash the furniture before use.

We suggest that you run the oven elements for 10 – 15 minutes at 220°C to burn off any residue from their surfaces.

The procedure should be repeated with the grill for approximately 5 – 10 minutes.

During this period an odour may be emitted, it is therefore advisable to open a window for ventilation.

## WHEN FIRST SWITCHING ON

The oven has a 24 hour clock. When the oven is first switched on at the wall the electronic display will automatically show 12.00, and the 'Time' (⊕) neon will also flash.

## THE COOLING FAN FOR THE CONTROLS

The cooling fan comes on immediately when the grill/top oven is switched on and after a short time when the main oven is in use. It runs on after the controls are switched off until the appliance has cooled. During the initial period the cooling fan for the main oven may turn ON and OFF, this is quite normal.



**Always allow the cooling fan to cool the appliance down before switching off at the wall prior to carrying out any cleaning or maintenance work.**

---

## CONTROL PANEL INDICATOR NEON(S)

The indicator neon will operate when the grill (where applicable) or oven(s) is switched on. The indicator neon will glow. It may turn on and off during use to show that the setting is being maintained. If the neon does not operate as the instructions indicate the controls have been incorrectly set. Return all controls to zero and reset following the instructions for the required setting.

## POP IN POP OUT CONTROLS

These control knobs can remain flush with the control panel when not in use, or pushed and released to stand out from the panel for easy operation.

## CONDENSATION AND STEAM

When food is heated it produces steam similar to a boiling kettle. The vents allow some of this steam to escape. However, always stand back from the appliance when opening the door(s) to allow any build up of steam or heat to release.

If the steam comes into contact with a cool surface on the outside of the appliance, e.g. a trim, it will condense and produce water droplets. This is quite normal and is not caused by a fault on the appliance.

To prevent discolouration, regularly wipe away condensation and also soilage from surfaces.

## COOKWARE

Baking trays, dishes etc., should not be placed directly against the grid covering the fan at the back of the oven.

**Do not** use baking trays larger than 30cm x 35cm (12" x 14") as they will restrict the circulation of heat and may affect performance.

## HELPFUL HINTS WHEN BUYING AND PREPARING FOOD

Care must be taken when handling foods in the home. Always follow the basic rules of food hygiene to prevent bacterial and microbial growth and cross contamination when preparing, reheating, cooking, cooling, defrosting and freezing foods:-

1. Avoid buying chilled or frozen products if you cannot store them straight away. The use of an insulated container when shopping is advisable.
2. When you arrive home, place perishable foods in the refrigerator or freezer immediately. Ensure they are well covered to prevent them drying out and to prevent any possible cross contamination with bacteria from raw to cooked foods.
3. In the kitchen keep work tops, chopping boards and utensils clean with hot soapy water between preparation stages. Ideally, keep one chopping board for raw meat and another for other foods. Keep your dish cloths and tea towels clean.

# ELECTRONIC TIMER

## KEY

- A COOK TIME INDICATOR NEON
- B SPEEDCOOK INDICATOR NEON
- C END TIME INDICATOR NEON
- D COUNTDOWN INDICATOR NEON
- E TEMPERATURE INDICATOR NEON
- F TIME INDICATOR NEON
- G TIME SELECTOR BUTTON
- H TIME/TEMPERATURE BUTTON
- I SPEEDCOOK BUTTON

## NOTE:

The time of day must be set before the main oven will operate manually.

## 1. HOW TO SET THE TIME OF DAY

The oven has a 24 hour clock.

When the electricity supply is first switched ON, the display will show 12.00 and the 'Time' indicator neon (⊕) will flash as Fig. 1.

To set the correct time turn the main oven increase/decrease selector ( +/- ) until the correct time on the 24 hour clock is reached, e.g. 10.00am as Fig.2. The 'Time' indicator neon (⊕) will flash for 5 seconds and then go out.

**Note:** The main oven increase/decrease selector will operate slowly at first, and then more rapidly.

## 2. HOW TO SET THE COUNTDOWN

The 'Countdown' gives an audible reminder at the end of any period of cooking. This cooking period may be up to 99 mins. It is not part of the automatic control.

To set, press the Time Selector button (⏸) until the 'Countdown' indicator neon (⏸) is illuminated the display reads 0.00 as Fig.3.

To set the correct time duration turn the main oven increase/decrease selector ( +/- ) until the display indicates the interval to be timed, e.g. 20 mins as Fig. 4.

**NOTE:** This must be completed within 5 seconds of first pressing the Time Selector button.

To view the remaining time period, press the time selector button until the 'Countdown' neon flashes.

When 90% of the time set has elapsed an audible signal sounds. The 'Countdown' will sound intermittently for up to 2 minutes at the end of the timed period. The sound can be stopped by pressing any button.

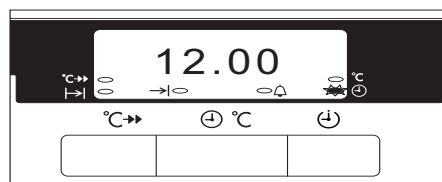
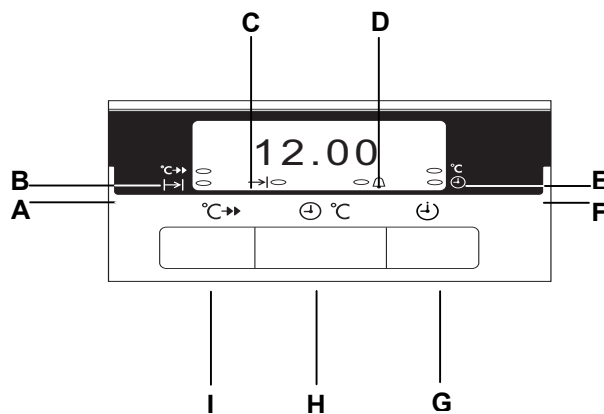

Fig.1

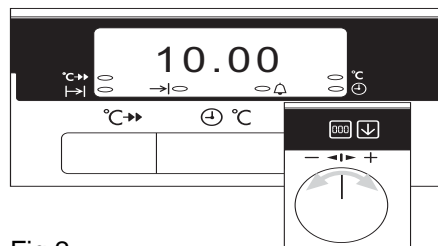

Fig.2

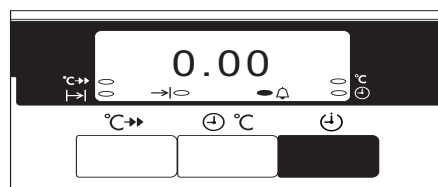

Fig.3

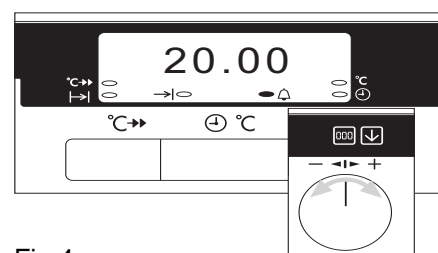





Fig.4



## TO CANCEL THE COUNTDOWN



If you change your mind and want to cancel the 'Countdown', press the Time Selector button until the 'Countdown' (  ) indicator neon flashes and then turn the main oven increase/decrease selector (  ) until 0.00 shows in the display as Fig. 5. The 'Countdown' (  ) indicator neon will continue to flash for a few seconds and then return to the time of day.

## 3. SETTING THE OVEN TIMER CONTROL





The main oven only can be automatically timed.

When using the timer control for the very first time, it is advisable to let it operate while you are at home. The displays can be checked to show that it is operating correctly and you will feel confident to leave a meal to cook automatically in the future.

### A) TO SET THE TIMER TO SWITCH ON AND OFF AUTOMATICALLY

- i) Ensure the electricity supply is switched ON and that the correct time of day is displayed, e.g. 9.am. as Fig. 6.
- ii) Set the main oven controls to the required function and temperature.
- iii) Place food in the oven.
- iv) To set the length of cooking time, press the Time Selector button until the 'Cook Time' indicator neon is illuminated (  ). Turn the main oven increase/decrease selector (  ) until the required length of cooking time is displayed, e.g. 2 hrs 15 mins as Fig. 7.
- v) The maximum cooking time is 9.59 hours.
- vi) Release the buttons. The 'Cook Time' indicator neon (  ) will be illuminated.

**Remember, this must be completed within 5 seconds of first pressing the Time Selector button.**

- vi) To set the 'End Time'. Press the Time Selector button until the 'End Time' indicator neon (  ) flashes. Turn the main oven increase/decrease selector (  ) until the required stop time is displayed, e.g. 12.15 p.m. as Fig. 8.
- vii) Release the buttons. The 'Cook Time' (  ) and 'End Time' (  ) indicator neons will be illuminated. To return the display to the time of day, press the Time/Temperature button. The 'End Time' must not be more than 23 hours 59 minutes from the time of day. For example, if the time of day is 09.00a.m., the latest 'End Time' would be 08.59a.m. the next day.

**NOTE: The Multifunction Selector neon and the main oven Increase/Decrease Selector neon (  ) will remain illuminated during programme.**

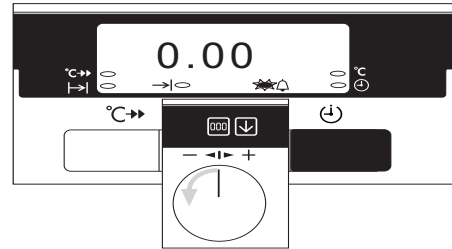

Fig.5

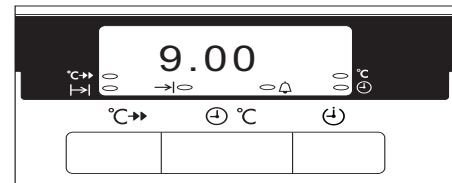

Fig.6

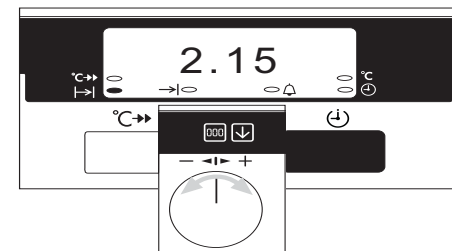

Fig.7

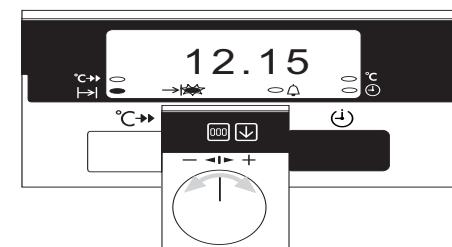







Fig.8

## B) TO SET THE TIMER TO SWITCH OFF ONLY

- i) Ensure the electricity supply is switched ON and that the correct time of day is displayed, e.g. 10.00am as Fig. 9.
- ii) Set the main oven controls to the required function and temperature.
- iii) Place food in the oven.
- iv) To set the length of cooking time, press the Time Selector button until the 'Cook Time' (  ) indicator neon is illuminated. Turn the main oven increase/decrease selector (  ) until the required length of cooking time is displayed, e.g. 2 hrs 15 mins as Fig. 10.
- v) Release the buttons. The 'Cook Time' indicator neon (  ) will illuminate.
- vi) To check the 'End Time' during the cooking period, simply press the Time Selector Control button once and the remaining time will be displayed, as Fig. 11.
- vii) To return the display to the time of day, press the Time/Temperature button.

**NOTE: The Multifunction Selector neon and the main oven Increase/Decrease Selector neon (  ) will remain illuminated during programme.**

## 4. TO CANCEL AN AUTOMATIC PROGRAMME

- i) To cancel an automatic programme press the Time Selector button until the 'Cook Time' (  ) indicator neon flashes. Turn the main oven increase/decrease selector (  ) until the display reads 0.00 as Fig. 12.
- ii) Release the buttons. The 'Cook Time' (  ) indicator neon will flash.
- iii) Turn off the oven controls.
- iv) The display will return to the time of day.

## 5. TO RETURN THE APPLIANCE TO MANUAL

At the end of a timed cooking period, the indicator neon will flash and an alarm will sound for up to 2 minutes.

- i) To stop the sound press any of the buttons, as Fig. 13.
- ii) ---°C will show in the display.
- iii) Turn off the oven controls.

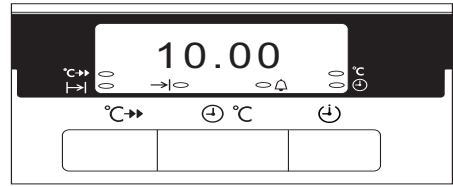

Fig.9

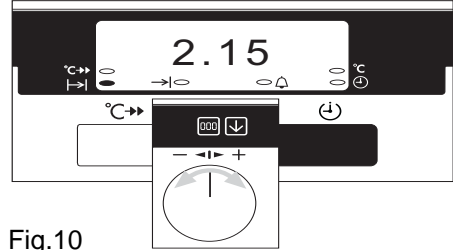

Fig.10

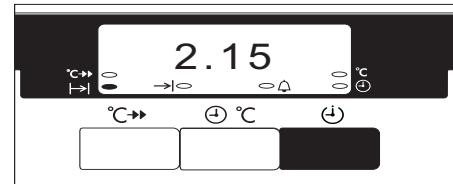

Fig.11

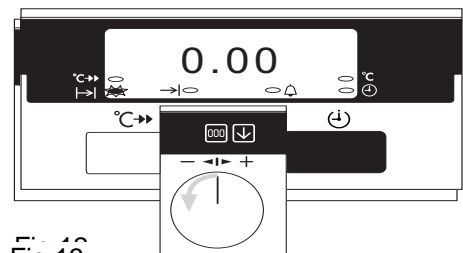

Fig.13

## 6. THINGS TO NOTE

- In the event of an interruption of the electricity supply, the timer will reset itself to 12.00, and all programming will be cancelled.

## 7. AUTOMATIC COOKING

It is advisable to leave food in the oven for as short a time as possible before automatic cooking. Always ensure commercially prepared food is well within its use by date and that home prepared food is fresh and of good quality.

When cooking is complete, **do not** leave food to stand in the oven, but remove and cool it quickly if the food is not to be consumed immediately.

Always ensure food in the oven has been covered before cooking if it is not possible to remove food immediately after cooking.

## OTHER FUNCTIONS

### SWITCHING OFF THE DISPLAY

You can save energy by switching off the clock display.

### SWITCHING OFF THE CLOCK DISPLAY

1. Turn the main oven increase/decrease selector ( **+/-** ) to the right and hold it.
2. In addition press the Time Selector button (  ) until the display goes out as Fig. 14.

As soon as the appliance is switched on again, the display comes on automatically.

### SWITCHING ON THE CLOCK DISPLAY

1. Turn the main oven increase/decrease selector ( **+/-** ) to the right and hold it.
2. In addition press the Time selector button (  ) until the display appears again.

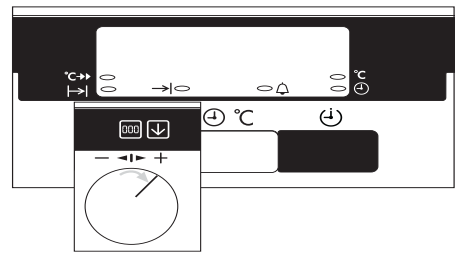

Fig.13

## CHILD SAFETY DEVICE

To avoid children switching on the main oven when the appliance is switched off, it is possible to lock the oven controls in the main oven only.

### THE MAIN OVEN CHILD SAFETY DEVICE

The oven cannot be used from the moment the child safety device has been switched on.

### ACTIVATING THE CHILD SAFETY DEVICE

- No oven function must be selected.
- Turn the main oven increase/decrease selector ( +/- ) to the left and hold it. In addition press the Time Selector button (  ) until "SAFE" appears in the display.
- The child safety device is now activated.

### DEACTIVATING THE CHILD SAFETY DEVICE

- Turn the main oven increase/decrease selector ( +/- ) to the left and hold it. In addition press the Time Selector button (  ) until "SAFE" disappears from the display.
- The child safety device is now deactivated and the oven is again ready for use.

## OVEN SAFETY CUT-OUT

If not switched off after a certain time, or if the temperature is not modified, the oven switches off automatically.

The last temperature set flashes in the temperature display.



### The oven switches off when the oven temperature is :\*

30	-	120°C	after	12.5	hours
120	-	200°C	after	8.5	hours
200	-	250°C	after	5.5	hours
250	-	Max°C	after	1.5	hours

### Switching on after a safety cut-out

Switch the oven off completely.

It can then be switched on again.

The safety cut-out is cancelled if the clock function Cook time (  ) or End Time (  ) is set.

\*Not with the Rotitherm Roasting oven function.

# FULL WIDTH DUAL GRILL

 **CAUTION – ACCESSIBLE PARTS MAY BE HOT WHEN THE GRILL IS IN USE. YOUNG CHILDREN SHOULD BE KEPT AWAY.**

The Dual Grill on this appliance has been designed to heat up more quickly than conventional grill elements. It provides quick, direct heat and no preheating is necessary. It has a dual circuit facility which means that the full area of the grill can be used, or for economy purposes the centre section only can be used when cooking smaller quantities of food.

## USING FULL WIDTH DUAL GRILL

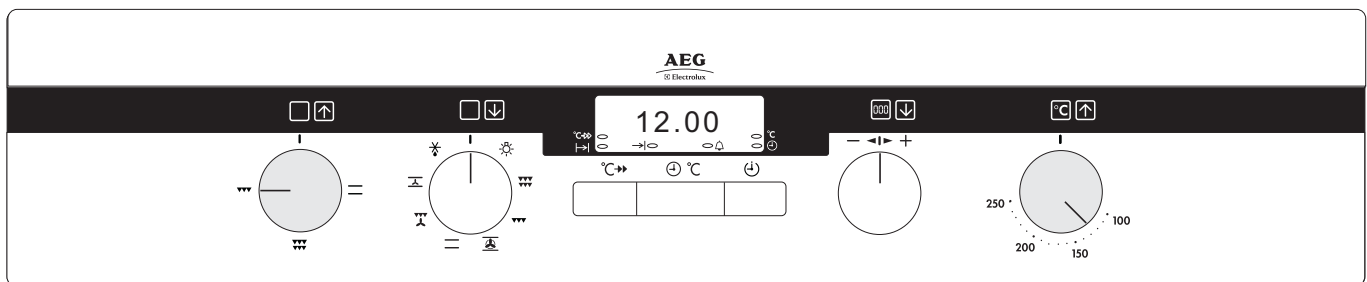

- To operate the grill, pop out and turn the second oven/grill function selector for full grill. ▼▼▼
- Pop out and turn the second oven/grill function selector for centre section only. ▼▼▼
- Turn the temperature control knob to the right as far as it will go. This is the hottest setting.
- To use the grill at lower settings, turn the temperature control knob so that 110°C or 150°C on the panel lines up with the "0" on the knob.

## THINGS TO NOTE

- The indicator neon will glow. It may turn ON and OFF during use to show that the setting is being maintained.
- The cooling fan for the controls may operate after a time.
- Some smoke from fat splashes may be evident as the grill cleans itself.
- The grill may be used with the door open or with the door closed.

## THE GRILL PAN AND HANDLES

The grill pan is supplied with removable handles.

1. To attach the handles, place the wirework under the cut out in the pan so that the metal plate hooks over the top of the grill pan.



**Ensure the handles are positively located.**

2. To remove the handles, lift away from the cut out on the grill pan.

Place the grill pan on the shelf so that the pan is positioned centrally beneath the grill.



**Protect your hands when removing the grill pan handles.**

**Always remove the grill pan handles during grilling.**

To check the progress of the food being grilled, the grill pan should be withdrawn to attend food during cooking.

If your model is fitted with telescopic runners in position 3, the grill pan can be withdrawn on the shelf.

## **i** HINTS AND TIPS

- Most foods should be placed on the grid in the grill pan to allow maximum circulation of air to lift the food out of the fats and juices.
- Adjust the grid and grill pan runner position to allow for different thicknesses of food. Position the food close to the element for faster cooking and further away for more gentle cooking.
- Food should be thoroughly dried before grilling to minimise splashing. Brush lean meats and fish lightly with a little oil or melted butter to keep them moist during cooking.
- Accompaniments such as tomatoes and mushrooms may be placed around the outer edges or underneath the grid when grilling meats.
- When toasting bread, we suggest that the top runner position is used with the grid in its 'high' position.
- When using the centre section grill, ensure food is placed centrally on the grilling grid directly beneath the grill element.

1.

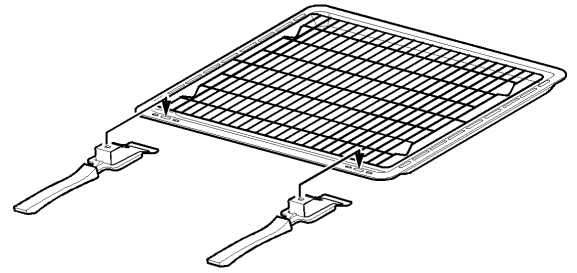

2.

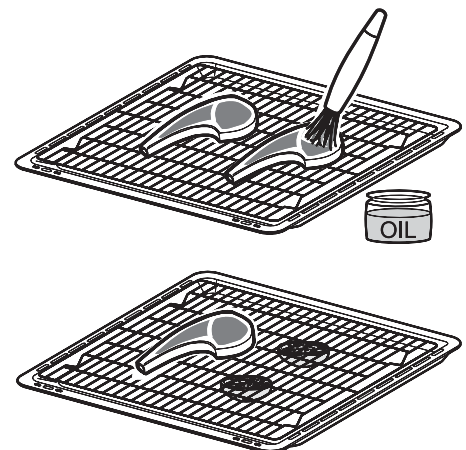
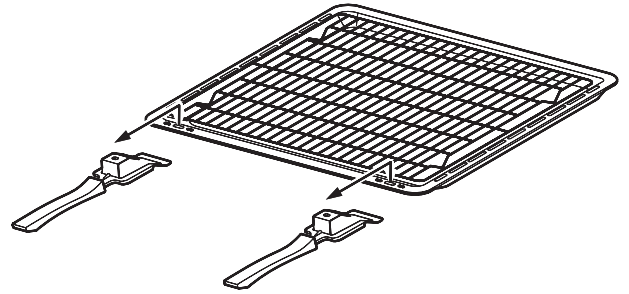

- Preheat the grill on full setting for a few minutes to seal meat or for toasting. Adjust the heat setting and the shelf position as necessary during cooking.
- The food should be turned over during cooking as required.



## GRILLING CHART

FOOD	POSITION	GRILL TIME (mins in total)
Bacon Rashers	Adjust grill setting and grill pan grid to suit different thicknesses of food	5 - 6
Beefburgers		10 - 15
Chicken Joints		30 - 40
Chops – Lamb		15 - 20
Pork		20 - 30
Fish – Whole Trout/Mackerel		15 - 25
Fillets - Plaice/Cod		10 - 15
Kebabs		20 - 30
Kidneys – Lamb/Pig		8 - 12
Liver – Lamb/Pig		10 - 20
Sausages		20 - 30
Steaks – Rare		6 - 12
Medium		12 - 16
Well Done		14 - 20
Toasted Sandwiches		3 - 4

The times quoted above are given as a guide and should be adjusted to suit personal taste.

# SECOND OVEN

The second oven is the smaller of the two ovens. It is heated by elements in the top and bottom of the oven. It is designed for cooking smaller quantities of food. It gives especially good results if used to cook fruit cakes, sweet and savoury flans or quiche.

The second oven is also ideal for use as a warming compartment to warm dishes and keep food hot. Use the second oven when you want to warm plates. Use the lowest setting on the second oven temperature control.

## USING SECOND OVEN

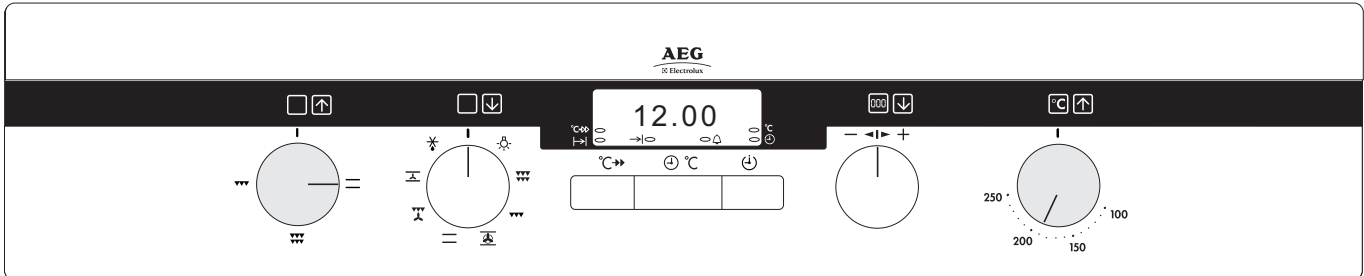

- Pop out and turn the second oven/grill function selector to. 
- Pop out and turn the second oven temperature control to the required setting.

## THINGS TO NOTE

- The oven light will illuminate.
- The indicator neon will glow. It may turn ON and OFF during use to show that the setting is being maintained.
- The cooling fan for the controls may operate after a time.

 **Do not place dishes, tins or baking trays directly onto the oven base as it becomes very hot and damage may occur.**

## TO FIT THE SECOND OVEN SHELF

The shelf should be fitted with the straight rods uppermost on the frame and the forms towards the back of the oven.

To remove a shelf slide the shelf towards you until the shelf stop is reached. Tilt shelf up at the front so that the stops clear the side supports. Lift shelf clear. To install a shelf, reverse the above steps. Each shelf position has an upper and lower support wire, ensure the shelf is placed between these two support wires.

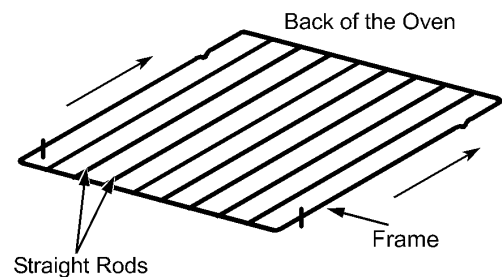



## HINTS AND TIPS

- Arrange the shelf in the required position before switching the oven ON. Shelf positions are counted from the bottom upwards.
- There should always be at least 2.5cm (1") between the top of the food and the element. This gives best cooking results and allows room for rise in yeast mixtures, Yorkshire puddings etc. When cooking cakes, pastry, scones bread etc., place the tins or baking trays centrally on the shelf.
- Ensure that food is placed centrally on the shelf and there is sufficient room around the baking tray/dish to allow for maximum circulation.
- Stand dishes on suitably sized baking trays on to prevent spillage onto the oven base and to help reduce cleaning.
- The material and finish of the baking tray and dishes used will affect base browning. Enamelware, dark, heavy or non-stick utensils increase base browning. Shiny aluminium or polished steel trays reflect the heat away and give less base browning.
- **Do not** place baking trays directly on the oven base as it interferes with the oven air circulation and can lead to base burning; use the lower shelf position.
- Because of the smaller cooking space and lower temperatures, shorter cooking times are sometimes required. Be guided by the recommendations given in the cooking chart.
- For economy leave the door open for the shortest possible time, particularly when placing food into a pre-heated oven.

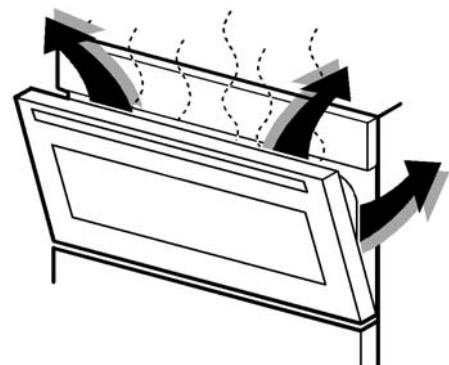
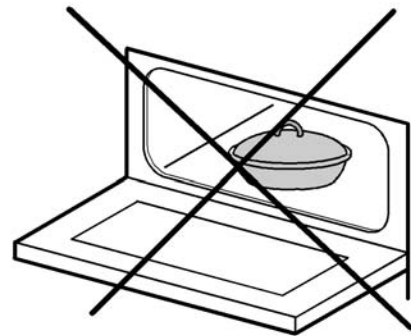
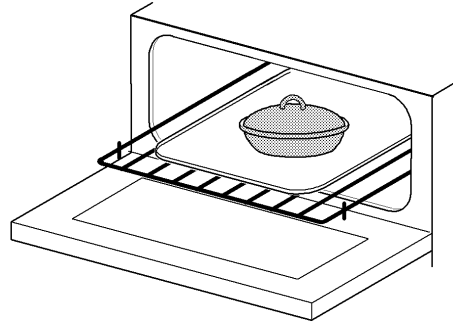
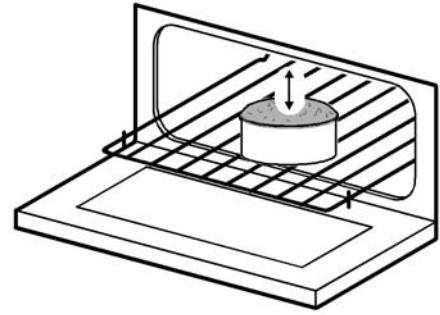

**Do not place cookware and cooking pots with rough bases e.g. cast iron on the oven door as damage to the glass may occur.**

# SECOND OVEN COOKING CHART

		SECOND OVEN		
FOOD		SHELF POSITION	COOKING TEMP°C	APPROX COOK TIME (m)
Biscuits		1	170 - 190	10 - 20
Bread		1*	200 - 220	25 - 30
Bread rolls/buns		1	200 - 220	15 - 20
Cakes:	Small & Queen	1	180 - 190	18 - 25
	Sponges	1	160 - 170	18 - 20
	Victoria Sandwich	1	160 - 170	18 - 25
	Madeira	1	140 - 150	1¼ - 1½h
	Rich Fruit	1	140 - 150	2¼ - 2½h
	Christmas	1	130 - 140	3 - 4½h
				depends on size
	Gingerbread	1	140 - 150	1¼ - 1½h
	Meringues	1	90 - 100	2½ - 3h
	Flapjack	1	170 - 180	25 - 30
	Shortbread	1	140 - 150	45 - 65
Casseroles:	Beef/Lamb	1*	140 - 160	2½ - 3h
	Chicken	1*	180 - 190	1¼ - 1½h
Convenience Foods			Follow manufacturer's instructions	
Fish		1	170 - 190	20 - 30
Fish Pie (Potato Topped)		1*	190 - 200	20 - 25
Fruit Pies, Crumbles		1	190 - 200	40 - 50
Milk Puddings		1	140 - 150	1½ - 2h
Pasta Lasagne etc.		1	170 - 180	40 - 45
Pastry:	Choux	1	180 - 190	30 - 35
	Eclairs, Profiteroles	1	170 - 180	20 - 30
	Flaky/Puff Pies	1*	210 - 220	25 - 40
Shortcrust	Mince Pies	1	190 - 200	15 - 20
	Meat Pies	1*	190 - 210	25 - 35
	Quiche, Tarts, Flans	1	180 - 200	25 - 45
Roasting Meat, Poultry		1*	160 - 180	see roasting chart
Scones		1	220 - 230	8 - 12
Shepherd's Pie		1*	190 - 200	30 - 40
Soufflés		1	170 - 180	20 - 30
Vegetables:	Baked Jacket Potatoes	1	180 - 190	1 - 1½h
	Roast Potatoes	1	180 - 190	1 - 1½h
Yorkshire Puddings:	Large	1	200 - 210	25 - 40
	Individual	1	200 - 210	15 - 25

\* = Shelf on the oven base

**Note:** Shelf positions are counted from the bottom of the oven upwards.

# VENTITHERM® PRECISION FAN COOKING

The fan oven is particularly suitable for cooking larger quantities of food.

The advantages of fan oven cooking are:

## PREHEATING

The fan oven quickly reaches its temperature, so it is not usually necessary to preheat the oven. Without preheating however, you may need to add an extra 5 – 10 minutes on the recommended cooking times. For recipes needing high temperatures, e.g. bread, pastries, scones, soufflés etc., best results are achieved if the oven is preheated first. For best results when cooking frozen or cooked chilled ready meals always preheat the oven first.

## COOKING TEMPERATURES

Fan oven cooking generally requires lower temperatures than conventional cooking. Follow the temperatures recommended in the cooking chart. As a guide reduce temperatures by 20°C - 25°C for your own recipes, using a conventional oven.

## BATCH BAKING

The fan oven cooks evenly on all shelf levels, especially useful when batch baking.

## USING VENTITHERM® PRECISION FAN COOKING

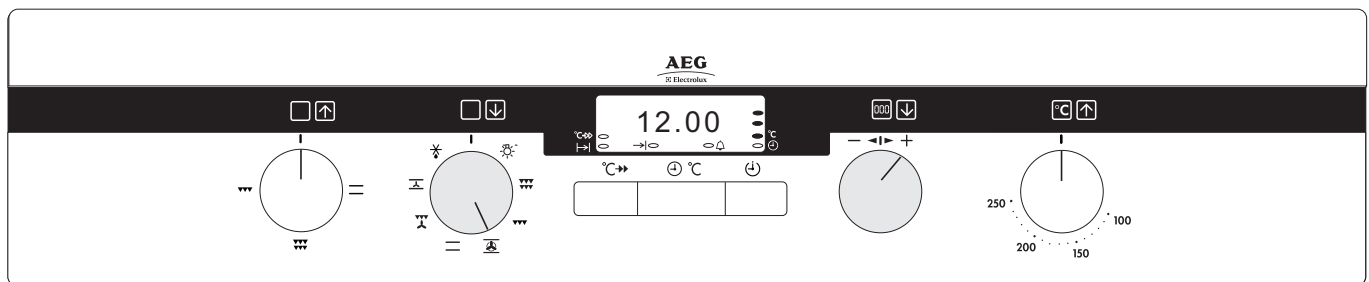

- Pop out and turn the multifunction selector to Ventitherm® Precision Fan Cooking.
- Wait 5 seconds until your choice is confirmed. The temperature will automatically set to 150°C.
- If you wish to alter the set temperature, you may do so by pushing out and turning the main oven increase/decrease selector (+/-) until the required temperature setting is reached.

## THINGS TO NOTE

- If it is necessary to reach the required temperature in a shorter time, the Speedcook Function can be used. See Speedcook Function section.
- When the required temperature is reached the three temperature indicator neons on the timer display will illuminate and an audible signal will sound.

- The multifunction selector indicator neon and the main oven increase/decrease selector indicator neon will glow.
- The main oven temperature neons will illuminate until the oven has reached the desired temperature and then stop. When the oven has been switched off the bars that are still lit indicate the remaining residual heat in the oven.
- The cooling fan for the controls may operate after a time.
- The oven light will illuminate.
- If an automatic programme has been set, the oven fan and light do not come on until cooking begins.
- Some internal noise may be heard during operation. This is quite normal.

## TO FIT THE MAIN OVEN SHELVES

The shelves should be fitted with the straight rods uppermost on the frame and the forms towards the back of the oven.

To remove a shelf slide the shelf towards you until the shelf stop is reached. Tilt shelf up at the front so that the stops clear the side supports. Lift shelf clear. To install a shelf, reverse the above steps. Each shelf position has an upper and lower support wire, ensure the shelf is placed between these two support wires.

## USING THE TELESCOPIC RUNNERS (where fitted)

1. Ensure the telescopic runners are pushed back into the oven cavity before fitting the shelf.
2. Holding the front edge of the shelf with both hands, place the rear shelf forms over the telescopic runners.
3. Slide the shelf into position, lifting slightly at the front so that the shelf locates into the retaining hooks.  
To remove, raise the front edge and withdraw the shelf.  
Ensure the shelf is positively located before using.

### Note:

Should you wish to purchase a telescopic runner kit, this can be ordered from your local Service Force Centre by quoting part number (BAZ D02).

## **i** HINTS AND TIPS

- Arrange the shelves in the required positions before switching the oven ON. Shelf positions are counted from the bottom upwards.
- When cooking more than one dish in the fan oven, place dishes centrally on different shelves rather than cluster several dishes on one shelf, this will allow the heat to circulate freely for the best cooking results.
- When batch baking one type of food, e.g. Victoria sandwich cakes, those of similar size will be cooked in the same time.
- It is recommended that when baking larger quantities the shelf positions should be evenly spaced to suit the load being cooked. A slight increase in cooking time may be necessary.
- **Do not** place baking trays directly on the oven base as it interferes with the oven air circulation and can lead to base burning; use the lower shelf position.



**Do not place cookware and cooking pots with rough bases e.g. cast iron on the oven door as damage to the glass may occur.**

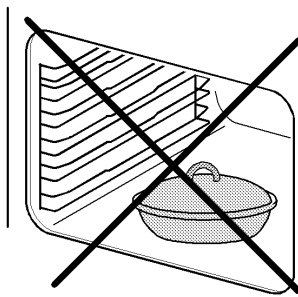
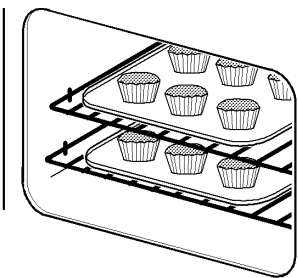
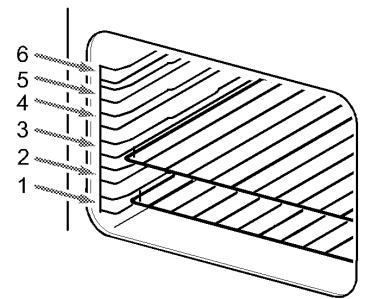
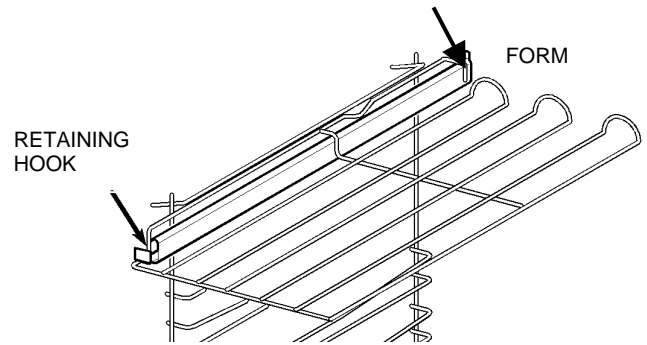
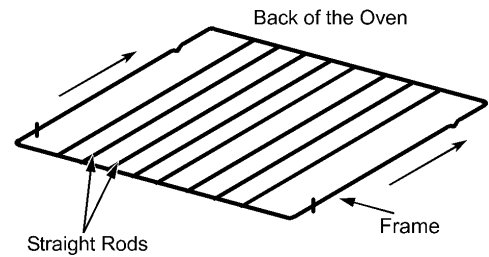



# CONVENTIONAL COOKING

This form of cooking gives you the opportunity to cook without the fan in operation.

It is particularly suitable for dishes which require extra base browning such as pizzas, quiches and flans. Gratins, lasagnes and hotpots which require extra top browning also cook well in the conventional oven. For best results cook on one level.

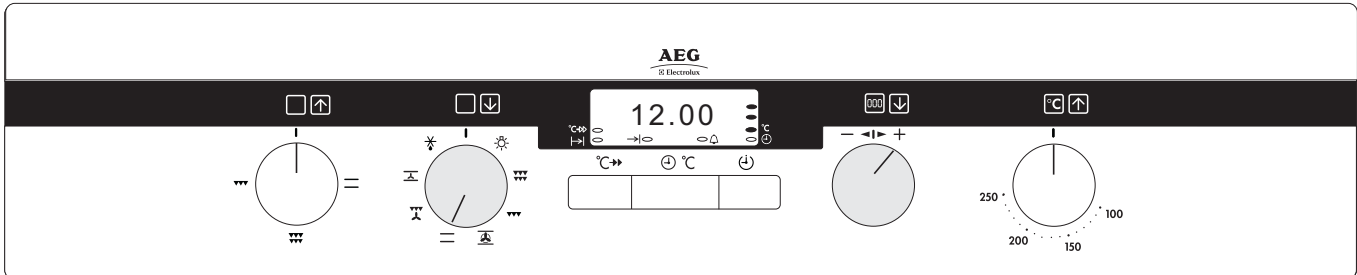
## USING CONVENTIONAL COOKING



- Pop out and turn the multifunction selector to Conventional Cooking. 
- Wait 5 seconds until your choice is confirmed. The temperature will automatically set to 200°C.
- If you wish to alter the set temperature, you may do so by pushing out and turning the main oven increase/decrease selector (+/-) until the required temperature setting is reached.

## THINGS TO NOTE

- If it is necessary to reach the required temperature in a shorter time, the Speedcook Function can be used. See Speedcook Function section.
- When the required temperature is reached the three temperature indicator neons on the timer display will illuminate and an audible signal will sound.
- The multifunction selector indicator neon and the main oven increase/decrease selector neon will glow.
- The main oven temperature neons will illuminate until the oven has reached the desired temperature and then stop. When the oven has been switched off the bars that are still lit indicate the remaining residual heat in the oven.
- The cooling fan for the controls may operate after a time.
- The oven light will illuminate.
- If an automatic programme has been set, the oven fan and light do not come on until cooking begins.
- Some internal noise may be heard during operation. This is quite normal.

## HINTS AND TIPS

- Single level cooking gives best results. If you require more than one level of cooking use the main fan oven.
- The middle shelf allows for the best heat distribution. To increase base browning simply lower the shelf position. To increase top browning raise, the shelf position.
- There should always be at least 2.5cm (1") between the top of the food and the grill element. This gives best cooking results and allows room for rise in yeast mixtures, Yorkshire puddings etc. When cooking cakes, pastry, scones bread etc., place the tins or baking trays centrally on the shelf.
- Ensure that food is placed centrally on the shelf and there is sufficient room around the baking tray or dish to allow for maximum circulation.
- Stand dishes on a suitably sized baking tray on the shelf to prevent spillage onto the oven base and to help reduce cleaning.
- The material and finish of the baking tray and dishes used will affect the degree of base browning. Enamelware, dark, heavy or non-stick utensils increase base browning. Shiny aluminium or polished steel trays reflect the heat away and give less base browning.
- **Do not** place baking trays directly on the oven base as it interferes with the oven air circulation and can lead to base burning; use the lower shelf position.
- For economy leave the door open for the shortest possible time, particularly when placing food into a pre-heated oven.



**Do not place cookware and cooking pots with rough bases e.g. cast iron on the oven door as damage to the glass may occur.**

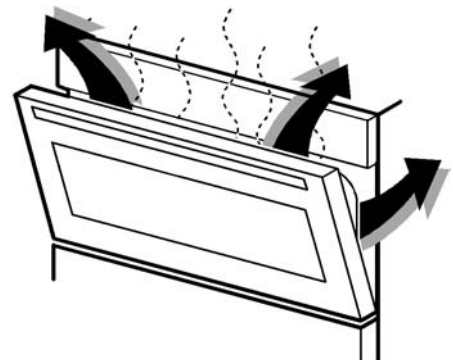
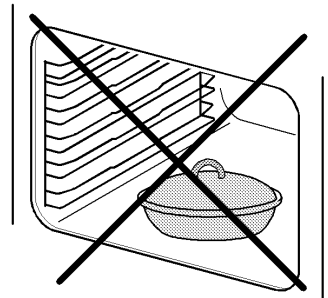
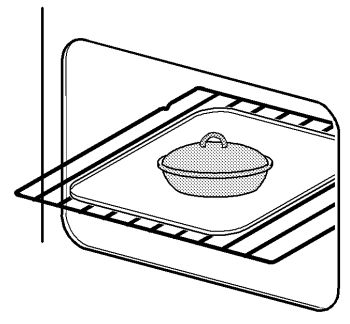
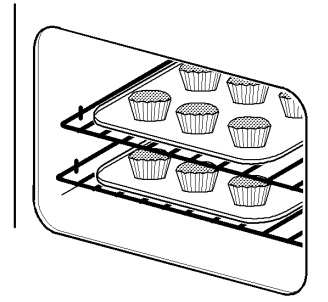

# MAIN OVEN COOKING CHART

The oven temperatures are intended as a guide only. It may be necessary to increase or decrease the temperatures by 10°C to suit individual preferences and requirements.

	VENTITHERM® PRECISION FAN COOKING		CONVENTIONAL OVEN			
Food	Position	Cooking Temp °C	Shelf Position	Cooking Temp °C	APPROX COOK TIME (m)	
Biscuits	Shelf positions are not critical but ensure that oven shelves are evenly spaced when more than one is used	180 - 190	2	180 - 190	10 - 20	
Bread		200 - 220	2	210 - 220	25 - 30	
Casseroles		130 - 160	2	150 - 180	1½ - 2½h	
Cakes: Small & Queen		160 - 170	2	170 - 180	18 - 25	
Sponges		160 - 170	2	170 - 180	20 - 30	
Madeira		140 - 150	2	160 - 170	1¼ - 1½h	
Rich Fruit		130 - 140	2	150 - 160	2 - 2½h	
Christmas		130 - 140	1	130 - 140	3 - 4½h	
						depends on size
Convenience Foods			Follow manufacturer's instructions			
Fish			170 - 190	2	170 - 190	20 - 30
Fruit Pies and Crumbles			190 - 200	3	190 - 200	40 - 60
Milk Puddings		130 - 140	3	130 - 140	1½ - 2h	
Pastry: Choux		190 - 200	2	160 - 170	30 - 35	
Shortcrust		190 - 200	3	190 - 200	15 - 20	
Flaky		210 - 220	3	210 - 220	25 - 40	
Puff		210 - 220	3	210 - 220	25 - 40	
Plate Tarts		180 - 190	2	190 - 200	25 - 45	
Quiches/Flans		170 - 180	2	190 - 200	25 - 45	
Scones		210 - 220	3	220 - 230	8 - 12	

**Note:** Shelf positions are counted from the bottom of the oven.

# ROASTING CHART

INTERNAL TEMPERATURES – Rare : 50-60°C; Medium : 60-70°C; Well done : 70-80°C		
MEAT	TEMPERATURE	COOKING TIME
Beef/ Beef boned	160-180°C	20-35 minutes per ½kg (1lb) and 20-35 minutes over
Mutton/Lamb	160-180°C	25-35 minutes per ½kg (1lb) and 25-35 minutes over
Pork/Veal/Ham	160-180°C	30-40 minutes per ½kg (1lb) and 30-40 minutes over
Chicken	160-180°C	15-20 minutes per ½kg (1lb) and 20 minutes over
Turkey/Goose	160-180°C	15-20 minutes per ½kg (1lb) up to 3½kg (7lb) then 10 minutes per ½kg (1lb) over 3½kg (7lb)
Duck	160-180°C	25-35 minutes per ½kg (1lb) and 25-30 minutes over
Pheasant	160-180°C	35-40 minutes per ½kg (1lb) and 35-40 minutes over
Rabbit	160-180°C	20 minutes per ½kg (1lb) and 20 minutes over

The roasting temperatures and times given in the chart should be adequate for most joints, but slight adjustments may be required to allow for personal requirements and the shape and texture of the meat. However, lower temperatures and longer cooking times are recommended for less tender cuts or larger joints.

Wrap joints in foil if preferred, for extra browning uncover for the last 20 – 30 min. cooking time.



# MAIN OVEN FULL WIDTH GRILL

 **CAUTION – ACCESSIBLE PARTS MAY BE HOT WHEN THE GRILL IS IN USE. YOUNG CHILDREN SHOULD BE KEPT AWAY.**

## USING FULL WIDTH GRILL

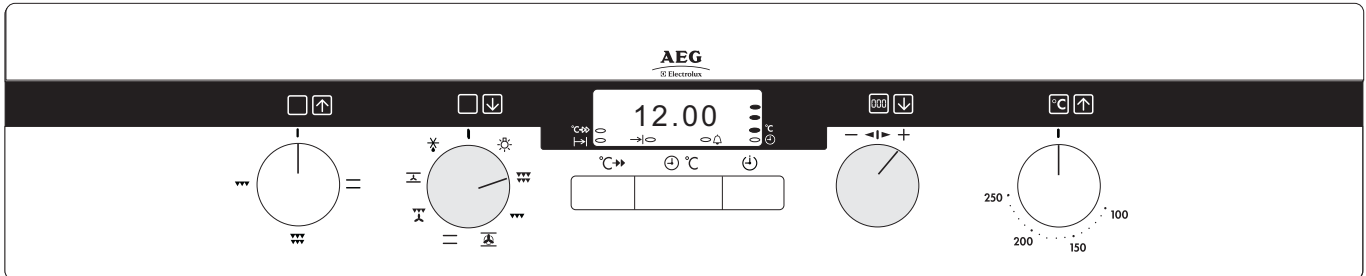

- Pop out and turn the multifunction selector to Full Width Grill. ▼▼▼
- Pop out and turn the multifunction selector for centre section only. ▼▼▼
- Wait 5 seconds until your choice is confirmed. The temperature will automatically set to 250°C.
- If you wish to alter the set temperature, you may do so by pushing out and turning the main oven increase/decrease selector (+/-) until the required temperature setting is reached.

## THINGS TO NOTE

- When the required temperature is reached the three temperature indicator neons on the timer display will illuminate and an audible signal will sound.
- The multifunction selector indicator neon and the main oven increase/decrease selector indicator neon will glow.
- The cooling fan for the controls may operate after a time.
- The oven light will illuminate.
- Some internal noise may be heard during operation. This is quite normal.
- The grill may be used with the door open or with the door closed.

## **i** HINTS AND TIPS

- Most foods should be placed on the grid in the grill pan to allow maximum circulation of air to lift the food out of the fats and juices.
- Adjust the grid and grill pan runner position to allow for different thicknesses of food. Position the food close to the element for faster cooking and further away for more gentle cooking.
- Food should be thoroughly dried before grilling to minimise splashing. Brush lean meats and fish lightly with a little oil or melted butter to keep them moist during cooking.
- Accompaniments such as tomatoes and mushrooms may be placed around the outer edges or underneath the grid when grilling meats.
- When toasting bread, we suggest that the top runner position is used with the grid in its 'high' position.
- Preheat the grill on full setting for a few minutes to seal meat or for toasting. Adjust the heat setting and the shelf position as necessary during cooking.
- The food should be turned over during cooking as required.

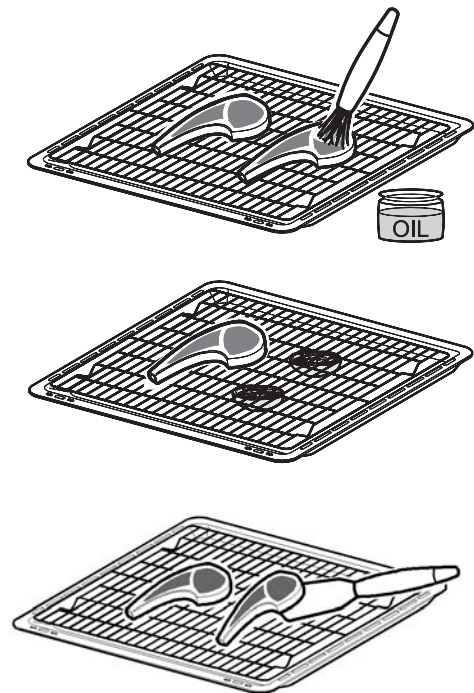

## GRILLING CHART

FOOD	SHELF	GRILL TIME (mins in total)
Bacon Rashers	Adjust	5-6
Beefburgers	shelf	10-15
Chicken Joints	position	30-40
Chops - Lamb	and	15-20
Pork	grill	20-30
Fish - Whole		
Trout/Mackerel	pan	15-25
Fillets - Plaice/Cod	grid	10-15
Kebabs	to	20-30
Kidneys - Lamb/Pig	suit	8-12
Sausages	different	20-30
Steaks - Rare	thicknesses	6-12
Medium		12-16
Well Done	of	14-20
Toasted Sandwiches	food	3-4

The times quoted above are given as a guide and should be adjusted to suit personal taste.

# PIZZA

This setting can be used for foods such as pizza where base browning and crispness are required. The top and lower elements operate in conjunction with the oven fan.

## USING PIZZA

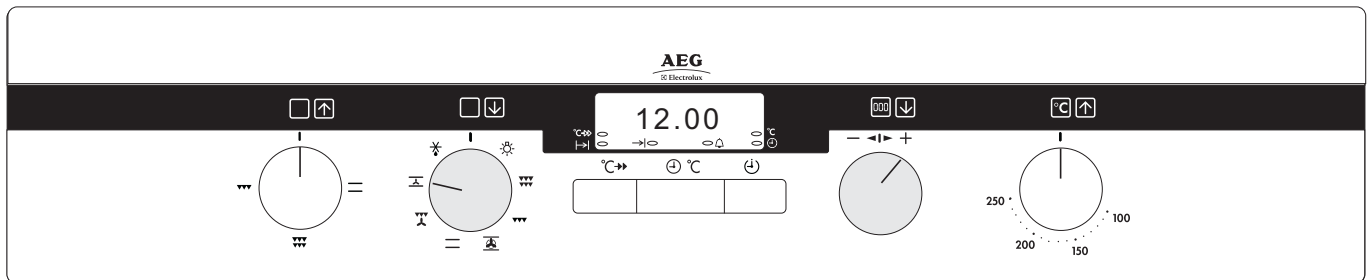

- Pop out and turn the multifunction selector to Pizza. 
- Wait 5 seconds until your choice is confirmed. The temperature will automatically set to 150°C.
- If you wish to alter the set temperature, you may do so by pushing out and turning the main oven increase/decrease selector (+/-) until the required temperature setting is reached.

## THINGS TO NOTE

- If it is necessary to reach the required temperature in a shorter time, the Speedcook Function can be used. See Speedcook Function section.
- When the required temperature is reached the three temperature indicator neons on the timer display will illuminate and an audible signal will sound.
- The multifunction selector indicator neon and the main oven increase/decrease selector indicator neon will glow.
- The main oven temperature neons will illuminate until the oven has reached the desired temperature and then stop. When the oven has been switched off the bars that are still lit indicate the remaining residual heat in the oven.
- The cooling fan for the controls may operate after a time.
- The oven light will illuminate.
- If an automatic programme has been set, the oven fan and light do not come on until cooking begins.
- Some internal noise may be heard during operation. This is quite normal.

## HINTS AND TIPS

- Single level cooking using the middle shelf position gives best results.
- Ensure that food is placed centrally on the shelf for maximum air circulation.
- Be guided by the cook times and temperatures given on any packaging.
- Some pizzas should be cooked directly on the oven shelf. To prevent soiling the oven base, place a baking tray in one of the lower shelf positions.



**Do not place dishes, tins or baking trays directly onto the oven base as it becomes very hot and damage may occur.**

- The material and finish of the baking trays and dishes used will affect base browning. Enamelware, dark heavy or non-stick utensils increase base browning. Shiny aluminium or polished steel trays reflect the heat away and give less base browning.

# ROTITHERM ROASTING

Rotitherm Roasting offers an alternative method of cooking food items normally associated with conventional grilling.

Rotitherm Roasting helps to minimise cooking smells in the kitchen and allows you to grill with the oven door closed.

With the exception of toast and rare steaks you can Rotitherm Roast all the foods you would normally cook under a conventional grill.

## COOKING TIMES

Cooking is more gentle, therefore food generally takes a little longer to cook when Rotitherm Roasting compared with conventional grilling. One of the advantages is that larger loads can be cooked at the same time.

The lower part of the oven can be used to cook accompaniments at the same time, e.g. tomatoes and mushrooms with a mixed grill or breakfast.

Dishes prepared in advance such as shepherd's pie, lasagne and au gratins can be heated through and browned on the top using the Rotitherm Roasting function.

## USING ROTITHERM ROASTING

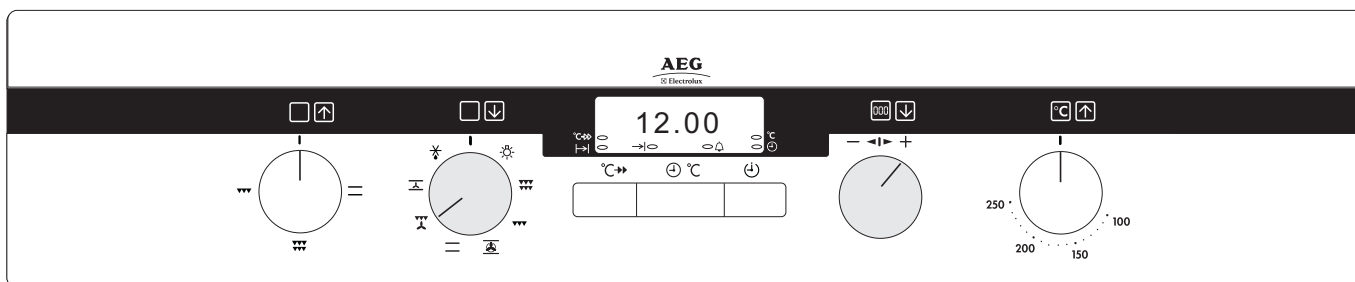

**Always Rotitherm Roast with the oven door closed and the grill pan handle removed.**

- Pop out and turn the multifunction selector to Rotitherm Roasting. 
- Wait 5 seconds until your choice is confirmed. The temperature will automatically set to 180°C.
- If you wish to alter the set temperature, you may do so by pushing out and turning the main oven increase/decrease selector (+/-) until the required temperature setting is reached.

## THINGS TO NOTE

- If it is necessary to reach the required temperature in a shorter time, the Speedcook Function can be used. See Speedcook Function section.
- When the required temperature is reached the three temperature indicator neons on the timer display will illuminate and an audible signal will sound.

- The multifunction selector indicator neon and the main oven increase/decrease selector indicator neon will glow.
- The main oven temperature neons will illuminate until the oven has reached the desired temperature and then stop. When the oven has been switched off the bars that are still lit indicate the remaining residual heat in the oven.
- The oven fan cycles as part of the cooking function.
- The cooling fan for the controls may operate after a time.
- The oven light will illuminate.
- If an automatic programme has been set, the oven fan and light do not come on until cooking begins.
- Some internal noise may be heard during operation. This is quite normal.

## **i** HINTS AND TIPS

- Prepare foods in the same way as for conventional grilling. Brush lean meats and fish lightly with a little oil or butter to keep them moist during cooking.
- Most food should be placed on the grill pan grid in the 'high' position in the grill pan to allow maximum circulation of air around the food.
- Accompaniments such as tomatoes and mushrooms may be placed below the grid when grilling meats, or in a separate dish on a lower shelf.
- Foods will cook more quickly the closer they are to the grill element and the higher the temperatures selected. Be prepared to adjust temperatures and shelf positions during cooking if necessary.
- Turn food over during cooking as necessary.
- Ensure that ready prepared or cooked chilled dishes e.g. shepherds pie, moussaka, lasagne, etc., are piping hot throughout before serving.
- A temperature range of 140°C - 220° is suitable for most foods. Be prepared to make suitable adjustments during cooking to suit individual requirements. If Rotitherm Roasting on more than one level, it may be necessary to interchange the food on the shelves during cooking.

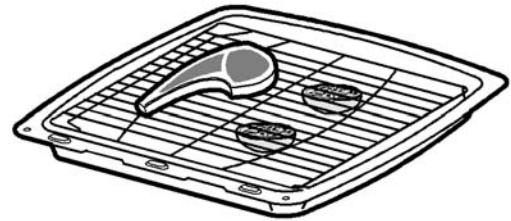
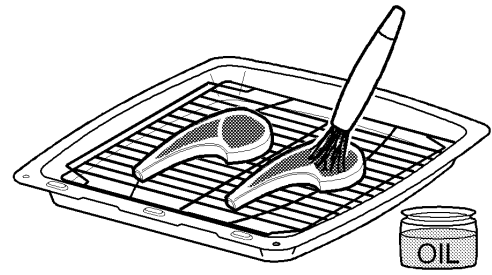

## ROTITHERM ROASTING CHART

FOOD	SHELF	TEMP (°C)	TIME (mins In total)
Bacon Rashers	4	200	8-12
Beefburgers	4	190	10-15
Chicken Joints	4	160	35-45
Chops - Lamb/Pork	4	170	20-35
Fish - Whole			
Trout/Mackerel	3	170	10-20
Fillets - Plaice/Cod	3	170	10-15
Kebabs	4	170	20-30
Kidneys - Lamb/Pig	4	180	10-15
Liver - Lamb/Pig	4	180	10-15
Sausages	4	190	10-15
Steaks - Medium	4	220	8-10
			each side
Steaks - Well Done	4	220	10-15
			each side
Heating through and Browning, e.g. Au-gratin, Lasagne, Shepherd's Pie.	3	170	20-30 depends on size

**NOTE:** Shelf positions are counted from the bottom of the oven.

Times quoted above are given as a guide and should be adjusted to suit personal taste.

# SPEEDCOOK

Speedcook is ideal for quick preheating of the oven.

## USING SPEEDCOOK

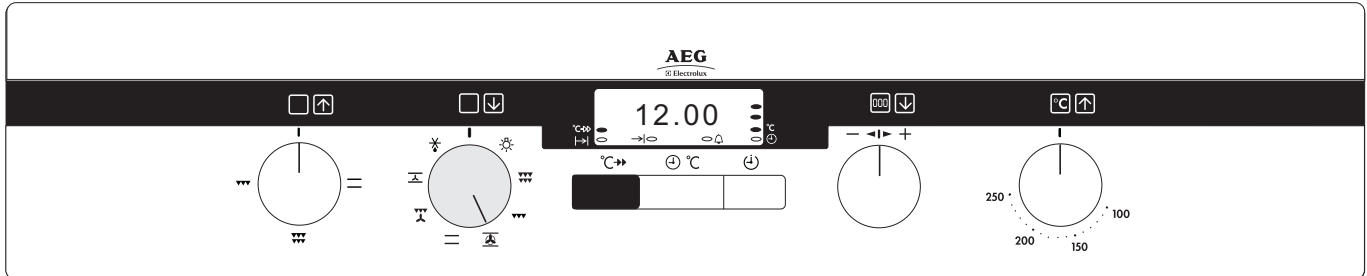

After a cooking function has been selected and the temperature has been adjusted, the cavity will gradually heat up until the selected temperature is reached. This will take from 10 to 15 minutes, depending on selected function and temperature. If it is necessary to reach the required temperature in a shorter time, the Speedcook Function can be used.

### SELECTING SPEEDCOOK

- Set the required cooking function and temperature as explained in the previous pages.
- Press the Speedcook control button. The Speedcook neon will illuminate ( °C→ ) and the temperature indicator neons ( °C ) will flash.
- When the required temperature is reached the three temperature indicator neons on the timer display will illuminate and an audible signal will sound.
- The Speedcook neon will go out.
- The selected cooking function will resume.

### THINGS TO NOTE

The Speedcook Function will override the selected main oven function until the required temperature is reached then return to the selected main oven function.

The Speedcook function cannot be used with the Second Oven, Main Oven Full Width Grill or Fan Controlled Defrosting.

# FAN CONTROLLED DEFROSTING

This main oven function enables you to defrost most foods without heat faster than some conventional methods as the oven fan circulates air around the food. It is particularly suitable for delicate frozen foods which are to be served cold e.g. cream filled gateaux, cakes covered with icings or frostings, cheesecakes, biscuits, scones, etc.

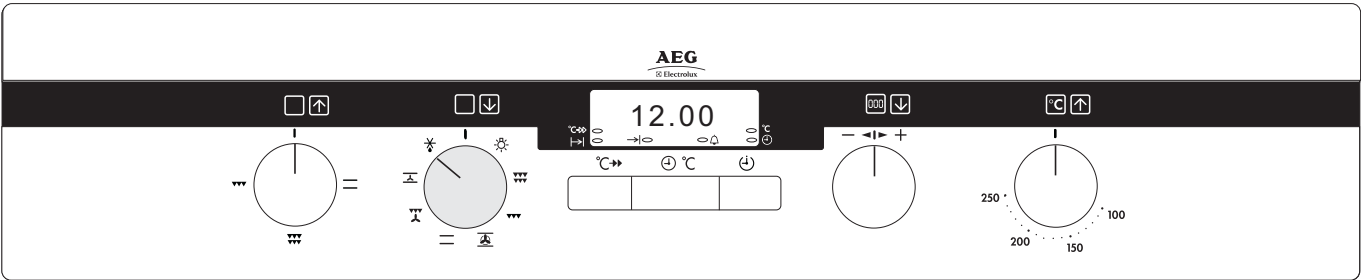

## USING FAN CONTROLLED DEFROSTING

- Pop out and turn the multifunction selector to Fan Controlled Defrosting. ✖
- Wait 5 seconds until your choice is confirmed. The temperature will automatically set to 30°C.

## THINGS TO NOTE

- The oven fan and oven light will come on
- The cooling fan does not operate.

## **i** HINTS AND TIPS

- Place the frozen food in a single layer where possible and turn it over half way through the defrosting process.
- The actual speed of defrosting is influenced by room temperature. On warm days defrosting will be faster than on cooler days.
- It is preferable to thaw fish, meat and poultry slowly in the fridge. However, this process can be accelerated by using the defrost function. Small or thin fish fillets, frozen peeled prawns, cubed or minced meat, liver, thin chops, steaks etc., can be thawed in 1 – 2 hours.
- A 1kg/2¼lb oven ready chicken will be thawed in approximately 5 hours. Remove the giblets as soon as possible during the thawing process.
- Joints of meat up to 2kg/4½lb in weight can be thawed using the defrost function.
- All joints of meat and poultry must be thawed thoroughly before cooking.
- Always cook thoroughly immediately after thawing.
- **Do not** leave food at room temperature once it is defrosted. Cook raw food immediately or store cooked food in the fridge, once it has been cooled.
- Care must always be taken when handling foods in the home. Always follow the basic rules of food hygiene to prevent bacterial growth and cross contamination when defrosting, preparing, cooking, cooling and freezing foods.

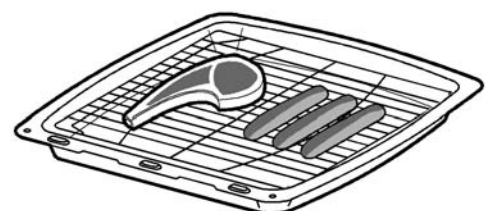
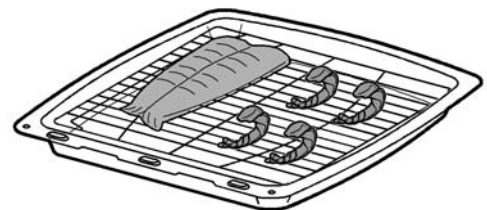
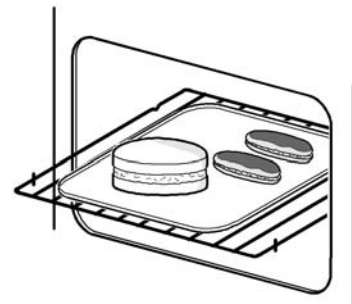

# CARE AND CLEANING

 **Before cleaning always allow the appliance to cool down before switching off at the electricity supply.**

## CLEANING MATERIALS

Before using any cleaning materials on your appliance, check that they are suitable and that their use is recommended by the manufacturer.

Cleaners that contain bleach should NOT be used as they may dull the surface finishes. Harsh abrasives and scourers should also be avoided as damage will occur.

## CLEANING THE OUTSIDE OF THE APPLIANCE

**Do not** use abrasive cleaning materials e.g. Hob Brite, Brillo pads or scourers on painted or printed finishes as damage may occur.

Regularly wipe over the control panel, doors and handles using a soft cloth and hot soapy water. To prevent streaking finish with a soft cloth.

Stainless Steel cream cleaners are abrasive and should be avoided as they may dull the surface finish. **Any spillage on the stainless steel finish must be wiped off immediately.**

 **Do not attempt to remove any of the control knobs from the panel as this may cause damage and is a safety hazard.**

 **Under no circumstances should the door assembly be detached from the product for cleaning.**

## REMOVING AND REPLACING WIREWORK RUNNERS

Remove all shelves and furniture from the oven.

Hold the wirework at the bottom, unclip from the cavity side and gently pull towards the centre of the oven.

Unhook the runner at the top and remove from the cavity.

To replace, ensure the side panel is assembled on to the wirework runner before hooking it back into the oven.

To replace the runners, hook the wirework side runner into the cavity, slide back and press into place.

 **Ensure the wirework runners are firmly in position before replacing the oven shelves.**

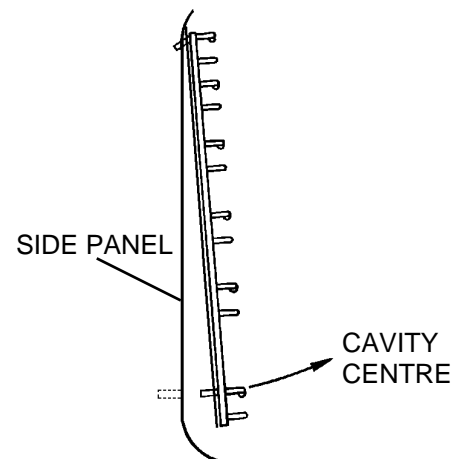
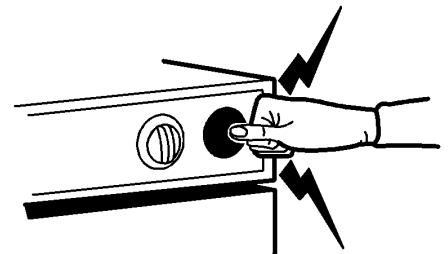
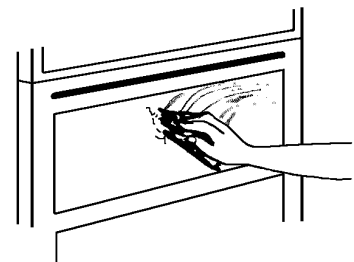
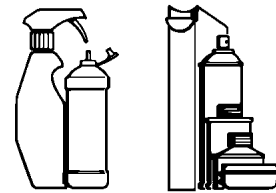



## CLEANING INSIDE THE OVENS

The sides and back of the grill/second oven and main oven compartments are coated with a special Stayclean coating. They should not be cleaned manually.

The vitreous enamel main oven base and grill compartment base can be cleaned using normal oven cleaners with care. Ensure that the manufacturers instructions are followed and that all parts are well rinsed afterwards.



**Aerosol cleaners must not come into contact with elements, the door seal, or any painted finishes as this may cause damage.**

## HINTS AND TIPS



**Aerosol cleaners must not be used on Stayclean surfaces.**

Stayclean surfaces destroy splashes of food and fats when the oven temperature is raised to around 220°C.

It is a good idea to run the oven for an hour or two per week to ensure continued good performance from the Stayclean finish.

Slight discolouration and polishing of the Stayclean surfaces may occur in time. This **DOES NOT** affect the Stayclean properties in any way.

Use minimal, if any, extra oil or fat when roasting meat, potatoes only require brushing with fat before cooking. Extra fat in the oven during roasting will increase splashing and soilage.

It is **NOT** necessary to add water to a meat tin when roasting. The water and the fat juices from the joint create excessive splattering during cooking – even at normal temperatures, as well as causing condensation.

Covering joints during cooking will also prevent splashing onto the interior surfaces. Removing the covering for the last 20-30 minutes will allow extra browning if required. Some large joints and turkeys especially benefit by this method of cooking, allowing the joint to cook through before the outside is over-browned.

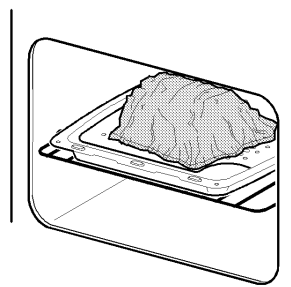
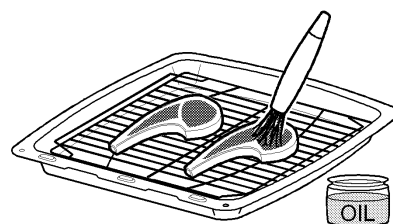

## CLEANING THE DOOR(S)



To prevent damaging or weakening the door glass panels avoid the use of the following:

- Household detergents and bleaches
- Impregnated pads unsuitable for non-stick saucepans
- Brillo/Ajax pads or steel wool pads
- Chemical oven pads or aerosols
- Rust removers
- Bath/Sink stain removers



Under no circumstances should the door assembly be detached from the product for cleaning.

### TO REMOVE THE INNER GLASS

1. Fully open the door.
2. Firmly grasp the rear edge of the inner glass panel with both hands.
3. Push the glass panel towards you until it clears the hinge location points at the rear.
4. With one hand, carefully lift the glass panel to disengage it from the location points under the handle. **(With your other hand, hold the outer door to ensure it does not spring shut on removing the inner panel).**
5. Close the oven door.

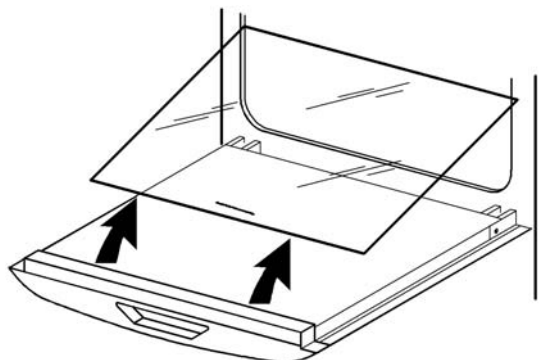
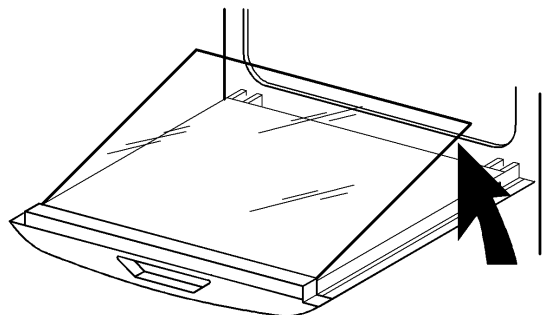
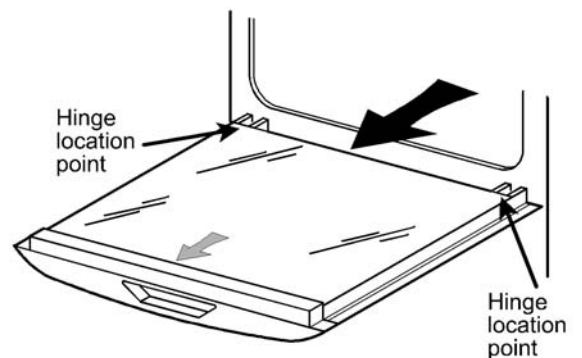

If the door glass panel becomes chipped or has deep scratches the glass will be weakened and must be replaced to prevent the possibility of the panel shattering. Please contact your local Service Force Centre who will be pleased to advise further.

### TO CLEAN THE INNER GLASS DOOR PANEL

Clean the inner door glass panel using a soft cloth and hot water to which a little washing up liquid has been added. If the inner panel is heavily soiled, Hob Brite may be used. **Do not** use abrasive cleaning materials on the door glass. Ensure that all parts are well rinsed and thoroughly dried before attempting to replace the glass.



**Do not** clean stainless steel outer panels (where fitted) with Hob Brite as damage to the finish will occur.

## TO REPLACE THE INNER GLASS DOOR PANEL

1. Holding the glass panel in your right hand fully open the oven door with your left.
2. Gently ease and push the glass into the location points under the handle before lowering and sliding the glass into position under the hinge location points at the rear.

Ensure the glass is properly located and the text 'This way up' is facing towards you and at the top edge of the door.



**Do not attempt to use the oven without the glass being in place.**

## CLEANING THE GRILL AND OVEN FURNITURE

All removable parts, except the grill pan handle can be washed in the dishwasher.  
The grill pan, grill pan grid, and oven shelves may be cleaned using a soap impregnated steel wool pad. Soaking first in hot soapy water will make cleaning easier.

## REPLACING AN OVEN LIGHT BULB (MAIN OVEN)



**Disconnect the appliance from the electricity supply before replacing the bulb.**

The type of bulb required is a 300°C 25 watt small Edison Screw.

1. Make sure the appliance is cool before replacing the bulb.
2. Open the door and remove the shelves and wirework runners.
3. Pull the glass bulb cover towards you and then pull it off. If necessary, use a screwdriver to carefully lever off the cover, taking care not to damage the oven cavity.
4. Unscrew the bulb by turning it to the left.
5. Fit a new bulb and then replace the glass bulb cover.
6. Refit the wirework runners and replace the oven shelves.
7. Restore the electricity supply and reset the time of day.

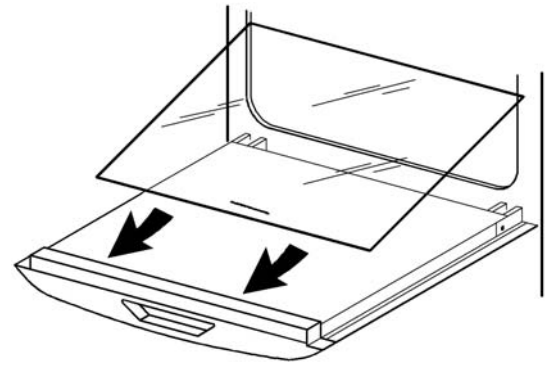

PLACE PALM AT TOP OF LENS  
FLAT AGAINST OVEN SIDE

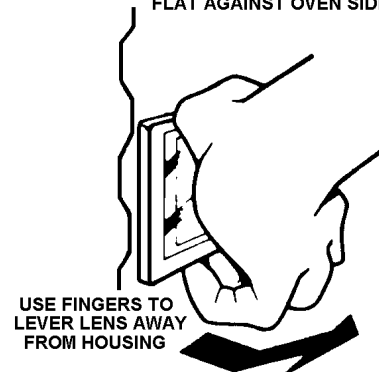

## REPLACING AN OVEN LIGHT BULB (TOP OVEN)

The type of bulb required is a 300°C 25 watt small Edison Screw.

---

 **Disconnect the appliance from the electricity supply before replacing the bulb.**

---

1. Make sure the appliance is cool before replacing the bulb.
2. Open the door and remove the shelves and wirework runners.
3. Remove the glass cover by turning it to the left.
4. Unscrew the bulb by turning it to the left.
5. Fit a new bulb and then replace the glass bulb cover.
6. Refit the wirework runners and replace the oven shelves.
7. Restore the electricity supply and reset the time of day.

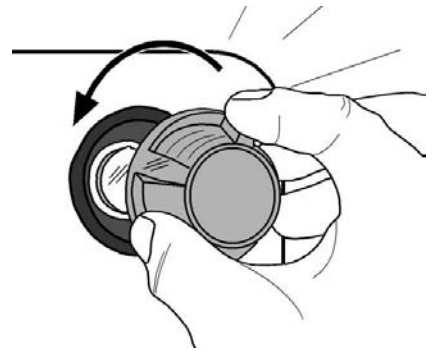

# SOMETHING NOT WORKING

Please carry out the following checks on your appliance before calling a Service Engineer. It may be that the problem is a simple one which you can solve yourself without the expense of a service call.

**In-guarantee customers should make sure that the checks have been made as the engineer will make a charge if the fault is not a mechanical or electrical breakdown.**

Please note that proof of purchase is required for in-guarantee service calls.

PROBLEM	POSSIBLE SOLUTION
<b>The grill, ovens and timer do not work.</b>	<p>Check that the appliance has been wired in to the appliance supply and is switched on at the wall.</p> <p>Check that the main appliance fuse is working.</p> <p>If you have checked the above: Allow the appliance to cool for a couple of hours. The appliance should now be working normally.</p>
<b>The grill and second oven work but the main oven does not.</b>	<p>Check that the time of day has been set on the clock.</p> <p>Check that the oven is set for manual cooking.</p>
<b>The grill does not work or cuts out after being used for a long period of time.</b>	<p>Ensure the cooling fan is running when the grill is on. If the cooling fan fails, the grill will not operate correctly. Contact your local Service Force Centre.</p> <p>Leave the grill door open and allow the grill to cool. After a couple of hours check that the grill works as normal</p>
<b>The timer does not work.</b>	<p>Check that the instructions for the operation of the timer are being closely followed.</p>
<b>The indicator neons are not working correctly.</b>	<p>Check that you have selected only the function you require. Ensure all other controls are in the Off position.</p>
<b>The oven is not cooking evenly.</b>	<p>Check that the appliance is correctly installed and is level.</p> <p>Check that the recommended temperatures and shelf positions are being used.</p>
<b>The oven light fails to illuminate.</b>	<p>The oven light bulb may need replacing.</p> <p>If the Main Oven is set for automatic cooking the light will illuminate when the cook time begins.</p>
<b>The oven fan is noisy.</b>	<p>Check that the oven is level.</p> <p>Check that the shelves and bakeware are not vibrating in contact with the oven back panel.</p>
<b>The oven temperature is too high or too low.</b>	<p>Check that the recommended temperatures and shelf positions are being used. Be prepared to adjust the temperature up or down by 10°C to achieve the results you want.</p>

# SERVICE AND SPARE PARTS

In the event of your appliance requiring service, or if you wish to purchase spare parts, please contact your local Service Force Centre by telephoning:-

**0870 5 929929**

Your telephone call will be automatically routed to the Service Force Centre covering your post code area.

For the address of your local Service Force Centre and further information about Service Force, please visit the website at [www.serviceforce.co.uk](http://www.serviceforce.co.uk)

Before calling out an engineer, please ensure you have read the details under the heading "Something Not Working".

When you contact the Service Force Centre you will need to give the following details:

1. Your name, address and post code.
2. Your telephone number.
3. Clear and concise details of the fault.
4. The model and serial number of the appliance (found on the rating plate).
5. The purchase date.

**Please note that a valid purchase receipt or guarantee documentation is required for in-guarantee service calls.**

For Customer Service in Ireland please contact us at the address below:

AEG-Electrolux  
Electrolux Group (Irl) Ltd  
Long Mile Road  
Dublin 12  
Republic of Ireland

Tel: +353 (0) 1 4090754

Email: [service.eid@electrolux.ie](mailto:service.eid@electrolux.ie)

## CUSTOMER CARE DEPARTMENT

For general enquires concerning your AEG-Electrolux appliance, or for further information on AEG-Electrolux products, please contact our Customer Care Department by letter or telephone at the address below or visit our website at [www.aeg-electrolux.co.uk](http://www.aeg-electrolux.co.uk)

Customer Care Department  
AEG-Electrolux  
Major Appliances  
Addington Way  
Luton  
Bedfordshire  
LU4 9QQ  
Tel: 0870 5 350350 (\*)

\*calls to this number may be recorded for training purposes.

# GUARANTEE CONDITIONS

## Standard guarantee conditions

AEG-Electrolux offer the following guarantee to the first purchaser of this appliance:

1. The guarantee is valid for 12 months commencing when the appliance is handed over to the first retail purchaser, which must be verified by purchase invoice or similar documentation.  
The guarantee does not cover commercial use.
2. The guarantee covers all parts or components which fail due to faulty workmanship or faulty material. The guarantee does not cover appliances where defects or poor performance are due to misuse, accidental damage, neglect, faulty installation, unauthorised modification or attempted repair, commercial use or failure to observe requirements and recommendations set out in the instruction book  
This guarantee does not cover such parts as light bulbs, removable glassware or plastic.
3. Should guarantee repairs be necessary the purchaser must inform the nearest customer service office (AEG-Electrolux's service or authorised agent). AEG-Electrolux reserves the right to stipulate the place of repair (i.e. the customer's home place of installation or AEG-Electrolux workshop).
4. The guarantee of free replacement includes both labour and materials.
5. Repairs carried out under guarantee do not extend the guarantee period for the appliance. Parts removed during guarantee repairs become the property of AEG-Electrolux.
6. The Purchaser's statutory rights are not affected by this guarantee.

## European Guarantee

If you should move to another country within Europe then your guarantee moves with you to your new home subject to the following qualifications:

- The guarantee starts from the date you first purchased your product.
- The guarantee is for the same period and to the same extent for labour and parts as exists in the new country of use for this brand or range of products.
- This guarantee relates to you and cannot be transferred to another user.
- Your new home is within the European Community (EC) or European Free Trade Area.
- The product is installed and used in accordance with our instructions and is only used domestically, i.e. a normal household.
- The product is installed taking into account regulations in your new country.

Before you move please contact your nearest Customer Care centre, listed below, to give them details of your new home. They will then ensure that the local Service Organisation is aware of your move and able to look after you and your appliances.

France	Senlis	+33	(0) 3 44 62 29 29
Germany	Nürnberg	+49	(0) 800 234 7378
Italy	Pordernone	+39	(0) 800117511
Sweden	Stockholm	+46	(0) 8 672 53 60
UK	Luton	+44	(0) 8705 350 350
Ireland	Dublin	+353	(0) 1 4090754

## TECHNICAL DETAILS

Voltage: 230-240 Volts AC 50Hz

Wattage: 5.8-6.3kW

Height: 897 mm

Width: 592 mm

Depth: 563 mm  
(excluding handles and knobs)

Weight: 59kg



This appliance complies with: European Council Directive 73/23/EEC.  
EMC Directive 89/336/EEC.  
CE Marking Directive 93/68/EEC. Energy Label Directive 2002/40/EC.



# INSTALLATION INSTRUCTIONS

## WARNINGS



- This appliance must be installed by a qualified electrician/competent person. Safety may be impaired if installation is not carried out in accordance with these instructions.
- This appliance must be earthed.
- Do not remove the screws from the earth tab extending from the oven mains terminal block (Fig. 1).
- Before connecting the appliance make sure that the voltage of your electricity supply is the same as that indicated on the rating plate. This is situated on the lower front frame of the appliance and can be seen upon opening the door. Alternatively the rating plate may also be found on the back or top of some models (where applicable).
- Do not alter the electrical circuitry of this appliance.

## THINGS TO NOTE

- This appliance is designed to be fitted in cabinets of the recommended dimensions as shown (Fig.3).
- If your cabinet interior dimension is between 565-570mm the oven may still be fitted. However, a minor modification to the cabinet will be required to reduce the aperture size down to 560-565 mm, to allow the product to be securely screwed into the cabinet.
- The dimensions given provide adequate air circulation around the unit within the cabinet, ensuring compliance with BS EN60-335.
- Enquiries regarding the installation of the cooker point, if required, should be made to your Regional Electricity Company to ensure compliance with their regulations.
- The appliance socket switch should be outside the cabinet but within 2m of the appliance to make it accessible to switch off the appliance in case of an emergency.
- To protect the hands, wear gloves when lifting the oven into its housing.



**Do not lift the appliance by the handles.**

## NOTE: HOUSE CIRCUIT

Earth leakage and continuity tests must be carried out before the appliance is connected to the mains supply and re-checked after fitting.

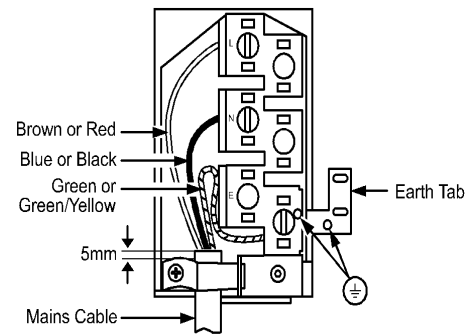

Fig.1

## CHOICE OF ELECTRICAL CONNECTION

- There are three possible ways to connect your appliance. In each case the appliance should be operated using at least 6mm<sup>2</sup> twin core and earth PVC insulated. Please choose from the most appropriate after reading the different methods:-
- a) By connecting the appliance to a cooker point (having a double pole isolating switch with at least 3mm contact separation in all poles and neutral) and protected with a fuse or miniature circuit breaker at your mains fuse box.

**Subject to Regional Electricity Companies regulations if you wish to connect the oven and hob to the power supply you may use one of the following two methods:-**

- b) By connecting the appliance together with a hob directly to a cooker point(s). Having a double pole isolating switch with at least 3mm contact separation in all poles and neutral.
- c) If you wish to connect an oven and a hob to a cooker point you can by connecting the oven and hob separately to the cooker point. Oven and hob units should be separately connected to a cooker point. See Fig. 2.

**NOTE:** It is good practice to :

- Fit an Earth Leakage Circuit Breaker to your house wiring.
- Wire your appliance to the latest IEE regulations.

## PREPARING CABINET FOR FITTING OF OVEN

- Make sure that the cabinet is the correct size for the appliance to be fitted (Ref. Fig. 3).
- If the size is between 565-570mm, then the cabinet should be modified so that at the screw fixing points the recommended dimension of at least 560-565mm is maintained. The modification should ideally be localised to ensure that after screw fitment the oven is **securely** fixed into position.
- The cabinet must be stable and level by firmly securing it to the wall or floor. If necessary, make arrangements to ensure the shelf upon which the oven will rest is level.
- When the appliance is installed ensure a minimum gap of 2mm is maintained between the trim on the bottom edge of the appliance, and any corresponding door / panel underneath.

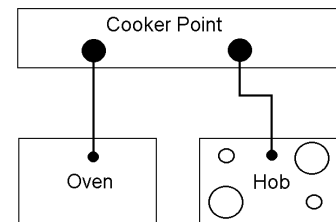

Fig. 2

# RECOMMENDED CABINET DIMENSIONS (IN MILLIMETRES)

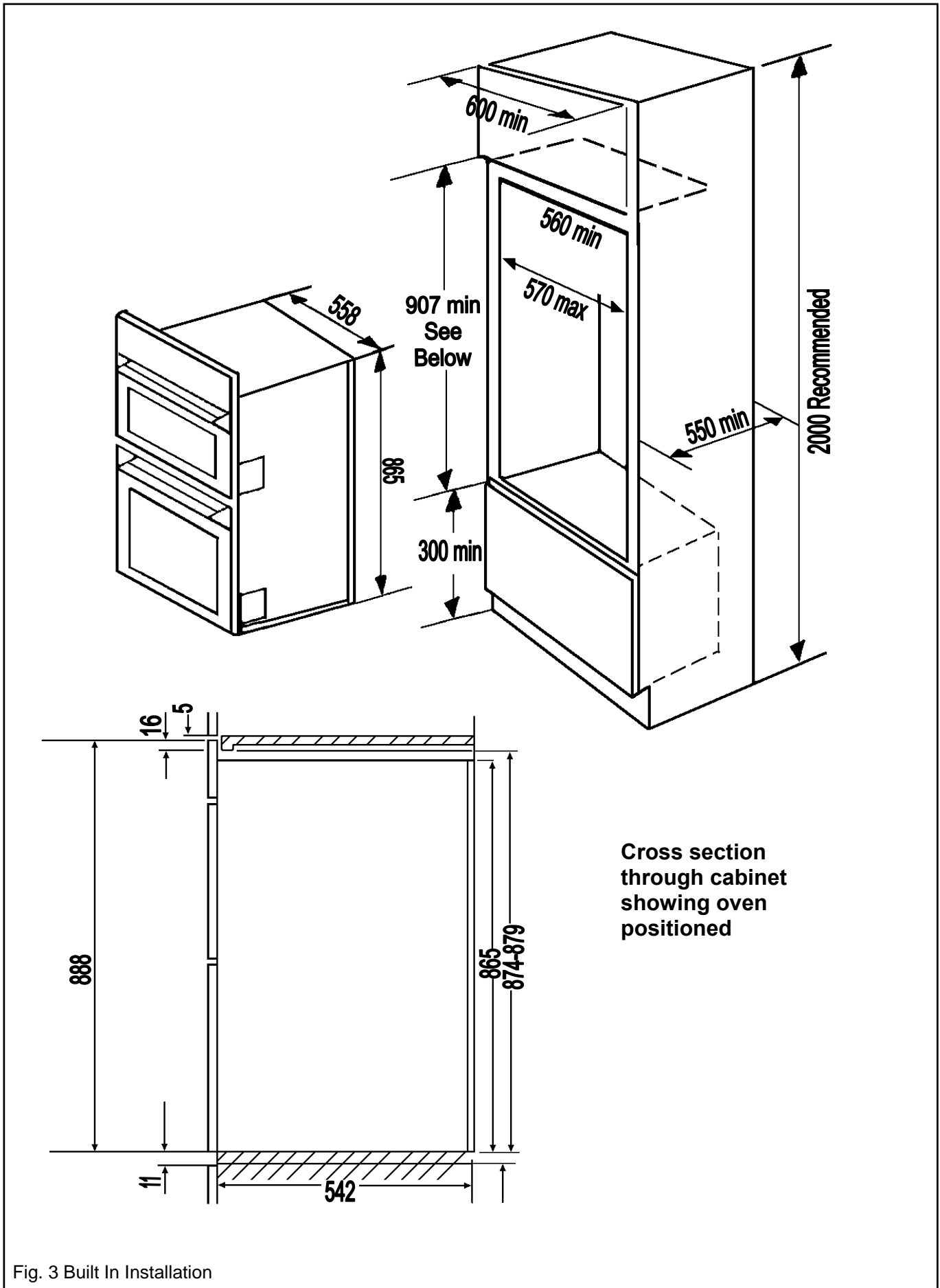

Fig. 3 Built In Installation

## HOW TO FINISH UNPACKING

- Place packed appliance next to the space in which it will be installed.
- Remove the appliance packing except for bottom tray which should be left in position until the appliance is ready to be fitted into its cabinet.

**NOTE: It is imperative that the appliance is left in the base to protect both the appliance and the floor.**

- Ensure the user is given these operating instructions.



**Important: Switch off at the mains, miniature circuit breaker and if appropriate, remove fuse before commencing any electrical work.**

## TO REMOVE COVER OF MAINS TERMINAL

From the rear of the appliance, remove mains input terminal cover to gain access to terminal block.

- First remove retaining screw with pozidrive screwdriver. See Fig. 4.
- Prise cover loose using screwdriver in position (1) then lever off with screwdriver in position (2) at either side. See Fig. 5.
- Lift cover and remove screw from cable clamp. See Fig. 6.

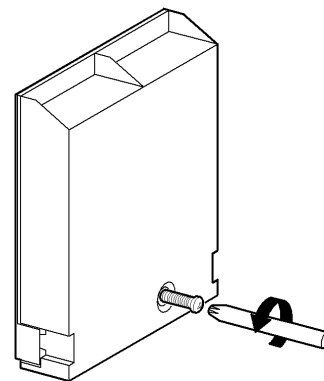

Fig. 4

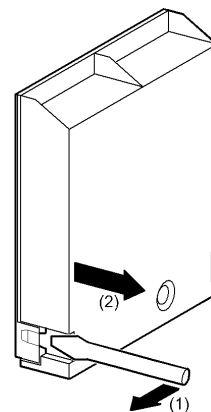

Fig.5

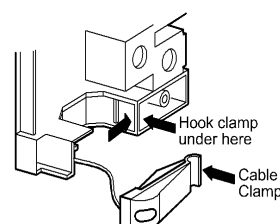

Fig.6

## CONNECTING TO THE MAINS TERMINAL



**Warning: This appliance must be earthed.**

- We recommend you use a new length of 6mm<sup>2</sup> twin core and earthed cable to ensure your safety.
- Make connection as shown in Fig. 7 by proceeding as follows:-
- Preform wires to the appropriate shape to suit fitting into the mains terminal block.
- Strip inner insulation on wires using wirestrippers.
- Twist the bared wires using pliers.
- Cut bared wires 10mm away from the end of the inner insulation. Where uninsulated Earth wires are used ensure they are suitably sheathed to leave 10mm bare wire to fit into the terminal.
- Clamp bare wires into the relevant terminal and check they are held by tugging each one in turn.
- Clamp the mains cable securely ensuring 5mm of the outer insulation is inside the terminal block and that the wires are not taugt but not so slack as to cause any fouling. See Fig. 7.
- Place fuse/miniature circuit breaker in circuit and switch on at mains.

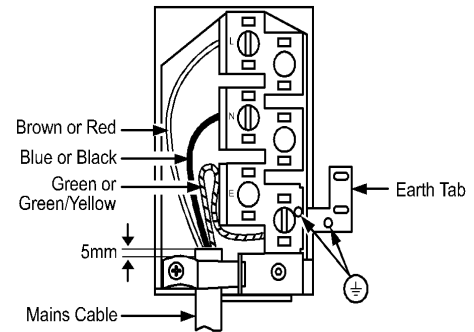

Fig.7

## CHECKING ELECTRICAL CONNECTIONS

Correct electrical connection can be confirmed when switching on the appliance as the timer will be flashing.

### NOTE: HOUSE CIRCUIT

Earth leakage and continuity tests must be carried out before the appliance is connected to the mains supply and re-checked after fitting.

## CONNECTING TO A HOB OR COOKER POINT

- Either follow in general terms the instructions for connecting to the terminal block or refer to the hob suppliers installation instructions.



**Feed the cable through the cabinet and arrange to route the cable away from the appliance which may become hot.**

## FITTING INTO THE CABINET



**IMPORTANT:** Ensure that the oven is switched off at the wall before any further work is carried out.

- Using a tape measure establish the internal width of the cabinet. Refer to page 40 if greater than 565mm.
- Position the appliance in front of the cabinet. See Fig. 8.
- Take out all oven furniture before installation to reduce the weight you need to lift. The oven door should be taped up to keep it closed whilst lifting.
- To place the appliance into the cabinetry follow the procedure below:
- **N.B. Two people will be required to carry out the lifting procedure.**



**Warning:** Do not attempt to lift this appliance by the handle(s).

- a) Each person should squat either side of the appliance.
- b) Tilt the appliance so that your hands can support the underside of the appliance.
- c) Keeping your back straight, raise the appliance to the correct height by straightening at the knees.
- d) Rest the rear underside of the appliance on the cabinet floor while your hands support the front.
- e) The appliance can be pushed fully into the cabinet. Take care to avoid fouling the mains lead.
- f) Ensure the appliance is central and level.
- g) **Do not** remove spacers fitted behind fixing holes.
- h) When the appliance is fully housed screw the stability screws (supplied with the appliance) into the side of the cabinet taking care not to distort the side trims (See Fig 9). It is advisable to turn each screw alternatively to avoid damaging the trims.
- i) Switch on the appliance then refer to the operating instructions.

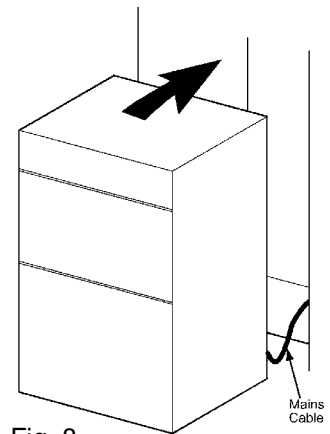

Fig. 8

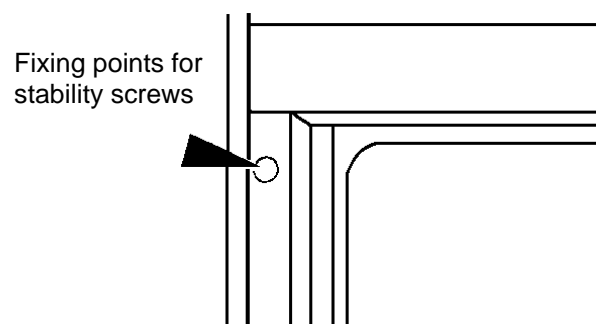

Fig. 9

## NOTES

## **IMPORTANT NOTICE**

In line with our continuing policy of research and development, we reserve the right to alter models and specifications without prior notice.

This instruction booklet is accurate at the date of printing, but will be superseded if specifications or appearance are changed.

To buy accessories, consumables and spare parts at our online shop please visit:  
<http://www.aeg-electrolux.co.uk>

**Part Number: 311807800**