

COMPETENCE 5210 BU

Build Under Double Oven

Operating And Installation
Instructions



IMPORTANT SAFETY INFORMATION

These warnings are provided in the interests of your safety. Ensure that you understand them all before installing or using the cooker. Your safety is of paramount importance. If you are unsure about any of the meanings of these warnings contact the Customer Care Department. The address is on the back page of this book.

INSTALLATION

- The cooker must be installed according to the instructions supplied. Any electrical installation work must be undertaken by a qualified electrician/competent person.
- This cooker is heavy and care must be taken when moving it. Do not try to move the cooker by pulling the door handles.
- All packaging, both inside and outside the cooker must be removed before the cooker is used.
- It is dangerous to alter the specifications or modify the cooker in any way. After installation please dispose of the packaging with due regard for safety and the environment.

CHILD SAFETY

- This cooker is designed to be operated by adults. Young children must not be allowed to tamper with the controls or play near or with the cooker.
- The cooker and accessible parts especially around the grill area become hot when the cooker is in use. Keep children away until it has cooled.

DURING USE

- Do not use this cooker if it is in contact with water. Never operate it with wet hands.
- Take great care when heating fats and oils as they will ignite if they become too hot.
- This cooker has been designed for cooking edible foodstuffs only, and must not be used for any other purposes.
- Never place plastic or any other material which may melt in or on the oven.
- Do not leave the grill pan handle in position when grilling and ensure oven gloves are used to remove and replace the handle, as it will become hot.
- Always use oven gloves to remove and place food in the oven.
- Ensure that all vents are left unobstructed to ensure ventilation of the oven cavity.
- Never line any part of the cooker with aluminium foil. Do not allow heatproof cooking material, e.g. roasting bags to come into contact with oven elements because they may catch fire.
- Always stand back from the cooker when opening the oven door to allow any build up of steam or heat to release.

- Stand clear when opening the drop down oven doors. Support the doors using the handles until fully open.
- Do not place sealed cans or aerosols inside the oven. They may explode if they are heated.
- Ensure that all control knobs are in the OFF position when not in use.
- Do not stand on the cooker or on the open oven doors.
- Do not hang towels, dishcloths or clothes from the cooker or its handles. They are a safety hazard.

CLEANING AND MAINTENANCE

- The cooker is heavy and care must be taken when moving it.
- This cooker should be kept clean at all times. A build-up of fats or other foodstuffs could result in a fire, especially in the grill pan.
- Do not leave cookware containing foodstuffs, e.g. fat or oil in the cooker in case it is inadvertently switched on.
- Always allow the cooling fan to cool the cooker down before switching off at the wall prior to carrying out any cleaning / maintenance work.
- Only clean this cooker in accordance with the instructions given in this book.

SERVICE

- Repairs should not be carried out by inexperienced persons as this may cause injury or serious malfunction. This cooker should be serviced by an authorised Service Engineer and only genuine approved spare parts should be used. Details of servicing and repair arrangements are supplied on page 52 of this book.

AT THE END OF THE COOKERS LIFE

- When the time comes to dispose of your cooker please contact your local Council Authority. They can arrange to dispose of the cooker in a safe and controlled manner. The number will be in the telephone book.



Please read this instruction book carefully before use and retain for future reference.

CONTENTS

FOR THE USER

Important Safety Information	2
Description of the Cooker	5
Getting to Know Your Oven	6
The Cooling Fan for the Controls	7
Fan Selector Indicator Neon	7
Pop In Pop Out Controls	7
Fan Selector Button	7
Before Using The Cooker	8
When First Switching On	8
Rating Plate	8
Condensation and Steam	8
Cookware	9
The Trivet	9
Grill and Oven Furniture	10
The Electronic Timer	11
The Dual Grill	15
Uses of the Grill	15
How To Use the Dual Grill	15
Things To Note	15
The Grill Pan and Handle	16
Hints and Tips	16
Grilling Chart	18
The Fan Assisted Top Oven	19
Uses of the Fan Assisted Oven	19
How To Use the Fan Assisted Oven	19
Things To Note	19
To Fit the Oven Shelves	19
Hints and Tips	20
The Conventional Top Oven	21
Uses of the Conventional Oven	21
How To Use the Conventional Oven	21
Things to Note	21
To Fit the Oven Shelf	21
Hints and Tips	22
Top Oven Cooking Chart	23
Thermal Grilling in the Top Oven	24
Uses of Thermal Grilling	24
How To Thermal Grill	24
Things to Note	25
Hints and Tips	25
Thermal Grilling Chart	26
To Defrost in the Top Oven	27
Uses of Defrost	27
How to Defrost	27
Things to Note	27
Hints and Tips	27
The Main Fan Oven	29
Uses of The Fan Oven	29
How To Use the Fan Oven	29
Things to Note	29
To Fit the Main Oven Shelves	30
Hints and Tips	30

The Conventional Oven	31
Uses of the Conventional Oven	31
How to Use the Conventional Oven	31
Things to Note	31
Hints and Tips	32
Main Oven Cooking Chart	33
Au Gratin Function	34
Uses of Au Gratin Setting	34
How to Use Au Gratin	34
Things To Note	34
Hints and Tips	34
Defrosting in the Main Oven	35
Uses of Defrost Feature	35
How to Defrost	35
Things to Note	35
Hints and Tips	35
Thermal Grilling in the Main Oven	37
Uses of Thermal Grilling	37
How to Thermal Grill	37
Things To Note	37
Hints and Tips	37
Thermal Grilling Chart	39
Care and Cleaning	40
Cleaning Materials	40
Cleaning the Outside of the Cooker	40
Cleaning the Outer and Inner Door	
Glass Panels	41
Cleaning the Main Oven	42
Cleaning the Grill / Top Oven Compartment	43
The Oven Cleaning Cycle - Top Oven	43
Things To Note	43
Hints and Tips	44
Cooking to Reduce Soilage	44
To Remove the Wirework Runners	45
Cleaning the Shelves, Wirework Runners and Oven Furniture	45
The Oven Clean Feature	46
Uses of Oven Clean	46
How to Use Oven Clean - Main Oven Only	46
Things to Note	46
Hints and Tips	47
Cooking to Reduce Soilage	47
The Oven Light	48
Replacing the Oven Light Bulb	48
If Something Doesn't Work	49
Guarantee Conditions	51
Service and Spare Parts	52
AEG Service Centres	53

FOR THE INSTALLER

Technical Details	47
Things You Need to Know	48
Warnings	48
Choice of Electrical Connection	48
Things to Note	49
Preparing Cabinet for Fitting Oven	50
How to Finish Unpacking	51
Making the Electrical Connections	52
To Remove Cover of Mains Terminal	52
Connecting to the Mains Terminal	53
Checking Electrical Connections	54
Connecting to a Hob or Cooker Point	54

Please read the whole instruction book before using the cooker. To help you the following symbols will be found in the text.

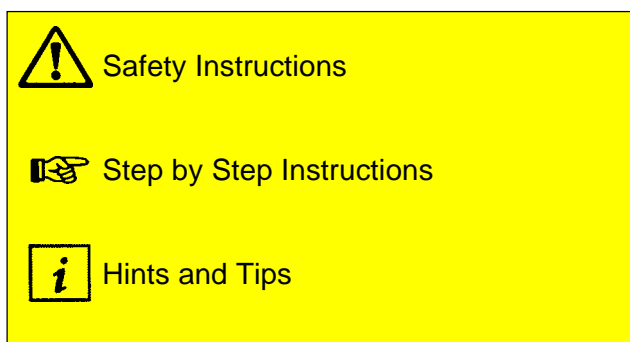

DESCRIPTION OF THE COOKER

Built in electric double oven



WARNING: THIS COOKER MUST BE EARTHED

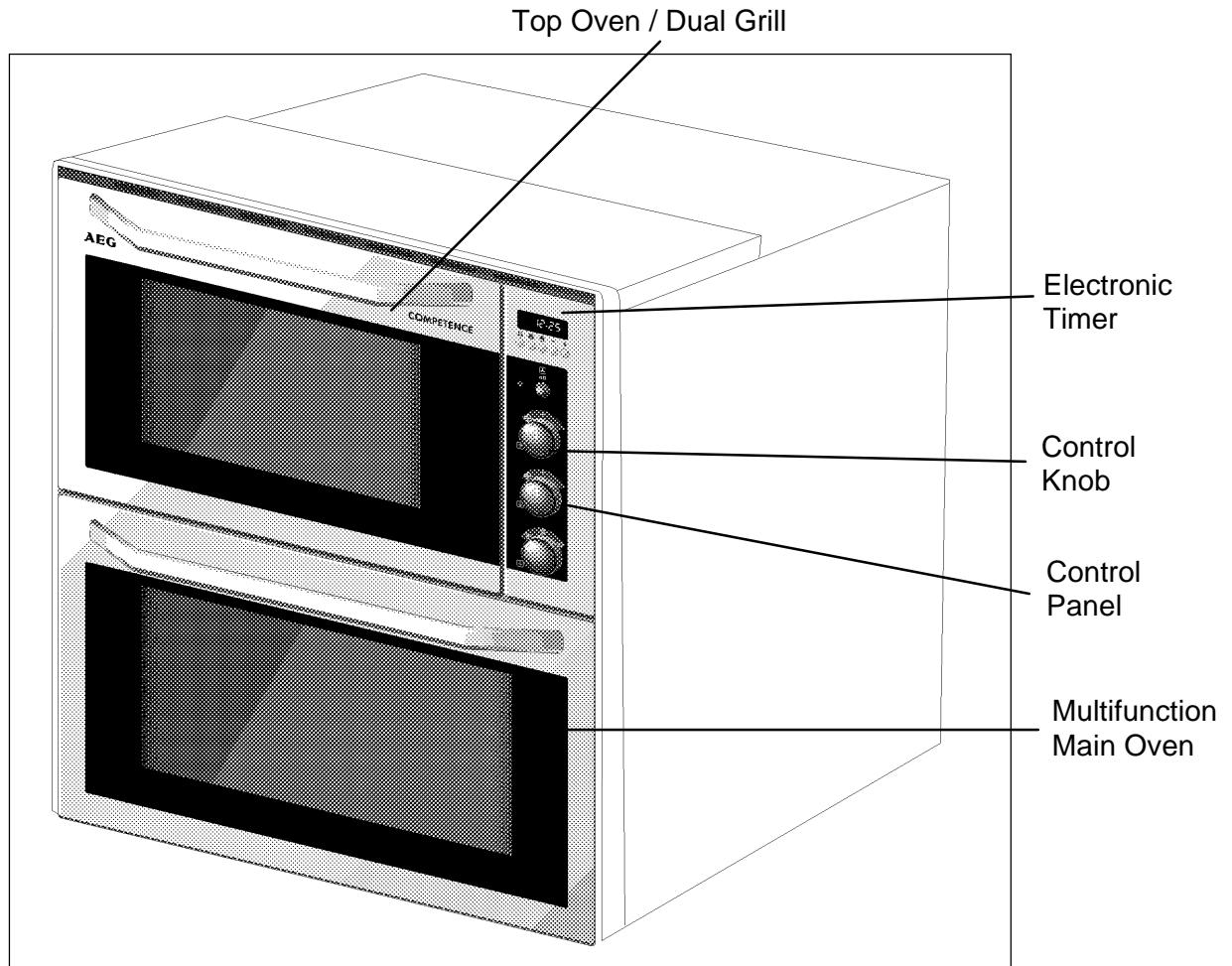

Your built in cooker comprises of an oven with conventional and fan assisted option and dual grill in the top compartment. The top oven is convenient and economical for mid-week use because of its size. The Multifunction main oven is the larger of the two ovens. It comprises of a number of different cooking functions and an oven clean feature.

The Multifunction oven can be automatically controlled by the electronic timer.

GETTING TO KNOW YOUR OVEN

The Control Panel

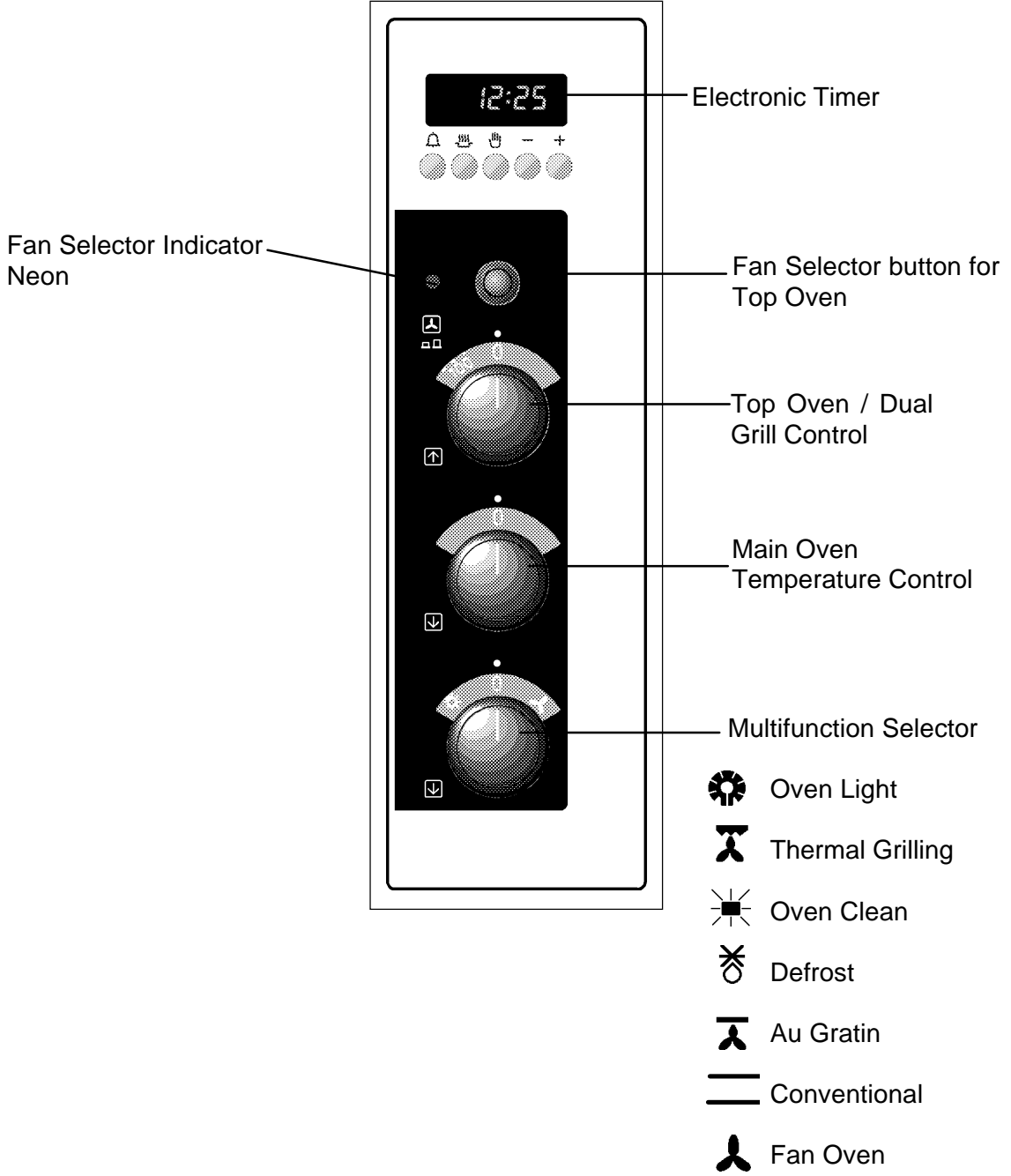

THE COOLING FAN FOR THE CONTROLS

Your cooker has a cooling fan fitted behind the controls to prevent them from overheating. The cooling fan will come on immediately when grilling or using thermal grill in the top compartment. The cooling fan may come on after a short time when the top or main oven are in use.

The cooling fan may cycle on and off when the cooker is in use. This is quite normal.

NOTE

The action of the cooling fan will depend on how long the ovens have been in use and what temperature. The cooling fan may not operate at low temperatures or where the oven(s) have been used for a short period of time.

The cooling fan may run on after the ovens or grill are switched off for a period of time to cool the cooker down. It may continue to switch on and off until the cooker is cool.

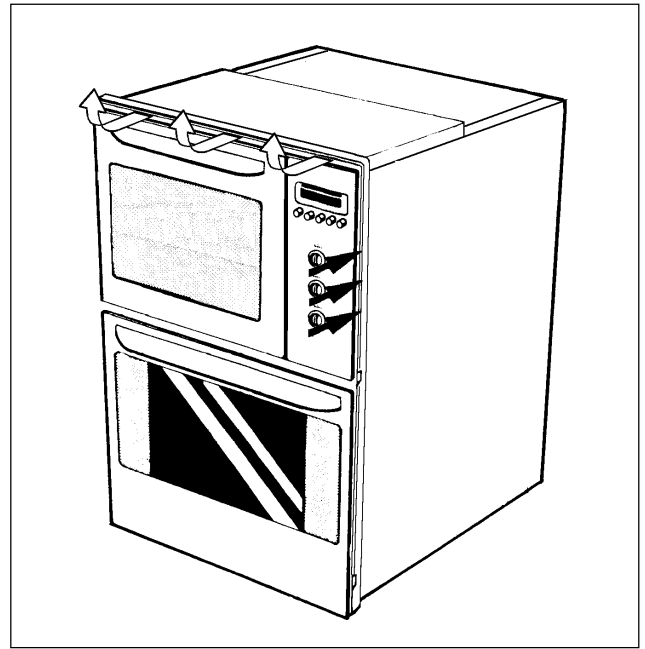

Always allow the cooling fan to cool the cooker down before switching off at the wall prior to carrying out any cleaning or maintenance work.

NOTE

The action of the cooling fan will depend on how long the ovens or grill have been used and at what temperature. It may not switch in at all at lower temperature settings nor run on where the grill or oven has only been used for a short time.

FAN SELECTOR INDICATOR NEON

The Fan Selector neon operates when the Fan Selector button is pushed out.

The Selector neon will illuminate with all Top oven functions, except the conventional oven.

The oven control surrounds will illuminate and cycle on and off during use to show that the temperature is being maintained.

POP IN POP OUT CONTROLS

These control knobs can remain flush with the control panel when not in use, or pushed and released to stand out from the panel for easy operation.

FAN SELECTOR BUTTON

The Top oven enables you to cook with the oven fan in operation or by conventional means. Push out the Fan Selector button for fan assisted cooking. Push the button in for conventional oven cooking. Refer to the appropriate oven section for full instructions.

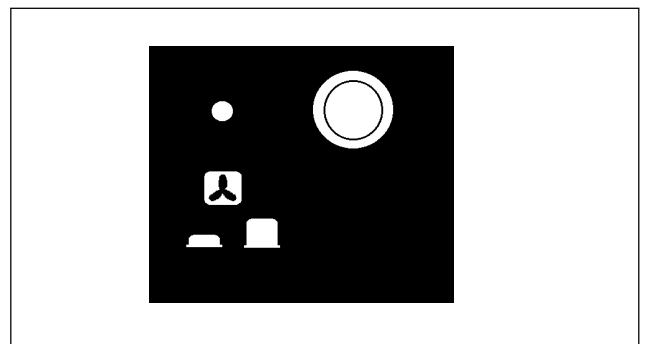

BEFORE USING THE COOKER

WHEN FIRST SWITCHING ON

The timer must be set to manual operation before the Main oven can be operated. This must be done whenever the cooker is switched off at the wall or when there has been a power failure. For instructions on how to set the timer see page 11.

If the control knob surround does not illuminate when the oven temperature control is turned, it is most likely that the timer is set for automatic cooking.

The Top Oven and the Dual Grill are not controlled by the electronic timer.

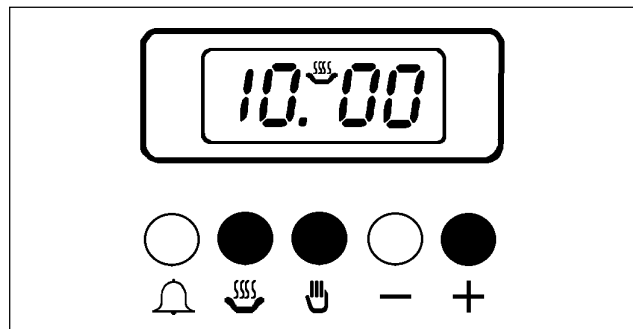

RATING PLATE

Record the model, product and serial numbers of your cooker on the back page of this instruction book for future reference. You can find these numbers on the rating plate on the front frame of the cooker upon opening the top oven door.

The cooker must be protected by a suitably rated fuse or circuit breaker. The rating of the cooker is given on the rating plate.

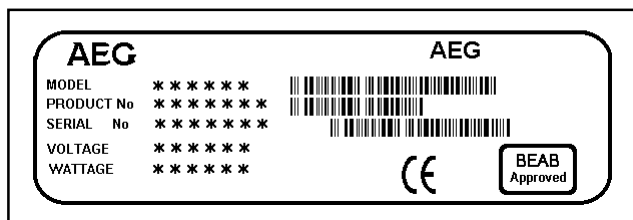

PREPARING TO USE YOUR COOKER

Wipe over the base of the ovens with a soft cloth and hot soapy water and wash the grill and oven furniture before use.

We suggest that you run the oven elements for 10 - 15 minutes at 220°C to burn off any residue from their surfaces.

The procedure should be repeated with the grill for approximately 5 - 10 minutes.

During this period an odour may be emitted, it is therefore advisable to open a window for ventilation.

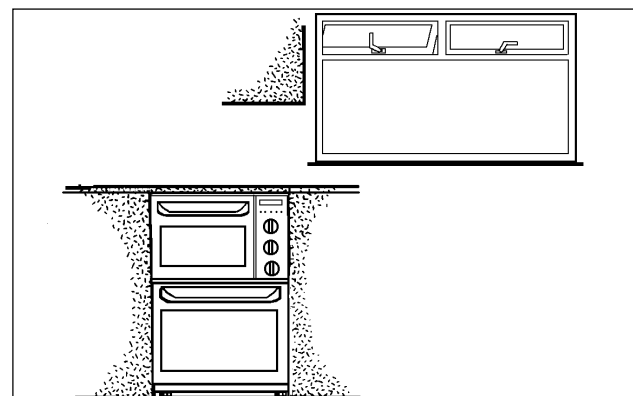

CONDENSATION AND STEAM

When food is heated it produces steam in the same way as a boiling kettle does. The ovens are vented to allow some of this steam to escape. However, always stand back from the cooker when opening the oven doors to allow any build up of steam or heat to release. If the steam comes into contact with a cool surface on the outside of the cooker, e.g. a trim, it will condense and produce water droplets. This is quite normal and is not caused by a fault on the cooker.

To prevent discolouration occurring, regularly wipe away condensation and any soilage from the cooker surfaces.

COOKWARE

Baking trays, dishes etc., should not be placed directly against the grid covering the fan at the back of the oven.

Do not use baking trays larger than 30cm x 35cm (12" x 14") as they will restrict the circulation of heat and may affect performance. Advice on the effect of different materials and finishes of bakeware is given in 'Hints and Tips' in the appropriate oven section.

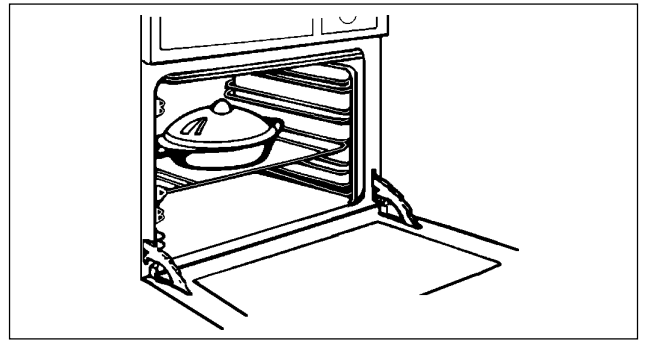

THE TRIVET

When roasting we recommend that you use the trivet in the meat tin. Fat and meat juices will drain into the meat tin below and can be used to make gravy. The trivet also prevents splashes of fat from soiling the oven interior.

Note. The meat tin should not be placed on a heated hotplate as this may cause the enamel to crack.

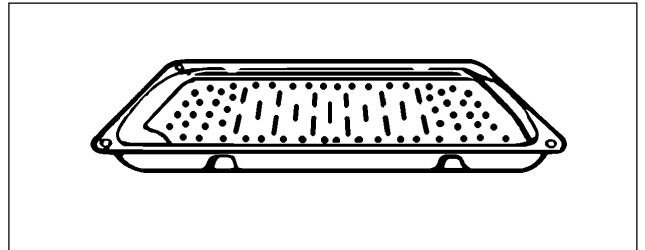

GRILL AND OVEN FURNITURE

The following items of oven furniture have been supplied with the cooker.

1 grill pan



1 grill pan handle

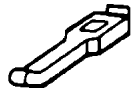

1 grill pan grid

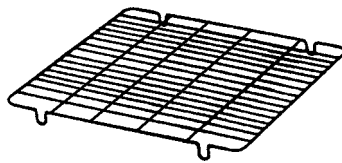

1 trivet

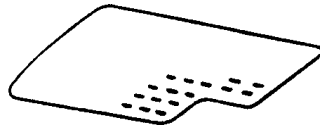

1 meat tin

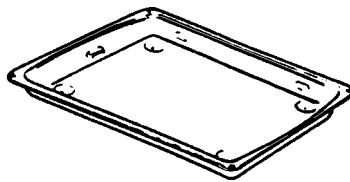

2 shelves for main oven cooking

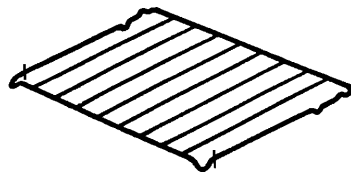

2 shelves for grilling and Top oven cooking

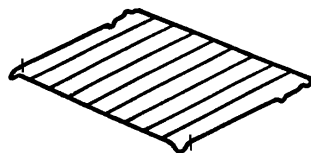



Scuffing of the Stayclean sides and back panel by the oven furniture pack may occur during transit.

These marks will disappear after the oven has been used for the first time.

THE ELECTRONIC TIMER



The electronic timer can indicate the time of day, operate as a minute minder and automatically time the Main oven.

- A Auto Symbol (automatic cooking)
-  Bell Symbol (minute minder)
-  Cookpot Symbol (manual cooking)

Please note that this is a 24 hour clock, for example 2pm is shown as 14.00.

If the oven is switched off at the wall or there is loss of power the clock will stop and you will not be able to use the cooker. When you first switch the electricity supply on, the timer display will flash.

TO SET THE TIME OF DAY

1. Press buttons  and  together.
Release the buttons.
2. Within 5 seconds press the + button until the time of day shows in the display.

The cookpot symbol () will be showing.

TO CHANGE THE TONE OF THE ALARM

The timer has three different tones to the alarm. You can change the sound of the alarm if you wish.

1. Ensure the clock shows the correct time of day.
2. Press the - button to change the sound of the alarm.

You will hear each of the three tones with each press of the button. Keep pressing the button until you hear the tone you prefer.

The next time the minute minder or timer is used the tone you selected will sound.

THE MINUTE MINDER

1. Press and release the  button.
2. Within 5 seconds press the + button until the display shows the time you want.

Our diagram shows the timer set to 5 minutes. After a few seconds the time of day will show in the display.

When you are using the minute minder you can check the number of minutes remaining by pressing the  button.

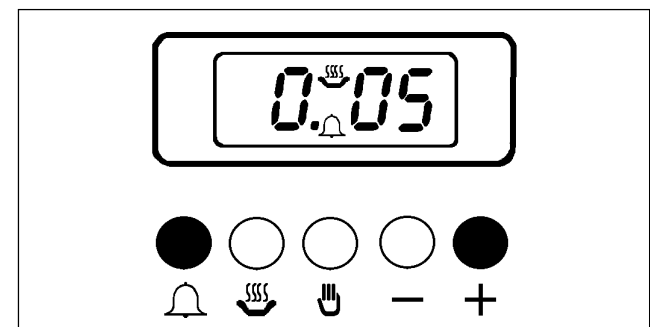
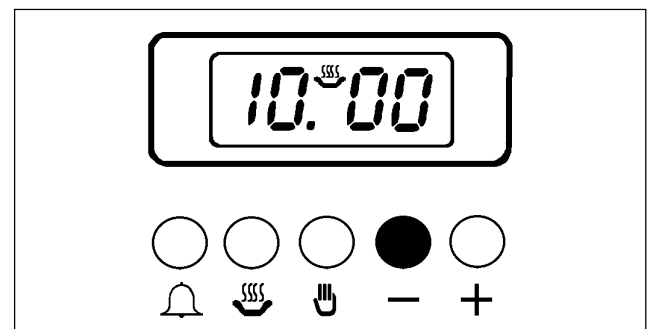
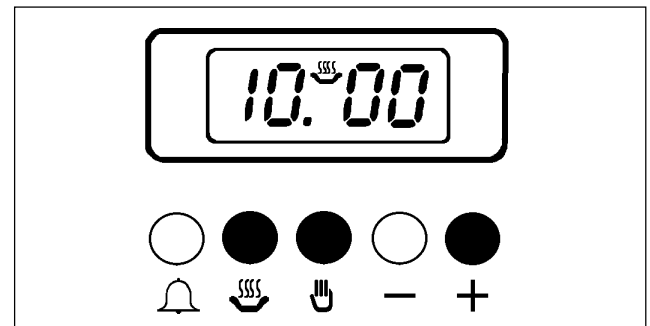
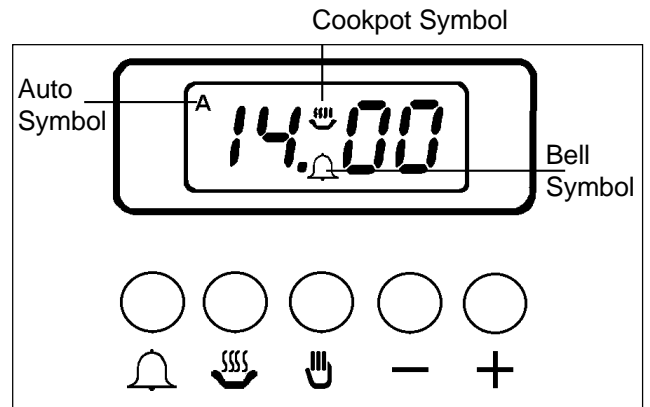

At the end of the timed period an alarm will sound. Switch off the alarm by pressing the  button.



AUTOMATIC TIMER CONTROL

The automatic timer can be used with the Multifunction oven only.

TO SWITCH THE MULTIFUNCTION OVEN ON AND OFF AUTOMATICALLY

1. Ensure the clock is showing the correct time of day.
2. Place food in the Multifunction oven.
3. Set the length of time you want the food to cook for by pressing and releasing the  button and then pressing the + button until the correct cooking time is displayed. This must be completed within 5 seconds of pressing the  button.

The maximum cooking time is 23 hours 59 minutes.

The Cookpot and Auto symbols will show in the display. Our diagram shows the cooking time set for 2 hours 30 minutes.

After a few seconds the time of day shows in the display.

4. To set the time you want the food to be cooked by, press and release the  button. This will show you the earliest possible stop time.

If this is different to the time you want the food to be cooked by, press the + button within 5 seconds until the correct stop time shows in the display. Our diagram shows the food is to be cooked by 18.00 hours (6pm). After a few seconds the time of day shows in the display and the Cookpot symbol goes out.

The 'Stop' time must not be more than 23 hours 59 minutes from the time of day. For example, if the time of day is 09.00 hours (9.00am) the latest 'Stop' time will be 08.59 (8.59am) the next day.

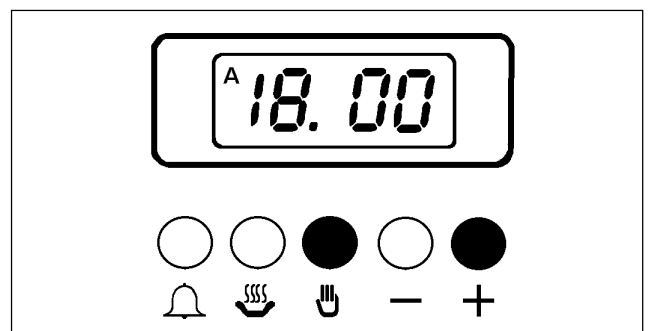
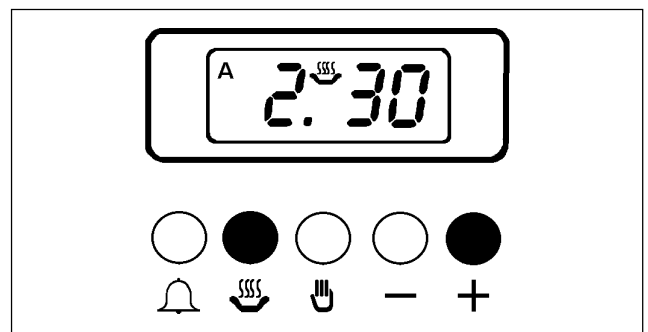



- Turn the oven control to the correct temperature and select the required function using the Multifunction Selector.

The clock will work out what time the oven will switch itself on and will switch the oven off at the end. An audible signal will sound when cooking is complete. To cancel the alarm, see below.

RETURNING THE COOKER TO MANUAL OR TO CANCEL AN AUTOMATIC PROGRAMME

Once automatic cooking is complete an alarm will sound and the Auto symbol will flash to remind you that the oven needs to be set for manual operation.

- To do this press buttons  and  together. After a few seconds the timer will show the time of day. The cookpot will show in the display and the oven will switch on again.
- Turn the oven control and Multifunction Selector off.

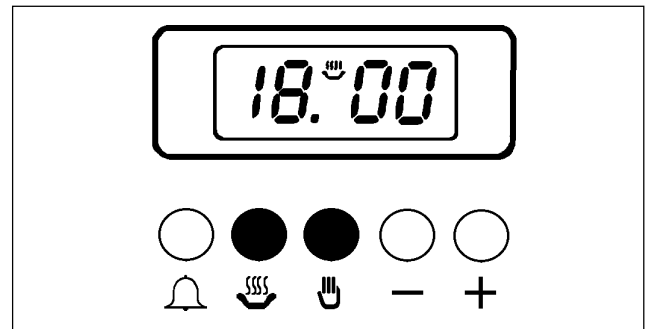

TO SET THE TIMER TO SWITCH OFF ONLY

This is useful if you want to begin cooking immediately but have the main oven switch off whilst you are out.

- Ensure the clock is showing the correct time of day.
- Place food in the oven.
- Set the length of time you want the food to cook for. Press and release the  button and then within 5 seconds press the + button until the correct cook time is showing.

Our diagram shows the timer set for 2 hours 30 minutes.



After a few seconds the time of day shows in the display.

- Turn the Multifunction Selector and oven temperature control to the required function and setting. The oven indicator neon will come on.

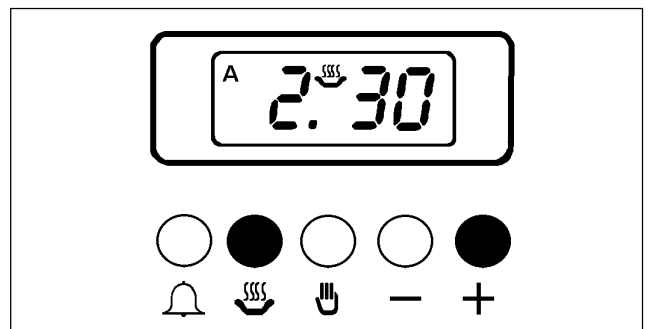
If you want to check the time the oven will switch off simply press the  button and the 'Stop' time will be displayed.



At the end of the cooktime the oven will switch off, the alarm will sound and the auto symbol will flash.

5. To cancel and return to manual operation press buttons  and  together.
6. Turn off the oven temperature control and Multifunction Selector.

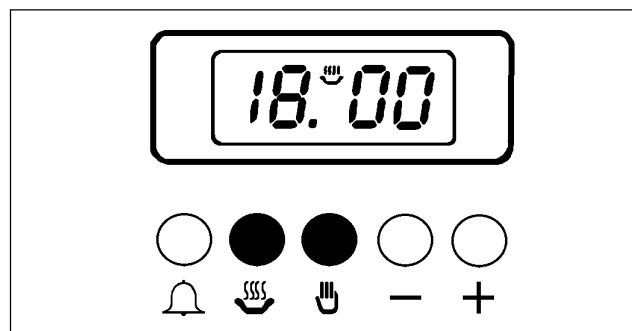

THE DUAL GRILL



WARNING - Accessible parts become hot when the grill is in use. Keep children away.

USES OF THE GRILL

The grill is situated in the Top oven compartment.

The grill is a dual circuit grill which means that the full area of the grill or the centre section only can be used. Use the full grill for cooking larger quantities of food. Use the centre section for economy purposes when cooking smaller quantities.

HOW TO USE THE DUAL GRILL

1. Open the Grill / Top Oven door.
2. Push out and turn the grill / top oven control clockwise past the maximum oven temperature to the settings that control the grill.
3. The first three settings control the full area at $\frac{1}{4}$, $\frac{1}{2}$ and full power. Set to full power at first then turn down as necessary. The fourth setting is for the centre section of the grill only. This section operates at full power.



The grill door must be left open when grilling.

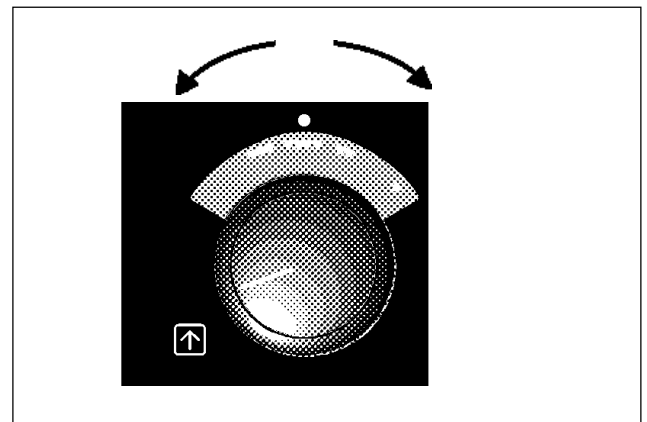

THINGS TO NOTE

- The cooling fan for the controls will operate as soon as the grill control is turned. For more information on the operation of the cooling fan turn to page 7.
- The outer section of the grill element may appear to glow brighter than the inner section. This is quite normal.
- The control knob surround will illuminate.
- You can use the grill pan on the shelf in positions 3 and 5 only.
- If you use the grill pan in position 3 the shelf must be withdrawn before the pan can be located or removed.

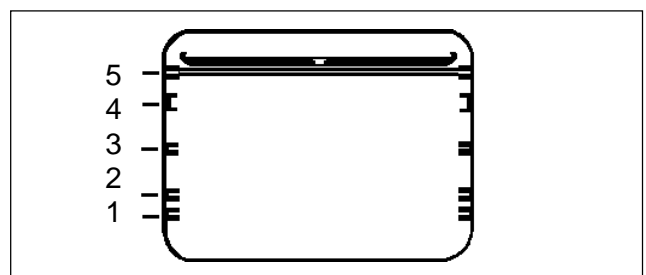

Ensure the grill pan is properly located.

THE GRILL PAN AND HANDLE

The grill pan has a removable handle.

To insert the handle, press the button on the handle with the thumb and pivot the handle slightly upwards inserting the lip into widest part of the bracket. Move the handle towards the left, lower into position and release the button.



Ensure the handle is positively located.

To remove the handle, press the button on the handle with the thumb and pivot the handle slightly upwards and towards the right to remove from the bracket.



Protect your hands when removing the grill pan handle.

Always remove the grill pan handle during grilling.

To correctly locate the grill pan on the shelf, ensure that the cut out on the underside of the handle bracket locates over the front bar of the shelf.

To check the progress of the food being grilled, the grill pan should be withdrawn on the shelf to attend to food during cooking.



Ensure that you support the grill pan when it is withdrawn.



HINTS AND TIPS

- Most foods should be placed on the grilling grid in the grill pan. This allows maximum circulation of air by raising the food out of fats and juices. Foods such as fish, liver and kidneys may be placed directly on the trivet in the grill pan if preferred.
- Adjust the grid and grill pan runner position to allow for different thicknesses of food. Position the food close to the element for faster cooking and further away for more gentle cooking.

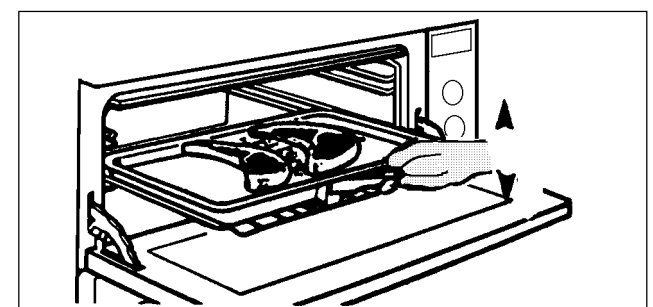
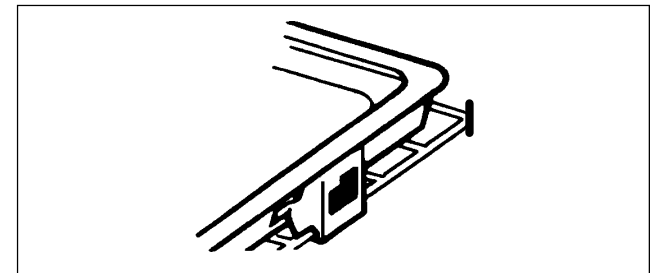
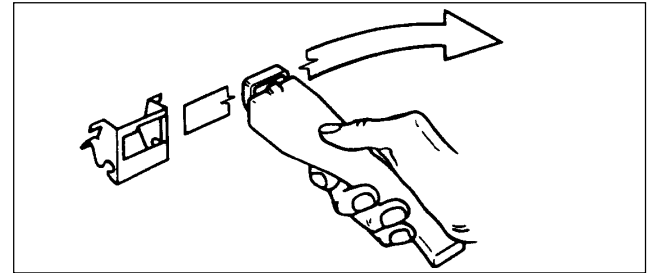
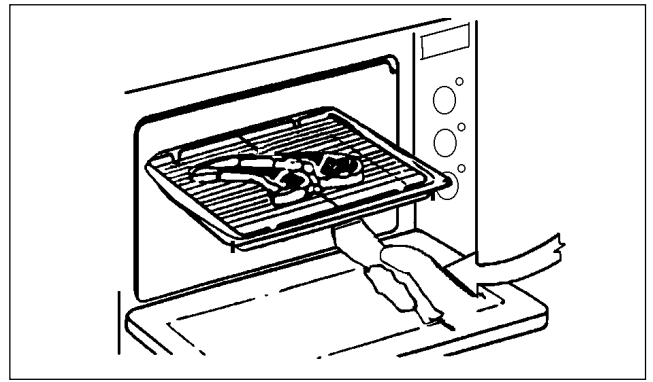

- The grill pan grid is reversible. This is useful if you want to cook foods of varying thickness. As a general rule, bread for toasting should be placed on the grid in the ' high ' position in the grill pan. Foods such as chicken pieces or chops may be grilled using the grilling grid in the low position.

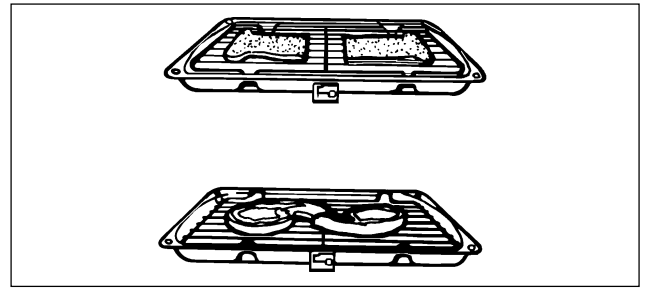

- Food should be thoroughly dried before grilling to minimise splashing. Brush lean meats and fish lightly with a little oil or melted butter to keep them moist during cooking.

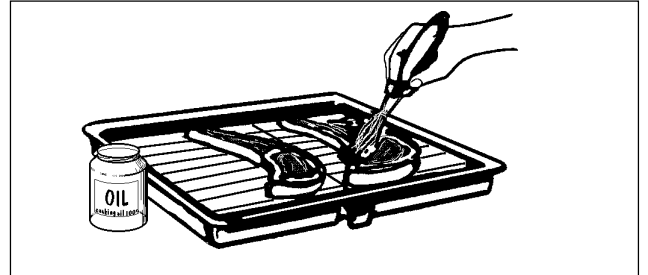

- Accompaniments such as tomatoes and mushrooms may be placed underneath the grid when grilling meats.

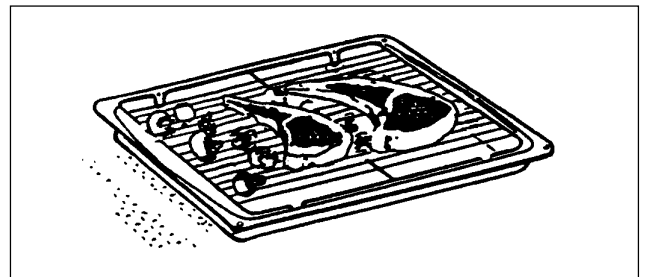

- The food should be turned over during cooking as required.

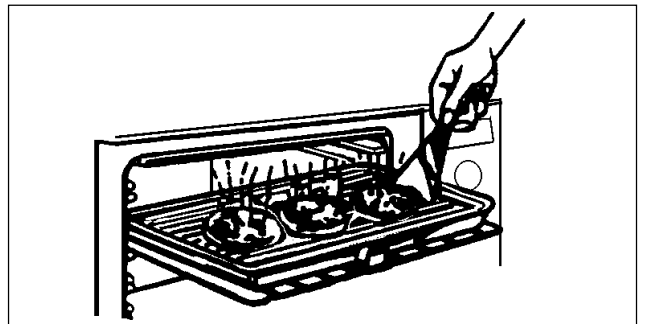

- The grill door must be left open when grilling. For convenience the grill door can be left ajar.

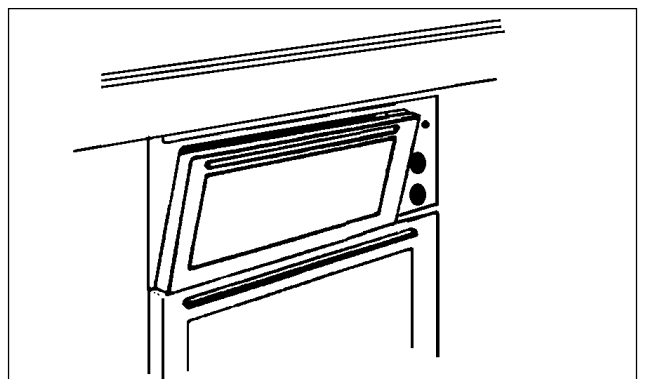

- Preheat the grill on full setting for a few minutes before searing steaks or toasting. Adjust the heat setting and the shelf position as necessary during cooking.

GRILLING CHART

The chart below gives recommended cooking times and shelf positions. Remember that these are a guide and should be adjusted to suit personal taste.

Note

Shelf positions are counted from the bottom upwards.

Food	Grill Time (Min)	Shelf	Grid position
Bacon Rashers	3 - 5 each side	5	High
Beefburgers	6 - 10 each side	5	Low
Chicken Joints	15 - 20 each side	3	High
Chops - Lamb	7 - 10 each side	5	Low
- Pork	10 - 15 each side	5	Low
Fish - Whole Trout / Herring	8 - 12 each side	5	Low
Filletts - Plaice / Cod	4 - 6 each side	5	Low
Kebabs	10 - 15 each side	5	Low
Kidneys - Lamb	4 - 6 each side	5	Low
Pig	8 - 10 each side	5	Low
Liver - Lamb / Pig	5 - 10 each side	5	Low
Sausages	10 - 15 turn as required	5	Low
Steaks - Rare	3 - 6 each side	5	Low
Medium	6 - 8 each side	5	Low
Well Done	7 - 10 each side	5	Low
Browning e.g. au gratin, lasagne, shepherd's pie	3 - 5 mins	3	-

THE FAN ASSISTED TOP OVEN

USES OF THE FAN ASSISTED OVEN

The Top oven is the smaller of the two ovens. It is convenient for mid-week meals where smaller quantities or convenience foods are being cooked. It is important to refer to the Top oven cooking chart as a guide to shelf positions and temperatures as these may differ from previous cookers you may have used.

HOW TO USE THE FAN ASSISTED OVEN

1. Push out and turn the Grill / Top oven temperature control clockwise to the required setting.
2. Push out the Fan Selector button.

THINGS TO NOTE

- The Fan Selector neon will glow throughout cooking.
- The control knob surround will illuminate and cycles on and off during use.
- The cooling fan for the controls will operate after a time. See page 7 for more information on the operation of the cooling fan.



Do not place dishes, tins and trays directly on the oven base as it becomes very hot and damage will occur.

TO FIT THE OVEN SHELVES

There are 5 shelf positions in the Top oven. Shelf positions are counted from the bottom upwards.

The shelves should be fitted with the straight rods uppermost on the frame and the forms towards the back of the oven.

If not fitted correctly the anti-tilt and safety stop mechanism will be affected.

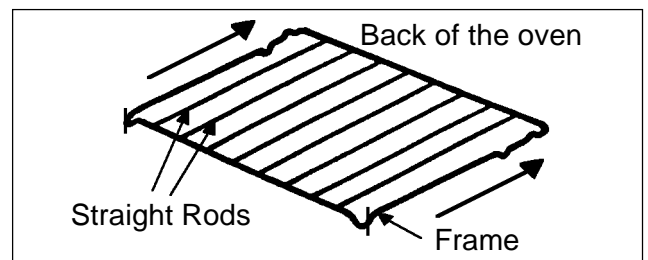
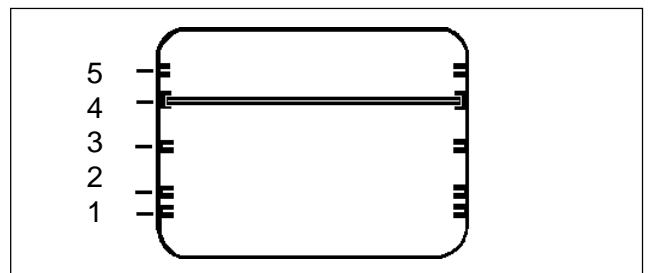
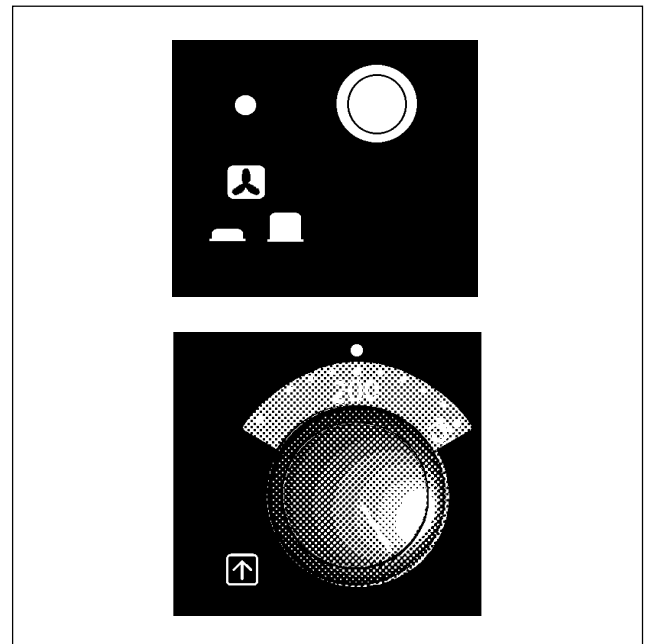

i HINTS AND TIPS

- Use the Top oven when you want to warm plates. Use a setting of 80°C - 100°C on the oven temperature control.
- You can use both shelves when using the fan assisted oven.
- There should always be at least 2.5cm (1") between the top of the food and the grill element. This gives best cooking results and allows room for rise in yeast mixtures, Yorkshire puddings etc. When cooking cakes, pastry, scones bread etc., place the tins or baking trays centrally on the shelf.
- Ensure that food is placed centrally on the shelf and there is sufficient room around the baking tray or dish to allow for maximum circulation.
- Where a degree of evenness in baking is required, it may be necessary to interchange food during cooking.
- Where a larger quantity of food is to be cooked we recommend you use the main oven.
- Place dishes on a suitably sized baking tray on the shelf to prevent spillage onto the oven base and to help reduce cleaning.
- The material and finish of the baking tray and dishes will affect the degree of base browning of the food. Enamelware, dark, heavy or non-stick utensils increase base browning. Shiny aluminium or polished steel trays reflect the heat away and give less base browning.
- For economy leave the door open for the shortest possible time, particularly when placing food into a pre-heated oven.
- Do not use the grill pan or meat tin as a baking tray as this will increase base browning of the food.
- Because of the smaller cooking space and lower temperatures, shorter cooking times are sometimes required. Be guided by the recommendations in the cooking chart.
- When roasting we recommend that you use the trivet in the meat tin. Fat and meat juices will drain into the meat tin below and can be used to make gravy. The trivet also prevents splashes of fat from soiling the oven interior.

Note. The meat tin should not be placed on a heated hotplate as this may cause the enamel to crack.

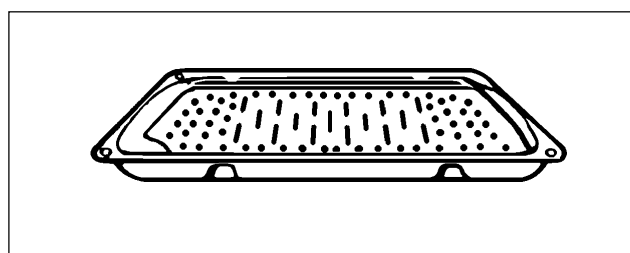
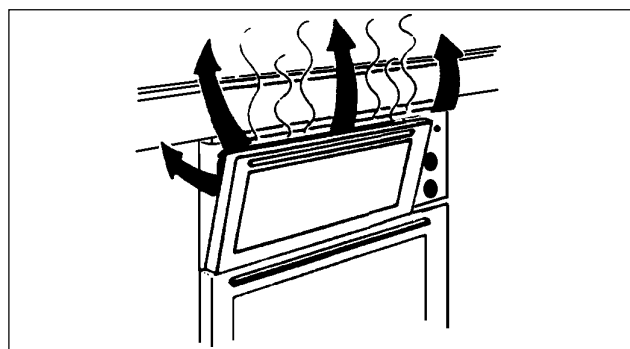
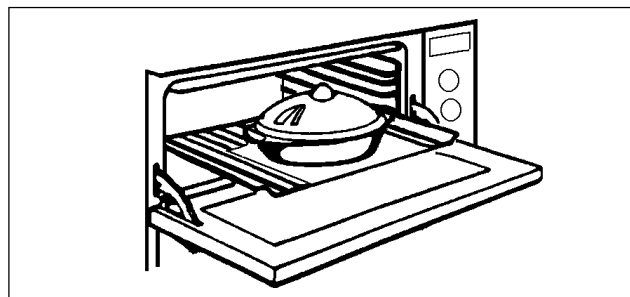
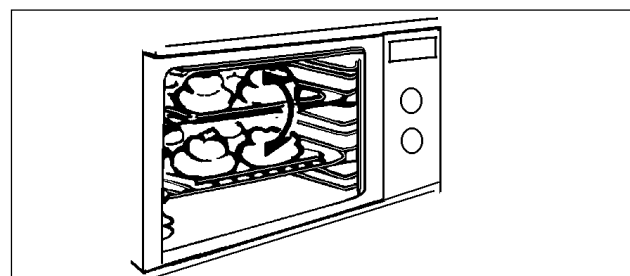
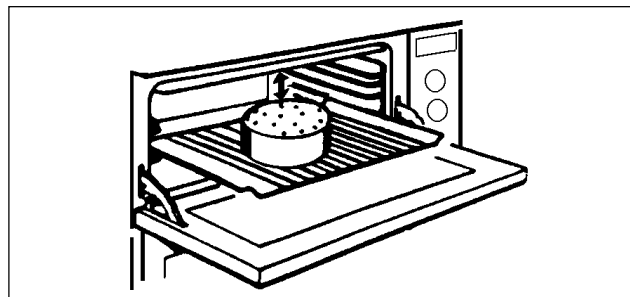

THE CONVENTIONAL TOP OVEN

USES OF THE CONVENTIONAL OVEN

This form of cooking gives you the opportunity to cook without the fan in operation. It is particularly suitable for some cook chilled convenience foods and dishes which require extra base browning such as pizzas, quiches and flans. Gratin's, lasagne and hotpots which require extra top browning also cook well in the conventional oven. For best results cook on one level.

HOW TO USE THE CONVENTIONAL OVEN

1. Push in the Fan Selector button.
2. Push out and turn the Grill / Top oven temperature control clockwise to the required setting.

THINGS TO NOTE

- The control knob surround will illuminate and cycle on and off during use.
- The cooling fan for the controls will operate after a short time. It may run on after the controls are switched off until the cooker has cooled. See page 7 for more details on the operation of the cooling fan.



Do not place dishes, tins or baking trays directly on the oven base as it becomes very hot and damage will occur.

TO FIT THE OVEN SHELF

There are 5 shelf positions in the Top oven. Shelf positions are counted from the bottom upwards.

The shelf should be fitted with the straight rods uppermost on the frame and the forms towards the back of the oven.

If not fitted correctly the anti-tilt and safety stop mechanism will be affected.

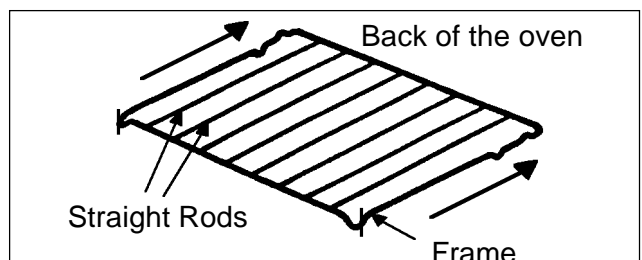
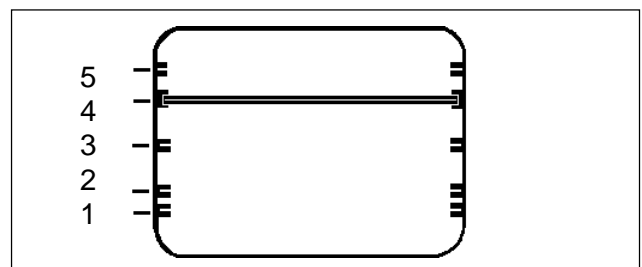
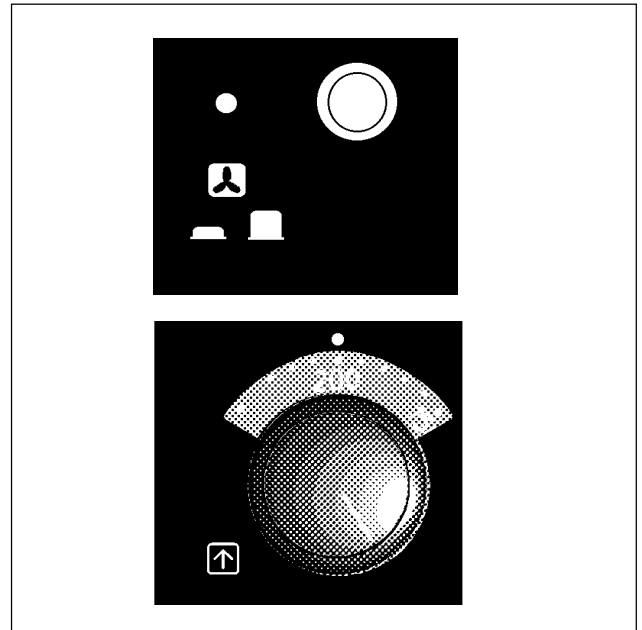

i HINTS AND TIPS

- The middle shelf allows for the best heat distribution. To increase base browning simply lower the shelf position. To increase top browning, raise the shelf position.
- The material and finish of the baking trays and dishes used will affect base browning. Enamelware, dark heavy or non-stick utensils increase base browning, while oven glassware, shiny aluminium or polished steel trays reflect the heat away and give less base browning.
- Always place dishes centrally on the shelf to ensure even browning.
- Stand dishes on suitably sized baking trays to prevent spillage onto the base of the oven and make cleaning easier.
- Single level cooking gives best results. If you require more than one level of cooking use the fan assisted function or main fan oven.
- Because of the smaller cooking space and lower temperature, shorter cooking times are sometimes required. Be guided by the recommendations in the cooking chart.
- For economy leave the oven door open for the shortest possible time particularly when placing food in a preheated oven.
- Where a larger quantity of food is to be cooked we recommend you use the fan assisted or main fan oven.

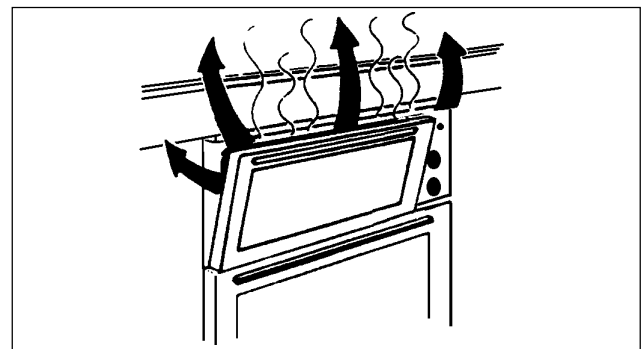
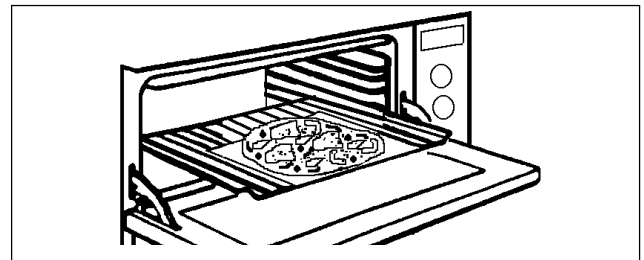
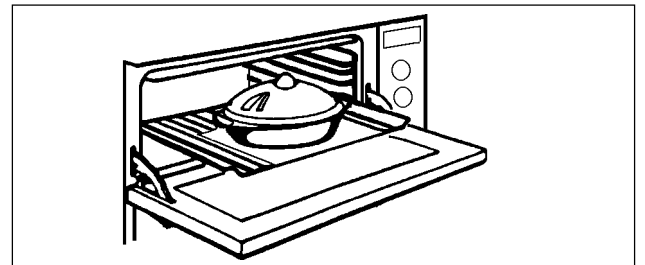
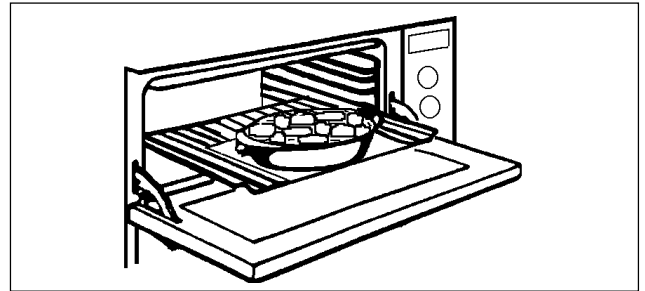
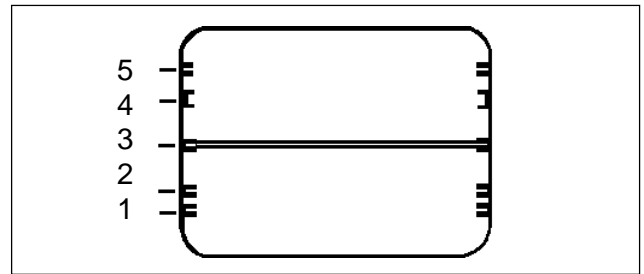

TOP OVEN COOKING CHART

The oven temperatures are intended as a guide only. It may be necessary to increase or decrease the temperatures by a further 10°C to suit individual preferences and requirements.

Note: Shelf positions are counted from the bottom of the oven.

FOOD	CONVENTIONAL OVEN		FAN ASSISTED OVEN	
	SHELF POSITION	TEMP (°C)	SHELF POSITION	TEMP (°C)
Biscuits	3	170 -190	2 & 4	160 - 170
Bread	3	210 - 220	2	200 - 210
Bread Rolls / Buns	3	210 -220	2 & 4	160 - 170
Cakes:				
Small & Queen	3	180 - 190	2 & 5	160 - 170
Sponges	2	180 - 190	2 & 5	160 - 170
Victoria Sandwich	2	180 - 190	2 & 4	160 - 170
Madeira	3	160 - 170	2	140 - 150
Rich Fruit	3	140 - 150	2	130 - 140
Gingerbread	3	150 - 160	2 & 4	140 -150
Meringues	2	80 - 100	2 & 4	90 - 100
Flapjack	3	180 - 190	3	170 - 180
Shortbread	3	140 - 150	3	130 - 140
Baked Custard	3	160 - 170	3	150 - 160
Casseroles :				
Beef / Lamb	2	150 - 160	4	140 - 150
Chicken	2	140 - 160	4	140 -160
Convenience Foods	3	Refer to Packaging	2 & 4	Refer to Packaging
Fish	3	170 - 190	3	150 - 170
Fish Pie - potato topped	3	200 - 210	7	180 -190
Fruit Pies, Crumbles	3	190 - 200	3	190 - 200
Milk Puddings	3	140 - 150	3	130 - 140
Pasta / Lasagne etc.	3	190 - 200	3	170 - 180
Pastry : Choux -	3	190 - 200	3	190 - 200
Eclairs/profiteroles	3	190 - 200	3	190 - 200
Flaky / Puff pies	3	200 - 210	3	190 - 200
Shortcrust -	3	190 - 200	2 & 4	170 - 180
Mince pies	3	190 - 200	2 & 4	170 - 180
Meat pies	3	210 - 220	2 & 4	170 - 180
Quiche, Tarts, Flans	3	180 - 190	3	180 - 190
Roast Meat / Poultry	1	160 - 180	2	160 - 180
Scones	3	220 -230	2 & 4	210 - 220
Shepherds Pie	3	200 - 210	3	200 - 210
Soufflés	3	190 - 200	3	160 - 170
Vegetables : Baked Jacket Potatoes	3	190 - 200	3	200 - 210
Roast Potatoes	3	200 - 210	4	170 - 180
Yorkshire Puddings - large	3	210 - 220	4	210 - 220
- individual	3	210 - 220	4	210 - 220

THERMAL GRILLING IN THE TOP OVEN

USES OF THERMAL GRILLING

Thermal grilling in the Top oven offers an alternative method of cooking food items normally associated with conventional grilling.

The grill element and the oven fan operate together, circulating hot air around the food. The need to check and turn food is reduced. Thermal grilling helps to minimise cooking smells in the kitchen and allows you to grill with the oven door closed. With the exception of toast and rare steaks you can thermal grill all the foods you would normally cook under a conventional grill.

Dishes prepared in advance such as shepherd's pie, lasagne and au gratin's can be heated through and browned on the top using the thermal grilling function.

COOKING TIMES

Cooking is more gentle, therefore food generally takes a little longer to cook when thermal grilling compared with conventional grilling. One of the advantages is that larger quantities can be cooked at the same time.

A general guide to cooking times is given on page 26 but these times may vary slightly depending on the thickness and quantity of food being cooked.

HOW TO THERMAL GRILL



Always thermal grill with the oven door closed and with the grill pan handle removed.

1. Press out the Fan Selector button.
2. Push out and turn the Top oven / Dual Grill control past the maximum oven setting to the required grill setting.
3. Locate the grill pan on shelf 3 or 5.
4. Remove the handle from the grill pan and close the oven door.



If you use the grill pan in position 3, the shelf must be withdrawn before the pan can be located or removed. Ensure the grill pan is properly located.

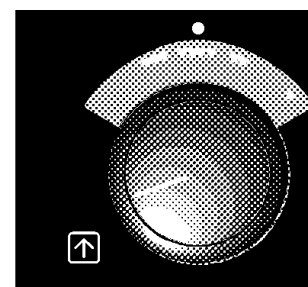
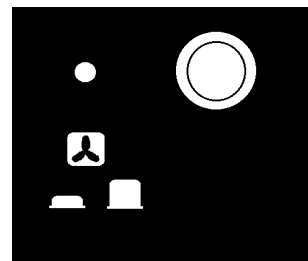
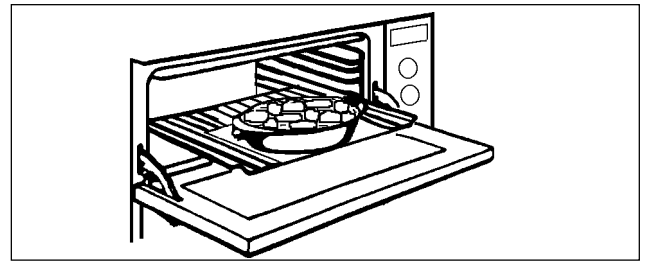
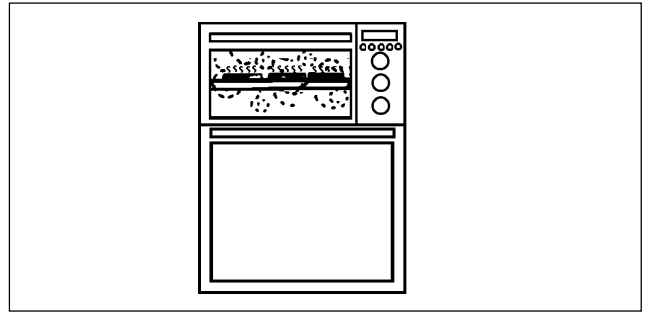

THINGS TO NOTE

- Shelf position 3 is suitable for most foods.
- Setting ▼▼ is suitable for most thicker foods such as chicken quarters and pork chops.
Setting ▼▼▼▼ is suitable for foods such as bacon.
- The control knob surround will illuminate.
- The Selector indicator neon will glow throughout cooking.
- The oven fan will operate continually during thermal grilling.
- The cooling fan for the controls will come on when the grill control is turned. It may run on after the controls are switched off until the cooker has cooled. See page 7 for more details on the operation of the cooling fan.



HINTS AND TIPS

- Prepare foods in the same way as for conventional grilling. Brush lean meats and fish lightly with a little oil or butter to keep them moist during cooking.
- Most food should be placed on the grill pan grid in the 'high' position in the grill pan to allow maximum circulation of air around the food. Foods such as fish, liver and kidneys may be placed directly onto the trivet in the grill pan if preferred.
- The use of the trivet beneath the grid when grilling fatty foods will help minimise fat splashing.
- Accompaniments such as tomatoes and mushrooms may be placed below the grid when grilling meats, or in a separate dish on a lower shelf.

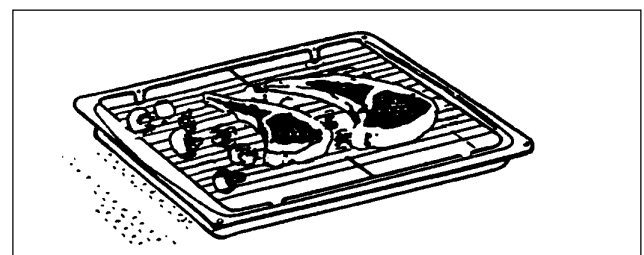
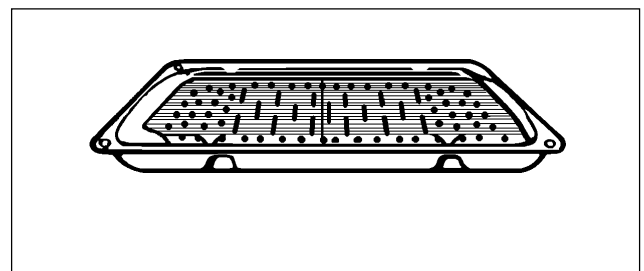
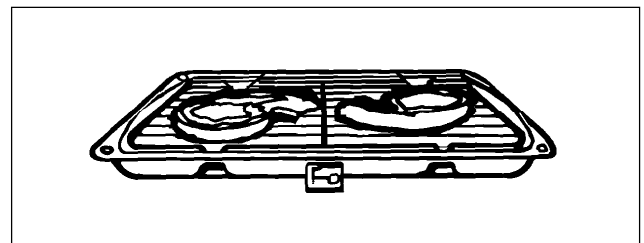
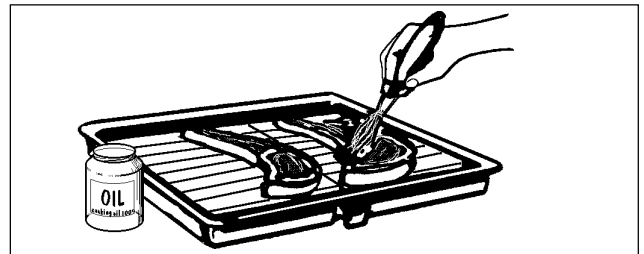

- Turn food over during cooking as necessary.

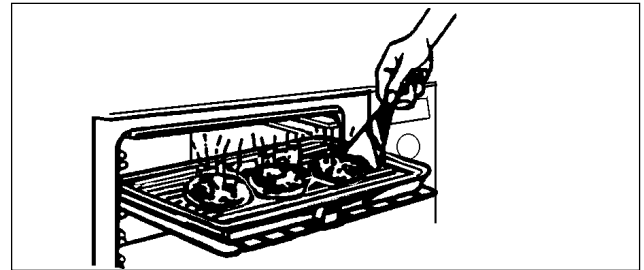

- Ensure that ready prepared or cooked chilled dishes e.g. shepherds pie, moussaka, lasagne, etc., are piping hot throughout before serving.

- Be prepared to make suitable adjustments to the grill setting during cooking to suit individual requirements. It may be necessary to turn down as required. If thermal grilling on more than one level, it may be necessary to interchange the food on the shelves during cooking.

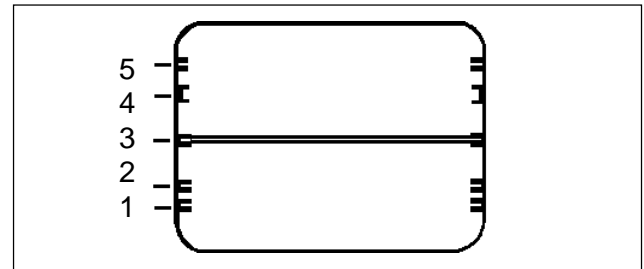

- With the exception of toast and rare steak you can thermal grill all foods normally grilled by conventional methods.

THERMAL GRILLING CHART

FOOD	SHELF	GRILL SETTING	TIME (mins in total)
Bacon Rashers	5	▼▼▼▼	8 - 12
Beefburgers	3	▼▼▼▼	10 - 15
Chicken Joints	3	▼▼	30 - 40
Chops - Lamb	3	▼▼	20 - 25
- Pork	3	▼▼	20 - 25
Fish - Whole Trout / Mackerel	3	▼▼	10 - 20
Fillets - Plaice / Cod	3	▼▼	10 - 15
Kebabs	3	▼▼	20 - 30
Kidneys - Lamb / Pig	3	▼▼	10 - 15
Liver - Lamb / Pig	3	▼▼	20 - 30
Sausages	3	▼▼	10 - 20
Steaks - Medium	3	▼▼	15 - 20
- Well Done	3	▼▼	20 - 30
Heating through and browning eg. au gratin, lasagne, Shepherds pie	3	▼▼	depends on dish

TO DEFROST IN THE TOP OVEN

USES OF DEFROST

This function enables you to defrost most foods without heat faster than some conventional methods as the oven fan circulates air around the food. It is particularly suitable for defrosting delicate frozen foods which are to be served cold e.g. cream filled gateaux, cakes covered with icings or frostings, cheesecakes, biscuits, scones etc.

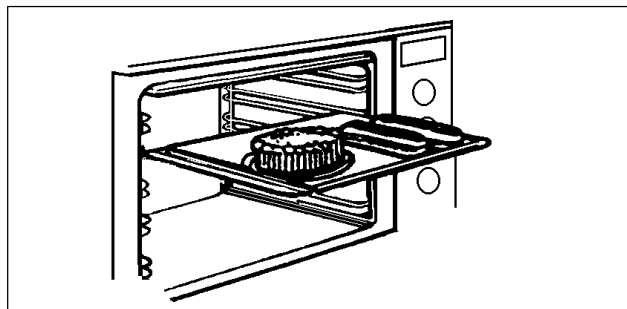

HOW TO DEFROST

1. Press out the Fan Selector button.
2. The Dual grill / Top oven control should be in the Off '0' position.

THINGS TO NOTE

- The oven fan will operate.
- The fan selector indicator neon will illuminate.

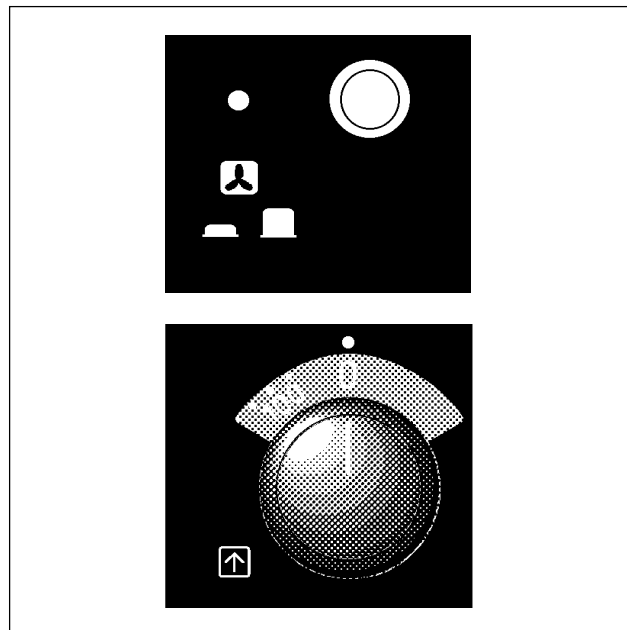

HINTS AND TIPS

- Place the frozen food in a single layer where possible and turn it over half way through the defrosting process.
- The actual speed of defrosting is influenced by room temperature. On warm days defrosting will be faster than on cooler days.
- It is preferable to thaw fish, meat and poultry slowly in the fridge. However, this process can be accelerated by using the defrost function. Small or thin fish fillets, frozen peeled prawns, cubed or minced meat, liver, thin chops, steaks etc., can be thawed in 1 - 2 hours.
- A 1kg/2¼lb oven ready chicken will be thawed in approximately 5 hours. Remove the giblets as soon as possible during the thawing process.

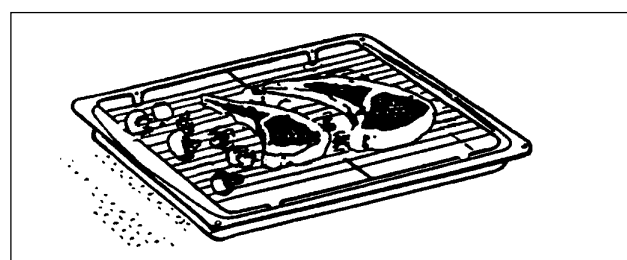
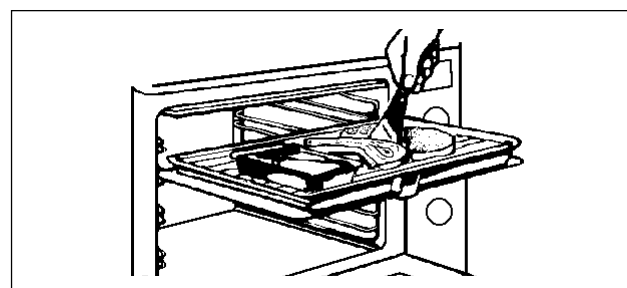

- Joints of meat up to 2kg/4½lb in weight can be thawed using the defrost function.
- All joints of meat and poultry must be thawed thoroughly before cooking.
- DO NOT leave food at room temperature once it is defrosted. Cook raw food immediately or store cooked food in the fridge.
- Care must always be taken when handling foods in the home. Always follow the basic rules of food hygiene to prevent bacterial growth and cross contamination when defrosting, preparing, cooking cooling and freezing foods. This is particularly important if the main oven is in use or is warm, as the temperature in the Top oven will be higher than room temperature.

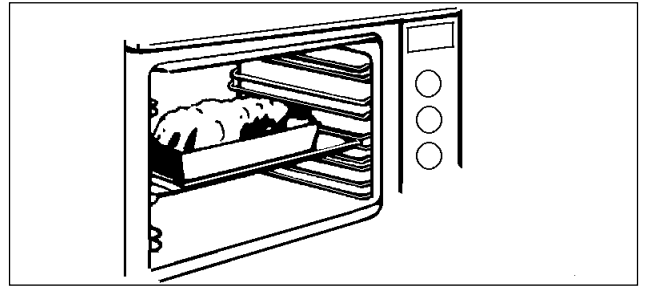

THE MAIN FAN OVEN

USES OF THE FAN OVEN

The fan oven is particularly suitable for cooking larger quantities of food.

The advantages of fan oven cooking are:

PREHEATING

The fan oven quickly reaches its temperature so it not usually necessary to preheat the oven. Without preheating however you may need to add an extra 5 - 10 minutes on the recommended cooking times. For recipes needing high temperatures e.g. bread, pastries, scones, soufflés etc., best results are achieved if the oven is preheated first.

COOKING TEMPERATURES

Fan oven cooking generally requires lower temperatures than conventional cooking. Follow the temperatures recommended in the chart on page 33 until you are familiar with the lower temperatures associated with Fan oven cooking. As a guide reduce temperatures by 20°C - 25°C for your own recipes.

BATCH BAKING

The fan oven cooks evenly on all shelf levels, especially useful when batch baking.

HOW TO USE THE FAN OVEN

1. Push out and turn the Selector to Fan oven. 
2. Push out and turn the main oven temperature control to the required setting.

THINGS TO NOTE

- The oven light will come on when the Selector is set.
- The oven fan will operate continually during cooking.
- The cooling fan for the controls may operate after a time. See page 7 for further details on the operation of the cooling fan.
- The control surrounds will illuminate. The oven control surround will cycle on and off during use.
- If an automatic programme has been set, the oven fan and oven light do not come on until the cook time begins.

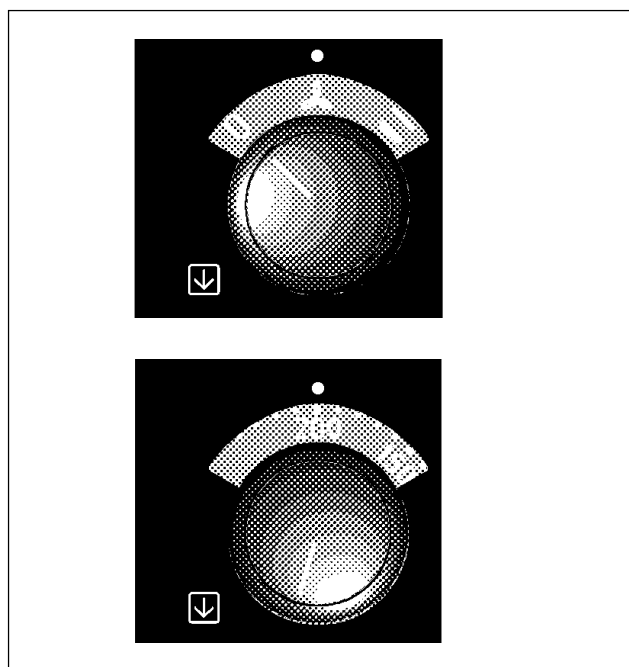
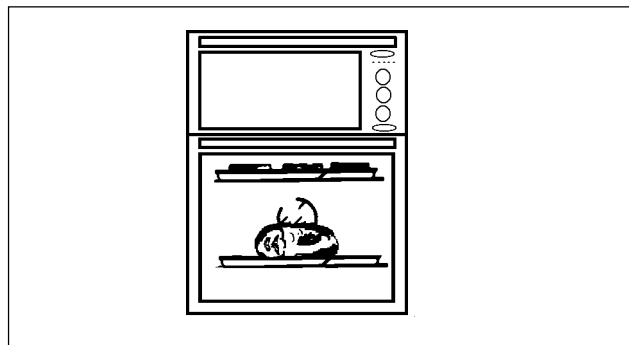

TO FIT THE MAIN OVEN SHELVES

The shelves should be fitted with the straight rods uppermost on the frame and the forms towards the back of the oven. If not fitted correctly the anti-tilt and safety stop mechanism will be affected.

HINTS AND TIPS

- Arrange the shelves in the required positions before switching the oven on. Shelves are numbered from the bottom upwards.

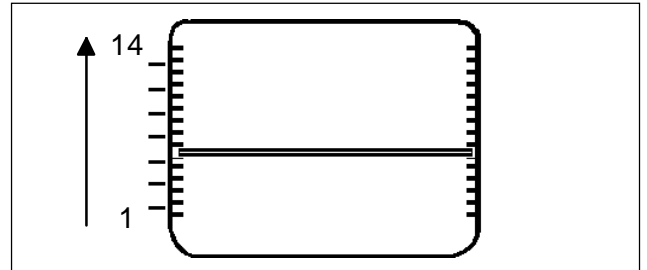
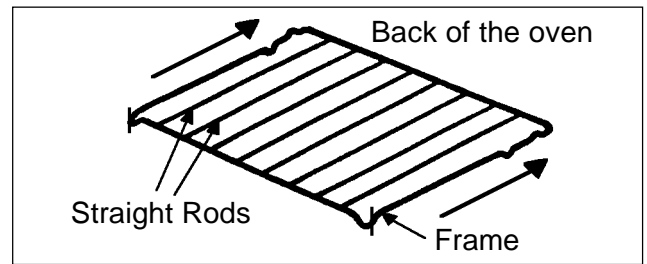

- When cooking more than one dish in the fan oven, place dishes centrally on different shelves rather than cluster several dishes on one shelf, this will allow the heat to circulate freely for the best cooking results.

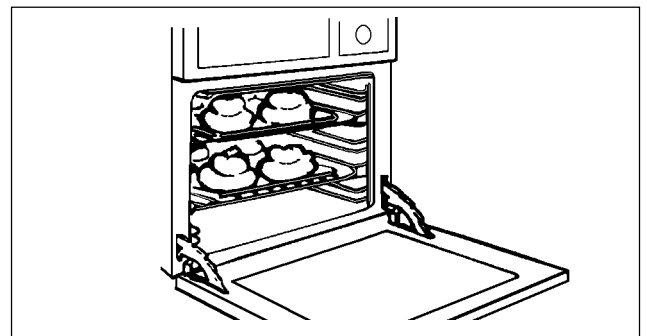

- It is recommended that when baking larger quantities, the shelf positions should be evenly spaced to suit the load being cooked. A slight increase in cooking time may be necessary.

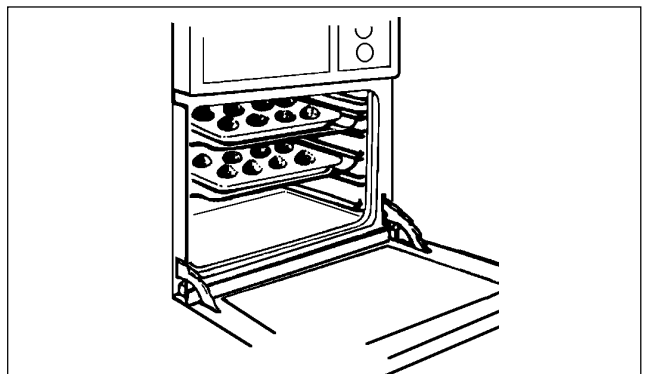

- The use of excessively high temperatures can cause uneven browning. It may be necessary to reduce temperatures slightly. Refer to the recommendations given in the oven cooking chart, on page 33.
- The material and finish of the baking trays and dishes used will affect base browning. Enamelware, dark heavy or non-stick utensils increase base browning, while oven glassware, shiny aluminium or polished steel trays reflect the heat away and give less base browning.

THE CONVENTIONAL OVEN

USES OF THE CONVENTIONAL OVEN

This form of cooking gives you the opportunity to cook without the fan in operation. It is particularly suitable for dishes which require extra base browning such as pizzas, quiches and flans. Gratin's, lasagne and hotpots which require extra top browning also cook well in the conventional oven. For best results cook on one level.

HOW TO USE THE CONVENTIONAL OVEN

1. Push out and turn the Selector to Conventional Oven. 
2. Push out and turn the main oven temperature control to the required setting.

THINGS TO NOTE

- The control surrounds will illuminate and the oven control surround will cycle on and off during use.
- The internal oven light operates when the Selector is set. If an automatic cooking programme is set, the oven light will come on when the cook time begins.
- The cooling fan for the controls may operate after a time. It may run on after the controls are switched off until the cooker has cooled. See page 7 for more details on the operation of the cooling fan.

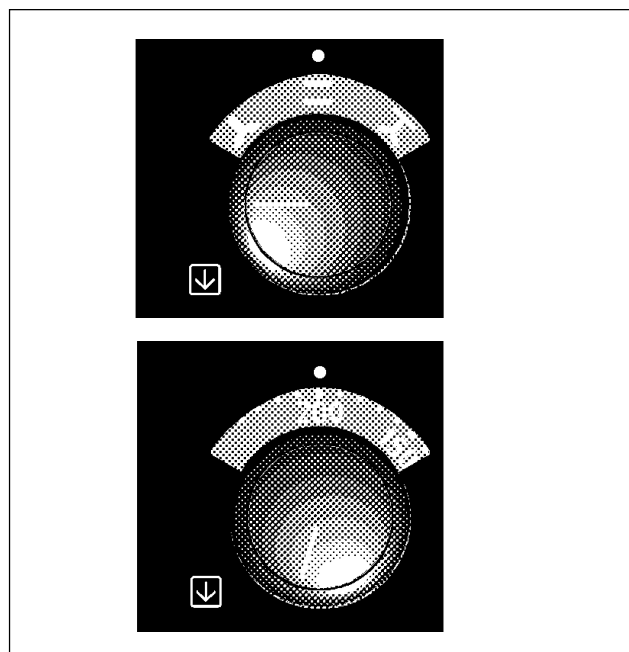

 Do not place dishes, tin or baking trays directly on the oven base as it becomes very hot and damage will occur.

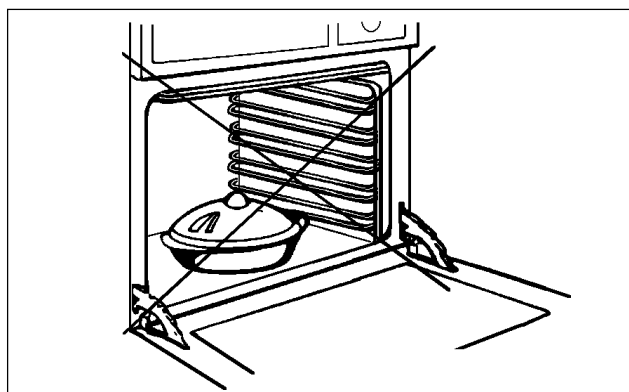



HINTS AND TIPS

- The middle shelf allows for the best heat distribution. To increase base browning simply lower the shelf position. To increase top browning, raise the shelf position.
- The material and finish of the baking trays and dishes used will affect base browning. Enamelware, dark heavy or non-stick utensils increase base browning, while oven glassware, shiny aluminium or polished steel trays reflect the heat away and give less base browning.
- Always place dishes centrally on the shelf to ensure even browning.
- Stand dishes on suitably sized baking trays to prevent spillage onto the base of the oven and make cleaning easier.
- Single level cooking gives best results. If you want to cook on more than one level use the fan or zoned oven functions.

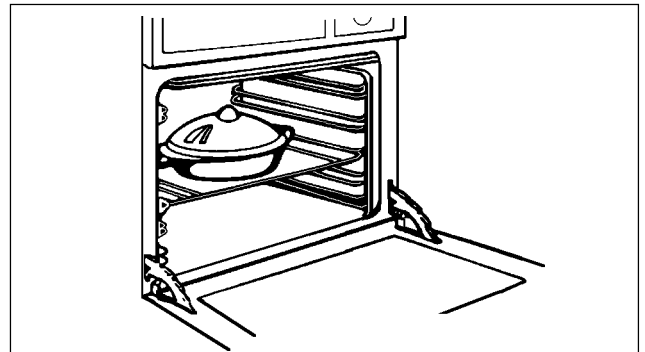
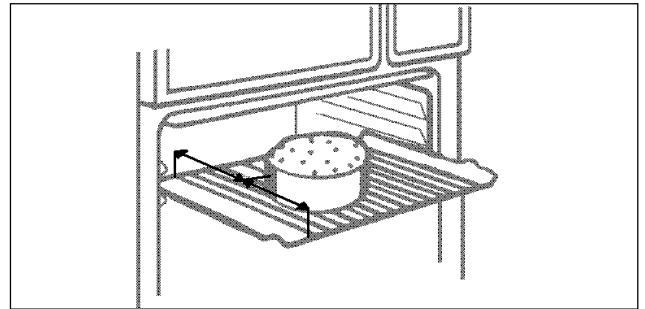
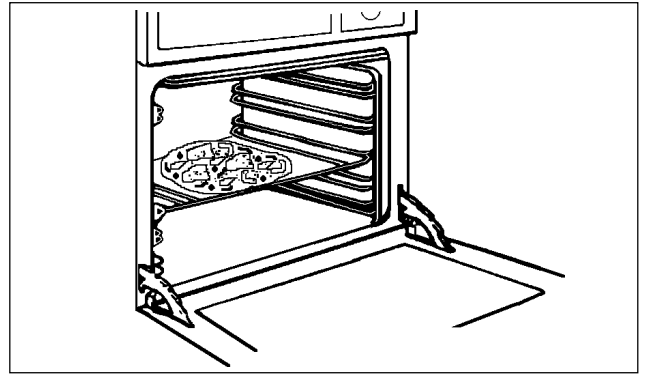

MAIN OVEN COOKING CHART

The oven temperatures are intended as a guide only. It may be necessary to increase or decrease the temperatures by a further 10°C to suit individual preferences and requirements.

Note: Shelf positions are counted from the bottom of the oven.

FOOD	FAN OVEN		CONVENTIONAL OVEN	
	SHELF POSITION	TEMP (°C)	SHELF POSITION	TEMP (°C)
Biscuits	2 & 12	160 -190	7	150 - 160
Bread	1 & 9	210 -220	4	210 - 220
Bread Rolls / Buns	2 & 12	210 -220	4	210 - 220
Cakes:				
Small & Queen	2 & 12	160 -170	4	170 - 180
Sponges	4 & 11	160 -170	4	160 - 170
Victoria Sandwich	4 & 11	160 -170	4	160 - 170
Madeira	7	140 - 150	7	160 - 170
Rich Fruit	7	140 -150	7	130 - 140
Christmas	7	130 - 140	1	130 - 140
Gingerbread	4 & 11	140 -150	7	140 - 160
Meringues	4 & 11	90 - 100	7	80 - 100
Flapjack	4 & 11	170 - 180	7	170 - 180
Shortbread	7	140 - 150	7	140 - 150
Baked Custard	7	140 - 150	7	160 - 170
Casseroles :				
Beef / Lamb	7	140 - 150	7	140 - 150
Chicken	7	160 -180	7	150 - 160
Convenience Foods	Any	Refer to	7	Refer to
		Packaging		Packaging
Fish	7	150 - 170	7	150 - 160
Fish Pie - potato topped	7	190 - 200	7	180 - 190
Fruit Pies, Crumbles	4 & 11	180 -190	7	190 - 200
Milk Puddings	7	130 - 140	7	130 - 140
Pasta / Lasagne etc.	7	180 - 190	7	190 - 200
Pastry : Choux -				
Eclairs/profiteroles	4 & 11	160 - 170	7	170 - 180
Flaky / Puff pies	7	210 - 220	7	210 - 220
Shortcrust -				
Mince pies	4 & 11	170 - 180	7	190 - 200
Meat pies	4 & 11	210 - 220	7	190 - 200
Quiche, Tarts, Flans	7	180 - 190	7	190 - 200
Roast Meat / Poultry	4	160 - 180	1	160 - 180
Scones	2 & 12	200 -210	4	210 - 220
Shepherds Pie	7	190 - 200	7	190 - 200
Soufflés	7	170 - 180	7	180 - 190
Vegetables : Baked Jacket Potatoes	7	190 - 200	7	190 - 200
Roast Potatoes	7	200 - 210	7	200 - 210
Yorkshire Puddings - large	10	210 -220	7	220 - 230
- individual	10	210 -220	7	220 - 230

AU GRATIN FUNCTION

USES OF AU GRATIN SETTING

This setting can be used whenever heating through and top browning is required. It is ideal for reheating and browning dishes such as Shepherds pie.

The top of the oven is hotter than the bottom. The approximate difference in temperature between the top and the bottom is 30°C.

HOW TO USE AU GRATIN

1. Push out and turn the Selector to the Au Gratin setting. 

2. Push out and turn the main oven temperature control to the required setting.

THINGS TO NOTE

- The control surrounds will illuminate and the oven control surround will cycle on and off during use.
- The cooling fan for the controls may operate after a time. It may run on after the controls are switched off until the cooker has cooled. See page 7 for further details on the cooling fan.
- If an automatic cooking programme is set, the oven light will come on when the cook time begins.

HINTS AND TIPS

- Use the Au Gratin setting for all dishes normally browned by a conventional grill.
- This setting is ideal for heating through and browning lasagne, cauliflower cheese, shepherds pie, fish pies etc.
- Use a setting of 200°C on the main oven temperature control.
- It is best to cover dishes where practical for part of the cooking time to prevent over browning. Uncover food for the last 15-30 minutes of cooking time to allow the food to brown.
- Ensure that food is placed centrally on the shelves and that there is sufficient room around the dishes to allow for maximum air circulation.

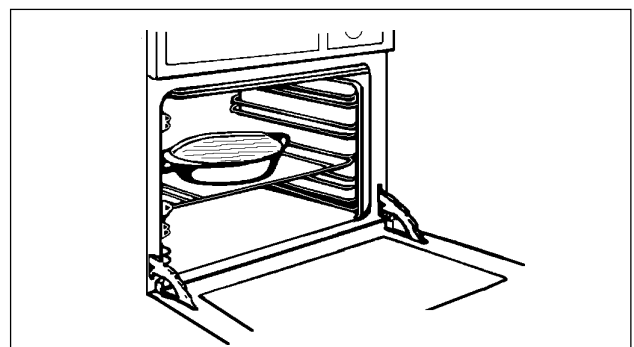
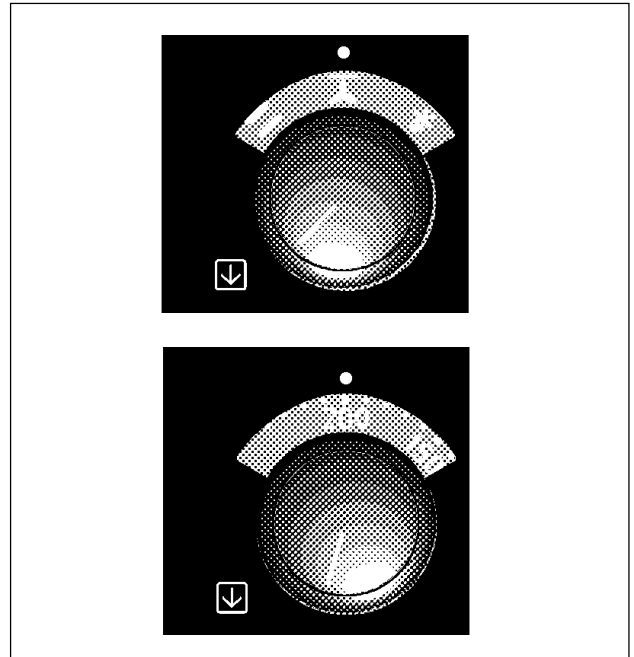

DEFROSTING IN THE MAIN OVEN ✕

USES OF DEFROST FEATURE

This main oven function enables you to defrost most foods without heat faster than some conventional methods as the oven fan circulates air around the food. It is particularly suitable for delicate frozen foods which are to be served cold e.g. cream filled gateaux, cakes covered with icings or frostings, cheesecakes, biscuits, scones etc.

HOW TO DEFROST

1. Push out and turn the Selector to Defrost setting. ✕
2. The Main Oven temperature control should be at the Off '0' position.

THINGS TO NOTE

- The oven fan and internal oven light will operate.
- The Selector control surround will illuminate.

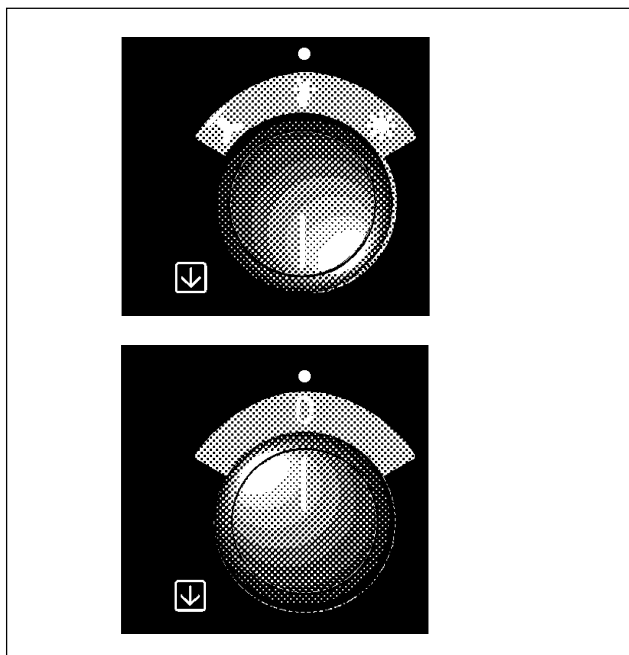
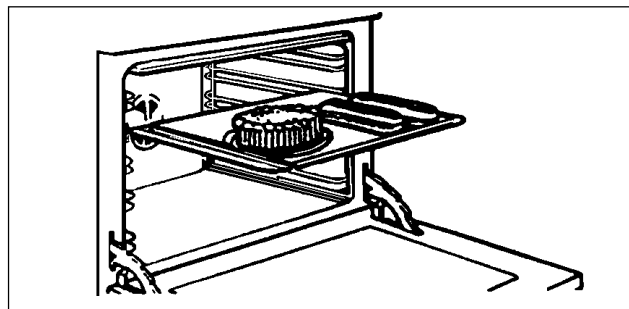

HINTS AND TIPS

- Place the frozen food in a single layer where possible and turn it over half way through the defrosting process.
- The actual speed of defrosting is influenced by room temperature. On warm days defrosting will be faster than on cooler days.
- It is preferable to thaw fish, meat and poultry slowly in the fridge. However, this process can be accelerated by using the defrost function. Small or thin fish fillets, frozen peeled prawns, cubed or minced meat, liver, thin chops, steaks etc., can be thawed in 1 - 2 hours.

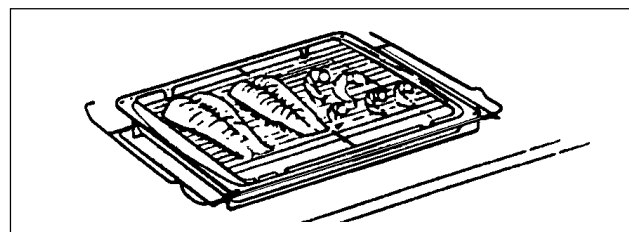
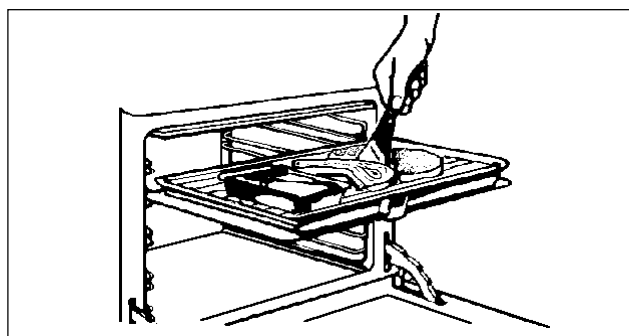

- A 1kg/2¼lb oven ready chicken will be thawed in approximately 5 hours. Remove the giblets as soon as possible during the thawing process.
- Joints of meat up to 2kg/4½lb in weight can be thawed using the defrost function.
- All joints of meat and poultry must be thawed thoroughly before cooking.
- Always cook thoroughly immediately after thawing.
- DO NOT leave food at room temperature once it is defrosted. Cook raw food immediately or store cooked food in the fridge.
- Care must always be taken when handling foods in the home. Always follow the basic rules of food hygiene to prevent bacterial growth and cross contamination when defrosting, preparing, cooking cooling and freezing foods.

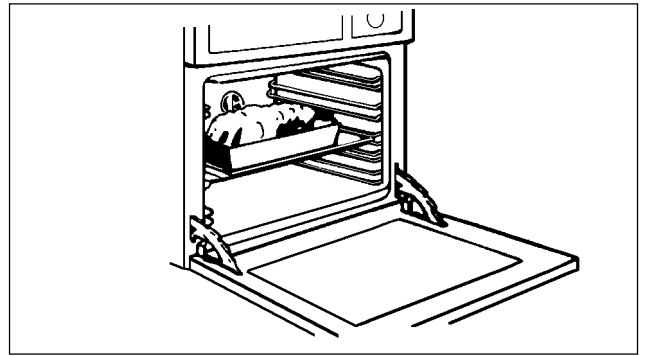

THERMAL GRILLING IN THE MAIN OVEN

USES OF THERMAL GRILLING

Thermal grilling in the main oven offers an alternative method of cooking food items normally associated with conventional grilling.

Thermal grilling helps to minimise cooking smells in the kitchen and allows you to grill with the oven door closed. The need to check and turn food is reduced. With the exception of toast and rare steaks you can thermal grill all the foods you would normally cook under a conventional grill.

COOKING TIMES

Cooking is more gentle, therefore food generally takes a little longer to cook when thermal grilling compared with conventional grilling. One of the advantages is that larger quantities can be cooked at the same time.

A general guide to cooking times is given on page 39 but these times may vary slightly depending on the thickness and quantity of food being cooked.

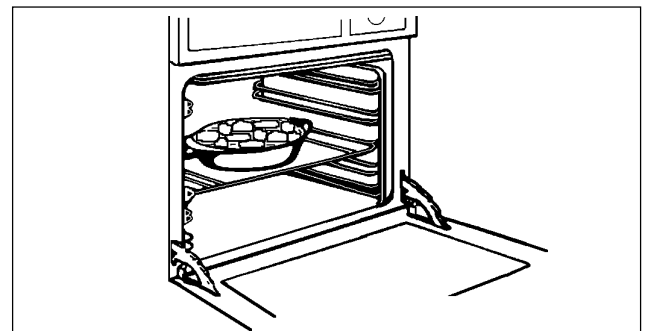
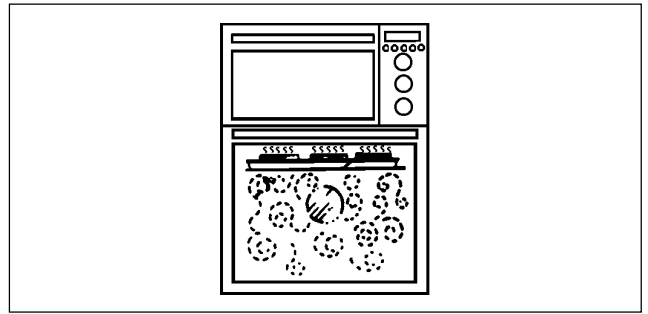

HOW TO THERMAL GRILL



Always thermal grill with the oven door closed and with the grill pan handle removed.

1. Push out and turn the Selector to Thermal Grill. 
2. Push out and turn the main oven temperature control to the required setting. (A temperature of between 140°C and 220°C is suitable for thermal grilling).
3. Remove the handle from the grill pan and close the oven door.

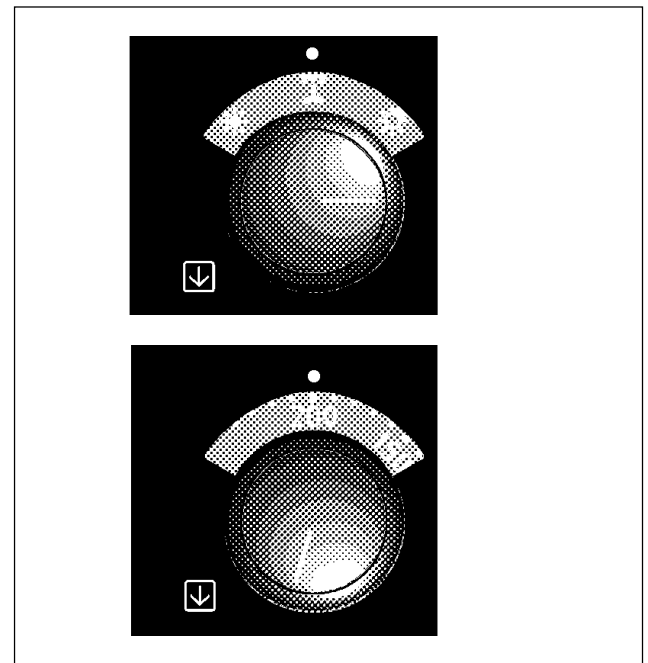

THINGS TO NOTE

- The control surrounds will illuminate. With prolonged use, the oven temperature control surround may cycle on and off.
- The oven fan will operate continually during thermal grilling.
- The oven light will come on when the selector is set.
- The cooling fan for the controls may operate after a time. It may run on after the controls are switched off until the cooker has cooled. See page 7 for more details on the operation of the cooling fan.



HINTS AND TIPS

- Prepare foods in the same way as for conventional grilling. Brush lean meats and fish lightly with a little oil or butter to keep them moist during cooking.
- Most food should be placed on the grill pan grid in the 'high' position in the grill pan to allow maximum circulation of air around the food. Foods such as fish, liver and kidneys may be placed directly onto the trivet in the grill pan if preferred.
- The use of the trivet beneath the grid when grilling fatty foods will help minimise fat splashing.
- Accompaniments such as tomatoes and mushrooms may be placed below the grid when grilling meats, or in a separate dish on a lower shelf.

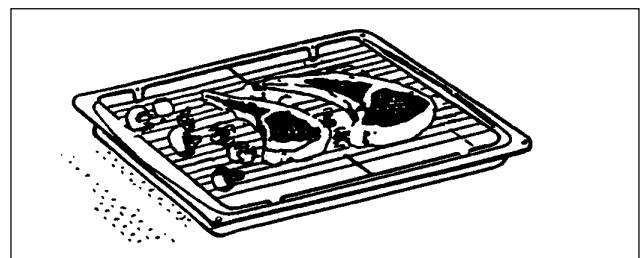
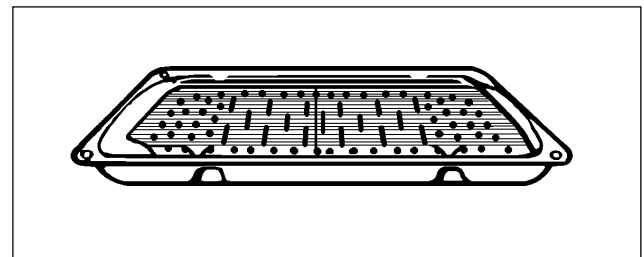
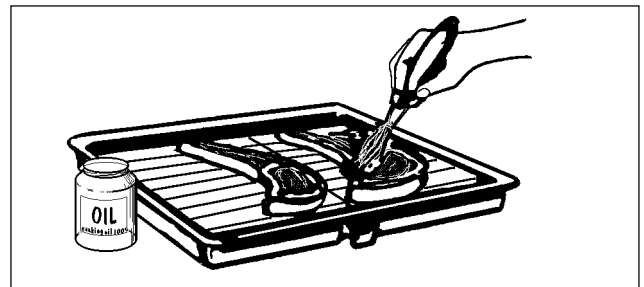

- Foods will cook more quickly the closer they are to the grill element and the higher the temperatures selected. Be prepared to adjust temperatures and shelf positions during cooking if necessary.
- Turn food over during cooking as necessary.

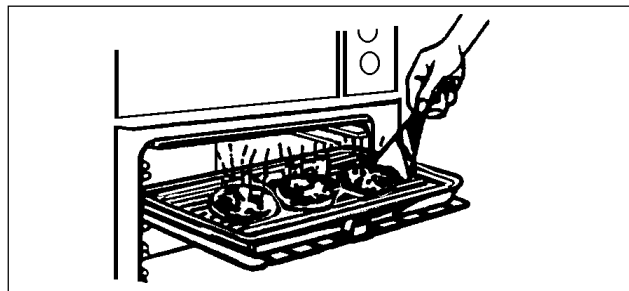

- Ensure that ready prepared or cooked chilled dishes e.g. shepherds pie, moussaka, lasagne, etc., are piping hot throughout before serving.
- A temperature range of 140°-220°C and shelf positions 9 and 10 are suitable for most foods. Be prepared to make suitable adjustments during cooking to suit individual requirements. If thermal grilling on more than one level, it may be necessary to interchange the food on the shelves during cooking.

THERMAL GRILLING CHART

FOOD	SHELF	TEMP (°C)	TIME (MINS IN TOTAL)
Bacon Rashers	9	200	10 - 12
Beefburgers	9	190	10 -15
Chicken Joints	8	160	30 - 40
Chops - Lamb	9	170	20 - 30
- Pork	9	170	20 - 30
Fish - Whole Trout / Mackerel	9	170	10 - 20
Filletts - Plaice / Cod	10	170	10 - 20
Kebabs	10	170	20 - 30
Kidneys - Lamb / Pig	9	180	20 - 30
Liver - Lamb / Pig	9	190	10 - 15
Sausages	9	190	10 - 15
Steaks - Medium	10	220	8 -10 each side
- Well Done	10	220	10 -15 each side
Heating through and browning eg. au gratin, lasagne, Shepherds pie	9	170	20 (depends on size)

CARE AND CLEANING



Before cleaning the cooker always allow the cooling fan for the controls to cool the cooker down before switching off the electricity supply.

CLEANING MATERIALS

Before using any cleaning materials on your cooker, check that they are suitable and that their use is recommended by the manufacturer.

Cleaners that contain bleach should NOT be used as they may dull the surface finishes. Harsh abrasives should also be avoided.

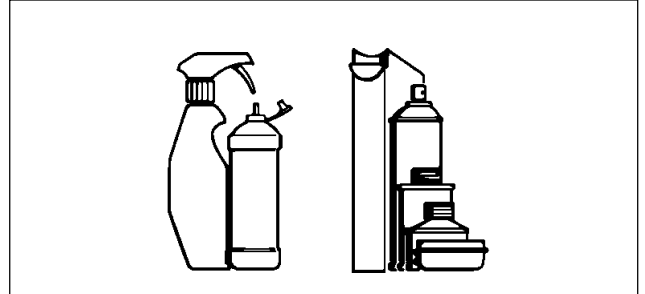

CLEANING THE OUTSIDE OF THE COOKER

DO NOT use abrasive cleaning materials or scourers on the outside of the cooker as some of the finishes are painted and damage may occur. Regularly wipe over the control panel and oven doors using a soft cloth well wrung out in warm water to which a little liquid detergent has been added.

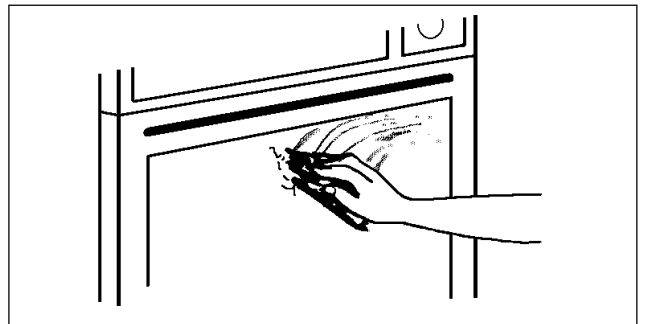

Do not attempt to remove any of the control knobs from the panel as this may cause damage and is a safety hazard.

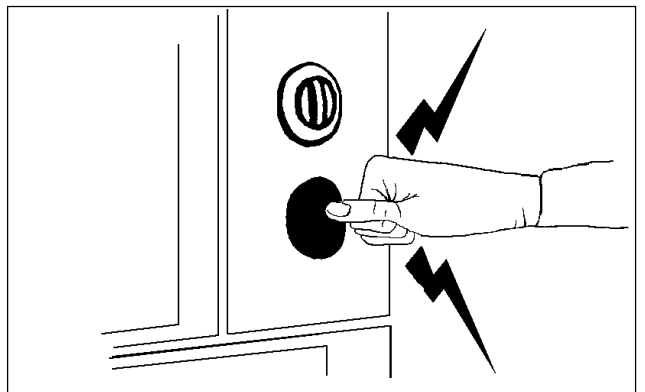

CLEANING THE OUTER AND INNER DOOR GLASS PANELS



To prevent damaging or weakening the door glass panels avoid the use of the following:

- Household detergents and bleaches
- Impregnated pads unsuitable for non-stick saucepans
- Brillo/Ajax pads or steel wool pads
- Chemical oven pads or aerosols
- Rust removers
- Bath/Sink stain removers

The outer oven door glass panels are removable for cleaning.

TO REMOVE THE OUTER GLASS

1. Open the oven door slightly to gain access to the two cross head screws on the top of the oven door.
2. Loosen the two screws using a Pozidrive screwdriver.
3. Holding the door glass securely in place with one hand remove the screws and washers with the other hand.

The screws and washers retain the trim on the top of the grill door. Note the position of the trim on the door.

4. Holding the door and glass with one hand, pull towards you and slightly lift the door glass with the other hand to disengage the panel from the location point at the bottom of the door. Gently release the door to close it.
5. Clean the outer and inner glass using hot soapy water or Hob Brite. Should the inner face of the outer door glass be heavily soiled it is recommended that soapy water with a high concentration of soap is used. To prevent streaking a glass cleaning spray may be applied and the glass polished with a soft cloth. Ensure that all parts are well rinsed and thoroughly dry before attempting to replace the outer door glass.



If the door glass panel becomes chipped or has deep scratches the glass will be weakened and must be replaced to prevent the possibility of the panel shattering. Please contact your local Service Centre who will be pleased to advise further.

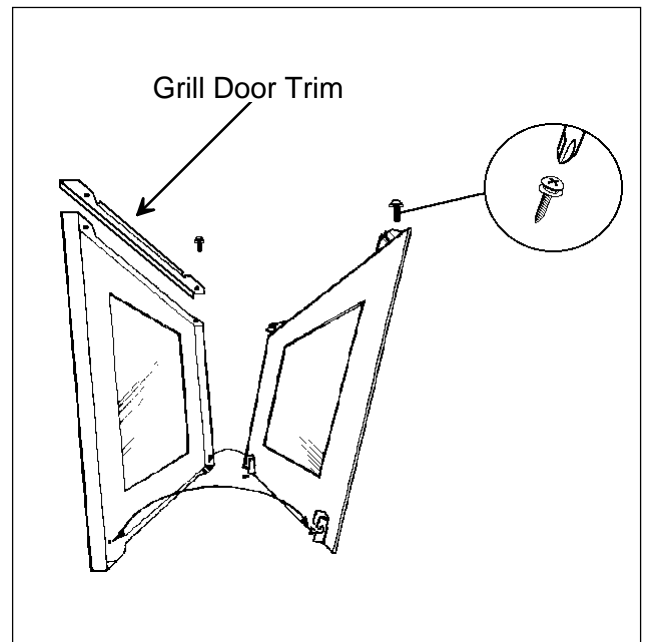

TO REPLACE THE OUTER DOOR GLASS

1. Holding the door glass panel with both hands, gently place the locators into the holes of the brackets at the bottom of the oven door.
2. Holding the door glass with your left hand, use your right hand to open the oven door. Bring the door gently towards the glass panel ensuring the screw location holes line up.
3. Place the trim in the correct position on the top of the grill door.
4. Hold the glass in place with one hand and insert the cross head screws with washers into the location holes with the other hand. Give the screws one turn to ensure the glass is secure.
5. Tighten the screws positively with a Pozidrive screwdriver before closing the oven door.

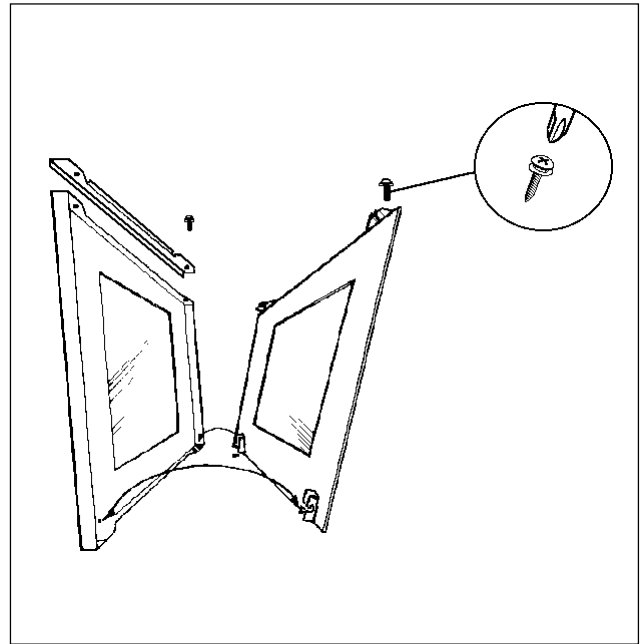

DO NOT attempt to use the oven without the glass being in place.

TO CLEAN THE INNER GLASS DOOR

The inner glass door is not removable. Clean using hot soapy water or Hob Brite and a soft cloth. **DO NOT** use abrasives as they may damage the glass or seal.

CLEANING THE MAIN OVEN

The main oven top, sides and back panels are coated with a Stayclean finish.

The Stayclean areas in the main oven should not be cleaned manually. See Oven Clean Feature on page 46.

The main oven base can be cleaned using normal oven cleaners or aerosol oven cleaners with care. Ensure that the manufacturers instructions are followed and that all parts are well rinsed afterwards.

Do not use any cleaning agents or scrapers on the oven tops, sides, back panels and door seals.

Damage will occur if soap impregnated steel wool pads, aerosol cleaners or any abrasive cleaners are used.

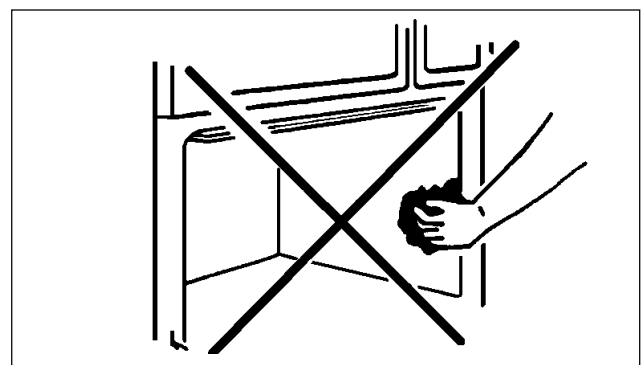

CLEANING THE GRILL/ TOP OVEN COMPARTMENT

The Top oven top, sides and back panels are coated with a Stayclean finish.

The Stayclean areas in the Top oven should not be cleaned manually.

Follow the procedure below to maintain the appearance of the Stayclean finish.

The Top oven base can be cleaned using normal oven cleaners or aerosol oven cleaners with care. Ensure that the manufacturers instructions are followed and that all parts are well rinsed afterwards.

Do not use any cleaning agents or scrapers on the oven top, sides, back panels and door seal. **Damage will occur if soap impregnated steel wool pads, aerosol cleaners or any abrasive cleaners are used.**

THE OVEN CLEANING CYCLE - TOP OVEN

1. Remove oven shelves and bakeware from oven.
2. Push out the Fan Selector button.
3. Push out and turn the top oven temperature control to 220°C and allow the oven to run for an hour or so.

THINGS TO NOTE

- The Fan Selector neon will illuminate.
- The Cooling Fan for the controls will operate after a short time. It may run on after the controls are switched off until the cooker has cooled. See page 7 for more details on the operation of the cooling fan.

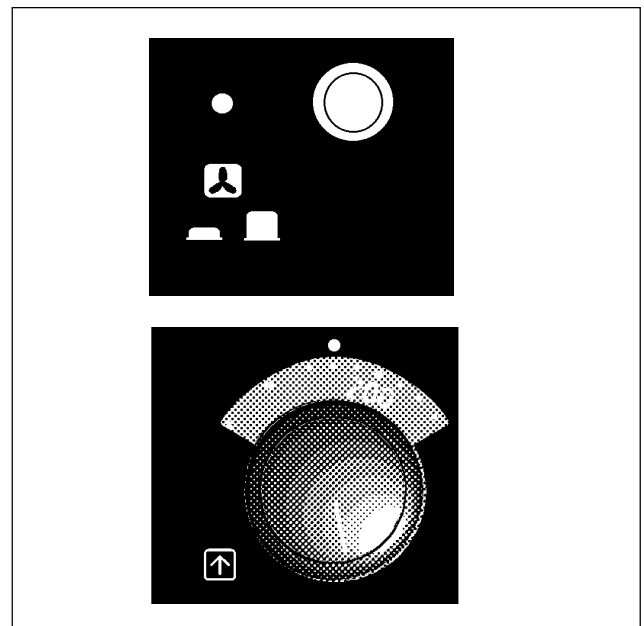

i HINTS AND TIPS

- Slight discolouration and polishing of the Stayclean surfaces may occur in time, but this will not affect their self cleaning properties.
- A good time to use the oven cleaning cycle is after the weekly roast.
If you do a lot of roasting and very little baking you should follow the cleaning cycle every week. If you roast very little you will only need to follow the cleaning cycle every 2 - 3 weeks.
- Follow the recommendations below to keep soilage to a minimum.

COOKING TO REDUCE SOILAGE

- Cook at the recommended temperatures. Higher temperatures during roasting will increase soilage. Try cooking at lower temperatures for an increased length of time, you will save energy and often the joint is more tender.
- Use minimal, if any, extra oil or fat when roasting meat, potatoes only require brushing with fat before cooking. Extra fat in the oven during roasting will increase splashing and soilage.
- It is not necessary to add water to the meat tin when roasting. The water and the fat juices from the joint create excessive splattering during cooking, even at normal temperatures, as well as causing condensation.
- Covering joints during cooking will also prevent splashing onto the interior surfaces. Removing the covering for the last 20-30 minutes will allow extra browning if required. Some large joints and turkeys especially benefit by this method of cooking, allowing the joint to cook through before the outside is overbrowned.
- **Do use** the trivet in the roasting tin. During roasting the fat from the joint will be contained beneath the trivet and therefore prevent it from splattering onto the Stayclean finish.

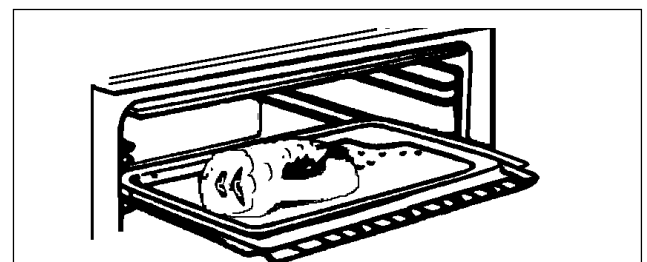
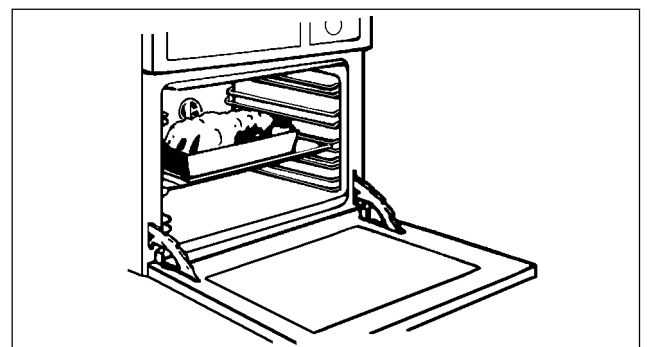
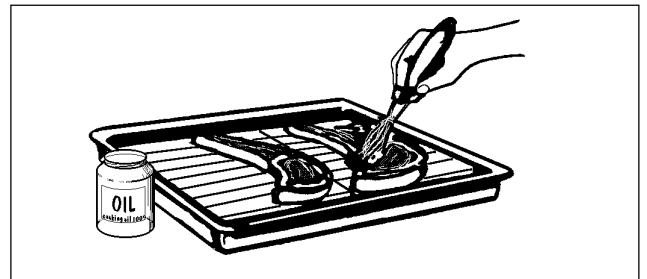

TO REMOVE THE WIREWORK RUNNERS

The wirework runners in both ovens can be removed for cleaning.

1. Remove all shelves and furniture from the oven.
2. Hold the wirework at the bottom, unclip from the cavity side and gently pull towards the centre of the oven.
3. Support the side panel at the bottom.
4. Unhook the runner and side panel at the top and remove them from the cavity.
5. To replace, ensure the side panels assembled onto the wirework runner before hooking it back into the oven.

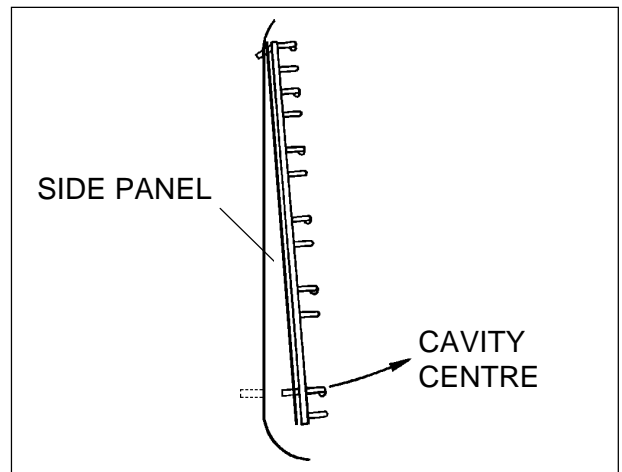

CLEANING THE SHELVES, WIREWORK RUNNERS AND OVEN FURNITURE

Soak the oven shelves, wirework runners and grilling grid in hot soapy water if heavily soiled, they will then clean more easily. If the shelves are heavily soiled a soap impregnated steel wool pad can be used.

The grill pan, meat tin and trivet can be cleaned using a soap impregnated steel wool pad.

All items of grill and oven furniture are dishwasher safe with the exception of the grill pan handle.

OVEN CLEAN FEATURE

USES OF OVEN CLEAN

The main oven top, sides and back panel are coated with a Stayclean finish.

During normal use the Stayclean coating on the oven interior will become splashed with fats and food residues. When Oven Clean is selected, the Stayclean surfaces burn off any soilage. Regular use of the Oven Clean function will help to keep the panels in good condition.

HOW TO USE OVEN CLEAN - MAIN OVEN ONLY

1. Remove oven shelves and bakeware from oven.
2. Push out and turn the Selector to Oven Clean. 
3. Push out and turn the main oven temperature control to 220°C and allow the oven to run for an hour or so.

THINGS TO NOTE

- The control surrounds will illuminate. The oven temperature control surround may cycle on and off during use.
- The internal oven light will come on when the selector is set.
- The cooling fan for the controls may operate after a time when the oven clean is selected. It may run on after the controls are switched off until the cooker has cooled. See page 7 for more details on the operation of the cooling fan.
- The oven fan operates continually when oven clean is selected.

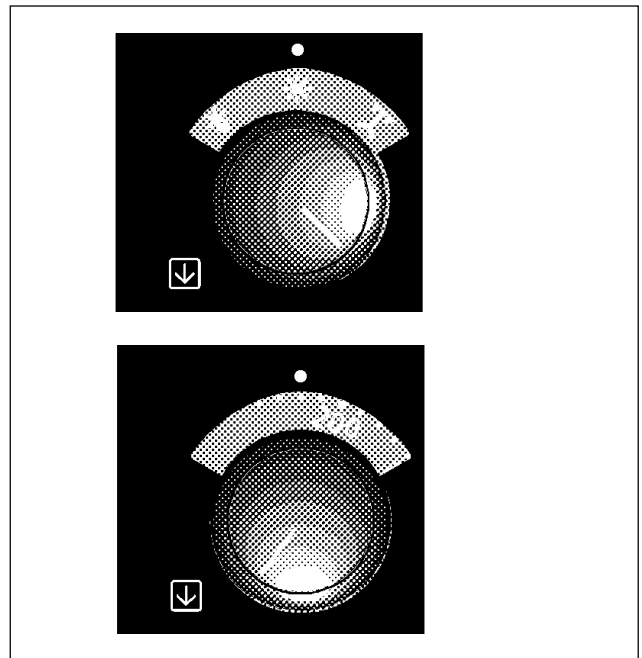

i HINTS AND TIPS

- Slight discolouration and polishing of the Stayclean surfaces may occur in time, but this will not affect their self cleaning properties.
- A good time to use the oven clean function is after the weekly roast.
If you do a lot of roasting and very little baking you should follow the cleaning cycle every week. If you roast very little you will only need to follow the cleaning cycle every 2 - 3 weeks.
- Follow the recommendations below to keep soilage to a minimum.

COOKING TO REDUCE SOILAGE

- Cook at the recommended temperatures. Higher temperatures during roasting will increase soilage. Try cooking at lower temperatures for an increased length of time, you will save energy and often the joint is more tender.
- Use minimal, if any, extra oil or fat when roasting meat, potatoes only require brushing with fat before cooking. Extra fat in the oven during roasting will increase splashing and soilage.
- It is not necessary to add water to the meat tin when roasting. The water and the fat juices from the joint create excessive splattering during cooking, even at normal temperatures, as well as causing condensation.
- Covering joints during cooking will also prevent splashing onto the interior surfaces. Removing the covering for the last 20-30 minutes will allow extra browning if required. Some large joints and turkeys especially benefit by this method of cooking, allowing the joint to cook through before the outside is overbrowned.
- **Do use** the trivet in the roasting tin. During roasting the fat from the joint will be contained beneath the trivet and therefore prevent it from splattering onto the Stayclean finish.

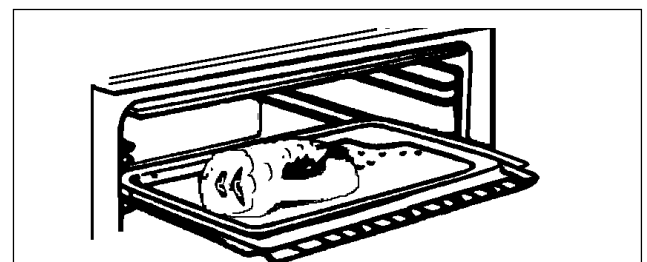
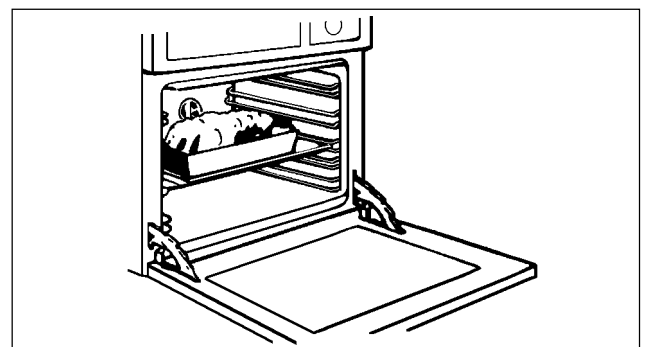
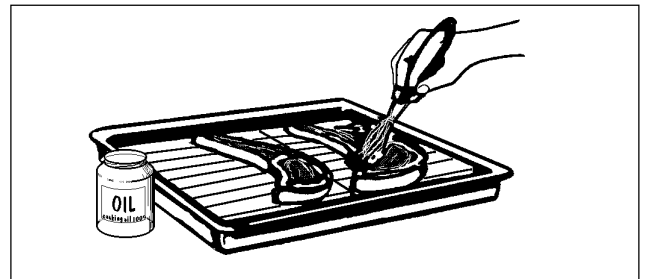

THE OVEN LIGHT

The oven light illuminates the oven when the Selector is turned to  .

This is useful for improving visibility when cleaning the oven base.

REPLACING THE OVEN LIGHT BULB

 Isolate the cooker from the electricity supply before replacing the bulb.

The type of bulb required is a 300°C, 25 watt small Edison Screw.

1. Make sure the cooker is cool before you replace a bulb.
2. Open the oven door and remove the shelves wirework runners and side panels. Instructions on how to remove the wirework runners are given on page 45.
3. Pull the glass bulb cover towards you and then pull it off. If necessary use a screwdriver to carefully lever off the cover, taking care not to damage the oven cavity.
4. Unscrew the bulb by turning it to the left.
5. Fit a new bulb and then replace the glass bulb cover.
6. Refit the wirework runners, side panels and replace the oven shelves.
7. Restore the cooker to the electricity supply and reset the time of day.

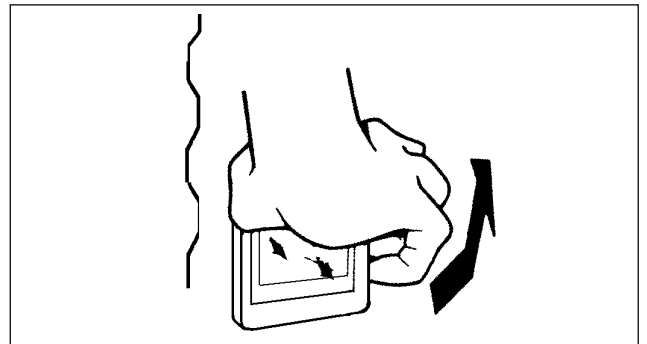

IF SOMETHING DOESN'T WORK

Please carry out the following checks on your cooker before calling a Service Engineer. It may be that the problem is a simple one which you can solve yourself without the expense of a service call.

If our Service Engineer finds that the problem is listed below you will be charged for the call whether or not the cooker is under guarantee.

PROBLEM	POSSIBLE SOLUTION
The grill, ovens and timer do not work	<p>Check that the cooker has been wired in to the cooker supply and is switched on at the wall.</p> <p>Check that the main cooker fuse is working.</p>
The Grill and Top Oven work but the Main Oven does not.	<p>Check that the timer is set for manual operation. See page 11.</p>
The Grill does not work or cuts out after being used for a long period of time.	<p>Check that only the Grill control has been turned. If the Top Oven control has been turned it will override the grill.</p> <p>Ensure that the grill door is open when grilling. Leave the grill door open and allow the grill to cool. After a couple of hours check that the grill works as normal.</p> <p>Ensure the cooling fan is running when the grill is on. If the cooling fan fails, the grill will cycle on and off. Contact your nearest Service Centre.</p>
The timer does not work	<p>Check that the instructions for the operation of the timer are being closely followed.</p>
The indicator neons are not working correctly	<p>Check that you have selected only the function you require. Ensure all other controls are in the Off 'O' position.</p>
The oven is not cooking evenly	<p>Check that the cooker is correctly installed and is level.</p> <p>Check that the recommended temperatures and shelf positions are being used.</p>

The oven light fails to illuminate

The oven light bulb may need replacing see page 48.

If the Main Oven is set for automatic cooking the light will illuminate when the cook time begins.

The oven fan is noisy

Check that the oven is level.

Check that shelves and bakeware are not vibrating in contact with the oven back panel.

The oven temperature is too high or low

Check that the recommended temperatures and shelf positions are being used. See pages 23 and 33. Be prepared to adjust up or down by 10°C to achieve the results you want.

GUARANTEE CONDITIONS

Standard guarantee conditions

AEG offer the following guarantee to the first purchaser of this appliance:

1. The guarantee is valid for 12 months commencing when the appliance is handed over to the first retail purchaser, which must be verified by purchase invoice or similar documentation.
The guarantee does not cover commercial use.
2. The guarantee covers all parts or components which fail due to faulty workmanship or faulty material. The guarantee does not cover appliances where defects or poor performance are due to misuse, accidental damage, neglect, faulty installation, unauthorised modification or attempted repair, commercial use or failure to observe requirements and recommendations set out in the instruction book.
This guarantee does not cover such parts as light bulbs, removable glassware.
3. Should guarantee repairs be necessary the purchaser must inform the nearest customer service office (AEG's service or authorised agent). AEG reserves the right to stipulate the place of repair (i.e. the customer's home, place of installation or AEG workshop).
4. The guarantee or free replacement includes both labour and materials.
5. Repairs carried out under guarantee do not extend the guarantee period for the appliance. Parts removed during guarantee repairs become the property of AEG.
6. The Purchaser's statutory rights are not affected by this guarantee.

European Guarantee

If you should move to another country within Europe then your guarantee moves with you to your new home subject to the following qualifications:

- The guarantee starts from the date you first purchased your product
- The guarantee is for the same period and to the same extent for labour and parts as exists in the new country of use for this brand or range of products
- This guarantee relates to you and cannot be transferred to another user
- Your new home is within the European Community (EC) or European Free Trade Area
- The product is installed and used in accordance with our instructions and is only used domestically, i.e. a normal household
- The product is installed taking into account regulations in your new country

Before you move please contact your nearest Customer Care centre, listed below, to give them details of your new home. They will then ensure that the local Service Organisation is aware of your move and able to look after you and your appliances.

France	Senlis	+33 (0)3 44 62 29 29
Germany	Nürnberg	+49 (0)911 323 2600
Italy	Pordenone	+39 (0)1678 47053
Sweden	Stockholm	+46 (0)8 738 79 10
UK	Newbury	+44 (0)1635 572 700

SERVICE AND SPARE PARTS

If after carrying out the necessary checks there is still a fault with your appliance please contact your local AEG Service Centre.

In-guarantee customers should make sure that the checks have been made as the engineer will make a charge if the fault is not a mechanical or electrical breakdown.

Please note that proof of purchase is required for in-guarantee service calls.

Service & Spare Parts

Spare parts can be purchased through your local service centre.

To contact your local AEG Service Centre, please telephone:

0990 929929

Help us to help you

Please determine your type of enquiry before writing or telephoning. When you contact us we need to know,

1. Your name, address and post code.
2. Your telephone number.
3. Clear and concise details of the fault.
4. The model, serial and product number.
5. Date of purchase.

The model, serial and product number can be found on the rating plate on the lower front frame of the cooker upon opening the oven door. It is advisable to make a note on the inside back cover of this book for easy reference.

Customer Care

For general enquiries concerning your AEG appliance, or further information on AEG products, you are invited to contact our Customer Care Department by letter or telephone:

Customer Care Department
AEG Domestic Appliances Limited
PO Box 47
Newbury
Berkshire RG14 5XL

Tel: 01635 572700

Fax: 01635 42970

To contact your local AEG Service Centre telephone **0990 929929**

CHANNEL ISLANDS

GUERNSEY	Guernsey Electricity PO Box 4 Vale, Guernsey Channel Islands
JERSEY	Jersey Electricity Company PO Box 45 Queens Road St Helier Jersey Channel Islands JE4 8NY

SCOTLAND

ABERDEEN (M05)	8 Cornhill Arcade Cornhill Drive Aberdeen AB2 5UT
AUCHTERMUCHY (M03)	33A Burnside Auchtermuchy Fife KY14 7AJ
BLANTYRE (M07)	Unit 5 Block 2 Auchenraith Ind Estate Rosendale Way Blantyre G72 0NJ
DUMFRIES (M01)	93 Irish Street Dumfries Scotland DG1 2PQ
DUNOON (M67)	Briar Hill 7 Hill Street, Dunoon Argyll PA23 7AL
GLASGOW (M04)	20 Cunningham Road Clyde Estate Rutherglen, Glasgow, G73 1PP
INVERNESS (M06)	Unit 3B Smithton Indust. Est. Smithton Inverness IV1 AJ
ISLE OF ARRAN (OWN SALES)	Arran Domestics Unit 4 The Douglas Centre Brodrick Isle of Arran KA27 8AJ
ISLE OF BARRA (OWN SALES)	J Zerfah 244 Bruernish Isle of Barra Western Islands HS9 5QY
ISLE OF BUTE (M66)	Walker Engineering Glenmhor Upper Serpentine Road Rothsay Isle of Bute PA20 9EH
ISLE OF LEWIS (M69)	ND Macleod 16 James Street Stornoway Isle of Lewis PA87 2QW
KELSO (M08)	2-8 Wood Market Kelso Borders TD5 7AX

ORKNEY (M65)	Corsie Domestics 7 King Street Kirkwall Orkney KW15
SHETLAND (OWN SALES)	Tait Electronic Systems Ltd. Holmsgarth Road Lerwick Shetland ZE1 0PW
SHETLAND (OWN SALES)	Boils Shetland Ltd 26 North Road Lerwick Shetland ZE1 0PE
WHALSAY (OWN SALES)	Leask Electrical Harlsdale Symbister, Whalsay Shetland ZE2 9AA

NORTHERN IRELAND

BELFAST (M27)	Owenmore House Kilwee Industrial Estate Upper Dunmury Lane Belfast BT17 0HD
------------------	---

WALES

CARDIFF (M28)	Guardian Industrial Estate Clydesmuir Road Tremorfa, Cardiff CF2 2QS
CLYWD (M14)	Unit 6-7 Coed - Parc Abergele Road Rhuddlan Clwyd Wales LL18 5UG
DYFED (M77)	Maes Y Coen High Mead Llanybydder Dyfed SA40 9UL
HAVERFORDWEST (M75)	Cromlech Lodge Ameriston Haverfordwest SA62 5DS
OSWESTRY (M17)	Plas Ffynnon Warehouse Middleton Road Oswestry SY11 2PP

NORTH EAST

GATESHEAD (M39)	Unit 356a Dukesway Court Dukesway Team Valley Gateshead NE11 0BH
GRIMSBY (M42)	Unit 2 Cromwell Road Grimsby South Humberside DN31 2BN
HULL (M41)	Unit 1 Boulevard Industrial Estate Hull HU3 4AY
LEEDS (M37)	64-66 Cross Gates Road Leeds LS15 7NN
NEWTON AYCLIFFE (M45)	Unit 16 Gurney Way Aycliffe Ind Estate Newton Aycliffe DL5 6UJ
SHEFFIELD (M38)	Pennine House Roman Ridge Ind. Roman Ridge Road Sheffield S9 1GB

NORTH WEST

BIRKENHEAD (M11)	1 Kelvin Park Dock Road Birkenhead L41 1LT
CARLISLE (M10)	Unit 8 South John Street Carlisle CA2 5AJ
ISLE OF MAN (M64)	South Quay Ind Estate Douglas Isle of Man
LIVERPOOL (M15)	Unit 1 Honeys Green Precinct Honeys Green Lane Liverpool L12 9JH
MANCHESTER (M09)	Unit 30, Oakhill Trading Estate Devonshire Road Worsley Manchester M28 3PT
PRESTON (M13)	Unit 250 Dawson Place Walton Summit Bamber Bridge Preston Lancashire PR5 8AL
STOCKPORT (M16)	Unit 20 Haigh Park Haigh Avenue Stockport SK4 1QR

To contact your local AEG Service Centre telephone **0990 929929**

MIDLANDS

BIRMINGHAM (M18)	66 Birch Road East, Wyrley Road Industrial Estate Witton Birmingham B6 7DB
BOURNE (M44)	Manning Road Ind Estate Pinfold Road Bourne PE10 9HT
BRIDGNORTH (M72)	1 Underhill Street Bridgnorth Salop WV16 4BB
GLOUCESTER (M23)	101 Rycroft Street Gloucester GL1 4NB
HEREFORD (M31)	Unit 3 Bank Buildings Cattle Market Hereford HE4 9HX
HIGHAM FERRERS (M51)	30 High Street Higham Ferrers Northants NN10 8BB
ILKESTON (M43)	Unit 2 Furnace Road Ilkeston DE7 5EP
LEICESTER (M22)	Unit 7 Oaks Industrial Estate Coventry Road Narborough Leicestershire LE9 5GF
LINCOLN (M40)	Unit 8 Stonefield Park Clifton Street Lincoln LN5 8AA
NEWCASTLE UNDER LYME (M12)	18-21 Croft Road Brampton Industrial Estate Newcastle under Lyme Staffordshire ST5 0TW
NUNEATON (M21)	19 Ptarmigan Place Townsend Drive Nuneaton CV11 6RX
REDDITCH (M20)	13 Thornhill Road North Moons Moat Redditch Worcestershire B98 9ND
TAMWORTH (M19)	Unit 3 Sterling Park Claymore Tamworth B77 5DO
WORCESTER (M73)	Unit 1 Northbrook Close Gregorys Mill Ind Estate Worcester WR3 8BP

LONDON & EAST ANGLIA

CHELMSFORD (M47)	Hanbury Road Widford Ind Estate Chelmsford Essex CM12 3AE
COLINDALE (M53)	Unit 14 Capitol Park Capitol Way Colindale London NW9 0EQ
ENFIELD (M49)	284 Alma Road Enfield London EN3 7BB
GRAVESEND (M57)	Unit B4, Imperial Business Estate Gravesend Kent DA11 0DL
HARPENDEN (M46)	Unit 4 Riverside Estate Coldharbour Lane Harpenden AL5 4UN
LETCHEWORTH (M50)	16-17 Woodside Ind Est. Works Road Letchworth Herts SG6 1LA
MAIDENHEAD (M60)	Reform Road Maidenhead Berkshire SL6 8BY
MOLESEY (M61)	10 Island Farm Avenue West Molesey Surrey KT8 2UZ
NEWBURY (M24)	PO Box 5627 Newbury Berkshire RG14 5GF
IPSWICH (M48)	Unit 2B Elton Park Business Centre Hadleigh Road Ipswich IP2 0DD
NORWICH (M52)	2b Trafalgar Street Norwich NR1 3HN
SUNBURY (M63)	Unit 1a The Summit Hanworth Road Hanworth Ind Estate Sunbury on Thames TW16 5D
SYDENHAM (M62)	Unit 6 Metro Centre Kangley Bridge Road Sydenham SE26
WEST DRAYTON (M76)	2 / 4 Royal Lane Yiewsley West Drayton Middlesex UB7 8DL

SOUTH EAST

ASHFORD (M58)	Unit 2 Bridge Road Business Estate Kent Bridge Road Ashford Kent TN2 1BB
FLEET (M59)	Unit 1 Redfields Industrial Estate Church Crookham Fleet Hampshire GU13 0RD
HAYWARDS HEATH (M55)	21-25 Bridge Road Haywards Heath Sussex RH16 1UA
TONBRIDGE (M56)	Unit 30 Deacon Trading Estate Morley Road Tonbridge Kent TN9 1RA

SOUTH WEST

BARNSTAPLE (M30)	P.O. Box 12 Barnstaple North Devon EX31 2YB
BOURNEMOUTH (M26)	63-65 Curzon Road Bournemouth Dorset BH1 4PW
BRIDGEWATER (M35)	6 Hamp Industrial Estate Bridgewater Somerset TA6 3NT
BRISTOL (M25)	11 Eldon Way Eldonwall Trading Bristol Avon BS4 3QQ
EMSWORTH (M33)	266 Main Road Southbourne Emsworth PO10 8JL
ISLE OF WIGHT (M34)	Unit 8 Enterprise Court Ryde Business Park Ryde Isle of Wight PO33 1DB
NEWTON ABBOT (M29)	Unit 2 Zealley Industrial Estate Kingsteignton Newton Abbot S. Devon TQ12 3TD
PLYMOUTH (M32)	16 Faraday Mill Cattledown Plymouth PL4 0ST
REDRUTH (M36)	Unit 7D Pool Industrial Estate Wilson Way, Redruth, Cornwall TR15 3QW

INSTALLATION INSTRUCTIONS

Voltage: 230\240 Volts AC 50Hz

Loading Info:

Top Oven* 1.7kW

Dual Grill: 2.8kW

Base Element: 1.0kW

Main Oven
Fan Element: 2.5kW

Fan Motor: 0.03kW

Oven Light: 0.05kW

Wattage: 5.0\5.5kW

Height: 720 mm

Width: 593 mm

Depth: 585 mm
(excluding handles and knobs)

* Cannot be used at the same time as the grill element.

This appliance complies with: European Council Directive 73/23/EEC.
EMC Directive 89/336/EEC.
CE Marking Directive 93/68/EEC.

INSTALLATION INSTRUCTIONS

THINGS YOU NEED TO KNOW



WARNINGS:

WARNINGS:

- This cooker must be installed by a qualified electrician/competent person. Safety may be impaired if installation is not carried out in accordance with these instructions.
- This cooker must be earthed.
- Do not remove the screws from the earth tab extending from the oven mains terminal block (Fig. 1).
- Before connecting the cooker make sure that the voltage of your electricity supply is the same as that indicated on the rating plate. The rating plate can be seen by opening the top oven door and looking below the oven door seal.
- Do not alter the electrical circuitry of this cooker.

CHOICE OF ELECTRICAL CONNECTION

- The cooker should be operated using at least 6mm² twin core and earth PVC insulated multicore cable. Please choose from the most appropriate after reading the descriptions:
- By connecting the cooker to a cooker point having a double pole isolating switch providing at least 3mm contact separation in all poles and protected with a fuse or miniature circuit breaker at your mains fuse box.
- If you wish to connect an oven and a hob to a cooker point you can, by connecting the oven and hob separately to the cooker point. See Fig. 2.

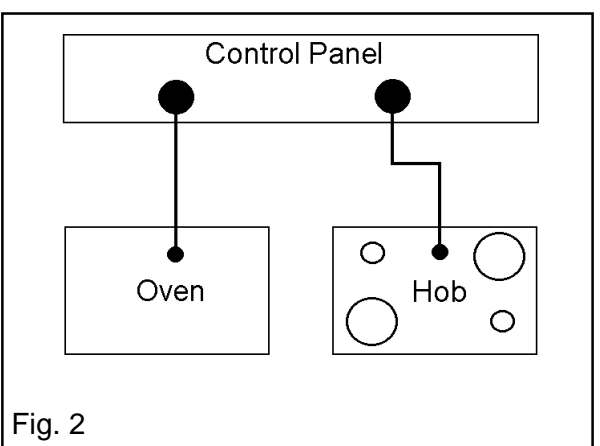
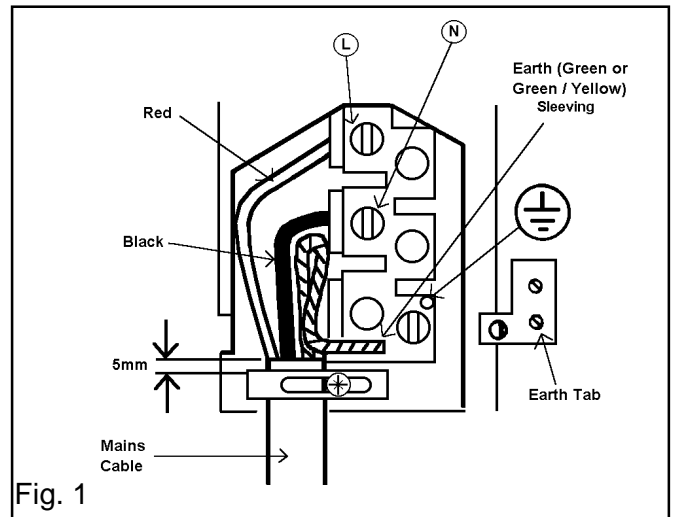

INSTALLATION INSTRUCTIONS

NOTE: It is good practice to:

- Fit an Earth Leakage Circuit Breaker to your house wiring.
- Wire your appliance to the latest IEE regulations.

THINGS TO NOTE

- This cooker is designed to be fitted between cabinets with the recommended dimensions as shown in Fig. 3 & 4.
- If there is an existing housing unit it must be removed.
- The dimensions given provide adequate air circulation around the unit within the cabinet, ensuring compliance with BS EN60-335.
- This appliance must not be installed on a wooden base board.
- Enquiries regarding the installation of the cooker point if required should be made to your Regional Electricity Company to ensure compliance with their regulations.
- The cooker point should be within 2m of the cooker to make it accessible to switch off the cooker in case of an emergency.
- To protect the hands wear gloves when lifting the oven into its housing.

NOTE: HOUSE CIRCUIT

Earth leakage / continuity tests must be carried out before the cooker is connected to the mains supply and re-checked after fitting.

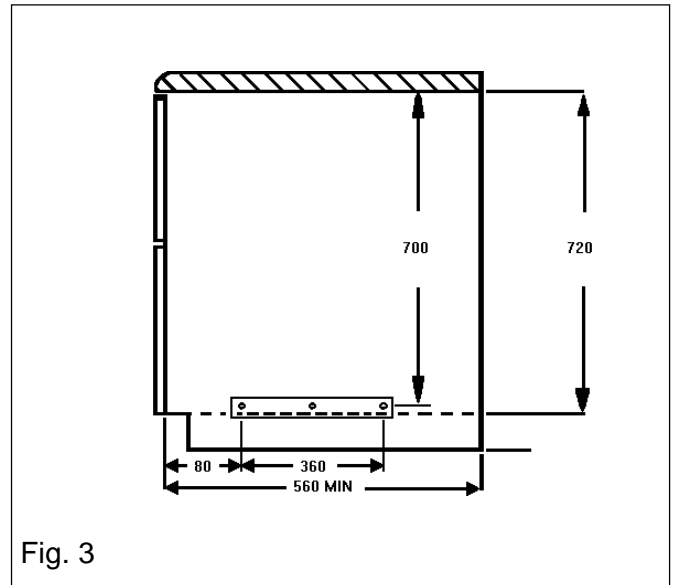

Fig. 3

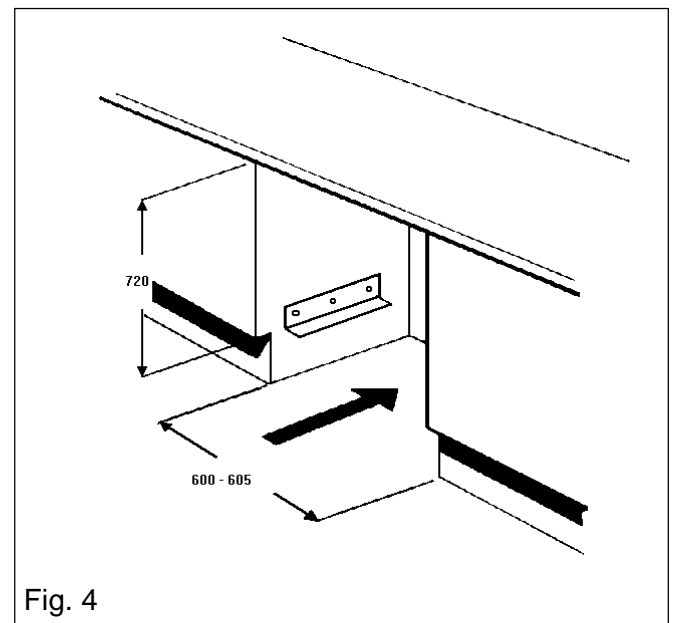

Fig. 4

INSTALLATION INSTRUCTIONS

PREPARING CABINET FOR FITTING OVEN

- Make sure the space between the cabinets is the correct size for the appliance to be fitted (Ref. Fig. 5 & 6).
- The plinth board spanning the space into which the appliance is to be installed should be removed.
- If the size between adjacent cabinets is 605-610*mm, then the cabinets should be modified so that the recommended dimension of at least 600-605mm is maintained.
- The adjacent cabinets must be stable and firmly secured to the wall or floor. If necessary, make arrangements to ensure the work surface below which the oven will rest is level.
- Drill two pilot screw holes into the sides of the adjacent cabinets, in the positions indicated by Fig. 5.
- Fit the appliance mounting brackets using the two holes indicated in Fig. 7 to the adjacent cabinets (Ref. Fig.5 & 6)

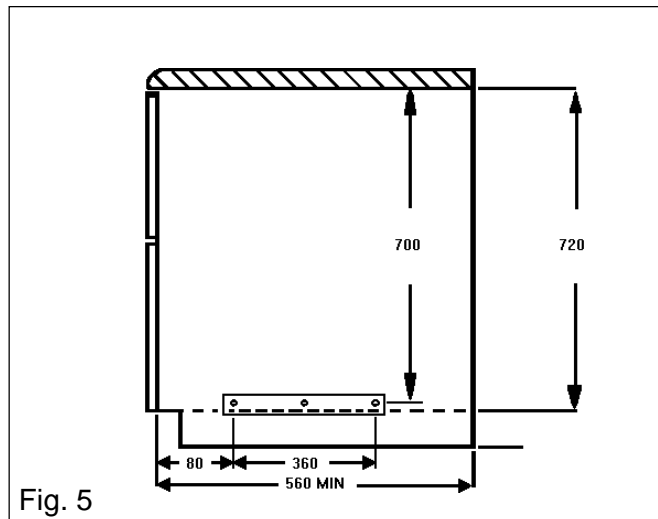

Fig. 5

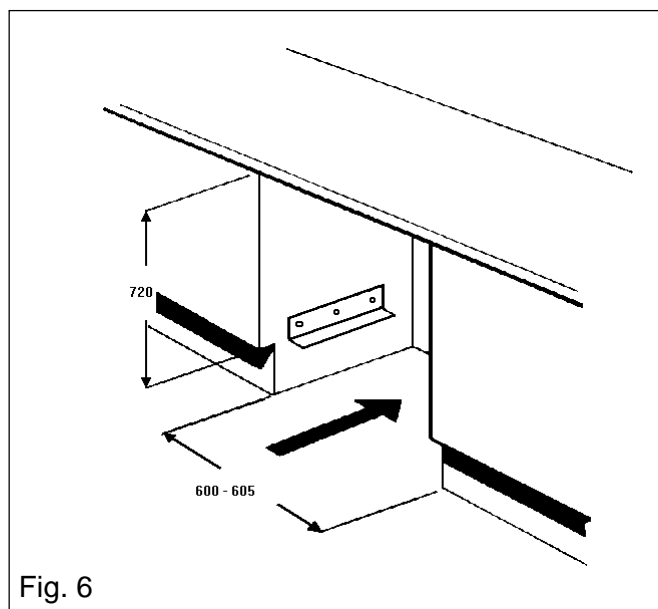

Fig. 6

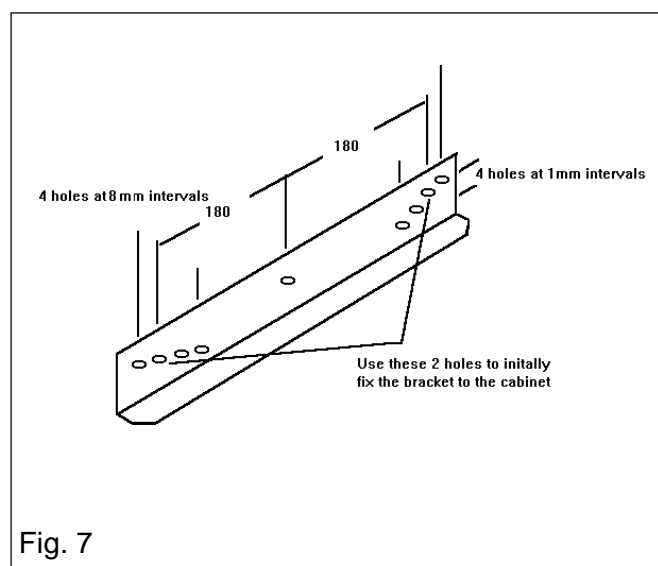

Fig. 7

INSTALLATION INSTRUCTIONS

- Check that the mounting brackets are level. They can be adjusted if necessary by using the extra holes at the ends of the brackets. Once the brackets are level, drill a pilot hole through the central hole in the bracket and fit the remaining screw

HOW TO FINISH UNPACKING

- Place packed cooker next to the space in which it will be installed. See Fig. 8.
- Remove the cooker packing except for bottom tray which should be left in position until the cooker is ready to be fitted into its cabinet.
- Ensure the owner is given these operating instructions.

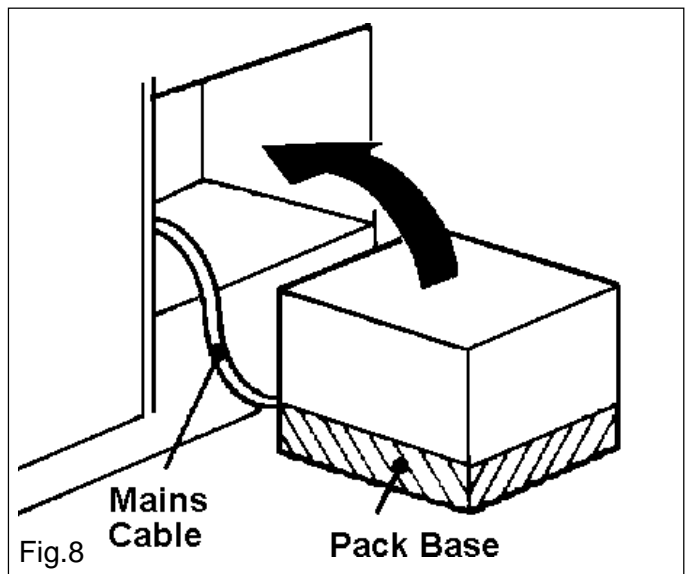

Important: Switch off at mains, miniature circuit breaker and, if appropriate, remove fuse before commencing any electrical work.

INSTALLATION INSTRUCTIONS

TO REMOVE COVER OF MAINS TERMINAL

From the rear of the cooker, remove mains input terminal cover to gain access to terminal block.

- First remove retaining screw with pozidrive screwdriver. See Fig. 9.

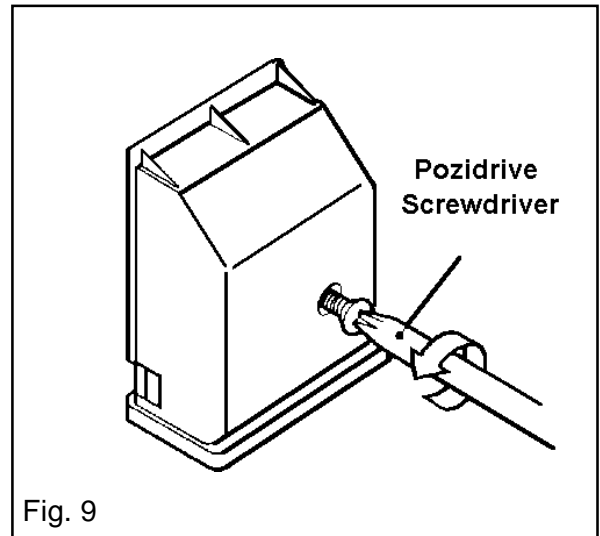

- Prise cover loose using screwdriver in position (1) then lever off with screwdriver in position (2) at either side. See Fig. 10.

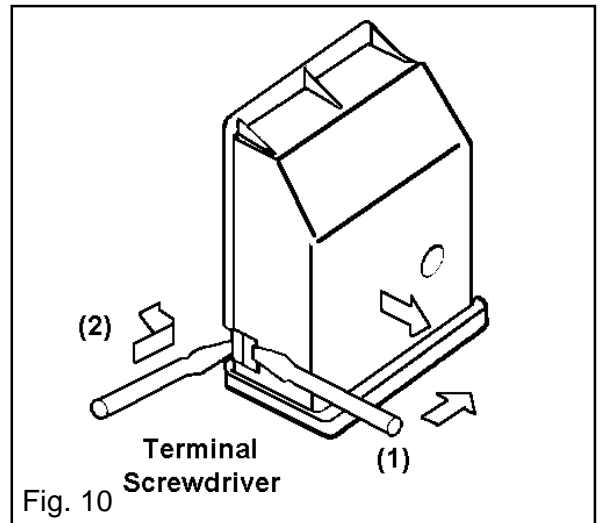

- Lift cover and remove screw from cable clamp. See Fig. 11.

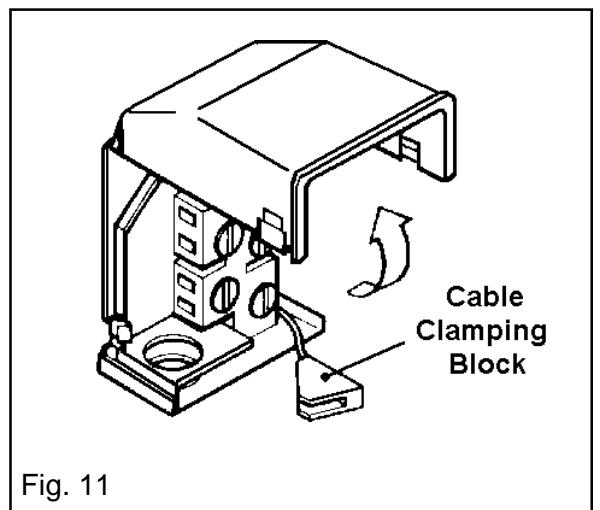

INSTALLATION INSTRUCTIONS

CONNECTING TO THE MAINS TERMINAL



Warning: This cooker must be earthed.

- We recommend you use a new length of 6mm² twin core and earthed cable to ensure your safety.
- Make connection as shown in Fig. 12 by proceeding as follows:-
- Preform wires to the appropriate shape to suit fitting into the mains terminal block.
- Strip inner insulation on wires using wirestrippers.
- Twist the bared wires using pliers.
- Cut bared wires 10mm away from the end of the inner insulation. Where uninsulated Earth wires are used ensure they are suitably sheathed to leave 10mm bare wire to fit into the terminal.
- Clamp bare wires into the relevant terminal and check they are held by tugging each one in turn.
- Clamp the mains cable securely ensuring 5mm of the outer insulation is inside the terminal block and that the wires are not taught but not so slack as to cause any fouling. See Fig. 12.
- Connect the remaining end of the mains cable to the cooker point / junction box
- Place fuse / miniature circuit breaker in circuit and switch on at mains.

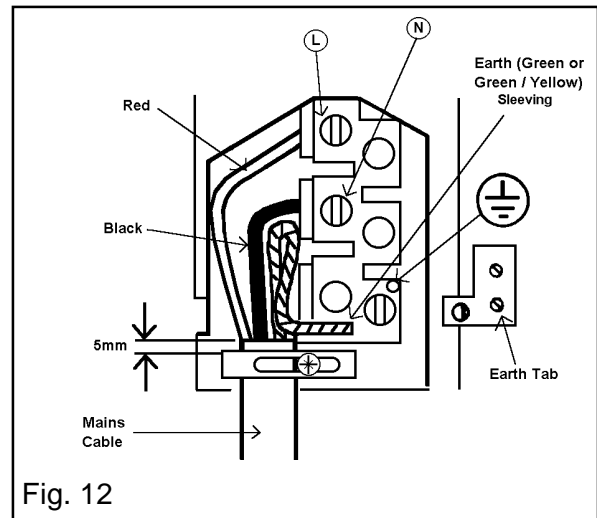

INSTALLATION INSTRUCTIONS

CHECKING ELECTRICAL CONNECTIONS

- Confirm the cooker is correctly connected by switching on and observing the various oven functions indicators.
- The electronic timer will flash on and off.

CONNECTING TO A HOB OR COOKER POINT

- Either follow in general terms the instructions for connecting to the terminal block or refer to the hob suppliers installation instructions.

Feed the cable through the cabinet and arrange to route the cable away from the cooker.

NOTE: HOUSE CIRCUIT

Earth leakage / continuity tests must be carried out before the cooker is connected to the mains supply and re-checked after fitting.

INSTALLATION INSTRUCTIONS

FITTING INTO THE SPACE BETWEEN CABINETS



IMPORTANT: Ensure that the oven is switched off at the wall before any further work is carried out.

- Ensure the cooker is in front of the cabinet. See Fig. 13.
- Take out all oven furniture before installation to reduce the weight you need to lift.
- To place the cooker into the space between cabinetry follow the procedure below:
- N.B. Two people will be required to carry out the lifting procedure. Each person should squat either side of the cooker. Tilt the cooker so that your hands can support the underside of the cooker. Raise the appliance to the correct height. Rest the rear underside of the cooker on the mounting brackets while your hands support the front. The cooker can be pushed fully into the space. Take care to avoid fouling the mains lead. Ensure the cooker is central and level.
- When the cooker is fully housed, screw the stability screws (supplied with the cooker) into the underside of the worksurface in the positions indicated (see Fig. 14), taking care not to distort the trim. It is advisable to turn each screw alternately to avoid damaging the trim.
- Place the top trim flush with the edge of the worksurface, with the cork spacers upover (see Fig.15) and screw into position using the screws supplied with the cooker.
- Replace the plinth board.
- Switch on the cooker and refer the user to the operating instructions.

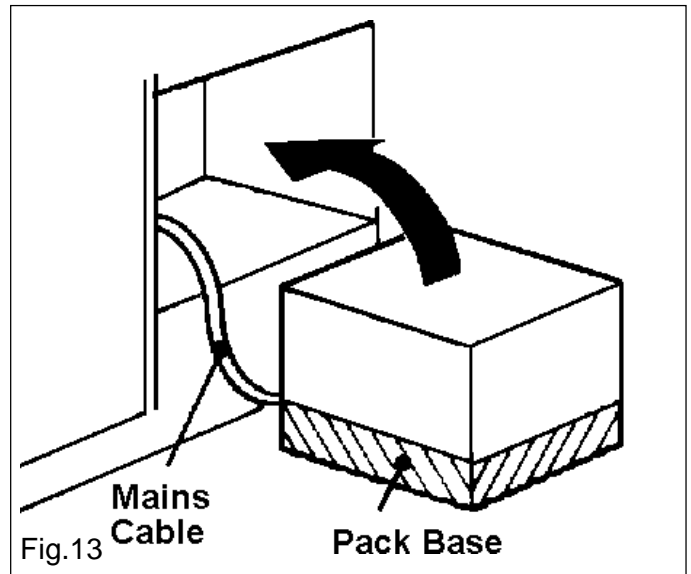

Fig.13

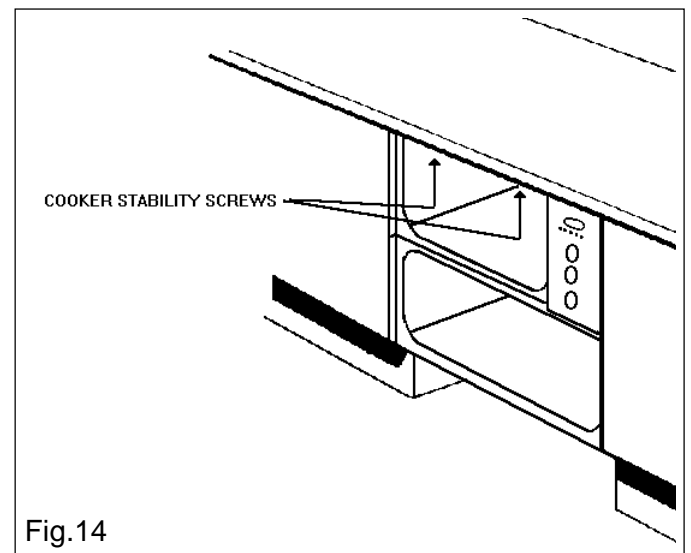

Fig.14

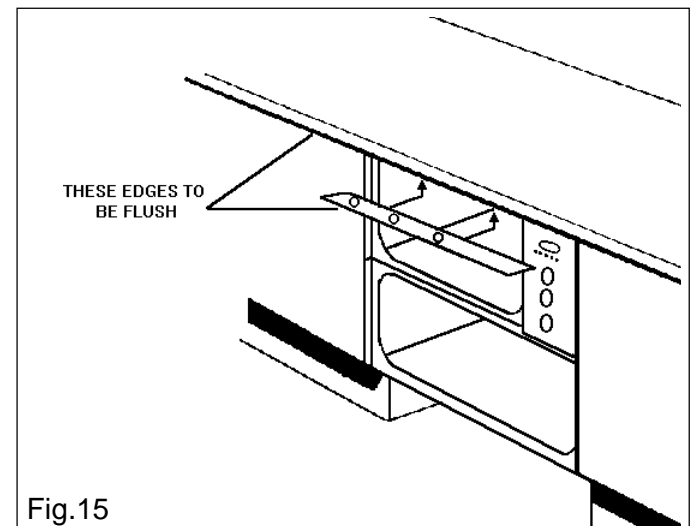

Fig.15

ELECTROLUX, 55 - 77 HIGH STREET, SLOUGH, BERKSHIRE. SL1 1DZ
TELEPHONE 08705 950950

PART NUMBER : 311359702