

# **Creda**

## **D010E**

# **Installation & User Instructions**

**You must read these instructions prior to using the appliance and retain them for future reference.**



For more information on our exciting product range ring  
**Creda Answer Centre 08701 54 64 74**

OR



Visit us on the **NET** at  
**<http://www.creda.co.uk>**

Our site invites you to make use of our **interactive cookbook** and **product selector**. Feel free to **browse our product range** to see what's **bubbling away** at the moment or to **ask for help** on our products and services

# Creda

General Domestic Appliances Ltd. Morley Way Peterborough PE2 9JB  
**Creda Answer Centre** 08701 54 64 74  
**Web** <http://www.creda.co.uk>

It may be necessary from time to time to change the specification outlined in this booklet without notice. Any change which is made will not affect your statutory rights.

---

# Contents

---

Introduction	4
Safety Information	5
Features	7
Controls	8
Clock / Minute Minder Operation	9
Grill Pan and Handle	11
Grilling	12
Guide To Grilling Successfully	13
Using the Oven for Fan Cooking	14
Using the Oven for Other Functions	16
Temperature Conversion Chart	17
Oven Temperature Charts	18
Cooking Results Not Satisfactory	20
Care and Cleaning	21
Installation	25
Something Wrong?	30
Key Contacts	Back Cover

---

---

# Introduction

---

Your new appliance is guaranteed\* and will give lasting service. This guarantee is only applicable if the appliance has been installed in accordance with the installation instructions detailed in this booklet.

To help make best use of your cooking equipment, please read this booklet carefully.

The cooker is designed specifically for domestic use and responsibility will not be accepted for use in any other installation.

**When the cooker is first used an odour may be emitted,  
this will cease after a period of use**

When first using the cooker ensure that the room is well ventilated (e.g. open a window or use an extractor fan) and that persons who may be sensitive to the odour avoid any fumes. It is suggested that any pets be removed from the room until the smell has ceased. This odour is due to temporary finish on oven liners and elements and also any moisture absorbed by the insulation.

**\* The guarantee is subject to the provisions that the appliance:**

- (a) Has been used solely in accordance with the Users Instruction Book.**
- (b) Has been properly connected to a suitable supply voltage as stated on the rating plate attached to this equipment.**
- (c) Has not been subjected to misuse or accident or been modified or repaired by any person other than the authorised employee or agent.**
- (d) Has been correctly installed.**

## Disposal of your product

To minimise the risk of injury to children please dispose of your product carefully and safely. Remove all doors and lids. Remove the mains cable (where fitted) by cutting off flush with the appliance and always ensure that no plug is left in a condition where it could be connected to the electricity supply.

To help the environment, Local Authority instructions should be followed for the disposal of you product.

This appliance conforms to the following EEC Directives:

Electromagnetic Compatibility  
89/336/EEC  
92/31/EEC  
93/68/EEC

Low Voltage Equipment  
73/23/EEC  
93/68/EEC



---

# Safety Information

---

**When used properly your appliance is completely safe but as with any electrical product there are certain precautions that must be observed.  
PLEASE READ THE PRECAUTIONS BELOW BEFORE USING YOUR APPLIANCE.**

## Always

- Always make sure you remove all packaging and literature from inside the oven and grill compartments before switching on for the first time.
- Always make sure you understand the controls prior to using the appliance.
- Always keep children away from the appliance when in use as the surfaces will get extremely hot during and after cooking.
- Always make sure all controls are turned off when you have finished cooking and when not in use.
- Always stand back when opening an oven door to allow any build up of steam or heat to disperse.
- Always use dry, good quality oven gloves when removing items from the oven/grill.
- Always take care to avoid heat/steam burns when operating the controls.
- Always turn off the electricity supply at the wall switch before cleaning and allow the appliance to cool.
- Always make sure the shelves are in the correct position before switching on the oven.
- Always keep the oven and grill doors closed when the appliance is not in use.
- Always keep the appliance clean as a build up of grease or fat from cooking can cause a fire.
- Always follow the basic principles of food handling and hygiene to prevent the possibility of bacterial growth.
- Always keep ventilation slots clear of obstructions.
- Always refer servicing to a qualified appliance service engineer.
- During use the oven becomes hot. Care should be taken to avoid touching heating elements inside the oven,

## SAFETY ADVICE

### **IN THE EVENT OF A CHIP PAN OR ANY OTHER PAN FIRE:**

1. TURN OFF THE COOKER APPLIANCE AT THE WALL SWITCH.
2. COVER THE PAN WITH A FIRE BLANKET OR DAMP CLOTH, this will smother the flames and extinguish the fire.
3. LEAVE THE PAN TO COOL FOR AT LEAST 60 MINUTES BEFORE MOVING IT. Injuries are often caused by picking up a hot pan and rushing outside with it. NEVER USE A FIRE EXTINGUISHER TO PUT OUT A PAN FIRE as the force of the extinguisher is likely to tip the pan over. Never use water to extinguish oil or fat fires.

---

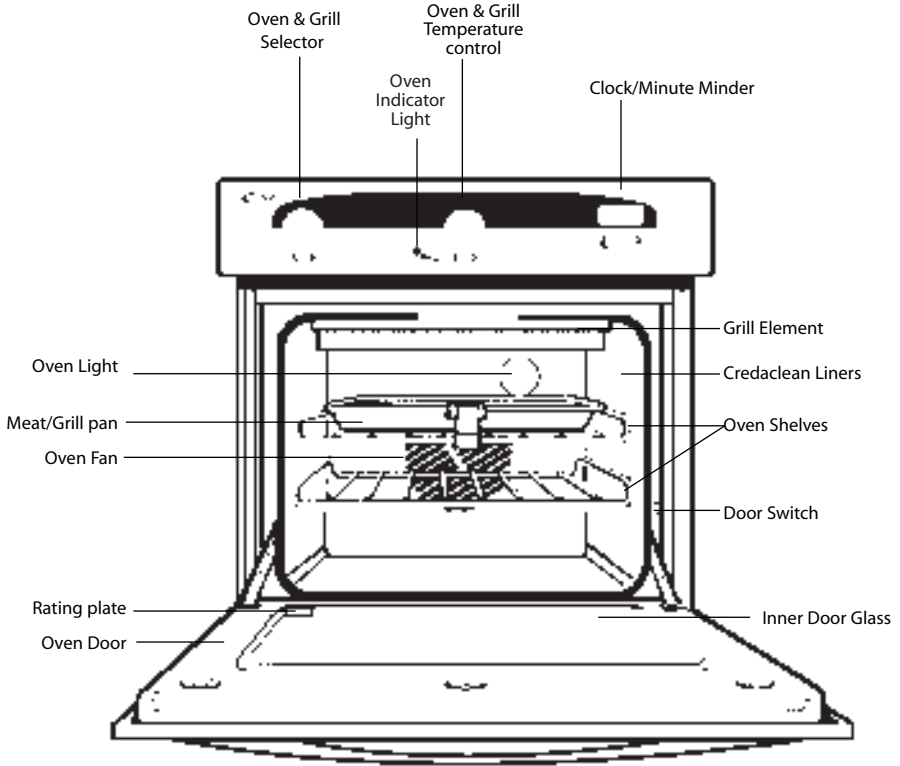
# Safety Information

---

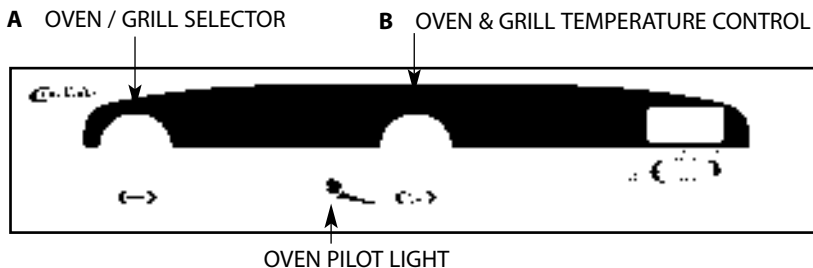
## Never

- Never leave children unsupervised where a cooking appliance is installed as all cooking surfaces will be hot during and after use.
- Never allow anyone to sit or stand on any part of the appliance.
- Never store items above the appliance that children may attempt to reach.
- Never remove the oven shelves whilst the oven is hot.
- Never heat up unopened food containers as pressure can build up causing the container to burst.
- Never store chemicals, food stuffs or pressurised containers in or on the appliance, or in cabinets immediately above or next to the appliance.
- Never operate the grill with the door closed as this will cause the appliance to overheat.
- Never use the appliance as a room heater.
- Never use the grill to warm plates.
- Never dry any items on the oven doors.
- Never install the appliance next to curtains or other soft furnishings.
- Never allow children to play with the appliance controls.
- Never use 'steam cleaners'.

# Features



# Control Panel



## CONTROL MARKINGS

Control Knob	Description	Function
<b>A</b>	<b>Oven &amp; Grill Selector</b>	<div style="border: 1px solid black; padding: 2px; display: inline-block; margin-bottom: 5px;">Fan Oven</div> Turning Selector clockwise allows use of fan oven. Turning Selector anti-clockwise allows use of grill. <div style="border: 1px solid black; padding: 2px; display: inline-block; margin-top: 5px;">Grill</div>
<b>B</b>	<b>Oven/Grill Temperature Control</b>	<div style="border: 1px solid black; padding: 2px; display: inline-block; margin-bottom: 5px;">80 - 230</div> Oven Temperature scale (in degrees centigrade) When cooking turn clockwise to the required setting.  <div style="border: 1px solid black; padding: 2px; display: inline-block; margin-top: 5px;">1-6</div> 1 = Low Setting when grilling 6 = High Setting when grilling

**Cooling Fan** A gentle flow of air will be blown below the control panel when the selector switch is used.

**Oven Interior Lights** The oven light is operated when the Fan Oven is selected.

**Slow Cooking** The oven has a "Slow Cook Setting" this can be used for slow cooking, keeping food warm and warming plates for a short period.

**Element and Fan cut-off** When Oven / Grill selector (A) is set to fan oven there is a safety device which disconnects the heating element and oven fan when the door is opened. The heating element and oven fan will not operate until the oven door is closed.

**Note: It is advisable to check that all oven controls have been switched off after you have finished using the appliance.**



---

# Clock/Minute Minder Operation

---

## CLOCKFACE



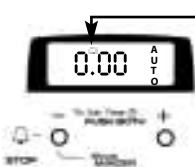
The timer incorporates a 24 hour clock.



**Ensure the correct time of day is always set before using your cooker.**

**PLEASE NOTE THAT THE DISPLAY WILL DIM BETWEEN 22.00 HOURS AND 06.00 HOURS TO PREVENT GLARE.**

**However, should you operate the timer during these hours the display will return to normal brightness for a few seconds and then dim again.**

## SYMBOLS



 will light up when you select a Minute Minder Period and will remain lit for the period set. At the end of the Minute Minder Period, the timer will emit an audible tone for 2 minutes, the  symbol will start to flash and will continue to flash until the Minute Minder function is cancelled.

## SETTING THE TIME OF DAY



**Step 1** Make sure all oven controls are turned off.

**Step 2** Check the electricity supply to the cooker is turned on.

**Step 3** When switched on, the display will show 0.00 / AUTO.



**THIS NEXT STEP SHOULD BE COMPLETED WITHIN 4 SECONDS...**

**Step 4** Press and release both the '+' and '-' buttons together. Press the '+' button and the display will show 12.00 Then press the '+' or '-' button to set the correct time of day.

**THE TIME OF DAY IS NOW SET.**

*To change the time of day repeat Step 4 above.*

## NB.

If at any time the display shows a 'KEY' symbol, the operation of the timer is unaffected.

The 'KEY' symbol can be deleted by pressing both buttons for a period of approximately 8 seconds, followed by a single press of the '+' button.

---

# Clock/Minute Minder Operation

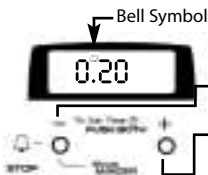
---


## TIMER FUNCTION BUTTONS

### Minute Minder


Here you can set a time period of up to 23 hours 59 minutes, that will count down. When it reaches zero, the timer will emit an audible tone. **For Example:** If you set 20 minutes, the audible tone will occur 20 minutes later.

### SETTING THE MINUTE MINDER




- Step 1** Ensure the time of day is set correctly.
- Step 2** Press and release the '-' button, a  symbol will light up.
- Step 3** Within 4 seconds press the '+' button to set the correct period of time required.


Release the '+' button.

The time is set and will continue to count down and the  symbol will be lit.

At the end of the set time a bleeping sound will be heard and the  symbol will flash for approximately 2 minutes.



After approximately 2 minutes the bleeping sound will stop. To cancel the  symbol flashing, press the '-' button once.

- Step 4** To cancel the bleeping sound and the  symbol, within the 2 minutes, press the '-' button.

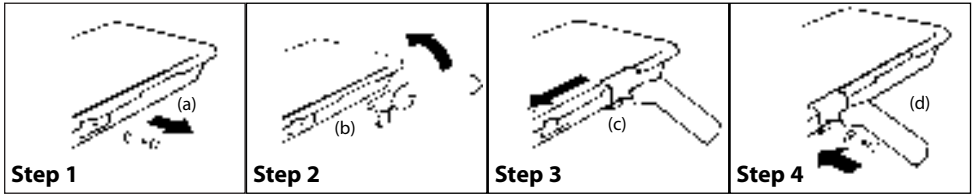
To cancel the minute minder period press the '-' button. Press the '-' button again until the display shows 0.00 After 5 seconds the display will return to the time of day.

If at any time the display shows flashing zero's / AUTO, it is likely that the electricity supply has been interrupted. Reset the timer to the correct time of day.

**NOTE: WHEN THE MINUTE MINDER HAS BEEN SET, THE DISPLAY WILL REVERT TO SHOW THE TIME OF DAY. ANY REMAINING TIMED PERIOD CAN BE VIEWED BY PRESSING THE '-' BUTTON.**

# Grill Pan and Handle

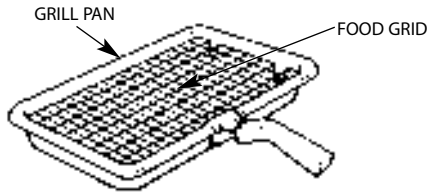
The grill pan handle is detachable from the pan, to facilitate cleaning and storage.  
The grill pan handle can be fixed as follows:



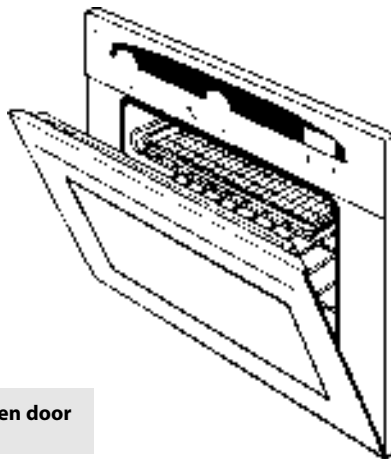
- Step 1** Remove screw & washers from the grill pan bracket (a).
- Step 2** Tilt the handle over the recess (b).
- Step 3** Slide it towards the centre of the pan (c).
- Step 4** Locate the handle over the bracket (d).  
For a fixed handle, replace screw & washers and ensure they are fully tightened up. If a detachable handle is required, do not replace screw & washers.

**Note: If a fixed handle is required, the grill pan is unable to be stored in the oven with the door closed and cannot be used as a meat pan.**

## GRILL PAN AND FOOD GRID



## DOOR POSITION FOR GRILLING

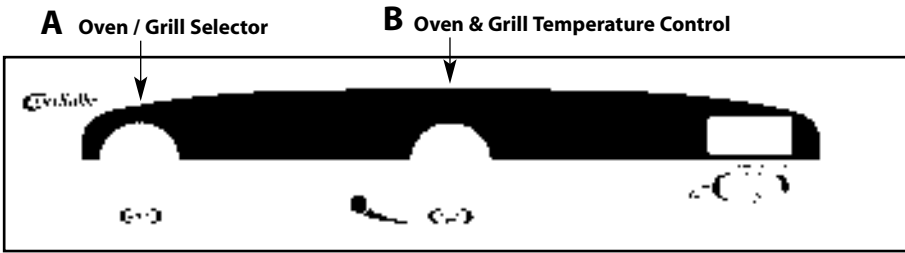


**Note: DO NOT grill with the grill/oven door closed.**

---

# Grilling Procedure

---



**Note:** DO NOT allow young children near to the appliance when the grill is in use as the surfaces get extremely hot.

- Step 1** Ensure the oven shelf is in the correct position (see Guide to Grilling Successfully).  
Ensure door is in the grilling position (see grilling page)
- Step 2** Turn knob (A) clockwise to GRILL function
- Step 3** Turn knob (B) anti-clockwise to select the Grill Setting (1–6).

**NOTE:** When using the grill, a gentle flow of air will be detected coming from beneath the control panel.

- Step 4** After use, turn both controls A & B to their off (0) position.

- Notes:
- Preheat the grill at setting 6 on the grill control for approximately 5 minutes.
  - The grill pan must be placed on the correct shelf and positioned centrally under the grill element.
  - Leave the control at 6 for toast, and for fast cooking of foods.
  - For thicker foods requiring longer cooking, turn the switch to a lower setting after the initial sealing on both sides at 6. The thicker the food, the lower the control should be set.
  - If excessive smoke is emitted reduce the setting.
  - **Do not** line the grill pan with aluminium foil as this increases the amount of fat spitting.
  - Ensure that the Grill Pan is cleaned after use. Excessive fat build-up in the bottom of the pan could cause a fire hazard.
  - **After use, always return both controls to their OFF (O) position.**

---

## Guide to Grilling Successfully

---

<b>Food</b>	<b>Preheat for 5 mins.</b>	<b>Shelf Position from Base of Oven</b>	<b>Approx. Cooking Time</b>
Toasting of Bread Products	6	6 or 5	Time depending on type of food.
Small cuts of meat, sausages, bacon, etc.	3	6 or 5	10-20 mins.
Chops, gammon steaks etc.	4	6 or 5	20-30 mins. depending on thickness.
Fish whole Fillets, e.g. Fish Fingers	4	5	10-20 mins.
Pre-cooked potato products	5	5	10-20 mins.
Pizzas	3 or 4	5	Preheat pan first, time depending on size and type.
Browning of food	6	6	5-10 mins.

---

# Using the Oven for Fan Cooking

---

Fan  
Oven

Since a circulaire fan oven heats up more quickly, and generally cooks food at a lower temperature than a conventional oven, pre-heating is often unnecessary. For guides on “pre-heating”, “cooking temperatures” and “cooking times”, see “Oven Temperature Charts” later in book.

**NOTE: Charts are a guide only, to suit personal taste and requirements, it may be necessary to increase or decrease temperatures by 10°C. It may also be necessary to increase or decrease cooking times.**

## OVEN SHELF POSITIONING FOR FAN OVEN

Most foods will cook satisfactorily on any shelf position, due to even distribution of heat in the oven, but the shelves must be evenly spaced.

**Food or utensils should never be placed directly on the floor of the oven for cooking as air circulation is restricted.**

**DO NOT allow young children near to the appliance when the oven is in use as the surfaces get extremely hot.**

## OVEN UTENSILS

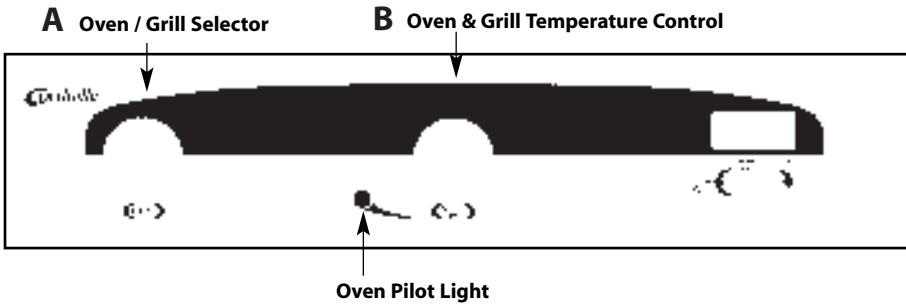
Do not use:            Meat pans larger than 375mm x 300mm (15" x 12")  
                              Baking Trays larger than 325mm x 250mm (13" x10")

An additional oven shelf can be purchased, from our Parts Department or your nearest retailer, if a third one is required for batch baking. Never use more than three shelves in the oven at one time as air circulation will be restricted.

## TEMPERATURE & TIME

If three shelves are in use to cook large quantities of food, it may be necessary to increase the cooking times given in the temperature charts by a few minutes, to allow for the loss of heat due to extra time taken to load the oven, and the larger mass of food. Baking trays should have an even gap around the oven.

## FAN OVEN OPERATION



- Step 1** Ensure that the oven shelf is in the correct position. Place food centrally on the shelf ensuring the oven door is fully closed. Turn Oven / Grill selector, knob A anti-clockwise to FAN OVEN function.
- Step 2** Turn knob (B) anti-clockwise and select the required cooking temperature (80°C to 230°C). The pilot light will immediately come on, and remain on until the oven reaches the required temperature. The light will then automatically go off and on during cooking as the oven thermostat maintains the correct temperature.
- Step 3** After use turn both controls to their Off (O) position.
- NOTE:** At the end of a cooking period there may be a momentary puff of steam when the door is opened. This will disperse in a few seconds and is a perfectly normal characteristic of an oven with a good door seal.

---

# Using the Oven for Other Functions

---

90

## “SLOW” SETTING

This is used for slow cooking, keeping food warm and warming plates for short periods. Extra care should be taken when warming bone china, as it may be damaged in a hot oven.

**DO NOT place food or plates directly on the oven floor as this could damage both the oven lining and the plates which are being warmed.**

### ADVANTAGES OF SLOW COOKING ARE:

The oven stays cleaner because there is less splashing.  
Timing of food is not as critical, so there is less fear of overcooking.  
Inexpensive joints of meat are tenderised.  
Fully loading the oven can be economical.  
Cooking times can be extended in some cases by up to 2 hours.  
The kitchen stays cooler.

### OPERATION:

1. Place the prepared food in the main oven and ensure the door is fully closed.
2. Turn knob A to Fan Oven function.  
Turn knob B to **90** (slow cooking temperature).

### STORAGE & RE-HEATING OF FOOD:

1. If food is to be frozen or not used immediately, place it in a clean container and cool as soon as possible.
2. Always thaw frozen food completely in the refrigerator before re-heating.
3. Always reheat food thoroughly and ensure it is piping hot before serving.
4. Only re-heat food **once**.

### POINTS TO CONSIDER WHEN PREPARING FOOD FOR SLOW COOKING

1. Make sure that all the dishes to be used will fit into the oven ensuring enough room for air to circulate.
2. All dishes cooked on the slow setting will require a minimum of 6 hours, however, if they are cooked for 1-2 hours longer then deterioration in their appearance may be noticed.
3. Never cook joints of meat over 2.7kg (6 lb) or poultry over 2.0kg (4lb 8oz).  
We do not recommend that joints of meat or poultry are stuffed before cooking on the slow setting.
4. To seal in the meat juices, always cook meat or poultry at 170°C for 30 minutes before wrapping in foil and placing on a rack over a tin (to allow good air circulation) before turning the control to the slow setting and cooking immediately.
5. Always ensure that joints of pork and poultry are thoroughly cooked by checking with a meat thermometer before serving.
6. Always thaw frozen foods completely before cooking. We do not recommend placing frozen food in the oven to cook.
7. Always bring soups, liquids and casseroles to the boil before placing in the oven.
8. Ensure that casserole dishes have a good seal (not airtight) and cover to the top with foil to prevent loss of moisture.
9. Ensure that fruit and vegetables are cut into even sized small pieces to cook properly.
10. Always adjust seasoning before serving.
11. If using dried red kidney beans it is important that the beans are soaked and then boiled for a minimum of 10 minutes before using in any dish to destroy any toxins.
12. When cooking fish or egg dishes it may be necessary to check during cooking to avoid overcooking.



---

## Temperature Conversion Chart

---

<b>Gas Mark</b>	<b>°F</b>	<b>Main Conventional Oven</b>	<b>Main Fan Oven</b>
1/2	250	120	100
1	275	140	120
2	300	150	130
3	325	160	140
4	350	180	160
5	375	190	170
6	400	200	180
7	425	220	200
8	450	–	210
9	475	–	220

# Oven Temperature Chart - Meat

Food	Fan Oven Cooking		
	Note: Up to three shelves may be used in this oven. The position of these is not important providing they are evenly spaced.		
Meat	Pre-heat	Temperature °C	Time (approx.)
Beef	No	160/180	20-25 mins per 450g (1lb) + 20 mins extra
Lamb	No	160/180	25 mins per 450g (1lb) + 25 mins extra
Pork	No	160/180	25 mins per 450g (1lb) + 25 mins extra
Veal	No	160/170	25-30 mins per 450g (1lb) + 25 mins extra
Chicken/Turkey up to 4kg (8lb)	No	160/180	18-20 mins per 450g (1lb) + 20 mins extra
Turkey up to 5.5kg (12lb)	No	150/160	13-15 mins per 450g (1lb) e.g. 5kg (11lb) = 143-165 mins
Turkey over 5.5kg (12lb)	No	150	12 mins per 450g (1lb) e.g. 10kg (22lb) = 264 mins
Casserole / Stews	No	140/150	1½ - 2 hours

## IF USING ALUMINIUM FOIL

1. Never allow foil to touch sides of oven.
2. Never cover interior with foil.
3. Never cover shelves with foil.

The most accurate method of testing the readiness of joints of meat or whole poultry is to insert a meat thermometer into the thickest part of a joint of meat, or the thickest part of poultry thighs, during the cooking period. The meat thermometer will indicate when the required internal temperature has been reached.

Beef			Pork	Lamb	Poultry	Veal
Rare 60°C	Medium 70°C	Well Done 75°C	90°C	80°C	90°C	75°C

# Oven Temperature Charts - Baking

Baking	Fan Oven Cooking		
	Note: Up to three shelves may be used in this oven. The position of these is not important providing they are evenly spaced.		
Food	Pre-heat	Temperature °C	Time
Scones	Yes	210/220	9-12 mins
Small Cakes	No	170/180	15-25 mins
Victoria Sandwich	No	160/170	20-25 mins
Sponge Sandwich (Fatless)	Yes	170/190	15-20 mins
Swiss Roll	Yes	180/200	12-15 mins
Semi-rich Fruit Cake	No	140/150	1¼-1½ hours
Rich Fruit Cakes	No	130/140	Time depending on use
Shortcrust Pastry	No	190/200	Time depending on use
Puff Pastry	No	190/200	Time depending on use
Yorkshire Pudding	Yes	180/190	40-45 mins
Individual Yorkshire Pudding	Yes	190/200	20-45 mins
Milk Pudding	No	130/140	1½-2 hours
Baked Custard	No	140/150	35-45 mins
Bread	Yes	200/210	20-30 mins
Meringues	No	70/90	3-4 hours

**Note: If soft tub margarine is being used for cake making, we would recommend using the all in one method and to reduce the temperature by 10°C. Temperatures recommended in this chart refer to cakes made with block margarine or butter only.**

---

# Cooking Results Not Satisfactory

---

## GRILL

**Uneven cooking front to back**      Ensure that the grill pan is positioned centrally below the grill element.

**Fat splattering**      Ensure that the grill pan is not lined with foil.  
Ensure that the grill setting is not too high.

## BAKING GENERAL

**Uneven rising of cakes**      Ensure that the oven shelves are level.

**Sinking of cakes**      The following may cause cakes to sink:

1. Pre-heating of fan ovens – not always necessary.
2. Cooking at too high a temperature – reduce standard temperatures by 25°C for fan ovens.
3. Using normal creaming method with a soft margarine. If using soft margarine, use an all in one method instead of the traditional creaming of the margarine and sugar. Remember when using a food mixer or processor not to over-cream soft margarine.

**Over/undercooking**      Refer to the cooking times and temperatures given in the Oven Temperature Charts provided, however, it may be necessary to increase or decrease temperatures by 10°C to suit personal taste.

Do not use utensils greater than 56mm (2¼") in height for roasting.

# Care and Cleaning

**Warning: Before cleaning, please ensure that the electricity supply to the appliance is switched off and the appliance is fully cold.**

## 1. "CREDACLEAN" OVEN LINERS

### (a) How "Credaclean" works.

The surfaces of the "Credaclean" oven liners are treated with a special vitreous enamel which absorbs cooking soils. At temperatures of 220°C (425°F) or above, the special surface enables these soils to be slowly destroyed.

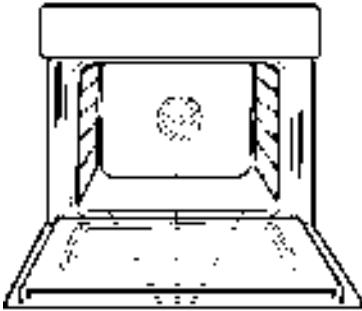
The higher the temperature the more effective it is.

### (b) Cleaning.

In most cases normal cooking operations at 220°C (425°F) will permit this cleaning operation to proceed during cooking. However if higher cooking temperatures are not used regularly, it may be necessary, in order to prevent heavy soiling, to run the ovens without shelves or meat pan, at a maximum setting for a couple of hours.

It should not normally be necessary to clean the "Credaclean" panels with water. If the user feels it is desirable to do so, wipe them over with a clean, soapy cloth, followed by a wipe with a clean damp cloth.

**DO NOT use biological washing powder, harsh abrasives or chemical oven cleaners of any kind as this could damage the "Credaclean" oven liners.**



MAIN OVEN SIDE LINERS  
AND REAR PANEL

---

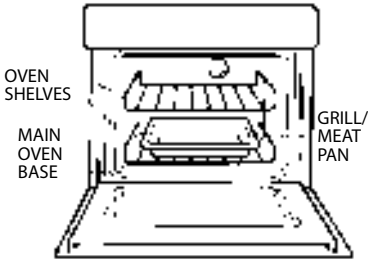
# Care and Cleaning

---

## 2. CLEANING THE OVEN

### (a) Base of Main Oven.

Wipe out the oven with a damp soapy cloth. For more stubborn stains on the base of the oven use a well soaped fine steel wool soap pad.



### (b) Grill/Meat Pan & Oven Shelves.

To prevent stains from being burnt on to the grill pan, food support and rod shelf, always wash immediately after use in hot soapy water.

Use a well soaped fine steel wool soap pad to remove stubborn stains from the rod shelves, grill/meat pan and the base of the oven.

**DO NOT use aerosol cleaners on this oven as they could adversely affect the fan motor unit, and cannot be wiped off the fan blade.**

# Care and Cleaning

## 3. CONTROL PANEL / TRIMS / INNER DOOR PANEL & GLASS

### (a) Control Panel

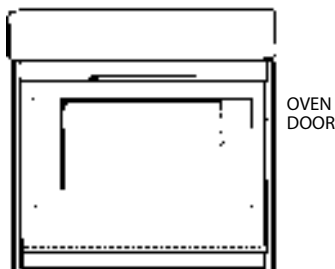
Regularly wipe with a clean, damp cloth and polish with a clean, dry cloth.

### (b) Trims

It is advisable to clean the trims regularly to prevent any build up of soiling which may detract from the appearance of the cooker. The recommended method of cleaning is to wipe over the trims with a clean, soft cloth wrung out in hot water, or mild non abrasive cleaner. (If in doubt try the cleaner on a small area of trim which is not notice able in normal use), then after wiping with a cloth wrung out in clear water, dry with a clean, soft cloth.

### (c) Inner Door Panels & Glass

Open the door fully. The glass panel may now be washed. Stubborn stains can be removed by using a well soaped, fine steel wool soap pad.



TRIMS

**DO NOT use scouring pads, or abrasive powder, which will scratch the glass.**

## 4. REPLACEMENT OF THE OVEN LAMP



OVEN LAMP

**Warning: Before removing lamp lens, please ensure that the electricity supply to the appliance is switched off and the appliance is fully cold.**

Open the oven door and remove the oven shelves. Using a thick cloth, grip the lamp lens, unscrew anti-clockwise and remove the lens. Carefully unscrew the bulb anti-clockwise. Fit replacement bulb (15W 300°C SES). Fit replacement bulb and refit lens.

## 5. HOW TO CLEAN THE LAMP LENS



OVEN LAMP

**Warning: Before cleaning lamp lens, please ensure that the electricity supply to the appliance is switched off and the appliance is fully cold.**

Open the oven door and remove the oven shelves. Using a thick cloth, grip the lamp lens, unscrew anti-clockwise and remove. Clean with a non-abrasive cleansing cream and refit lamp lens.

**DO NOT use scouring pads, or abrasive powder, which will scratch the glass lens**

---

# Care and Cleaning

---

Take particular care not to damage the inner surface of the door inner glass that is coated with a heat reflective layer. Do not use scouring pads, or abrasive powder, which will scratch the glass. Ensure that the glass panel is not subjected to any sharp mechanical blows.

Stubborn stains can be removed by using a fine steel wool pad. For slight soiling the inner glass panel may be cleaned, while still warm, without removing it from the door. After cleaning, rinse and dry with a soft cloth.

## CLEANING THE DOORS

### SIDE OPENING DOORS

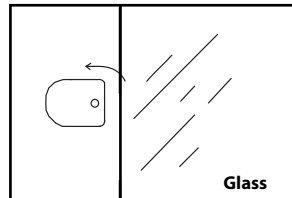
Cleaning the door glass is the same as the drop down doors, except take care to support the weight of the inner glass when removing and refitting.

### DROP DOWN DOORS

Remove the door inner glass as follows.

1. Open the door fully and unscrew the two screws securing the glass panel so that the securing brackets can be turned. There is no need to remove the screws completely.
2. Turn the brackets so that the glass can be removed and cleaned at the sink (Fig. 1.)

Fig. 1.



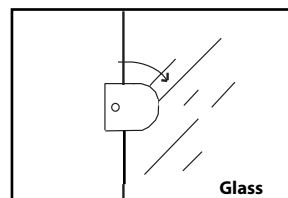
3. The inside of the outer door glass can now be cleaned while still fitted to the cooker.

## NEVER OPERATE THE COOKER WITHOUT THE INNER DOOR GLASS IN POSITION.

Refit the door inner glass as follows.

1. **NOTE:** The inner door glass has a special reflective coating on one side. Replace the door inner glass so that the statement: "IMPORTANT THIS FACE TOWARDS THE OVEN" can be read from the inner side of the door.
2. Turn the two securing brackets back to their original position to retain the glass and tighten the screws. (Fig. 2.)

Fig. 2.





---

# Installation Instructions

---

## IMPORTANT

This equipment is designed specifically for domestic purposes and Creda Limited cannot accept responsibility if used in any other type of installation.

All Creda oven units are suitable for installation under Creda hob units.

This appliance must not be installed over any appliance that generates heat.

For your own safety, we recommend that your appliance is installed by a competent person – such as one who is registered with NICEIC (National Inspection Council for Electrical Installation Contracting). The cooker should be installed in accordance with the latest Edition of the IEE Regulations.

## 1. GENERAL

### **WARNING: THIS APPLIANCE MUST BE EARTHED.**

- (a) The oven unit is designed for mounting at a safe level into an oven housing which must be secured to the backing wall, or alternatively, in the case of the single oven unit, under a worktop with or without a hob unit above.
- (b) In an oven/hob arrangement where it is proposed to install the oven directly below the hob. It is advisable that only slimline hobs are used which have the following maximum depths.

Kitchen Worktop thickness	Maximum hob depth (from worktop surface vertically down)
30mm	55mm
40mm	65mm
40mm +	Worktop thickness + 25mm

It is most important that the hob installation instructions are strictly observed.

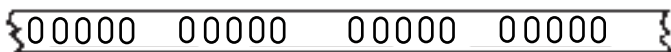
---

# Installation Instructions

---

## 2. OVEN UNIT HOUSING CABINETS

- (a) The oven unit housing cabinet dimensions must comply with Fig. 3 and Fig. 4.
- (b) An air gap of 50mm minimum must be provided at the rear of any top or bottom cupboards or shelves for ventilation.
- (c) Do not obstruct the ventilation slots provided on the oven trim. This is found adjacent to the bottom of the oven door.



- (d) The air gap at the rear allows the warmed air to pass out of the cabinet. If cabinets extend up to the ceiling, the warm air must be exhausted through the front. Fig. 1.
- (e) If an oven unit is installed adjacent to a tall cabinet, steam escaping from the oven when the door is opened could condense on, and perhaps stain the adjacent surface. To prevent permanent staining, the adjacent surface should be made of a material that is heat resisting and easy to clean. Adjacent tall cabinets should not be deeper than the oven housing cabinet.

### IMPORTANT

It is essential that the lower cupboard is constructed in the manner illustrated i.e. having side, back and roof panels so joined as to provide no apertures which could permit access to the oven unit when installed.

## 3. ELECTRICAL INSTALLATION

### Mains Supply

A 20 amp Double Pole control switch with a minimum contact clearance of 3mm must be fitted on or recessed in the wall adjacent to the oven housing cabinetry and should be accessible after installation. If the oven is to be wired into a connector unit this may be positioned behind the oven providing:-

- i. The top of the connector unit is not more than 30cm above the base of the oven recess – see Fig. 4.
- ii. The depth of the connector unit does not reduce the depth of the oven recess to less than 55cm.

We recommend that 4mm<sup>2</sup> twin and earth PVC insulated cable is used to connect the cooker to the control unit. This power supply cable must conform to BS 6004.

Alternatively the mains supply can be taken from a household 13 amp switched fused spur. Having a minimum contact clearance of 3mm which must be fitted adjacent to the oven housing cabinetry and accessible after installation. The oven must be fitted with a 3 core cable having a minimum cross sectional area of 1.5mm<sup>2</sup> and must conform to BS6500.

The oven **must not** be connected using a 3 pin 13 amp plug.

---

# Installation Instructions

---

Any spare cable must be coiled either behind the oven (not more than 30cm above the base of the oven recess) or pushed into the air gap below the oven after installation.

Where a hob is fitted adjacent to or above an oven a 30 amp or 45 amp double pole switch with a minimum contact clearance of 3mm should be used to feed both units via separate suitably rated cables.

Where a hob unit is fitted above the oven unit we recommend that 85°C High Temperature PVC with insulated 3 core flexible cord to table 15 of BS 6141:1991 with a conductor size of 2.5mm<sup>2</sup> must be used to connect the hob to the control unit.

Where a hob unit is fitted adjacent to the oven unit, then 4mm<sup>2</sup> twin and earth cable to BS 6004 is recommended to connect the hob unit to the control unit.

**In all cases adhere to routing details (see fig. 5).**

Your cooker should have been checked to ensure that the voltage corresponds with your supply voltage, this is stated on the rating plate which is located on the oven front frame (lower).

## CONDUIT BOX TO MAINS TERMINAL BLOCK

- (a) The oven unit should be placed on the floor on its carton base in front of the housing cabinet. The rear of the unit should be in line with the conduit box.
- (b) Ensure there is sufficient cable for any future servicing.
- (c) Remove the terminal cover. Prepare the cable, pass it through the cable entry hole in the oven rear panel and fit to terminal block. Secure the cable clamp and replace the terminal cover.

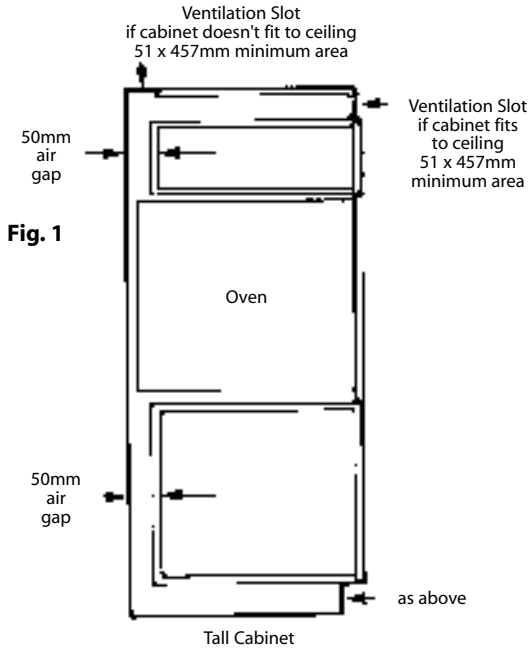
## 4. FINAL INSTALLATION

- (a) Using a spirit level, check that the housing cabinet is level from side to side and from front to back in its installed position.
- (b) Correct any unevenness by placing spacers under the bottom of the cabinet. Make sure that the cabinet rests firmly on the floor without rocking.
- (c) Before the oven is fitted the cabinet must be firmly secured to the backing wall for stability.
- (d) The oven unit should now be lifted (this requires two people) into the cabinet and pushed fully home.
- (e) Finally the oven unit must be secured to the cabinet. Position the oven side trims equally about the cabinet sides. This should give an overlap of approx. 1.5mm per side (see Fig. 2). Secure the oven unit to the cabinet, through the side trims, by means of the four screws provided, two each side trim.
- (f) Remove all packing material from the grill and oven interior.

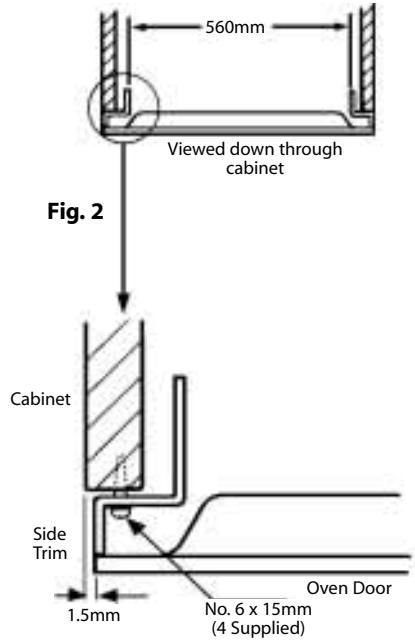
## LIST OF LOOSE ITEMS

4 x No.6 Pozi Head screws

# Installation Instructions

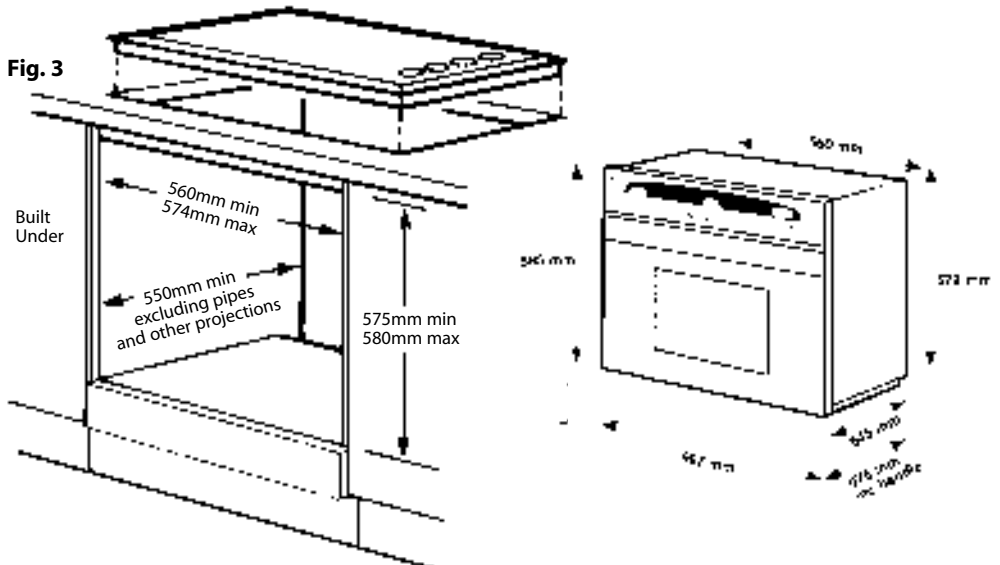


**Fig. 1**



**Fig. 2**

When fitting a hob above an oven always use these installation instructions in conjunction with the hob instructions. Use 2.5mm<sup>2</sup> High Temp Cable. Refer to Electrical Installation.



**Fig. 3**

# Installation Instructions

Fig. 4

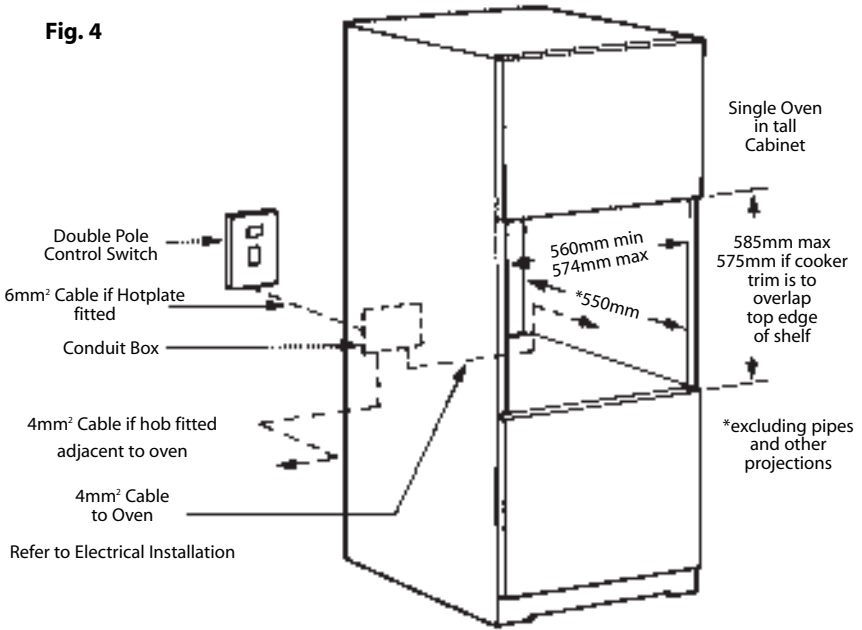
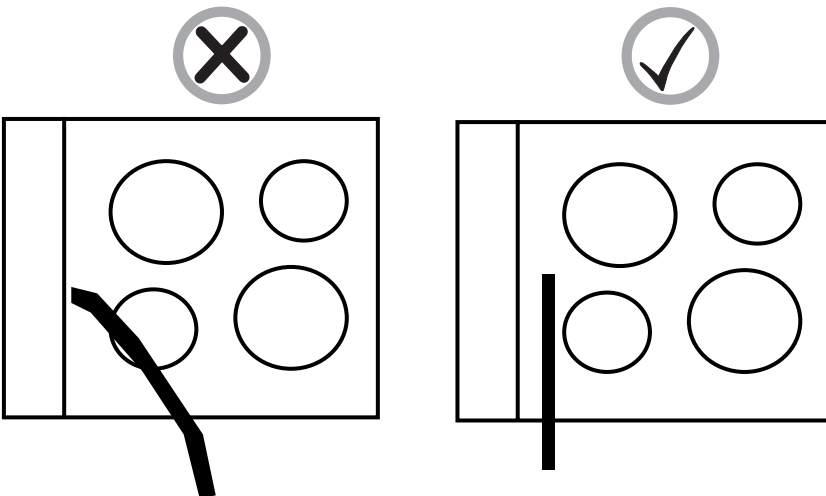


Fig. 5



# Something Wrong?

Before calling a Service Engineer, please check through the following lists.  
THERE MAY BE NOTHING WRONG.

Problem	Check
Nothing works.	(a) Check If you find :- Display is blank. <b>Then it is likely that there is no electricity supply to your oven.</b> Check: (i) That the main cooker wall switch is turned on. (ii) Check other appliances to see if you have a power cut. (iii) Check the main circuit breaker for the property. (iv) With the selector switch (A) turned to 'fan oven' the oven light does not illuminate.
Display shows 0.00	The power supply to your oven has possibly been interrupted, but has now come back on again. Reset the timer to the correct time of day (see 'Clock/Minute Minder' section).
Oven and Grill do not work.	Operating the cooker under the following conditions may cause a safety device to operate. (a) Grilling with the door closed - always grill with the door open to the correct position - see grilling. (b) Grilling for an excessively long period at maximum setting - see grilling guide. (c) Grilling with inadequate ventilation in the cabinet - see installation instructions.
Oven does not work.	Check that the selector switch (A) is set to 'FAN OVEN' and that the temperature control (B) is set to the correct temperature.
Grill does not work.	Check that you have selected :- 'GRILL' function on the Oven/Grill Select knob (A) <b>and</b> a Grill setting on the Temperature Control Knob (B) (see grilling page).
Grill keeps turning on and off.	When the Temperature Control knob (B) is operating at less than "6", the grill will cycle on and off, this is normal and is <u>not</u> a fault.
Draught from beneath control panel.	A gentle flow of air will be blown from beneath the control panel when the appliance is used. If the appliance is still warm, this cooling fan may run on, or restart itself after all of the controls have been turned off. The fan will stop once the appliance has been cooled. This is normal and <b>not</b> a fault.
Timer buzzer/bleeper operates continually	Buzzer/Beeper should stop automatically after several minutes. To cancel press the '-/' button.

If you have been through the above list and there is still a problem, contact your Local Service Office (see Back Cover)



# **Key Contacts**

## **Service**

Creda has the largest appliance manufacturer's service team in Europe, trained specialists directly employed by us to ensure your complete confidence.

### **Repair Service**

**UK: 08709 066 066**

**Republic of Ireland: 1850 302 200**

You will be asked for the following information:-

Name, address and postcode.

Telephone number

Model / Serial number of the appliance

Clear and concise details of the query or fault

Place and Date of purchase

(Please keep the receipt as evidence will be required when the engineer calls).

### **Extended Warranty**

**To join: UK 08709 088 088**

**Republic of Ireland: 1850 502 200**

### **Genuine Parts & Accessories Mail Order Hotline**

**UK: 08709 077 077**

**Republic of Ireland: (01) 842 6836**

For further product information 08701 546474

All Creda Services are offered as an extra benefit and do not affect your statutory rights.

# **Creda**

General Domestic Appliances Limited, Morley Way, Peterborough, PE2 9JB