

# SV430 Compact Oven

Manual for Installation, Use and Maintenance

**CDA**



**CE**



## Important

This appliance must only be used for the purpose for which it is intended, i.e. domestic cooking. Any other use could be dangerous and may lead to premature failure of the appliance.

This appliance is not designed to be used by people (including children) with reduced physical, sensorial or mental capacity, or who lack experience or knowledge about it, unless they have had supervision or instructions on how to use the appliance by someone who is responsible for their safety..

Under no circumstances should any external covers be removed for servicing or maintenance except by suitably qualified personnel.

### User information:

- Ovens become hot during and immediately after use. Take care not to touch any of the internal components of the oven.
- The oven door can become very hot during operation.
- After use, please ensure that the oven is switched off.
- Keep children away from the appliance when in use, and immediately after use.
- Keep the oven door closed whilst grilling.

### Appliance information:

Please enter the details on the appliance rating plate below for reference, to assist CDA Customer Care in the event of a fault with your appliance and to register your appliance for guarantee purposes.

Appliance Model	<input type="text"/>
-----------------	----------------------

Serial Number	<input type="text"/>
---------------	----------------------

### CE Declarations of Conformity:

This oven has been designed, constructed and marketed in compliance with safety requirements of EEC Directive 2006/95/EEC (Low voltage) and requirements of EMC Directive 2004/108/EEC.

This appliance has been manufactured to the strictest standards and complies with all applicable legislation, including Electrical safety (LVD) and Electromagnetic interference compatibility (EMC). Parts intended to come into contact with food conform to EEC/89/109.4

### IMPORTANT INFORMATION FOR CORRECT DISPOSAL OF THE PRODUCT IN ACCORDANCE WITH EC DIRECTIVE 2002/96/EC.

At the end of its working life, the product must not be disposed of as urban waste. It must be taken to a special local authority differentiated waste collection centre or to a dealer providing this service.

Disposing of a household appliance separately avoids possible negative consequences for the environment and health deriving from inappropriate disposal and enables the constituent materials to be recovered to obtain significant savings in energy and resources. As a reminder of the need to dispose of household appliances separately, the product is marked with a crossed-out wheeled dustbin. 

## Important

Read the user instructions carefully before using the oven for the first time.

Clean the oven regularly.

Remove spills as soon as they occur.

Always use oven gloves when removing shelves and trays from the ovens.

Do not allow children near the oven when in use.

Do not lean on the oven door, or place heavy items on the door. Make sure that children do not climb or sit on the door when it is open.

Do not pull the oven by the handle.

Do not allow fat or oils to build up on the oven shelves, grill pan or oven base.

Do not place any cooking utensils or plates directly on the oven base.

Cook on all functions with the oven door closed.

Do not grill food containing fat without using the grill pan grid.

Do not cover the grill pan grid or the oven walls with aluminium foil.

Do not perform maintenance or cleaning of the oven without first switching off the electricity supply. If the oven has recently been used, allow to cool.

Do not use steam cleaners to clean the oven.

Do not place hot enamel parts in water. Leave them to cool first.

Do not allow vinegar, coffee, milk, saltwater, lemon or tomato juice to remain in contact with enamel parts.

Do not use abrasive cleaners or powders that will scratch the surface of the enamel.

Do not attempt to repair the internal workings of your oven.

### First use of the oven

Before using the oven for the first time we recommend that you clean the oven with soapy water, rinse carefully and then heat on the fan oven function for 15 minutes at 220. A slightly unpleasant smell may be produced, caused by grease remaining on the oven elements from the production process.

## Using the touch control

The touch controls should be used with the flat of your finger, rather than the fingertip.

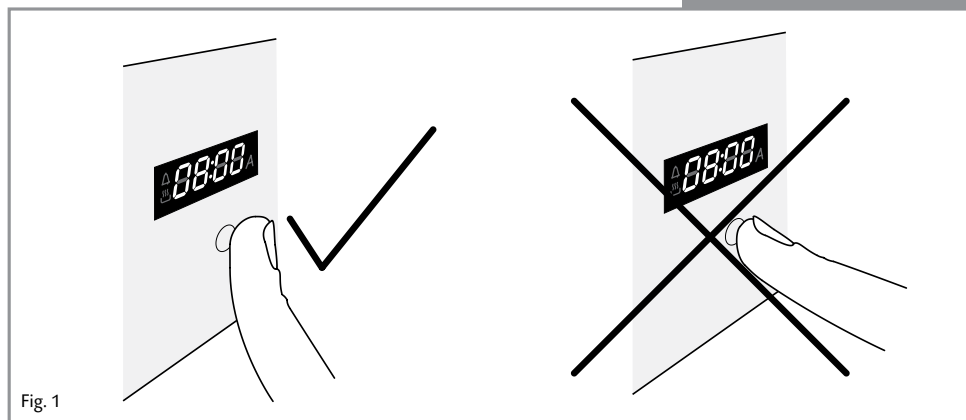

Fig. 1

## Using your oven

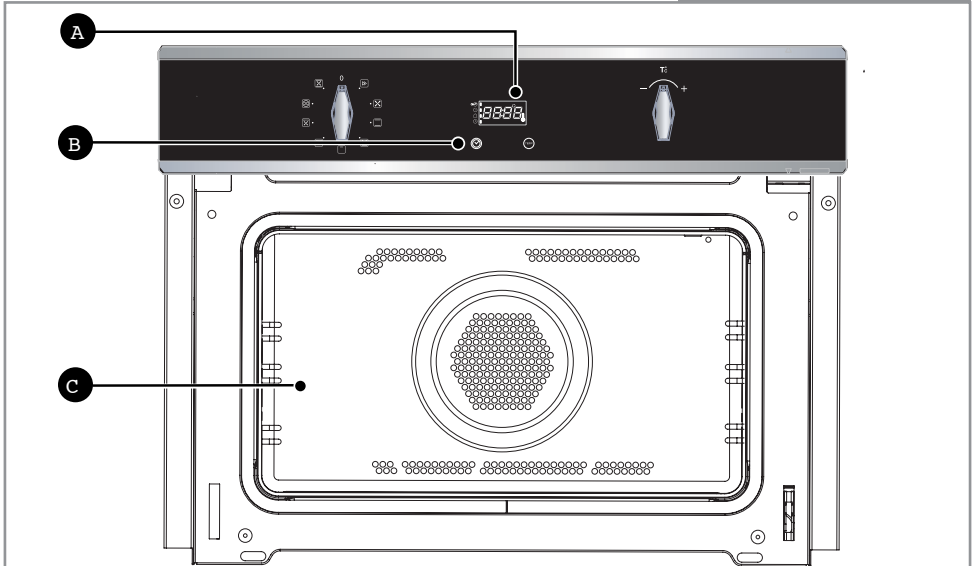

Fig.2

- A Display
- B Control panel
- C Wire shelf supports

## The Control Panel and Display

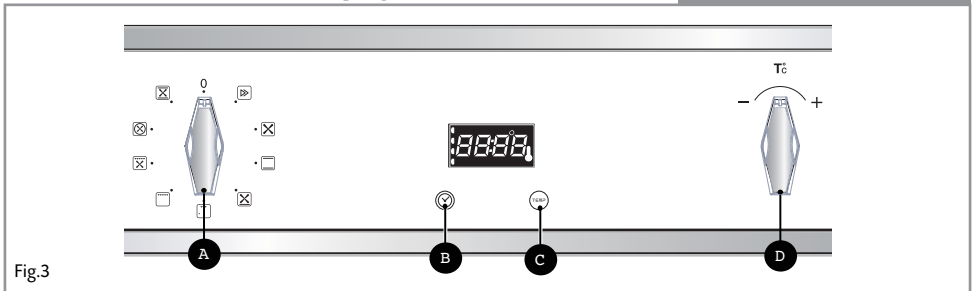

Fig.3

A	Function control knob	This control knob allows you to select the programme required
B	Clock/timer key	This key activates the clock/timer selection
C	Temperature key	This key activates the temperature selection
D	Selection control knob	The control knob allows you to increase or decrease the times and temperatures

## The Control Panel and Display

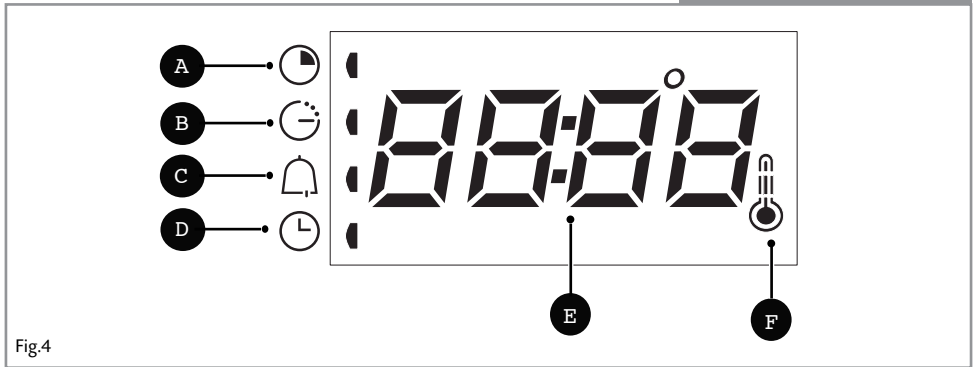





Fig.4

A	Cooking time indicator
B	End time indicator
C	Minute minder indicator
D	Clock indicator
E	Clock/temperature display
F	Temperature indicator

## General Settings and Use

### Clock

To set the clock when the time and the clock indicator are flashing (for example, when the oven is first switched on) turn the selection control knob until the correct time shows on the display, then touch  to confirm the selection. The oven will beep to confirm the selection and the clock and clock indicator will stop flashing.

To set the clock once the time has been set (when the clock is not flashing) touch  twice until the clock and the clock indicator flashes. Turn the selection control knob until the correct time shows on the display, then touch  to confirm the selection. The oven will beep to confirm the selection and the clock and clock indicator will stop flashing.

### Minute minder

This oven is equipped with a minute minder to count down for a maximum of 60 minutes. To set the timer, touch  so the display flashes **0:00** and the minute minder indicator flashes. Turn the selection control knob until the required time shows on the display. The minute minder will set after three seconds delay and starting counting down.

The display will show the time remaining and the minute minder indicator will stay lit. At the end of the countdown, the minute minder indicator will flash and the oven will beep intermittently for approximately 80 seconds. To stop the end of timer alerts before that time, touch .

To check on the progress of the minute minder during a programme, touch  until the minute minder indicator flashes and the time remaining will show on the display.

To cancel the minute minder touch  until the minute minder indicator flashes and then turn the selection control knob until the display shows **0:00**.



Fig. 5

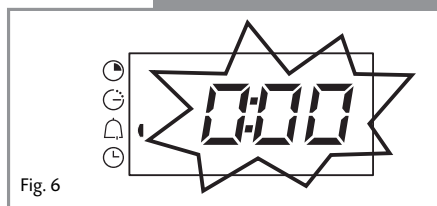



Fig. 6



## General Settings and Use



### To programme the oven

Turn the function control knob to the required programme.



The display will flash the temperature preset for the programme (as detailed on pages 7 and 8) and after three seconds' delay the display will stop flashing and the oven will start cooking.

To change the temperature, temperature selection must be active (the display will flash). If the display is not flashing, touch  so the display flashes. Then turn the selection control knob until the required temperature shows on display, and touch  to confirm the temperature selection.

To set the cooking time (the cooking starts immediately, and finishes at a programmed time), touch  once so the cooking time indicator flashes and the display shows **0:00**. Then turn the selection control knob until the required cooking time (in minutes) shows on the display, and touch  to confirm the cooking time selection. The cooking time indicator will stay lit and the cooking time will show on the display.

To set a delayed programme (the cooking starts and finishes at a programmed time), first set the cooking time as above, then touch  twice so the end time indicator flashes and the display flashes the time the programme is due to end (current time + cooking time). Then turn the selection control knob until the required end time shows on the display, and touch  to confirm the end time selection. The cooking and end time indicators will stay lit and the cooking time will show on the display. The oven light will switch off, and switch back on when cooking starts.

To cancel a programme, touch  once so the cooking time indicator flashes, then turn the selection control knob until the display shows **0:00**.

At the end of the programme, the oven will beep intermittently for two minutes, and the cooking time indicator will flash. To stop the beep, touch  or .

### **Please note: The function control knob must be turned to 0 to switch off the oven completely.**

If the oven must be preheated, switch on the oven as above. Once the preheat is complete, the upper bars on the temperature indicator on the display will stay lit and the oven will beep three times, pause, and beep three times again.

## General Settings and Use

### Oven functions

Each of the oven functions uses different elements within the oven to offer you the best choice of cooking every time. These are explained below.



**1. Preheat booster – preset 200°** (range available 75-275°)

This function uses a combination of elements to bring the oven up to temperature in the shortest possible time.

This function is recommended for any foods that require the oven to be pre-heated.



**2. Defrost – preset 35°** (range available 35-75)

Using the fan and a limited amount of heat, this oven function circulates the air around the oven cavity, speeding up the natural defrost process.

Meats should be placed on a dish to catch liquids from the defrosting process. These liquids are not edible.



**3. Conventional Oven – preset 200°** (range available 75-250)

This function uses the top and bottom heating elements only.

Natural convection creates a perfect cooking zone in the centre of the oven, ideal for dark fruit cakes and pastries.

Preheating is recommended with the conventional oven function.

This programme is used for the notice printed on the energy label in conformity with European standard EN50304 and European directive 2002/40/CE



**4. Fan With Lower Heat – preset 150°** (range available 75-250)

This function circulates the heat produced by the bottom element, with a small amount of heat from the grill and the fan.

The shelf should be on the lowest shelf support setting.

This function is recommended for quiches, fruit tarts etc to cook the crust thoroughly. This function is also recommended for dishes that rise (e.g. cakes and soufflés) where a crust on the top is not required.



**5. Half Grill – preset 230°** (range available 100-275)

This function radiates the heat from the grill element.

The fully temperature variable grill in the half grill function is ideal for small amounts of food.



**6. Full Grill – preset 210°** (range available 100-275)

This function radiates the heat from the grill element.

The fully temperature variable grill in the full grill function is ideal for full family meals or large meals.



**7. Fanned Grill – preset 190°** (range available 100-250)

This function uses the fan to circulate the heat from the grill element around the food.

Foods cook quickly on both sides without the need for turning or preheating the oven.

This function is recommended for all roast meats, and to retain the moist texture of fish steaks.



## General Settings and Use



### 8. Fan Oven – preset 190° (range available 75-250)

Using the fan element and the fan, this cooking function blows the hot air into and around the oven cavity.

Temperatures are achieved quicker, reducing or even removing the need for preheating.

Both cooking temperatures and cooking times can be reduced for a more energy efficient cooking programme.

Perfect for cooking white meat, fish and vegetables moist.



### 9. Fan Assisted Oven – preset 175° (range available 75-220)

Using the fan to circulate the heat produced by the top and bottom heating elements, this function circulates the heat around the oven to give an even temperature throughout.

This function is recommended for quiches and pies baked in a metal, preferably non-stick, dish.

#### FOR EACH GRILL FUNCTION, PLEASE NOTE:

- **Always grill with the oven door closed.**
- **Put the grill pan as close to the grill as possible.**
- **You are recommended not to grill for more than 30 minutes at a time.**
- **Preheat the grill for approximately five minutes with the oven door closed.**



## Cleaning and Maintenance

### **IMPORTANT:**

**Always disconnect the appliance from the power supply before undertaking any cleaning or maintenance. You should always allow the oven to cool fully after use before undertaking any cleaning or maintenance.**

You should only use non-abrasive cleaners. Any abrasive cleaners (including Cif) will scratch the surface and could erase the control panel markings. You should not cleaning products with a chlorine or acidic base.

Any spillages should be cleaned off immediately, especially any alkaline or acidic substances (lemon juice, vinegar etc.)

### **Stainless steel**

Stainless steel can be effectively cleaned by simply using a dilute solution of water and mild detergent and drying to a shine with a clean cloth. Proprietary stainless steel cleaners are available. We recommend the CDA E-Cloth available from the CDA Sales Team for cleaning stainless steel surfaces.

### **Enamelled parts**

All enamelled parts must be cleaned with a sponge and soapy water only, or other non-abrasive products. Suitable proprietary chemical cleaners may be used after first consulting with the manufacturer's recommendations and testing a small sample on the oven cavity.

**PLEASE NOTE: Steam cleaners must not be used to clean this appliance.**

**Do not store flammable material in the oven.**

**When correctly installed, your product meets all safety requirements laid down for this type of product. However, special care should be taken around the rear or the underneath of the appliance as these areas are not designed or intended to be touched and may contain sharp or rough edges that could cause injury.**

The light bulb must only be replaced by authorised service personnel. In the event of light bulb failure, contact CDA Customer Care.

## Care and Maintenance

### Cleaning the interior of the door

Open the door completely and insert two of the red stoppers supplied with the oven, as shown in figure 7.

Then insert the other two red stoppers in the A slots, as shown in figure 8.

Lever the stoppers to lift the frame and the glass from the door, as shown in figure 9.

Remove the inner frame and the panes of glass as shown in figure 10, ensuring you put them on a soft flat surface to prevent damage.

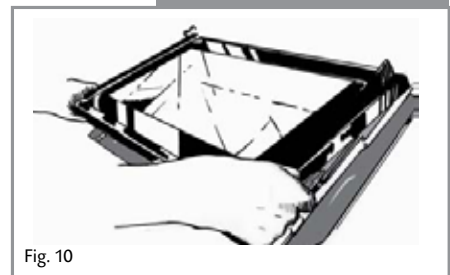
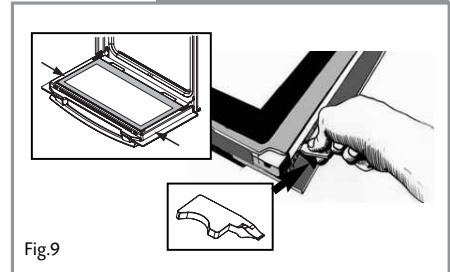
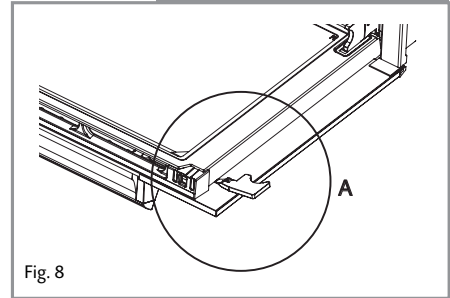
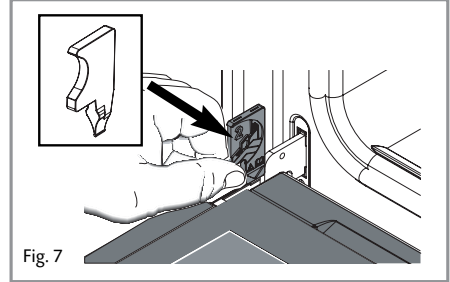

## Care and Maintenance

Clean the panes of glass using a soft sponge and washing up liquid. Do not soak the glass in water.

Do not use abrasive cleaning products, metallic scrapers or scouring sponges. These could scuff the surface and cause the glass to shatter.

Rinse with clean water and dry off with a lint-free cloth.

Replace the clean panes in the door, taking care to slot the frame under the spigot next to the hinge, as shown in figure 11. Reattach the frame by tightening it against the door until the frame clicks into place.

Do not push down on the door itself as this may damage your oven.

Finally remove the red stoppers from the hinge slots.

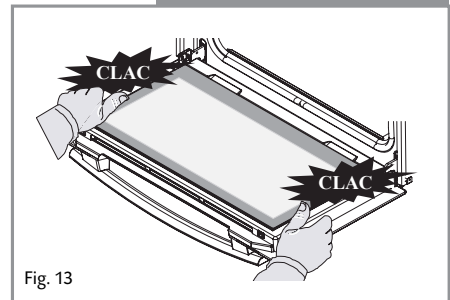
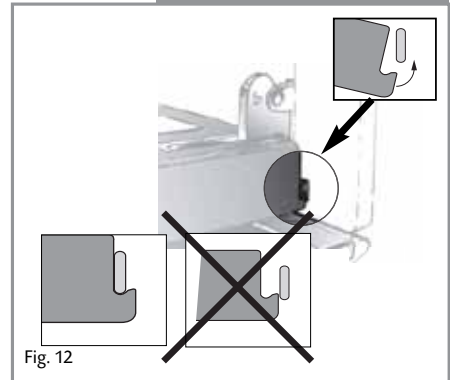
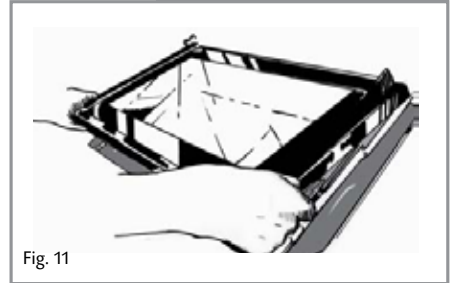

## Troubleshooting

If the oven is not functioning correctly, check the advice below prior to calling CDA Customer Care.

Problem	Possible Cause	Advice
The oven does not heat up	There is no power supply to the oven	Check the oven is switched on at the cooker point and the fuse/circuit breaker has not activated.
The padlock on the display is flashing	Door lock system fault	Call CDA Customer Care
The oven light is not working	Light fault	Call CDA Customer Care
The oven starts beeping during cooking		The oven is at the required temperature
The oven starts beeping at the end of the cooking programme		The programme has finished
The cooling fan continues to run after the programme ends		The fan will run up to one hour after cooking, or when the oven temperature is above 125°C
		If the fan continues to run more than 90 minutes after use, then call CDA Customer Care

The oven display will show error codes if there is a fault with the appliance. These are detailed below. Before calling CDA Customer Care, take note of the error code as this will help when attempting to resolve the problem.

Error Code	Fault
F01	Temperature sensor error
F02	Overheated oven . First ensure there is adequate ventilation to the oven as described on page 14.
F04	Door interlock
F05	Other cooking fault
F10	Information only – power cut during cooking
AUTO	Auto stop. The oven is equipped with an auto stop function to automatically switch off the oven if it is in continuous use for more than 23 hours and 30 minutes.

## Installation

### Important

If the oven is being installed into a built under oven housing unit ensure that the front rail at the top of the unit is not installed as it could restrict ventilation.

Ensure that air can flow freely around the housing area. If the oven is being installed into a fully enclosed built-under oven housing unit it may be necessary to cut a small slot in the top of the plinth fitted under the unit. Cut a section 400mm wide and a minimum of 15mm high to allow air to pass under the unit. Alternatively cut a section 400 x450mm in the base of the carcass as indicated.

Failure to allow adequate ventilation to the appliance may result in overheating or damage to adjacent units and could invalidate the warranty.

The walls of the kitchen units must be able to withstand temperatures of 75°C above ambient (typically this is between 90°C and 100°C). This appliance is type X installation.

When correctly installed ensure that there is a gap of 6mm minimum between the sides of the oven and adjacent furniture doors.

Lift the oven carefully into position on the shelf, taking care NOT to lift it by the door handle. If you open the oven door, you will see 2 screw holes, 1 on each side of the oven. The oven should then be secured to the housing by fitting screws into these holes. Remember the housing should not be free standing but be secured to the wall and/or adjacent fittings.

### How to install your oven

You will need the following housing area fit your oven correctly.

Dimensions	Oven	Housing
Height (mm)	457	450
Width (mm)	592	560
Depth (mm)	571	560 (min)

The oven is designed to fit into a cabinet of 600mm width. The oven can be built in or built under the kitchen units, but you must ensure that it is properly ventilated. In the diagram the built-in oven is ventilated by means of a space at the top of the kitchen cabinet. There are many other methods of ventilating your oven - Consult a qualified engineer for advice.

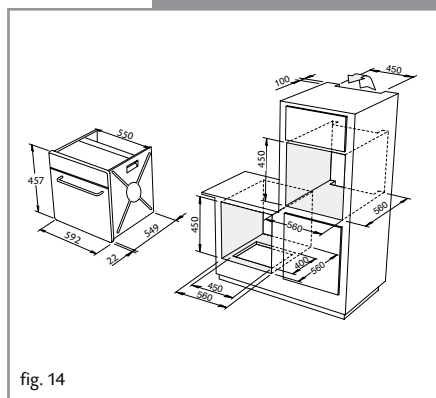

## Mains Electricity Connection

### **Warning! This appliance must be earthed**

We recommend that the appliance is connected by a qualified electrician, who is a member of the N.I.C.E.I.C. and who will comply with the I.E.E. and local regulations.

### **This appliance is intended to be connected to fixed wiring and is not suitable for connection to a 13A plug or 13A supply.**

This appliance is intended to be connected to fixed wiring by a double pole switch, having a contact separation of at least 3mm in all poles. The switch must be positioned no further than 2m from the appliance.

This appliance is supplied with a 3 core mains cable; the wires are in accordance with the following code:

**Green and Yellow = Earth**

**Blue = Neutral**

**Brown = Live**

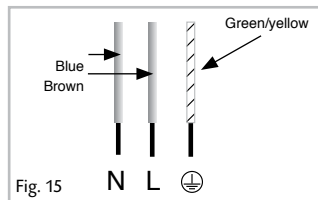

### **Please note:**

- The mains cable must only be replaced by a qualified electrician or service engineer and must be of equivalent or better rating (i.e. 1.5mm<sup>2</sup>, HO5V2V2-F).
- The marking of the current rating of the fuse or circuit breaker protecting this appliance should be marked on the socket outlet (16A).
- Assembly and electrical connection should be carried out by specialised personnel.
- When installing this product we recommend you seek the help of another individual.
- The mains isolation switch must be accessible after installation.



To contact our Customer Care Department, or for Service,  
please contact us on the details below.