

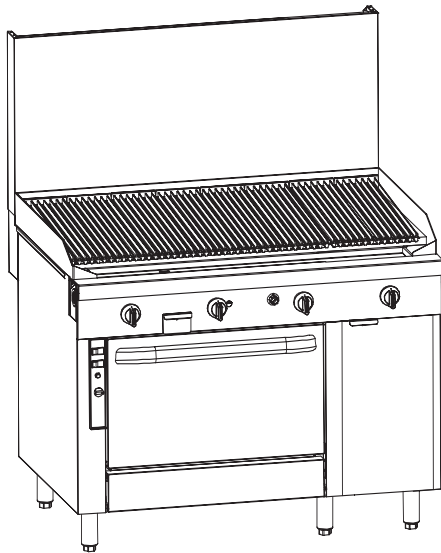

MODEL B48-CCCC

B48-CCCC

48" Heavy Duty Sectional Range with Full Width Charbroiler



Model B48A-CCCC with 24" Flue Riser

Project _____

Item No. _____

Quantity _____

- Model B48A-CCCC (Convection Oven Base)
- Model B48D-CCCC (Standard Oven Base)
- Model B48N-CCCC (Modular Range-Top)

The Blodgett 48" wide sectional-range with full width charbroiler is available with a choice of two types of base (a convection oven with a side cabinet, a standard oven with a side cabinet, or with no base (for mounting as a modular range-top). Three flue-riser heights are available, and the flue riser can support up to 250 pounds (for an optional shelf). An optional rearward-extending flue riser is available to increase the overall depth to match a deep battery. Battery-design assistance is available!

SPECIFY

- | | | |
|---|---|---|
| Gas Type | <input type="checkbox"/> Natural Gas | <input type="checkbox"/> Propane |
| Manifold | <input type="checkbox"/> Front (1-1/4") | <input type="checkbox"/> Rear (1") |
| Flue Riser Height | <input type="checkbox"/> 5" | <input type="checkbox"/> 24" (option) <input type="checkbox"/> 36" (option) |
| Range Depth | <input type="checkbox"/> Standard | <input type="checkbox"/> Deep (option) |
| Position in Battery | <input type="checkbox"/> Left End | <input type="checkbox"/> Right End <input type="checkbox"/> Not at End |
| Electric Power (ovens) | <input type="checkbox"/> 120V | <input type="checkbox"/> 208/240V |
| Operating altitude (if above 2000 ft (700 meters) _____ | | |

Blodgett can often accommodate special or custom requirements. Contact your Blodgett representative.

STANDARD FEATURES (All models)

- Four 32,000 BTU 12" sections with separate controls
- Cast iron grates with surface temperature of up to 725°F
- 5" flue riser
- 7" stainless-steel front rail with "belly bar"
- Standard range depth
- Battery end-units have solid side (no manifold cover plate)
- Stainless-steel front and sides
- Fully insulated lining and burner boxes
- 6" adjustable legs (except on modular range-top model)
- Warranty: two year parts and labor from date of purchase

STANDARD FEATURES (Convection & Standard Ovens)

- 45,000 BTU oven with standing pilot (optional electronic ignition available)
- Cool-to-the-touch oven handle
- Recessed oven control panel for added reliability
- Standard-oven interior is 14" high, 26" wide, 26.5" deep (so sheet pans fit either way)
- Two oven racks (2-1/4" between each of five positions)
- "Insta-On" thermostat with a wide range of 150°F to 500°F
- Convection-oven models have 1/3 hp, two-speed blower
- Porcelain enamel oven interior

OPTIONS AND ACCESSORIES

(AT ADDITIONAL CHARGE)

- Flue riser
 - 24"
 - 36"
- Single-shelf (mounts on 24" flue riser)
 - Solid shelf
 - Tubed shelf
- Double-shelf (mounts on 36" flue riser)
 - Solid shelves
 - Tubed shelves
- Stainless-steel back
- Deep range depth
- Additional oven racks
- Bolt down flange feet
- Casters (in lieu of legs)
- Open frame base with casters
- Cable restraint kit for units on casters



BLODGETT

www.blodgett.com

1100 Old Honeycutt Road Fuquay-Varina, NC 27526 USA

Phone: (877) 255-3976 • Fax: (866) 644-1354



MODEL B48-CCCC

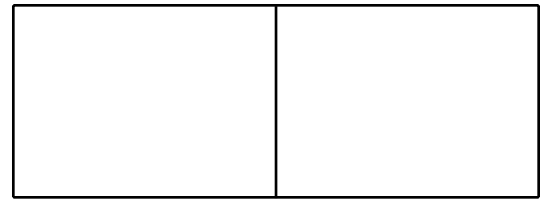

APPROVAL/STAMP

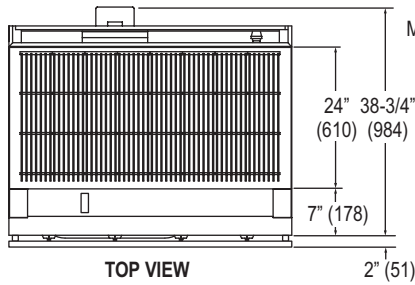

Minimum clearance from noncombustible construction is zero.

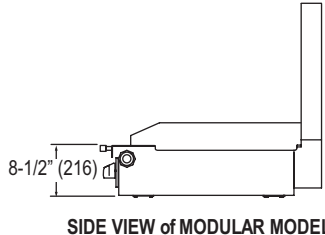

SHIPPING CRATE DIMENSIONS & WEIGHT (Door entry clearance when uncrated is 38" for all models, except convection ovens, which is 41". The flue riser is installed on-site)					
Model	Width	Height	Depth	Volume	Weight
B48A-CCCC	45.5 (1156)	45.0 (1143)	55.0 (1397)	65.2 cu ft (1.85 cu m)	621 lbs (281 kg)
B48D-CCCC	45.5 (1156)	45.0 (1143)	55.0 (1397)	65.2 cu ft (1.85 cu m)	568 lbs (257 kg)
B48N-CCCC	45.5 (1156)	23.0 (584)	55.0 (1397)	33.3 cu ft (0.95 cu m)	276 lbs (125 kg)

Dimensions are in inches and (millimeters)

Flue riser for "deep" depth-option extends rearward 6" (cooking surface area is same as for "standard" depth).

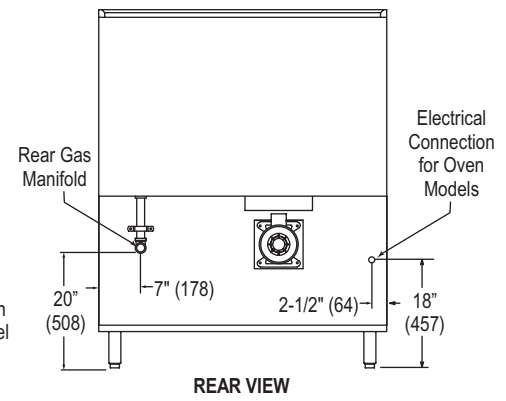
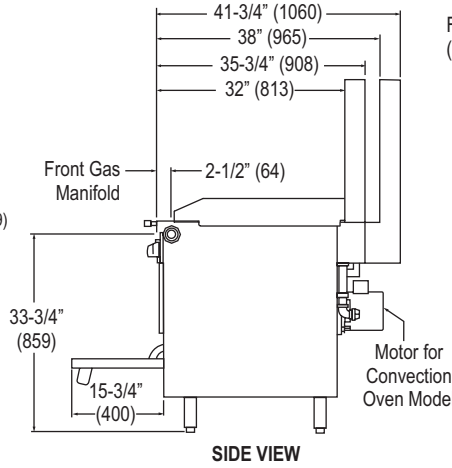
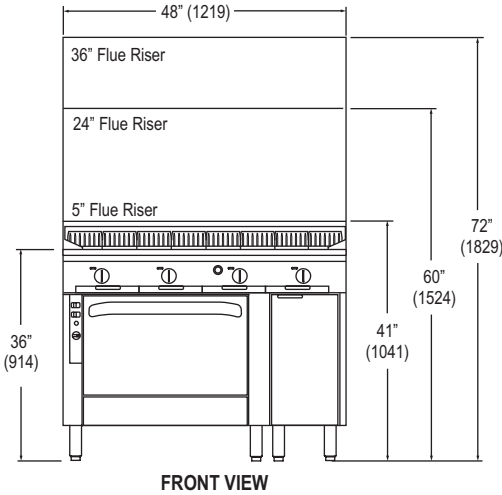

SHORT FORM SPECIFICATIONS

The item shall be a 48"-wide front-manifold sectional range with full width charbroiler with four 32,000 BTU sections, cast iron removable grates, and an operating surface temperature of up to 725°F. The item shall have a 7" front rail and a belly bar. The item shall have 6" adjustable legs [casters]. The item shall have a [5" 24" 36"] flue riser able to support 250 pounds. The exterior (except for the back) shall be constructed of 430 stainless steel #3 polish. If the item is at the end of a battery, the end side shall be solid (rather than have a coverplate over the end of the front manifold).

Model 48A: The item shall have a 12" wide cabinet and 36" wide, 45,000 BTU convection oven with standing pilot and a thermostat range of 150°F to 550°F (66°C to 288°C). The oven interior shall be porcelain, measure 14" high x 26" wide x 24" deep, and have two racks with five-position side-rails with 2-1/4" between positions. The blower fan shall have two speeds and a 1/3 hp motor.

Model 48D: The item shall have a 12" wide cabinet and 36" wide 45,000 BTU standard oven with standing pilot and a thermostat range of 150°F to 550°F (66°C to 288°C). The oven interior shall be porcelain, measure 14" high x 26" wide x 26.5" deep, and have two racks with five-position side-rails with 2-1/4" between positions.

UTILITY INFORMATION

MODEL	GAS (BTU/hr)		ELECTRICITY (amp)	
	Natural Gas	Propane	120V	208/240V
B48A-CCCC	173,000	154,000	4.8	2.6
B48D-CCCC	173,000	154,000	1.0	1.0
B48N-CCCC	128,000	112,000	-	-

GAS: Each unit has a 1-1/4" front gas manifold that couples to the adjacent sectional unit(s), and can be ordered with a 1" rear gas connection with a male NPT connector. Minimum supply pressure is 7" W.C. for natural gas, 11" W.C. for propane. An external pressure regulator and shut off valve must be provided. If using a flexible-hose gas connection, the I.D. of the hose must not be smaller than the connector on the unit and must comply with ANSI Z21.69. Provide an adequate means of restraint to prevent undue strain on the gas connection.

ELECTRICITY: Both standard-oven and convection-oven models require electric power (50Hz or 60Hz single-phase AC). 120V models have a 7-foot (2134 mm) power cord with a grounded plug. 208/240V models have a terminal block for connection to a single-phase 208/240V source.

FLUE EXHAUST: Installation under a vented hood is recommended.

OTHER TECHNICAL INFORMATION

Exterior surfaces are 430 stainless steel #3 polish, except the back is aluminized steel.

Each 12" section has a separate control knob located on the front panel. On oven models, a gas valve for the oven is located on the front panel above the oven. The oven control panel is located to the left of the oven door and includes an on-off switch, indicator light, thermostat knob, and (on convection ovens) a speed selector switch for the blower motor. The fan motor for convection ovens is 1/3 hp, 2-speed, 1725/1140 rpm, with overload protection. Check local codes for fire and sanitary regulations.

NOTE: The company reserves the right to make substitutions of components without prior notice

BLODGETT

www.blodgett.com

1100 Old Honeycutt Road Fuquay-Varina, NC 27526 USA • Phone: (877) 255-3976 • Fax: (866) 644-1354