



# USER'S INFORMATION MANUAL GAS FIRED RESIDENTIAL HEATING BOILERS

CATALOG NO: 2100.51-J  
Effective: 06-15-00  
Replaces: 11-01-99

**MODELS H- 0030B, 0042B, 0066B, 0090B, 0135B, 0180B**

**WARNING: If the information in this manual is not followed exactly, a fire or explosion may result causing property damage, personal injury or loss of life.**

- **Do not store or use gasoline or other flammable vapors and liquids or other combustible materials in the vicinity of this or any other appliance. To do so may result in an explosion or fire.**
  
- **WHAT TO DO IF YOU SMELL GAS**
  - **Do not try to light any appliance.**
  - **Do not touch any electrical switch; do not use any phone in your building.**
  - **Immediately call your gas supplier from a neighbor's phone. Follow the gas supplier's instructions.**
  - **If you cannot reach your gas supplier, call the fire department.**
  
- **Installation and service must be performed by a qualified installer, service agency or the gas supplier.**

This User's Information Manual is provided with the necessary information for the proper operation and maintenance of these Raypak boilers. Please review and follow these procedures carefully. **Keep this manual in a safe and accessible place for easy reference in the future.**

## BLOCKED VENT SHUT-OFF SYSTEM

This boiler is equipped with a blocked vent shut-off system designed to shut off main burner gas in the event the venting system is totally blocked.

In the event the blocked vent shut-off system is actuated, do not attempt to place the boiler in operation, but contact a qualified service agency.

## FLAME ROLL-OUT SAFETY SHUT-OFF SYSTEM

This boiler is equipped with a flame roll-out safety shut-off system designed to shut-off the main burner gas in the event of sustained flame roll-out.

In the event the flame roll-out safety system is actuated, do not attempt to place the boiler in operation, but contact a qualified service agency.

**CAUTION:** *Improper care and maintenance of flue and venting system can cause a hazardous condition which may result in injury or property damage.*

## **LIGHTING INSTRUCTIONS FOR STANDING PILOT MODELS.**

Some safety information you need to read and under-

stand before operating the boiler.

**WARNING:** *If you do not follow these instructions exactly, a fire or explosion may result causing property damage, personal injury or loss of life.*

A. This boiler has a pilot which must be lighted by hand. When lighting the pilot, follow these instructions exactly.

B. **BEFORE LIGHTING** Smell all around the boiler area for gas. Be sure to smell next to the floor because some gas is heavier than air and will settle on the floor.

### WHAT TO DO IF YOU SMELL GAS

- Do not try to light any appliance.
- Do not touch any electric switch;
- Do not use any phone in your building.
- Immediately call your gas supplier from a neighbor's phone. Follow the gas supplier's instructions
- If you cannot reach you gas supplier, call the fire department.

C. Use only your hand to push in move or turn the gas control knob or lever. Never use tools. If the knob or lever will not push in move or turn by hand,

don't try to repair it, call a qualified service technician. Force or attempted repair may result in a fire or explosion.

D. Do not use this boiler if any part has been under water. Immediately call a qualified service technician to inspect the boiler and to replace any part of the control system and any gas control which has been under water.

**FOR STANDING PILOT MODELS WITH ROBERTSHAW GAS VALVE, 2 STAGE OPERATION.  
(Models 90, 135 & 180)**

1. **STOP!** Read the safety information.
2. Set the thermostat to the lowest setting.
3. Turn off all electric power to the appliance.
4. Push in and move gas control lever counterclockwise  to "OFF" position.

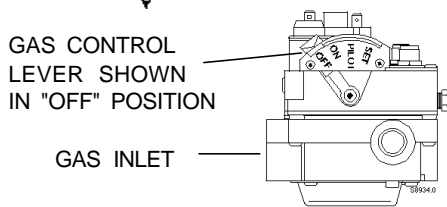

Fig. #8934.0

NOTE: Lever cannot be moved from "ON" to "OFF" unless lever is pushed in slightly. Do not force.

5. Wait five (5) minutes to clear out any gas. Then smell for gas, including near the floor. If you smell gas, STOP! Follow "B" in the safety information above on this label. If you don't smell gas, go to the next step.
6. Locate pilot mounted on the right side of the burner drawer, and right of first burner.

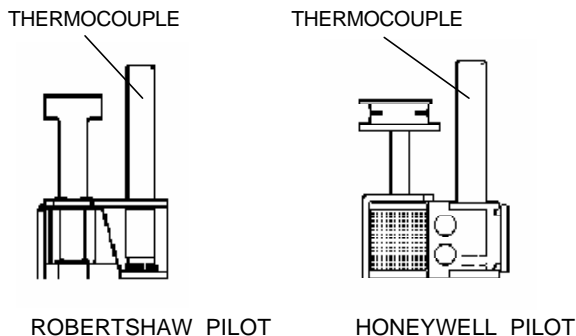



Fig. #8084.1

Fit. # 8083.0

7. Move control lever clockwise  to "SET" position and immediately light pilot with a match.
8. Hold lever in "SET" position for 1/2 minute after pilot is lit. Release lever, and it will spring back to "PILOT" position Pilot should remain lit. If it goes out, repeat steps 4 through 8.

\*If lever does not spring back to "PILOT" position when released, stop and immediately call your

service technician or gas supplier.

\*If the pilot does not stay lit after several tries, move the gas control lever to "OFF" and call your service technician or gas supplier.

9. Stand to the side of the heater and move the gas control lever counterclockwise  to "ON".
10. Turn on all electric power to the appliance.
11. Set the thermostat to the desired setting.

**TO TURN OFF GAS TO THE BOILER**

1. Set the thermostat to the lowest setting.
2. Turn off all electric power to the appliance.
3. Push in and move gas control lever counterclockwise  to "OFF" position. Do not force.

**LIGHTING INSTRUCTIONS FOR AUTOMATIC IGNITION MODELS.**

Please read carefully and understand the following safety information before operating the boiler.

**WARNING:** If you do not follow these instructions exactly, a fire or explosion may result causing property damage, personal injury or loss of life.

A. This boiler does not have a pilot. It is equipped with a hot surface ignition device which automatically lights the burners. Do not try to light the burners by hand.

B. **BEFORE OPERATING** smell all around the boiler area for gas. Be sure to smell next to the floor because some gases are heavier than air and will settle on the floor.

**WHAT TO DO IF YOU SMELL GAS**

- \* Do not try to light any appliance.
- \* Do not touch any electric switch;
- \* Do not use any phone in your building.
- \* Immediately call your gas supplier from a neighbor's phone. Follow the gas supplier's instructions.
- \* If you cannot reach your gas supplier, call the fire department.

C. Use only your hand to push in, move or turn the gas control knob or lever. Never use tools. If the knob or lever will not push in, move or turn by hand, don't try to repair it, call a qualified service technician. Force or attempted repair may result in a fire or explosion.

D. Do not use this boiler if any part has been under water. Immediately call a qualified service technician to inspect the boiler and to replace any part of the control system and any gas control which has been underwater.

**FOR INTERMITTENT IGNITION (IID) WITH HONEYWELL OR ROBERTSHAW GAS VALVE (For All Models)**

1. **STOP!** Read the safety information above.
2. Set the thermostat to the lowest setting.
3. Turn off all electric power to the appliance.
4. This boiler is equipped with an ignition device which automatically lights the pilot. Do not try to light the pilot by hand.

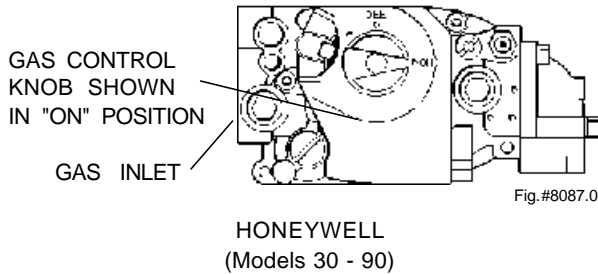

5. **For Honeywell Valve:** Turn gas control knob clockwise to "Off".  
**For Robertshaw Valve:** Push in and move gas control lever to "Off" position.
6. Wait 5 minutes to clear out any gas. Then smell for gas, including near the floor. If you smell gas, **STOP!** Follow "B" in the safety information above on this label. If you don't smell gas, go to the next step.
7. **For Honeywell Valve:** Turn gas control counter-clockwise to "On".  
**For Robertshaw Valve:** Move gas control lever to "On" position.

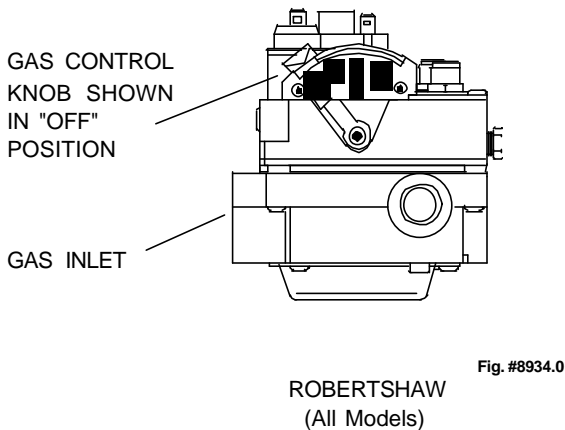

8. Turn on all electric power to the boiler.
9. Set thermostat to desired setting.
10. If the boiler will not operate, follow the instruction "To Turn Off Gas To Boiler" and call your service technician or gas supplier.

**TO TURN OFF GAS TO BOILER**

1. Set the thermostat at the lowest setting.
2. Turn off all the electric power to the boiler if service

- is to be performed.
3. **For Honeywell Valve:** Turn gas control knob clockwise to "Off". Make sure knob rest against stop.  
**For Robertshaw Valve:** Push in and move gas control lever to "Off" position.

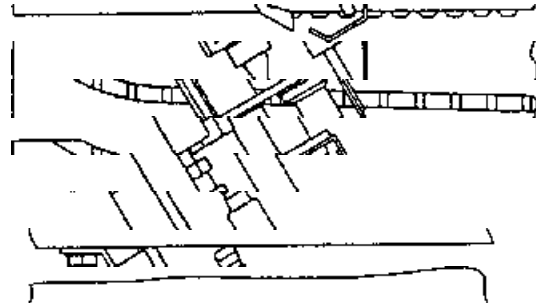

HONEYWELL PILOT

**CAUTION:** Should overheating occur or the gas supply fails to shut off, **DO NOT** turn off or disconnect the electrical supply to the pump. Instead, shut off the gas supply at a location external to the appliance. Failure to observe this precaution may aggravate the overheated condition resulting in possible damage to the boiler and injury to the user.

**INSPECTION AND MAINTENANCE PROCEDURES**

It is a good practice to make a periodic inspection of the boiler. It is recommended that the home owner or user check's the boiler after the first and third month of operation, and then on an annual basis, or more often if desired. It is also recommended to have a qualified service agency check the boiler before each heating season, or at anytime there may be an indication of a problem.

**DANGER:** Keep boiler area clear and free from combustibles and flammable materials. Do not obstruct the flow of combustion and ventilating air into the boiler enclosure. Failure to observe these safety precautions can cause fire, explosion, or asphyxiation.

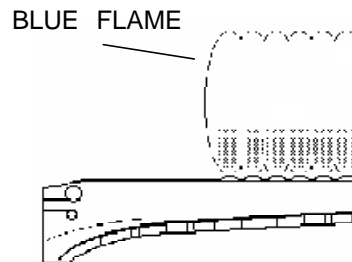

Fig.#9295

### 1. Burner Inspection.

Clean the main burners and air louvers of dust, lint and debris. With burner in operation, make a visual check of the burner flame and the pilot flame (when equipped). Yellow flames indicate some restriction of combustion air openings. A bright orange, luminous flame is not normal and can cause sooting under prolonged operation. Should this condition be observed, contact immediately a qualified service agency to correct the problem.

### 2. Venting System Inspection.

Visually inspect the venting system. Make sure the vent connections are secure and have not become disengaged. Look for any indication of corrosion, or carbon (soot) streaks which could cause leakage of products of combustion into the living space. Inspect the vent terminal outside the building. Make sure it is not damaged to cause blockage or restriction of the flue gas. Observe for any indication of soot. The presence of soot accumulation in the vent terminal would indicate an abnormal operating condition. This should be investigated and corrected by a qualified service agency.

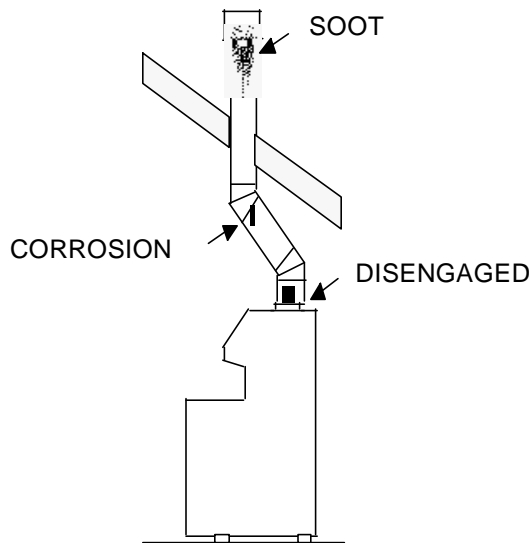

Fig.#8204.0

### 3. Circulator (Water Pump) Inspection.

The circulator is permanently lubricated and thus, will not require any lubrication. Inspect for evidence of water leakage. This should be corrected to prevent any possible damage to electrical components of the boiler.

**CAUTION:** In case of a prolonged power failure during freezing weather conditions, boiler and piping system must be drained completely to avoid possible damage to the heating system.

To prevent the potential freezing damage to the heating system, it is recommended that the following system shut down procedure be performed.

#### SYSTEM SHUT DOWN PROCEDURE

1. Set the room thermostat to "OFF" or the lowest setting.
2. Turn off all electric switches to the boiler.
3. Turn off all gas valves supplying gas to the boiler. Refer to operating instruction label on the boiler.
4. Shut off the water supply to the boiler piping system loop.
5. Open drain valve on the boiler to remove water from the boiler and the piping circuits.

**NOTE:** It may be necessary to open the purge valves and/or manual air vents to facilitate complete drainage of water from the heating system.

### 4. Service Assistance.

If service is required on the boiler, contact your local service agency or Raypak, Inc. can refer you to the proper qualified service agency. It is important and very often will save time if you state the model number, serial number and type of gas used. This information will be found on the nameplate of the boiler.