

FOR PERFECT RESULTS

Thank you for choosing this AEG product. We have created it to give you impeccable performance for many years, with innovative technologies that help make life simpler – features you might not find on ordinary appliances. Please spend a few minutes reading to get the very best from it.

ACCESSORIES AND CONSUMABLES

In the AEG webshop, you'll find everything you need to keep all your AEG appliances looking spotless and working perfectly. Along with a wide range of accessories designed and built to the high quality standards you would expect, from specialist cookware to cutlery baskets, from bottle holders to delicate laundry bags...



Visit the webshop at:
www.aeg-electrolux.com/shop

CONTENTS

- 4 Safety information
- 7 Product description
- 9 Before first use
- 10 Control panel
- 11 Daily use
- 15 Clock functions
- 17 Automatic programmes
- 18 Using the accessories
- 20 Additional functions
- 21 Helpful hints and tips
- 22 Care and cleaning
- 25 What to do if...
- 26 Environment concerns

The following symbols are used in this user manual:



Important information concerning your personal safety and information on how to avoid damaging the appliance.



General information and tips



Environmental information

Subject to change without notice

SAFETY INFORMATION

Before the installation and use, read this manual carefully:

- For your personal safety and the safety of your property
- For the respect of the environment
- For the correct operation of the appliance.

Always keep these instructions with the appliance also if you move or sell it.
The manufacturer is not responsible if incorrect installation or use results in damage.

Children and vulnerable people safety

- This appliance can be used by children aged from 8 years and above and persons with reduced physical, sensory or mental capabilities or lack of experience and knowledge if they have been given supervision or instruction concerning use of the appliance in safe way and understand the hazards involved. Children shall not play with the appliance.
- Keep all packaging away from children. There is the risk of suffocation or physical injury.
- Keep children and animals away from the appliance when the door is open or the appliance is in operation. There is the risk of injury or other permanent disability.
- If the appliance has Child Lock or Key Lock (Control Lock) function, use it. It prevents children and animals from accidental operation of the appliance.

General safety

- Do not change the specifications of this appliance. There is the risk of injury and damage to the appliance.
- Do not let the appliance stay unattended during operation.
- Switch off the appliance after each use.

Installation

- Only an approved electrician can install and connect the appliance. Contact an approved service centre. This is to prevent the risks of structural damage or physical injury.
- Make sure that the appliance is not damaged because of transport. Do not connect a damaged appliance. If necessary, contact the supplier.
- Remove all packaging, stickers and layers from the appliance before first use. Do not remove the rating plate. It can invalidate the guarantee.
- Make sure that the appliance is disconnected from the power supply during the installation.
- Be careful when you move the appliance. The appliance is heavy. Always use safety gloves. Do not lift the appliance by the handle.
- The electrical installation must have an isolation device which lets you disconnect the appliance from the mains at all poles. The isolation device must have a contact opening width of minimum 3 mm.
- You must have correct isolation devices: line protecting cut-outs, fuses (screw type fuses removed from the holder), earth leakage trips and contactors.
- Before the installation, make sure that the kitchen cabinet has the recess dimensions applicable.

- Make sure that the appliance is installed below and adjacent safe structures.
- Keep the minimum distances to the other appliances and units.
- The appliance cannot be positioned on a base.
- Built in ovens and built in cooking surfaces are attached with special connection system. To prevent damage to the appliance, only use an appliance with the appliances from the same manufacturer.

Electrical connection

- The appliance must be earthed.
- Make sure that the electrical data on the rating plate agree with your domestic power supply.
- Information on the voltage is on the rating plate.
- Always use a correctly installed shockproof socket.
- Do not use multi-way plugs, connectors and extension cables. There is the risk of fire.
- Do not replace or change the mains cable. Contact the service centre.
- Make sure not to squash or cause damage to the mains plug (if applicable) and cable behind the appliance.
- Do not pull the mains cable to disconnect the appliance. Always pull the mains plug – if applicable.

Use

- The appliance is only for domestic use. Do not use the appliance for commercial and industrial use.
- Only use the appliance for domestic cooking tasks. This is to prevent physical injury to persons or prevent damage to property.
- Do not use the appliance as a work surface or storage surface.
- The interior of the appliance and the accessories become hot during use. There is the risk of burns. Use safety gloves when you insert or remove the accessories or pots.
- Be careful when you remove or install the accessories to prevent damage to the oven enamel.
- Always stay away from the appliance when you open the door while the appliance is in operation. Hot steam can release. There is the risk of skin burns.
- To prevent damage or discoloration to the enamel:
 - do not put any objects directly on the appliance floor and do not cover it with aluminium foil;
 - do not put hot water directly into the appliance;
 - do not keep moist dishes and food in the appliance after you finish the cooking.
- Discoloration of the enamel has no effect on the performance of the appliance so it is not a defect in the sense of the warranty law.
- Do not apply pressure on the open door.
- Always close the appliance door when you cook, even while grilling.

Care and cleaning

- Before maintenance, switch off the appliance and disconnect the appliance from the power supply.
- Before maintenance, make sure that the appliance is cold. There is the risk of burns. There is the risk that the glass panels can break.
- Keep the appliance clean at all times. A build-up of fats or other foodstuff can result in a fire.
- Regular cleaning prevents the surface material from deteriorating
- Use a deep baking tray for very moist cakes to prevent that fruit juices cause stains that can be permanent.
- For your personal safety and the safety of your property, only clean the appliance with water and a soap. Do not use flammable products or products that can cause corrosion.
- Do not clean the appliance with steam cleaners, high-pressure cleaners, sharp objects, abrasive cleaning agents, abrasive sponges and stain removers
- If you use an oven spray, follow the instructions from the manufacturer.
- Do not clean the glass door with abrasive cleaning agents or metal scraper. Heat resistant surface of the inner glass can break and shatter.
- When the door glass panels are damaged they become weak and can break. You must replace them. Contact the service centre.
- Be careful when you remove the door from the appliance. The door is heavy!
- Do not clean catalytic enamel (if applicable).

Risk of fire

- Open the door carefully. The use of ingredients with alcohol can cause a mixture of alcohol and air. There is the risk of fire.
- Do not let sparks or open flames come near the appliance when you open the door.
- Do not put flammable products or items that are wet with flammable products, and/or fusible objects (made of plastic or aluminium) in, near or on the appliance.

Steam cooking

- Do not open the oven door during Steam cooking. Steam can release. There is the risk of skin burns. There is the risk that steam causes moisture damage to units.

Oven lamp

- Bulb lamps used in this appliance are special lamps selected for household appliances use only. They cannot be used for the full or partial illumination of a household room.
- If it becomes necessary to replace the lamp use one of the same power and specifically designed for household appliances only.
- Disconnect the appliance from the power supply before the replacement of the oven lamp. There is the risk of electrical shock.

Service centre

- Only an approved engineer can repair or work on the appliance. Contact an approved service centre.

- Use only original spare parts.

Disposal of the appliance

- To prevent the risk of physical injury or damage
 - Disconnect the appliance from the power supply.
 - Cut off the mains cable and discard it.
 - Discard the door catch. This prevents children or small animals from being closed inside of the appliance. There is the risk of suffocation.

PRODUCT DESCRIPTION

General overview

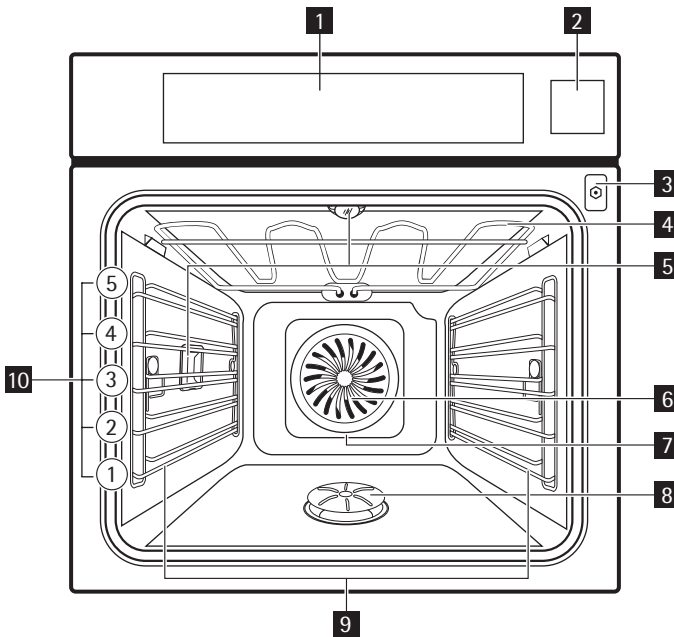

- 1** Control panel
- 2** Water tank
- 3** Socket for the core temperature sensor
- 4** Heating element
- 5** Oven lamp
- 6** Fan
- 7** Rear wall heating element
- 8** Steam generator
- 9** Shelf support, removable
- 10** Shelf positions

Oven accessories

- Wire shelf

For cookware, cake tins, roasts.

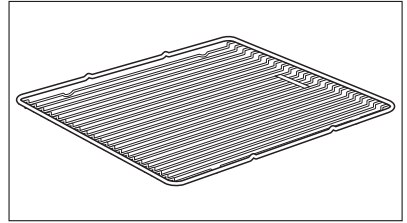

- Baking tray

For cakes and biscuits.

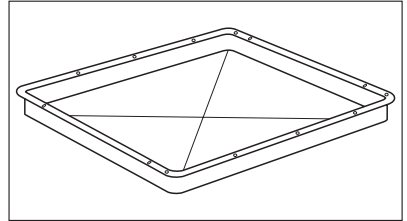

- Grill / roasting pan

To bake and roast or as pan to collect fat.

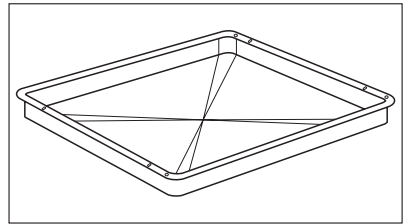

- Patisserie tray

For rolls, brezels and small pastries.

Suitable for steam functions. Discoloration of the surface has no effect on function.

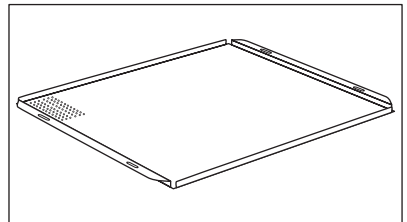

- Sponge 150

For absorbing residual water from the steam generator.

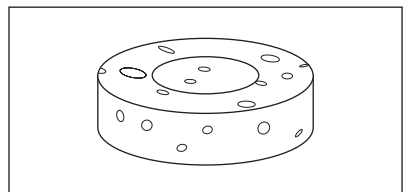

- **Steam set**
Unperforated and perforated food container.

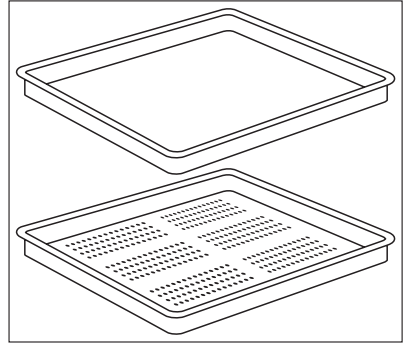

- **Core Temperature Sensor**
To measure how far the food is cooked.

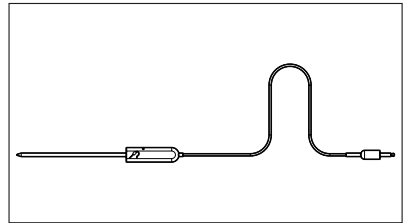

BEFORE FIRST USE



WARNING!

Refer to "Safety information" chapter.

Initial Cleaning

- Remove all parts from the appliance.
- Clean the appliance before first use.



CAUTION!

Do not use abrasive cleaning agents! This can damage the surface. Refer to chapter "Care and Cleaning".

First Connection

When you connect the appliance to the mains or after the power cut you have to set the language, display contrast, display brightness and time of the day. Use shuttle to set the value. Press OK to confirm.

CONTROL PANEL

Control Panel

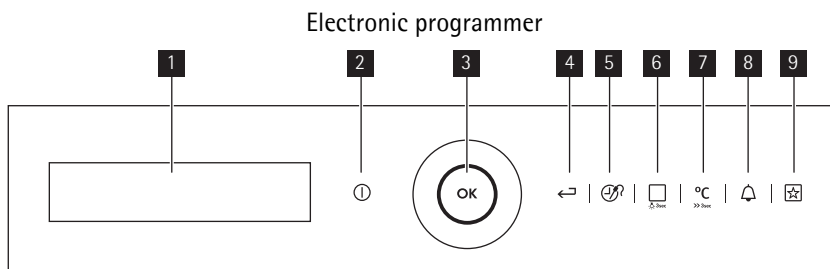

Use the sensor fields to operate the appliance

Number	Sensor field	Function	Comment
1	-	Display	Shows the current settings of the appliance.
2		On/off	To activate and deactivate the appliance.
3	OK	OK and Shuttle	To confirm the selection or setting. Use shuttle to navigate.
4		Home Key	To display main menu.
5		Time and additional functions	To set different functions when the oven function operates: timer, child safety, Favourite Programme memory, Heat + Hold , SET + GO , Core Temperature Sensor setting change.
6		Heating Functions or Assisted Cooking	If you press it ones, you can choose the oven function. If you press it twice, you can choose the Assisted Cooking function . If you press it and hold for 3 seconds, it turns oven light ON and OFF.
7		Temperature selection	To set cavity temperature or show current oven temperature. If you press it and hold for 3 seconds, it turns Fast Heat Up function ON and OFF.
8		Minute Minder	To set the Minute Minder .
9		Favourite Programme	You can store your favourite programmes. Use it to access them.

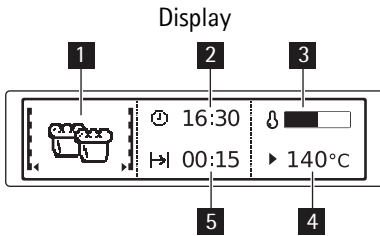

- 1 Oven function
- 2 Shows the current time
- 3 Heat-up indicator
- 4 Temperature
- 5 Shows duration time or end time of a function

Other indicators of display

Symbol	Function
	Minute Minder The function is active.
	Time The display shows the current time.
	Duration Shows the time required for the cooking cycle.
	End Time Shows when the cooking cycle ends.
	Time Indication It shows how long the heating function operates.
	Heat-up indicator Indicates temperature level in the cavity. Display shows it also after you deactivate the appliance and the cavity is still warm.
	Fast Heat Up indicator The function is active. It decreases the heat up time.
	Weight Automatic The display shows that automatic weight system is active or weight can be changed.
	Heat + Hold The display shows the function is active.

DAILY USE



WARNING!

Refer to "Safety information" chapter.















The menus in overview

Main menu

Symbol	Menu item	Application
	Assisted Cooking	Contains a list of automatic cooking programmes.
	Heating Functions	Contains a list of oven heating functions.
	Favourite Programme	Contains a list of favourite cooking programmes stored by user.
	Steam Cleaning	Procedure for cleaning with steam.
	Basic Settings	You can use it to set other oven settings.

 Refer to Recipe Book for Assisted Cooking menu listing.



Submenus for: Basic Settings

Symbol	Submenu	Description
	Set Time of Day	Sets the current time on the clock.
	Time Indication	When ON, the displays shows the current time when you deactivate the appliance.
	SET + GO	When ON, you can activate the functions when you activate the oven function.
	Heat + Hold	When ON, you can activate this function when you activate the oven function.
	Extra time	Activates and deactivates the function.
	Display Contrast	Adjusts display contrast by degrees.
	Display Brightness	Adjusts display brightness by degrees.
	Set Language	Sets the language for the display.
	Buzzer Volume	Adjusts volume of press-tones and signals by degrees.
	Key Tones	Activates and deactivates the tone of the touch fields.
	Alarm/Error Tones	Activates and deactivates the alarm tones.
	Cleaning Assistant	Guides you through the cleaning procedure.
	Service	Shows the software version and configuration.
	Factory Settings	Reset all settings to factory settings.





Favourite Programme : You can save up to 20 programs.

Heating functions

Submenu for: Heating Functions

	Oven function	Application
	Full Steam	For vegetables, fish, potatoes, rice, pasta or special side-dishes.
	Half Steam + Heat	For dishes with a high moisture content and for poaching fish, custard royale and terrines.
	Quarter Steam + Heat	To bake bread, roast large pieces of meat or to warm up chilled and frozen meals.

	Oven function	Application
	Eco Steam	ECO functions let you to optimize the energy consumption during cooking. Thus it is necessary to set the cooking time first. To get more information about the recommended settings, refer to the cooking tables with the equivalent usual oven function.
	Moist Fan Baking	For energy-saving baking and cooking of mainly dry bakery items as well as for baking in tins on one shelf position.
	True Fan Cooking	For baking on up to three oven levels at the same time. Set the oven temperatures 20-40 °C lower than when using Conventional cooking .
	Pizza Setting	For baking on one oven level dishes that require more intensive browning and a crispy base. Set the oven temperatures 20-40 °C lower than when using conventional.
	Slow Cook	For preparing especially tender, succulent roasts.
	Conventional Cooking	For baking and roasting on one oven level
	Frozen Foods	To make your convenience food like e.g. French Fries, Wedges, spring rolls crispy.
	Turbo Grilling	To roast larger meat joints or poultry with bones on one shelf position. Also to gratinate and to brown.
	Fast Grilling	To grill flat food in large quantities. To toast bread.
	Grilling	To grill flat food in the middle of the grill. To toast bread.
	Keep Warm	To keep food warm.
	Defrost	To defrost frozen food.
	Bottom Heat	For baking cakes with crispy or crusty bases and to preserve food.
	Dough Proving	For controlled rising of yeast dough before baking.
	Bread Baking	To bake bread.
	Au Gratin	For oven dishes like lasagna or potato gratin. Also to gratinate and brown.

	Oven function	Application
	Preserving	To preserve vegetables e.g. mixed prickles in glasses and liquid.
	Drying	For drying of sliced fruits like apples, plums, peaches and vegetables as tomatoes, zucchini or mushrooms.
	Plate Warming	To preheat your plate for serving.
	Steam Reheating	To reheat your already cooked food directly on a plate.
	Eco Roasting	For roasting larger joints of meat or poultry on one level. The function is also suitable for gratinating and browning.

Navigating the menus

Operation of the menus:

1. Activate the appliance.
2. Use the shuttle clockwise or counter clockwise to select the menu option.
3. Press OK to move to submenu or accept setting.

At every point you can get back to the main menu with \leftarrow .

Activating a heating function

1. Activate the appliance.
2. Select Heating Functions menu. Press OK to confirm.
3. Select the heating function. Press OK to confirm.
4. Set the temperature. Press OK to confirm.





Press  to go directly to Heating Functions menu. Also in off state.

Steam cooking

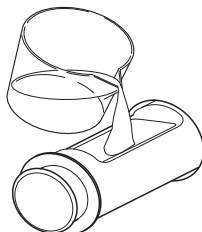
1. Fill the water tank with approximately 800 ml of water. The tank is in the control panel. The water supply is for approximately 50 minutes. When the water finishes acoustic signal sounds. Refill the drawer.



2. Activate the appliance.
3. Select the steam heating function and set temperature.

4. Use  to set the Duration  for cooking time or End Time  for switch-off time.
The first steam shows after approximately 2 minutes. When the oven reaches set temperature an acoustic signal sounds.
Another acoustic signal sounds at the end of cooking time or when water finishes.
5. Deactivate the appliance.
After the oven cools down, soak up all remaining water from the steam generator with the Sponge and clean if it is necessary with some vinegar.
Let the oven dry fully with the door open.

Heat-up indicator

When you activate an oven function, the bar on the display comes on. The bar shows that the temperature increases.

Fast Heat Up indicator

This function decreases the heat-up time. To activate the function hold  for 3 seconds. You will see the heat-up indicator alternates.

Residual heat indicator

When you deactivate the appliance, the display shows the residual heat. You can use the heat to keep the food warm.

Energy saving





The appliance has same features that help you save energy during everyday cooking:

- Residual heat:
 - the oven function or programme operates: the heating elements are deactivated 10% time earlier (the lamp and fan continue to operate). The condition: the cooking time is longer then 30 minutes or you use the clock functions (Duration , End Time).
 - the oven is off: you can use the heat to keep the food warm. The display shows the remaining temperature, the bars show the decreasing temperature.
- Oven lamp off - touch and hold  for 3 seconds to deactivate the oven lamp during cooking;
- Eco functions - refer to "Oven function".

CLOCK FUNCTIONS

Timer functions

Symbol	Function	Description
	Minute Minder	To set a countdown (max 2 hours 30 minutes). This function has no effect on the operation of the appliance. You can also activate it in off state. Use  to activate the function. Use shuttle to set the minutes and OK to start.
	Duration	To set how long the appliance has to be in operation (max. 23 h 59 min).

Symbol	Function	Description
→	End Time	To set the switch-off time for an oven function (max. 23 h 59 min).

 You can use Duration and End Time at the same time, if you want to automatically activate and deactivate the appliance on a given time later.

If you set the time for a clock function, the time starts to count down after 5 seconds.

 If you use the clock functions Duration and End Time, the appliance deactivates the heating elements after 90 % of the set time. The appliance uses the residual heat to continue the cooking process until the time ends (3–20 minutes).

Setting the Duration and End Time

1. Set the oven function.
2. Press  again and again until the display shows the necessary clock function and the related symbol.
3. Use shuttle to set the necessary time. Press OK to confirm.
After 90 % of the set time, an acoustic signal sounds. The appliance deactivates. The display shows a message.
4. Press a sensor field or open the door to stop the signal.

 With Duration and End Time the appliance deactivates automatically.

 With Duration and End Time you must set the heating function and the temperature first. Then you can set the clock function.

 When you use Core Temperature Sensor, Duration and End Time do not work.

Heat + Hold

 You can activate or deactivate the function in Basic Settings menu.

The Heat + Hold function keeps prepared food warm at 80° for 30 minutes. It activates after the baking or roasting procedure ends.

 **Conditions for the function:**

- The set temperature is more than 80°C.
- The function Duration is set.

Activating the function

1. Activate the appliance.
2. Select the oven function.
3. Set the temperature above 80°C.
4. Press  again and again until the display shows Heat + Hold. Press OK to confirm.
When the function ends, an acoustic signal sounds.

The Heat + Hold function operates for 30 minutes.



The Heat + Hold function stays on if you change the oven functions.

Extra Time

The Extra Time makes the oven function continue after the Duration ends.

- Applicable for all oven functions with Duration or Weight Automatic .
- Not applicable for oven functions with Core Temperature Sensor.

Activating the function:

1. When the cooking time ends, an acoustic signal sounds. Press any sensor field.
2. The display shows the message for Extra Time for five minutes.
3. Press  to activate (or  to cancel).
4. Set Extra Time period. Press OK to confirm.

AUTOMATIC PROGRAMMES



WARNING!

Refer to "Safety information" chapter.

Assisted Cooking with Recipe Automatic

This appliance has a set of recipes you can use. Recipes are fixed and you cannot change them.

Activating the function:

1. Activate the appliance.
2. Select Assisted Cooking menu. Press OK to confirm.
3. Select the category and dish. Press OK to confirm.
4. Select the Recipe Automatic . Press OK to confirm.



When you use Manual function the appliance uses automatic settings. You can change them as with other functions.

Assisted Cooking with Weight Automatic

This function automatically calculates the roasting time. To use it you need to input food weight.

Activating the function:

1. Activate the appliance.
2. Select Assisted Cooking . Press OK to confirm.
3. Select the category and dish. Press OK to confirm.
4. Select the Weight Automatic . Press OK to confirm.
5. Use the shuttle to set the food weight. Press OK to confirm.

The automatic program starts. You can change the weight at any time. Use the shuttle to change the weight. When time ends, an acoustic signal sounds. Press a sensor field to deactivate the signal.



-  With some programs turn over the food after 30 minutes. The display shows a reminder.

Favourite Programme

You can store your favourite settings like duration, temperature or oven function. They are available in Favourite Programme menu. You can store 20 programmes.

Storing a program

1. Activate the appliance.
2. Select the oven function or Assisted Cooking function.
3. Press  again and again until the display shows "SAVE ". Press OK to confirm.
4. The display shows the first free memory position.
Press OK to confirm.
5. The first letter flashes.
Use the shuttle to change the letter. Press OK .
6. Turn the selector to move the cursor to the right or to the left. Press OK.
The letter flashes.
7. Repeat steps 5 and 6 again to write name of the program.
Press and hold OK to save.



-  Press and hold  for 3 seconds to save the current program in Favourite Programme

-  You can over write a memory position. (Refer to the section „Storing a programme“. At step 4 use the shuttle to over write existing program.

-  You can change the name of a program in the menu " Edit Programme Name ".

Activating the programme

1. Activate the appliance.
2. Select Favourite Programme menu. Press OK to confirm.
3. Select your favourite programme name. Press OK to confirm.

-  Press  to go to Favourite Programme directly. Also from the off state.

USING THE ACCESSORIES



WARNING!

Refer to "Safety information" chapter.

Core temperature sensor

Core temperature sensor measures the core temperature of the meat. When the meat reaches set temperature the oven switches off automatically.

You have to set:

- The oven temperature
- The core temperature



Use only original parts. It ensures the best cooking result.

Using the core temperature sensor:

1. Put the tip of the core temperature sensor into the centre of the meat.
2. Activate the appliance.
3. Put the plug of the core temperature sensor into the socket on the right-upper side of the cavity front.

The display shows core temperature sensor.

4. Use shuttle in less than 5 seconds to set the core temperature.
5. Set the oven function and, if necessary, the oven temperature.

The appliance calculates an approximate end time. An end time is different for the different quantities of the food, the set oven temperatures (minimum 120°C) and the operating modes. The appliance calculates the end time in approximately 30 minutes.



The core temperature sensor must stay in the meat and in the socket during the cooking process.

6. When the meat reaches set core temperature, an acoustic signal sounds. The appliance switches off automatically.

Use any key to stop the signal.

7. Remove the core temperature sensor plug from the socket and remove the meat from the oven.



To change the core temperature press .



WARNING!

The core temperature sensor is hot! There is the risk of burns! Be careful when you remove the tip and plug of the core temperature sensor.

Inserting the Oven Accessories



The deep pan and the wire shelf have side edges. These edges and the shape of the guide-bars causes the anti-tilt safety for the oven accessories.

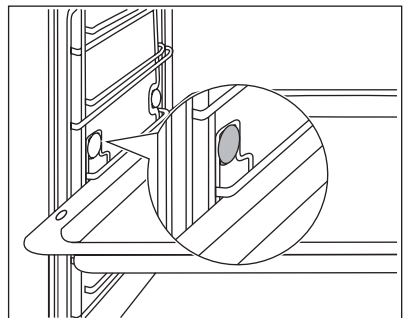

Inserting the wire shelf and the deep pan together

Put the wire shelf on the deep pan. Push the deep pan between the guide-bars of one of the shelf positions.

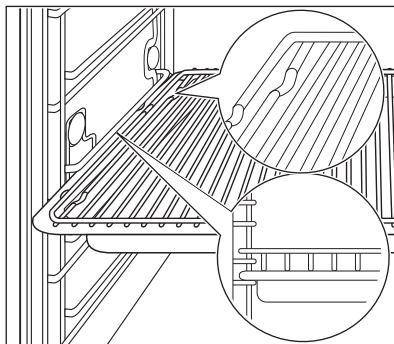

ADDITIONAL FUNCTIONS

Control Lock

The Control Lock prevents an accidental change of the oven function .

Activating the Control Lock

1. Activate the appliance.
2. Set the oven function.
3. Press  again and again until the display shows Control Lock
4. Press **OK** to confirm.

The Control Lock is active.

Deactivating the Control Lock

1. Press .
2. Press **OK** to confirm.

The Control Lock is not active.





If you deactivate the appliance, the Control Lock deactivates.



Child Lock

The Child Lock prevents an accidental operation of the appliance .

Activating the Child Lock

1. Activate the appliance.
2. Touch  and  at the same time at the same time until the display shows a message.



Deactivating the Child Lock

1. Press **OK** key.
2. Touch  and  at the same time until the display shows a message.

SET + GO

SET + GO function lets you set an oven function (or programme) and use it later with one press of the sensor field.

Activating the function:

1. Activate the appliance.
2. Set the heating function.
3. Press  again and again until the display shows Duration .
4. Set the time.
5. Press  again and again until the display shows SET + GO .
6. Press OK to confirm.

To start SET + GO press any sensor field (except ). The set oven function starts. When the oven function ends, an acoustic signal sounds.



When the oven function operates, the function Control Lock is on.



You can activate and deactivate the SET + GO function in the Basic Settings menu.

Automatic switch-off

For safety reasons the appliance deactivates automatically after some time:

- if an oven function operates.
- if you do not change the oven temperature.

Oven temperature	Switch-off time
30 °C -120 °C	12.5 h.
120 °C - 200 °C	8.5 h.
200 °C -230 °C	5.5 h.



The Automatic switch-off works with all oven functions, except Light , Core Temperature Sensor, Duration , End Time .

Cooling fan

When the appliance operates, the cooling fan activates automatically to keep the surfaces of the appliance cool. If you deactivate the appliance, the cooling fan can continue to operate until the appliance cools down.

HELPFUL HINTS AND TIPS

Inner side of door

In some models on the inner side of the oven door you can find:

- the numbers of the shelf levels (selected models)
- information about the oven functions, recommended shelf levels and temperatures for typical dishes (selected models).



The temperature and baking times in the tables are guidelines only. They depend on the recipes, quality and quantity of the ingredients used.

Information on acrylamides

Important! According to the newest scientific knowledge, if you brown food (specially the one which contains starch), acrylamides can pose a health risk. Thus, we recommend that you cook at the lowest temperatures and do not brown food too much.

CARE AND CLEANING



WARNING!

Refer to "Safety information" chapter.

Notes on cleaning:

- Clean the front of the appliance with a soft cloth with warm water and cleaning agent.
- To clean metal surfaces use a usual cleaning agent
- Clean the oven interior after each use. Thus you can remove dirt more easily and it does not burn on.
- Clean stubborn dirt with a special oven cleaner.
- Clean all oven accessories (with a soft cloth with warm water and cleaning agent) after each use and let them dry.
- If you have nonstick accessories, do not clean them using an aggressive agents, sharp edged objects or dishwasher. It can cause a damage to the nonstick coating.

Steam generation system



CAUTION!

Dry the steam generator after each use . Soak up water with the Sponge 150.



Remove a lime residue with water and vinegar.



CAUTION!

Chemical de-scaling agents can damage oven enamel. Obey instructions of the manufacturer!

Cleaning the Water Tank and the Steam Generator:

1. Fill the water and vinegar mixture (approximately 250 ml) through the water tank in the steam generator.
Wait for approximately 10 minutes.
2. Remove the water and vinegar with the Sponge 150.
3. Use clean water (100-200 ml) to flush the steam generation system through the water tank.
4. Remove water from the steam generator with the Sponge 150 and rub dry.
5. Keep the door open to let the appliance dry fully.

Steam Cleaning

1. Remove the worst of the residual dirt manually.
2. Pour 250ml of water with 3 tablespoons of vinegar into the steam generator.

3. Activate Steam Cleaning in the main menu. The process duration is shown in the display.
4. An acoustic signal sounds when the programme has finished. Press any button to switch the signal off.
5. Wipe out the oven with a soft cloth. Remove any residual water from the steam generator.
6. Leave the appliance door open for around 1 hour to completely dry the oven.

Shelf support

You can remove the shelf support to clean the side walls.

Removing the shelf support

1. Carefully pull the support up and out of the front catch.
2. Lightly move the support on the front catch inwards.
3. Pull the support out of the rear catch.

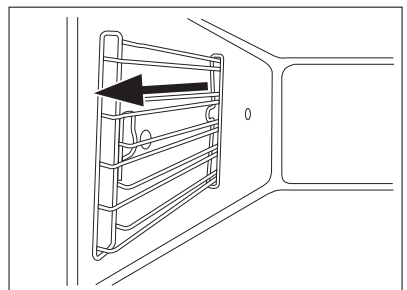
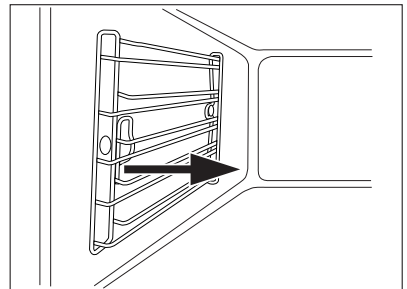
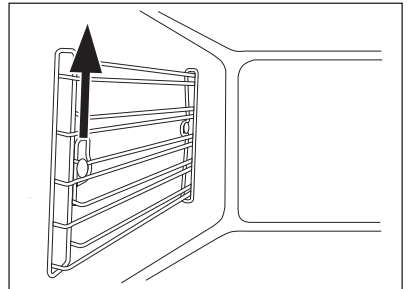

Installing the shelf support

Install the shelf support in the opposite sequence.

Oven door and glass panels

To clean the oven door, remove it.



CAUTION!

Be careful when you remove the door from the appliance. The door is heavy!

Removing the oven door

1. Open the oven door as far as it goes.
2. Fully press clamping levers (A) on the two door hinges.
3. Close the oven door until the first position (angle approximately 70°).
4. Hold of the oven door with one hand on each side and pull it away from the oven at an up angle.

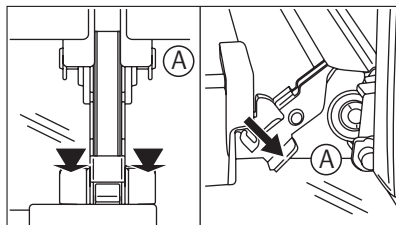

To install the door follow the procedure in reverse.



The number of glass panels is different for the different models.



CAUTION!

Put the oven door with the outer side down on a soft and level surface to prevent scratches.

Removing and cleaning the door glass panels

1. Remove the oven door.
2. Hold the door t (B) on the top edge of the door at the two sides and push inwards to release the clip seal.
3. Pull the door t to the front to remove it.

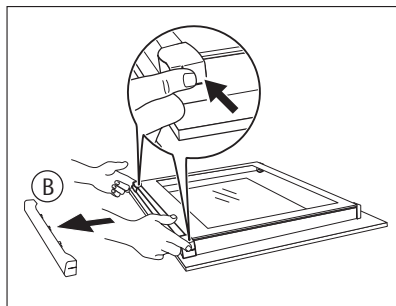

4. Hold the door glass panels on their top edge one by one and pull them up out of the guide
5. Clean the door glass panels.

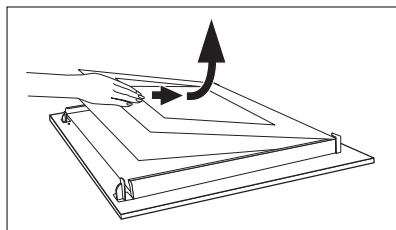

To install panels follow the procedure in reverse. Install the smaller panel first, then the larger.

Oven lamp



WARNING!

There is a risk of electrical shock.
Oven lamp and the lamp glass cover can be hot.

Before you change the oven lamp:

- Deactivate the appliance.
- Remove the fuses from the fuse box or deactivate the circuit breaker.



CAUTION!

Put a cloth on the bottom of the interior of the appliance. It prevents damage to the lamp glass cover and the cavity.

Replacing the oven lamp:

1. You can find the lamp glass cover at the cavity ceiling.
Turn the lamp glass cover counterclockwise to remove it.
2. Remove the metal ring and clean the glass cover.
3. If necessary, replace the oven lamp with applicable 300°C heat-resistant oven lamp.



Use the same oven lamp type.

4. Fit the metal ring to the glass cover.
5. Install the glass cover.

Replacing the oven lamp:

1. You can find the lamp glass cover at the left side of the cavity.
Remove the left shelf support.
2. Use a torx 20 screwdriver to remove the cover.
3. Remove and clean the metal frame and the seal.
4. Replace the oven lamp with applicable 300°C heat-resistant oven lamp.



Use the same oven lamp type.

5. Install metal frame and seal and tighten screws.
6. Install the left shelf support.

WHAT TO DO IF...



WARNING!

Refer to "Safety information" chapter.

Problem	Possible cause	Remedy
The oven does not heat up	The oven is switched off	Activate the oven

Problem	Possible cause	Remedy
The oven does not heat up	The clock is not set	Set the clock
The oven does not heat up	The necessary settings are not set	Check the settings
The oven does not heat up	The Child Lock is activated	Refer to "Deactivating the Child Lock"
The oven does not heat up	The fuse is released	Make sure, if the fuse is the cause for the malfunction. If the fuse releases again and again, refer to an authorized electrician
The display shows F111	The CT Sensor plug is not correctly installed into the socket	Put the plug of core temperature sensor as far as possible into the socket.
The oven lamp does not operate	The oven lamp is defective	Refer to "Replace the oven lamp"

If you cannot find a solution to the problem yourself, contact your dealer or the service centre.

The necessary data for the service centre is on the rating plate. The rating plate is on the front frame of the oven cavity.

We recommend that you write the data here:

Model (MOD.)

Product number (PNC)

Serial number (S.N.)



ENVIRONMENT CONCERNS

The symbol  on the product or on its packaging indicates that this product may not be treated as household waste. Instead it should be taken to the appropriate collection point for the recycling of electrical and electronic equipment. By ensuring this product is disposed of correctly, you will help prevent potential negative consequences for the environment and human health, which could otherwise be caused by inappropriate waste handling of this product. For more detailed information about recycling of this product, please contact your local council, your household waste disposal service or the shop where you purchased the product.



Packaging material

The packaging material is environmentally-friendly and recyclable. Plastic parts are marked with international abbreviations such as PE, PS, etc. Dispose of the packaging material in the containers provided for this purpose at your local waste management facility.

www.aeg-electrolux.com/shop

892945648-C-372010

