

**TOSHIBA Pocket PC e750/e755**

**User's Guide**

**TOSHIBA**

## Introduction

Thank you very much for your purchase of this Toshiba Pocket PC.

Please be sure to read this user's guide before using the Toshiba Pocket PC, and ensure that you are aware of correct the handling procedures.

- Please be sure to read the "Safety precautions" section in this document to learn about important safety issues.
- After reading this document, keep it in a convenient place for future reference.

## Copyright Information

© 2003 by Toshiba Corporation. All rights reserved. Under the copyright laws, this manual cannot be reproduced in any form without the prior written permission of Toshiba. No patent liability is assumed, with respect to the use of the information contained herein.

**Toshiba Pocket PC e750/e755 User's Guide**

**First edition March 2003**

## Trademarks

Microsoft, ActiveSync, Outlook, Pocket Outlook, Windows, Windows CE, and the Windows logo are either registered trademarks or trademarks of Microsoft Corporation in the United States and/or other countries. Microsoft products are licensed to OEMs by Microsoft Licensing, Inc., a wholly owned subsidiary of Microsoft Corporation.

## Safety precautions

- Please carefully read "Safety precautions" before using the Toshiba Pocket PC and ensure that you are aware of correct handling procedures.
- The precautions provide essential information for the protection of the user and others from possible injury and property damage. They also provide information on the safe handling of this product.
- Please check that you fully understand the definition of the following messages (signs and graphical symbols) before reading the text, and always follow the instructions provided.

## Safety instructions

Please carefully read "Safety precautions" before using the Toshiba Pocket PC and ensure that you are aware of correct handling procedures. The precautions provide essential information for the protection of the user and others from possible injury and property damage. They also provide information on the safe handling of this product. Please check that you fully understand the definition of the following messages (signs and graphical symbols) before reading the text, and always follow the instructions provided.

There are two categories of Safety Instructions included in this manual: Product Warnings, (i.e., what must never be done to assure avoiding those hazards that could cause bodily injury or property damage); and User Directions (i.e., what must always be done to assure the safe use of your Pocket PC).

The Safety Instructions contained in this manual have been categorized in accordance with the seriousness of the potential hazards through the use of Signal Words.

**Those Signal Words, and their intended meanings, are as follows:**

Signal Word	Meaning
<b>DANGER</b>	Indicates that a failure to observe the Safety Instructions could result in serious bodily injury.
<b>CAUTION</b>	Indicates that a failure to observe the Safety Instructions could result in minor bodily injury or property damage.
<b>WARNING</b>	Designates important information that relates to the safe use of your Pocket PC.

Your Pocket PC produces low levels of RF energy due to the generation of digital timing pulses by its clock oscillator circuits. Your Pocket PC has been equipped with internal shielding to minimize any stray emissions of RF energy.

Airlines may nevertheless prohibit the on-board use of all portable PCs (and all other portable electronic devices that could potentially emit stray RF energy), particularly during take-offs and landings, to prevent any possible interference with the reception of signals by airborne electronic navigational devices.

### **WARNING**

Always request and obtain prior consent and approval of an authorized airline representative before using your Pocket PC aboard an aircraft.

Always follow the instructions of the airline representative whenever using your Pocket PC aboard an aircraft, to prevent any possible interference with airborne electronic equipment.

## **WARNING**

Certain locations, such as hospitals, may restrict the use of Pocket PCs and other devices that emit low-level RF energy.

Always comply with posted prohibitions of the use of RF-emitting devices, such as in hospitals. Failure to follow such directives could result in the interference with medical equipment and/or devices.

Never come closer than 16cm (6inches) to a person with a heart pacemaker implant when using this Pocket PC in combination with a mobile cellular telephone. Failure to do so could result in interference with the function of the pacemaker.

## **WARNING**

Never use a Pocket PC while driving an automobile or any other moving vehicle. Always pull out of traffic and come to a stop in a legally permissible and safe location before using your Pocket PC. Failure to do so could result in serious bodily injury in a traffic accident.

Never use your Pocket PC while walking. Usage while walking could result in bodily injury caused by inattention to automobile traffic or other pedestrian hazards.

## **WARNING**

Never allow metallic objects, such as staples and paper clips, to enter inside your Pocket PC. Metallic objects, such as staples and paper clips, if allowed to enter your Pocket PC, could cause the generation of excess heat or fire.

Never connect terminals (metal parts) to metallic objects (such as wires). Connecting terminals to metal objects could cause excessive heat or fire.

Always immediately turn the battery switch to the "off" position and disconnect the AC Adaptor from the power outlet in the event the Pocket PC emits an unusual odor or sound or generates smoke.

## **WARNING**

Never use or store your Pocket PC in the following locations:

Anywhere it may be exposed to water, such as a bathroom or sauna;

In conditions of high humidity, such as in the rain or fog; Where your Pocket PC will be exposed to high temperatures, such as near a fire or equipment that emits high temperatures; In direct sunlight; or In a sealed automobile left in the sun and subject to high temperatures.

Never drop your Pocket PC or subject it to severe shock. Dropping your Pocket PC or subjecting it to severe shock could cause the removable battery to leak, ignite and/or rupture.

Always immediately remove your Pocket PC and its battery from the vicinity of any open flame in the event the removable battery leaks liquid or emits an unusual odor. Continued use of your Pocket PC under either of these conditions could cause ignition (i.e., fire) of the leaked battery liquid, or rupture.

Never touch any fluid that might leak from the removable battery. Such liquid when in contact with the eyes or skin, could cause injury to the skin or eyes. Should the liquid come into contact with the eyes, irrigate the eyes thoroughly with clean water and immediately seek medical attention. In the event the liquid comes into contact with the skin or clothing, wash it away immediately with clean water.

Never attempt to disassemble, repair or make any modification to your Pocket PC. Disassembly, modification or any attempt at repair could cause bodily injury or property damage, as well as damage to the Pocket PC itself.

Failure to follow the above directions concerning use and storage could result in damage to your Pocket PC or bodily injury and property damage due to battery liquid leakage, fire or rupture.

## **CAUTION**

Never raise the sound volume level to high when using your Pocket PC with earphones. An excessive sound volume level could cause damage to your hearing.

Never touch the liquid that might leak from a broken liquid crystal display. Contact with this liquid could cause a skin rash. If the crystal display liquid should come into contact with the skin or clothing, wash it immediately with clean water.

Never allow infants or small children within reach of your Pocket PC. Infants or small children could injure themselves if allowed access to your Pocket PC.

## **DANGER**

Never attempt to disassemble or repair an AC Adaptor, and never alter their Power Supply Cables or plugs as exposure to electric shock hazards could result.

Always contact an authorized service provider, if repair or replacement is required.

## **WARNING**

Always use the AC Adaptor that has been provided with your Pocket PC.

Bodily injury or property damage could occur as a result of the use of an unauthorized and incompatible AC Adaptor in violation of this Warning.

Never connect or disconnect the AC Adaptor with wet hands. Connecting or disconnecting the AC Adaptor to a power source with wet hands could cause electric shock.

## **CAUTION**

Never place an AC Adaptor on a wooden surface (or any other surface that could be marred by exposure to heat) while it is in use, since its surface temperature increases during normal use. Always rest it on a suitable heat-insulating material.

Never cover the AC Adaptor with any object while it is in use, and never place it adjacent to a heat source. An excessive temperature increase could detrimentally affect its performance.

Never place a Power Supply Cable near a heat source, as damage to the cord or to its insulation could result.

Always use a surge protector when utilizing the AC Adaptor during an electrical storm. Otherwise, a power surge could result in the loss of stored data.

Insert the power plug to a household electric outlet.

When travelling abroad, never plug the AC Adaptor into a power source that does not correspond to both the voltage and the frequency specified on the rating plate of the unit, as equipment damage will result.

Never attempt to connect or disconnect the power plug with damp or wet hands. Connecting or disconnecting the power plug with damp or wet hands could result in an electric shock.

Never leave an open container, such as a cup or glass, containing a liquid near the AC Adaptor. Spilled liquid coming in contact with the AC Adaptor could cause a fire or electric shock.

Always ensure the power plug pins are clean and free of dust or other foreign material by wiping the pins with a clean dry cloth. Dust or other foreign material accumulation on the power plug pins could cause fire.

Always unplug the power plug from an outlet by grasping the power plug itself. Never pull on the Power Supply Cable to disconnect the Power Supply Cable from an outlet. Pulling on the Power Supply Cable could cause a fire or electric shock as a result of damage to the Power Supply Cable.

Never use a worn or damaged AC Adaptor Power Supply Cable or plug, or a worn or damaged extension cord or plug. The use of a worn or damaged Power Supply Cable or plug could result in electric shock or fire. Always contact an authorized service provider immediately to obtain a suitable Power Supply Cable replacement.

Never bend or twist a Power Supply Cable, and never pull on a Power Supply Cable in an attempt to remove a plug from an outlet. Always grasp the plug directly when unplugging a Power Supply Cable to avoid causing any damage to the cord.

Never plug the AC Adaptor into an overloaded multiple outlet, power strip or surge protector to prevent blowing a fuse or tripping a circuit breaker.

Never place heavy objects on a Power Supply Cable, as that could result in damage to the cord.

**Always confirm that the AC Adaptor plug (and the extension cord and plug, if any) have been fully inserted into the receptacle, to assure a secure electrical connection.**

## NOTE

Under certain conditions, data may be lost, including:

Misuse of your Pocket PC; Subjecting the main unit of your Pocket PC to static electricity and/or noise; Total loss of electric charge in the removable battery; and Servicing of your Pocket PC.

Use your Pocket PC only in locations with the following ambient environmental conditions:

Under normal operational use with temperatures between 0°C and 40°C (32°F and 104°F); With humidity of 30% to 80%; and When charging the battery with temperatures between 5°C and 40°C (41°F and 104°F).

Do not store or use your Pocket PC in the following locations:

Those subject to extremely high or low temperatures; Dusty locations; and Locations or sites subject to strong vibration.

Use or storage in these location, sites or areas can result in product failure, malfunction or loss of data.

Do not subject your Pocket PC to sudden and severe temperature changes. This could result in moisture condensation in the Pocket PC that could cause damage to your Pocket PC, computer function loss, and/or the loss of data. In the event of moisture condensation, allow your Pocket PC to dry out completely.

It is normal for the AC Adaptor to become warm when charging.

Disconnect the power plug from the outlet when not in use.

Take care not to sit on your Pocket PC when it is located in the back pocket of trousers, etc. This could cause damage to your Pocket PC or malfunction of the Pocket PC functions.

Do not place objects on top of your Pocket PC or drop them on top of your Pocket PC. This could cause damage to your Pocket PC and/or malfunction.

Clean terminals (metallic parts) on a regular basis with a cotton swab. Dirty terminals could affect battery charging.

Never use organic solvents such as benzene or paint thinner to clean your Pocket PC. Use of these solvents can cause deformation or discoloration.

Do not wipe the display with a damp or wet cloth or touch the display with damp or wet hands. Wiping or touching the display under this condition can cause product failure or malfunction. Always use a soft dry cloth to wipe the display.

**When using the “SD memory card” and/or “(CF) compact flash card,” be sure to read the relevant instruction manual and ensure that you know the proper procedures for their use.**

Never subject the card to any severe shock while connected to your Pocket PC. Such a shock can cause damage to the card and a malfunction.

Do not carry your Pocket PC with the card connected to it. This can result in the damage or loss of the card.

Never connect cradle terminals with metallic objects, such as wires. Connecting these terminals with metallic objects may cause the production of excess heat, burns and damage to the charger and/or your Pocket PC.

Lithium ion batteries are recyclable. Never dispose of the battery with ordinary waste.



Supplementary Information:	“The product complies with the requirements of the Low Voltage Directive 73/23/EEC and the EMC Directive 89/336/EEC.”
Weitere Informationen:	“Das Produkt entspricht den Anforderungen der Niederspannungs-Richtlinie 73/23/EG und der EMC-Richtlinie 89/336/EG.”
Informations complémentaires:	“Ce produit est conforme aux exigences de la directive sur les basses tensions 73/23/CEE et de la directive EMC 89/336/CEE.”
Información complementaria:	“El Producto cumple los requisitos de baja tensión de la Directiva 73/23/CEE y la Directiva EMC 89/336/CEE.”
Ulteriori informazioni:	“Il prodotto é conforme ai requisiti della direttiva sulla bassa tensione 73/23/EG e la direttiva EMC 89/336/EG.”
Ytteligare information:	“Produkten uppfyller kraven enligt lägsäpänningsdirektiver 73/23/EEC och EMC-direktiv 89/336/EEC.”

## Working environment

This product was designed to fulfill the EMC (electromagnetic compatibility) requirements for “residential, commercial and light industry environments”.

Toshiba does not approve the use of this product in working environments other than “residential, commercial and light industry environments”.

For example, the following environments are not approved:

- Industrial Environments (environments with a main voltage >230V~)
- Medical Environments
- Automotive Environments
- Aircraft Environments

Any consequences resulting from the use of this product in working environments that are not approved are not the responsibility of Toshiba Corporation.

The consequences of the use of this product in non-approved working environments may be:

- Interference with other devices or machines in the nearby surrounding area
- Malfunction of, or data loss from, this product caused by disturbances generated by other devices or machines in the nearby surrounding area

Therefore Toshiba strongly recommends that the electromagnetic compatibility of this product be suitably tested in all non-approved working environments before use. In the case of automobiles or aircraft, the manufacturer or airline respectively should be asked for permission before use of this product.

Furthermore, for general safety reasons, the use of this product in environments with explosive atmospheres is not permitted.

## CE compliance

This product and the original options are designed to observe the related EMC (Electromagnetic compatibility) and safety standards. However, Toshiba cannot guarantee that this product still observes these EMC standards if options or cables not produced by Toshiba are connected or implemented. In this case the persons who have connected / implemented those options / cables have to make sure that the system (PC plus options / cables) still fulfils the required standards. To avoid general EMC problems, the following advice should be observed:

- Only CE marked options should be connected / implemented
- Only best shielded cables should be connected

## FCC Notice

### “Declaration of Conformity”

This equipment has been tested and found to comply with the limits for a Class B digital device, pursuant to part 15 of the FCC Rules. These limits are designed to provide reasonable protection against harmful interference in a residential installation. This equipment generates, uses and can radiate radio frequency energy and, if not installed and used in accordance with the instructions, may cause harmful interference to radio communications. However, there is no guarantee that interference will not occur in a particular installation. If this equipment does cause harmful interference to radio or television reception, which can be determined by turning the equipment off and on, the user is encouraged to try to correct the interference by one or more of the following measures:

- Reorient or relocate the receiving antenna.
- Increase the separation between the equipment and receiver.
- Connect the equipment into an outlet on a circuit different from that to which the receiver is connected.
- Consult the dealer or an experienced radio/TV technician for help.



**WARNING:** Only peripherals complying with the FCC class B limits may be attached to this equipment. Operation with non-compliant peripherals or peripherals not recommended by Toshiba is likely to result in interference to radio and TV reception. Shielded cables must be used between the external devices and the computer's USB ports, external monitor port, PS/2 keyboard port and PS/2 mouse port. Changes or modifications made to this equipment, not expressly approved by Toshiba or parties authorized by Toshiba could void the user's authority to operate the equipment.

This device complies with part 15 of the FCC Rules. Operation is subject to the following two conditions:

1. This device may not cause harmful interference
2. This device must accept any interference received, including interference that may cause undesired operation.

## **Canadian Regulatory Information (Canada Only)**

This digital apparatus does not exceed the Class B limits for radio noise emissions from digital apparatus as set out in the Radio Interference Regulation of the Canadian Department of Communications.

Note that Canadian Department of Communications (DOC) regulations provide, that changes or modifications not expressly approved by TOSHIBA Corporation could void your authority to operate this equipment.

This Class B digital apparatus meets all requirements of the Canadian Interference-Causing Equipment Regulations.

Cet appareil numérique de la class B respecte toutes les exigences du Règlement sur le matériel brouilleur du Canada.

### **BSMI Notice (Taiwan Only)**

警告使用者：這是 A 類的資訊產品，在開放的環境中使用時，可能會造成無線電干擾，在這種情形下，使用者會被要求採取某些適當的對策。

## **(VCCI graphic here, p12 of E740)**

### **VCCI Notice (Japan Only) Class BITE**

The paragraph below in English should be translated into Japanese here. (see pg. 12 of E740 u. manual for Japanese text.)

This is a Class B product based on the standard of the Voluntary Control Council for Interference (VCCI) for information technology equipment. If this equipment is used near a radio or television receiver in a domestic environment, it may cause radio interference. Install and use the equipment according to the instruction manual.

## **FCC Class B Digital Devices & Peripheral Devices (Declaration of Conformity or Certification Authorization)**

### **Declaration of Conformity Label & Marking Requirements**

- User Manual must provide user information in accordance with  $\pm$ 15.19(a)(3), 15.21, 15.27 and 15.105(b):

### **Instruction Manual Federal Communication Commission Interference Statement**

This equipment has been tested and found to comply with the limits for a Class B digital device, pursuant to Part 15 of the FCC Rules. These limits are designed to provide reasonable protection against harmful interference in a residential installation. This equipment generates, uses and can radiate radio frequency energy and, if not installed and used in accordance with the instructions, may cause harmful interference to radio communications.

However, there is no guarantee that interference will not occur in a particular installation. If this equipment does cause harmful interference to radio or television reception, which can be determined by turning the equipment off and on, the user is encouraged to try to correct the interference by one of the following measures:

- Reorient or relocate the receiving antenna.
- Increase the separation between the equipment and receiver.
- Connect the equipment into an outlet on a circuit different from that to which the receiver is connected.
- Consult the dealer or an experienced radio/TV technician for help.

FCC Caution: Assure continued compliance (for example, use only shielded interface cables when connecting to computer or peripheral devices). Any changes or modifications not expressly approved by the manufacturer of this device could void the user's authority to operate this equipment.

This device complies with Part 15 of the FCC Rules. Operation is subject to the following two conditions: (1) This device may not cause harmful interference, and (2) this device must accept any interference received, including interference that may cause undesired operation.

Responsible Party: Toshiba America Information Systems, Inc.

9740 Irvine Blvd.

Irvine, CA 92618-1697

Telephone No: 1-800-Toshiba

## Table of Contents

COPYRIGHT INFORMATION .....
TABLE OF CONTENTS .....
CHAPTER 1: GETTING STARTED .....
CHAPTER 2: BASIC SKILLS .....
CHAPTER 3: MICROSOFT ACTIVESYNC .....
CHAPTER 4: MICROSOFT POCKET OUTLOOK .....
CHAPTER 5: COMPANION PROGRAMS .....
CHAPTER 6: POCKET INTERNET EXPLORER .....
CHAPTER 7: GETTING CONNECTED .....
CHAPTER 8: IEEE 802.11B WLAN .....
CHAPTER 9: OPTIONAL FUNCTIONS .....
CHAPTER 10: ADDITIONAL INFORMATION .....

# Getting Started

## Welcome

Congratulations on purchasing your Toshiba Pocket PC. Due to the size and capabilities of this device, you can keep your most important business and personal information up-to-date and close at hand. Microsoft® ActiveSync® increases the power of your device by allowing you to synchronize the information on your desktop or laptop computer with your device. Picture yourself in the following situations:

- While walking with a colleague, your cell phone rings and your manager asks if you two are free this afternoon for an emergency meeting. While your colleague fumbles through his paper organizer, you press a button on your device and instantly see a list of today's appointments and meetings. You are quickly able to tell your manager your available times. For more information on scheduling appointments and meetings, see Chapter 4.
- You're meeting your friends tonight for dinner and a movie. You download the latest movie information from the Internet to your computer and then synchronize it with your device. At dinner, you pull out your Toshiba Pocket PC device and review your movie options with your friends. For more information on downloading Web pages to your device, see Chapter 6.
- A Calendar reminder alerts you that it is time to catch the bus. You grab your Toshiba Pocket PC device and catch the bus just in time. Because ActiveSync keeps the information on your device up-to-date, you leisurely review your task list, make notes about the new books and CDs you want to buy, and read and respond to e-mail messages. When you get back to the office, ActiveSync transfers any task changes you made, your notes, and your e-mail message responses to your computer. For more information on ActiveSync, see Chapter 3.

## Where to Find Information

This book describes your Pocket PC hardware, provides an overview of the programs on your Pocket PC, and explains how to connect your Pocket PC to a desktop computer, a network, or the Internet. For instructions on setting up your Pocket PC and installing ActiveSync, see information to help you use your Pocket PC.

<b>For information on:</b>	<b>See this source:</b>
Programs on your Pocket PC	This User's Guide and device Help To view Help, tap  and then Help.
Additional programs that can be installed on the Pocket PC	The Pocket PC Companion CD.
Connecting to and synchronizing with a computer	The Quick Start Card or Active Sync Help on your computer. To view Help, click Help and then Microsoft Active Sync Help.
Last-minute updates and detailed technical information	The Read Me files, located in the Microsoft Active Sync folder on the desktop computer and on the Pocket PC Companion CD.
Up-to-date information on your Toshiba Pocket PC	<a href="http://www.pda.toshiba.com">http://www.pda.toshiba.com</a>



Chapter 2:

# Basic Skills

You can easily learn to use your Toshiba Pocket PC e750/e755. This chapter describes the use and customization of your Toshiba Pocket PC e750/e755.

## Parts Names and Function



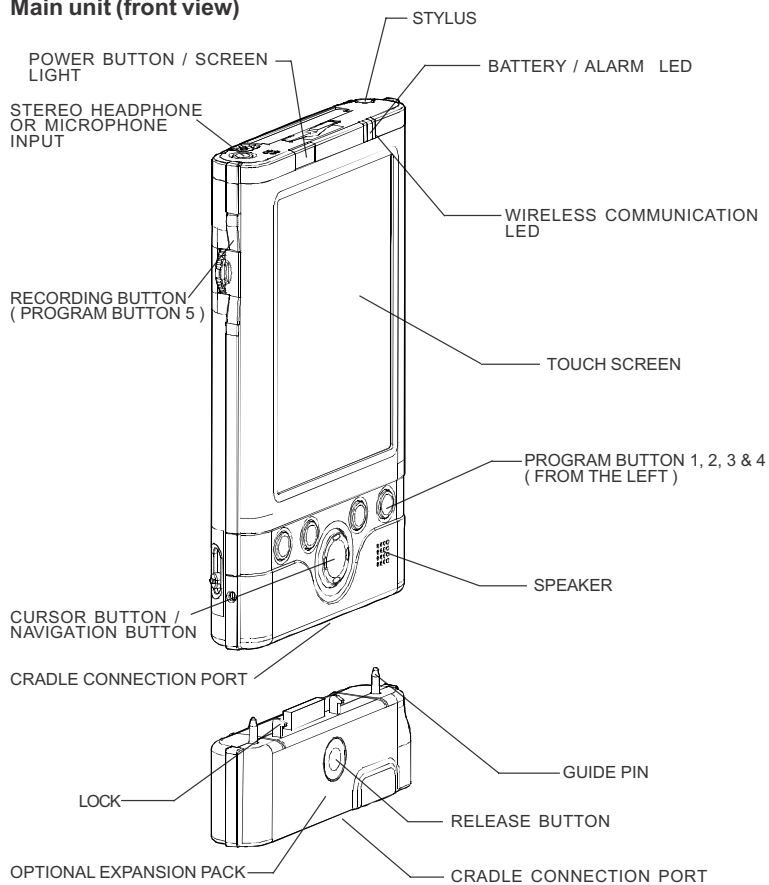

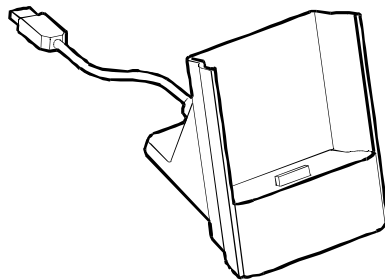
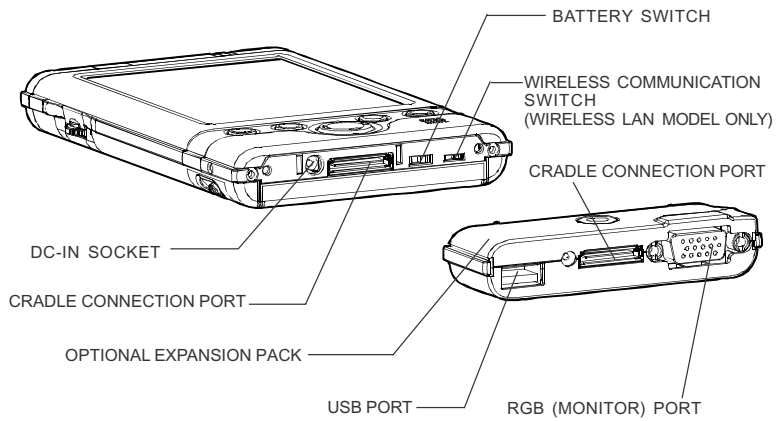
### Main unit (front view)





## Cradle

### Initial Setting of Program Button

- Program button 1 = Calendar 
- Program button 2 = Tasks 
- Program button 3 = Home 
- Program button 4 = Contacts 
- Program button 5 = Voice recorder

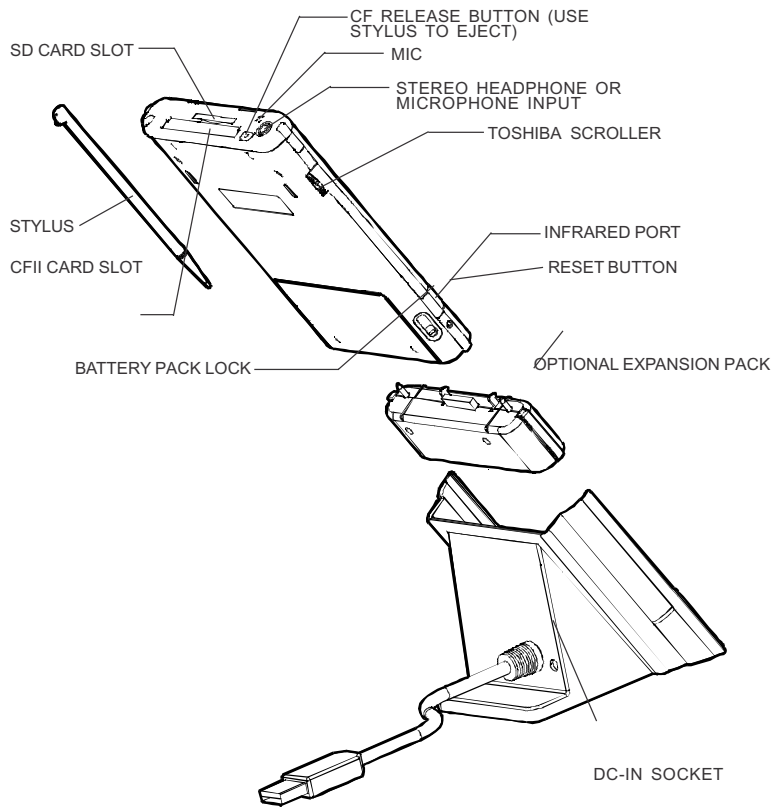

**Main unit ( back view )**

**Power Button**

The power button turns the unit and the screen light on and off.

Power button	When the power is off	When the power is on
Press and hold.	The power turns on.	The screen light alternately turns on/off.
Press it quickly.	The power turns on.	The power turns off.

### Battery Switch

The battery switch supplies/cuts off the battery power to the Toshiba Pocket PC e750/e755.

The setting of this switch at shipment is "stop". When using the Toshiba Pocket PC e750/e755 for the first time, slide this switch to the left (the "supply" side) with the stylus.



Switching the battery switch to the "stop" position at any time will lead to loss of data.

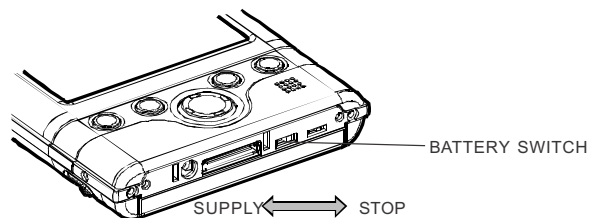

### Battery/Alarm LED

The Battery/Alarm LED indicates the machine condition.

<b>Flashing orange</b>	When the preset alarm time, which was set through <b>Calendar</b> or <b>Tasks</b> , goes off, the lamp starts flashing.
<b>Orange</b>	Indicates charging of the battery.
<b>Yellow</b>	The battery charging process is stopped due to the ambient temperature being too high or low. Charge the battery in an ambient temperature of approx. 41°F to 104°F.
<b>Green</b>	Indicates full charge of the battery.

### Wireless Communication Switch ( Wireless LAN model only )

1. To enable Wireless module, make sure the Wireless Communication Switch is turned on. (The default setting is Power Off. Press the switch to the left to turn the power on.)
2. Wireless LAN model only: If this is your first time turning on the switch, the IP Address Page will pop up for you to set the IP address, Subnet mask and Default gateway.

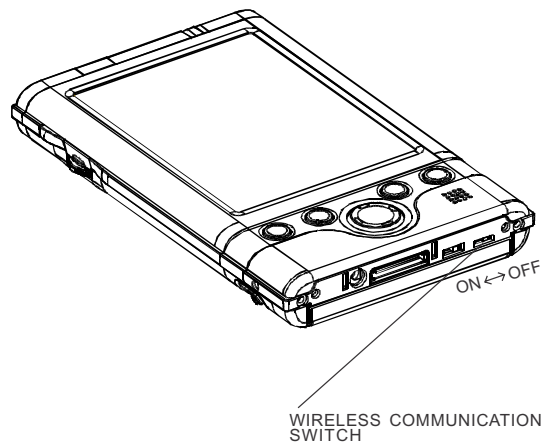

### LED Descriptions

LED indicates the different status:

LED	Status
Off	Wireless Communication Switch is turned OFF
Orange	Wireless Communication Switch is turned ON

### How to Use the Stylus

The stylus is used for menu selection or data input on the touch-screen of the Toshiba Pocket PC e750/e755.

- **Tap:** Touch the screen once with the stylus to open items and select options.
- **Drag:** Hold the stylus on the screen and drag it across to select text and images. Drag in a list to select multiple items.
- **Tap and hold:** Tap and hold the stylus on an item to see a list of actions available for that item. On the pop-up menu that appears, tap the action you want to perform.



*When you operate the touch screen of the Toshiba Pocket PC e750/e755, use the supplied stylus.*

*If the tip of the stylus is damaged, do not use it. If you operate the touch screen with a damaged stylus or a ballpoint pen, the touch screen may be damaged.*

*When the stylus is damaged, please purchase a new one.*

### About the Cursor Button

You can move a cursor (selection display) on the screen by pressing the upper, lower, right or left part of the cursor button.

You can select a program to launch by pressing the center part of the cursor button.



*The cursor movement is different depending on the screen. When the cursor is at the right or the left side of the screen, it may not move.*

### About the Scroller

You can also move the cursor on the screen by moving the scroller up and down.

You can select a program to launch by pressing the scroller.

## Battery Charging

When using the Toshiba Pocket PC e750/e755 for the first time, set the battery switch to the supply side, and then charge the removable battery with the supplied AC adapter.

### How to Charge the Battery

You can use two charging methods.



*Turn the unit off before connecting the AC Adapter and Pocket PC.*

Method1.: Connect the supplied AC adapter and the cradle as shown in the figure below, and then insert the Toshiba Pocket PC e750/e755 into the cradle.

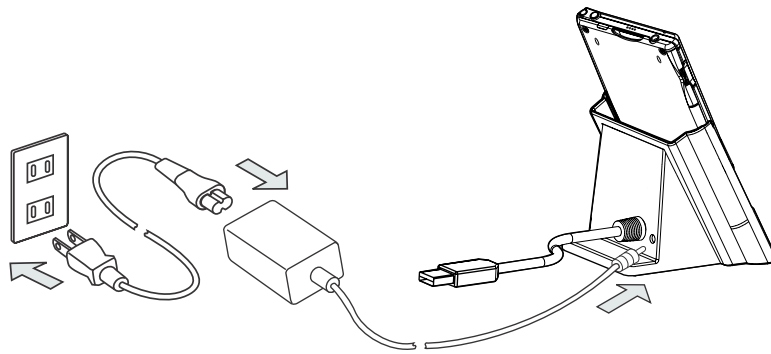

Method 2 :Connect the supplied AC adapter and the Toshiba Pocket PC e750/e755 as shown in the figure below.

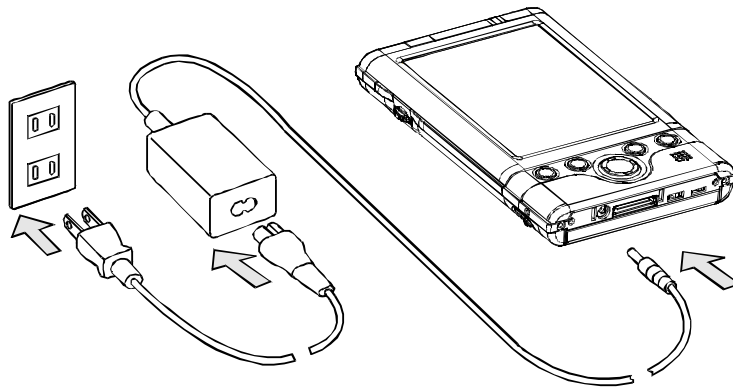

For charging the battery, maintain an ambient temperature from approx. 41°F to 104°F.

When the lamp is lit in orange during the battery charging, you can use the Toshiba Pocket PC e750/e755.

When the battery is completely charged, the LED alarm lamp color will change to green.



## How to Attach / Detach Main Battery Pack

1. Turn off the power.
2. Switch Battery Pack Lock to release the battery pack.
3. Attach / Detach battery from the Pocket PC.

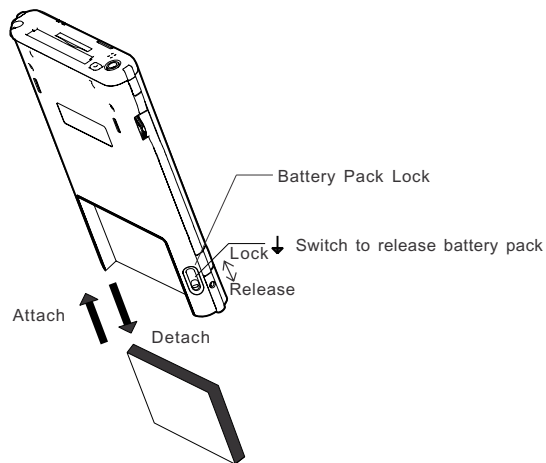

 You cannot turn on the power if Battery Pack Lock is at the Release side.

 You can change the main battery without data loss because Toshiba Pocket PC e750/e755 has the rechargeable backup battery. But the capacity of the backup battery is small. When you change the main battery, please attach the new main battery and switch the Battery Pack Lock to the lock side as soon as possible.

### How to Prolong Battery Life

- Use the Toshiba Pocket PC e750/e755 with the AC adapter.  
When you use the Toshiba Pocket PC e750/e755 under the following conditions, the power consumption will be high. Please use the AC adapter when:
  - The Toshiba Pocket PC e750/e755 is operated while connected to your computer.
  - The Toshiba Pocket PC e750/e755 is operated with storage card or with any other optional equipment.
  - Select the short power-off time in the setting menu. This will shorten the time the unit will remain on if not used. For more information, see “Customize Your Toshiba Pocket PC e750/e755” in Chapter 2-35.
  - Turn off the front light.
  - Set the screen brightness to power saving mode. Also shorten the light turn-off time. For more information, see “Customize Your Toshiba Pocket PC e750/e755” in Chapter 2-35.
  - Use the Toshiba Pocket PC e750/e755 with an ambient temperature between 59°F and 77°F. This temperature range is the most effective for the battery.
  - When you use the Toshiba Pocket PC e750/e755 in high or low temperature environments, the operable time is shortened due to the decrease of the battery capacity.
  - You can save power if wireless communication module is off.

### Battery Life

The removable battery has a limited life. Repeated charging/discharging of the battery gradually decreases operable time. When the operable time has been extremely shortened, it is time to replace the removable battery with a new one.

- Do not leave the Toshiba Pocket PC e750/e755 in a place of high or low temperature. It may shorten battery life.



*If you have not used the Toshiba Pocket PC e750/e755 for several days, its battery charge level reading may be inaccurate. Fully recharge the battery before using.*

### **Battery Charge Level and Stored Data Protection**

If the battery charge level becomes extremely low, or is completely discharged, the memory data stored in the Toshiba Pocket PC e750/e755 could be lost.

When the low battery status icon or the alarm message appears, immediately connect the AC adapter to the Toshiba Pocket PC e750/e755 and charge the battery.

- The removable battery gradually discharges even if the device is not being used. When the Toshiba Pocket PC e750/e755 is left for a long time, the removable battery of the Toshiba Pocket PC e750/e755 may completely discharge.
- It is recommended to save the Toshiba Pocket PC e750/e755's memory data to your computer or to a storage card.
- The manufacturer is not responsible for data change or clearance due to battery discharge. Please acknowledge that.

## How to Use the Optional Expansion Pack

You can use the Optional Toshiba Expansion Pack (see 2-2) together with the Toshiba Pocket PC e750/e755 to additional peripherals.

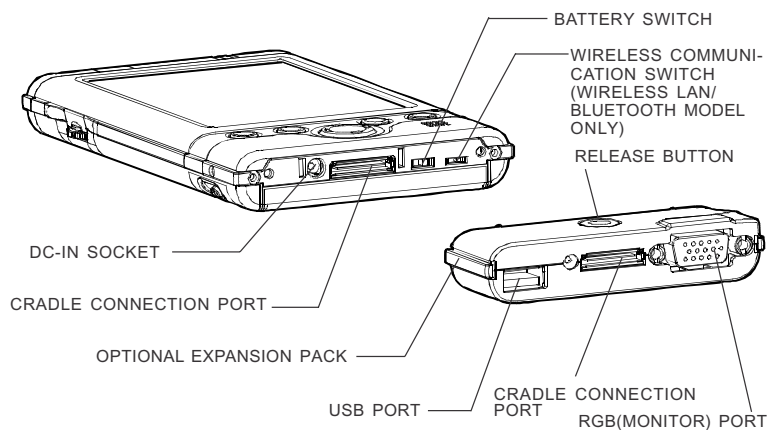

### Parts and Functions of the Expansion Pack

**Cradle Connection Port:** The **Cradle Connection Port** allows you to connect the Expansion Pack to the Cradle.

**RGB (Monitor) Port:** The **RGB (Monitor) Port** is a standard 15-pin RGB port for connecting an external display device such as a monitor or projector.

 Only IA-Presenter and IA Screen Mirror (see page 10-18) can output the image to the external monitor. Other applications cannot output the image to the external monitor.

**USB Port:** The **USB Port** allows you to connect USB keyboard to the Pocket PC.

 Use only a Microsoft Pocket PC compatible keyboard.

**Release Button:** When being pressed, the **Release Button** releases the Expansion Pack from the Toshiba Pocket PC e750/e755.

Connecting the Expansion Pack to the Pocket PC

1. Plug the **Guide Pins** into the corresponding jacks on the Toshiba Pocket PC e750/e755.

2. The locks will give a light click when the Expansion Pack is in place.



*The locks are based on foolproof design to help you connect the Expansion Pack to the Pocket PC with the right face-up, i.e. the face with the **Release Button**.*

Releasing the Expansion Pack from the Pocket PC

Press the **Release Button** on the Expansion Pack and gently remove the Pack from the Toshiba Pocket PC e750/e755.

## How to use the Optional USB Host Cable

The optional USB Host Cable allows you to connect a USB keyboard to the Pocket PC.

### To connect a USB keyboard to the Pocket PC:

1. Turn off the power.
2. Plug the optional USB Host Cable to the Pocket PC.
3. Connect a USB keyboard to the USB Port of the optional USB Host Cable.

 *Charging the battery or connect AC adapter if the battery power is low. You cannot use a USB keyboard if the battery power is less than 15%.*

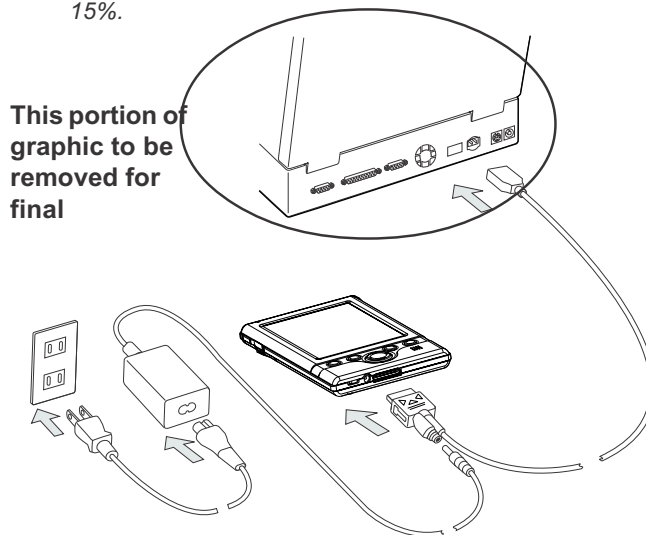

 *Use only a Microsoft Pocket PC compatible keyboard.*

## Initial Setup

When using the Toshiba Pocket PC e750/e755 for the first time, carry out initial setup according to the procedures below after a battery has been charged.

1. Move the battery switch to the "supply" position. The Toshiba Pocket PC e750/e755 powers on automatically and the Welcome screen appears. Tap the screen to start the following setup.

2. Execute touch screen correction.

When the align screen appears, tap the center of the cross target with the stylus. The next target position changes upon tapping the target. Five taps completes the positioning correction. The screen then changes to the Stylus screen.

- If a finger or any other object touches the screen during correction, the correction will be cancelled. Repeat the correction procedure.

3. Read how to use the stylus.

- Read and understand the stylus operation, and then tap **NEXT**.



*For more information on stylus operation, see "How to Use the Stylus" in Chapter 2-5.*

4. Learn the pop-up menu operation.

- Read the on-screen explanation and then follow the instructions. Display the pop-up menu, and cut and paste the data according to the screen instructions.

- After you finish the paste operation, this stage is completed. Tap **NEXT**.

5. Set the TIME ZONE.

- When tapping the right ▼ mark, the city and the time zone lists appear. Tap the desired city and time zone.

- When the setup is completed, tap **NEXT**.

6. To complete the initial setup.

- When the Complete screen appears, the initial setup is completed.

- After tapping the screen, you can use the Toshiba Pocket PC e750/e755.



*When you tap the Complete screen, the Today screen appears. For more information on the Today screen, see "Today screen" in Chapter 2-19.*

## Inserting a CF II Card

1. Turn off the power.
2. Remove the dummy card.
3. Insert the CF II Card.

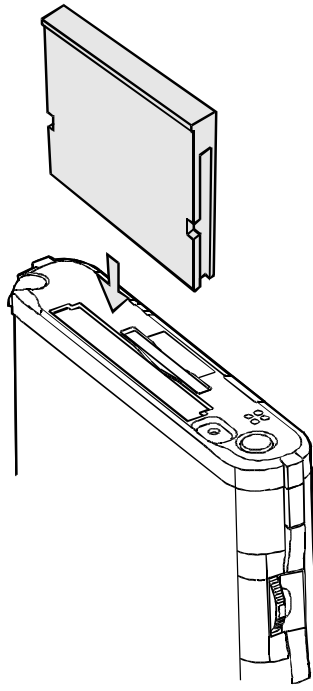



**To remove a card:**

1. Turn off the power.
2. Lightly press down the release button with the stylus. The button will pop out. Press down on the release button again. The card will withdraw slightly from the slot.
3. Pull the card straight up to remove.

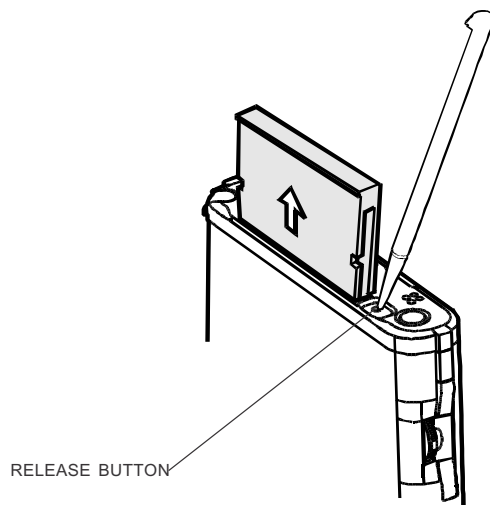

*Use stylus to release the CF card.*

### Inserting an SD Card

1. Turn off the power.
2. Remove the dummy card.
3. Insert the card with its contact surface (metal contact surface) facing the back of the Toshiba Pocket PC e750/e755.
4. Press down until it clicks.

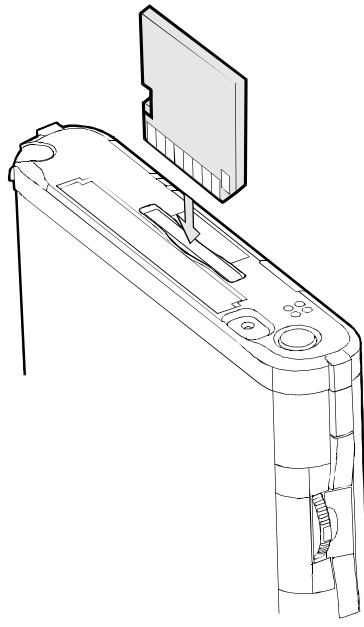

**To remove a card:**

1. Turn off the power.
2. Lightly press down the card until a clicking sound is heard. The card will pop out slightly from the slot.
3. Pull the card straight up to remove.

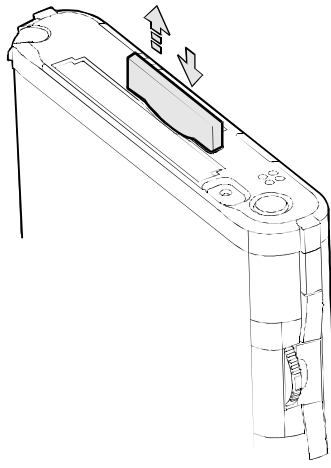

**G** When storage cards are inserted in both the CF and SD card slots, one of them may only be accessible depending on the application or the Settings operation (typically, the first storage card inserted is accessed).

Typical examples:

- Notes of Pocket Outlook.
- Saving the destination selection of the Options item of the Tools menu of Pocket Word.

### Connecting to a Computer

Before connecting your Toshiba Pocket PC e750/e755 to a computer, check the following.

- ActiveSync has been installed on your computer. (See Chapter 3.)
- The position of connecting port on the computer may differ according to the computer type.

#### To Connect Using The Supplied Cradle:

1. Connect the USB cradle to your computer as shown in the illustration below.

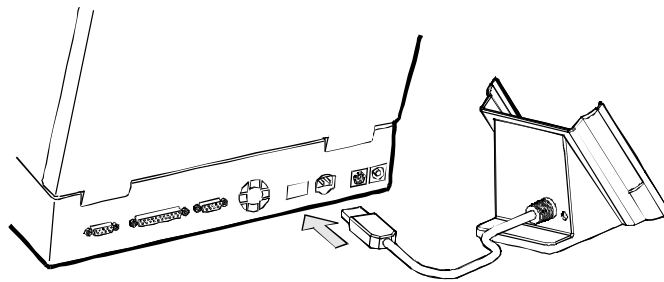

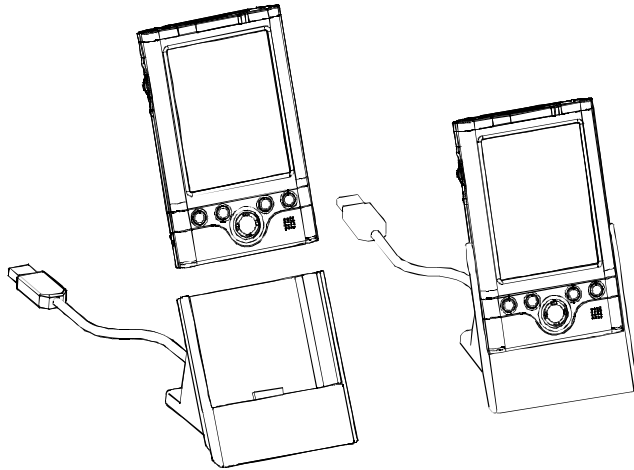

2. Insert the Pocket PC into the cradle.

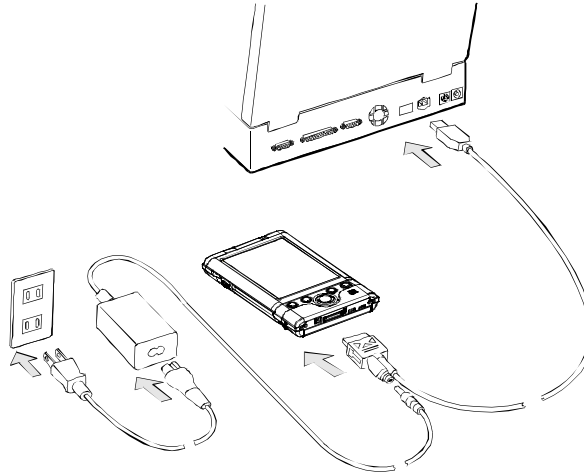

**To connect directly using a connection cable:**

Connect the Toshiba Pocket PC e750/e755 directly to your computer using an optional USB Sync Cable.









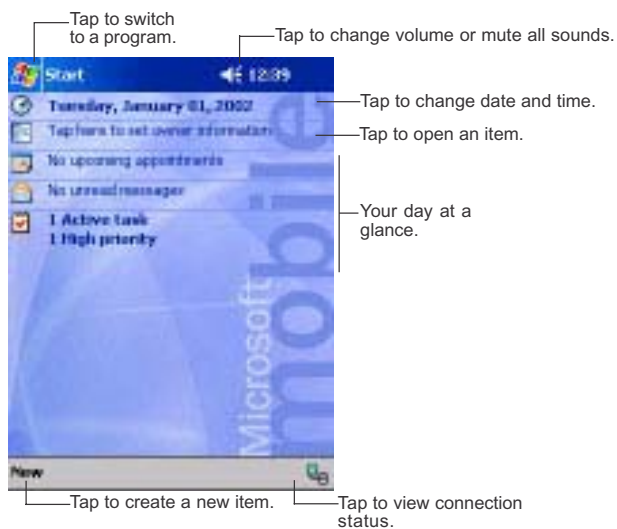





 When the Toshiba Pocket PC e750/e755 is connected to another device via a USB Sync Cable do not plug the AC adapter directly into the Pocket PC as this may lead to interference. Instead, plug the AC adapter into the port on the USB Client cable connector.



## Today Screen

When you turn on your device for the first time each day (or after 4 hours of inactivity), you'll see the Today screen. You can also display it by tapping  and then **Today**. On the Today screen, you can see at a glance important information for the day.





Following are some of the status icons you may see.

Status Icon	Meaning
	Turns all sounds on and off
	Backup battery is low
	Main battery is charging
	Main battery is low
	Main battery is very low
	Main battery is full
	Connection is active
	Synchronization is beginning or ending
	Synchronization is occurring
	Notification that one or more instant messages were received
	Notification that one or more e-mail messages were received
	Traffic Monitoring Utility(W-LAN model only)
	Bluetooth Power Management Utility(BT model only)

 If more notification icons need to be displayed than there is room to display them, the Notification icon, , will display. Tap the icon to view all notification icons.

## Programs











You can switch from one program to another by selecting it from the  menu. (You can customize which programs you see on this menu. For information, see “Adjusting Settings,” later in this chapter.) To access some programs, you’ll need to tap  **Programs**, and then the program name.

You can also switch to some programs by pressing a program button. Your device has one or more program buttons located on the front or side of the device. The icons on the buttons identify the programs they switch to.

 Some programs have abbreviated labels for check boxes and drop-down menus. To see the full spelling of an abbreviated label, tap and hold the stylus on the label. Drag the stylus off the label so that the command is not carried out.

The following table contains a partial list of programs that are on your device. Look on the Toshiba Pocket PC Companion CD for additional programs that you can install onto your device.



Icon	Program	Description
	ActiveSync	Synchronize information between your device and computer.
	Calendar	Keep track of your appointments and create meeting requests.
	Contacts	Keep track of your friends and colleagues.
	Inbox	Send and receive e-mail messages.
	Pocket Internet Explorer	Browse Web and WAP sites, and download new programs and files from the Internet.
	Notes	Create handwritten or typed notes, drawings, and recordings.
	Tasks	Keep track of your tasks.
	Pocket Excel	Create new workbooks or view and edit Excel workbooks created on your computer.
	MSN Messenger	Send and receive instant messages with your MSN Messenger contacts.
	Pocket Word	Create new documents or view and edit Word documents created on your computer.

## Navigation Bar and Command Bar

The navigation bar is located at the top of the screen. It displays the active program and current time, and allows you to switch to programs and close screens.

Use the command bar at the bottom of the screen to perform tasks in programs. The command bar includes menu names, buttons, and the Input Panel button. To create a new item in the current program, tap **New**. To see the name of a button, tap and hold the stylus on the button. Drag the stylus off the button so that the command is not carried out.

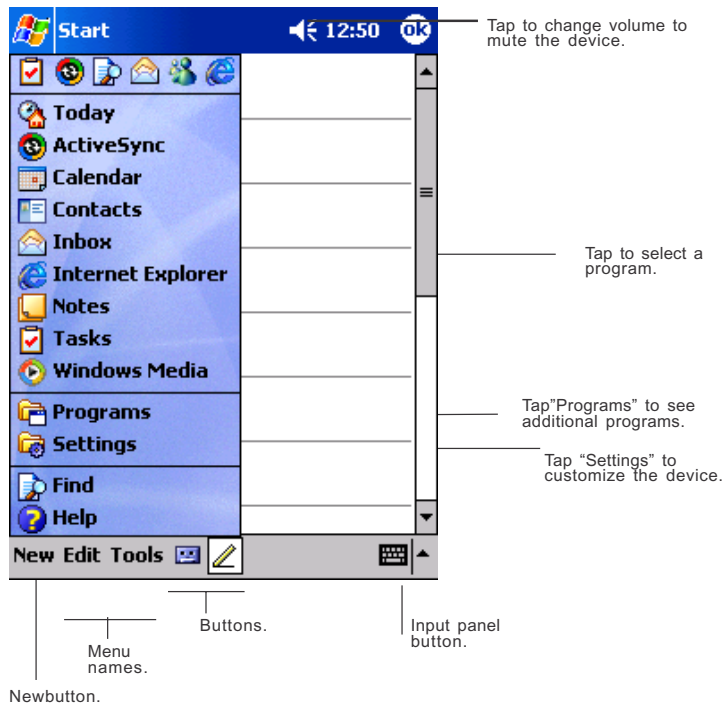

## Pop-up Menu

With pop-up menus, you can quickly choose an action for an item. For example, you can use the pop-up menu in the contact list to quickly delete a contact, make a copy of a contact, or send an e-mail message to a contact. The actions in the pop-up menu vary from program to program. To access a pop-up menu, tap and hold the stylus on the item name that you want to perform the action on. When the menu appears, lift the stylus, and tap the action you want to perform. Or tap anywhere outside the menu to close the menu without performing an action.

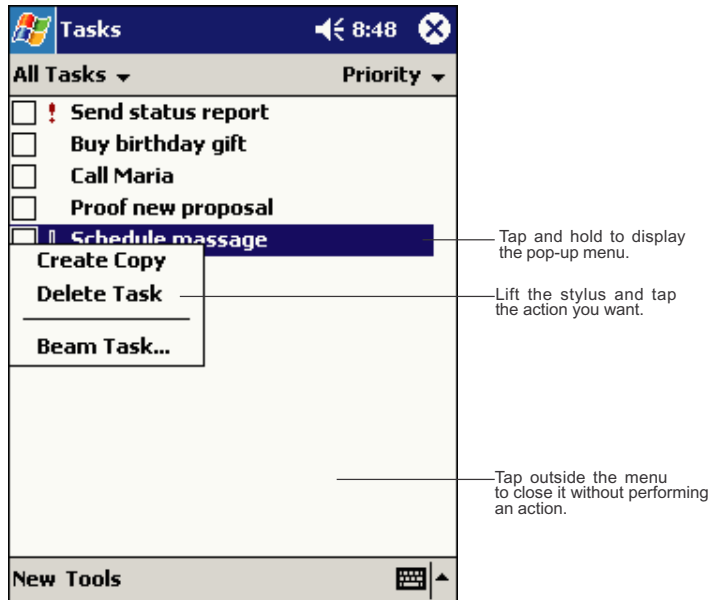

## Notifications

Your device reminds you in a variety of ways when you have something to do. For example, if you've set up an appointment in Calendar, a task with a due date in Tasks, or an alarm in Clock, you'll be notified in any of the following ways:

- A message box appears on the screen.
- A sound, which you can specify, is played.
- A light flashes on your device.

To choose reminder types and sounds for your device, tap  and then **Settings**. In the **Personal** tab, tap **Sounds & Notifications**. The options you choose here apply throughout the device.

## Enter Information on Your Toshiba Pocket PC

You have several options for entering new information:

- Use the input panel to enter typed text, either by using the soft keyboard or other input method.
- Write directly on the screen.
- Draw pictures on the screen.
- Speak into your device microphone to record a message.
- Use Microsoft® ActiveSync® to synchronize or copy information from your computer to your device. For more information on ActiveSync, see ActiveSync Help on your computer.

### Entering Text Using the Input Panel

Use the input panel to enter information in any program on your device. You can either type using the soft keyboard or write using Letter Recognizer, Block Recognizer, or Transcriber. In either case, the characters appear as typed text on the screen.

To show or hide the input panel, tap the Input Panel button. Tap the arrow next to the Input Panel button to see your choices.

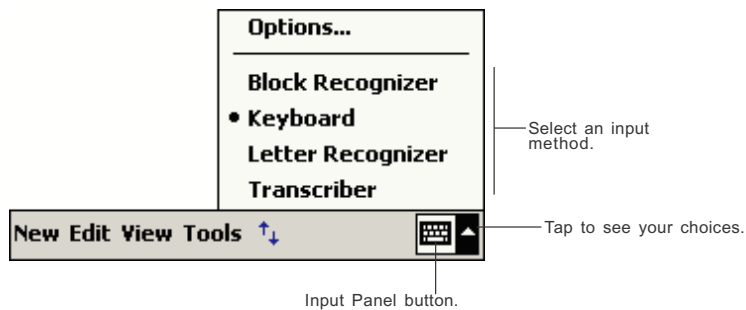

When you use the input panel, your device anticipates the word you are typing or writing and displays it above the input panel. When you tap the displayed word, it is inserted into your text at the insertion point. The more you use your device, the more words it learns to anticipate.

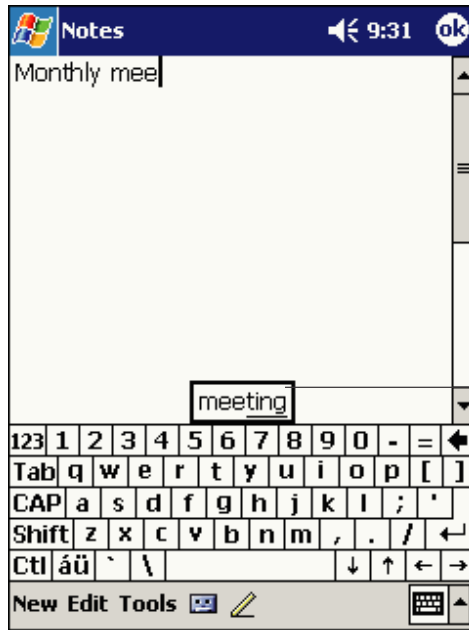

Tap here if this is the right word.

 To change word suggestion options, such as the number of words suggested at one time, tap  **Settings**, **Personal** tab, **Input**, and then the **Word Completion** tab.

#### To type with the soft keyboard:

1. Tap the arrow next to the Input Panel button and then **Keyboard**.
2. On the soft keyboard that is displayed, tap the keys with your stylus.

#### To use Letter Recognizer:

With Letter Recognizer you can write letters using the stylus just as you would on paper.

1. Tap the arrow next to the Input Panel button and then **Letter Recognizer**.
2. Write a letter in the box.

When you write a letter, it is converted to typed text that appears on the screen. For specific instructions on using Letter Recognizer, with Letter Recognizer open, tap the question mark next to the writing area.

**To use Block Recognizer:**

With Block Recognizer you can input character strokes using the stylus that are similar to those used on other devices.

1. Tap the arrow next to the Input Panel button and then **Block Recognizer**.
2. Write a letter in the box.

When you write a letter, it is converted to typed text that appears on the screen. For specific instructions on using Block Recognizer, with Block Recognizer open, tap the question mark next to the writing area.

**To use Transcriber:**

With Transcriber you can write anywhere on the screen using the stylus just as you would on paper. Unlike Letter Recognizer and Block Recognizer, you can write a sentence or more of information. Then, pause and let Transcriber change the written characters to typed characters.

1. Tap the arrow next to the Input Panel button and then **Transcriber**.
2. Write anywhere on the screen.

For specific instructions on using Transcriber, with Transcriber open, tap the question mark in the lower right hand corner of the screen.

**To select typed text:**

If you want to edit or format typed text, you must select it first.

- Drag the stylus across the text you want to select.

You can cut, copy, and paste text by tapping and holding the selected words and then tapping an editing command on the pop-up menu, or by tapping the command on the **Edit** menu.

## Writing on the Screen

In any program that accepts writing, such as the **Notes** program, and in the **Notes** tab in Calendar, Contacts, and Tasks, you can use your stylus to write directly on the screen. Write the way you do on paper. You can edit and format what you've written and convert the information to text at a later time.

### To write on the screen:

- Tap the Pen button to switch to writing mode. This action displays lines on the screen to help you write.



Tap the Pen button and use your stylus like a pen.



*Some programs that accept writing may not have the Pen button. See the documentation for that program to find out how to switch to writing mode.*

**To select writing:**

If you want to edit or format writing, you must select it first.

1. Tap and hold the stylus next to the text you want to select until the insertion point appears.
2. Without lifting, drag the stylus across the text you want to select.

If you accidentally write on the screen, tap **Tools**, then **Undo** and try again. You can also select text by tapping the **Pen** button to deselect it and then dragging the stylus across the screen.

You can cut, copy, and paste written text in the same way you work with typed text: tap and hold the selected words and then tap an editing command on the pop-up menu, or tap the command on the **Edit** menu.

**To convert writing to text:**

- Tap **Tools** and then **Recognize**.

If you want to convert only certain words, select them before tapping **Recognize** on the **Tools** menu (or tap and hold the selected words and then tap **Recognize** on the pop-up menu). If a word is not recognized, it is left as writing.

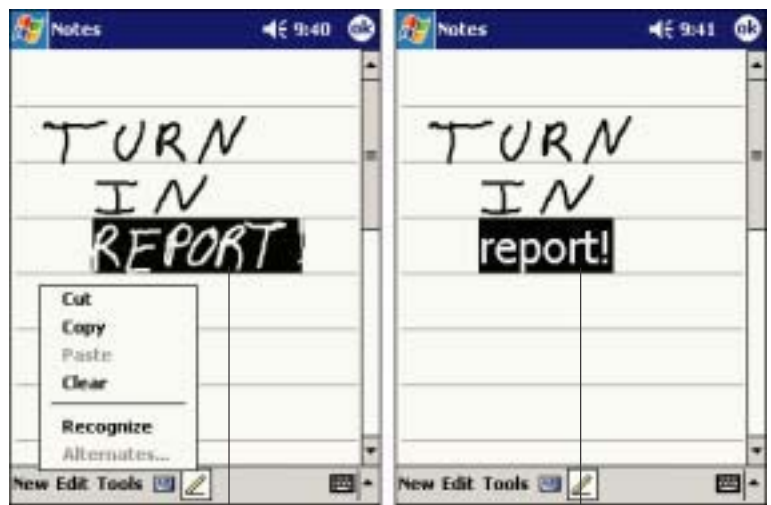

Select the text you want to convert and tap **Recognize** on the pop-up menu.

The writing is turned into text.



If the conversion is incorrect, you can select different words from a list of alternates or return to the original writing. To do so, tap and hold the incorrect word (tap one word at a time). On the pop-up menu, tap **Alternates**. A menu with a list of alternate words appears. Tap the word you want to use, or tap the writing at the top of the menu to return to the original writing.

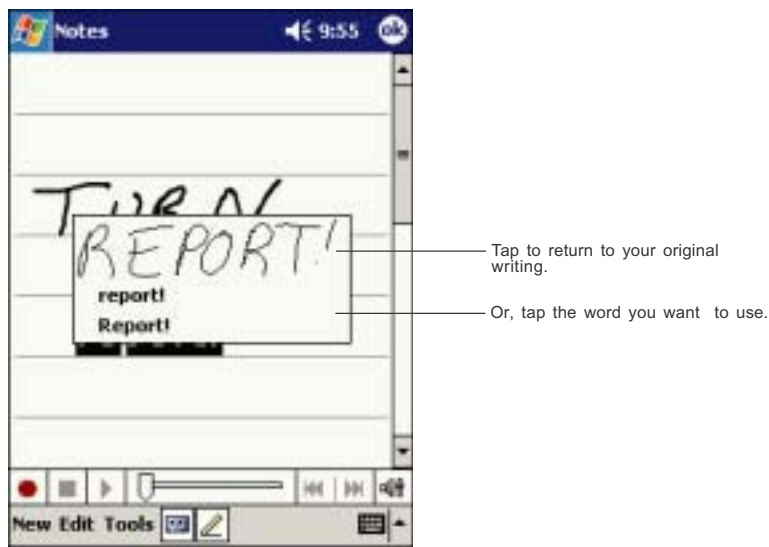

Tips for getting good recognition:

- Write neatly.
- Write on the lines and draw descenders below the line. Write the cross of the "t" and apostrophes below the top line so that they are not confused with the word above. Write periods and commas above the line.
- For better recognition, try increasing the zoom level to 300% using the **Tools** menu.
- Write the letters of a word closely and leave big gaps between words so that the device can easily tell where words begin and end.
- Hyphenated words, foreign words that use special characters such as accents, and some punctuation cannot be converted.
- If you add writing to a word to change it (such as changing a "3" to an "8") after you attempt to recognize the word, the writing you add will not be included if you attempt to recognize the writing again.

## Drawing on the Screen

You can draw on the screen in the same way that you write on the screen. The difference between writing and drawing on the screen is how you select items and how they can be edited. For example, selected drawings can be resized, while writing cannot.

### To create a drawing:

- Cross three ruled lines on your first stroke. A drawing box appears. Subsequent strokes in or touching the drawing box become part of the drawing. Drawings that do not cross three ruled lines will be treated as writing.

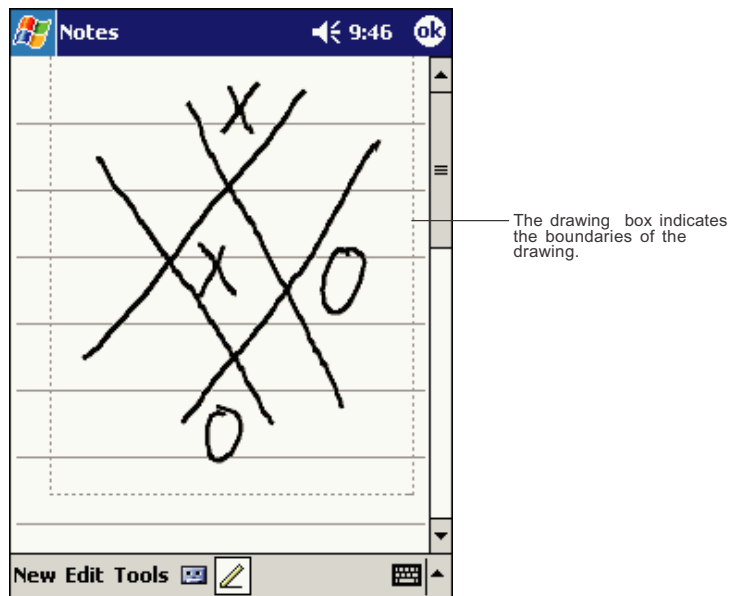

 You may want to change the zoom level so that you can more easily work on or view your drawing. Tap *Tools* and then a zoom level.

**To select a drawing:**

If you want to edit or format a drawing, you must select it first.

- Tap and hold the stylus on the drawing until the selection handle appears. To select multiple drawings, deselect the Pen button and then drag to select the drawings you want.

You can cut, copy, and paste selected drawings by tapping and holding the selected drawing and then tapping an editing command on the pop-up menu, or by tapping the command on the **Edit** menu. To resize a drawing, make sure the Pen button is not selected, and drag a selection handle.

## Recording a Message

In any program where you can write or draw on the screen, you can also quickly capture thoughts, reminders, and phone numbers by recording a message. In Calendar, Tasks, and Contacts, you can include a recording in the **Notes** tab. In the Notes program, you can either create a stand-alone recording or include a recording in a written note. If you want to include the recording in a note, open the note first. In the Inbox program, you can add a recording to an e-mail message.

To create a recording:

1. Hold your device's microphone near your mouth or other source of sound.
2. Press and hold the Record hardware button on your device until you hear a beep.
3. While holding down the Record button, make your recording.
4. To stop recording, release the Record button. Two beeps will sound. The new recording appears in the note list or as an embedded icon.



You can also make a recording by tapping the **Record** button on the Recording toolbar.

To play a recording, tap it in the list or tap its icon in the note.

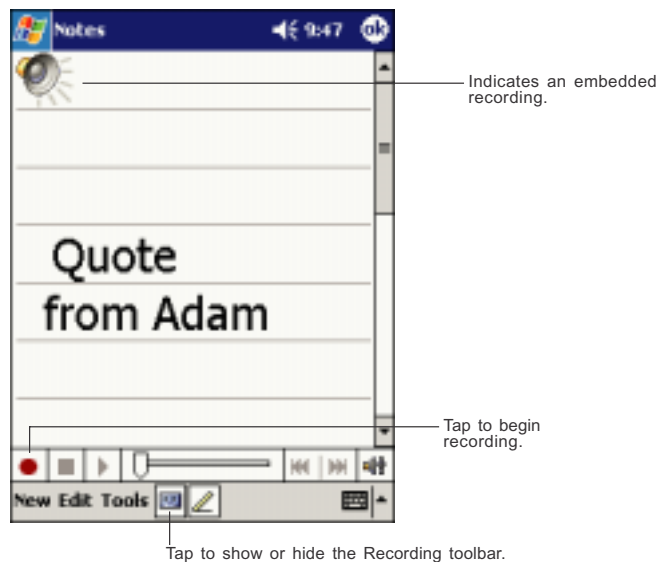

## Using My Text

When using Inbox or MSN Messenger, use My Text to quickly insert preset or frequently used messages into the text entry area. To insert a message, tap **My Text** and tap a message.



You can add text after inserting a My Text message before sending it.

To edit a My Text message, in the Tools menu, tap **Edit** and then tap **My Text Messages**. Select the message you wish to edit and make desired changes.

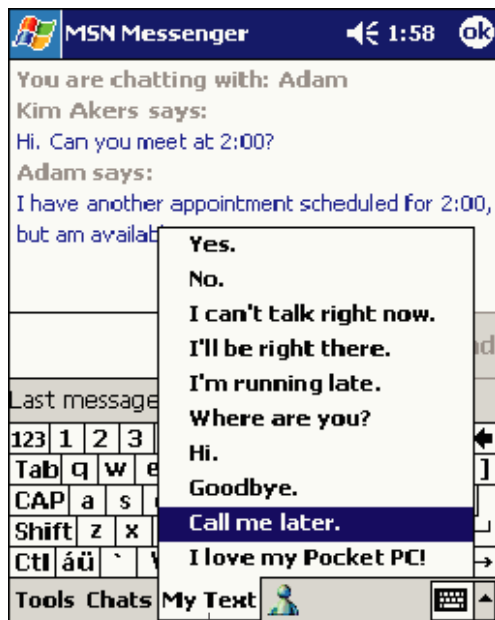



Tap to select a prewritten message.

## Find and Organize Information

The Find feature on your device helps you quickly locate information.

- On the  menu, tap **Find**. Enter the text you want to find, select a data type, and then tap **Go** to start the search.

 To quickly find information that is taking up storage space on your device, select **Larger than 64 KB** in **Type**.

You can also use the File Explorer to find files on your device and to organize these files into folders. On the  menu, tap **Programs**, and then **File Explorer**.

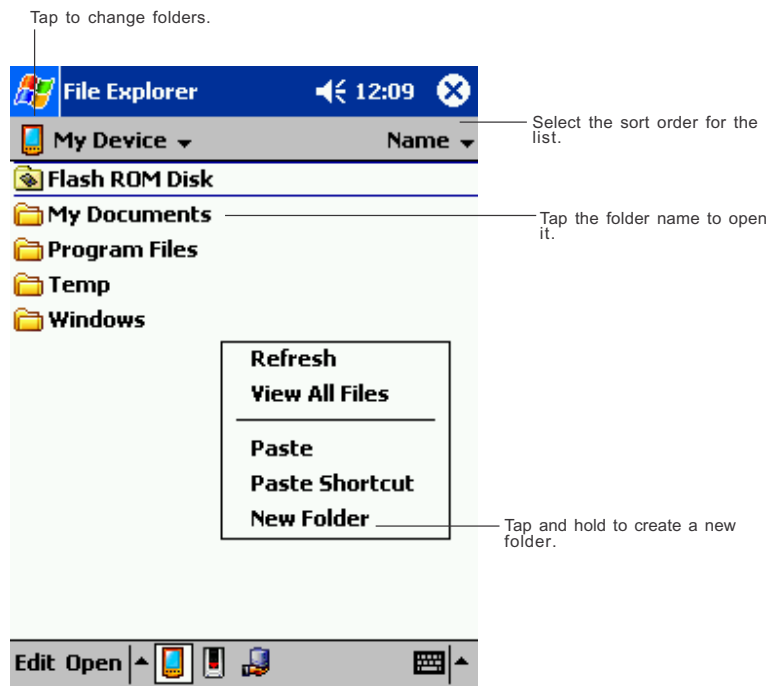

 You can move files in File Explorer by tapping and holding the item you want to move, and then tapping **Cut** or **Copy** and **Paste** on the pop-up menu.

## Customize Your Toshiba Pocket PC

You can customize your device by adjusting device settings and installing additional software.

### Adjusting Settings

You can adjust device settings to suit the way you work. To see available options, tap , **Settings**, then the **Personal** or **System** tab located at the bottom of the screen.

You might want to adjust the following:

- **Clock**, to change the time or to set alarms
- **Menus**, to customize what appears on the  menu, and to enable a pop-up menu from the **New** button
- **Owner Information**, to enter your contact information
- **Password**, to limit access to your device
- **Power**, to maximize battery life
- **Today**, to customize the look and the information that is displayed on the Today screen

### Adding or Removing Programs

Programs added to your device at the factory are stored in ROM (read-only memory). You cannot remove this software, and you'll never accidentally lose ROM contents. ROM programs can be updated using special installation programs with a \*.xip extension. All other programs and data files added to your device after factory installation are stored in RAM (random access memory).

You can install any program created for your device, as long as your device has enough memory. The most popular place to find software for your device is on the Pocket PC Web site (<http://www.microsoft.com/mobile/pocketpc>).

### To add programs using ActiveSync

You'll need to install the appropriate software for your device on your desktop computer before installing it on your device.

1. Determine your device and processor type so that you know which version of the software to install.

Tap  and then **Settings**. On the **System** tab, tap **About**. In the **Version** tab, make a note of the information in **Processor**.

2. Download the program to your computer (or insert the CD or disk that contains the program into your computer). You may see a single \*.xip, \*.exe, or \*.zip file, a Setup.exe file, or several versions of files for different device types and processors. Be sure to select the program designed for the Toshiba Pocket PC and your device processor type.
3. Read any installation instructions, Read Me files, or documentation that comes with the program.

Many programs provide special installation instructions.

4. Connect your device and computer.
5. Double-click the \*.exe file.
  - If the file is an installer, the installation wizard will begin. Follow the directions on the screen.

Once the software has been installed on your computer, the installer will automatically transfer the software to your device.
  - If the file is not an installer, you will see an error message stating that the program is valid but it is designed for a different type of computer. You will need to move this file to your device. If you cannot find any installation instructions for the program in the Read Me file or documentation, use ActiveSync Explore to copy the program file to the Program Files folder on your device. For more information on copying files using ActiveSync, see ActiveSync Help.

Once installation is complete, tap , **Programs**, and then the program icon to switch to it.





### To add a program directly from the Internet

1. Determine your device and processor type so that you know which version of the software to install.  
Tap  and then **Settings**. On the **System** tab, tap **About**. In the **Version** tab, make a note of the information in **Processor**.
2. Download the program to your device straight from the Internet using Pocket Internet Explorer. You may see a single \*.xip, \*.exe or \*.zip file, a Setup.exe file, or several versions of files for different device types and processors. Be sure to select the program designed for the Toshiba Pocket PC and your device processor type.
3. Read any installation instructions, Read Me files, or documentation that comes with the program. Many programs provide special installation instructions.
4. Tap the file, such as a \*.xip or \*.exe file. The installation wizard will begin. Follow the directions on the screen.

### To add a program to the Start menu

Tap , **Settings**, **Menus**, the **Start Menu** tab, and then the check box for the program. If you do not see the program listed, you can either use File Explorer on the device to move the program to the Start Menu folder, or use ActiveSync on the computer to create a shortcut to the program and place the shortcut in the Start Menu folder.

- **Using File Explorer on the device:** Tap , **Programs**, **File Explorer**, and locate the program (tap the folder list, labeled **My Documents** by default, and then **My Device** to see a list of all folders on the device). Tap and hold the program and tap **Cut** on the pop-up menu. Open the Start Menu folder located in the Windows folder, tap and hold a blank area of the window, and tap **Paste** on the pop-up menu. The program will now appear on the menu. For more information on using File Explorer, see "Find and Organize Information," earlier in this chapter.
- **Using ActiveSync on the computer:** Use the Explorer in ActiveSync to explore your device files and locate the program. Right-click the program, and then click **Create Shortcut**. Move the shortcut to the Start Menu folder in the Windows folder. The shortcut now appears on the  menu. For more information, see ActiveSync Help.

### To remove programs

- Tap  and then **Settings**. On the **System** tab, tap **Remove Programs**.

If the program does not appear in the list of installed programs, use File Explorer on your device to locate the program, tap and hold the program, and then tap **Delete** on the pop-up menu.

## Setting Password

You can protect data or settings from a third person by setting a password which is requested when turning power on.

1. Tap  and then **Settings**. On the **Personal** tab, tap **Password**.
2. Select the type of password you would like to use.
3. Enter a password and tap **OK**.
4. Tap **YES** on the confirmation screen. The password is saved and the screen returns to the **Personal** tab screen

If you tap **YES** on the confirmation screen to return to the **Personal** tab screen, it becomes necessary to enter the password even for displaying the Password setting screen.

In case you forget the password, it is necessary to initialize the Pocket PC. Please note that when initialization is executed, data or settings stored in the Pocket PC are all deleted.

## To Set Screen Light

You can set the screen brightness for better sight according to a place of use. You can also set the time that elapses until the screen light turns off automatically after the last operation.

1. Tap  and then **Settings**. On the **System** tab, tap **Screen Light**.
2. Set the Screen Light on battery power.

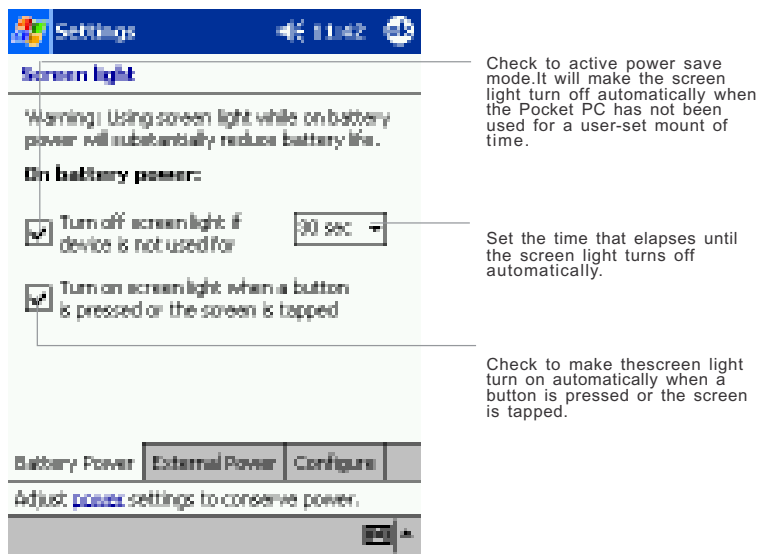

-or set the screen light on External power.

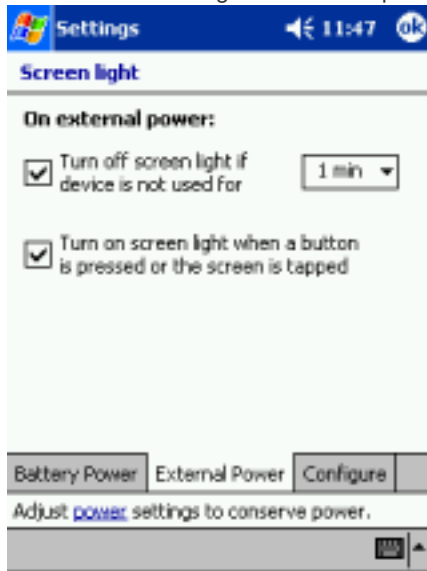

3. Set the Brightness level.



Tap and set the screen light brightness level by move the cursor up or down. If Power Save is activated, the screen light turns off.

4. When finished, tap **OK** to return to the System tab screen.

## Setting Power

You can set to confirm the battery remaining power and the time that elapses until the power turns off after the last operation.

1. Tap  and then **Settings**. On the **System** tab, tap **Power**.
2. Set the Power.



Options are 1, 2,3,4, and 5 minutes until device will turn off in battery-powered mode if not used. Check box to left to engage this feature.

Options are 1, 2,3,4, and 5 minutes until device will turn off in external-powered mode if not used. Check box to left to engage this feature.

3. Select **Battery** tab to adjust when battery alarm will come on, and to enable/disable **Record** and **Program button** wake up.

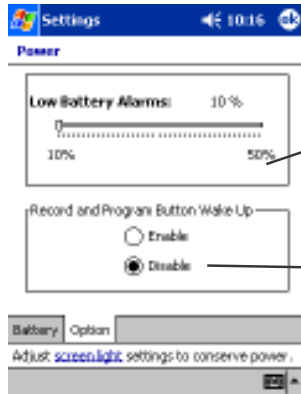

Battery alarm can be adjusted to go off from 10% to 50% of full charge.

Enable or Disable Record and Program Wake Up

4. Select **CPU speed** tab to set the CPU performance. To conserve battery power, select 200 MHz. Note: this will decrease performance.
5. When finished, tap **OK** to return to the System tab screen.

## Setting Memory

You can adjust the data storing memory and the program running memory. You can also confirm the free space of a storage card and so on. Memory for the Pocket PC is managed automatically.

### To change Memory allocation:

1. Tap  and then **Settings**. On the **System** tab, tap **Memory** to display the Memory setting screen.
2. Drag the knob widthwise to adjust the memory allocation between Storage and Program.
3. When finished, tap **OK** to return to the System tab screen.

### To confirm usage status of a storage card:

1. Tap **Storage card** tab on the Memory setting screen.

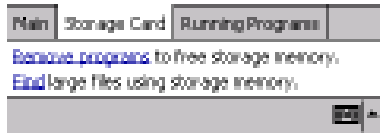
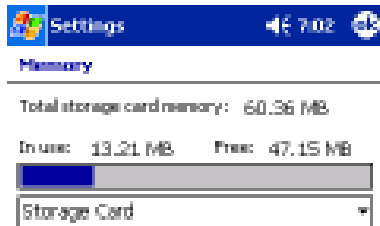

2. When finished, tap **OK** to return to the System tab screen.

## Setting Volume

This program allows you to adjust the built-in volume and the headphone volume on the Toshiba PC e750/e755.

- 1 Tap  and then **Settings**. On the **System** tab, tap **Advanced Sounds**.
- 2 Select the **Built-in** tab and adjust the Volume as shown below.

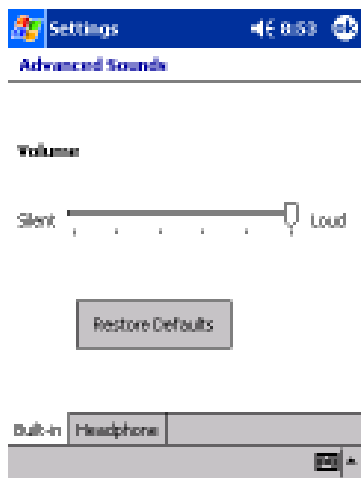

- 3 If using headphones, select the **Headphone** tab and make adjustments as shown below .

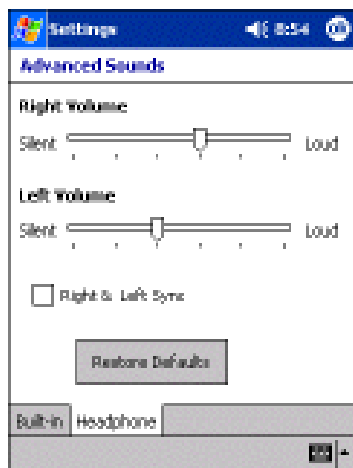

## Setting Microphone

Tap  and then **Settings**. On the **System** tab, tap **Microphone**.

- This program is setting Automatic Gain Control (AGC) auto or manual.
- If “Auto Gain Control” is chosen, **Volume** function is suspended.
- If “Auto Gain Control” is not chosen, **Volume** function is enabled.

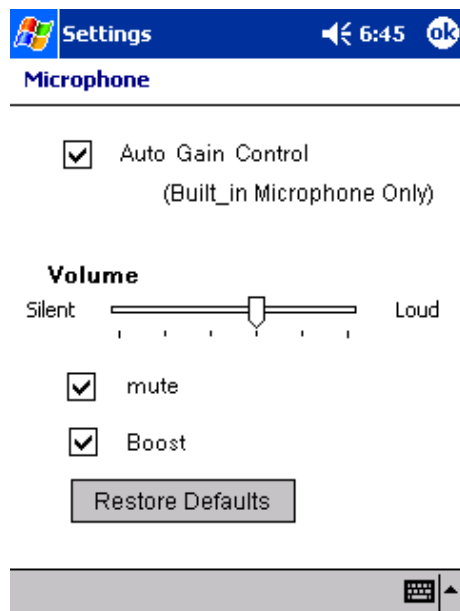



### Chapter 3:

## Microsoft ActiveSync

Using Microsoft® ActiveSync®, you can synchronize the information on your desktop computer with the information on your device. Synchronization compares the data on your device with your PC and updates both computers with the most recent information. For example:

- Keep Pocket Outlook data up-to-date by synchronizing your device with Microsoft Outlook data on your PC.
- Synchronize Microsoft Word and Microsoft Excel files between your device and desktop computer.

Your files are automatically converted to the correct format.



*By default, ActiveSync does not automatically synchronize all types of information. Use ActiveSync options to turn synchronization on and off for specific information types.*

With ActiveSync, you can also:

- Back up and restore your device data.
- Copy (rather than synchronize) files between your device and desktop computer.
- Control when synchronization occurs by selecting a synchronization mode. For example, you can synchronize continually while connected to your desktop computer or only when you choose the synchronize command.
- Select which information types are synchronized and control how much data is synchronized. For example, you can choose how many weeks of past appointments you want synchronized.

Before you begin synchronization, install ActiveSync on your PC from the Toshiba Pocket PC Companion CD. For more information on installing ActiveSync, see your Quick Start card. ActiveSync is already installed on your device.

After installation is complete, the ActiveSync Setup Wizard helps you connect your Pocket PC to your PC, set up a partnership so you can synchronize information between your device and your desktop computer, and

customize your synchronization settings. Your first synchronization process will automatically begin when you finish using the wizard.

After your first synchronization, take a look at Calendar, Contacts, and Tasks on your device. You'll notice that information you've stored in Microsoft Outlook on your PC has been copied to your device, and you didn't have to type a word. Disconnect your device from your PC and you're ready to go!

Once you have set up ActiveSync and completed the first synchronization process, you can initiate synchronization from your device. To switch to ActiveSync on your device, tap , and then tap **ActiveSync**.

For information about using ActiveSync on your PC, start ActiveSync on your PC, and then see ActiveSync Help.

For more information about ActiveSync on your device, switch to ActiveSync, tap , and then tap **Help**.

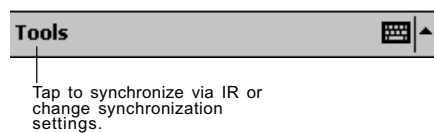
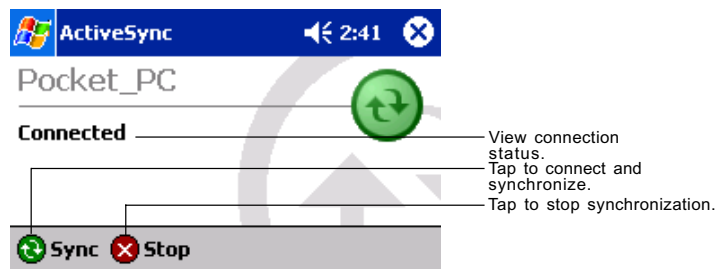

*Chapter 4:*

## **Microsoft Pocket Outlook**

Microsoft® Pocket Outlook includes Calendar, Contacts, Tasks, Inbox, and Notes. You can use these programs individually or together. For example, e-mail addresses stored in Contacts can be used to address e-mail messages in Inbox.

Using ActiveSync® you can synchronize information in Microsoft Outlook or Microsoft Exchange on your desktop computer with your device. You can also synchronize this information directly with a Microsoft Exchange server. Each time you synchronize, ActiveSync compares the changes you made on your device and desktop computer or server and updates both computers with the latest information. For information on using ActiveSync, see ActiveSync Help on the desktop computer.

You can switch to any of these programs by tapping them on the  menu.

## Calendar: Scheduling Appointments and Meetings

Use Calendar to schedule appointments, including meetings and other events. You can check your appointments in one of several views (Agenda, Day, Week, Month, and Year) and easily switch views by using the **View** menu.

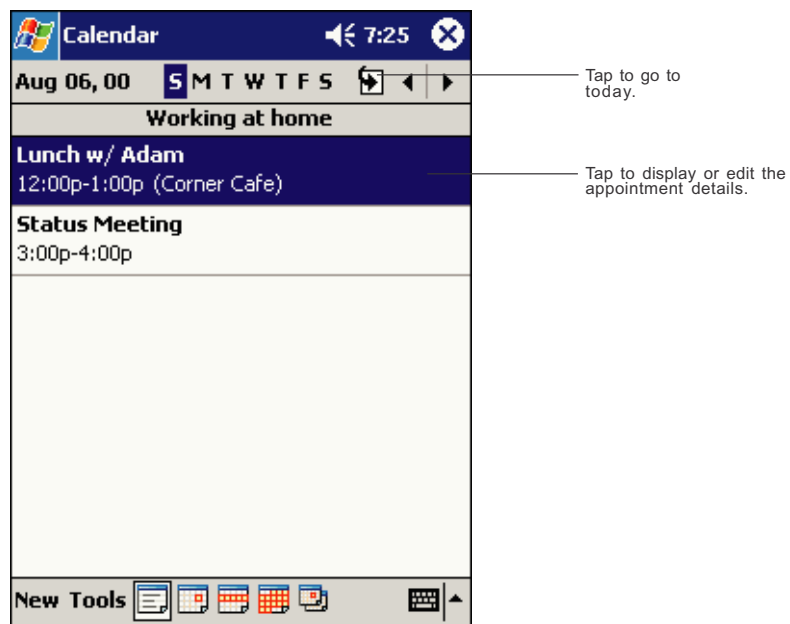



 You can customize the Calendar display, such as changing the first day of the week, by tapping **Options** on the **Tools** menu.

**To create an appointment:**

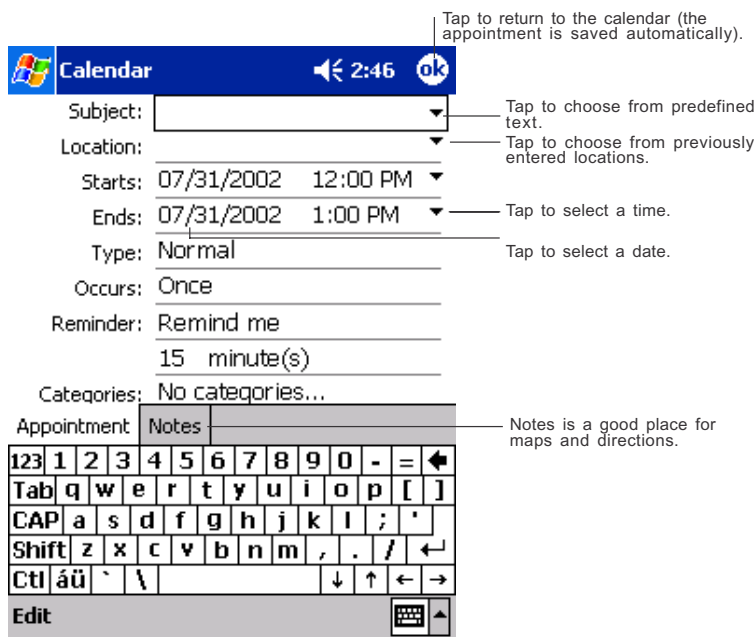
1. If you are in Day or Week view, tap the desired date and time for the appointment.
2. Tap **New**.



3. Using the input panel, enter a description and a location. Tap first to select the field.
4. If needed, tap the date and time to change them.
5. Enter other desired information. You will need to hide the input panel to see all available fields.
6. To add notes, tap the **Notes** tab. You can enter text, draw, or create a recording. For more information on creating notes, see "Notes: Capturing Thoughts and Ideas," later in this chapter.
7. When finished, tap **OK** to return to the calendar.

 If you select **Remind me** in an appointment, your device will remind you according to the options set in  **Settings, Personal** tab, **Sounds & Notifications**.

## Using the Summary Screen

When you tap an appointment in Calendar, a summary screen is displayed. To change the appointment, tap **Edit**.

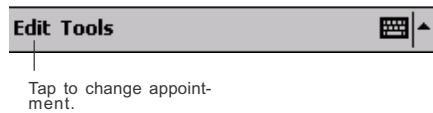
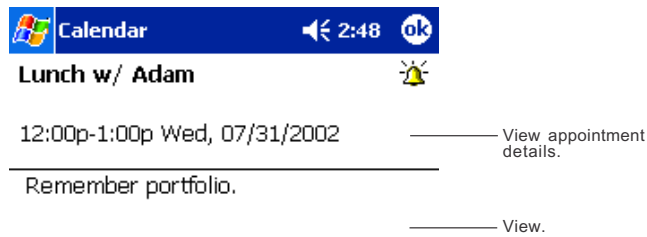

## Creating Meeting Requests

You can use Calendar to set up meetings with users of Outlook or Pocket Outlook. The meeting request will be created automatically and sent either when you synchronize Inbox or when you connect to your e-mail server. Indicate how you want meeting requests sent by tapping **Tools** and then **Options**. If you send and receive e-mail messages through ActiveSync, select **ActiveSync**.

### To schedule a meeting:

1. Create an appointment by tapping **NEW**.
2. In the appointment details, hide the input panel, and then tap **Attendees**.
3. From the list of e-mail addresses you've entered in **Contacts**, select the meeting attendees.

The meeting notice is created automatically and placed in the Outbox folder. For more information on sending and receiving meeting requests, see **Calendar Help** and **Inbox Help** on the device.

## Contacts: Tracking Friends and Colleagues

Contacts maintains a list of your friends and colleagues so that you can easily find the information you're looking for, whether you're at home or on the road. Using the device infrared (IR) port, you can quickly share Contacts information with other device users.

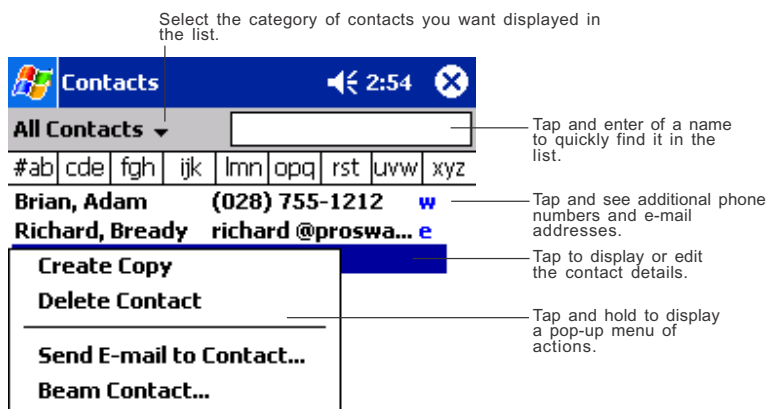

Tap to create a newcontact.

 To change the way information is displayed in the list, tap **Tools** and then **Options**.

**To create a contact:**

1. Tap **New**.

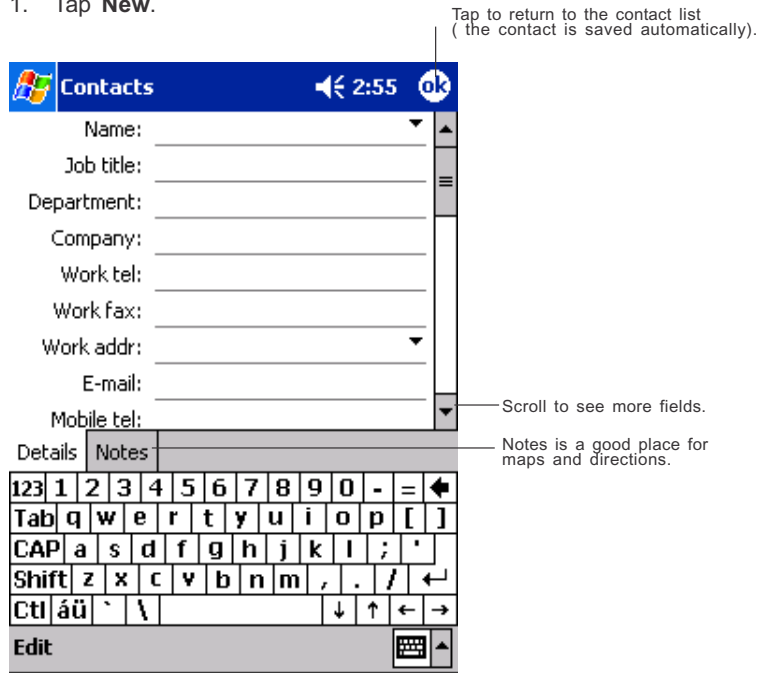

2. Using the input panel, enter a name and other contact information. You will need to scroll down to see all available fields.
3. To assign the contact to a category, scroll to and tap **Categories** and select a category from the list. In the contact list, you can display contacts by category.
4. To add notes, tap the **Notes** tab. You can enter text, draw, or create a recording. For more information on creating notes, see "Notes: Capturing Thoughts and Ideas," later in this chapter.
5. When finished, tap **OK** to return to the contact list.



### Finding a contact

There are four ways to find a contact:

- In the contact list, enter a contact name in the box under the navigation bar. To show all contacts again, clear text from the box or tap the button to the right of the box.
- In the contact list, tap the category list (labeled **All Contacts** by default) and select the type of contact that you want displayed. To show all contacts again, select **All Contacts**. To view a contact not assigned to a category, select **None**.
- To view the names of companies your contacts work for, in the contact list, tap **View > By Company**. The number of contacts that work for that company will be displayed to the right of the company name.
- Tap  **Find**, enter the contact name, select **Contacts** for the type, and then tap **Go**.

## Using the Summary Screen

When you tap a contact in the contact list, a summary screen is displayed. To change the contact information, tap **Edit**.

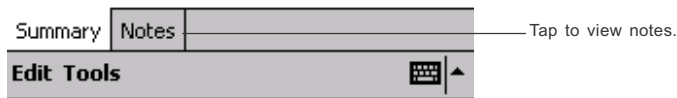
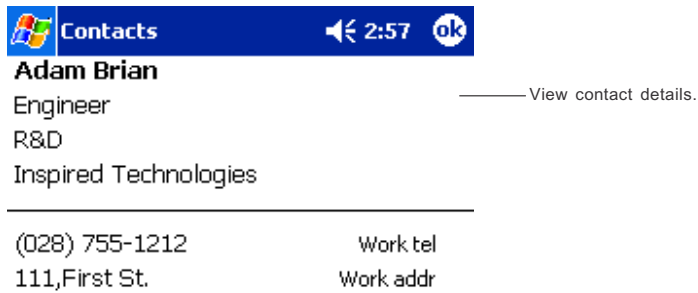

## Tasks: Keeping a To Do List

Use Tasks to keep track of what you have to do.

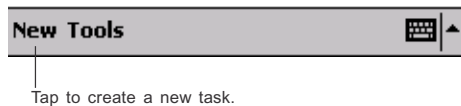
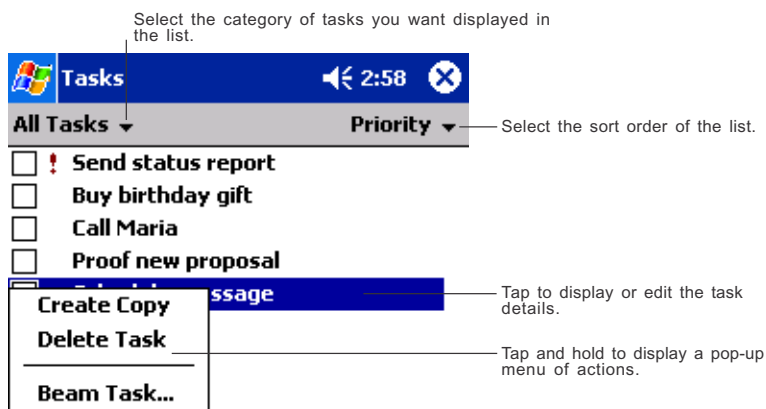

 To change the way information is displayed in the list, tap **Tools** and then **Options**.

**To create a task:**

1. Tap **New**.

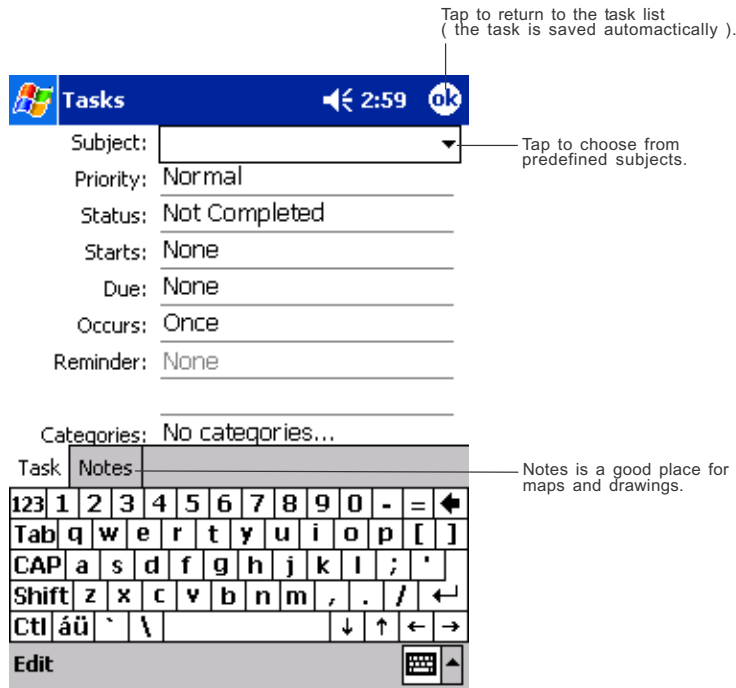

2. Using the input panel, enter a description.
3. You can enter a start date and due date or enter other information by first tapping the field. If the input panel is open, you will need to hide it to see all available fields.
4. To assign the task to a **category**, tap **Categories** and select a category from the list. In the task list, you can display tasks by category.
5. To add notes, tap the **Notes** tab. You can enter text, draw, or create a recording. For more information on creating notes, see “Notes: Capturing Thoughts and Ideas,” later in this chapter.
6. When finished, tap **OK** to return to the task list.

 To quickly create a task with only a subject, tap **Entry Bar** on the **Tools** menu. Then, tap **Tap here to add a new task** and enter your task information.

### Using the Summary Screen

When you tap a task in the task list, a summary screen is displayed. To change the task, tap **Edit**.

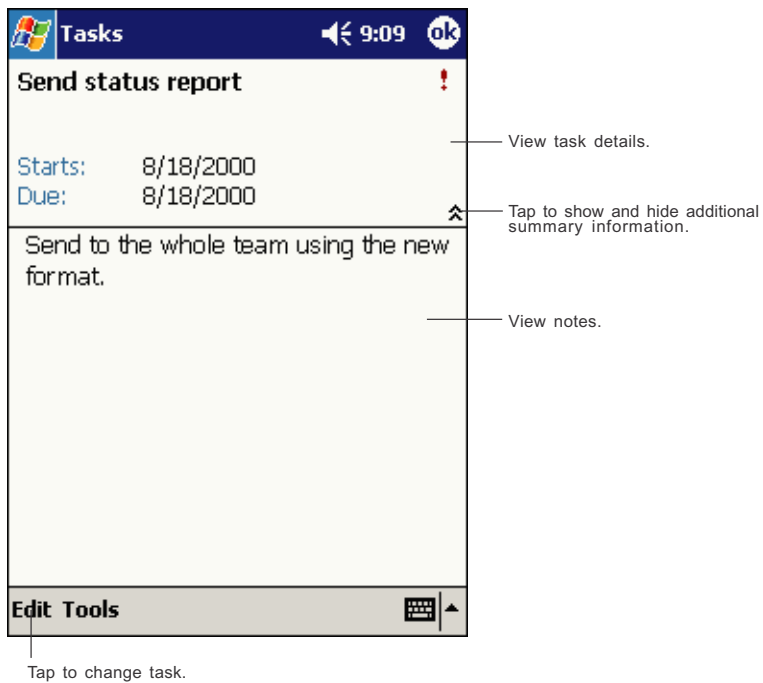

## Notes: Capturing Thoughts and Ideas

Quickly capture thoughts, reminders, ideas, drawings, and phone numbers with Notes. You can create a written note or a recording. You can also include a recording in a note. If a note is open when you create the recording, it will be included in the note as an icon. If the note list is displayed, it will be created as a stand-alone recording.

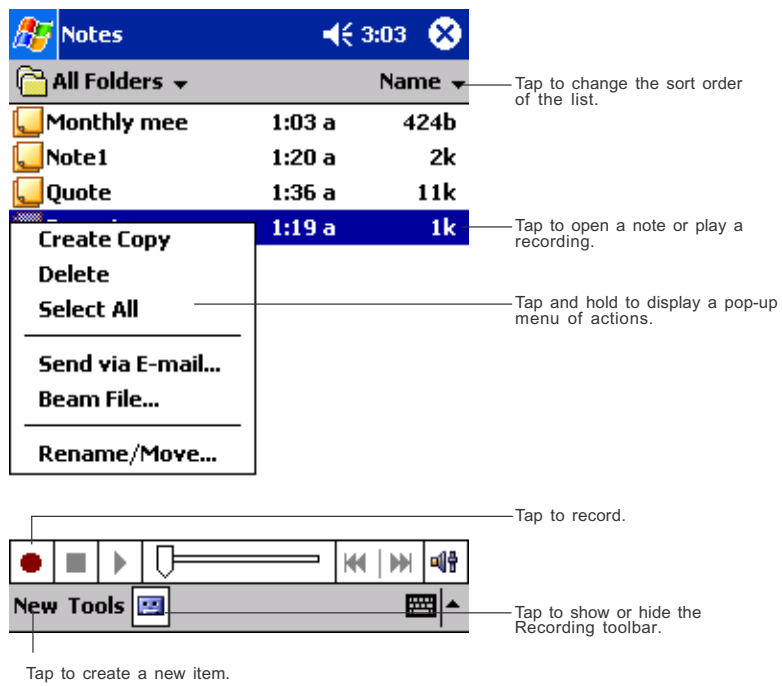

**To create a note:**

1. Tap **New**.
2. Create your note by writing, drawing, typing, and recording. For more information about using the input panel, writing and drawing on the screen, and creating recordings, see Chapter 2.

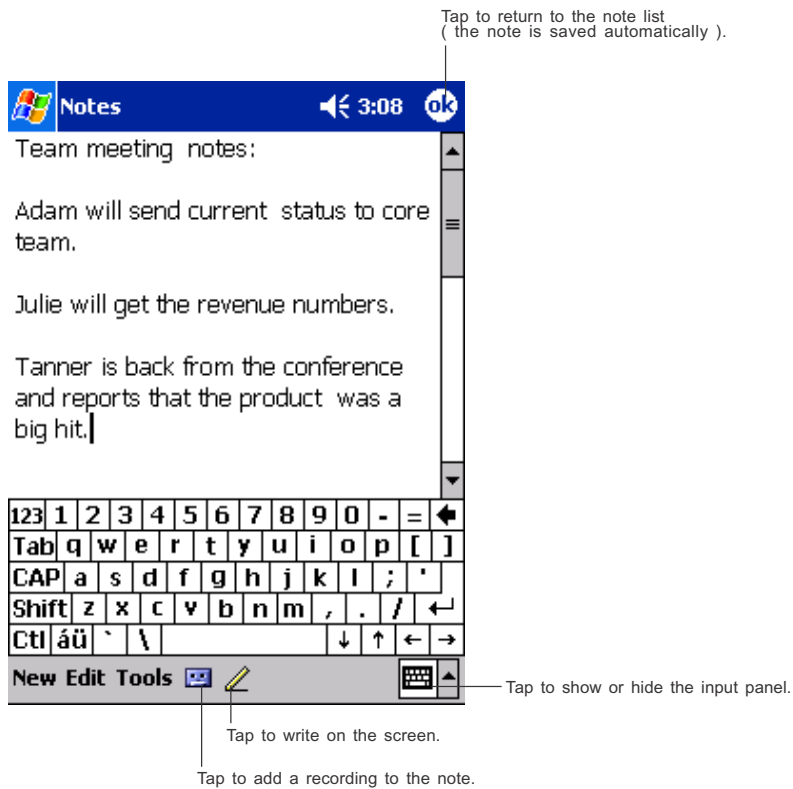

## **Inbox: Sending and Receiving E-mail Messages**

Use Inbox to send and receive e-mail messages in either of these ways:

- Synchronize e-mail messages with Microsoft Exchange or Microsoft Outlook on your PC.
- Send and receive e-mail messages by connecting directly to an e-mail server through an Internet Service Provider (ISP) or a network.

### **Synchronizing E-mail Messages**

E-mail messages can be synchronized as part of the general synchronization process. You will need to enable Inbox synchronization in ActiveSync. For information on enabling Inbox synchronization, see ActiveSync Help on the PC.

During synchronization:

- Messages are copied from the mail folders of Exchange or Outlook on your desktop computer to the ActiveSync folder in Inbox on your device. By default, you will receive messages from the past three days only, the first 100 lines of each message, and file attachments of less than 100 KB in size.
- E-mail messages in the Outbox folder on your device are transferred to Exchange or Outlook, and then sent from those programs.
- E-mail messages in subfolders must be selected in ActiveSync on your desktop computer in order to be transferred.



### Using the Message List

Messages you receive are displayed in the message list. By default, the most recently received messages are displayed first in the list.

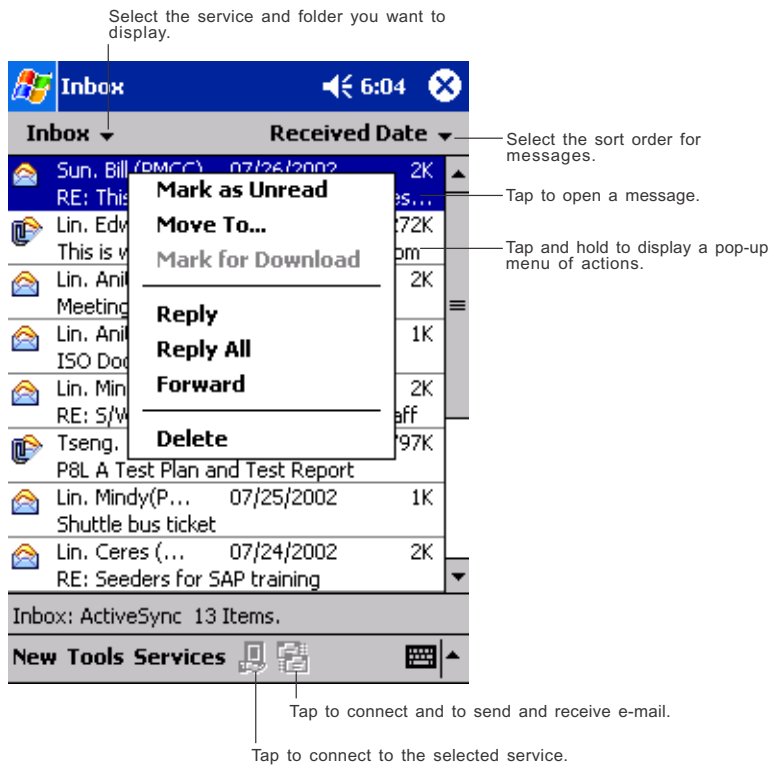

When you receive a message, tap it to open it. Unread messages are displayed in bold.

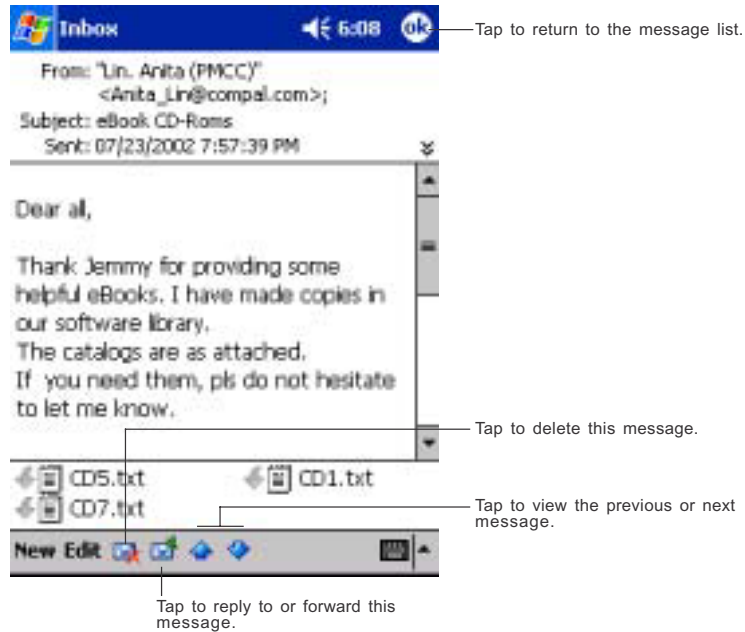

When you connect to your e-mail server or synchronize with your desktop computer, by default, you'll receive messages from the last five days only, the first 100 lines of each new message, and file attachments of less than 100 KB in size. The original messages remain on the e-mail server or your desktop computer.

You can mark the messages that you want to retrieve in full during your next synchronization or e-mail server connection. In the message list, tap and hold the message you want to retrieve. On the pop-up menu, tap **Mark for Download**. The icons in the Inbox message list give you visual indications of message status.

You specify your downloading preferences when you set up the service or select your synchronization options. You can change them at any time:

- Change options for Inbox synchronization using ActiveSync options. For more information, see ActiveSync Help.
- Change options for direct e-mail server connections in Inbox on your device. Tap **Tools** and then tap Options. On the **Service** tab, tap the service you want to change. Tap and hold the service and select **Delete** to remove a service.

## Composing Messages

### To compose a message:

1. Tap **New**.
2. In the **To** field, enter an e-mail or SMS address of one or more recipients, separating them with a semicolon, or select a name from the contact list by tapping the **Address Book** button. All e-mail addresses entered in the e-mail fields in Contacts appear in the Address Book.

Tap to send the message.



Tap to show or hide the complete header.



Tap to show / hide the recording toolbar.

Tap to display the Address Book.

Tap to insert common messages.

3. Compose your message. To enter preset or frequently used messages, tap **My Text** and select a message.
4. Tap **Send** when you've finished the message. If you are working offline, the message is moved to the Outbox folder and will be sent the next time you connect. If you are working online, it is sent immediately.

If you are sending an SMS message and want to know if it was received, tap **Edit, Options**, and select **Request SMS text message delivery notification** before sending the message.

## Managing E-mail Messages and Folders

By default, messages are displayed in one of five folders for each service you have created: Inbox, Deleted Items, Drafts, Outbox, and Sent Items. The Deleted Items folder contains messages that have been deleted on the device. The behavior of the Deleted and Sent Items folders depends on the options you have chosen. In the message list, tap **Tools** and then **Options**. On the **Message** tab, select your options.

If you want to organize messages into additional folders, tap **Tools**, and then **Manage Folders** to create new folders. To move a message to another folder, in the message list, tap and hold the message and then tap **Move to** on the pop-up menu.

### Folder behavior with a direct connection to an e-mail server

The behavior of the folders you create depends on whether you are using ActiveSync, SMS, POP3, or IMAP4.

- If you use ActiveSync, e-mail messages in the Inbox folder in Outlook will automatically be synchronized with your device. You can select to synchronize additional folders by designating them for ActiveSync. The folders you create and the messages you move will then be mirrored on the server. For example, if you move two messages from the Inbox folder to a folder named Family, and you have designated Family for synchronization, the server creates a copy of the Family folder and copies the messages into that folder. You can then read the messages while away from your desktop computer.
- If you use SMS, messages are stored in the Inbox folder.
- If you use POP3 and you move e-mail messages to a folder you created, the link is broken between the messages on the device and their copies on the mail server. The next time you connect, the mail server will see that the messages are missing from the device Inbox and delete them from the server. This prevents you from having duplicate copies of a message, but it also means that you will no longer have access to messages that you move to folders created from anywhere except the device.
- If you use IMAP4, the folders you create and the e-mail messages you move are mirrored on the server. Therefore, messages are available to you anytime you connect to your mail server, whether it is from your device or desktop computer. This synchronization of folders occurs whenever you connect to your mail server, create new folders, or rename/delete folders when connected.

*Chapter 5:*

## Companion Programs

The companion programs consist of Microsoft® Pocket Word, Microsoft® Pocket Excel, Microsoft® Money, Windows Media™ Player for Toshiba Pocket PC e750/e755, and Microsoft® Reader.

To switch to a companion program on your device, tap **Programs** on the  menu, and then tap the program name.

### Pocket Word

Pocket Word works with Microsoft Word on your computer to give you easy access to copies of your documents. You can create new documents on your device, or you can copy documents from your computer to your device. Synchronize documents between your computer and your device so that you have the most up-to-date content in both locations.

Use Pocket Word to create documents, such as letters, meeting minutes, and trip reports. To create a new file, tap , **Programs**, **Pocket Word**, and then **New**. A blank document appears. Or, if you've selected a template for new documents in the **Options** dialog box, that template appears with appropriate text and formatting already provided. You can open only one document at a time; when you open a second document, you'll be asked to save the first. You can save a document you create or edit in a variety of formats, including Word (.doc), Pocket Word (.psw), Rich Text Format (.rtf), and Plain Text (.txt).

Pocket Word contains a list of the files stored on your device. Tap a file in the list to open it. To delete, make copies of, and send files, tap and hold a file in the list. Then, select the appropriate action on the popup menu.

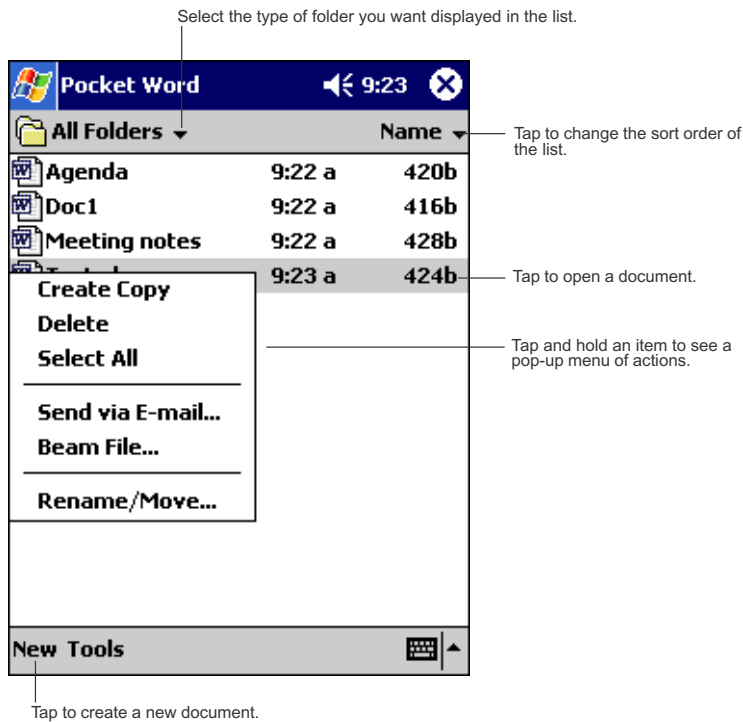

You can enter information in Pocket Word in one of four modes (typing, writing, drawing, and recording), which are displayed on the **View** menu. Each mode has its own toolbar, which you can show and hide by tapping the **Show/Hide Toolbar** button on the command bar.

 You can change the zoom magnification by tapping **View** and then **Zoom**. Then select the percentage you want. Select a higher percentage to enter text and a lower one to see more of your document. If you're opening a Word document created on a computer, select **Wrap to Window** on the **View** menu so that you can see the entire document.

### Typing Mode

Using the input panel, enter typed text into the document. For more information on entering typed text, see Chapter 2.

To format existing text and to edit text, first select the text. You can select text as you do in a Word document, using your stylus instead of the mouse to drag through the text you want to select. You can search a document to find text by tapping **Edit** and then **Find/Replace**.

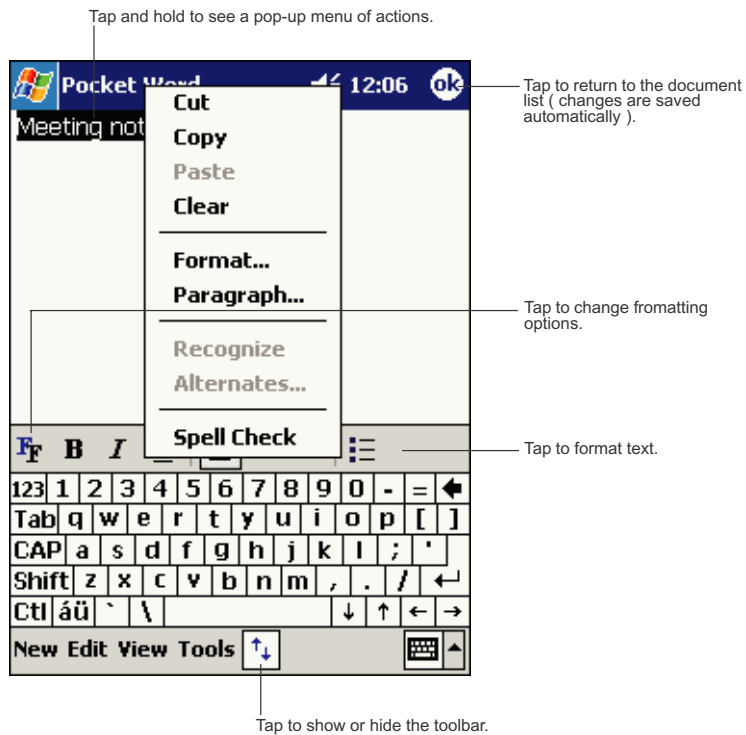



## Writing Mode

In writing mode, use your stylus to write directly on the screen. Ruled lines are displayed as a guide, and the zoom magnification is greater than in typing mode to allow you to write more easily. For more information on writing and selecting writing, see Chapter 2.

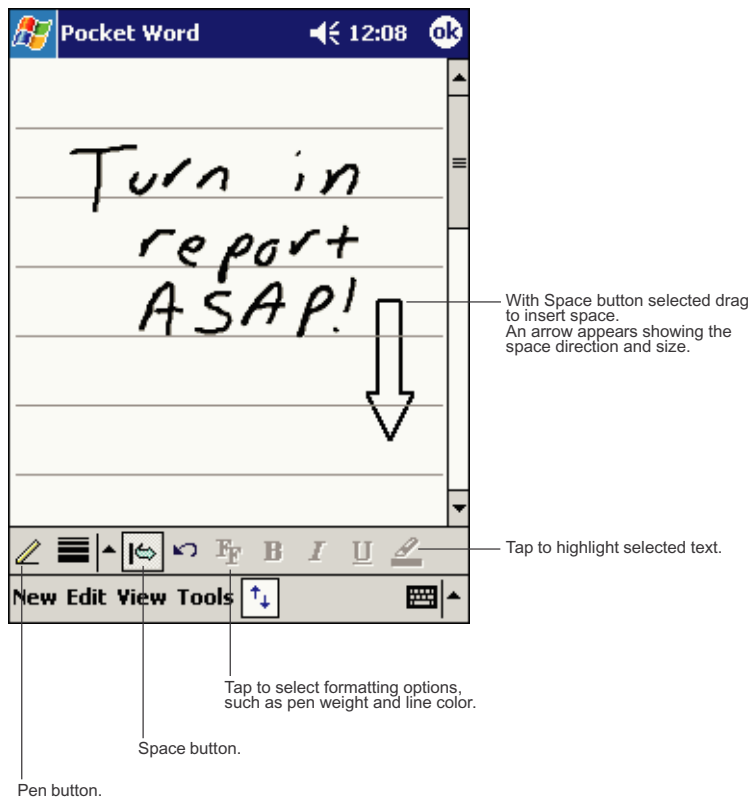

**G** If you cross three ruled lines in a single stylus stroke, the writing becomes a drawing, and can be edited and manipulated as described in the following section. Written words are converted to graphics (metafiles) when a Pocket Word document is converted to a Word document on your computer.

### Drawing Mode

In drawing mode, use your stylus to draw on the screen. Gridlines appear as a guide. When you lift your stylus off the screen after the first stroke, you'll see a drawing box indicating the boundaries of the drawing. Every subsequent stroke within or touching the drawing box becomes part of the drawing. For more information on drawing and selecting drawings, see Chapter 2.

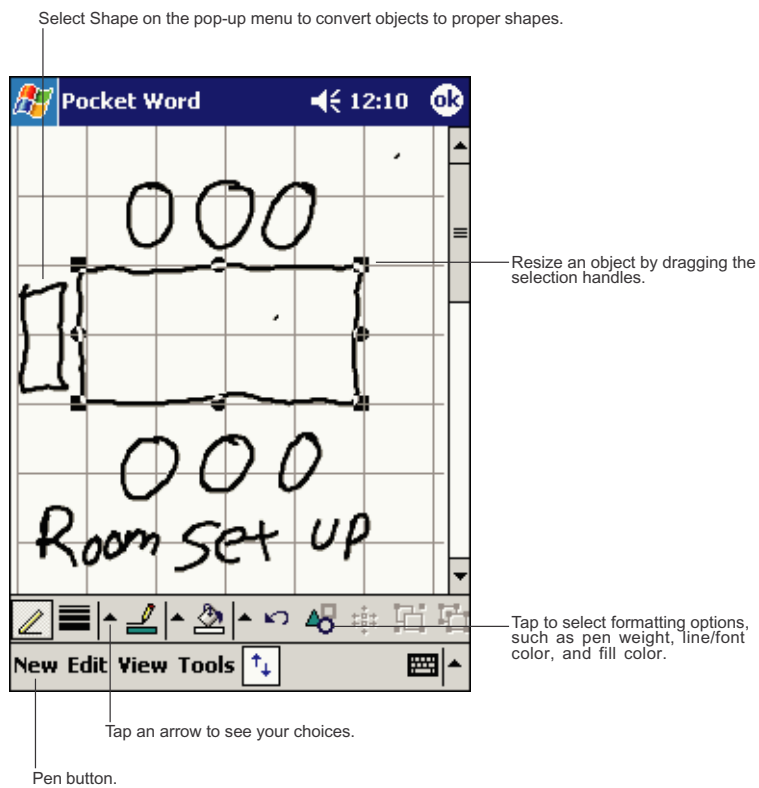

### Recording Mode

In recording mode, embed a recording into your document. Recordings are saved as .wav files. For more information on recording, see Chapter 2.

For more information on using Pocket Word, tap  and then **Help**.

## Pocket Excel

Pocket Excel works with Microsoft Excel on your computer to give you easy access to copies of your workbooks. You can create new workbooks on your device, or you can copy workbooks from your computer to your device. Synchronize workbooks between your computer and your device so that you have the most up-to-date content in both locations.

Use Pocket Excel to create workbooks, such as expense reports and mileage logs. To create a new file, tap , **Programs**, **Pocket Excel**, and then **New**. A blank workbook appears. Or, if you've selected a template for new workbooks in the **Options** dialog box, that template appears with appropriate text and formatting already provided. You can open only one workbook at a time; when you open a second workbook, you'll be asked to save the first. You can save a workbook you create or edit in a variety of formats, including Pocket Excel (.pxl) and Excel (.xls).

Pocket Excel contains a list of the files stored on your device. Tap a file in the list to open it. To delete, make copies of, and send files, tap and hold a file in the list. Then select the appropriate action from the pop-up menu.

Pocket Excel provides fundamental spreadsheet tools, such as formulas, functions, sorting, and filtering. To display the toolbar, tap **View** and then **Toolbar**.

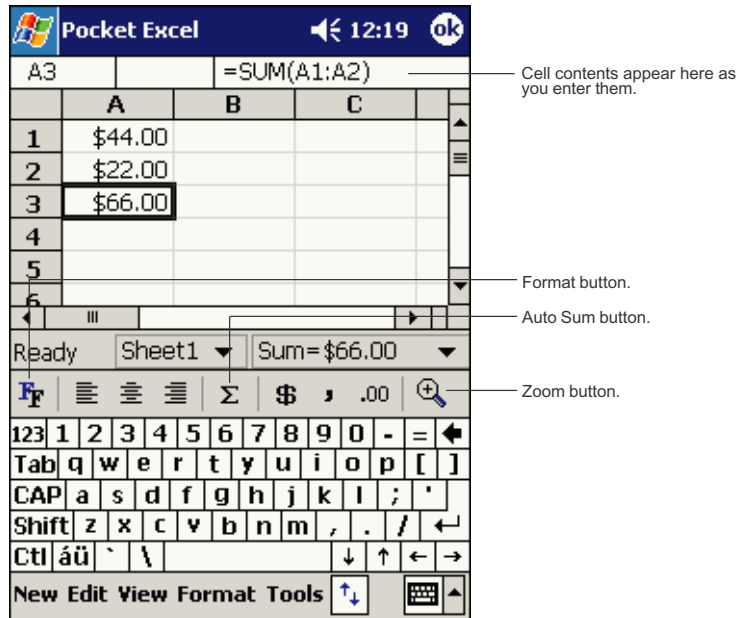

 If your workbook contains sensitive information, you can protect it with a password. To do so, open the workbook, tap **Edit**, and then **Password**. Every time you open the workbook, you will need to enter the password, so choose one that is easy for you to remember but hard for others to guess.

### Tips for Working in Pocket Excel

Note the following when working in large worksheets in Pocket Excel:

- View in full-screen mode to see as much of your worksheet as possible. Tap **View** and then **Full Screen**. To exit full-screen mode, tap **Restore**.
- Show and hide window elements. Tap **View** and then tap the elements you want to show or hide.
- Freeze panes on a worksheet. First select the cell where you want to freeze panes. Tap **View** and then **Freeze Panes**. You might want to freeze the top and leftmost panes in a worksheet to keep row and column labels visible as you scroll through a sheet.
- Split panes to view different areas of a large worksheet. Tap **View** and then **Split**. Then drag the split bar to where you want it. To remove the split, tap **View** and then **Remove Split**.
- Show and hide rows and columns. To hide a hidden row or column, select a cell in the row or column you want to hide. Then tap **Format**, then **Row** or **Column**, and then **Hide**. To show a hidden row or column, tap **Tools**, then **Go To**, and then type a reference that is in the hidden row or column. Then tap **Format**, then **Row** or **Column**, and then **Unhide**.

For more information on using Pocket Excel, tap  and then **Help**.

## MSN Messenger

MSN® Messenger on your mobile device is an instant messaging program that lets you:

- See who is online.
- Send and receive instant messages.
- Have instant message conversations with groups of contacts.

To use MSN Messenger, you must have a Microsoft Passport™ account or a Microsoft Exchange e-mail account. You must have a Passport to use MSN Messenger Service. If you have a Hotmail® or MSN account, you already have a Passport. Once you have obtained either a Microsoft Passport or a Microsoft Exchange account, you are ready to set up your account.



Sign up for a Microsoft Passport account at <http://www.passport.com>.  
Get a free Microsoft Hotmail e-mail address at <http://www.hotmail.com>.

To switch to MSN Messenger, tap , **Programs**, and then tap **MSN Messenger**.

### Setting Up

Before you can connect, you must enter Passport or Exchange account information.

#### To set up an account and sign in:

1. In the **Tools** menu, tap **Options**.
2. In the **Accounts** tab, enter your Passport or Exchange account information.
3. To sign in, tap the sign-in screen and enter your e-mail address and password.



If you already use MSN Messenger on your computer, your contacts will show up on your device without being added again.

### Working with Contacts

The MSN Messenger window shows all of your messenger contacts at a glance, divided into Online and Not Online categories. From this view, while connected, you can chat, send an e-mail, block the contact from chatting with you, or delete contacts from your list using the pop-up menu.

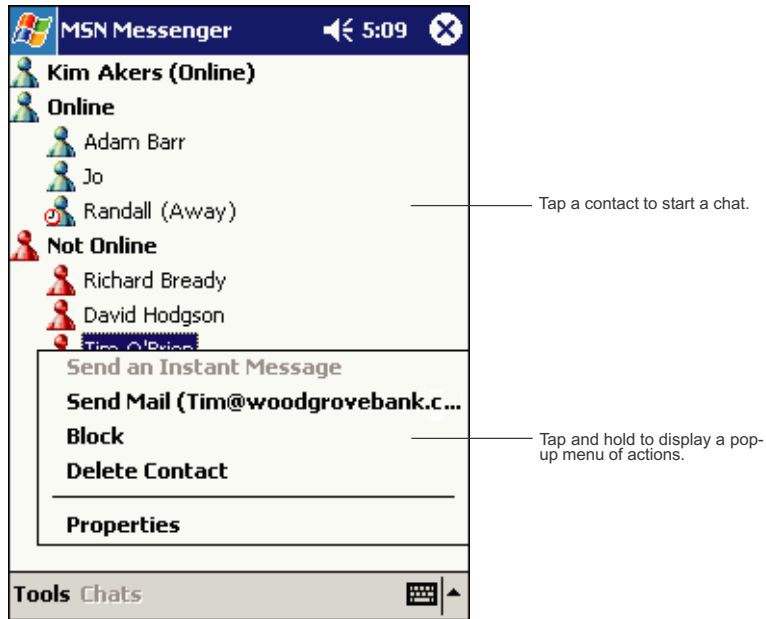



 To see others online without being seen, in the **Tools** menu, tap **My Status** and select **Appear Offline**.

*If you block a contact, you will appear offline but will remain on the blocked contact's list. To unblock a contact, tap and hold the contact, then tap **Unblock** on the pop-up menu.*

## Chatting with Contacts

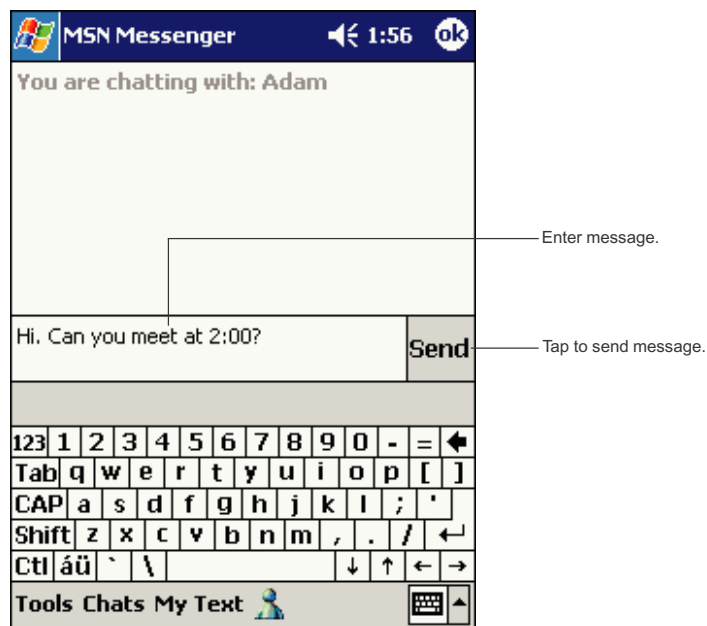
Tap a contact name to open a chat window. Enter your message in the text entry area at the bottom of the screen, or tap **My Text** to enter a preset message, and tap **Send**. To invite another contact to a multi-user chat, in the **Tools** menu, tap **Invite** and tap the contact you want to invite.



 To switch back to the main window without closing a chat, tap the **Contacts** button. To revert back to your chat window, tap **Chats** and select the person whom you were chatting with.



To know if the contact you are chatting with is responding, look for the message under the text entry area.



For more information on using MSN Messenger, tap  and then **Help**.

## Windows Media Player

Use Microsoft Windows Media Player to play digital audio and video files that are stored on your device or on a network. To switch to Windows Media Player for Toshiba Pocket PC e750, tap  and then tap **Windows Media**.

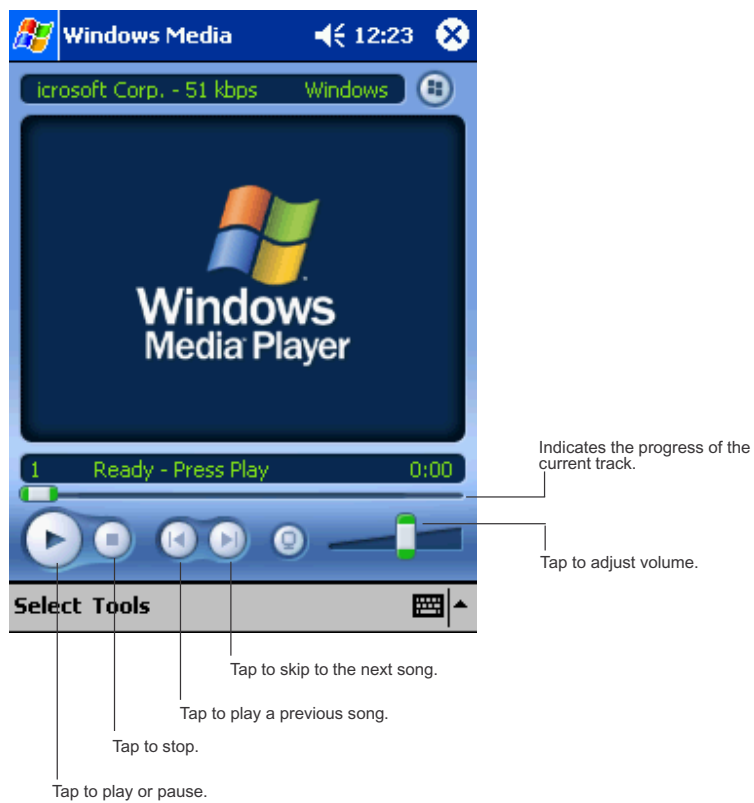

Use Microsoft Windows Media Player on your computer to copy digital audio and video files to your Toshiba Pocket PC e750. You can play Windows Media and MP3 files on your Toshiba Pocket PC e750.

For more information about using Windows Media Player for Toshiba Pocket PC e750, tap , and then tap **Help**.

## Microsoft Reader

Use Microsoft Reader to read eBooks on your device. Download books to your computer from your favorite eBook Web site. Then, use ActiveSync to copy the book files to your activated device. The books appear in the Reader Library, where you can tap them in the list to open them.

Each book consists of a cover page, an optional table of contents, and the pages of the book. You can:

- Page through the book by using the Up/Down control on your device or by tapping the page number on each page.
- Annotate the book with highlighting, bookmarks, notes, and drawings.
- Search for text and look up definitions for words.

The Guidebook contains all the information you'll need to use the software. To open the Guidebook, tap **Help** on the Reader command bar. Or, on a book page, tap and hold on the book title, and then tap **Help** on the pop-up menu.

To switch to Microsoft Reader, tap , **Programs**, and then **Microsoft Reader**.

### Getting Books on Your Device

You can download book files from the Web. Just visit your favorite eBook retailer and follow the instructions to download the book files.

Sample books and a dictionary are also included in the MSReader folder in the Extras folder on the Toshiba Pocket PC e750 Companion CD.

Use ActiveSync to download the files from your computer to your activated device as described in the Read Me file in the MSReader folder.

### Using the Library

The Library is your Reader home page; it displays a list of all books stored on your device or storage card.

To open the Library:

- On the Reader command bar, tap **Library**.
- On a book page, tap the book title, and then tap **Library** on the pop-up menu.

To open a book, tap its title in the Library list.

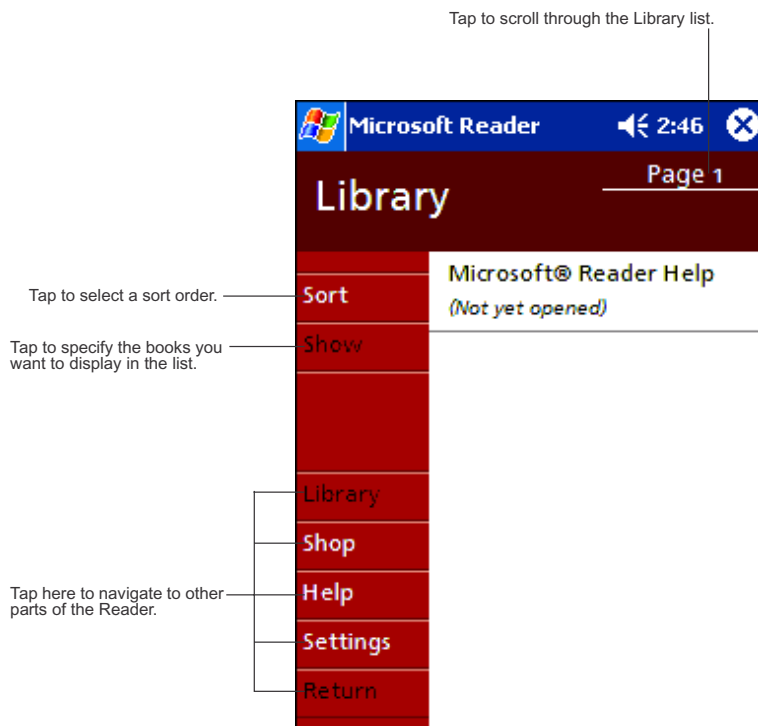

## Reading a Book

Each book consists of a cover page, an optional table of contents, and the pages of the book. Navigation options are listed in the bottom portion of the cover page.

The first time you open a book, you'll probably want to go to the first page or to the table of contents, if there is one. Subsequently, whenever you open the book, you'll be automatically taken to the last page read.

In addition to the text, each book page includes a page number and book title.

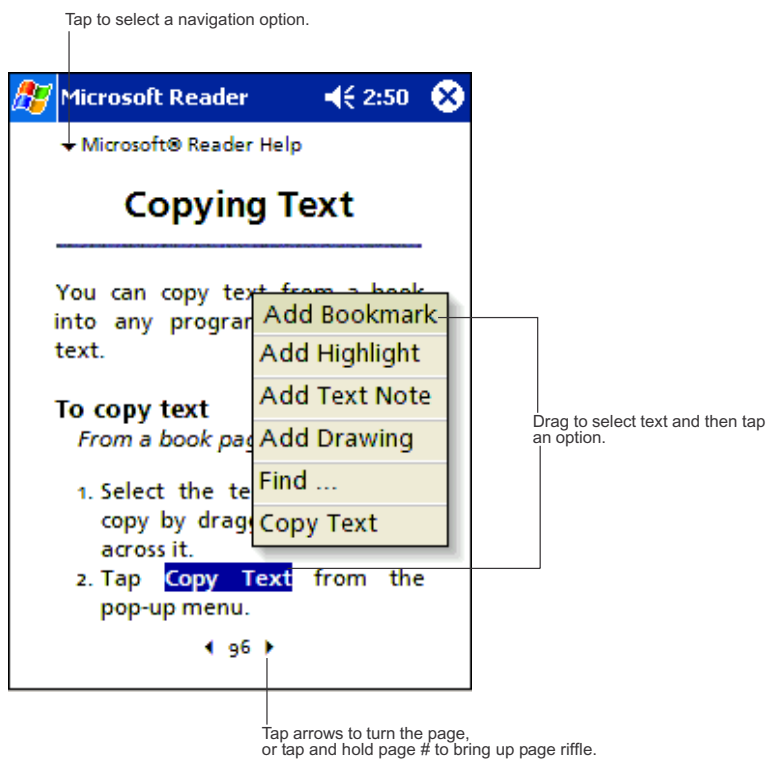

You can also page through a book by using the Up/Down control on your device.

### Using Reader Features

Reading a book electronically gives you several options not available with paper books. These options are available from any book page.

Select text by dragging across the text on the page. Then, tap an option on the pop-up menu, as described here:

- **Search for Text.** Find text in a book by tapping **Find** on the pop-up menu. Enter the word you want to search for, and tap the desired **Find** option. Reader highlights found text on the page. To close **Find**, tap outside the box. To return to your original page, tap the title and then tap **Return** on the pop-up menu.
- **Copy Text.** You can copy text from books that support this feature into any program that accepts text. On a book page, select the text you want to copy. Then, tap **Copy Text** on the pop-up menu. The text can be pasted into the program of your choice.
- **Bookmarks.** When you add a bookmark to a book, a color-coded bookmark icon appears in the right margin. You can add multiple bookmarks to a book. Then, from anywhere in the book, tap the bookmark icon to go to the bookmarked page.
- **Highlights.** When you highlight text, it appears with a colored background.
- **Notes.** When you attach a note to text, you enter the text in a note pad that appears on top of the book page. A Note icon will display in the left margin. To show or hide the note, tap the icon.
- **Drawings.** When you add a drawing, a Drawing icon appears in the bottom-left corner of the page, and drawing tools appear across the bottom of the page. Draw by dragging your stylus.
- To see a list of a book's annotations, including bookmarks, highlights, text notes, and drawings, tap **Annotations Index** on the book's cover page. You can tap an entry in the list to go to the annotated page.

### **Removing a Book**

When you finish reading a book, you can delete it to conserve space on your device. If a copy of the book is stored on your computer, you can download it again at any time.

To remove a book from your device, tap and hold the title in the Library list, and then tap **Delete** on the pop-up menu.

## Chapter 6:

# Pocket Internet Explorer

Use Microsoft® Pocket Internet Explorer to view Web or WAP pages in either of these ways:

- During synchronization with your desktop computer, download your favorite links and mobile favorites that are stored in the Mobile Favorites subfolder in Internet Explorer on the desktop computer.
- Connect to an Internet service provider (ISP) or network and browse the Web. To do this, you'll need to create the connection first, as described in Chapter 7.

When connected to an ISP or network, you can also download files and programs from the Internet or intranet.

To switch to Pocket Internet Explorer, tap  and then **Internet Explorer**.

## The Mobile Favorites Folder

Only items stored in the Mobile Favorites subfolder in the Favorites folder in Internet Explorer on your desktop computer will be synchronized with your device. This folder was created automatically when you installed ActiveSync.

## Favorite Links

During synchronization, the list of favorite links in the Mobile Favorites folder on your desktop computer is synchronized with Pocket Internet Explorer on your device. Both computers are updated with changes made to either list each time you synchronize. Unless you mark the favorite link as a mobile favorite, only the link will be downloaded to your device, and you will need to connect to your ISP or network to view the content. For more information on synchronization, see ActiveSync Help on the desktop computer.



## Mobile Favorites

If you are using Microsoft Internet Explorer 5.0 or later on your desktop computer, you can download mobile favorites to your device. Synchronizing mobile favorites downloads Web content to your device so that you can view pages while you are disconnected from your ISP and desktop computer.

Use the Internet Explorer plug-in installed with ActiveSync to create mobile favorites quickly.

### To create a mobile favorite:

1. In Internet Explorer on your desktop computer, click **Tools** and then **Create Mobile Favorite**.
2. To change the link name, enter a new name in the **Name** box.
3. In **Update**, select a desired update schedule.
4. Click **OK**. Internet Explorer downloads the latest version of the page to your desktop computer.
5. If you want to download the pages that are linked to the mobile favorite you just created, in Internet Explorer on the your PC, right-click the mobile favorite and then click **Properties**. In the **Download** tab, specify the number of links deep you want to download. To conserve device memory, go only one level deep.
6. Synchronize your device and desktop computer. Mobile favorites that are stored in the Mobile Favorites folder in Internet Explorer are downloaded to your device.



*If you did not specify an update schedule in step 3, you will need to manually download content to keep the information updated on your desktop computer and device. Before synchronizing with your device, in Internet Explorer on your desktop computer, click **Tools** and then **Synchronize**. You will see the last time content was downloaded to the desktop computer, and you can manually download content if needed.*

*You can add a button to the Internet Explorer toolbar for creating mobile favorites. In Internet Explorer on your desktop computer, click **View, Toolbars**, and then **Customize**.*

### To save device memory

Mobile favorites take up storage memory on your device. To minimize the amount of memory used:

- In the settings for the Favorites information type in ActiveSync options, turn off pictures and sounds, or stop some mobile favorites from being downloaded to the device. For more information, see ActiveSync Help.
- Limit the number of downloaded linked pages. In Internet Explorer on the desktop computer, right-click the mobile favorite you want to change and then **Properties**. In the **Download** tab, specify 0 or 1 for the number of linked pages you want to download.

## Using AvantGo Channels

AvantGo is a free interactive service that gives you access to personalized content and thousands of popular Web sites. You subscribe to AvantGo channels directly from your device. Then, you synchronize your device and desktop computer, or connect to the Internet to download the content. For more information, visit the AvantGo Web site.

### To sign up for AvantGo:

1. In ActiveSync options on the desktop computer, turn on synchronization for the AvantGo information type.
2. In Pocket Internet Explorer on your device, tap the Favorites button to display your list of favorites.
3. Tap the AvantGo Channels link.
4. Tap the Activate button.
5. Follow the directions on the screen. You will need to synchronize your device with your desktop computer and then tap the My Channels button to complete the AvantGo setup.

When synchronization is complete, tap the AvantGo Channels link in your list of favorites to see a few of the most popular channels. To add or remove channels, tap the **Add** or **Remove** link.

## Using Pocket Internet Explorer

You can use Pocket Internet Explorer to browse mobile favorites and channels that have been downloaded to your device without connecting to the Internet. You can also connect to the Internet through an ISP or a network connection and browse the Web.



**To view mobile favorites and channels:**

1. Tap the Favorites button to display your list of favorites.

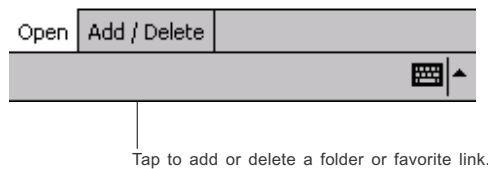
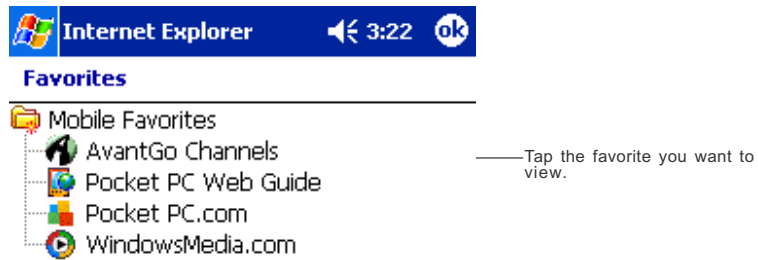

2. Tap the page you want to view.

You'll see the page that was downloaded the last time you synchronized with your desktop computer. If the page is not on your device, the favorite will be dimmed. You will need to synchronize with your desktop computer again to download the page to your device, or connect to the Internet to view the page.

**To browse the Internet:**

1. Set up a connection to your ISP or corporate network using **Connections**, as described in Chapter 7.
2. To connect and start browsing, do one of the following:
  - Tap the Favorites button, and then tap the favorite you want to view.
  - Tap **View** and then **Address Bar**. In the address bar that appears at the top of the screen, enter the Web address you want to visit and then tap **Go**. Tap the arrow to choose from previously entered addresses.



*To add a favorite link while using the device, go to the page you want to add, tap and hold on the page, and tap **Add to Favorites**.*

## Getting Connected

You can use your device to exchange information with other mobile devices as well as your computer, a network, or the Internet. You have the following connection options:

- Use the infrared (IR) port on your device to send and receive files between two devices. If this is the method you want to use, see the following section “Transfer Items Using Infrared.”
- Connect to your Internet service provider (ISP). Once connected, you can send and receive e-mail messages by using Inbox and view Web or WAP pages by using Microsoft® Pocket Internet Explorer. The communication software for creating an ISP connection is already installed on your device. Your service provider will provide software needed to install other services, such as paging and fax services. If this is the method you want to use, see “Connect to an Internet Service Provider” later in this chapter.
- Connect to the network at your company or organization where you work. Once connected, you can send and receive e-mail messages by using Inbox, view Web or WAP pages by using Pocket Internet Explorer, and synchronize with your computer. If this is the method you want to use, see “Connect to Work” later in this chapter.
- Connect to your computer to synchronize remotely. Once connected, you can synchronize information such as your Pocket Outlook information. If this is the method you want to use, see ActiveSync Help on your computer or Connections Help on the device.

### Transfer Items Using Infrared

Using infrared (IR), you can send and receive information, such as contacts and appointments, between two devices.

#### To send information:

1. Switch to the program where you created the item you want to send and locate the item in the list.
2. Align the IR ports so that they are unobstructed and within a close range.
3. Tap and hold the item, and tap **Beam Item** on the pop-up menu.



You can also send items, but not folders, from File Explorer. Tap and hold the item you want to send, and then tap **Beam File** on the pop-up menu.

#### To receive information:

1. Align the IR ports so that they are unobstructed and within a close range.
2. Have the owner of the other device send the information to you. Your device will automatically receive it.

## Connect to the Internet

You can connect to your ISP, and use the connection to send and receive e-mail messages and view Web or WAP pages.

You can connect to work in one of two ways:

- Create a modem connection. If this is the method you want to use, see "To create a modem connection to an ISP."
- Use an Ethernet card and a net tap to connect to the network. If this is the method you want to use, see "To create an Ethernet connection to an ISP."

#### To create a modem connection to an ISP:



1. Obtain the following information from your ISP: ISP dial-up access telephone number, user name, password, and TCP/IP settings. Some ISPs require information in front of the user name, such as MSN/username.
2. If your device does not have a built-in modem, install a modem card, or use or use a NULL modem cable and appropriate adapters to connect an external modem to your device through the serial port.
3. Tap  and then **Settings**. In the **Connections** tab, tap **Connections**. Under The Internet settings, select **Internet Settings** and tap **Modify**.
4. In the **Modem** tab, tap **New**.
5. Enter a name for the connection, such as "ISP Connection."
6. In the **Select a modem** list, select your modem type. If your modem type does not appear, try reinserting the modem card. If you are using an external modem that is connected to your device with a cable, select **Hayes Compatible on COM1**.
7. You should not need to change any settings in **Advanced**. Most ISPs now use a dynamically-assigned address. If the ISP you are connecting to does not use a dynamically-assigned address, tap **Advanced** and then the **TCP/IP** tab, and enter the address. When finished, tap **OK** and then **Next**.

8. Enter the access phone number, and tap **Next**.
9. Select other desired options, and tap **Finish**.
10. In the **Dialing Locations** tab, specify your current location and phone type (most phone lines are tone). These settings will apply to all connections you create.

To start the connection, simply start using one of the following programs. Your device will automatically begin connecting. Once connected, you can:

- Send and receive e-mail messages by using Inbox. Before you can use Inbox, you need to provide the information it needs to communicate with the e-mail server. For specific instructions, see “Connect Directly to an E-mail Server,” later in this chapter.
- Visit Web and WAP pages by using Pocket Internet Explorer. For more information, see Chapter 6.
- Send and receive instant messages with MSN Messenger. For more information, see “MSN Messenger” in Chapter 5.

**To create an Ethernet connection to an ISP:**

1. You do not need to create a new connection on your device. Instead, you must purchase and configure an Ethernet card that is compatible with your device.
2. Obtain the following information from your ISP: user name, password, and domain name.
3. Insert the Ethernet card into your device. For instructions on inserting and using the Ethernet card, see the owner’s manual for the card.
4. The first time you insert the card, **Network Settings** will appear automatically so that you can configure the Ethernet card. Most networks use DHCP, so you should not have to change these settings unless your network administrator instructs you to do so. Tap **OK**. (If it does not appear or to change settings later, tap  and then **Settings**. In the **Connections** tab, tap **Network Adapters**, tap the adapter you want to change, and then tap **Properties**.)
5. Connect the Ethernet card to the network by using a network cable. For information, see your owner’s manual.
6. Tap , **Settings, Connections** tab, and then **Connections**. From the **My network card connects to** list, select **The Internet**.

To start the connection, simply start using one of the programs listed in the preceding section. Once connected, you can perform the same activities as listed in the preceding section.



## Connect to Work

If you have access to a network at work, you can send e-mail messages, view intranet pages, synchronize your device, and possibly access the Internet. You can connect to work in one of two ways:

- Create a modem connection by using a RAS account. Before you can create this modem connection, your network administrator will need to set up a RAS account for you. If this is the method you want to use, see "To create a modem connection to a network." Your network administrator may also give you VPN settings.
- Use an Ethernet card and a net tap to connect to the network. If this is the method you want to use, see "To create an Ethernet connection to a network."



### To create a modem connection to a network:

1. Get the following information from your network administrator: dial-up access telephone number, user name, password, domain name, and TCP/IP settings.
2. If your device does not have a built-in modem, install a modem card.
3. Tap  and then **Settings**. In the **Connections** tab, tap **Connections**. Under The Internet settings, select **Internet Settings** and tap **Modify**.
4. In the **Modem** tab, tap **New**.
5. Enter a name for the connection, such as "Company Connection."
6. In the **Select a modem** list, select your modem type. If your modem type does not appear, try reinserting the modem card. If you are using an external modem that is connected to your device with a cable, select **Hayes Compatible on COM1**.
7. You should not need to change any settings in **Advanced**. Most servers now use a dynamically-assigned address. If the server you are connecting to does not use a dynamically-assigned address, tap **Advanced** and then the **TCP/IP** tab and enter the address. When finished, tap **OK** and then **Next**.
8. Enter the access phone number, and tap **Next**.
9. Select other desired options, and tap **Finish**.
10. In the **Dialing Locations** tab, specify your current location and phone type (most phone lines are tone). These settings will apply to all connections you create.

To start the connection, simply start using one of the following programs. Your device will automatically begin connecting. Once connected, you can:

- Send and receive e-mail messages by using Inbox. Before you can use Inbox, you need to provide the information it needs to communicate with the e-mail server. For specific instructions, see “Connect Directly to an E-mail Server,” later in this chapter.
- Visit Internet or intranet Web or WAP pages by using Pocket Internet Explorer.
- Send and receive instant messages with MSN Messenger. For more information, see “MSN Messenger” in Chapter 5.
- Synchronize. For more information, see ActiveSync Help on the computer.

**To create an Ethernet connection to a network:**

1. You do not need to create a new connection on your device. Instead, you must purchase and configure an Ethernet card that is compatible with your device.
2. Get the following information from your network administrator: user name, password, and domain name.
3. Insert the Ethernet card into your device. For instructions on inserting and using the Ethernet card, see the owner’s manual for the card.
4. The first time you insert the card, Network Settings will appear automatically so that you can configure the Ethernet card. Most networks use DHCP, so you should not have to change these settings unless your network administrator instructs you to do so. Tap **OK**. (If it does not appear or to change settings later, tap  and then **Settings**. On the **Connections** tab, tap **Network Adapter**, tap the adapter you want to change, and then tap **Properties**.)
5. Connect the Ethernet card to the network by using a network cable. For information, see your owner’s manual.
6. Tap , **Settings**, **Connections** tab, and then **Connections**. From the My network card connects to list, select **Work**.
7. If you want to synchronize your device, tap , and then **ActiveSync**. In the Tools menu, tap **Options**. In the PC tab, select **Include PC** when synchronizing remotely and connect to, and select your computer’s name. Remote synchronization with a computer will work only if you have set up a partnership with that computer through ActiveSync and have set ActiveSync to allow remote connections. Other restrictions apply. For more information on synchronizing remotely, see ActiveSync Help on the computer.

To start the connection, simply start using one of the programs listed in the preceding section. Once connected, you can perform the same activities as listed in the preceding section.

## End a Connection

To disconnect, do one of the following:

- When connected via dial-up or VPN, tap the Connection icon, , on your navigation bar, and then tap **End**.
- When connected via cable or cradle, detach your device from the cable or cradle.
- When connected via Infrared, move the device away from the PC.
- When connected via a network (Ethernet) card, remove the card from your device.

## Connect Directly to an E-mail Server

You can set up a connection to an e-mail server so that you can send and receive e-mail messages by using a modem or network connection and Inbox on your device.



*The ISP or network must use a POP3 or IMAP4 e-mail server and an SMTP gateway.*

You can use multiple e-mail services to receive your messages. For each e-mail service you intend to use, first set up and name the e-mail service. If you use the same service to connect to different mailboxes, set up and name each mailbox connection.

### To set up an e-mail service:

- In Inbox on your device, tap **Services**, and then **New Service**. Follow the directions in the New Service wizard.

For an explanation of a screen, tap  and then **Help**. When finished, to connect to your e-mail server, tap **Services** and then **Connect**. For more information on using the Inbox program, see "Inbox: Sending and Receiving E-mail Messages" in Chapter 4.

## Get Help on Connecting

More information on the procedures described here, as well as information on additional procedures, can be found in the following locations:

- "Inbox: Sending and Receiving E-mail Messages" in Chapter 4.
- Online Help on the device. Tap  and then **Help**. Tap **View**, **All Installed Help**, and then **Inbox** or **Connections**.
- ActiveSync Help on the computer. In ActiveSync, click **Microsoft ActiveSync Help** on the **Help** menu.
- For troubleshooting information, see the Pocket PC Web site at: <http://www.microsoft.com/mobile/pocketpc>

Chapter 8:

## Wi-Fi (IEEE 802.11b)

## Wireless LAN

### Overview



*This chapter is valid for WLAN model only.*

The IEEE 802.11b WLAN Adapter can connect your Toshiba Pocket PC e750/e755 wirelessly to the existing IEEE 802.11b wireless networks or form its own Wireless Network. Using the adapter in the Toshiba Pocket PC e750/e755, you can enjoy the complete mobile and high-speed wireless Internet connectivity while in range of a Wi-Fi compatible access point.

RF Exposure Warning Statement:

This device has been evaluated for FCC RF exposure compliance as portable device for lap held position and with 1.5cm separation distance from the transmitting antenna to the near by person. To comply with FCC RF exposure compliance requirements, this device and its antenna must not be co-located or operating in conjunction with any other antenna or transmitter.

This device has not been investigated for FCC RF exposure compliance for portable configuration with any other antenna or transmitter except for the WLAN transmitter installed by Toshiba Corp. CF Card Slot or SD Card Slot can not be used for adding any other transmitter.

## Configuration

To configure your Wireless settings, click the Wireless LAN icon and tap the "Config" button.



In order to Turn Off your Wireless LAN radio connection, click the Wireless icon and tap the "Turn Off" button. If the connection is turned off the WLAN icon will have a cross marked across the icon. Tap the icon to turn on and configure the Wireless settings.



## IP Address Page

Use IP Address Page to view and edit the **IP address**, **Subnet mask** and **Default gateway**.

Click Start→Settings→Connections→Network Adapters→ “IEEE 802.11b WLAN Adapter”→Properties→IP Address

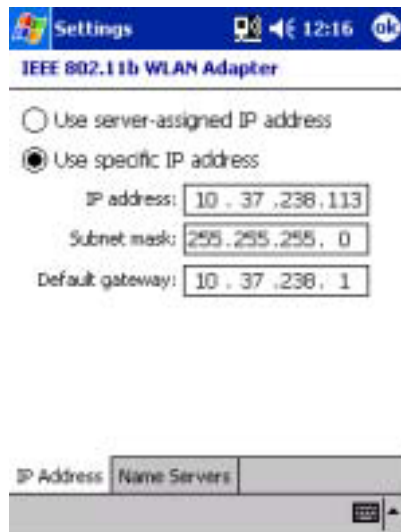

- **IP Address:**

IP Address is Internet Protocol Address; a numeric address such as 10.37.238.100 that the domain name server translates into a domain name. Each node on the IP network should have a unique IP address.

- **Subnet mask:**

A number used to identify a subnetwork when multiple networks share an IP address. For example 255.255.255.0

- **Default gateway:**

This is a device used to forward IP packets to and from a remote destination.

 Please check with your network administrator for these connection settings.

## Name Servers Page

Use Name Servers Page to view and edit **DNS**, **Alt DNS**, **WINS** and **Alt WINS**.

Start→Settings→Connections→Network Adapters→“IEEE 802.11b WLAN Adapter” →Properties→Name Servers



- **DNS:**  
Domain Name System is a database system that translates addresses and domain names. For example, a numeric address like 232.245.021.54 can become something like cba.com. DNS can also be used to control Internet email delivery.
- **WINS:**  
In Toshiba Pocket PC e750/e755, Windows Internet Naming Service has two functions; one is a Microsoft Net BIO name server that eliminates the broadcasts needed to resolve computer names to IP addresses by providing a cache or database of translations. The other one is to set the IP address of the host computer that you already construct the partnership for Network adapter Active sync purpose.  
 *Without setting the host computer's IP address in the WINS, you cannot wirelessly synchronize your Pocket PC with your host computer.*
- **Alt DNS:**  
Alt DNS stands for Alternative Domain Name System. Used to substitute main DNS when necessary.
- **Alt WINS:**  
Alt WINS stands for Alternative Windows Internet Naming Service. Used to substitute main WINS when necessary.

### Link Page

Use the Link page to view **SSID**, **Channel**, **TxRate**, **BSSID**, **IP Address**, **Subnet Mask** and **Gateway**.

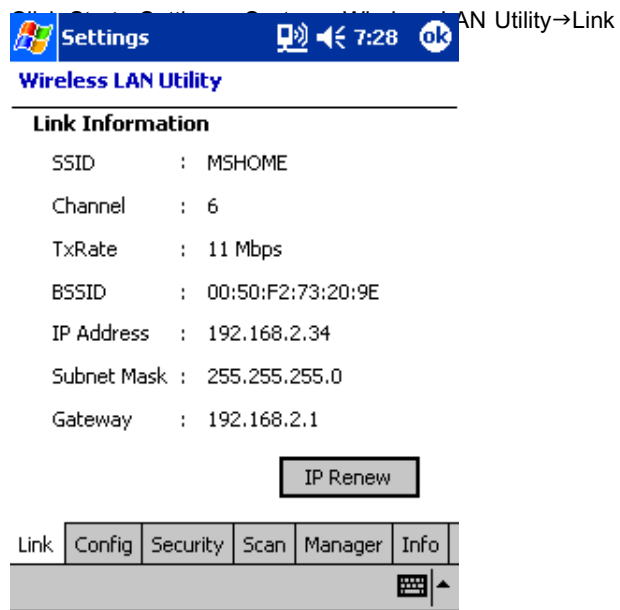

- **SSID:** Displays the SSID currently connected to the access point or 802.11 ad hoc network.
- **Channel:** Indicates the channel currently in use for Access Point or 802.11 Ad Hoc network.
- **TxRate:** Indicates the current data transmission rate in use.
- **BSSID:** Displays the BSSID set on the access point or 802.11 ad hoc network.



- **IP Address:** Displays the IP address set.
- **Subnet Mask:** Displays the subnet mask set.
- **Gateway:** Displays the gateway IP address set.

### Configuration Page

Use the Configuration page to set the **Mode**, **SSID**, **Channel** and **Country**, and to **view Link Quality** as well.



Click Start→Settings→System→Wireless LAN Utility→Config

- **Mode:** Use the Mode pull-down menu to select the operating mode.  
Infrastructure – can connect to an access point or a network connected to an access point.  
802.11 Ad Hoc – This mode allows Wireless LAN Module to form its own local network where adapters communicate peer-to-peer without Access Points using a shared SSID.
- **SSID:** Service Set Identifier is a group name given to the groups that form the wireless LAN network, and up to 32 single-byte English characters and symbols may be used. With the default setting “ANY”, it will automatically connect to the highest performance access point among those it was able to scan.

- **Status:** shows whether or not the network is connected. If a connection has been successful, it shows "Authenticated". If it has failed, it displays the reason for this. This authentication concerns connection only, and does not necessarily indicate that the network is usable.
- **Channel:** In France, only channel 10 and 11 are available. In USA, Canada, Europe or Australia, you have 11 options: channel 1~11.

*If you cannot connect with the APs or the 802.11 Ad Hoc Network Stations, check if the channel been used is between 1~11. Using channels other than 1~11 will not enable the connection.*

The channel is set by the adapter, which starts the 802.11Ad Hoc network. Under 802.11Ad Hoc mode, the first station forms the 802.11 Ad Hoc network should choose a proper SSID and the channel for use. Other stations will only have the same SSID set to join the 802.11 Ad Hoc network automatically.

- **Rescan:** Used to search the proper Access Point close to the adapter.
- **Link Quality:** An indicator of how clearly the adapter can hear the Access Point.

• **Wired Equivalent Privacy (WEP)**

Wired Equivalent Privacy. 802.1x validation configuration can be performed.

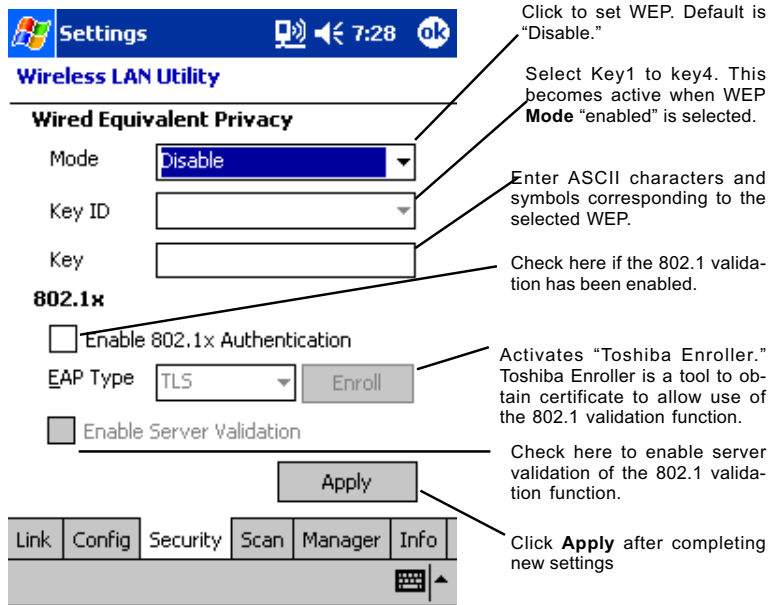

**Mode:**

The default WEP Mode setting is "Disable". You can choose "64 bits (ASCII)", "128 bits (ASCII)", "64 bits (HEX)" or "128 bits (HEX)" manually to enable the WEP or choose "Disable" to disable the WEP.

◆ **Disable:**

When in this mode, WEP does not function. When WEP does not function, there are risks relating to hacking or tapping by external persons, data loss or destruction. We strongly recommend using WEP.

◆ **64 bits (ASCII):**

5-digit ASCII characters or symbols can be entered in "Key".

✧ **128 bits (ASCII):**

13-digit ASCII characters or symbols can be entered in "Key".

✧ **64 bits (HEX):**

Hexadecimal 10-digit English letters and numerals can be entered in "Key". Letters and numerals that can be entered are 0-9 and A(a) - F(f).

✧ **128 bits (HEX):**

Hexadecimal 26-digit English letters and numerals can be entered in "Key". Letters and numerals that can be entered are 0-9 and A(a) - F(f).

✧ **Key ID:**

This becomes enabled when WEP is selected. Select Key1 - Key4.

✧ **Key:**

Enter the ASCII characters and symbols that correspond to the mode selected. Different characters can be entered, depending on the mode selected. Please refer to Wired Equivalent Privacy above. If "64 bits (ASCII)" or "128 bits (ASCII)" have been selected, input of letters or numerals above the upper limit is blocked. If "64 bits (HEX)" or "128 bits (HEX)" have been selected, a warning prompt appears if you enter anything other than the permitted numerals/letters.

✧ **Enable 802.1x authentication:**

Check here to enable 802.1x validation function.

✧ **EAP type:**

Select protocol for using 802.1x validation function.

✧ TLS (EAP-TLS)

Protocol used by Windows 2000 Server, etc.

✧ PEAP

Protocol use by Windows NET Server 2003, etc.

✧ **Enable server validation:**

When 802.1x validation is performed, this confirms whether it is connected to the right server. It should normally be checked for improved security.

Please ask your network administrator for further details.

### Scan Page

Use Scan page to scan and select scannable AP and Ad-hoc devices.

Click Start→Settings→System→Wireless LAN Utility→Scan

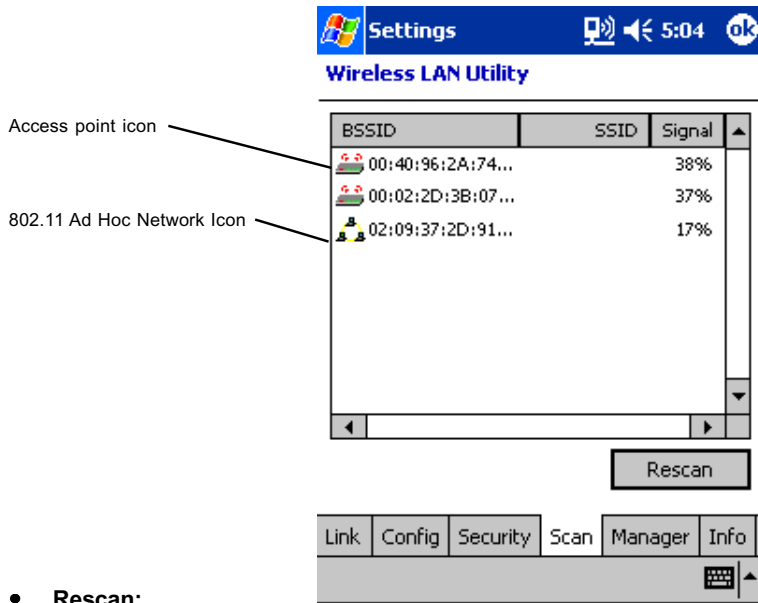

- **Rescan:**  
Rescan scannable Access Point(s) and Ad-hoc connectable Device(s). If you double tap menu after scanning, you can try to connect tapped AP or Ad-hoc device. If you are unable to see any Access points in that menu, check your access point setting. Some Access Points are set to refuse scanning.
- **Network Selection:**  
Each Access Point is identified by its BSSID and SSID. Double-click on the BSSID to choose the Access Point/802.11 Ad Hoc group you want to connect with.
- **Signal:**  
Indicates the signal strength of the Access Point.

### Manager Page

Click Start→Settings→System→Wireless LAN Utility→Manager

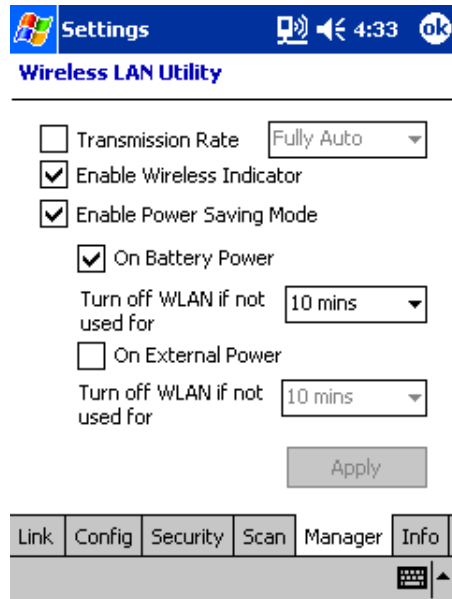

- **Transmission Rate:**  
Select the transmission rate to be used from the pull-down menu. If you select “Fully Auto”, the adapter is automatically set to the most suitable transmission rate.
- **Enable Wireless LAN Indicator:**  
If you check this, the wireless LAN indicator is displayed in the navigation bar.
- **Enable Power Saving Mode:** Check to use power saving mode
  - Battery Power** -- Check this to run in power saving mode when on battery power. Power is turned off if no transmission occurs during the specified time. Select time length from pull-down menu.
  - External Power** -- Check this to run in power-saving mode when on external power. Power is turned off if no transmission occurs during the specified time. Select time length from pull-down menu.

### Info Page

Use Info Page to view **MAC Address**, **Utility version**, **Driver version** and **Firmware version**.

Click Start→Settings→System→Wireless LAN Utility→Info



- **MAC Address:**

Displays Wireless LAN MAC Address. MAC (Media Access Control) Address is a hardware address that uniquely identifies each device of network.

- **Versions:**

**Firmware** -- Display FW version that included Wireless LAN hardware.

**Driver** -- Display Wireless LAN Driver version.

**Utility** -- Display Wireless LAN Driver version.

## Toshiba Enroller

Configure the "Toshiba Enroller" tool for obtaining and administering certificates used for 802.1x validation. Please ask your network administrator for configuration details.

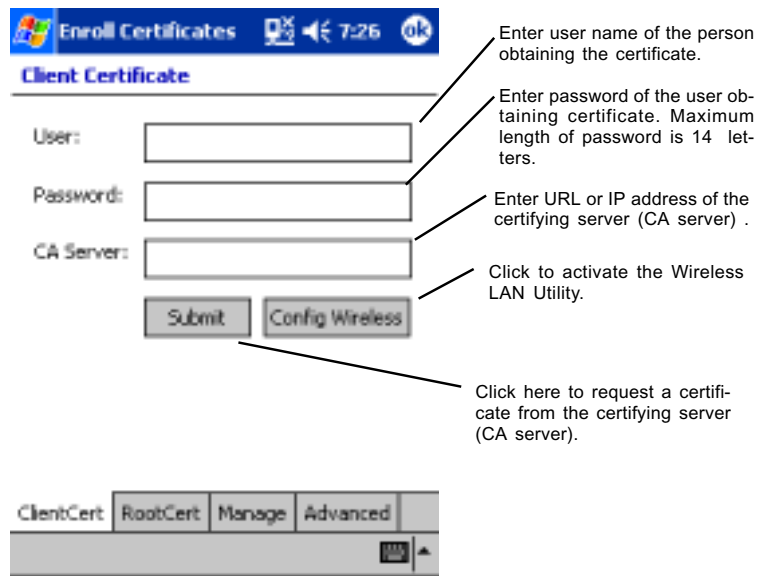



## Root Page



- **Open Certificate:**  
Opens the root certificate. When the root certificate is opened, the person it has been issued to, the persons issued by, and the period of validity will be displayed. The root certificate is provided by the cer file.
- **Install Certificate:**  
Registers the open root certificate in the system. This button is enabled when the root certificate is opened.

**Management Page**



- **Property:**  
Displays Information on certificates obtained.
- **Delete:**  
Deletes certificates. Please exercise caution when deleting certificates.

One client certificate and one root certificate are required at a minimum when using EAP-TLS, and one root certificate is required at a minimum when using PEAP.

### Advanced Page

Enroll Certificates 7:26 ok

**Advanced Settings**

Request Page:  
/certsrv/certifnsh.asp

Cert Template:  
/certsrv/certnew.cer?ReqId=%8&Enc=b64

Cert Attribute:  
CertificateTemplate%3AClientAuth%0D%0A

Apply Default

ClientCert RootCert Manage Advanced ok

- **Requested Page:**  
Portion of URL to be accessed when obtaining client certificates.
- **Cert Template:**  
Template used when obtaining client certificates.
- **Cert Attribute:**  
Attribute used when obtaining client certificates.





Under normal circumstances configuration is not needed unless requested by your network administrator.

## TMU-Traffic Monitoring Utility

TMU keeps users updated of current WLAN Module's activity status.



### Icon Specification

#### **Wireless Communication Switch off:**

Wireless Communication Switch, on the bottom of the PDA, is turned off. Clicking on the icon  gives you a warning message, "Please turn on Wireless communication switch". Click "OK" to close the Message Box. Turn on the switch and you will see the icon  turns to  or , depends on the original setting for the WLAN Module Power.







 **Wireless Communication Power off:**

The WLAN Module is at Power Off Status. Clicking on the icon  displays you 2 icons, "On" and "Off". Click "On" to turn on the Wireless LAN Module, and then the icon  turns to . Click "Off" to exit without turning on the Wireless LAN Module.



 **Wireless LAN Power on:**

The WLAN Module is at Power On Status. Clicking on the icon  displays you 2 icons, “On” and “Off”. Click “Off” to turn off the Wireless LAN Module, and then the icon  turns to . Click “On” to exit without turning off the Wireless LAN Module. To save power, the WLAN module can automatically switches power off after a period of inactivity (  turns to  ).

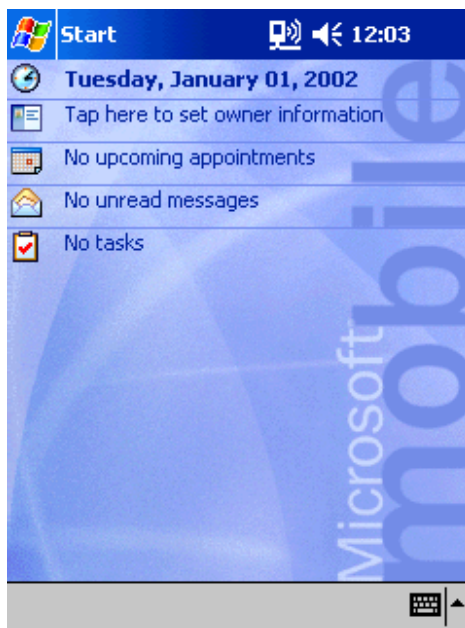



# Optional Functions

## Home

You can launch the built-in or installed applications easily by tapping the icon displayed on the Home screen. You can also set to display a desired image on your screen background.

### Launching an Application From the Home

1. Tap , **Programs**, and then **Home** to display the Home screen.

You can also launch the Home by pressing the Toshiba Pocket PC e750/e755 Home button .



For initial setting, the respective application icons are registered on three tabs: **Main**, **Programs** and **Games**. In the **Running** tab, active applications are displayed.

Tab.

Tap to select **Tab Setting...** or **About**.

Tap to select **Large Icon**, **Small Icon** or **Text color...**

Tap to select **Paste** or **Add**.

2. Tap the desired tab, and then tap the application icon you want to launch. The selected application starts up.



Also, you can launch an application by moving the cursor button or scroller to select and pressing the center of the cursor button to confirm.

You can add tabs up to a maximum of 10 kinds and icons up to 18 in a tab.

### About Running

In the **Running** tab, the active application names are displayed.

The icons do not appear.

#### Application Activate/Stop:

Tap the application name you want to activate. You can also activate the application from the pop-up menu displayed by tapping and holding the application name.

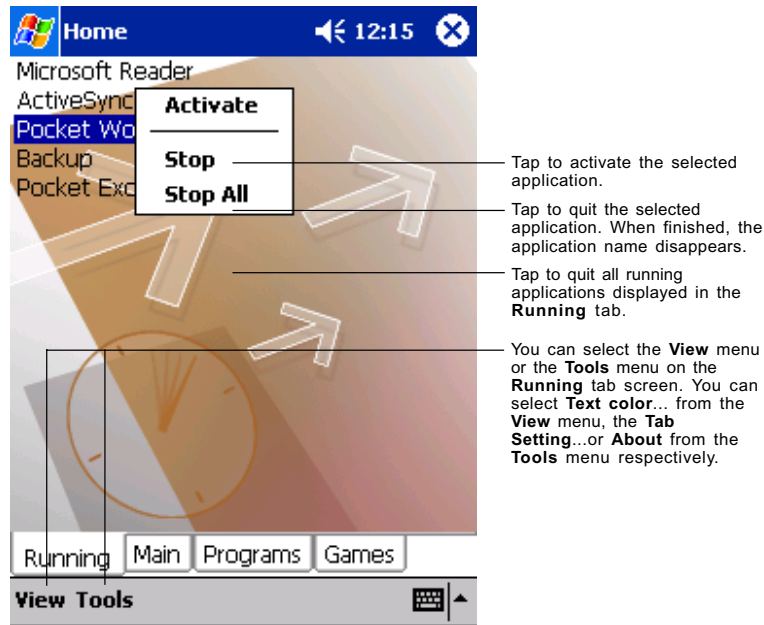















You can show a pop-up menu by tapping and holding any portion other than the application names displayed in the **Running** tab. In this case, only the **Stop All** is selectable.



### Display Icon List

The following list shows the tabs and icons for the initial setup.

Tabs	Icons	Applications
Running	—	—
Main		Pocket Internet Explorer
		Windows Media Player
		Notes
		Tasks
		Inbox
		Calendar
		Contacts
		Pocket Word
		Pocket Excel
		Calculator
Programs		File Explorer
		DataBackup
		Infrared Receive
Games		Solitaire

### Moving an Application Icon into Another Tab

The moved icon is placed next to the last icon on the tab screen. You cannot move an icon into a tab which already contains 18 icons.

#### To move using pop-up menu:

1. Tap and hold the icon you want to move to display the pop-up menu.
2. Tap **Cut** on the pop-up menu.
3. Tap the destination tab, and then tap **Paste** on **Edit** menu. The selected icon is pasted on the screen.



*You can also select **Paste** from the pop-up menu displayed by tapping and holding any portion other than the icon.*

### Deleting an Icon

1. Tap and hold the icon you want to delete to display the pop-up menu.
2. Tap **Drop** on the pop-up menu. The icon is deleted and the next icon positioned after the deleted icon automatically shifts to fill the deleted icon position. And all icons after the deleted icon likewise shift to fill the previous icon position.

## Adding an Icon

You can add the application and your file icons to the Home screen.

1. Tap **Edit** and then **Add** to display the Add Application screen.

You can also select **Add** from the pop-up menu displayed by tapping and holding any portion other than the icon.

2. Tap ▼ of Application file to show the file list. If there is no desired file on the file list, you can find it by tapping **Browse**. To refer to all folders and files, tap **Browse** to show the Browse Dialog screen. When the file is selected, its name is displayed in the Application file box.

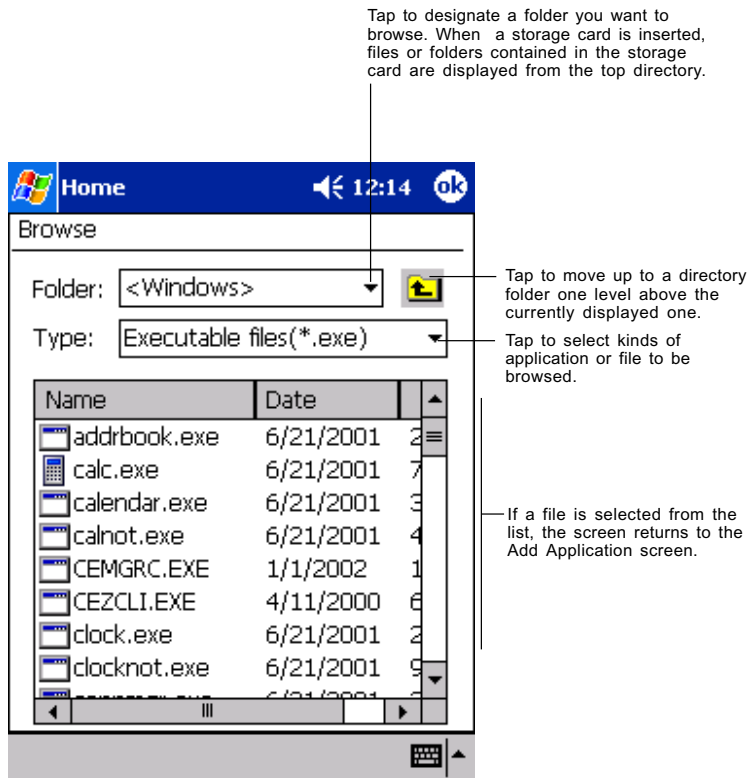

3. Enter an icon name in the Application name box, which is to be displayed on the Home screen.

You can enter up to a maximum of 32 characters.

4. When finished, tap **OK** to close the Add Application screen, and the new icon is added to the Home screen.



*If the Application file is not designated, or if the Application name is not entered, you cannot add a new icon.*

*You cannot launch the icon added from the storage card, if the same card is not inserted in the Toshiba Pocket PC e750/e755.*

### Tab Setting

You can set to add, delete or rename the tab on the Tab Settings screen. You can also set to display a desired image on your screen background.

#### To add a tab:

1. Tap **Tools** and then **Tab Settings** to display the Tab Settings screen.
2. Tap **Tab Settings** and then **New** to display a box to enter the new tab name.
3. Enter a new tab name. When finished, tap **OK** to return to the Tab Settings screen. You can enter up to a maximum of 10 characters.
4. Tap **OK** on the Tab Settings screen to return to the Home screen.

#### To delete a tab:

1. Tap **Tools** and then **Tab Settings**.
2. Select the tab name to delete, and then tap **Delete**, the Delete tab dialog for confirming appears. Please note that all the icons contained in the same tab will also be deleted.
3. Tap **OK** on the Delete tab dialog to delete the tab. When finished, the screen returns to Tab Settings screen.
4. Tap **OK** on the Tab Settings screen to return to the Home screen.



*You cannot delete the **Running** tab.*

**To change the name of a tab:**

1. Tap **Tools** and then **Tab Settings** to display the Tab Settings screen.
2. Select the tab name you want to change, and then tap **Rename**.
3. Enter a new tab name. When finished, tap **OK** to return to the Tab Settings screen. You can enter up to a maximum of 10 characters.
4. Tap **OK** on the Tab Settings screen to return to the Home screen.



*You cannot rename the **Running** tab.*

**To change a background:**

1. Select the background setup tab on the Tab Settings menu, and then tap **Browse** to display the Browse Dialog screen.
2. Tap the desired file from the list to return to the Tab Settings screen.
3. Tap **OK** on the Tab Settings screen to return to the Home screen.



*If the selected file is not a designated file type, you cannot set it on your screen background. The displayable range of the image on the Home screen is 240(W) x 246(H).*

**Text Color Setting:**

You can set the color of application name for each tab using Text Color.

1. Tap the tab whose color you want to set to display the selected tab screen.
2. Tap **View** and then **Text Color** to display the color list.  
You can set the color of the application name as desired.
3. Tap the color you want to set, and the color of the application name changes.

## Home Help

Tapping an icon displayed at “**Home**” launches that application. In addition to applications, it is also possible to register icons for associated files here. The Home screen is divided into tabs. There are 4 tab types as default, and up to 10 types of tab can be registered. As for the icons on the tab, up to 18 icons per one tab can be registered.

An image can be used as the background for the tab screen.

### (1).”Running” tab

The names of currently running applications are displayed at the “**Running**” tab.

Applications can be switched or quit here.

“**Text Color**” can be selected from the “**View**” menu, and “**Tab Settings**” and “**About**” can be selected from the “**Tools**” menu.

- To activate applications, tap and hold the name of the application you want to activate to, then tap “**Activate**” from the pop-up menu.
- To stop an application, tap and hold the name of the application you want to stop, then choose “**Stop**” from the pop-up menu. If “**Stop all**” is selected from the pop-up menu, all currently running applications are stopped.
- “**Stop all**” can also be selected by tapping and holding on the “**Running**” tab screen without selecting an application name.

### (2).Launching applications

When an icon on the tab screen is tapped, the application or associated file registered at the icon is launched.

- Applications can also be launched by selecting them with the cursor button then pressing on the center of the cursor button.

### (3).Switching the icon display

Tap on the “**View**” menu to display the current display settings. Current display settings are indicated by check mark at the left. To switch the display, select “**Large Icon**” or “**Small Icon**”.

#### (4).Icon settings

##### 1. Moving icons (using the pop-up menu)

1. Tap and hold the icon you want to move on the tab screen.
2. When the pop-up menu appears, select **"Cut"** from the menu.
3. Tap on the tab to which you want to move the icon, then tap **"Paste"** from the **"Edit"** menu to move the icon and display it on the tab screen.
  - **"Paste"** can also be selected from the pop-up menu displayed when you tap and hold at a position on the screen other than on icon.
  - It is not possible to move icons to tabs already containing 18 icons. When an icon is moved, it is positioned at the very end of the tab's icons.

##### 2. Deleting icons

1. Tap and hold the icon you want to delete. A pop-up menu appears.
2. Tap **"Drop"** from the pop-up menu to delete the selected icon from the tab screen.
  - When an icon is deleted, subsequent icons are all moved up one place.

##### 3. Adding icons

1. Tap the tab to which you want to add an icon to select that tab.
2. Tap **"Add"** from the **"Edit"** menu to display the **"Add Application"** screen.
3. Tap the **"Application file"** box.
4. From the list, tap the application you want to add. To select a file not on the list, tap the **"Browse"** button, then select the file from the Browse Dialog.
5. Input the name of the icon you want to add (up to 32 characters) in the **"Application name"** box.
6. Tap the **"OK"** button. The new icon is added.

- Associated files can be specified for added icons.
- If either one of “**Application file**” or “**Application name**” is not filled in, an icon can not be added.

#### 4. Browse Dialog

1. Tap the “**Folder**” box to select the folder to be browsed.
  2. Tap the “**Type**” box to select the type of file to be browsed.
  3. The list of the files of the specified type and in the specified folder appears on the screen. Select the desired application or file or the image to be used as the background and tap it. The original screen reappears.
- If a storage card is inserted into the main unit when adding icons, icons of applications and files on the storage card are also displayed on the browse screen. The folders and files on the storage card can be displayed in the “**Folder**” box, beginning at the topmost level.
  - If an icon on a storage card is added, that storage card must be inserted when the icon is tapped or the file will not be launched.

### (5).Tab settings

#### 1. Switching tabs

Tap on another tab to switch the tab screen.

Initially four tabs are registered: “**Running**”, “**Main**”, “**Programs**” and “**Games**”.

#### 2. Changing tab names

1. Select “**Tab Settings**” from the “**Tools**” menu. The “**Tab Settings**” screen appears.
2. Tap the “**Select tab**” box to select the tab to be changed.
3. Tap the “**Rename**” button. The screen for inputting the new tab name appears.
4. Input the new tab name (up to 10 characters) into the “**Rename to**” box.
5. Tap the “**OK**” button. The tab name is changed and the “**Tab Settings**” screen reappears.
6. Tap “**OK**” at the upper right to return to the Home screen.



### 3. Deleting tabs

1. Select "**Tab Settings**" from the "**Tools**" menu. The "**Tab Settings**" screen appears.
2. Tap the "**Select tab**" box to select the tab to be deleted.
3. Tap the "**Delete**" button. A dialog asking you to confirm you want to delete the tab appears.
4. Tap the "**Yes**" button. The tab is deleted and the "**Tab Settings**" screen reappears.
5. Tap "**OK**" at the upper right to return to the Home screen.
  - Note that when a tab is deleted, all the icons on that tab are also deleted.
  - "**Delete**" cannot be selected if there are only two tabs on the Home screen.

### 4. Adding tabs

1. Select "**Tab Settings**" from the "**Tools**" menu. The "**Tab Settings**" screen appears.
2. Tap the "**New**" button. An input screen appears.
3. Input the name you want to give the tab (up to 10 characters) into the "**New tab**" box.
4. Tap the "**OK**" button. The new tab is added and the "**Tab Settings**" screen reappears.
5. Tap "**OK**" at the upper right to return to the Home screen.

**5. Setting the background bitmap**

1. Select **“Tab Settings”** from the **“Tools”** menu. The **“Tab Settings”** screen appears.
2. Select the tab whose background you want to set at the **“Select tab”** box.
3. Tap the **“Browse”** button to display the Browse Dialog.
4. Select and tap the image to be used as the background. The **“Tab Settings”** screen reappears.
5. Tap **“OK”** at the upper right to return to the Home screen.

**6. Setting the text color**

Different colors can be set for the application names at the different tabs.

1. Display the tab whose color you want to set, then select **“Text Color”** from the **“View”** menu.
2. Tap the color you want to set from the list of display colors. That color is set for the application names.

## How to Make a Backup

You can make a backup of the Toshiba Pocket PC e750/e755 data in the storage device. If you have backed up your data on the storage device, you can restore that data in your Toshiba Pocket PC e750/e755. You can also delete backup file data from the storage device. Periodical data backup is recommended.

Data of the following three types can be backed up:

**File:** Includes a file created by Pocket Word, Pocket Excel, Notes, etc. or an additionally installed program and so on.

**Registry:** Setting information on Pocket PC 2002 or Built-in Program.

**Database:** Database information of Microsoft Pocket Outlook.



1. If you update ROM programs using special installation programs with a \*.xip extension, do not use the backup data which you made before updating ROM programs.

2. When using the DataBackup, beware of the remaining battery charge.

3. If you make a backup to the CF/SD card by DataBackup Utility, please **DO NOT** remove the CF/SD card nor **DO NOT** turn off power of the device until the backup is completed.

4. If you restore the data from the CF/SD card by DataBackup Utility, please **DO NOT** remove the CF/SD card nor **DO NOT** turn off the power of the device until the restore is completed.

5. Before making a backup, disable the password protection. Tap **Start, Settings, Personal tab, Password**, and select **No password**.

Failure to follow any of the above procedures may result in the loss of data.

### Making a Backup

1. If you make a backup to the CF/SD card, insert a **CF Card** or a **SD Card**.
2. Tap **Start, Programs**, and then **DataBackup** to display the DataBackup screen.
3. Setting **Custom Name**.
4. Select and tap **The storage device**.
5. Tap **Backup** to display the Prompt message screen.
6. Tap **Yes**. The Proceeding message is displayed during the backup process. When the backup is completed, a backup finished message appears.
7. Tap **OK** to return to the previous screen.

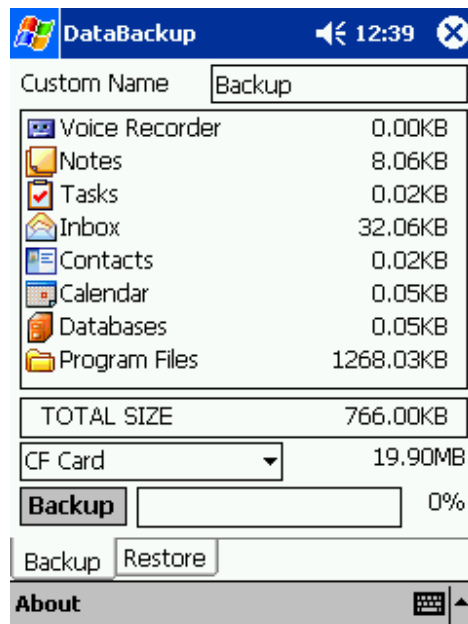

 *If the remaining storage device capacity becomes short during backup, the backup process stops. Check the storage device capacity before starting the backup.*

*If the CF/SD card is write protected, you cannot save the backup data. Cancel the write protection before starting the backup.*

## Carrying Out Restore Operation

To restore is to overwrite the backed up data from the storage device onto the main memory of your Toshiba Pocket PC e750/e755.

If the same file name exists in the main memory of your Toshiba Pocket PC e750/e755, the file data is replaced with the backup data from the storage device. If files exist in the main memory but not in the backup file, they will not be overwritten.

1. If you carry out restore from the CF/SD card, insert the CF/SD card, which contains backup data into your Toshiba Pocket PC e750/e755.
2. Tap **Start**, **Programs**, and then **DataBackup** to display the DataBackup screen.
3. Select **Restore** from tab, then select and tap **The storage device**.
4. Select backup file from restored files list.
5. Tap **Delete** if want to delete backup file.
6. Tap **Refresh** if want to refresh the storage device.
7. Tap **Restore** to display the Prompt message screen.
8. Tap **Yes**. The Proceeding message is displayed during the restore process.

When the restore is completed, a restore finished message appears.

9. Tap **OK**. Your Toshiba Pocket PC e750/e755 is reset and restarts automatically.



## Data Backup Help

The backup function allows you to back up the data from the main unit to a storage device. The backed up data can be restored and deleted.

Before performing the backup or restore operation, check that there is enough space in the main unit's memory and on the storage device. The data is saved as a backup file (.dbk) in your storage device.

### (1).If you make a backup to the CF/SD card, load the CF/SD card

- Make sure the main unit's power is off when loading and unloading the CF/SD card.
- Insert the CF/SD card in the designated card slot, making sure to do so in the proper direction.
- Save current data in the main unit's memory before backing it up on the CF/SD card.

### (2).Making backups

1. Select "DataBackup" from "Programs" in the "Start" menu.

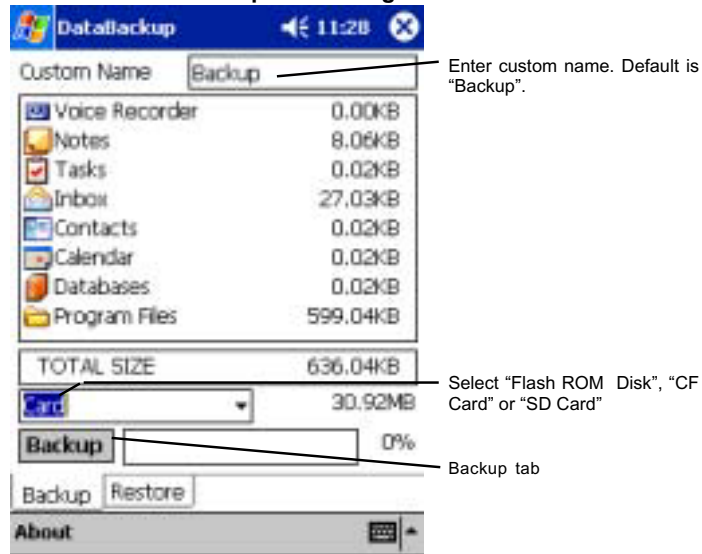

2. Once the backup screen appears, tap the "Backup" tab.
3. Select a Custom Name.
4. Select and tap **The storage device**.
5. Tap the "Backup" button.

6. A message appears once backing up is completed.
7. Tap "OK" at the upper right to return to the previous screen.

### (3).Restoring the data

Use this operation to restore the backup data stored on the storage device into the main unit. The data in the backup file is copied over the data in the main unit's memory.

- If a file with the same name already exists in the main unit's memory, its data is replaced with the data in the backup file.
  - Files in the main unit's memory not included in the backup file remain in the main unit's memory.
1. Select "DataBackup" from "Programs" in the "Start" menu.

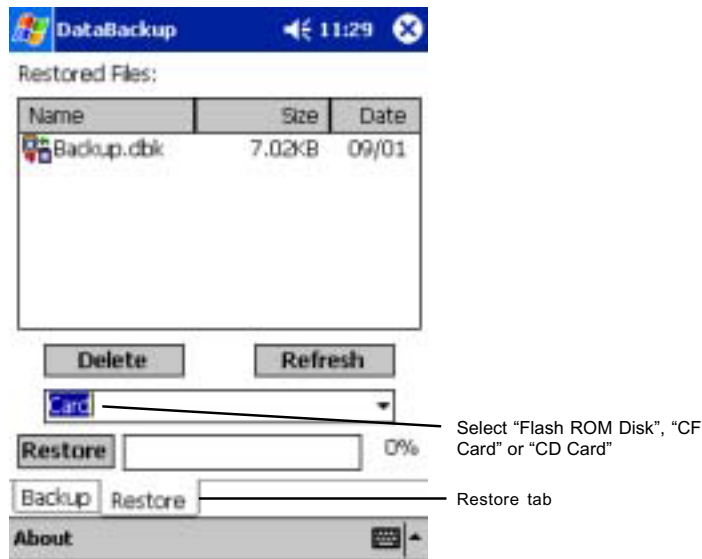

2. Once the backup screen appears, tap the "Restore" tab.
3. Select and tap **The storage device**.
4. Select backup file from restored file list.
5. Tap the "Restore" button.
6. A message appears once the restore operation is completed.
7. Tap "OK" button. The main unit is reset and restarted.

**(4).Deleting the backup file**

1. Select **"DataBackup"** from **"Programs"** in the **"Start"** menu.
2. Once the backup screen appears, tap the **"Restore"** tab.

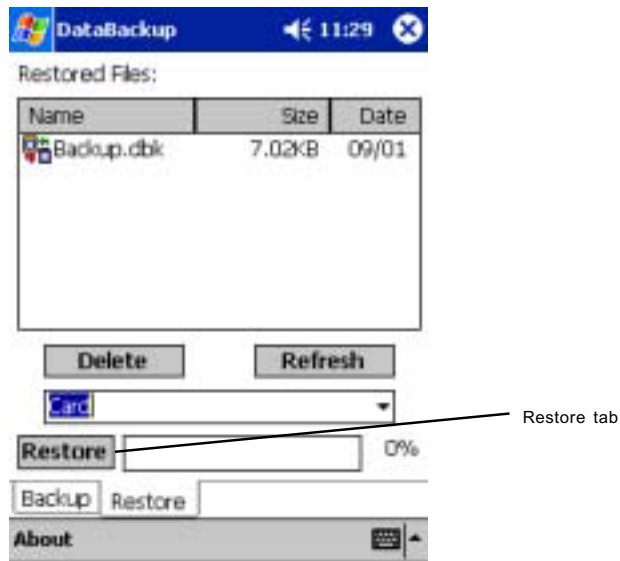

3. Select and tap **The Storage Device**.
  4. Select backup file from restored file list.
  5. Tap the **"Delete"** button. A message screen asking you to confirm that you want to delete the backup file appears.
  6. Tap the **"Yes"** button.
- The backup data is deleted from the storage device and the previous screen reappears.

**Note:** Pressing **"About"** in the **Backup** or **Restore** menus displays the version of the program being used.



## System Information

The **System Information** program displays the system information such as CPU clock, CPU stepping, Boot Loader Version, OS Version, PIC Version, MAC address (WirelessLAN model only), and UUID. The information is displayed by accessing the **Identity**, **Memory**, **Drivers**, **System**, and **Wireless** tabs.

To launch the program, Click Start > Settings > System Information.

The opening menu presents identification information for product service.



Tabs for accessing information about **Identity**, **Memory**, **Drivers**, **System**, and **Wireless** settings.

### Memory tab

The Memory tab presents information about the systems RAM, ROM, and Flash ROM Disk.



### Driver tab

The Driver tab displays the drivers used by the system's software applications.



### System tab

The System tab displays CPU, operating system, and other system information.



### Wireless tab

The Wireless tab displays information about the Wireless LAN adapter.



### Tools Menu

The Tools menu displays the system information and allows it to be exported to a text (\*.txt) file. “**Export**” exports all system information parameters to a text (\*.txt), and “**About**” displays the system information version.



## ATI Presentation Pack

### Introduction

The Toshiba Expansion Pack with ATI IMAGEON Dual Display Solution comes bundled with the ATI Presentation Pack, which includes the IA Presenter and IA Screen Mirror modules.

#### IA Presenter

Take your Microsoft Windows PowerPoint slides and use IA Presenter to run a smooth presentation directly from your Pocket PC. IA Presenter can run as a standalone mobile PowerPoint player using your portable device's LCD screen. But with IA Presenter and the Toshiba Expansion Pack linked to an LCD projector or a monitor, you can create powerful presentations from your Pocket PC.

#### IA Screen Mirror

This module projects the current contents of your Pocket PC's LCD screen onto an external projector, or monitor. It can display up to nine different images from your LCD output at the same time on the second display.

### Installing the ATI Presentation Pack

All components of the ATI Presentation Pack are installed together by doing as follows:

1. Make sure your Pocket PC is connected to your computer and that an ActiveSync connection has been established.
2. Start the ATI Presentation Pack installation by running the Setup program.



*You can setup ATI Presentation Pack from Companion CD (Enhance Your Pocket PC→Tools→AT Presentation Pack→Install)*

3. After accepting the license agreement, choose the folder to which you want the ATI Presentation Pack to be installed. Click **Next** to accept the default destination folder; click Browse... to specify a different folder.
4. Check your Pocket PC screen for any additional steps required to complete the installation.

### **On-line Help**

This Manual serves as a quick-reference guide. For more details about any feature, consult the on-line Help. When using IA Presenter, select **Tools**→**Help** for the main Help table of contents. In IA Screen Mirror, tap the **Help** button in the *About* tab to access the main Help file. **Context-sensitive Help** is also available. If, during some operations, you cannot open the Tools Menu, you can access the context-sensitive Help messages via the Windows *Start Menu*.

### **A Note about Updates to the ATI Presentation Pack**

Your copy of the ATI Presentation Pack contains the latest versions of IA Presenter and IA Screen Mirror. For updates, please visit the IA Style web site ([www.iastyle.com](http://www.iastyle.com)).

## ATI Presentation Pack

### Introduction

The Toshiba Expansion Pack with ATI IMAGEON Dual Display Solution comes bundled with the ATI Presentation Pack, which includes the IA Presenter and IA Screen Mirror modules.

### IA Presenter

Take your Microsoft Windows PowerPoint slides and use IA Presenter to run a smooth presentation directly from your Pocket PC. IA Presenter can run as a standalone mobile PowerPoint player using your portable device's LCD screen. But with IA Presenter and the Toshiba Expansion Pack linked to an LCD projector or a monitor, you can create powerful presentations from your Pocket PC.

## IA Presenter

### Getting Started

After you invoke IA Presenter, the screen lists all the converted PowerPoint presentations currently in your *My Documents* folder. A sample presentation file is included with the installation, so at least one file will be listed when you initially invoke IA Presenter.

To receive a presentation file into the *My Documents* folder of your Pocket PC via Infrared beaming, tap **Tools** in the lower left corner of the screen, then select **Receive via InfraRed...** from the menu shown above. To drag-and-drop a PowerPoint file from your computer to your Pocket PC, see the section **Using IA Presenter's Desktop Converter** on the next page.

The **Options...** command on the Tools Menu opens the *General*, *File*, *Display*, and *VGA Output* tabs. These tabs are explained in the on-line Help file, which can be accessed from the Tools Menu by tapping **Help....** Or, after opening one of the tabs, select **Help** from the Windows *Start Menu*.

### Using IA Presenter's Desktop Converter

When you drag-and-drop a PowerPoint file from your PC to your Pocket PC, the ActiveSync Converter in the IA Presenter will automatically convert the PowerPoint file to a special IA Presenter format for your Pocket PC, using the resolution you specify. The file will be placed in any folder on your mobile device where you choose to drag-and-drop it.



*PowerPoint 97 or PowerPoint 2000 (or greater) is necessary for using IA Presenter's Desktop Converter.*

There are two ways to open the “Set ActiveSync Conversion Options” dialog box:

- 1) Select **ATI Presentation Pack** from the *Start Menu*, and then **Set IA Presenter ActiveSync Conversion Options** from the submenu. The dialog box will open, establishing it as your default PowerPoint filter for your ActiveSync drag-and-drop operations. You can choose a dimension and then uncheck the *Show this option dialog box next time* checkbox (it is checked by default as shown in the figure above). If you uncheck it, the dialog box will not open whenever you drag-and-drop a file from your computer to your mobile device. Instead, the dimension you specified will be used during each conversion.
- 2) You can set the dimension each time you drag-and-drop a PowerPoint file from your computer to your mobile device. If the *Show this option dialog box next time* checkbox has not been un-checked, the IA Presenter “Set ActiveSync Conversion Options” dialog box will open automatically every time you drag-drop a PowerPoint file to your Pocket PC.

#### Choosing Dimensions for the Converted .IAP File

The conversion filter supports both PPT and PPS PowerPoint files. The conversion options are:

- **Pocket PC LCD Size – 320 x 240:** Select this option if you only want to display the presentation on the LCD screen of your Pocket PC. However, if you have tried the **320 x 240** button and then find that images on the Pocket PC screen have been “stretched” to fit the screen, and you do not want this effect, try converting again using the **User-defined** button. After selecting **User-defined**, enter **240** in the first box, and **320** in the second box.

If you want to prepare the file to project the presentation to a VGA screen or video monitor, select one of these options:

- **VGA – 640 x 480**
- **SVGA – 800 x 600**
- **User-defined: If you do not want to use one of the pre-defined dimensions** listed above, select the **User-defined** option and enter your own value in the fields.



XGA 1024 x 768 is not supported.



## Opening a Presentation and Using View Modes

When you invoke IA Presenter, the first screen that appears lists all the converted PowerPoint presentations currently in your *My Documents* folder. Tap on the name of the file you want to load. You can then choose from the following view modes.

### Normal View

Normal view allows you to view the current slide in the upper pane, while still able to navigate slides conveniently using the lower thumbnail pane. You can drag the Splitter Bar that divides the two panes up or down, to adjust the screen distribution above and below the splitter. The *Normal View* icon is located at the leftmost side of the Toolbar, as shown below.

You can also use the stylus to pan the slide image in the upper pane to show the part covered by the lower pane. The splitter position will automatically be remembered across multiple application sessions, freeing you from having to adjust the splitter position again during the current IA Presenter session.

To display a different slide in the upper pane, simply tap on the desired thumbnail in the lower pane, or use the Slide Title Bar (unnamed slides will be represented by a number in the Slide Title Bar drop-down list). The lower thumbnail pane in Normal view provides slide navigation. If you want to select multiple slides for further operations, use the Slide Sorter view, as explained in the next section.

You can project the currently selected slide to VGA Display by activating the **VGA Slide Toggle** command on the View Menu, or by tapping the **VGA Slide Output Toggle** icon at the rightmost side of the Toolbar. To end the projection, select the command again to toggle it off.

### Slide Sorter

Slide Sorter view fills the entire application space with either large or small thumbnails, depending on whether **Large Thumbnail** or **Small Thumbnail** is active on the View Menu. You can select:

- One slide by tapping on it, or
- Multiple adjacent slides by dragging your stylus over them, or
- If you select Multiple Select Mode on the Edit Menu, you can tap, drag, or a combination thereof, to select multiple slides that are separated.

Selected slides will be highlighted by a different border color.





You can project an individual slide to the VGA output by activating the **VGA Slide Toggle** command on the View Menu, or by tapping the *VGA Slide Output Toggle* icon at the rightmost side of the Toolbar. When you activate this function:

- If one slide is selected at the time you toggle the VGA Slide Output “on,” that slide will be output to the VGA Display.
- If multiple slides happen to be selected, the first selected slide in the sequence will be output to the VGA Display.
- If no slides are selected, there is no change to the current status of the VGA Display. That is, if an image is already displayed on the VGA Display, that image remains until you select a slide on your LCD screen for projection.

To end the projection and return to viewing the slide only on your mobile device’s screen, just select the command again (or tap the icon a second time) to toggle it off.

#### Indicator Icons under Thumbnails

Under each thumbnail in Slide Sorter view mode, there may be various small icons displayed which indicate the status/attributes of the slide, as follows:

- - The transition icon indicates that a transition effect has been associated with the slide, and tapping the icon will “demo” the transition effect.
- - The shape icon indicates that the slide contains animated shapes.
- - If you assigned a transition delay-time to the slide in the *Automatically* field of the **Edit Menu > Slide Transition...** screen, the delay-time will be shown.
- - The slide number is always shown at the right. If the slide has been hidden using the **Hide Slide** command on the Edit Menu, the slide number will be enclosed in a red box with a line crossing it out.

### Notes Page

Notes Page view displays the current slide content in the upper pane, with the lower pane displaying the speaker notes that were entered for the original PowerPoint presentation, or entered/edited in IA Presenter. The upper pane operation is the same as in Normal view. The lower pane is both a Notes display window and an editing window. After editing a Note, tap **OK** in the upper right corner to save it.

When in Notes Page view mode, you can project the currently-selected slide to VGA output by activating the **VGA Slide Toggle** command on the View Menu, or by tapping the **VGA Slide Output Toggle** icon at the rightmost side of the Toolbar. To end the projection and return to viewing the slide only on your mobile device screen, just select the command again to toggle it off.

### Quick Notes

The **Quick Notes** command on the View Menu (and the *Quick Notes View* icon on the Toolbar) gives you a view mode that combines the thumbnail images of Slide Sorter view with the Notes pane of the Notes Page view.

When you tap on a thumbnail, a border around it indicates it is selected. You can also use the Up, Down, Left, or Right buttons on your mobile device to move the selection focus (or the Slide Title Bar, if you chose to display it).

The lower pane displays the Speaker Notes that were entered for the original PowerPoint presentation, or entered/edited in IA Presenter. The lower pane is both a Notes display window and an editing window. Tap in the lower pane to start editing a Speaker Note. The editing functionality is the same as for Notes Page view.

If the **Cut/Copy/Paste/Clear/Undo/Select All** commands are required for editing the text, press your stylus within the Notes pane to activate the pop-up editing menu. The Notes-editing operation can be undone by selecting the multiple-steps **Undo** command on the Edit Menu, pop-up menu, or Toolbar.

### Slide Show

The **Slide Show** command on the View Menu starts a full screen Slide Show on the Pocket PC's LCD screen. (If you want to project the slide show to VGA output, you must use the **VGA Slide Show** command.) Before selecting Slide Show or VGA Slide Show, you should select **Set Up Show...** from the Tools Menu to set up the desired behavior for your slide show.

If the *Auto-Rotate* option is checked in the **Tools > Options > Display** tab, the slide will be automatically rotated according to the direction you choose (Left or Right).

Depending on the slide advancement setting specified in the Slide Transition dialog box, you can tap to advance the slide (or the next animated object); use the navigation (arrows) buttons of your Pocket PC to advance/back play the slides; or, IA Presenter will automatically advance slides based on the number of seconds (delaytime) you set. Sound effects will also be played according to your assignment.

### Pop-Up Menu for Slide Show Mode

If the *Show Popup-Menu Button* option is checked in the **Tools→Options →Display** tab, a small transparent icon will be shown in the upper left corner of the LCD screen. Tapping on the small icon will activate the Slide Show mode's pop-up control menu. If this option isn't checked, you can always tap-and-hold your stylus during Slide Show mode to activate the pop-up menu. The commands on the menu are explained below.

#### **Next / Previous**

Displays the next or previous slide, or next or previous animated object (if the animated object display was designed). Hidden slides won't be shown.

#### **Go**

The **Go** submenu allows you to jump to the **First Slide**, **Last Slide**, **Previously Viewed Slide**, or jump to any slide using **Navigate by Title**.

#### **Trigger**

If the **Trigger** mode is selected, the slide show will advance according to the mode you set using the **Tools→Set Up Show...** command or *Set Up Show* icon. For example, if you have specified to advance the slides manually, they will advance each time you tap on the screen. If the slide show is set to play automatically, you can use the pop-up menu to put it on pause or end it immediately. IA Presenter is set to Trigger mode by default.

### **Pen**

Select the **Pen** command to enter Ink annotation mode. During the Ink annotation mode, you can use the stylus to mark or highlight the presentation elements on the screen. To exit the Ink annotation mode, select the **Trigger**, **VGA Pointer**, or **VGA Zoom** mode from the pop-up menu.

Use the **Pen Color** submenu to choose the Ink color, and use the **Pen Width** submenu to choose a thickness.

If Pen mode is active when you select **Blank** from the **Screen** submenu, you will be able to draw or write Ink annotation on the projected black screen. (The **Screen** submenu also lets you undo the most recent Ink stroke, or erase all of the Ink strokes.)

### **VGA Pointer**

This mode works only when IA Presenter is in VGA Slide Show view. After you select the **VGA Pointer** command, your stylus movements on the LCD screen will simulate a laser pen light on the VGA screen during presentations. (To exit the **VGA Pointer** mode, select **Trigger**, **Pen**, or **VGA Zoom** from the pop-up menu.)

### **VGA Zoom**

This mode works only when IA Presenter is in VGA Slide Show view. After you select the **VGA Zoom** mode, you will be able to specify a portion of the screen which will be projected to the VGA screen, and also a zoom ratio for that specific area. (To exit **VGA Zoom** mode, select **Trigger**, **Pen**, or **VGA Pointer** from the pop-up menu.)

The message that appears on your screen when you invoke VGA Zoom mode depends on the value that is currently selected on the **VGA Zoom Size** submenu. The message will either tell you to tap-and-drag your stylus to define an area yourself, or it will tell you to simply tap your stylus to create a zoom area of pre-defined size. You can specify the zoom ratio using the **VGA Zoom Ratio** submenu, accessed from the Slide Show pop-up menu.

### **Pen Color**

Tapping **Pen Color** opens a submenu of available colors to use for your Ink annotation when in Pen mode. Select one of the available colors as the new pen color. The **Reset** command resets the pen color to the default White color.

### **Pen Width**

Tapping **Pen Width** opens a submenu of available pen widths to use for your Ink annotation when in Pen mode. Select a thickness settings as the new pen width to be used for Ink strokes on the LCD screen (and projection to VGA output, if desired). The **1 Unit** option is the thinnest setting. Higher values give you thicker widths.

### **VGA Zoom Size**

The **VGA Zoom Size** command opens a submenu of “zoom area” options. When you invoke **VGA Zoom** mode by selecting it on the pop-up menu, the current setting on the **VGA Zoom Size** submenu will be activated.

The **Quarter**, **Large**, **Medium**, **Small**, and **Tiny** settings on the submenu represent pre-defined areas. For example, if **Quarter** is selected, tapping on your LCD screen will automatically produce a rectangular area which is the size of one-quarter of your LCD screen (centered around the spot where you tapped).

The “zoom area” will be displayed on top of the already-existing projection of the entire slide on the VGA screen.

After the rectangular zoom area exists on your screen, you can drag it to any part of the screen you wish. It can also be converted to any of the other pre-defined sizes by pressing your stylus on the LCD screen to open the pop-up menu again, then selecting a different value from the **VGA Zoom Size** submenu. The size of the existing area will then be changed accordingly.

If you select **Drag Select** on the submenu, you will be able to drag your stylus on the LCD screen and freely define any area for zooming. After the desired area has been specified, you can drag it to any portion of the screen. You can also resize it by dragging any of its corners. To specify the zoom ratio for the projected zoom area, use the **VGA Zoom Ratio** command.

### **VGA Zoom Ratio**

The **VGA Zoom Ratio** command opens a submenu of pre-defined “zoom ratio” options. When you invoke **VGA Zoom** mode by selecting it on the pop-up menu, the current setting on the **VGA Zoom Ratio** submenu will be activated.

### **Screen**

The **Screen** submenu contains commands that allow you to pause a Slide Show (**Pause Auto Play**), project a blank screen (**Blank**), undo the most recent Ink stroke (**Clear Last Pen**), or erase all Ink strokes (**Clear All Pen**).

### **Pause Auto Play**

If you have specified that you want slides to advance automatically after a specified number of seconds (using the **Set Up Show...** command on the Tools Menu or the *Set Up Show* icon on the Toolbar), you can select **Pause Auto Play** during the playing of a slide show, to pause the show. When ready to continue the automatic progress of a slide show, tap **Resume Auto Play**.

### **Blank**

When you select **Blank**, your LCD screen will become completely black, and the black screen will also be projected to your VGA screen. (After you have selected **Blank**, the command name changes to **Restore**. Tap **Restore** when you are ready to return to the slide that was previously displayed.)

#### **Using the Blank Option with Pen Mode:**

When the Blank option is active and IA Presenter is in **Pen** mode, you can write or draw digital Ink on the screen, and it will be output to the VGA device. In effect, this allows you to project an "electronic blackboard" which you might find useful when giving a presentation to an audience. Be aware that any Ink strokes you draw on the Blank screen will be lost when you exit Blank mode. They cannot be retained.

When IA Presenter is in **VGA Zoom** mode or **VGA Pointer** mode, the Blank option is not available.

### **Clear Last Pen**

Erases the last individual Ink stroke. This command can be applied repeatedly until there are no more Ink strokes in the current slide.

### **Clear All Pen**

Erases all the pen strokes on the current slide.

### **Speaker Notes**

This command displays the current slide's Note text (if any) in a pop-up window, with the slide number also shown, on top of the displayed slide. To advance the slide or object when the Speaker Notes window is shown, tap on the underlying slide. When you advance the slides, the Speaker Notes window remains open and interactively displays the Note text of the related slide. To close the Speaker Notes window, tap the "X" in the upper right corner.

### **End Show**

This command terminates the Slide Show playback mode and returns to the mode you were using prior to entering Slide Show mode. The Action button on your Pocket PC can also be used to exit Slide Show mode.

### **VGA Slide Show**

VGA Slide Show mode operates almost identically to the Slide Show mode, except for the following operational differences:

- You should use the *VGA Output* tab in the **Tools→Options...** command to set VGA output-related options. You can also elect to have IA Presenter perform dithering for your slide if you project your slide to an external VGA/video device with less color capability (such as only 256 colors available).
- During VGA Slide Show mode, the presentation output will be directed to both the Pocket PC's LCD screen and the external connected VGA device or video device.  
The Pocket PC will always show the reduced size version, while the VGA/video device will view the original matching dimensions set during ActiveSync conversion. Or if your current presentation has a dimension specified which is different from the exact dimension of your selected output dimension, IA Presenter will automatically resize the slides to fit the output dimensions.
- The Ink annotation will be projected to both the VGA video device and the LCD screen.
- You can use **VGA Zoom** on the pop-up menu to designate an area on a slide during *VGA Slide Show* view, and project that specific area to the VGA screen (on top of the already-existing projection of the entire slide). Use the **VGA Zoom Size** command to specify an area of predefined size, or manually drag your stylus on the LCD screen to specify the desired area of the slide. Then use the **VGA Zoom Ratio** command to choose the ratio at which you want the zoomed area to be projected. After the "zoom window" has been created, it can be dragged to enclose other portions of the slide on your LCD screen, and this movement will also be reflected in the projected image on the VGA output.
- You can use the **VGA Pointer** command on the pop-up menu to enable movements of your stylus on the LCD screen to simulate a laser pen light on the VGA screen during VGA Slide Show presentations.
- In addition to being able to draw digital Ink annotation on your slides, you can project a black screen to the VGA output and write or draw projected Ink on it. To use Ink on the blank screen, make sure you are in *Pen* mode on the Slide Show pop-up menu before selecting **Blank** from the **Screen** submenu.



In addition, before a VGA Slide Show can be projected to a VGA screen, you must specify the appropriate settings. Select **Options...** from the Tools Menu, then tap *VGA Output*.

More information about the *General*, *File*, *Display*, and *VGA Output* tabs are included in the on-line Help.

### Controlling Transition Effects

Any transition effects that were assigned in your original PowerPoint file will be retained when the IA Presenter Converter converts it to an **.iap** file on your Pocket PC.

However, IA Presenter also furnishes many attractive transition effects that can be assigned to the **.iap** file. You can assign a particular transition effect to an individual selected slide, or to all slides in the current file.

After you select one or more slides, tap **Slide Transition...** on the Edit Menu or the  icon on the Toolbar.

The Slide Transition screen will appear. In it, you can select a transition effect, a speed for the transition effect, method of slide advancement during a slide show, and associate a sound (**.wav** file) to a slide.

### Merging Presentations

You can merge the slides of two different presentations into one file. The new inserted slides will adopt the Master Slide style of the current file. Therefore, you should first open the presentation whose Master Slide style you want to adopt to.

The next thing you should do is select **Options...** from the Tools Menu and open the *File* tab. Tap **OK** to close the tab and save the settings.

If you selected **To Current Selection** in the *File* tab as the insertion position, use your stylus to tap the desired insertion point in the current file (in Slide Sorter view). Or, select the slide after which you want the imported slides to be inserted.

Select the **Insert Slides From Files...** command from the Tools Menu. A listing of files will appear. Tap the name of the file whose slides you want to merge with the current file, and it will be done immediately. This command can be undone or redone (Edit Menu). You can also use **Save Presentation As...** (Tools Menu) if you wish to save a backup copy before you start the merge operation, if desired.

More information about the *General*, *File*, *Display*, and *VGA Output* tabs are included in the on-line Help.

## IA Screen Mirror

**IA Screen Mirror** projects an exact emulation of your mobile device's screen contents (LCD display) onto a connected external VGA output device or television monitor via the Composite video or S-video terminals. It allows you to project and display multiple LCD screens on the VGA screen simultaneously, "freeze" them in the desired state, and maintain one as the active viewport. Flexible output control options let you control the allocation of CPU utilization, orientation, resolution, and color optimization/dithering of projected images.

### Getting Started

Tap the *IA Screen Mirror* icon in your *Programs* group to start the *IA Screen Mirror* program.

1. Use the *Layout* tab to set up the viewports to which you will project images.
2. Use the *Switch* tab to assign a "switching" button on your mobile device.
3. Use the *Refresh* tab and *VGA* tab to customize other parameters as desired.
4. Tap **OK** to project the LCD screen contents onto the active viewport.
5. Start and operate the application you want to project ("foreground application").
6. To make adjustments to the settings, use the "switching" button on your mobile device to freeze the active viewport and return to the IA Screen Mirror control screens. Tap **OK** to continue the projecting.
7. Use the **Exit Program** button to terminate IA Screen Mirror entirely and stop projection to the VGA screen.

For more information please refer to the on-line Help.

## **Copyright and Contact Information**

ATI® and IMAGEON® are registered trademarks of ATI Technologies, Inc.

Microsoft®, MS-Windows®, and PowerPoint® are registered trademarks, and Windows CE™ is a trademark, of Microsoft Corporation in the United States and other countries.

IA Album®, IA Presenter®, and IA Screen Mirror® are registered trademarks of IA Style, Inc., and Information In Action™ is a trademark of IA Style, Inc.

The names of other actual companies, products, and brand names mentioned herein may be trade names, service marks, trademarks, or registered trademarks of their respective owners.

This User's Manual and the programs in the ATI Presentation Pack are copyrighted. All rights are reserved. Reproduction, adaptation, or translation of these programs and documents without prior written permission of IA Style, Inc. is also prohibited.

First Edition March 2002

©2000-2002 IA Style, Inc.

All rights reserved.

Web sites: <http://www.iastyle.com>

Product support: [supportE@iastyle.com](mailto:supportE@iastyle.com)



Chapter 11:

## Additional Information

### Troubleshooting

Check the following guide for the possible cause of a problem and how to correct it.

Symptom	Cause	Correction
Even if the power button is pressed and the power does not turn on.	The battery power is exhausted.	Charge the battery.
	The main battery or the High Capacity Battery is not attached.	Attach the main battery / High Capacity Battery and switch Battery Pack Lock to the Lock side.
	Battery Pack Lock is at the Release side.	Switch Battery Pack Lock to the Lock side.
The power was suddenly cut off.	The battery power is exhausted.	Charge the battery.
	Automatic suspend is active.	Select  , <b>Settings</b> , <b>System</b> , <b>Power</b> to set to alter the power shut down time.
Even if the battery is completely charged, it discharges after a short period of time.	The battery is extinct.	Replace the main battery with a new one.

Symptom	Cause	Correction
The screen was tapped, but the correct action was not executed.	Touch screen adjustment is incorrect.	Select  , <b>Settings, System, Screen, Align Screen</b> to adjust the touch screen.
The operation is slow in response.	Insufficient memory	Secure the free memory. Quit the application if it is not in use.
	Some malfunction.	Reset the system. If no action is observed after resetting the system, initialize the system. (However, the data will be deleted.)
The screen was tapped, but there is no response. The operation button does not work either.	Some malfunction.	Reset the system. If no action is observed after resetting the system, initialize the system. (However, the data will be deleted.)
The screen is dark.	The front light is off.	Press and hold the power button until the front light is turned on.
The screen is hard to see.	Brightness setting is incorrect.	Select  , <b>Settings, System, Front Light</b> to adjust the screen brightness for better sight.
Cannot connect to your computer.	—	See Help of ActiveSync.
ActiveSync does not function when your Toshiba Pocket PC is connected to your computer with a cradle or USB cable.	The USB driver of your computer may not be compatible.	Reselect the USB driver.

Symptom	Cause	Correction
Cannot access the Internet.	The connecting using a specified cellular phone connection cable was not correct.	Check whether the connecting using a specified cellular phone connection cable is correct.
	Radio waves of a connected cellular phone are getting worse.	Carry out communications where radio wave conditions are satisfactory.
	Setting is incorrect.	Carry out correct setting.
Following message is displayed. "Not Enough Battery Power. There is not enough battery power to use USB Device"	The Battery power is too low to use USB devices.	Charge the battery or connect AC adapter.
	The total power consumption of connected USB devices is too large.	This USB port supports total 500mA USB device. Confirm connected USB device.
Following message is displayed. "USB OVER CURRENT DETECT USB device is turned off. Please disconnect USB device."	The total power consumption of connected USB devices is too large.	This USB port supports total 500mA USB device. Confirm connected USB device.
		To enable USB port again, turn off the power of Pocket PC and push Reset Switch.

## Resetting

Reset is equivalent to "**Restarting**" a computer. Reset the Pocket PC e750/e755 when a button or tapping the screen does not respond. When your Toshiba Pocket PC e750/e755 is reset, all data that was not stored during operation will be deleted.



*If the function cannot be restored even if the reset button is pressed, initialize your Toshiba Pocket PC e750/e755.*

- When the power is on, press the reset switch with the stylus, then release.

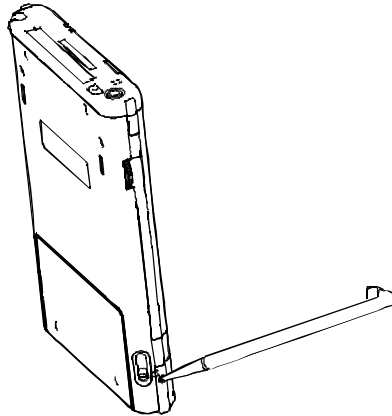

## Clear Memory

When you initialize your Toshiba Pocket PC e750/e755, it returns to the status when it was purchased.



*When you initialize your Toshiba Pocket PC e750/e755, all data stored in the memory is deleted. Your Toshiba Pocket PC e750/e755's initially installed programs are not deleted.*

*Before initialization, remove all CF/SD cards.*

1. Turn off the power.
2. Press the power button while pressing and holding the reset switch with the stylus, and then release the power button.
3. When a screen appears, release the reset switch. When initialization is completed, the Welcome screen appears. Set up the system according to the screen as in the case of startup procedure.



## Troubleshooting for Wi-Fi

If you encounter some problems while using our product, please refer to this troubleshooting section.

Problems	Solutions
Cannot connect to the network	<ul style="list-style-type: none"> <li>■ Make sure the Wireless Communication Switch is turned on.</li> <li>■ Check if the SSID is correct (note that it is case-sensitive)</li> <li>■ Check Link Quality in Configuration Page. If the link quality is poor, rescan and find another Access Point.</li> <li>■ Check if the operating mode is set properly. See Chapter 4.4 Configuration Page.</li> <li>■ Check if the WEP key is correctly entered.</li> <li>■ Be sure you are in the range of a working Access Point.</li> <li>■ Make sure the channel been set is in the range of 1~11.</li> </ul>
The host computer cannot wirelessly connect with my Toshiba Pocket PC e740	<ul style="list-style-type: none"> <li>■ Make sure you have setup the partnership for your Toshiba Pocket PC e740 and your host computer.</li> <li>■ Make sure you are within the range of a working network.</li> <li>■ Make sure you have entered the IP address of the host computer as the WINS server on your Toshiba Pocket PC e740.</li> <li>■ Reset your Handheld PC or Toshiba Pocket PC e740 to make the TCP/IP settings take effect.</li> <li>■ Make sure the SSID, WEP keys and channel for all devices in the network are set the same.</li> <li>■ Make sure the channel been set is in the range of 1~11.</li> </ul>
Cannot edit the "Channel" and "Country" field in "Infrastructure" Mode?	In Infrastructure mode, country and channel are decided by the Access Point. You can only join the existing network formed by the working Access Point, not to create a new Wireless Network.
The Toshiba Pocket PC e740 freezes	<ul style="list-style-type: none"> <li>■ Reset the Toshiba Pocket PC e740.</li> </ul>

## FAQ for Wi-Fi

### A. Compatibility

**A1: Should I use equipment with the same brand as the IEEE802.11b WLAN Adapter's to enable the wireless communication?**

This is not necessary. IEEE802.11b WLAN Adapter is Wi-Fi certified which means that it will work well with different branded equipments as long as the equipment is also Wi-Fi certified.

**A2: Can I connect IEEE802.11b WLAN Adapter to other devices using Bluetooth?**

No, you can only connect the IEEE802.11b WLAN Adapter to other IEEE802.11b equipment.

### B. Wireless LAN Connectivity

**B1: How do I form a wireless network?**

Typically, you can form a wireless network by connecting Access Points. Different Access Points should have different channels. Every devices connected to the network should have the same SSID. When you are using Access Points, set the mode to "Infrastructure" mode. Without Access Points, you can still build a network where adapters communicate peer-to-peer using a shared SSID. When you are not using Access Points, change the operating mode to be "802.11Ad Hoc". To set the operating mode, click Start→Settings→System→Wireless LAN Utility→Config.

**B2: How can I connect my Toshiba Pocket PC e750/e755 to the usable Wireless Network?**

Please click Start→Settings→System→Wireless LAN Utility→Scan to view Scan Page where you can find the usable Wireless Network. If you cannot see all the networks you are expecting, please click "Rescan" to see the list of usable Wireless Networks. Choose one Wireless Network you want and double click the BSSID to connect to the network. Once the network is chosen, you need to configure the IEEE802.11b WLAN adapter.

Click Start→Settings→Connections→Network Adapters→IEEE802.11b WLAN Adapter→Properties→IP Address to set IP address, Subnet mask and Default gateway settings. Click Start→Settings→System→Wireless LAN Utility to edit other settings, such as Mode and SSID etc. If the WEP Mode of the Wireless Network you selected is enabled (64bit or 128bit WEP Mode), please choose the proper WEP KeyID and the proper WEP Key value network.

## More Information

- B4. *What is 802.11 Ad Hoc Network? What should I do to form an 802.11 Ad Hoc Network?*
- B5. *What is the difference between "Infrastructure" and "802.11 Ad Hoc" Network Mode?  
How do I choose?*
- B6. *Could I use the 802.11 Ad Hoc Mode to access the LAN resources? How can I access the LAN resource without an Access Point?*
- B7. *What should I do if my host computer cannot wirelessly connect with my Toshiba Pocket PC e750/e755?*
- E1. *What is WEP?*
- E2. *How many WEP security service mode does Wireless LAN support?*
- E3. *How to set the WEP security service?*

### **B3: How do I know whether or not my Pocket PC has already connected to an AP successfully?**

1. Check BSSID. When there is a link, the current Basic Service Set ID of the Access Point been used will be shown in the BSSID field in Link Page. When the adapter is disconnected with the Access Point, "Non-associated" will appear in the BSSID field. To view BSSID, from your Toshiba Pocket PC e750/e755, click Start→Settings→System→Wireless LAN Utility→Link.
2. Check Link Quality. Link Quality shows how clearly the adapter can hear the Access Point. If the quality is poor, it's better to rescan and find a better performance Access Point or re-arrange the AP's position for better performance. To view Link Quality, from your Toshiba Pocket PC e750/e755, click Start→Settings→System→Wireless LAN Utility→Config.

### **B4: What is 802.11 Ad Hoc Network? What should I do to form an 802.11 Ad Hoc Network?**

802.11 Ad Hoc Mode is used to create a peer-to-peer connection without an Access Point. The SSID must be the same among stations to enable the wireless communication within the local area network.

 You need to choose a proper SSID and channel for the first 802.11 Ad Hoc station. For other stations want to join the same SSID group, you could only choose the same SSID as the first station for connection. The Channel setting for the 802.11 Ad Hoc Network stations to join the existing 802.11 Ad Hoc Network will automatically be set as the channel number of the network.

### **More Information**

*B5. What is the difference between "Infrastructure" and "802.11 Ad Hoc" Network Mode?*

*How do I choose?*

*B6. Could I use the 802.11 Ad Hoc Mode to access the LAN resources? How can I access the LAN resource without an Access Point?*

*B7. What should I do if my host computer cannot wirelessly connect with my Toshiba Pocket PC e750/e755?*

#### **B5: What is the difference between "Infrastructure" and "802.11 Ad Hoc" Network Mode?**

##### **How do I choose?**

Infrastructure Mode is used to connect your Toshiba Pocket PC e750/e755 with the Access Point. Usually, to form a Wireless Network, you can connect your Access Point to the ADSL, Cable Modem or LAN Ethernet and then configure the Access Point base on the User Guide for the Access Point to set the proper SSID, Channel and WEP security service. After that, configure the IEEE 802.11b WLAN adapter. Set the same SSID, Channel and WEP as the Access Point's. 802.11 Ad Hoc Mode allows your Toshiba Pocket PC e750/e755 to form its own local network where devices communicate peer-to-peer, using a shared SSID, without Access Points. Under 802.11 Ad Hoc mode, the SSID must be the same among stations so that the devices can communicate properly within the Wireless Network. If you want to form your network without any Access Points, you should choose 802.11 Ad Hoc mode.

#### **B6: Could I use the 802.11 Ad Hoc Mode to access the LAN resources? How can I access the LAN resource without an Access Point?**

Yes, you can access the LAN resources without an Access Point. Follow the steps shown below:

- (1) *Make sure your host computer already successfully connect to the LAN or Internet through the LAN Adapter or the Modem.*
- (2) *Install the Wireless LAN Adapter into your Host computer successfully and set 802.11 Ad Hoc Mode and the proper SSID to form the 802.11 Ad Hoc Network. Install and enable the ICS (Internet Sharing Software, such as "SyGate"... ) function in your host computer. (Note that the Windows 2K or later version, OS, supports the ICS function in Local Area Connection Properties? Sharing)*
- (3) *Set your Toshiba Pocket PC e750/e755 as 802.11 Ad Hoc Mode and choose the same SSID to join the 802.11 Ad Hoc Network (choose the DHCP to get the IP assigned).*

- (4) Check and make sure the Wireless LAN Adapter in the 802.11 Ad Hoc Network have the same IP group. (Please Ping each other to make sure the connection is successful)
- (5) Now you can access the LAN resource successfully.

**B7: What should I do if my host computer cannot wirelessly connect with my Toshiba Pocket PC e750/e755?**

- (1) Make sure you have setup the partnership for your Toshiba Pocket PC e750/e755 and your host computer.
- (2) Make sure you are within the range of a working network.
- (3) Make sure you have entered the IP address of the host computer as the WINS server on your Toshiba Pocket PC e750/e755.
- (4) Reset your Handheld PC or Toshiba Pocket PC e750/e755 to make the TCP/IP settings take effect
- (5) Make sure the SSID, WEP keys and channel for all devices in the network are set the same.
- (6) Make sure the channel been set is in the range of 1~11.

## C. Application

**C1: What should I do to use the ActiveSync Function through Wireless Network?**

- (1) Make sure you have already setup the partnership for your Toshiba Pocket PC e750/e755 and your host computer through USB Interface and the ActiveSync can work properly. (The ActiveSync connection Interface should also choose the Ethernet interface for Wireless LAN ActiveSync Connection)
- (2) Make sure you are within the range of a working Wireless Network.
- (3) Make sure you can Ping your Toshiba Pocket PC e750/e755 from your Host Computer. (Make sure the SSID, WEP keys and channel for all devices in the network are set the same.)
- (4) Make sure you have entered the IP address of the host computer as the WINS server on your Toshiba Pocket PC e750/e755.
- (5) Reset your Toshiba Pocket PC e750/e755 to make the TCP/IP settings take effect and execute the ActiveSync function in the Toshiba Pocket PC e750/e755 to enjoy the high speed ActiveSync Wirelessly.

**C2: How do I wirelessly browse the Internet?**

- (1) If your network uses DHCP (Dynamic Host Configuration Protocol), an IP address and DNS (or WINS) will be assigned automatically. On your Toshiba Pocket PC e750/e755, simply click Start→Setting→Connections→Network Adapters→IEEE802.11b WLAN Adapter→Properties to set the proper setting for Internet

connection.

- (2) If your network does not use DHCP, you should enter the IP address, subnet mask, gateway and DNS (or WINS).

**IP Address** is Internet Protocol Address; a numeric address such as 10.37.238.100 that the domain name server translates into a domain name. Each node on the IP network should have a unique IP address.

**Subnet mask** is a number used to identify a subnetwork when multiple networks share one IP address. For example 255.255.255.0 Gateway is a device used to forward IP packets to and from a remote destination.

**DNS** stands for Domain Name System, a database system, which translates addresses and domain names. For example, a numeric address like 232.245.021.54 can become something like cba.com.

**WINS** stands for Windows Internet Naming Service which has two functions; one is a Microsoft Net BIO name server that eliminates the broadcasts needed to resolve computer names to IP addresses by providing a cache or database of translations. The other one is to set the IP address of the host computer that you already construct the partnership for Network adapter Active sync purpose.

To set IP address, Subnet mask and Gateway, click Start → Settings → Connections → Network Adapters → IEEE802.11b WLAN Adapter → Properties → IP Address. To set DNS or WINS (Windows Internet Naming Service), click Start → Settings → Connections → Network Adapters → IEEE802.11b WLAN Adapter → Properties → Name Servers.

- (3) To ping your Toshiba Pocket PC e750/e755 from your host computer. In the Host Computer, open the DOS command mode window, type the command "Ping" followed by the IP address, such as "Ping 140.124.40.112". If you can see the reply from this IP address, the connection is complete. You are now ready to browse the Internet using Internet Explorer on your Toshiba Pocket PC e750/e755.

### **C3: How do I wirelessly check my e-mail?**

- (1) Please make sure that you can use the ActiveSync function through USB Interface at first, and make sure you can use the ActiveSync to receive and send e-mail successfully. For corporate e-mail received and sent, please check with your network administrator for necessary connection settings.
- (2) Make sure you have entered the IP address of the host computer as the WINS server on your Toshiba Pocket PC e750/e755.
- (3) Reset your Toshiba Pocket PC e750/e755 to make the TCP/IP settings take effect and execute the ActiveSync function in Toshiba Pocket PC e750/e755 to enjoy the high speed ActiveSync Wirelessly to receive and send e-mail.

## D. Settings

### D1: What is SSID? What should I set in the SSID field?

SSID stands for Service Set Identification, which is the ID to form the Wireless Network. You can set up to 32 characters in the SSID field. For the Infrastructure Mode, you should set the SSID the same as the Access Point been connected with. To create a 802.11 Ad Hoc Network, the SSID must be the same among stations to enable the wireless communication within the local area network.

 You need to choose a proper SSID and channel for the first 802.11 Ad Hoc station. For other stations want to join the same SSID group, you could only choose the same SSID as the first station, but the channel will not take effect. The 802.11 Ad Hoc must enter the proper SSID. Blank SSID for the 802.11 Ad Hoc Mode is not allowed. The stations want to join the 802.11 Ad Hoc Network must have the same SSID and are suggested to have the same IP Address in the Network group.

### D2: Why can't I choose the "Channel" and "Country" field in "Infrastructure" Mode?

For the Infrastructure Mode, the Country and Channel are decided by the Access Point. You can only join the existing Access Point formed Wireless Network but not create a new Wireless Network. That is the reason why you can't set the "Channel" and "Country" settings.

### D3: When should I set the IP address, Subnet mask and Default gateway settings?

When the Wireless Network does not have the DHCP server, you should set your own IP address, Submask and Default gateway for Wireless Network connection. Otherwise, the OS might set the different Network group IP address for you, which will cause the disconnection for the Wireless Network.

### D4: How can I set the IP address, Subnet mask and Default gateway settings?

Simply click Start→Settings→Connections→Network adapter→IEEE802.11b WLAN Adapter→Properties→IP Address to set IP address, Subnet mask and Default gateway settings.

### D5: What Transmit Rate should I choose for Wireless Connection?

Suggest you to use the "Fully Auto" option in the "Transmission Rate" field for full Transmission Data Rate range to automatically adjust the Best Communication Data Rate and to be compatible with other Low speed 802.11 Wireless Device.

## E. Security

### E1: What is WEP?

WEP stands for Wired Equivalent Privacy, a security service, used to prevent the unauthorized access to your wireless network.

### E2: How many WEP security service modes does my Wireless LAN support?

WEP stands for Wired Equivalent Privacy that is the security service for the Wireless Network. There are three WEP security service modes available for "IEEE 802.11b WLAN Adapter" formed Wireless Network. The first is "Disable" which will disable the WEP security service; the second is "64bit" which will support 5 bytes Hexadecimal value WEP security service; the third is "128bit" which will support 13 bytes Hexadecimal value WEP security service.

### E3: How do I set the WEP security service?

Please click Start?Settings?System?Wireless LAN Utility?Advanced to view Advanced page where you can set the WEP security service. Please choose the proper WEP Key Mode, WEP KeyID and WEP Key value for the Wireless Network.



*The WEP Mode, WEP KeyID and WEP Key value must be exactly the same as your Wireless Network's to enable the connection. Example of setting the WEP:*

*You can choose*

- 1. WEP Mode "64bit", KeyID "1" and Key "1234567890", or*
- 2. WEP Mode "128bit", KeyID "1" and Key "12345678901234567890123456", or*
- 3. WEP Mode "Disable" for connection*

## F. Performance

### F1: Will IEEE802.11b WLAN Adapter work in the environment where Bluetooth network is employed?

Yes, IEEE802.11b WLAN Adapter can coexist with Bluetooth environment.

### F2: How far is the working range of IEEE802.11b WLAN Adapter?

It depends on the data transmission rate and the condition of the environments. The higher the data rate, the smaller the range it could cover. At 11 Mbps, the adapter can go up to 300 meter in an outdoor environment; however, in an indoor environment, it can only go up to 100 meter. Because of the ceilings, higher RF interference, interior walls and reflected signals, indoor range is usually shorter than outdoor range.



**F3: How does the data transmission rate work?**

IEEE802.11b WLAN Adapter allows you to choose one of the six data rate options: Fixed 1Mbps, Fixed 2Mbps, Fixed 5.5Mbps, Fixed 11 Mbps, Auto Select 1 or 2 Mbps, and Fully Auto.

The farther the distance between two communicating devices, the slower the data rate should be used. Basically, with slower data rate, the data delivery will be more reliable. If you don't know which data rate should be used, simply choose "Fully Auto", and the data rate will automatically step down from 11 Mbps, 5.5 Mbps, 2 Mbps, to 1 Mbps if you move farther your Toshiba Pocket PC e750/e755 away from the Access Point or other connected mobile device.

**F4: The Wireless LAN uses lots of power. What should I do to save power?**

- (1) Please turn off the WirelessLAN Switch if you are not using the Wireless Network currently, or
- (2) You can click the "Radio Off" button on Start→Settings→System→Wireless LAN Utility→Config page to temporarily disable the RF function, or
- (3) You can click Start→Settings→System→Wireless LAN Utility→Advanced to get into Advanced Page and tick the "Enable Power Saving Mode" to enter the Power Saving Mode.



- (1) *Turn off the WirelessLAN Switch will cause the disconnection of the Wireless Network, please make sure to close all the Wireless Connection before you execute this function.*
- (2) *"Radio Off" function will cause the disconnection of the Wireless Network, please make sure to close all the Wireless Connection before you execute this function.*
- (3) *Enable "Power Saving Mode" will keep the connectivity but will lower down the average throughput due to longer connection period for the Wireless Network.*
- (4) *If you are in 802.11 Ad Hoc Mode, you are not allowed to enable "Power Saving Mode", because Ad Hoc Mode doesn't support this function.*

**F5: How do I make sure that the Wireless LAN SW has been installed successfully and that Wireless LAN already work properly?**

- (1) Please check if the "IEEE 802.11b WLAN Adapter" already exist in Start→Settings→Connections→Network Adapters; if not , the Wireless LAN Driver is not Installed successfully.
- (2) Please check if the Wireless LAN Utility already exist and could be opened successfully by simply click Start→Settings→System→Wireless LAN Utility.
- (3) Click Start?Settings?System?Wireless LAN Utility?Link to check the current Link information in the Link Page.

## Specifications

<b>External dimensions</b>	<b>125 x 80 x16mm</b>
<b>Weight</b>	180g.
<b>Operating conditions</b>	Temperature: 32 F to 104 F, Humidity: 30 to 80% when only the Toshiba Pocket e750/e755 is operating. Temperature capable of charging 41 F to 104 F.
<b>Battery Type</b>	1050mAh Li-ion battery
<b>Processor</b>	Intel (R) PXA 255 processor at 400 MHz
<b>Memory</b>	RAM: 64 MB mobile ram with 32 MB Flash ROM
<b>Display</b>	Sharp 3.8", Trans-reflective LCD screen
<b>Interfaces</b>	
RGB	
USB Host/Client	
SIR	
DC-in	
<b>Headphone</b>	(4 rings)
<b>Microphone</b>	(4 rings)
CF card slot	Flash type II slot
SD card slot	SD slot x 1 The security finctionof the SD memory card is not usable. Data encrypted by the SD memory card security function - compatible equipment is not usable.
cradle connection port	
<b>Audio</b>	AC 97 Codec, Mono record, Stereo playback, 8.0, 11.025, 22.025, and 44.1 KHz sample rate. Full Duplex record and playback. On board microphone. on board speaker. Stereo earphone jack x 1. software volume control.
<b>Accessories</b>	<b>Ac Adaptor, USB client cable, stylus pen, cradle, USB host cable, battery pack, high capacity battery pack, battery charger.</b>

Although the display is manufactured using an extremely high order of technology, there may be a case that some dots do not light or always light. It is not a malfunction.