

COMPETENCE E3140-1

The Built-In Pyrolytic Oven

Operating Instructions

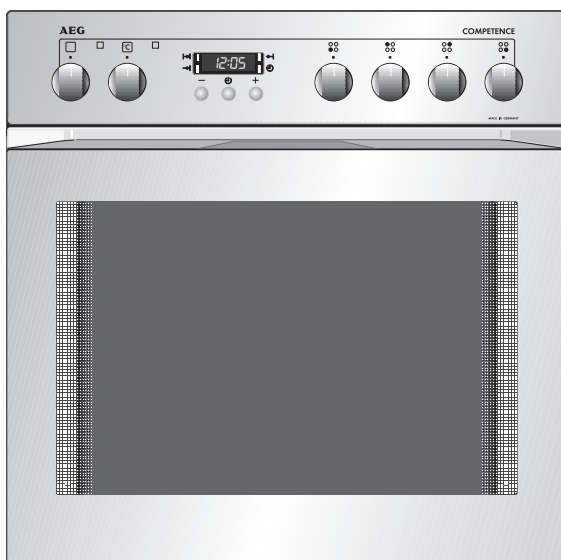

Dear Customer,

Please read these operating instructions carefully.

In particular please note the "Safety" section on the first pages. Please retain these operating instructions for later reference and pass them on to any future owners of the appliance.



The warning triangle and/or key words (**Warning!**, **Caution!**, **Important!**) highlight information that is important for your safety or the function of the appliance. It is imperative that this information is observed.



1. This symbol guides you step by step through the operation of the appliance.

2. ...



This symbol gives you additional information and practical tips on using the appliance.



Tips and information about the economical and ecological use of the machine are marked with the clover sign.

These operating instructions contain information on steps you can take yourself to rectify a possible malfunction. Refer to the section "What to do if..."

In the event of any technical problems please contact your nearest CUSTOMER SERVICE CENTRE at any time. (Addresses and telephone numbers may be found in the appendix under "Customer Service Centres").

You should also refer to the section "Service".

Printed on environmentally friendly paper.
Thinking ecologically means acting ecologically ...

Contents

Safety Instructions	5
Disposal	7
Eco-insulation	7
Appliance Assembly	8
Control Panel	8
Clock Functions	9
Oven Features	10
Oven Accessories	11
Oven Functions	12
Before Using for the First Time	14
Initial Cleaning	14
Set the Time	15
Resetting the Time	16
Using the Rings	17
Cooking with the Rings	18
Using the Oven	19
Positioning the Shelf Unit and the Universal Baking Tray	19
Switching the Oven On and Off	20
Using the Automatic Function	21
Countdown	24
Oven safety cut-out	25
Uses, Tables and Tips	26
Cooking	26
Settings for Cooking on the Rings	26
Baking	27
Baking Table	29
Tips for Baking	31
Pies and Gratin Table	32
Frozen Ready Meals Table	33
Roasting	34
Table for Roasting	36
Grilling	38
Grilling table	38

Defrosting	39
Defrosting table	39
Preserving	40
Preserving times	40
Cleaning and Care	41
Exterior of the Appliance	41
Oven Interior	41
Accessories	41
Side Support Rails	42
Cleaning with Pyroluxe	44
Oven Light	44
Oven Door	45
Oven Door Glass	46
What to do if	48
Technical Data	50
Oven Interior Dimensions	50
Regulations, Standards, Directives	50
Index	54
Service	55



Safety Instructions

The installation and connection of the new appliance must only be carried out by a **registered specialist**.

Where damage occurs the warranty will not apply if this instruction has not been adhered to.

The safety features of AEG electrical appliances comply with recognised technical standards and the German law covering equipment safety.

However, as manufacturers we also believe it is our responsibility to familiarise you with the following safety instructions.

General Safety

- Take care when connecting electrical appliances to sockets near to the appliance. Do not allow connecting leads to come into contact with hot rings or to catch beneath the hot oven door.
- Do not store inflammable objects in the oven. They may ignite when the oven is switched on.
- For safety reasons cleaning the appliance with a steam jet cleaner or high-pressure water cleaner is **not permissible**.
- Using force, especially on the edges of the front glass panel, may break the glass.
- **Caution:** Risk of burning! Whenever you bake, roast or grill the oven door becomes hot, as do the inner surfaces of the oven, heating elements and accessories. Always use an oven cloth or oven gloves and take every care to avoid burns. **For this reason** keep children away from the appliance **at all times**.
- Overheated fats and oils catch fire quickly. Do not leave the appliance unattended when cooking food in fat or oil (e.g. chips).
- Using ingredients containing alcohol in the oven may create an alcohol-air mixture that is easily ignited. In this case, open the door carefully. Do not have embers, sparks or naked flames in the vicinity when opening the door. We recommend that you leave the cooked item in the oven with the door closed and the oven turned off for about 10 - 15 minutes to cool.
- **Repairs** to the appliance may only be carried out by **qualified specialists**. Improperly effected repairs may result in significant risk to the user. If your appliance needs repairing, please contact customer service or your dealer.
- If the appliance malfunctions: remove fuses or switch off.

Intended Use

- This appliance is intended to be used for cooking, frying and baking food in the home and must not be used for any other purpose.
- Only use the appliance to prepare food.
- Do not use the oven as a room heater.

To Avoid Damaging Your Appliance

- Do not line your oven with aluminium foil and do not place a baking tray or dish on the oven floor, otherwise the oven enamel will be damaged by the resulting build up of heat.
- Clean the appliance after each use. This is the easiest way to remove spills and prevents them being burnt on.
- Juice from fruit that drips from baking trays will leave marks that cannot be removed. For very moist cakes, use the universal baking tray.
- Never pour water directly into the hot oven. The enamel may be damaged.
- Do not put any weight on the open oven door.
- Do not store moist food in the oven.



Disposal

Disposing of packaging material

All materials used can be fully recycled.

The cardboard container is made from 80% recycled paper.

Plastics are marked as follows:

- >PE< indicates polythene, as used on the outer covering and the wrappings inside.
- >PS< indicates expanded polystyrene e.g., the padding materials. It is entirely CFC-free.

Any unwanted packaging materials will be taken back by your dealer free of charge.

Disposing of old appliances

To protect the environment, it is important that worn out appliances are disposed of in the correct manner. This applies to your old appliance and will also apply to your new appliance at some time in the future when it is no longer required.



Warning! Before disposing of old appliances make them inoperable. Disconnect the appliance from the mains supply and remove the mains lead.

This prevents children getting into life-threatening situations when playing.



Disposal advice

- The appliance must not be disposed of with household rubbish.
- You can obtain information about collection dates or public refuse disposal sites from your local refuse department or council.
- You can also take the appliance to your AEG dealer; they will dispose of it for you for a small contribution towards the costs.

Eco-insulation

The oven is fitted during manufacture with eco-insulation. This insulation has been tested for harmful substances by independent test centres and has been classified safe.

Appliance Assembly

Control Panel

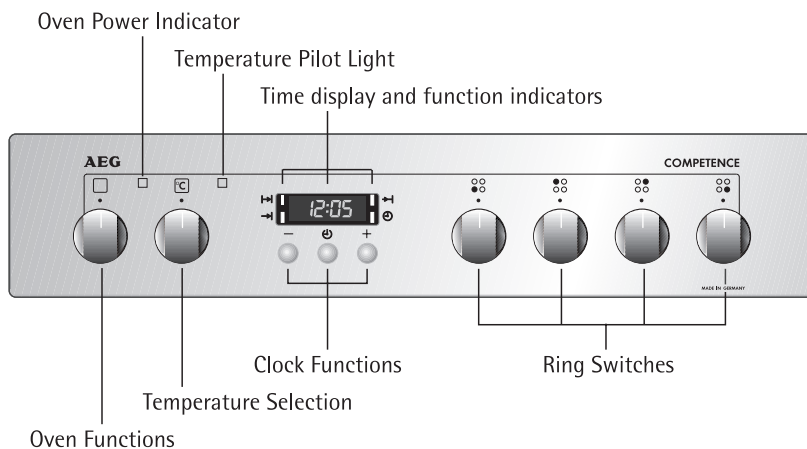

The rotary switches used to operate the oven and rings can be read from above.

Oven functions

Rotary switch used for selecting the required oven function.

Temperature selection

Rotary switch for selecting the required oven temperature.

Oven power indicator

The yellow oven power indicator comes on as soon as the oven or rings are switched on.

Temperature pilot light

The red temperature pilot light comes on while the oven is warming up and goes out once the set temperature has been reached.

Ring switches

Rotary switches for switching on the cooking zones.

Clock functions and time display

Buttons for setting the clock functions. The time or alarm time is displayed in the time display.



Clock Functions

Your appliance has a programmable clock by which you can see the time, use the countdown timer as an "egg-timer" or set baking and roasting times using the automatic functions.



Time

The current time is shown in the display window provided no other clock function has been selected.

Countdown timer

Using the countdown function  you can set a maximum "alarm time" of 2 hours 30 minutes. The countdown function  works like a normal kitchen alarm and does not affect the operation of the oven in any way.

Automatic functions

Using the cook time  and end time functions  you can set the clock so that the oven automatically switches on or on and then off.

Oven Features

Shelf positions

There is a shelf support rail on both sides of the oven, with 5 shelf positions on which to insert the accessories.

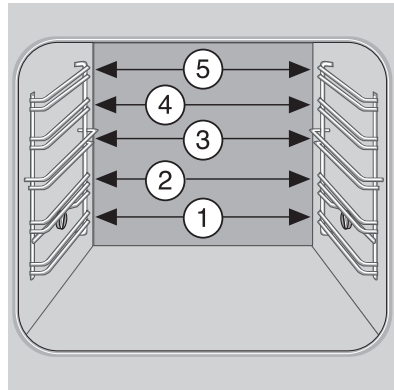

Anti-tip device

All slide-in units are fitted with an anti-tip device to prevent them being pulled out of the oven unintentionally.

When the unit is inserted the anti-tip device must be to the rear of the oven.

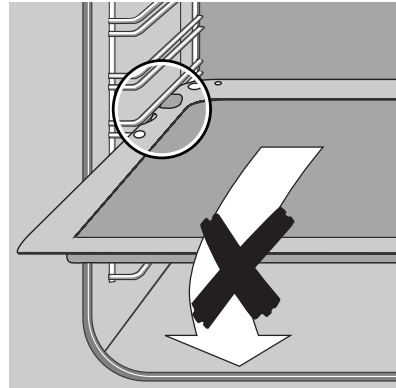

Oven steam vent

The steam from the oven is fed directly to the extractor hood via the duct in the rear of the cooking surface.

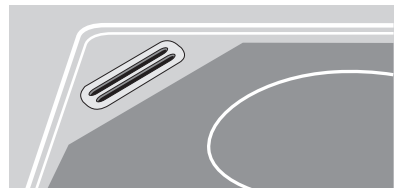

Fan run-on

The fan switches on automatically as soon as the oven is switched on. Once the oven has been switched off, the fan continues running to cool down the appliance and then switches itself off automatically.

Oven Accessories

The following parts are supplied with the oven:

Combination shelf

For dishes, cake tins, items for roasting and grilling

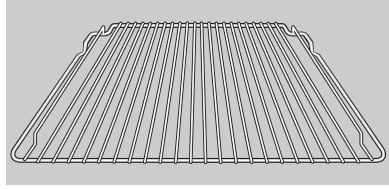

Universal baking tray

For moist cakes, roasts or as a baking tray or as a container to catch fat

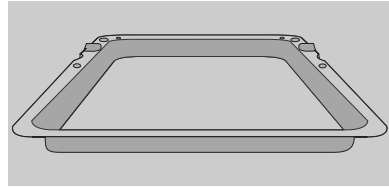

Oven Functions

The oven has the following functions:

Hot air

Hot air is particularly suitable for **baking** biscuits on **2 levels at the same time**.

The oven temperatures are usually 20-40 °C lower than with conventional.

Top and bottom heat are used. In addition, a fan in the rear wall of the oven ensures constant circulation of hot air within the oven compartment. Hot air reaches all sides of the food.

Conventional

Conventional oven heating is suitable for **baking** and **roasting** on **one level**.

Heat is supplied evenly from above and below.

Rotitherm

Rotitherm is particularly suitable for **roasting** larger joints of meat or poultry on one level. The function is suitable for **browning** gratin dishes and **crisping** toppings.

The grill heating element and the fan operate alternately.

Dual grill

The dual grill is suitable for **grilling** or **toasting** large quantities of flat food such as steaks, escalopes, fish or toast.

When you use this function an additional, second grill heating element in the oven ceiling is switched on.

Grill

Grilling is particularly suitable for **grilling** or **toasting** flat foods, such as steaks, escalopes, fish or toast.

The heat is supplied from the grill element on the oven ceiling.

Bottom heat

You can use this oven function to **crisp and brown** bread, cakes (e.g., moist cakes) and pastries from below.

In this case only the heater fitted in the base of the oven is used.

Defrosting

Using the defrost oven function you can **partially-** or **completely and evenly defrost** foods such as flans, butter, bread, fruit or other delicate foods.

With this function only the fan is in operation; there is no heating.

Pyroluxe

The pyroluxe function is a self-cleaning system. It works by burning left-on deposits within the oven to cinders which can easily be wiped off after the oven has cooled.

For this function the oven is heated to approx. 500 °C.

Before Using for the First Time

Initial Cleaning

Before using the oven for the first time you should clean it thoroughly. You can switch on the oven light to make cleaning easier.

-  1. Turn the oven function switch to Oven Lighting .
2. Remove all accessories and the side support rails, and wash them with warm water and washing-up liquid.
3. Then wash out the oven with warm water and washing-up liquid, and dry.
4. Wipe off the front of the unit with a damp cloth only.

 To clean stainless steel fronts use commercially available cleaning agents that create a protective film to prevent finger marks.



 **Important:** Do not use any caustic, abrasive cleaners! The surface could be damaged.

Set the Time

i The oven will only operate when the time has been set.

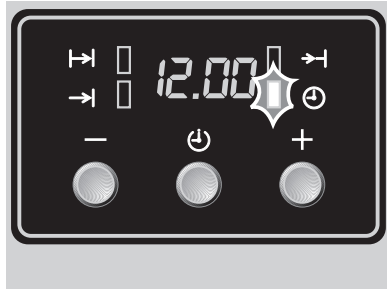
When the power supply is switched on, or after a power failure, the function indicator flashes on the clock display .



1. Using buttons  or  set the current time.

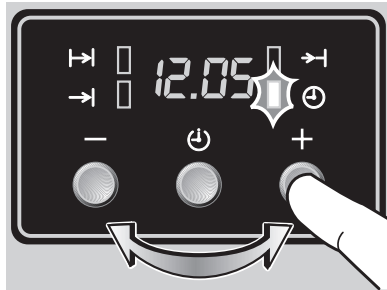



2. Wait for 5 seconds.

The flashing will stop and the set time will be displayed in the display window.

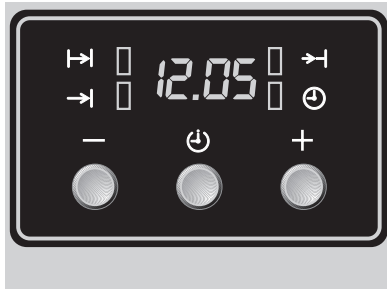

The appliance is ready for use.

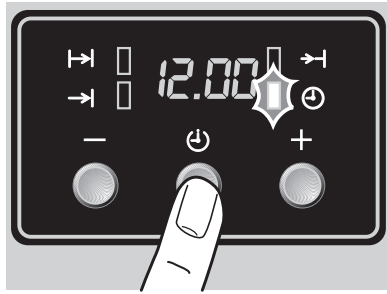

Resetting the Time

-  Press button  until the function indicator flashes on the clock display .





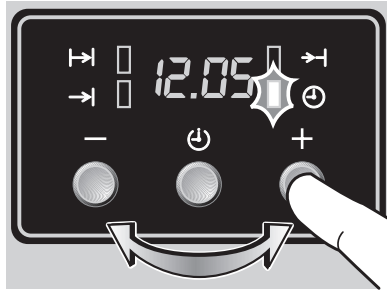

3. Using buttons  or  set the current time.

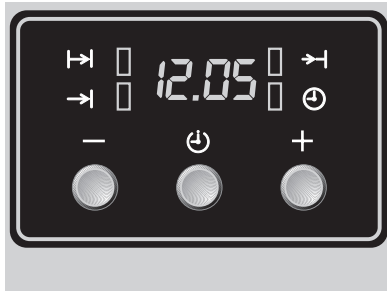

4. Wait for 5 seconds.

The flashing will stop and the set time will be displayed in the display window.
The appliance is ready for use.



-  The time may only be reset when no automatic function (cook time  or end time ) has been set.

Using the Rings

Also refer to the operating instructions for your built-in cooking unit. It contains important information on ovenware, operation, cleaning and care.

Heat settings

- Within the range of settings 1-9, it is possible to select 14 heat settings (including intermediate positions).
- Intermediate positions may be selected between settings 2 and 7. They are marked with a dot between the heat settings.

1 = lowest heat setting
9 = highest heat setting

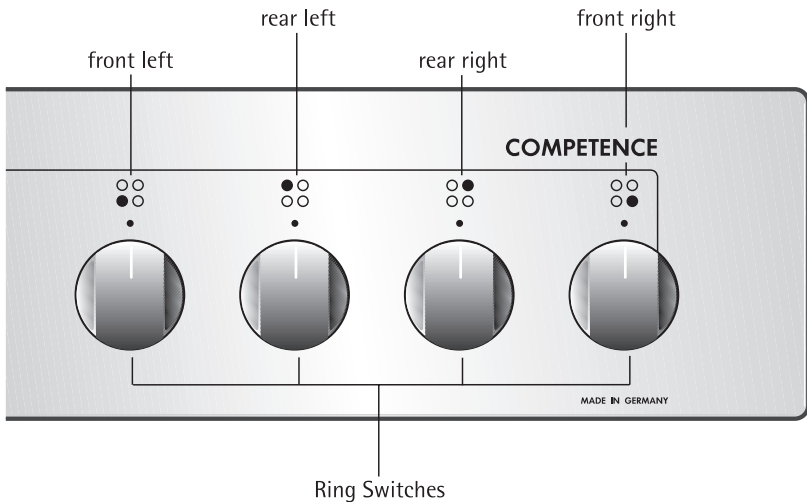

Cooking with the Rings

 1. Select a high heat setting to boil/fry.

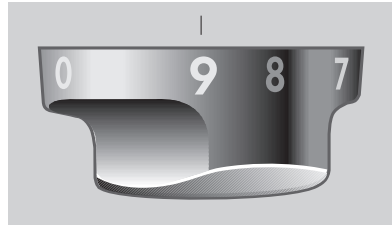

2. As soon as steam appears or the fat is hot, lower the setting to the required position to continue cooking.

3. To stop cooking, turn back to the zero position.

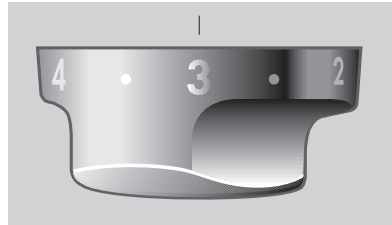

Switch the cooking zone off approx. 5-10 minutes before cooking is finished to make use of the residual heat. This saves electricity.

Using the Oven

Positioning the Shelf Unit and the Universal Baking Tray

All slide-in units have a small bulge on the left and right. This bulge serves as an anti-tip device and must always point downwards.

Inserting shelf unit

- ➡ Insert the shelf unit with both guide rails pointing upwards. The anti-tip device must point downwards and be positioned to the rear of the oven compartment.

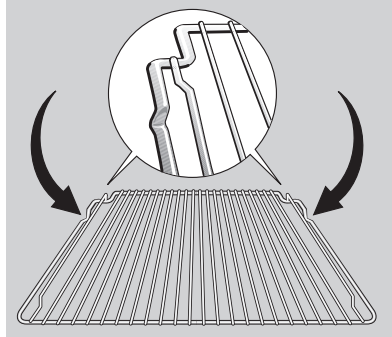

Inserting the shelf unit and tray

- ➡ When the shelf unit and universal baking tray are used together, carefully place the shelf anti-tip device in the bulges on the tray.

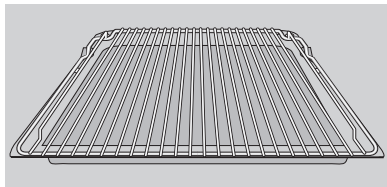

Switching the Oven On and Off

1. Turn the "Oven Functions" switch to select the required function.

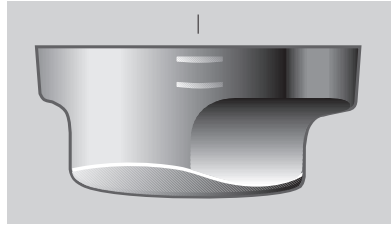

2. Turn the "Temperature Selection" switch to set the required temperature.

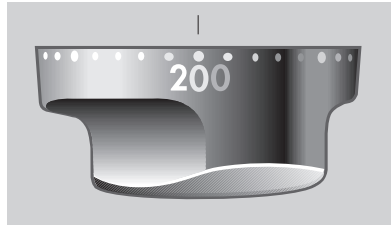

3. The yellow oven power indicator will come on while the oven or rings are in use. The red temperature pilot light will come on while the oven is heating up and will go out as soon as the set temperature has been reached.

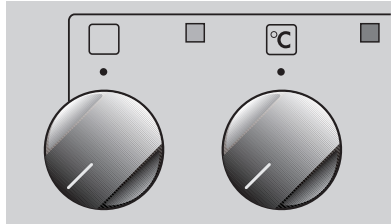

4. To switch the oven off turn the "Oven Functions" switch and the "Temperature Selection" switch back to zero.

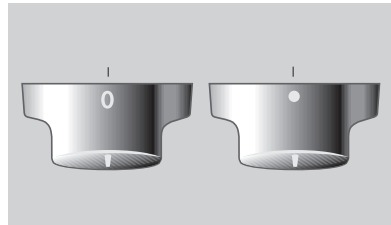



Using the Automatic Function

i The required oven function and temperature can be selected before or after setting the automatic function.



You can select the following functions:

Cook time

Using the cook time  function you can set the time for which the oven is required to operate.

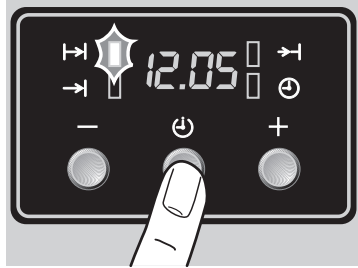
1. Keep pressing the  button until the cook time function indicator  flashes.



2. Using buttons  or  set the required cooking time.

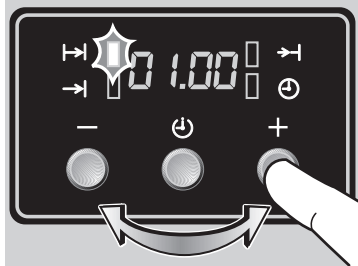

3. Wait for 5 seconds. The display will revert to showing the time. The cook time function indicator  will come on and the oven will start to work at once. When the cooking time has elapsed the function indicator will flash, an acoustic signal will sound for 2 minutes and the oven will switch off.

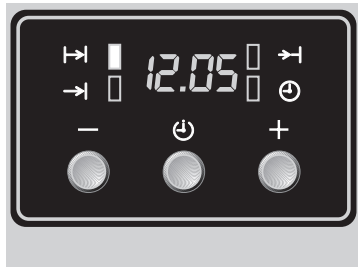



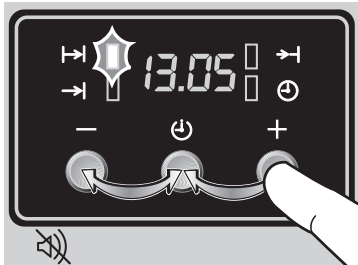

4. Press any button to cancel the signal.

When you have finished cooking turn the oven function and temperature switch back to zero.





End time

Using the end time function  you can set the oven to switch off automatically.

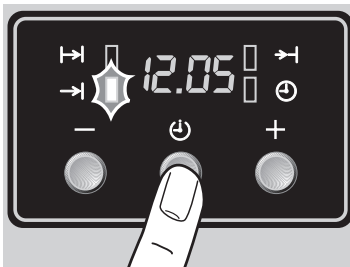
-  1. Keep pressing the button  until the end time function indicator  flashes.



2. Using the  or  buttons set the time at which you require the oven to switch off.

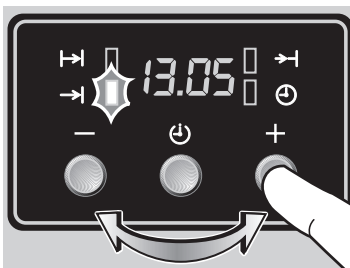



3. Wait for 5 seconds. The display will revert to showing the time. The end time function indicator  will come on and the oven will start to work at once. When the time has expired the function indicator will flash, an acoustic signal will sound for 2 minutes and the oven will switch off.



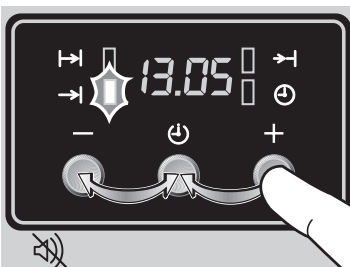

4. Press any button to cancel the signal.
When you have finished cooking turn the oven function and temperature switch back to zero.



Cook time and end time combined

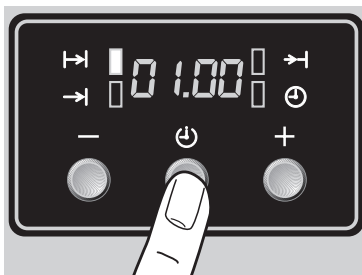

 Cook time  and end time  can be used simultaneously if the oven is required to switch on and off automatically at a **later** time .

-  **1.** Using the cook time function  set the time for which the dish is required to cook.
In this case 1 hour.

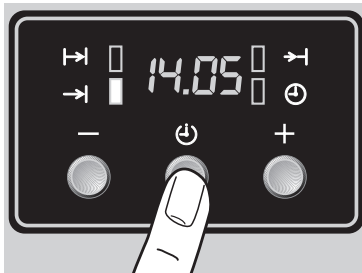

- 2.** Using the end time function  set the time at which the dish should be ready.
In this case 14:05



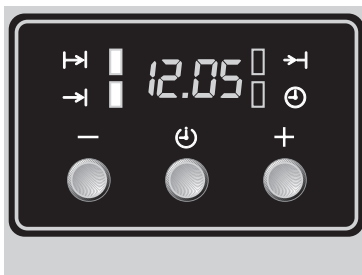

- 3.** The cook time  and end time  function indicators will come on and the time will be displayed in the display window.
In this case 12:05
The oven will switch on automatically at the calculated time.
In this case at 13:05
And will switch off again when the given time has expired. (14:05)





When you have finished cooking turn the oven function and temperature switch back to zero.

Countdown

At the end of the countdown  an acoustic signal will sound.

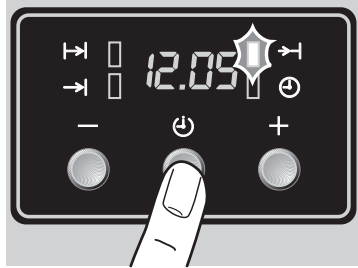
1. Keep pressing button  until the countdown function indicator  flashes.



2. Using buttons  or  set the required countdown.
(Max. 2 hours and 30 minutes.)

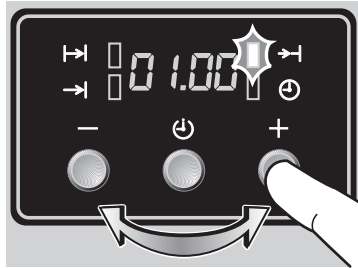

3. Wait for 5 seconds. The display will show how much time remains.
The countdown function indicator  will come on. When the time has expired the function indicator will flash and an acoustic signal will sound for 2 minutes.

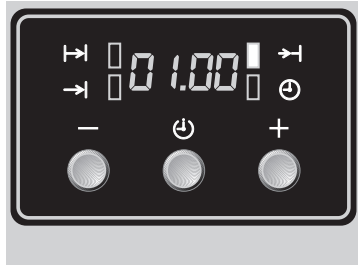

4. Press any button to cancel the signal.

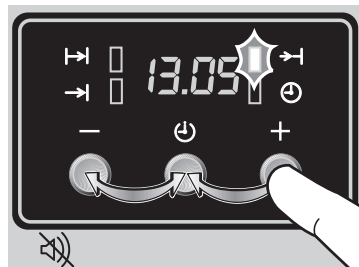

Oven safety cut-out



If not switched off after a certain time, or the temperature is not changed, the oven switches off automatically.

The red temperature indicator light flashes.

The oven switches off at temperatures of:

30 - 120° C	after	12.5 hours
120 - 200° C	after	8.5 hours
200 - 250° C	after	5.5 hours
250 - 275° C	after	1.5 hours

Switching on again after a safety cut-out

Switch the oven off completely.

You will then be able to switch on again.

Uses, Tables and Tips

Cooking

The information given in the following tables is for guidance. The switch setting required for cooking depends on the quality of the pans and the type and quantity of food.

Settings for Cooking on the Rings

Switch Setting	Cooking/ Continuation Cooking level	Suitable for
9	Bringing to the boil	Heating up large quantities of water, cooking pasta
7-9	Hot fat frying	Deep-frying chips, browning meat, e.g., stewing steak, frying, e.g., potato cakes, chops, steaks
6-7	Light frying	Frying meat, escalopes, veal cutlet cordon bleu chops, rissoles, sausages, liver, roux, lightly frying eggs, pancakes, deep-fried fritters
4-5	Boiling	Cooking larger quantities of food, stews and soups, steaming potatoes, simmering meat stock
3-4	Steaming braising	Steaming vegetables, braising meat cooking rice puddings
2-3	Poaching	Poaching and simmering rice and milk dishes (stir occasionally), steaming small quantities of potato or vegetables, heating prepared dishes
1-2	Melting	Soufflé omelet, cooked-egg garnish or royale, hollandaise sauce, keeping foods warm, melting butter, chocolate, gelatine
0		Residual heat, off position





We recommend using setting "9" to heat up or brown food and then reducing the heat setting to the appropriate level for those foods that require longer cooking.



Baking

For baking use the hot air  oven function or conventional .

Baking tins

- When using conventional heat  coated baking tins or tins made of dark metal are most suitable.
- For hot air  baking tins made of light metal are also suitable.

Shelf positions

- Baking with conventional  is only possible on one shelf position at a time.
- Using hot air  you can bake dry items and biscuits on 2 baking trays simultaneously.

1 Baking tray
Shelf position 3

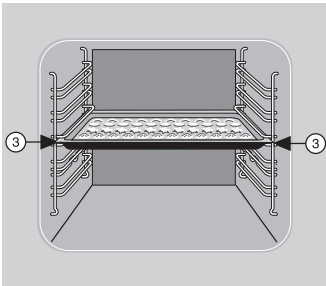

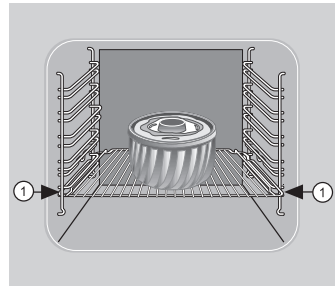

1 Baking tin:
Shelf position 1

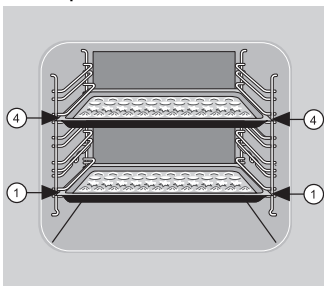

2 Baking trays:
Shelf positions 1 and 4



General information

- Always count the shelf positions from the bottom upwards.
- Insert baking sheets with the bevelled edge to the front!
- Always place cake tins in the middle of the shelf.
- You can also bake with two tins at the same time using conventional  or hot air . In this case, place the cake tins side by side on the shelf. The cooking time is increased, but only slightly.

Notes on the baking tables

In the tables you will find information on temperatures, cooking times and shelf positions for a selection of dishes.

- Ranges are given for the temperature and cooking time since these are dependent on the mixture, quantity and cake tin used.
- When using 2 baking trays the lower baking tray should remain in the oven for an extra 5-10 minutes if necessary.
- Items that might drip (e.g., pizzas, fruit flans) should only be prepared on one level.
- When using for the first time, we recommend setting the lower temperature, and only if necessary, e.g. if increased browning is required or the cooking time is too long, select a higher temperature.
- If you cannot find specific information for one of your own recipes, use information given in a similar recipe for guidance.
- Variations in the height of the item to be baked can lead to different degrees of browning at the start of baking. In this case **please do not change the temperature setting**.
Differences in the degree of browning will balance out during baking.





Switch off the oven 10-15 minutes before the end of the cooking time to make use of the residual heat.

Unless otherwise stated, the information in the tables assumes starting with a cold oven.

Baking Table

Type of Cake or Pastry	Hot Air 		Conventional 		Time
	Shelf Position from Bottom	Temperature °C	Shelf Position from Bottom	Temperature °C	
Baking in tins					
Ring-shaped or pudding-bowl shaped cakes	1	150-170	1	160-180	0:50-1:10
Madeira cake/ king cake	1	140-160	1	150-170	1:10-1:30
Sponge cake	1	140-160	2	160-180	0:25-0:40
Shortcrust pastry flan base	3	170-180	2	190-210 ¹	0:10-0:25
Sponge flan base	3	150-170	2	170-190	0:20-0:25
Covered apple flan	1	150-170	1	170-190	0:50-1:00
Savoury flan (e.g., quiche lorraine)	1	160-180	1	190-210	0:30-1:10
Cheesecake	1	140-160	1	170-190	1:00-1:30
Baking on baking trays					
Plaited roll/ring	3	160-170	3	170-190	0:30-0:40
Fruit loaf	3	160-170 ¹	3	160-180 ¹	0:40-1:00
Bread (rye bread) initiallythen	1	180-200 ¹ 140-160	2	250 ¹ 160-180	0:20 0:30-1:00
Cream puffs/eclairs ²	3	160- 170 ¹	3	190-210	0:25-0:40
Swiss roll	3	150-170 ¹	3	180-200 ¹	0:10-0:20
Dry streusel cake ³	3	150-160	3	170-190	0:20-0:40
Butter cake/sugar cake, sugar-topped cakes	3	160-170 ¹	3	190-210 ¹	0:15-0:30

Type of Cake or Pastry	Hot Air 		Conventional 		Time
	Shelf Position from Bottom	Temperature °C	Shelf Position from Bottom	Temperature °C	
Fruit flan (with a yeast dough/sponge base)	3	140-160	3	170 -190	0:25-0:50
Fruit flan with shortcrust pastry base ²	3	150- 170	3	170 -190	0:40-1:20
Tarts baked with delicate fillings (e.g., curd cheese, cream.)	-	-	3	170 -190	0:40-1:20
Pizza (with deep topping) ²	1	180-200	1	190 -210 ¹	0:30-1:00
Pizza (thin)	-	-	1	230 -300 ¹	0:10-0:25
Unleavened Bread	-	-	1	275 -300 ¹	0:08-0:15
Flat sweet or savoury pies	1	180-200	1	210 -230	0:35-0:50
Biscuits					
Shortbread biscuits ³	3	150 -160	3	170-190 ¹	0:06-0:20
Small piped biscuits ³	3	140 -150	3	160-180	0:10-0:40
Sponge fingers ³	3	150 -160	3	170-190	0:15-0:20
Meringues	3	80 -100	3	100-120	2:00-2:30
Macaroons	3	100 -120	3	120-140	0:30-0:60
Small pastries made with yeast dough	3	150 -160	3	170-190	0:20-0:40
Small pastries made with puff pastry	3	170-180 ¹	3	190 -210 ¹	0:20-0:30
Bread Rolls	3	170-190 ¹	3	180 -220 ¹	0:20-0:35

1) Pre-heat the oven



2) Use the combination/fat tray or the fat tray alone

3) Baking on 2 levels possible Information printed in bold type indicates the **preferred oven function or temperature**

Tips for Baking

	Tip
To tell if your cake is cooked through	Push a wooden skewer into the highest point of the cake. If the skewer comes out clean, you can switch off the oven and utilise the residual heat.
The cake collapses (is sticky, not properly cooked through, water marks)	Check your recipe. Next time, use less liquid. Check that you have beaten the mixture for the correct length of time, particularly when using a food-processor.
The cake is undercooked at the bottom	Next time use a dark cake tin or place the cake one level lower.
Cake with moist topping/cheesecake is not cooked through	Next time bake at a lower temperature and increase the cooking time.





Pies and Gratin Table

	Conventional 		Rotitherm 		Time
	Shelf position from bottom	Temp. °C	Shelf position from bottom	Temp. °C	Hrs: Mins.
Pasta bake	1	180-200	1	160-170	0:45-1:00
Lasagne	1	180-200	1	160-170	0:25-0:40
Vegetables au gratin ¹	1	200-220	1	160-170	0:15-0:30
Pizza baguettes ¹	1	200-220	1	160-170	0:15-0:30
Sweet soufflés	1	180-200	-	-	0:40-0:60
Fish pies	1	180-200	1	160-170	0:30-1:00
Stuffed vegetables	1	180-200	1	160-170	0:30-1:00

1) Pre-heat the oven.

Information printed in bold type indicates the **preferred oven function** for the dish.

Frozen Ready Meals Table



Food to be cooked	Shelf position from bottom	Oven function	Temperature	Time
Frozen pizza	3	Conventional 	in accordance with the maker's instructions	in accordance with the maker's instructions
Chips ¹ (300-600 g)	3	Rotitherm 	200-220 °C	15-25 Mins.
Baguettes	3	Conventional 	in accordance with the maker's instructions	in accordance with the maker's instructions
Fruit flan	3	Conventional 	in accordance with the maker's instructions	in accordance with the maker's instructions

1) Comment: Turn chips 2-3 times during cooking.



When frozen foods are used the trays inserted may distort during cooking. This is because of the large differences in temperature between the frozen item and the oven. Once the trays have cooled the distortion will disappear again.

Roasting

Use the rotitherm  oven function or conventional  when roasting.

Ovenware for roasting



- Any heat-resistant dish is suitable for roasting.
- If the dish has plastic handles, check that they are heat-resistant.
- Large joints can be roasted **directly in the universal baking tray or on the shelf unit with the baking tray placed below** (e.g., turkey, goose, 3-4 chickens, 3-4 knuckles of veal.)
- We recommend that all lean pieces of meat should be roasted **in a casserole dish with a lid** (e.g., veal, marinated beef, pot roast, frozen meat.) In this way the meat will retain its juices.
- You can roast meats that are to be browned or crisped in a **casserole dish without a lid** (e.g., pork joints, meat loaf, lamb joints, mutton, duck, 1-2 knuckles of veal, 1-2 chicken, small poultry, roast sirloin, fillet, game).
- **Tip:** If you use dishes for roasting (particularly for small amounts), the oven will not get so dirty!

Shelf positions

- Please see the following table for the shelf positions to be used.

Notes on the roasting tables



Information is given in the table on suitable oven functions, temperature settings, cooking times and shelf positions for various types of meat. The cooking times are only for guidance.



- We recommend that only meat and fish **with a minimum weight of 1 kg** should be roasted or baked in the oven.
- In general, conventional  is particularly suitable for cooking very lean meat such as fish or game. For all other types of meat (particularly poultry) we recommend the rothitherm function .
- The cooking time required is dependent on the type and quality of the meat.
- To stop meat juices or fat burning onto dishes or the oven, we recommend adding a little liquid to the roasting dish
- Turn the roast after approx. 2/3 of the cooking time.



Switch off the oven 10-15 minutes before the end of the cooking time to make use of the residual heat.

Table for Roasting



Type of Meat	Quantity	Conventional 		Rotitherm 		Time
	Weight	Shelf Position from Bottom	Temperature °C	Shelf Position from Bottom	Temperature °C	Hours: Mins.
Beef						
Pot roast	1-1.5 kg	1	200-250	-	-	2:00-2:30
Roast beef or fillet						per cm of thickness
- red inside	per cm of thickness	1	250-270 ¹	1	190-200	0:05-0:06
- pink inside	per cm of thickness	1	250-270 ¹	1	180-190	0:06-0:08
- cooked through	per cm of thickness	1	210-250 ¹	1	170-180	0:08-0:10
Pork						
Shoulder, neck ham joint	1-1.5 kg	1	210-220	1	160-180	1:30-2:00
Chop, smoked loin chop	1-1.5 kg	1	180-190	1	170-180	1:00-1:30
Meat loaf	750 g-1 kg	1	170-180	1	160-170	0:45-1:00
Pork knuckles (pre-cooked)	750 g-1 kg	1	210-220	1	150-170	1:30-2:00
Veal						
Roast veal	1 kg	1	210-220	1	160-180	1:30-2:00
Knuckle of veal	1.5-2 kg	1	210-225	1	160-180	2:00-2:30
Lamb						
Leg of lamb, roast lamb	1-1.5 kg	1	210-220	1	150-170	1:15-2:00
Saddle of lamb	1-1.5 kg	1	210-220	1	160-180	1:00-1:30

Type of Meat	Quantity	Conventional 		Rotitherm 		Time
	Weight	Shelf Position from Bottom	Temperature °C	Shelf Position from Bottom	Temperature °C	Hours: Mins.
Game						
Whole piece of hare, haunch or jointed hare	up to 1 kg	3	220-250 ¹	3	160-170	0:25-0:40
Saddle of venison	1.5-2 kg	1	210-220	1	160-180	1:15-1:45
Haunch of venison	1.5-2 kg	1	200-210	1	160-180	1:30-2:15
Poultry						
Portions of poultry 4-6 portions	per 200- 250g	3	220-250	3	180-200	0:35-0:50
Half chicken portions 2-4 portions	per 400-500 g	3	220-250	3	180-200	0:35-0:50
Chicken, poulard	1-1.5 kg	1	220-250	1	170-180	0:45-1:15
Duck	1.5-2 kg	1	210-220	1	160-180	1:00-1:30
Goose	3.5-5 kg	1	200-210	1	150-160	2:30-3:00
Turkey	2.5-3.5 kg 4-6 kg	1	200-210 180-200	1	150-160 140-150	1:30-2:00 2:30-4:00
Fish (steaming)						
Whole fish	1-1.5 kg	2/3	210-220	2/3	160-170	0:45-1:15

1) Pre-heat oven.

Information printed in bold type indicates the **preferred oven function for the dish concerned.**

Grilling

To grill, use oven function  for dual grill or  for single grill with temperature setting .



Important: Always preheat the empty oven with the **grill function for 5 minutes!**

Ovenware for grilling

- Use the shelf unit and universal tray together for grilling.

Shelf positions

- For grilling flat foods you should generally use the **4th shelf position from the bottom.**

Notes on the grilling table

The grilling times are only for guidance and will vary depending on the type and quality of meat or fish.

- Grilling is particularly suitable for flat pieces of meat and fish.
- Turn the food halfway through grilling.



Warning: Always grill with the oven door closed. Risk of burning!

Grilling table

Type of Food	Shelf Position from Bottom	Grilling Time	
		1st side	2nd side
Rissoles	4.	8-10 mins.	6-8 mins.
Fillet of pork	4.	10-12 mins.	6-10 mins.
Grilled sausages	4.	8-10 mins.	6-8 mins.
Fillet steaks, veal steaks	4.	6-7 mins.	5-6 mins.
Fillet of beef, sirloin (approx. 1 kg)	3.	10-12 mins.	10-12 mins.
Toast ¹	3.	2-3 mins.	2-3 mins.
Toast with topping	3.	6-8 mins.	-

1) Do not use the universal baking tray together with the grilling shelf unit.

Defrosting

Use the defrost oven function for defrosting.

Dishes for defrosting

- Put the food on a plate and put the plate on the shelf unit.
- Use only parchment paper or suitable cling film to cover the food. Do not cover with a plate or bowl as these considerably prolong the defrosting time.

Shelf positions

- To defrost, insert the shelf unit in the **1st shelf position from the bottom**.

Notes on the defrosting table

The following table offers some guidance on defrosting times.

Defrosting table

Dish	Defrosting Time Mins.	Final Defrosting Time Mins.	Comment
Chicken, 1000 g	100-140	20-30	Place the chicken on an upside-down saucer on a large plate. Defrost uncovered, turning half way through, or defrost covered in suitable cling film.
Meat, 1000 g	100-140	20-30	Defrost uncovered, turning half way through or cover with suitable cling film.
Meat, 500 g	90-120	20-30	Defrost uncovered, turning half way through or cover with suitable cling film.
Trout, 150 g	25-35	10-15	Defrost uncovered
Strawberries, 300 g	30-40	10-20	Defrost uncovered
Butter, 250 g	30-40	10-15	Defrost uncovered
Cream, 2 x 200 g	80-100	10-15	Defrost uncovered (Cream may still be whipped if some parts are still slightly frozen)
Flan, 1400 g	60	60	Defrost uncovered

Preserving

When preserving use the hot air  oven function.

Preserving jars

- Only use commercially available preserving jars (preserving jars with a rubber ring and glass lid) for preserving.
- Screw-top jars, jars with a bayonet fastening and metal containers are unsuitable.

Shelf positions



- When preserving use the **1st shelf position from the bottom** .

Notes on preserving



- Use the universal baking tray for preserving. There is room for up to 6 preserving jars each with a capacity of 1 litre on this tray.
- Stand a cup of water on the universal baking tray so that there is sufficient moisture in the oven.
- Position the preserving jars on the universal baking tray so that they do not come into contact with one another.
- The preserving jars should all be filled to the same level and closed.

Preserving times

Fruit and pickled gherkins

-  1. Select the hot air  oven function and turn the temperature selection switch to 160° C.
2. As soon as bubbles begin to appear in the liquid in the first jars (for 1-litre jars this takes about 45 minutes), switch the oven off.
3. Leave the jars to stand in the closed oven for a further 30 minutes or, in the case of delicate fruits such as strawberries, for approx. 15 minutes.

Vegetables and meat

-  1. Select the hot air  oven function and turn the temperature selection switch to 160° C.
2. As soon as bubbles begin to form in the first jars, lower the temperature to 100 °C.
3. Continue to cook at 100 °C for approx. 60-90 minutes.
4. Then switch off the oven and leave the preserving jars to stand in the closed oven for a further 30 minutes.

Cleaning and Care

Exterior of the Appliance

-  Wipe the front of the appliance with a soft cloth and warm, soapy water.
 - Do not use scourers, caustic cleaners or abrasive items.
 - You can use commercially available cleaning agents on stainless steel fronts. At the same time these form a protective film against finger marks.
 - As an alternative to washing up liquid, you can use glass cleaning spray or cream to clean the aluminium front of your appliance.

Oven Interior

- 
 1. Every time you use the oven, wipe it out afterwards with water and washing-up liquid to which you have added a few drops of vinegar.
 2. Remove stubborn dirt with pyroluxe.

 **Please note:** There is no need to use an oven spray if you use pyroluxe.

 **Important!** If you prefer to use an oven spray, always follow the manufacturer's instructions.

Accessories

-  Wash all slide-in parts (shelf unit, baking tray, etc.) after each use and dry well. Soak briefly to make them easier to clean.

Side Support Rails

The side support rails on the left and right hand sides of the oven can be removed for cleaning the side walls.

Removing the side support rails

-  1. Remove screw.

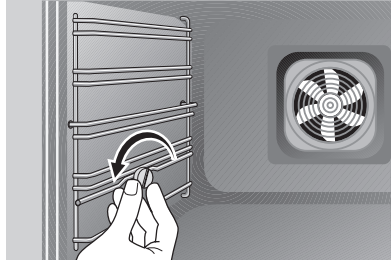

2. Pull the rail at the back away from the oven wall and pivot towards the front (1).

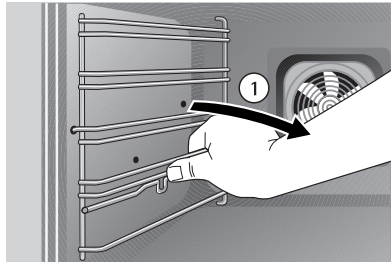

3. Remove rail (2).

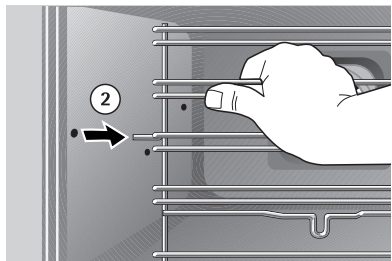

Fitting the side support rails



Take care when fitting the rails that the rounded ends of the guide rails are pointing forwards!

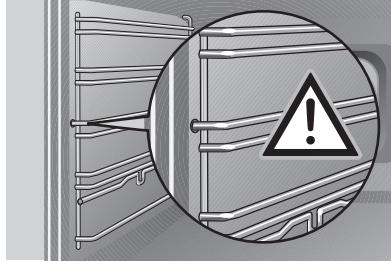

-  **1.** To replace, first insert and fit the rail at the front (1).

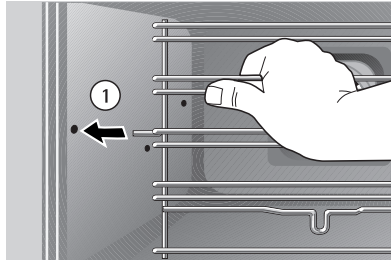

- 2.** Pivot the rail towards the back and insert (2).

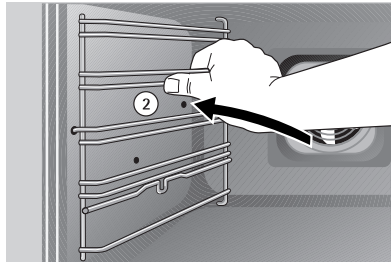

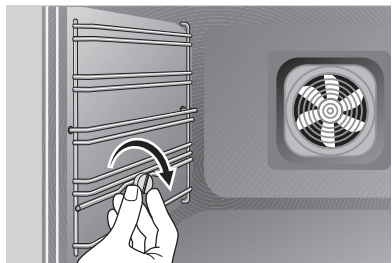

- 3.** Replace the screw.



Cleaning with Pyroluxe

 **Warning!** The oven becomes very hot during pyroluxe self-cleaning. Keep young children well away from the oven.

 **Important:** Before carrying out pyroluxe cleaning the oven must be completely emptied with the exception of the shelf support rails.

 1. Select the pyroluxe oven function.

2. Turn the temperature selection switch clockwise to the end position. Pyroluxe cleaning will begin after a few seconds and will switch itself off again automatically after 2 hours 30 minutes.

3. When pyroluxe cleaning has been completed, turn all switches to the zero position.

4. After it has cooled down, wipe out the oven with a damp cloth.

 During pyroluxe cleaning, the door is locked and the oven lighting is off. The temperature pilot light will come on until the door lock is released.

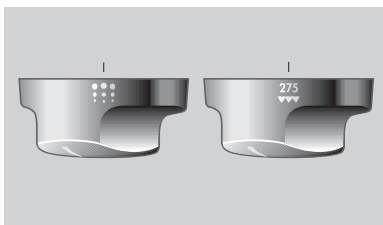

Oven Light

 **Warning:** Risk of electric shock! Prior to changing the oven light:
– Switch off the oven!
– Either remove or switch off the fuses in the fuse box.

Replacing the oven light bulb/cleaning the glass

 1. Remove the right shelf support rail.

2. Place a cloth on the floor of the oven.

3. Remove the glass cover by turning it anti-clockwise and then clean it.

4. **Replace with
40 watt, 230 V, 300 °C
heat-resistant oven lighting.**

5. Refit the glass cover.

6. Remove the cloth from the oven.

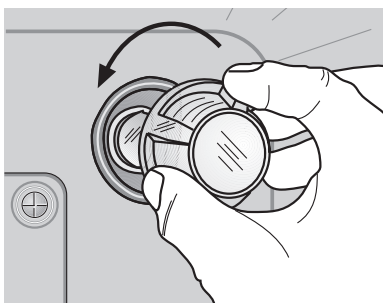

Oven Door

The oven door of your appliance may be removed for cleaning.

Removing the oven door

1. Open the oven door completely.
2. **Completely** fold back the **brass-coloured clamping lever** on **both** door hinges (1).
3. Grip the oven door with both hands on the sides and close it by about $\frac{3}{4}$ (2) **past its resistance**.
4. Pull the door away from the oven (Caution: heavy!) (3).
5. Place the door, with the outer surface downwards, on a soft, flat surface, for example a blanket, to avoid scratches.

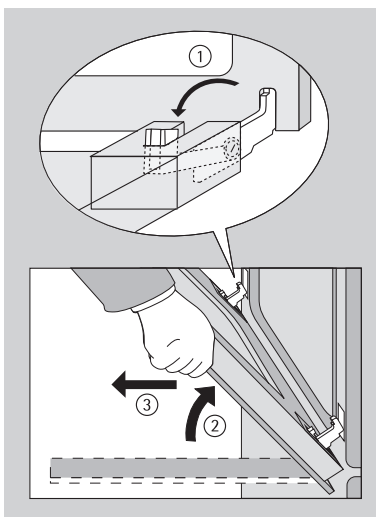

Hanging the oven door

1. With both hands take hold of the sides of the door from the side on which the handle is positioned.
2. Hold the door at an angle of approx. 60° .
3. Slide the door hinges as far as possible into the two slots on the right and left at the bottom of the oven (1).
4. Lift the door up until resistance is met and then open fully (2).
5. Lift the brass-coloured clamping lever on both door hinges back to their original position (3).
6. Close oven door.

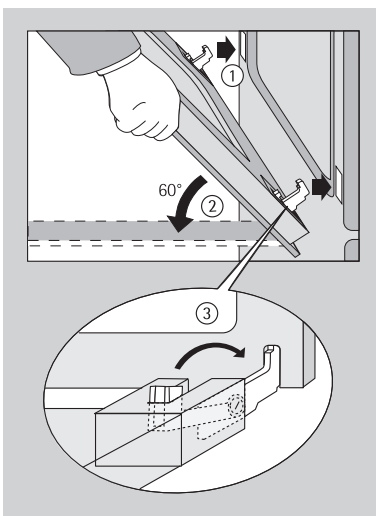

Important! When hanging the oven door the clamping lever on **both** door hinges must be opened out, then push the door hinges in **simultaneously!**

Oven Door Glass

The oven door is fitted with four glass panels mounted one behind the other. The three inner panels may be removed for cleaning.



Warning: Carry out the following steps only when the oven door has been unhinged! When left on its hinges, the door could rise rapidly due to the lighter weight when the glass is removed and could cause injury.

Removing the glass door panels

Unhinge the oven door and place it on a soft, flat surface with the handle facing down.

Remove the three glass panels in sequence as follows:

1. Take hold of the glass panel at the lower edge and slide it against the spring pressure in the direction of the oven door handle until it is free at the base (1).

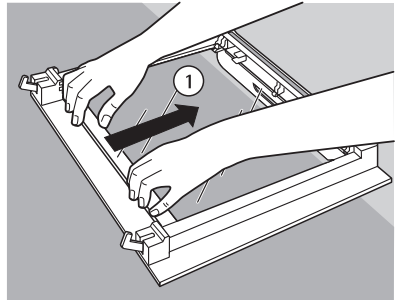

2. Raise the panel **gently** at the base and pull out.

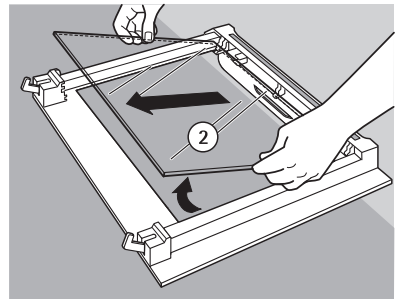

Clean the glass panels

Inserting the glass door panels



The three removable glass panels differ in size. They will only fit into the section of the door for which they are designed.

Smallest panel - at the bottom
Biggest panel - at the top



There is printing on the biggest panel. The panel must be inserted such that when the door is open the print can be read on the front from above.

Re-insert the three panels one at a time and in the appropriate order:

-  **1.** Insert the glass panel at an angle from above into the section of the door in which the handle is located.
- 2.** Lower the glass panel and push against the spring on the handle side.
- 3.** Slide it under the lower bracket towards the lower door edge as far as it will go.

Each glass panel must be firmly positioned and fit exactly into the door frame!

Re-hang the oven door

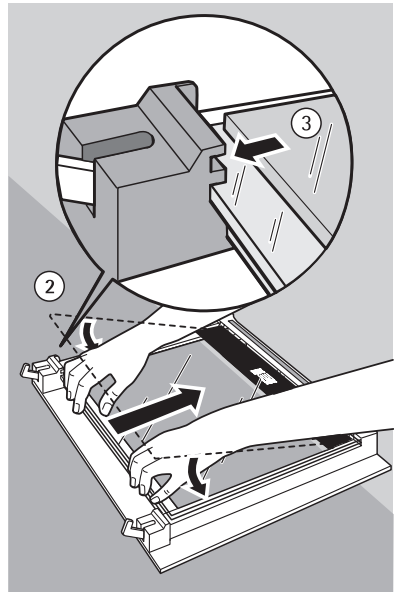
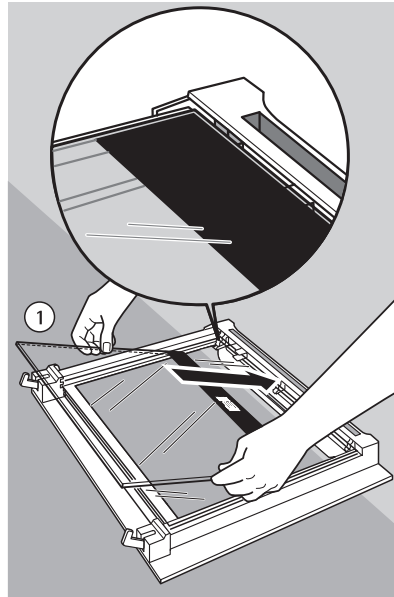

What to do if ...

.... the cooking zones don't work?



Check whether

- the appropriate cooking zone has been switched on,
- the circuit breaker (at the household power distribution box) has tripped or the mains fuse (fuse box) has blown.

.... the oven doesn't heat up?



Check whether

- the appliance is switched on,
- all the necessary settings have been made,
- the circuit breaker (at the household power distribution box) has tripped or the mains fuse (fuse box) has blown.

If the fuse blows or the circuit breaker trips several times, please contact an approved electrician.

.... the oven lighting goes out?



Replace the light bulb in the oven (see section on cleaning and care).

.... the red temperature pilot light flashes slowly?

There has been an interruption to the power supply.



Check whether

- the circuit breaker (at the household power distribution box) has tripped or a mains fuse (fuse box) has blown

Turn the temperature selection and oven functions switches back to zero and reset them to the required settings.

.... both pilot lights flash rapidly

Your appliance is incorrectly connected.



Disconnect appliance from the mains and please contact customer service.

.... the pilot lights flash in a manner not described above?



Please contact customer service.



Due to the cold front of your appliance the inner door glass may steam over briefly if you open the door during or shortly after baking or roasting.

If you call in customer service to resolve a problem listed in these notes, or to rectify a problem caused by incorrect operation of the appliance, the customer service engineer's visit will not be free of charge, even during the warranty period.

Should you still have problems after reading this information, please contact your specialist dealer or customer service.



Warning: Repairs to the unit may only be carried out by qualified specialists. Improperly effected repairs may result in considerable risk to the user. If your appliance needs repairing, please contact your specialist dealer or customer service.

Technical Data

Oven Interior Dimensions

Height x Width x Depth	31 cm x 41 cm x 41 cm
Capacity (usable capacity)	52 l

Regulations, Standards, Directives

This appliance meets the following standards:

- EN 60 335-1 and EN 60 335-2-6
relating to the safety of electric appliances for household use and similar purposes and
- EN 60350 and
- DIN 44546 / 44547 / 44548
relating to the operating features of household electric cookers.
- EN 55014-2
- EN 55014
- EN 61000-3-2
- EN 61000-3-3
relating to basic requirements for electromagnetic compatibility protection (EMC).

CE This appliance complies with the following EC directives:

- 73/23/EWG dated 19.02.1973 (Low Voltage Directive)
- 89/336/EWG dated 03.05.1989 (EMC Directive including Amending Directive 92/31/EWG).

Index

A

Anti-tip device 10

B

Baking 27

C

Cleaning

accessories 41

initial cleaning 14

oven door 45

oven light 44

pyroluxe 44

side support rails 42

Clock functions 9

cook time 21

countdown 24

end time 22

Combination shelf 11

Control panel 8

Conventional oven heating 12

Cooking 18, 26

Customer service 55

D

Defrosting 39

Dishes with toppings 32

Disposal 7

F

Fan run-on 10

G

Grill 12

Grilling 38

H

Hot air 12

O

Oven

accessories 11

features 10

functions 8, 12

light 44

steam vent 10

P

Power indicator 8

Preserving 40

Pyroluxe 13, 44

R

Ready meals 33

Repairs 5

Resetting the time 16

Ring

switches 8

Roasting 34

Rothitherm 12

S

Safety 5

Set the time 15

Shelf positions 10, 27

Shelf unit 19

Side support rails 42

Soufflés 32

T

Tables and tips 26

Temperature selection switch 8

U

Universal baking tray 11, 19

Using the oven 19, 20

Using the rings 17

W

Warranty 5

Service

The section "What do I do if..." lists some faults that you can remedy yourself. Look there first if a fault occurs.

Is it a technical fault?

Then contact your nearest customer service centre. (Addresses and telephone numbers can be found under "Customer Service Centres".)

Always prepare in advance for the discussion. By doing so you will make it easier to diagnose the fault and decide whether customer service is necessary.

Please make a note of the following information as accurately as possible:

- What form does the fault take?
- Under what circumstances does the fault occur?

Prior to the telephone call it is imperative that you make a note of the following appliance code numbers that are given on the rating plate:

- PNC Code (9 digits),
- S No Code (8 digits).

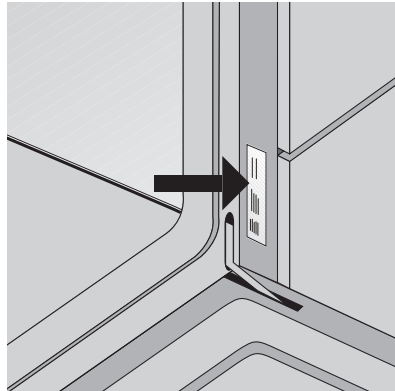

We recommend that you record the code numbers here so that you always have them to hand:

PNC

S No.

When do you incur costs even during the warranty period?

- if you could have remedied the fault using the fault table (see section "What to do if ..."),
- if the customer service technician has to make several journeys because he was not provided with all the relevant information before his visit and therefore, for example, has to fetch spare parts. These multiple trips can be avoided if you prepare for your phone call as described above.

AEG Hausgeräte GmbH
Postfach 1036
D-90327 Nürnberg

<http://www.aeg.hausgeraete.de>

© Copyright by AEG

822 947 476-NO-250102-02

Subject to change without notice