

**TUNGSTEN™** | *E2*



# Getting Started

## Copyright and Trademark

© 2003-2004 palmOne, Inc. All rights reserved.

palmOne, Tungsten, the Tungsten logo, "T" (Stylized), Addit, Blazer, Graffiti, HotSync, Palm, Palm Powered, Palm OS, the Palm logo, and VersaMail are among the trademarks or registered trademarks owned by or licensed to palmOne, Inc. All other brand and product names are or may be trademarks of, and are used to identify products or services of, their respective owners.

palmOne, Inc. uses the Bluetooth wireless technology trademark under express license from Bluetooth SIG, Inc. RealPlayer is a trademark or registered trademark of RealNetworks, Inc. MPEG Layer-3 audio decoding technology is licensed from Fraunhofer IIS and Thomson. This product includes technology owned by Microsoft Corporation and cannot be used or distributed without a license from Microsoft Licensing, GP.

## Disclaimer and Limitation of Liability

palmOne, Inc. assumes no responsibility for any damage or loss resulting from the use of this guide.

palmOne, Inc. assumes no responsibility for any loss or claims by third parties which may arise through the use of this software. palmOne, Inc. assumes no responsibility for any damage or loss caused by deletion of data as a result of malfunction, dead battery, or repairs. Be sure to make backup copies of all important data on other media to protect against data loss.

**[ ! ] IMPORTANT** Please read the End User Software License Agreement with this product before using the accompanying software program(s). Using any part of the software indicates that you accept the terms of the End User Software License Agreement.

## Software Download Available

Palm® Desktop software is supplied on a CD. If you do not have access to a CD drive for your computer, you can download Palm Desktop software from [www.palmOne.com/intl/support](http://www.palmOne.com/intl/support).

PN: 406-10389-05

# Table of Contents

<b>About This Guide</b> .....	<b>vii</b>
Tips for viewing this guide.....	vii
What's in this guide? .....	viii
Sidebars.....	ix
<b>Chapter 1: Your Handheld</b> .....	<b>1</b>
What's on my handheld? .....	2
What's on the CD? .....	7
Opening applications.....	10
Using the 5-way navigator .....	12
Entering information .....	17
Using menus .....	22
Handheld do's and don'ts .....	23
Beyond the basics.....	24
<b>Chapter 2: Synchronizing Your Handheld with Your Computer</b> .....	<b>25</b>
Why synchronize information?.....	26
What information is synchronized?.....	27
How to synchronize .....	28
Using Quick Install and the Send To Handheld droplet .....	29
Beyond the basics.....	31
<b>Chapter 3: Managing Your Contacts</b> .....	<b>32</b>
Adding a contact.....	33
Locating a contact on your list.....	35
Beaming a contact .....	36
Beyond the basics.....	37

<b>Chapter 4: Managing Your Calendar .....</b>	<b>38</b>
Scheduling an appointment.....	39
Checking your schedule .....	41
Setting an alarm.....	42
Beyond the basics.....	43
<b>Chapter 5: Managing Your Office Files.....</b>	<b>44</b>
Creating and managing Office files? .....	45
Opening files from within Documents .....	46
Beyond the basics.....	47
<b>Chapter 6: Viewing Photos and Videos.....</b>	<b>48</b>
Supported file types .....	49
Viewing photos or videos .....	50
Organizing photos or videos into albums .....	51
Sending a photo or video using Bluetooth technology.....	53
Beyond the basics.....	54
<b>Chapter 7: Listening to Music.....</b>	<b>55</b>
Transferring MP3 files to an expansion card.....	56
Transferring music from a CD to an expansion card .....	59
Playing music on your handheld.....	64
Beyond the basics.....	65
<b>Chapter 8: Managing Your Tasks .....</b>	<b>66</b>
Creating a task.....	67
Organizing your tasks.....	68
Marking a task complete .....	69
Beyond the basics.....	70
<b>Chapter 9: Writing Memos.....</b>	<b>71</b>
Creating a memo .....	72
Viewing and editing a memo .....	73
Beyond the basics.....	74

<b>Chapter 10: Writing Notes in Note Pad.....</b>	<b>75</b>
Creating a note.....	76
Viewing and editing a note .....	77
Beyond the basics.....	78
<b>Chapter 11: Making Wireless Connections .....</b>	<b>79</b>
What can I do with the built-in Bluetooth wireless technology? .....	80
What types of connections can I make?.....	80
Entering basic Bluetooth settings.....	81
Setting up a phone connection.....	82
Accessing email and the web wirelessly .....	86
Setting up a connection for wireless synchronization.....	88
Beyond the basics.....	92
<b>Chapter 12: Sending and Receiving Text Messages .....</b>	<b>93</b>
Sending a text message .....	94
Viewing a text message .....	95
Beyond the basics.....	96
<b>Chapter 13: Browsing the Web.....</b>	<b>97</b>
Accessing a web page .....	98
Beyond the basics.....	99
<b>Chapter 14: Sending and Receiving Email Messages .....</b>	<b>100</b>
Setting up an account.....	101
Getting and reading email .....	104
Sending an email message.....	105
Working with attachments .....	106
Beyond the basics.....	109
<b>Chapter 15: Expanding Your Handheld.....</b>	<b>110</b>
What type of expansion cards can I use? .....	111
How can expansion cards help me?.....	111
Removing an expansion card .....	112

Inserting an expansion card.....	113
Beyond the basics.....	114
<b>Chapter 16: Customizing Your Handheld .....</b>	<b>115</b>
Setting the date and time.....	116
Preventing your handheld from turning on by accident .....	118
Changing the screen fonts .....	119
Changing the background of your screen .....	121
Correcting problems with tapping .....	122
Selecting sound settings.....	123
Changing entries in Favorites .....	124
Beyond the basics.....	125
<b>Chapter 17: Common Questions .....</b>	<b>126</b>
Beyond the basics.....	131
<b>Product Regulatory Information .....</b>	<b>132</b>
<b>Index .....</b>	<b>138</b>

# About This Guide





This guide tells you everything you need to know to start using your handheld—from the things you'll do every day, to the things that make your handheld not only useful, but fun.

## Tips for viewing this guide

Here are some helpful tips for making it easier to read and find information in this guide as you view it in Adobe Reader:

### [ ! ] Before You Begin

Complete the steps in *Read This First* in your handheld package to set up your handheld and install the software on your computer and your handheld.

- To magnify the page, click the magnifying glass , move the cursor (which is now a magnifying glass) over the page, and click repeatedly. Click Previous View ( or  depending on your version of Reader) to return to the original view.
- Click an entry in the Table of Contents or Index to go directly to that section of the guide.
- If you link to a page in the guide, to return to the page you were on before you clicked the link, click Previous View ( or  depending on your version of Reader).
- When selecting the page(s) to print, be sure to use the file page number shown at the bottom of your computer screen, not the printed page number. For example, to print the page you are reading right now, select page 7 (the file page), not page vii (the printed page).

## What's in this guide?

The info in this guide includes step-by-step instructions, links to cross-references, and sidebars.

### Step-by-step instructions

Here you'll find how-to information. Look for these cues in instructions:

 **Continued**

Cue that means the procedure continues on the next page.

 **Done**

Cue that signals the end of the procedure. You're done.

 **IMPORTANT**

A step that you must follow; otherwise, you could experience an error or even lose information.

 **OPTIONAL**

A step you might find useful.

 **NOTE**

Information that applies only in certain cases or that tells more about a procedure step.

**WINDOWS ONLY**

A procedure or text that applies to one platform only. In most cases, if you see one heading, check the following or preceding sections for the other. Sometimes, there is no Mac counterpart for a Windows procedure or text—this feature is not available to Mac users.

**MAC ONLY**



## Sidebars

\* **Tip**  
To access the *User Guide*, you need to be connected to the Internet.

[ ! ] **Before You Begin**

Things you must complete before you can do the steps described in a procedure or group of procedures.

\* **Tip**

A suggestion on how to use a feature more fully; a shortcut; a pointer to a related feature.

+ **Did You Know?**

An interesting fact about the topic being described; may include a link to more information.

» **Key Term**

A technical term related to the topic being described. The term may appear in this guide or only on your handheld.

**User Guide**

A pointer to the *User Guide* on the web where you can learn about more things you can do with an application or feature.

**Support**

A pointer to the web where you can find help if you experience problems with the features discussed in the chapter or with your handheld.

# Your Handheld

## In this chapter

[What's on my handheld?](#)

[What software is on my handheld?](#)

[What's on the CD?](#)

[Opening applications](#)

[Using the 5-way navigator](#)

[Entering information](#)

[Using menus](#)

[Handheld do's and don'ts](#)

[Beyond the basics](#)

Like a good personal assistant, your handheld helps you keep track of your schedule, your business and personal contacts, your to-do list, even your Microsoft Office and multimedia files.

Stay productive by carrying more of your important files and documents. Get connected with wireless access to email, text messages, and the web. View digital photo and video albums directly on your handheld, or insert an expansion card (sold separately) to listen to your favorite music. And don't worry about losing your information—even if the battery drains completely, the information stays in your handheld's memory. Simply recharge to access it again.



## Benefits

- Carry more of your important information, and work with it on the go
- Save time and stay organized
- Travel light
- Never lose important information
- Stay in touch with wireless connectivity

## What's on my handheld?

### Front

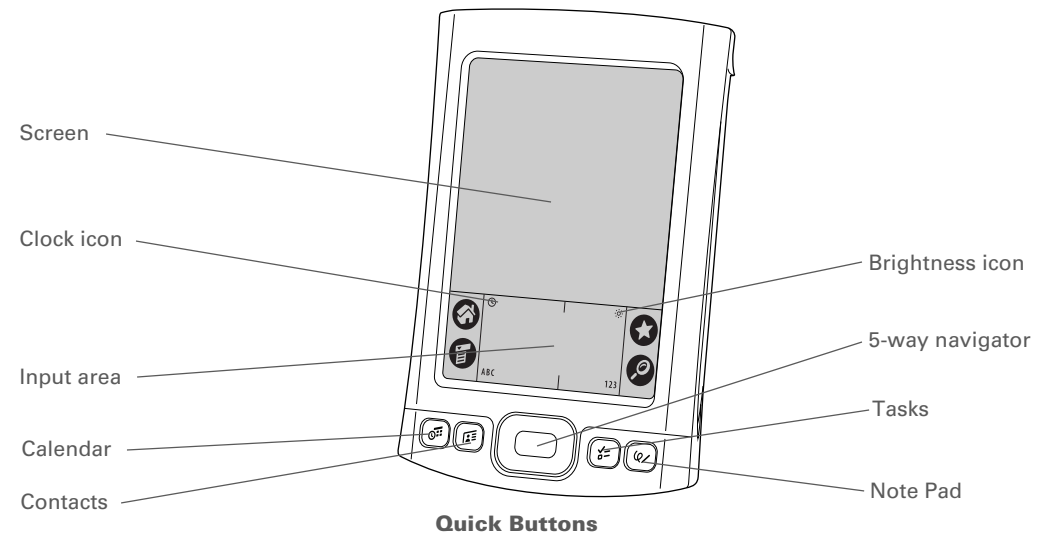

#### Screen

Displays the applications and information on your handheld. The screen is touch-sensitive.

#### Clock icon

Displays the current time and date.

#### Input area

Lets you enter info with **Graffiti® 2 writing** or open the **onscreen keyboard**.

#### Brightness icon

Lets you adjust the brightness of your handheld's display.

#### 5-way navigator

Helps you move around and select info to display on the screen.

#### Quick buttons

Turn on your handheld and open Calendar, Contacts, Tasks, and Note Pad.

» **Key Term**  
**IR** Short for *infrared*.  
 Beaming uses infrared technology to send information between two IR ports that are within a few feet of each other.

+ **Did You Know?**  
 Beaming lets you quickly share appointments, addresses, phone numbers, and more.

## Top and side

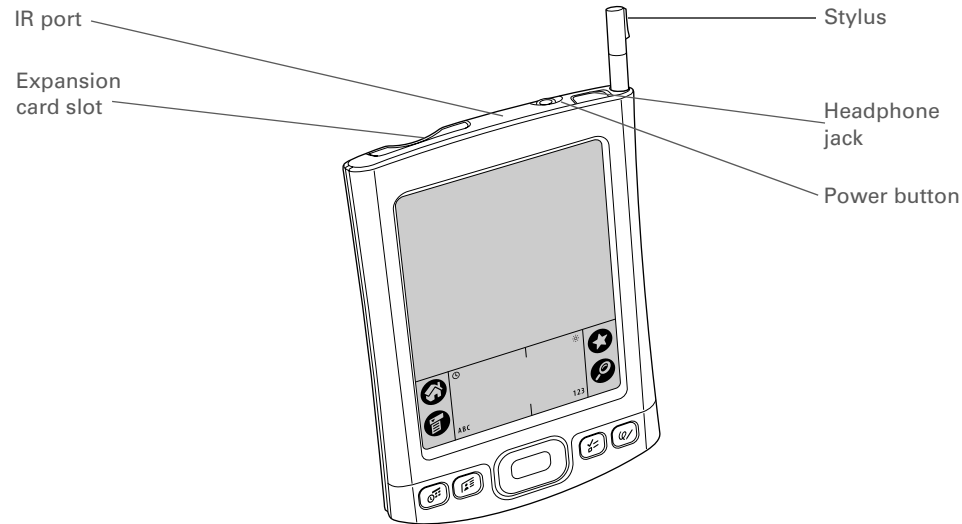

### IR port

**Beams information** between handhelds and other devices that have an IR port.

### Expansion card slot

Lets you insert an expansion card (sold separately) to play music, back up info, and add memory, applications, and accessories to your handheld.

### Power button

Turns your handheld on or off and lets you turn **Keylock** on (if active).

### Headphone jack

Lets you connect standard 3.5 mm headphones (sold separately) to your handheld so you can listen to music and other audio applications.

### Stylus

Lets you enter information on your handheld. To use the stylus, slide it out of the slot and hold it as you would a pen or pencil. Using your fingertip instead of the stylus is OK, but don't use your fingernail, a real pen, or any other sharp object to touch the screen.

## » Key Term

**USB** The type of connector or cable that's commonly used to connect accessories to a computer.

## Back

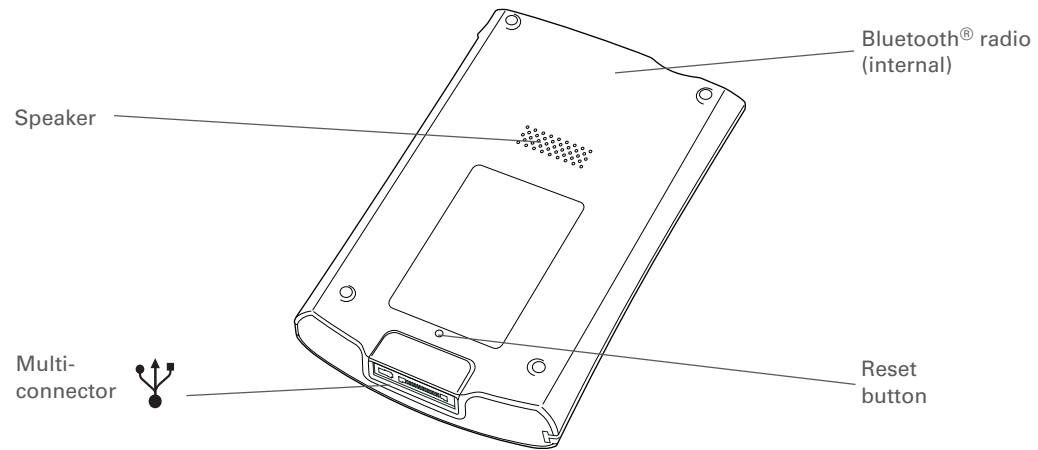
**Speaker**

Lets you listen to alarms, game and system sounds, and music.

**Reset button**

**Resets your handheld** if it freezes (stops responding).

**Multi-connector**

Lets you connect a sync cable (included) or a cradle (sold separately) to your computer so you can **synchronize** or exchange information. Also lets you connect the AC charger to your handheld so you can charge it.

**Bluetooth radio (internal)**











Enables your handheld to connect with other devices (sold separately) that use **Bluetooth wireless technology**.







**\* Tip**

Can't find some of these applications? Tap the category list in the upper-right corner of the Home screen and select All.

## What software is on my handheld?

Your handheld comes with many applications preinstalled and ready to use.

- |  |  |
|--|--|
|  <b>Favorites</b>       | Customize a list of your favorite applications and web pages so that you can locate and open them quickly.   |
|  <b>Calendar</b>        | Manage your schedule from single entries, like lunch with a friend, to repeating and extended events, like weekly meetings and holidays. Even color-code your schedule by category.  |
|  <b>Contacts</b>        | Store names and addresses, phone numbers, email and website addresses—even add a birthday alarm or a contact's photo.  |
|  <b>Documents To Go</b> | Create, view, and edit Microsoft Word and Excel files, and view and manage PowerPoint files, directly on your handheld. Includes companion desktop software that lets you move or copy Microsoft Word, Excel, and PowerPoint files to your handheld, as well as create and edit files. |
|  <b>Media</b>           | View and organize photos and videos.   |
|  <b>Bluetooth®</b>      | Set up wireless connections to a mobile phone, network, or computer for sending and receiving information.   |
|  <b>SMS</b>           | Send and receive short text (SMS) messages using the built-in Bluetooth wireless technology on your handheld.  |
|  <b>Web</b>           | Browse your favorite sites on the web using the built-in Bluetooth technology on your handheld.  |
|  <b>Tasks</b>         | Stay on top of your to-do list. Enter things you need to do, prioritize them, set alarms, and then monitor your deadlines.   |
|  <b>Memos</b>         | Capture information such as meeting notes, lists of books to read, movies to see, recipes, and anything else you need to write down.   |
|  <b>Note Pad</b>      | Write on the screen in your own handwriting or draw a quick sketch.  |

-  **Calculator** Solve basic math calculations such as splitting restaurant bills and figuring tips.
-  **Quick Tour** Learn about your handheld and how to enter information.
-  **Expense** Track business or travel expenses and print expense reports after you synchronize with your computer.
-  **HotSync®** Synchronize the info on your handheld with the info on your computer.
-  **Prefs** Customize your handheld's sound levels, colors, security, and more.
-  **Card Info** View information about an expansion card seated in the expansion card slot.
-  **World Clock** Set the time in your home city and two other locations, and set an alarm to wake you up.

**\* Tip**

To install extra software from the CD, insert the CD into your CD drive, and then do one of the following:

**Windows:** On the Discover your device screen, click Add software to your device.

**Mac:** Double-click the Essential Software folder icon.

## What's on the CD?

The Tungsten™ E2 software installation CD includes desktop software for your computer and additional software for your handheld.

The desktop software lets you use your computer to view, enter, and manage info for many of the applications on your handheld. Make sure you install the desktop software so that you can back up and save the info on your handheld onto your computer.

The additional software lets you do more things with your handheld. When you set up your handheld you may install some (or all) of these applications. You can install any of the applications at any time after you set up your handheld as well.

The software installation CD includes titles such as the following:



### Palm Desktop software

View, enter, manage, and back up info for Calendar, Contacts, Tasks, Media, Memos, and Expense on your computer. (Expense and Media are Windows only.) You can also view, manage, and back up info for Note Pad. When you **synchronize your handheld with your computer**, this info is updated in both places. This application installs automatically during the initial CD installation process.

**NOTE** During CD installation, you can choose to synchronize your handheld with Microsoft Outlook on your computer. (Windows only.) If you do, information from Contacts, Calendar, Tasks, and Memos is synchronized with Outlook. Information for Expense, Note Pad, and Media is still synchronized with Palm Desktop software.



### palmOne™ Quick Install (Windows only)

Install applications and transfer files from your Windows computer to your handheld or to an expansion card that is seated in the expansion card slot for use on your handheld. This application installs automatically when you synchronize during the initial CD installation process.



\* **Tip**

After you install an app and discover how valuable it is, be sure to add it to **Favorites**.

+ **Did You Know?**

You can categorize applications. Some apps are automatically assigned to a category when you install them; others are assigned to the Unfiled category. All apps appear in the All category of **Applications**. Assign an application to a category in Applications by selecting Category in the App menu. Select the pick list next to the application's name; then select a category

**Send To Handheld droplet (Mac only)**

Install applications and transfer files from your Mac computer to your handheld or to an expansion card that is seated in the expansion card slot for use on your handheld. This application installs automatically when you synchronize during the initial CD installation process.

**VersaMail®**

Send, receive, and manage email messages wirelessly using the built-in Bluetooth technology on your handheld or by synchronizing with your Windows computer.

**AudiblePlayer**

Listen to newspapers, books, public radio, language instruction, and more. (Windows only; download requires Internet connection, additional fees may apply.)

**RealPlayer desktop application**

Transfer MP3 music files from your computer to an expansion card (sold separately), copy music from your CDs to your computer. Carry music on expansion cards (sold separately), create playlists, and listen to music on your handheld. This application has a companion desktop application that you can install from the CD. (Windows only.) Both Mac and Windows users can use RealPlayer on the handheld.

**Windows Media Player/Direct X**

Work with the palmOne Media desktop application. These applications are required for Media to prepare videos for playback on your handheld. (Windows only.)

**QuickTime**

Works with the palmOne Media desktop application. Required to prepare videos in certain formats for viewing on your handheld.

**NOTE** QuickTime is included on the CD for Windows computers only. For Mac computers, QuickTime is included in OS X.

**Getting Started Guide**

Keep the Getting Started Guide with you and view it on your handheld. You can also install this file on your handheld to carry it with you on the go; it installs to the Palm Desktop Help automatically during the initial CD installation process;

**Java Technologies**

Access more software and functions when you download WebSphere Micro Environment to run Java (J2ME) on your handheld. (Download requires Internet connection and valid email address.)

**Handmark Solitaire**

Enjoy hours of entertainment with this solitaire game.

**powerOne Calculator**

Calculate math and business solutions with this enhanced calculator.

**Addit™**

Preview, try, and buy software for your handheld. (Windows only and web access required.)

**Adobe Reader  
for Palm OS**

View PDF files that are tailored to fit your handheld's screen.

**Power by Hand eReader**

Purchase and download eBooks from the web so you can read them when you want, where you want.

**VPN Client Software**

Purchase and download VPN software to create a secure wireless connection to your corporate network in order to safely send and receive email messages, access the corporate intranet, and more. (Download requires Internet connection; additional fees apply.)

**Tutorial**

Learn to use the popular features of your handheld. The Tutorial includes a tour of your handheld and step-by-step instructions. Access it from the CD.

- + **Did You Know?**  
 You can use a favorite photo as the background for your Favorites or Applications View.

## Opening applications

Your handheld lets you display two views to quickly see and open applications. Favorites lets you create a list of the items you want to quickly access, while Applications displays all applications on your handheld.

### Using Favorites

The Favorites View can include applications and links to the web. Certain items are included in Favorites by default, but you can customize the list to contain any items you want.

To access an item from Favorites, tap Star  and select from the list. Use the 5-way navigator or tap the buttons in the upper-right corner of the screen to move to another page of favorites.

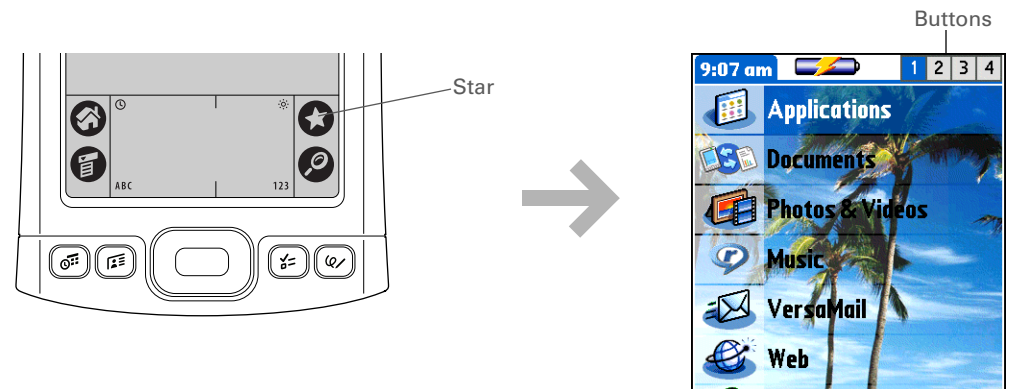

+ **Did You Know?**  
You can also open applications using the **quick buttons** on the front of your handheld.

\* **Tip**  
Press Center on the 5-way to scroll through application categories.

\* **Tip**  
From most applications you can return to Applications by holding down Center on the 5-way.

## Using Applications

The Applications View shows all of the applications on your handheld. Use the category pick list in the upper-right corner of the screen to view applications by category or to see all applications.

To access an item from Applications, tap Home  and select an icon.

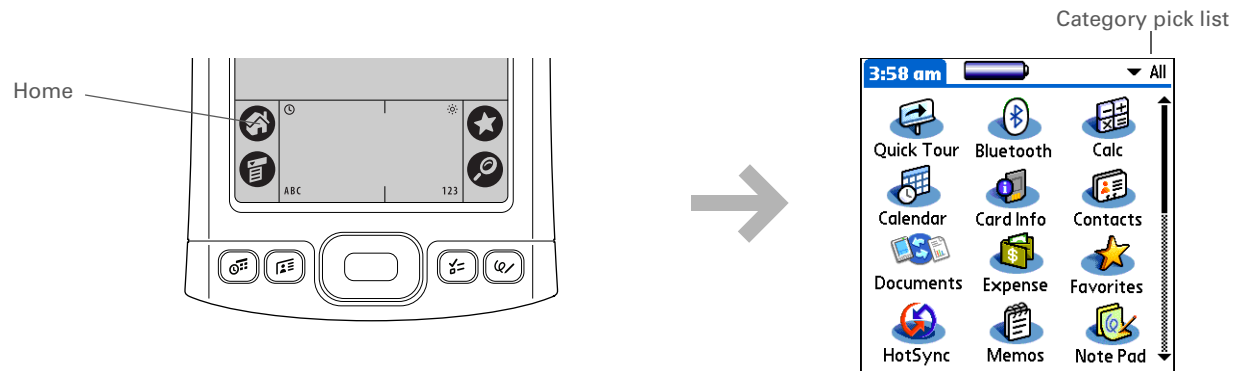

\* **Tip**

To remove the selection highlight without making a selection, scroll to the first icon (in the upper-left corner) and then press Left on the 5-way, or enter the Backspace character using **Graffiti 2 writing**.

## Using the 5-way navigator

The 5-way navigator lets you access information quickly with one hand and without the stylus. The 5-way does various things based on which type of screen you're on. To use the 5-way, press Up, Down, Right, Left, or Center.

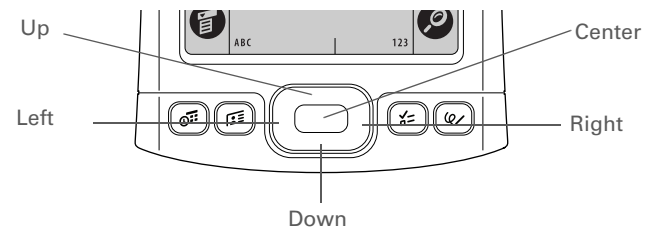

## Moving around in Favorites View

- |                      |  |
|----------------------|--|
| <b>Right or Left</b> | Displays the next or previous page of favorites.             |
| <b>Up or Down</b>    | Scrolls to the next favorite in the corresponding direction. |
| <b>Center</b>        | Opens the selected item.                                     |

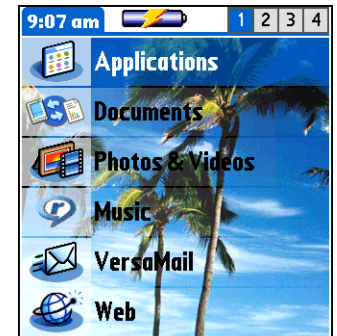

## Moving around in Applications View

- Up or Down** Scrolls to the next or previous page of applications.
- Right or Left** Scrolls to the next or previous application category.
- Center** Inserts the selection highlight. When the selection highlight is present:
- Up, Down, Right, or Left** Scrolls to the next item in the corresponding direction.
- Center** Opens the selected item.

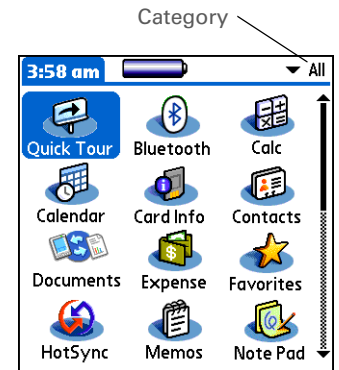

## Moving around list screens

In list screens, select and move between entries such as notes, memos, contacts, or photos.

- Up or Down** Scrolls an entire screen of entries, as long as there's nothing highlighted. Press and hold to accelerate the scrolling.
- Center** Inserts the selection highlight. When the selection highlight is present:
- Up or Down** Scrolls to the previous or next entry.
- Center** Displays the selected entry.
- Left** Removes the selection highlight.



## Moving around entry screens

In entry screens, use the 5-way to scroll within the current entry or between entries.

### Up, Down, Right, or Left

Scrolls to the next item in the corresponding direction.

If there is no “up” entry, pressing Up scrolls left. Likewise if there is no “left” entry, pressing Left scrolls up.

If there is no “down” entry, pressing Down scrolls right. If there is no “right” entry, pressing Right scrolls down.

On some entry screens, pressing Left highlights the leftmost button at the bottom of the screen.

### Center

Inserts or removes the selection highlight.

If a button is highlighted, activates the button.

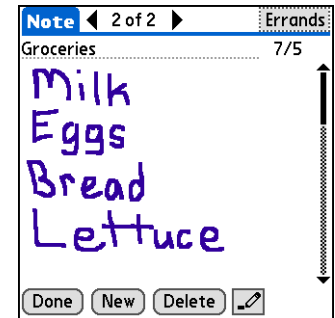

## Moving around dialog boxes

Dialog boxes appear when you select a button or option that requires you to provide additional information. In dialog boxes, use the 5-way to select a button or to make a selection from items such as boxes and pick lists.

### Up, Down, Right, or Left

Highlights the next item in the dialog box (pick list, box, button) in the corresponding direction.

### Center

- If highlight is on a box: Checks or unchecks the box.
- If highlight is on a pick list: Opens the pick list. When a pick list is open:

**Up or Down** Scrolls to the previous or next entry.

**Center** Selects the highlighted entry.

- If highlight is on a button: Activates the button, and then closes the dialog box.

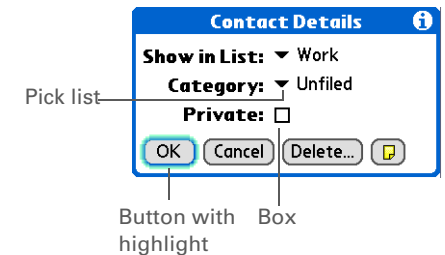

**[ ! ] IMPORTANT** Read dialog boxes carefully. Selecting a button such as OK or Yes may cancel an action or delete information.



## Moving around menus

After you **open the menus** you can use the 5-way to move between and to select menu items:

- |                      |   |
|----------------------|---|
| <b>Up or Down</b>    | Scrolls within the current menu list.                 |
| <b>Right or Left</b> | Scrolls to the next or previous menu on the menu bar. |
| <b>Center</b>        | Selects the highlighted menu item.                    |

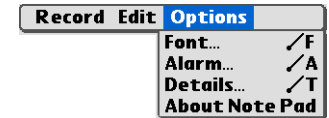

\* **Tip**  
Write letters on the left side of the input area and numbers on the right. Write capital letters in the center.

+ **Did You Know?**  
Your handheld package includes a sticker that shows the most common Graffiti 2 characters.

\* **Tip**  
Display the Graffiti 2 help screens at any time. Just draw a single stroke from the bottom of the input area to the top of your handheld's screen.



## Entering information

There are several ways to enter information on your handheld. The most popular methods are using Graffiti 2 writing, using the onscreen keyboard, and using Palm Desktop software or Microsoft Outlook on a computer. The next few pages briefly describe these three methods.

### Learning Graffiti 2 writing

Graffiti 2 writing is a special set of letters, numbers, and symbols that you can use to write directly on the screen. With only a few minutes of practice, you can learn to use Graffiti 2 writing—and help is always only a tap away.

**1**

Tap Home  and select Quick Tour .

**2**

Select Graffiti 2, and then navigate through the screens to learn Graffiti 2 writing.

↓ Done

» **Key Term**  
**Record** An entry in an application such as a contact in Contacts or an appointment in Calendar.

\* **Tip**  
You can enter text whenever you see a blinking cursor on the screen.

## Using the onscreen keyboard

You can use the onscreen keyboard in any application where you need to enter text, numbers, or symbols on your handheld.

**1**

Open an entry:

- a. **Open an application.**
- b. Select a record or tap New.

**2**

Tap one of the following to open an onscreen keyboard:

**ABC** Opens the letter keyboard.

**123** Opens the number keyboard.

↘ **Continued**



Letter keyboard

Number keyboard

\* **Tip**  
 When a keyboard is open, you can tap **abc**, **123**, or **Int'l** to open any of the other keyboards.

**3**

Tap the characters to enter text, numbers, and symbols, and then select Done.

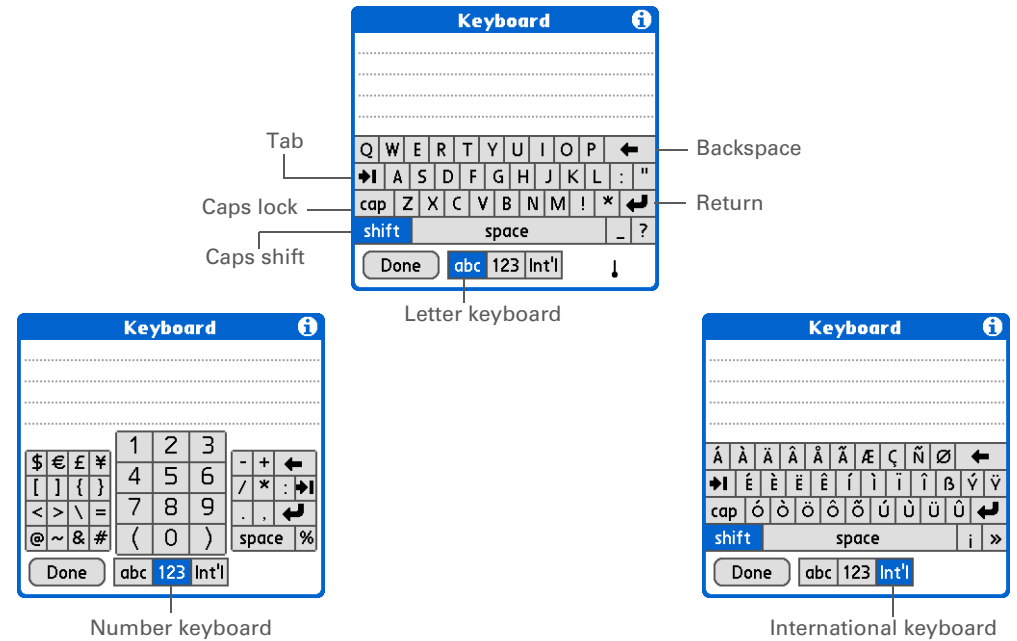

↓ Done

\* **Tip**  
 The Palm Desktop online Help has lots of info about how to use Palm Desktop software. Open the Help menu and select Palm Desktop Help.

## Using your computer

Many of the applications on your handheld are also included in Palm Desktop software. You can use these applications to enter information on your computer. When you **synchronize your handheld with your computer**, the information is updated in both places.

**NOTE** During CD installation (Windows only), you can choose to synchronize with Microsoft Outlook. If you do, info from Contacts, Calendar, Tasks, and Memos is synchronized with Outlook. Other info, such as photos and notes, is synchronized with Palm Desktop software.

### WINDOWS ONLY

Double-click the Palm Desktop icon on your computer desktop, and then click the icons in the launch bar to access the various applications.



Launch bar

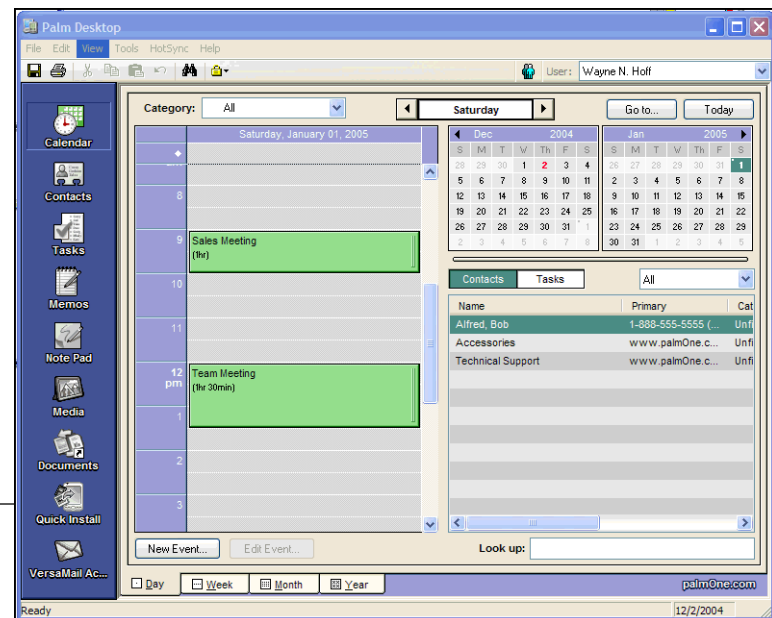

**MAC ONLY**

Double-click the Palm Desktop icon in the Palm folder on your computer, and then click the icons in the launch bar to access the various applications.

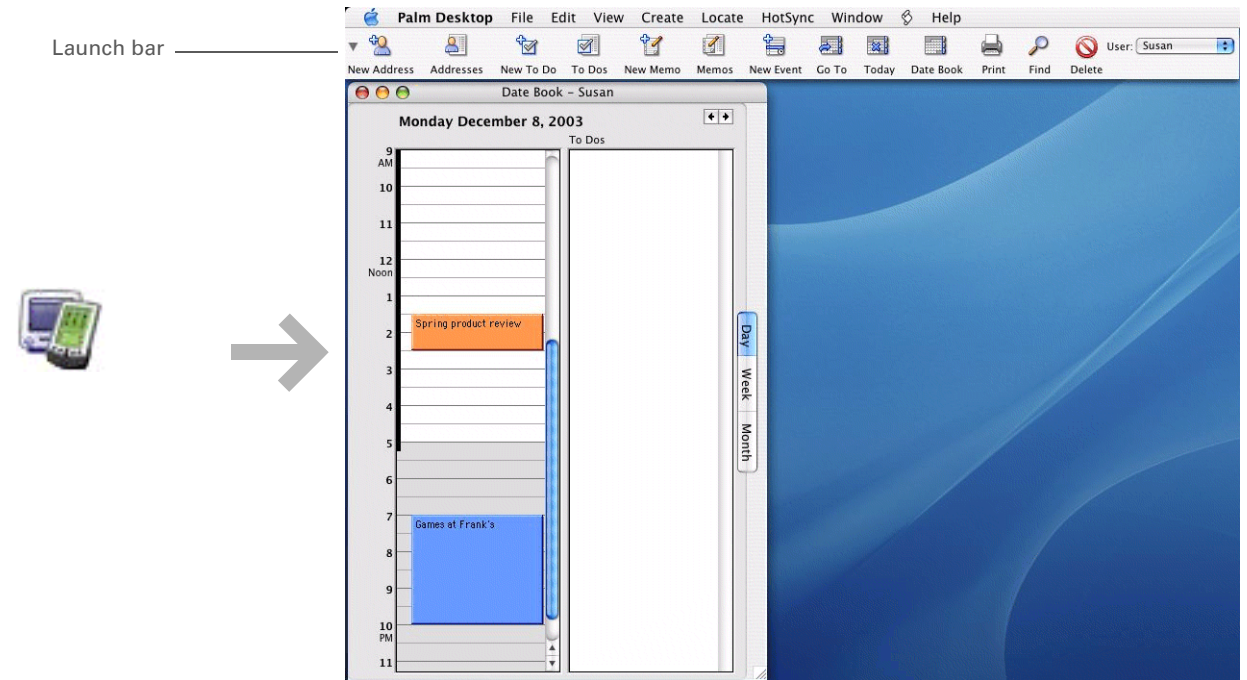

## Using menus

Menus let you access additional commands and settings. They are easy to use, and once you master them in one application, you know how to use them in all your applications.

\* **Tip**  
You can also open the handheld menus by tapping the application title in the upper-left corner of the screen.

\* **Tip**  
When the menus are open, you can use the 5-way to select menus and menu items.

- 1** **Open an application.**
- 2** Tap Menu  to open the menus.

Application title

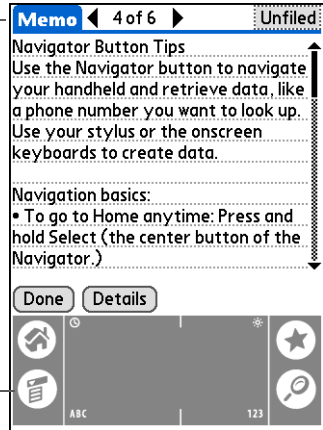

Menu icon

Menu

Menu item

- 3** Tap a menu, and then tap a menu item.

 Done

**+ Did You Know?**

Your handheld saves information in storage memory permanently. Even if the battery drains completely, none of your information is lost. Simply recharge to access the information again.

## Handheld do's and don'ts

To protect your handheld from damage and ensure reliable performance, follow these guidelines.

### Handheld do's

- Use only the stylus to tap the screen—no pens, pencils, paper clips, or other sharp objects.
- Use only the supplied power adapter to charge your handheld.
- **Keep the battery charged.**
- Keep the screen free of dust (or anything else that could make it dirty).
- For general cleaning, use a soft, damp cloth. If the screen becomes dirty, use a soft cloth moistened with a diluted window-cleaning solution.
- Use only 3.5 mm stereo headphones in your handheld's headphone jack.
- Be sure to **get rid of any static electricity buildup** before you connect your handheld to any cable or accessory.

### Handheld don'ts

- Do not drop, bang, or otherwise cause a strong impact to your handheld.
- Do not carry your handheld in your back pocket; you might sit on it by mistake.
- Do not let your handheld get wet; don't even leave it in a damp location.
- Do not expose your handheld to very hot or cold temperatures, including placing it near a heater, leaving it in the trunk of a car, or setting it by a window in direct sunlight.



**User Guide**

For everything you need to know about your handheld—all that's in this guide, and much more—go to [www.palmOne.com/tungstene2-handbook](http://www.palmOne.com/tungstene2-handbook).

**Support**

If you're having problems with your handheld, go to [www.palmOne.com/intl/support](http://www.palmOne.com/intl/support).

## Beyond the basics

Go to the *User Guide* on the web and learn about these related topics:

**Entering Information**

Entering information with Graffiti 2 characters

**Installing and Removing**

- Adding applications to your handheld
- Deleting applications from your handheld
- Viewing application information

**Categories**

Organizing your applications and information by filing them into categories

**Privacy**

Keeping information private by turning on security options

**Sharing**

- Beaming information and applications to other Palm Powered™ devices
- Sending information and applications to other Bluetooth devices by using Bluetooth technology on your handheld

**Maintaining**

Caring for your handheld

# Synchronizing Your Handheld with Your Computer

## In this chapter

[Why synchronize information?](#)

[What information is synchronized?](#)

[How to synchronize](#)

[Using Quick Install and the Send To Handheld droplet](#)

[Beyond the basics](#)

You can use handheld on its own only to look up phone numbers, enter appointments, and so on. But you can do much more with your handheld if you synchronize it with your computer.

Synchronizing simply means that information that has been entered or updated in one place (your handheld or your computer) is automatically updated in the other. There's no need to enter information twice.



## Benefits

- Quickly enter and update information on your computer and your handheld
- Install applications
- Protect your information
- Send photos and videos to your handheld from your desktop computer

\* **Tip**  
Synchronize Microsoft Word, PowerPoint, or Excel files from your computer and open them in the **Documents** application on your handheld to view and edit them at your convenience.

## Why synchronize information?

**Quickly enter and update information on your computer and handheld.** Synchronizing updates information both on your handheld and in **Palm® Desktop** software on your computer. For example, you can quickly enter a contact list on your computer and then send it to your handheld instead of re-entering the information.

**NOTE** During CD installation, you can choose to **synchronize your handheld with Microsoft Outlook** on your computer (Windows only).

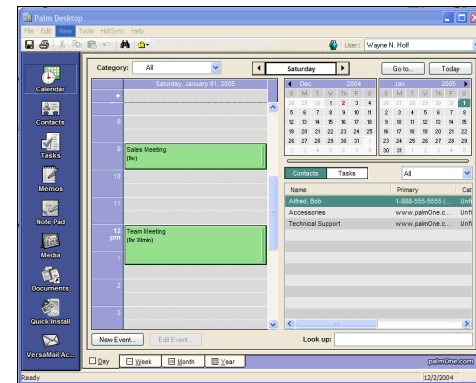
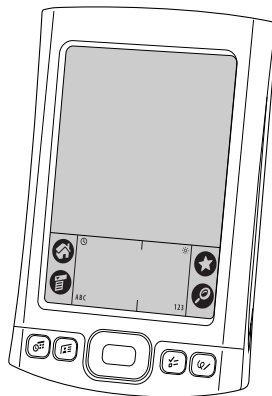

**Install applications.** With just a few clicks, you can use **palmOne™ Quick Install** to add files to certain applications on your handheld or to install additional software.

**Protect your information.** Nothing is worse than losing important information. When you synchronize information, you create a backup copy. If something happens to your handheld or your computer, the information is not lost; one tap restores it in both places.

**[ ! ] IMPORTANT** Be sure to synchronize information at least once a day so that you always have an up-to-date backup copy of important information.

**[ ! ] Before You Begin**

Complete the following:

- Perform initial handheld setup.
- Install Palm Desktop software and additional software from the CD.

For setup and installation procedures, see *Read This First* included in your handheld package.

**» Key Term**

**Conduit** The synchronization software that links an application on your computer with the same application on your handheld.

**\* Tip**

You can synchronize your handheld with your computer wirelessly using the built-in Bluetooth® technology on your handheld.

## What information is synchronized?

If you use the preset settings, information from all the following applications is transferred between your handheld and Palm Desktop software each time you synchronize your handheld with your computer:



**NOTE** Information from Expense is synchronized on Windows computers only.

In addition, the preset settings back up system information from your handheld to your computer and install add-on applications from your computer to your handheld.

If you've installed applications from the CD, these applications may also be included in the presets for synchronization.

If you want to synchronize applications other than the ones using the preset settings, see the *User Guide* on the web.

During CD installation, you can choose to synchronize your handheld with Microsoft Outlook on your computer (Windows only). If you do, information from Contacts, Calendar, Tasks, and Memos is synchronized with Outlook. Information for Expense, Note Pad, and Media is still synchronized with Palm Desktop software. You can insert the CD at any time to choose synchronization with Outlook if you did not do so during the initial installation.

**NOTE** You can also set up the VersaMail® application to synchronize with Outlook.

You can synchronize more than one handheld with your computer. For example, family members can synchronize their handhelds with the same copy of Palm Desktop software. Just make sure that each handheld has its own username; Palm Desktop software reads the username and recognizes the handheld during synchronization. Loss of data may occur from sharing the same user name.

## How to synchronize

» **Key Term**  
**HotSync®** Technology that allows you to synchronize the information on your handheld with the information on your computer.

\* **Tip**  
If the Select User dialog box appears during synchronization, select the username whose information you want to synchronize, and then click OK.

\* **Tip**  
If you need help with synchronizing, see [What do I do if I can't synchronize with my computer?](#)

**1**

Connect the USB sync cable to the USB port on your computer, and then insert the other end into your handheld.

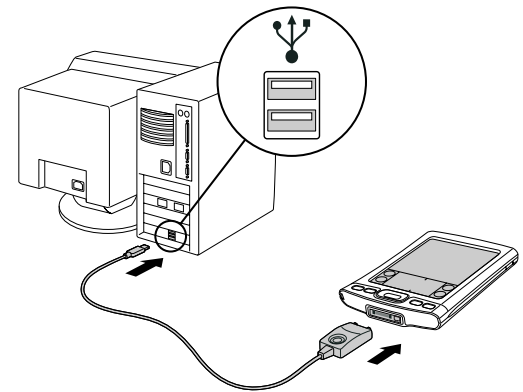
**2**

Synchronize your handheld with your computer:

- Press the sync button on the USB sync cable.
- When synchronization is complete, a message appears at the top of your handheld screen, and you can disconnect your handheld from the connector.

↓ Done

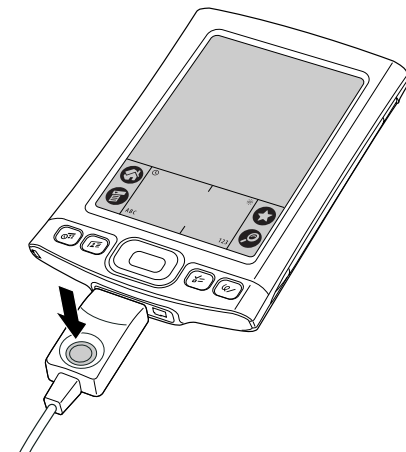

## Using Quick Install and the Send To Handheld droplet

Use Quick Install (Windows) or the Send To Handheld droplet (Mac) to install applications on your handheld.

### Using Quick Install

#### WINDOWS ONLY

#### \* Tip

A confirmation dialog box shows whether the items will be copied to your handheld or to an expansion card. You can choose which handheld will receive the items by selecting the username in the User drop-down box in the upper-right corner.

#### + Did You Know?

You can move multiple applications into the Quick Install window to have them ready for installation the next time you synchronize.

**1**

Click the Quick Install icon on your desktop.

**2**

Copy the application:

- a. Drag and drop the application onto the Quick Install window.
- b. When the confirmation dialog box appears, confirm your username, the application name, and the destination, and then click OK.

**3**

**Synchronize to install the file to your handheld.**

↓ Done

## Using the Send To Handheld droplet

MAC ONLY

\* **Tip**

In Mac OS X, you can make the Send To Handheld droplet a permanent part of your desktop by dragging the droplet to the Dock. Then simply drag photos, and other files you want to transfer to your handheld, onto the Dock.

**1**

Select the applications or files you want to install:

- a. Drag and drop the applications or files onto the Send To Handheld droplet in the Palm folder.
- b. In the Send To Handheld dialog box, select your username and click OK.



**2**

**Synchronize your computer with your handheld.**

↓ Done

**User Guide**

For everything you need to know about your handheld—all that's in this guide, and much more—go to [www.palmOne.com/tungstene2-handbook](http://www.palmOne.com/tungstene2-handbook).

**Support**

If you're having problems with synchronization or with anything else on your handheld, go to [www.palmOne.com/intl/support](http://www.palmOne.com/intl/support).

## Beyond the basics

Go to the *User Guide* on the web and learn about these related topics:

**Synchronizing**

- Synchronizing your handheld with Microsoft Outlook on your computer
- Synchronizing wirelessly using Bluetooth technology on your handheld
- Using your company's network to synchronize information
- Choosing whether to synchronize information for a specific application
- Switching back to the cable if you have been synchronizing information using Bluetooth technology
- Receiving information on your handheld from an outside source, such as a file containing your company's phone list

**Installing and Removing**

Using palmOne Quick Install to add applications to your handheld



# Managing Your Contacts

## In this chapter

### [Adding a contact](#)

### [Locating a contact on your list](#)

### [Beaming a contact](#)

### [Beyond the basics](#)

Say good-bye to a paper address book that you need to update manually every time someone moves, changes their email address, or gets a new work extension. With Contacts, not only is it easy to enter information such as names, addresses, and phone numbers, but it is just as quick to view, update, and organize contact information.

You can easily share info with other handhelds and dial phone numbers or send messages directly from a contact entry using your handheld's built-in Bluetooth<sup>®</sup> wireless technology and a compatible mobile phone, or by beaming. You can even add photos of your loved ones directly to their contact information screen.



## Benefits

- Carry all your business and personal contact information in your hand
- Keep track of who's who
- Keep in touch

## Adding a contact

### \* Tip

If the first character you enter in the Last Name or Company field is an asterisk (\*) or another symbol, that contact always appears at the top of the Contacts list. That's useful for an entry like "If Found Call [your phone number]."

### + Did You Know?

You can also enter one or more contacts on your desktop computer, and then copy them to your handheld by [synchronizing](#).

1

Press the Contacts  button.

2

Add your contact information:

a. Select New.

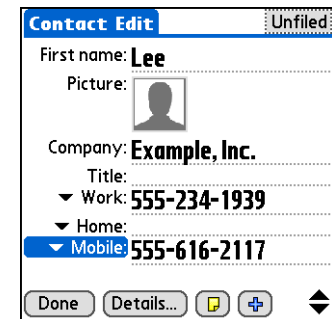
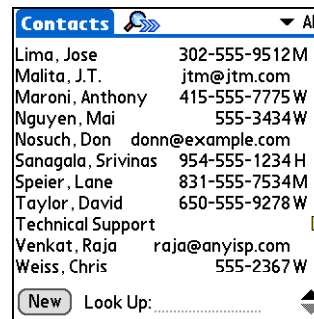

b. Tap each field in which you want to enter information, and enter it. Tap the scroll arrows  to view more fields.

↘ Continued

\* **Tip**  
If multiple contacts share information, such as a company name and address, you can enter the first contact and then **copy the information into other contacts**.

+ **Did You Know?**  
If you want a reminder about a birthday, select the Reminder box, enter the number of days before the birthday that you want to see the reminder, and then select OK.

\* **Tip**  
Birthdays you enter in Contacts appear as untimed events in Calendar. If you update the birthday in Contacts, it is automatically updated in Calendar as well.

3

[ & ] **OPTIONAL** Add a photo:

- Tap the Picture box.
- Select and add a photo from palmOne™ Media.

The screenshot shows the 'Contact Edit' screen with the following fields: First name: Lee; Picture: (empty box); Company: Example, Inc.; Title: (empty); Work: 555-234-1939; Home: (empty); Mobile: 555-616-2117. At the bottom are buttons for Done, Details..., a photo icon, a plus icon, and a dropdown arrow. A line points to the 'Picture' box with the text 'Tap here'.

4

[ & ] **OPTIONAL** Add a birthday:

- Tap the Birthday box.
- Select the birth year, month, and date.

The screenshot shows the 'Contact Edit' screen with the following fields: Addr(W): 4929 Rockaway Dr.; City: Anytown; State: CA; Zip Code: 90000; Country: (empty); Birthday: - Tap to add -; Custom 1: (empty). At the bottom are buttons for Done, Details..., a photo icon, a plus icon, and a dropdown arrow. A line points to the 'Birthday' field with the text 'Tap here'.

5

After you finish entering all the information you want, select Done.

↓ **Done**

That's it. Your handheld automatically saves the contact. Make sure you have a current backup. **Synchronize** often.



## Locating a contact on your list

### \* Tip

In the Contacts list view, you can also press Right on the 5-way navigator (or tap the Quick Look Up icon at the top of the screen) to open the Quick Look Up line. Press Up and Down to select the letter of the name you want in each box, and press Right to move to the next box.

### + Did You Know?

The **Phone Lookup** feature lets you add contact information directly into certain other applications on your handheld. For example, you can add a name and phone number to a memo or task.

<b>1</b>	Press the Contacts  button.
<b>2</b>	<p>Search for the contact:</p> <p>a. Tap the Look Up line at the bottom of the screen and enter the first letter of the name you want to find.</p> <p>b. Enter the second letter of the name, and so on, until you can easily scroll to the contact you want.</p>
<b>3</b>	<p>Select the contact to open it.</p> <p style="text-align: center;"> Done</p>



Quick Look Up icon

## Beaming a contact

\* **Tip**  
You can create a contact with your own information and select it as your business card by opening the Record menu and selecting Business Card. Beam your business card to other handhels by holding down the Contacts button until the Beam dialog box appears.

+ **Did You Know?**  
A Beam command appears on the left-most menu of most applications. Use it to beam information such as photos, appointments, and more.

\* **Tip**  
Does your mobile phone have an IR port? You can easily beam contact information from your handheld to your mobile phone.

1

Press the Contacts  button.

2

Beam the contact:

- a. **Locate the contact** you want to beam.
- b. **Open the menus** .
- c. Select Record, and then select Beam Contact.
- d. When the Beam Status dialog box appears, point your handheld's IR port directly at the IR port of the other handheld or mobile phone.



**NOTE** For best results, the devices should be between 4 and 36 inches apart, and there should be a clear path between them. Depending on the receiving handheld model, not all information may be sent correctly.

3

Wait for the Beam Status dialog box to indicate that beaming is complete.

↓ Done

**User Guide**

For everything you need to know about your handheld—all that's in this guide, and much more—go to [www.palmOne.com/tungstene2-handbook](http://www.palmOne.com/tungstene2-handbook).

**Support**

If you're having problems with Contacts or with anything else on your handheld, go to [www.palmOne.com/intl/support](http://www.palmOne.com/intl/support).

## Beyond the basics

Go to the *User Guide* on the web and learn about these related topics:

<b>Contacts</b>	<ul style="list-style-type: none"><li>• Deleting contacts</li><li>• Removing a photo from a contact</li><li>• Displaying additional contact fields and defining custom fields</li><li>• Choosing the field type for certain fields, such as Home or Work for a phone number</li><li>• Using Quick Connect to make a phone call, address and send an email or text message, or go to a web page directly from a contact</li></ul>
<b>Categories</b>	Organizing contacts by type and sorting them
<b>Information</b>	Transferring contact information from other applications such as databases, spreadsheets, and other organizer software
<b>Privacy</b>	Keeping contacts private by turning on security options
<b>Sharing</b>	Sending contacts to other Bluetooth devices by using Bluetooth technology on your handheld
<b>Email</b>	Sending contacts as attachments to email messages

# Managing Your Calendar

## In this chapter

[Scheduling an appointment](#)

[Checking your schedule](#)

[Setting an alarm](#)

[Beyond the basics](#)

Staying on top of your schedule is an important part of being productive both at work and at home. Calendar can help you remember appointments and spot schedule conflicts. You can view your calendar by day, week, or month, or as an agenda list that combines your list of tasks with your appointments. You can also brighten up your calendar by color-coding the categories.



## Benefits

- Track current, future, and past appointments
- Stay on top of deadlines
- Carry one calendar
- Spot schedule conflicts

## Scheduling an appointment

## » Key Term

**Event** The name for an entry in the Calendar application, including appointments, birthdays, reminders, recurring meetings, and so on.

## \* Tip



You can also scroll to a date by pressing Right or Left on the 5-way navigator or by tapping the arrows at the top of the Day View.

## + Did You Know?

You can use more than one line to describe an appointment.

1

Open Day View:

- Press the Calendar  button.
- Tap the Day View icon .

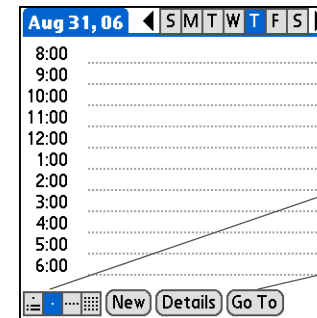

Day View icon

Go To

2

**[ & ] OPTIONAL** If the appointment is not for today, select the date of the appointment:

- Tap Go To.
- Select the year, month, and date.

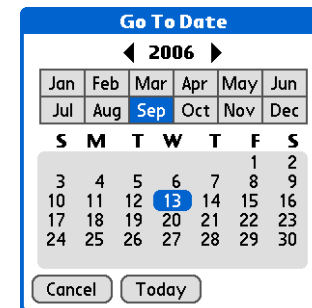

3

Tap the line next to the time the appointment begins and **enter a description**.

↘ Continued



- \* **Tip**  
To enter reminders, holidays, anniversaries, and other events that take place on a particular date but not at a particular time, select No Time.
- \* **Tip**  
Color-code your calendar. Tap the bullet next to the description to file the appointment in a category. Each category has its own color.

4

If the appointment is longer or shorter than an hour, set the duration:

- a. In Day View, tap the start time.
- b. In the Set Time dialog box, tap End Time.
- c. Tap the hour and minute lists to select the time the appointment ends.
- d. Select OK.

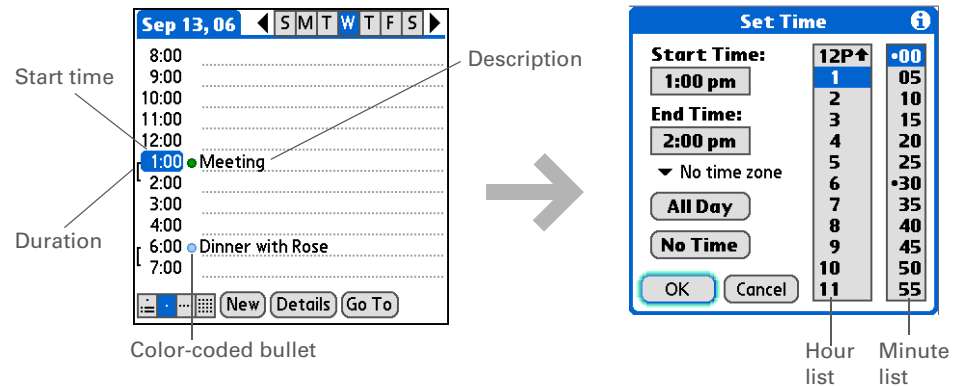

⏴ Done That's it. Your handheld automatically saves the appointment. Make sure you have a current backup. Synchronize often.

## Checking your schedule

Sometimes you want to look at your schedule for a particular date, while other times you want to see an overview of a week or month.

\* **Tip**  
Press the Calendar button repeatedly to cycle through the Agenda View, Day View, Week View, and Month View.

\* **Tip**  
You can also display Year View. From Month View, tap Year.

+ **Did You Know?**  
You can use a favorite photo as the background for your Agenda View.

**1** Press the Calendar  button.

**2** Tap the icons in the lower-left corner to see four different Calendar views:

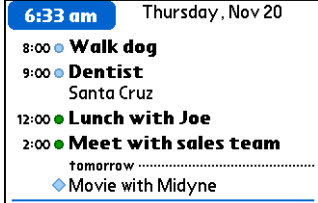

Agenda View

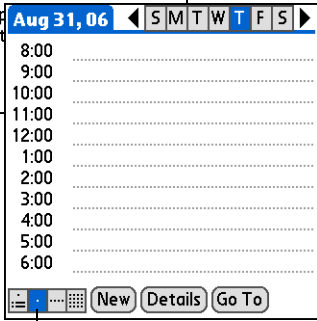

Day View

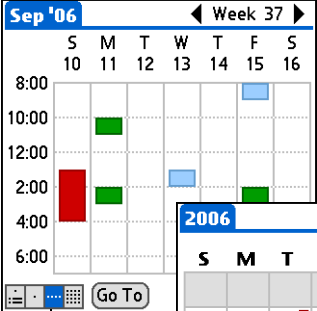

Week View

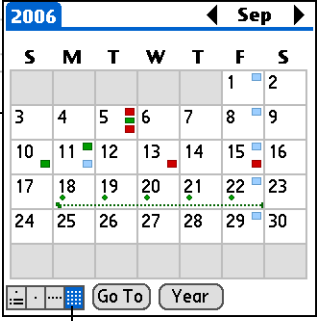

Month View

 Done

## Setting an alarm

**+ Did You Know?**  
Setting your alarm sounds in World Clock instead of in Calendar gives you different alarm sound choices.

**\* Tip**  
Check out the other options in the Event Details dialog box. For example, Repeat creates an event that recurs daily, weekly, or at whatever interval you set up.

**+ Did You Know?**  
When you set an alarm, a little alarm clock appears to the right of the event description.

- 1** Press the Calendar  button.
- 2** Go to the event you want to assign an alarm to:
  - a. From Day View, tap Go To.
  - b. Select the year, month, and date of the event.
  - c. Tap the event description.
- 3** Set the alarm:
  - a. Tap Details.
  - b. Check the Alarm box.
  - c. Select the pick list and select Minutes, Hours, or Days.
  - d. Enter how many minutes, hours, or days before the event you want the alarm to sound, and then select OK.

Event Details i

**Time:** 1:00 pm - 2:00 pm

**Date:** Wed 9/13/06

**Alarm:**  5 ▼ Minutes

**Location:** .....

**Category:** ▼ Unfiled

**Repeat:** ▼ None

**Private:**

**↓ Done**

**User Guide**

For everything you need to know about your handheld—all that's in this guide, and much more—go to [www.palmOne.com/tungstene2-handbook](http://www.palmOne.com/tungstene2-handbook).

**Support**

If you're having problems with Calendar or with anything else on your handheld, go to [www.palmOne.com/intl/support](http://www.palmOne.com/intl/support).

## Beyond the basics

Go to the *User Guide* on the web and learn about these related topics:

- |                   |   |
|-------------------|---|
| <b>Calendar</b>   | <ul style="list-style-type: none"><li>• Creating repeating events for things you do at regular intervals, such as taking a class at the gym three days a week or taking a biweekly music lesson</li><li>• Setting a time zone for an individual appointment different from the time zone of the location you set for your handheld</li><li>• Reserving blocks of time for long events like vacations or conferences</li><li>• Choosing the default Calendar view format and the information that appears in each view by setting display options</li><li>• Customizing alarm settings and choosing what time days start and end by setting preferences</li><li>• Storing extra information about an event by adding a note</li><li>• Erasing old appointments by purging them</li></ul> |
| <b>Categories</b> | Organizing events by type and color-coding them   |
| <b>Privacy</b>    | Keeping events private by turning on security options   |
| <b>Sharing</b>    | <ul style="list-style-type: none"><li>• Beaming events to other Palm Powered™ devices</li><li>• Sending events to other Bluetooth® devices by using Bluetooth wireless technology on your handheld</li></ul>  |
| <b>Email</b>      | Sending events as attachments to email messages   |

# Managing Your Office Files

## In this chapter

[Creating and managing Office files?](#)

[Opening files from within Documents](#)

[Beyond the basics](#)

With its ability to store important information, your handheld lets you take your office with you—including your Microsoft Office files. With the Documents application, you can carry, create, view, and edit Microsoft Word and Excel files directly on your handheld. You can also view, carry, and manage PowerPoint files on your handheld.

You can keep updated copies of the files on both your handheld and your computer so that you can work on them in the most convenient location any time.



## Benefits

- Manage Word, Excel, and PowerPoint files on your handheld
- Improve productivity by taking important docs, spreadsheets, and presentations with you on the go

## Creating and managing Office files?

\* **Tip**

The Documents application has a companion application on your computer called Documents To Go. Use Documents To Go to move or copy files to your handheld when you synchronize.

For complete information on this application, click the Documents To Go icon on your computer and then click Help, or go to [www.dataviz.com](http://www.dataviz.com).

The Documents application provides powerful editing and file management features for Office files on your handheld. What's more, Documents makes it easy for you to share files between your computer and your handheld during **synchronization**.

Here are some of the capabilities of Documents:

- View Word, Excel, and PowerPoint files in their native format (DOC, XLS, or PPT); no conversion needed.
- Create or edit a Word document or Excel spreadsheet on your handheld and save it in native format. Create or edit a PowerPoint presentation that is automatically converted for optimal viewing on your handheld.
- Open Office files received as attachments to incoming **email messages**, and attach files to outgoing messages.
- Transfer Office files to a Bluetooth using your handheld's **built-in wireless technology**.

## Opening files from within Documents

In the Documents application, you can view and open any Word, Excel, or PowerPoint file on your handheld.

### [ ! ] Before You Begin

You must install Documents To Go on your computer from the Tungsten™ E2 software installation CD. Insert the CD and follow the onscreen instructions for installing extra software.

\* **Tip**  
When you are working on a file, save it to your handheld or your expansion card by selecting Menu, selecting Save As from the File menu, and then selecting the location where you want to save the file.

\* **Tip**  
Do you have a file or folder you are always viewing? **Add it to your Favorites list** for easy access.

1

**Go to Favorites** and select Documents.

2

Select the file you want from the list.

↓ Done

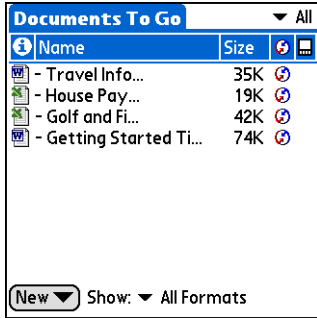

Documents To Go		All
Name	Size	
- Travel Info...	35K	
- House Pay...	19K	
- Golf and Fi...	42K	
- Getting Started Ti...	74K	

New Show: All Formats

## Beyond the basics

Go to the *User Guide* on the web and learn about these related topics:

### User Guide

For everything you need to know about your handheld—all that's in this guide, and much more—go to [www.palmOne.com/tungstene2-handbook](http://www.palmOne.com/tungstene2-handbook).

### Support

If you're having problems with Docs, click the Documents To Go icon on your computer, and then click Help, or go to [www.dataviz.com](http://www.dataviz.com).

### Email

Sending and receiving Office files as attachments to email messages



# Viewing Photos and Videos

## In this chapter

### [Supported file types](#)

### [Viewing photos or videos](#)

### [Organizing photos or videos into albums](#)

### [Sending a photo or video using Bluetooth technology](#)

### [Beyond the basics](#)

A picture may be worth a thousand words, but what happens when you have a lots of pictures—or videos—that you are trying to keep organized? Or maybe just a few that are so meaningful that you want to have instant access to them at any time?

Solve both problems with palmOne™ Media. Media features easy viewing and organization of still photos and videos. You can keep your favorite photos right on your handheld; **select photos as the background** for your Favorites and Applications Views and for Agenda View in Calendar; even **add a photo to a Contacts entry**.



## Benefits

- Never be far from your favorite people or places
- Simplify photo and video organization
- Store multiple videos and photos

## Supported file types

When you **copy a photo or video from your computer**, you can save it directly on your handheld or on an **expansion card** (sold separately) inserted into the expansion slot.

You can view photos in popular formats such as JPG, BMP, TIFF (uncompressed), and GIF on your handheld. On a Windows computer, when you copy a photo in a popular format to your handheld using the Media desktop application from within Palm® Desktop software, the photo is saved on your handheld in its original format. If you copy a photo in a different format, it is saved on your handheld in JPG format.

On a Mac computer, all photos you copy by dragging them onto the Send To Handheld droplet icon are saved on your handheld in JPG format.

To view a video on your handheld, on a Windows computer, open Media from within Palm Desktop software, add the video, and then synchronize to send the video to your handheld. On a Mac computer, drag the video to the Send To Handheld droplet, and then synchronize. The video is converted to a format your handheld can play and is optimized for viewing on the handheld.

For both Windows and Mac computers, note that there are numerous video formats. Not all types can be converted to a format that's viewable on your handheld. If you can't open and view a video in the desktop Media application on a Windows computer, you won't be able to view the video on your handheld.

## Viewing photos or videos

- \* **Tip**  
 Select Slide Show to display all photos and videos in an album, automatically, one after another. Tap a photo or video to stop the slide show.

1

**Go to Favorites** and select Photos & Videos .

2

Tap the pick list in the upper-right corner and select the location on your handheld or an expansion card of the photo or video you want to view.

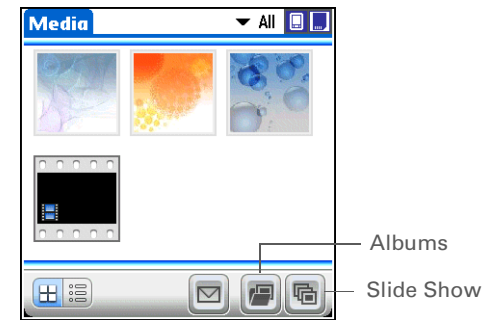

3

Select the photo or video you want to view.

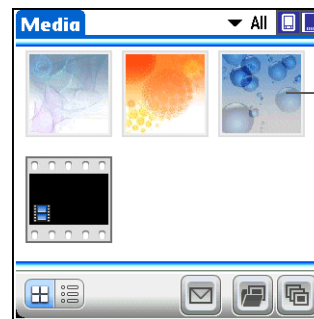

Select a photo or video to view



Tap on the photo or video to return to the selection screen

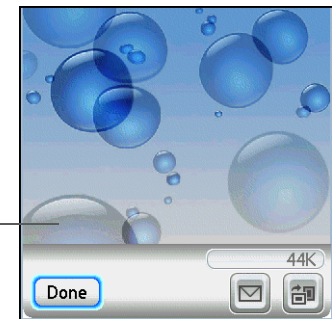

↓ Done

## Organizing photos or videos into albums

### \* Tip

If a photo is stored on your handheld, you can add it only to an album located on the handheld. Likewise, if a photo is stored on an expansion card, you can add it only to an album that is on the same card. Use the **copy** feature to move a photo from your handheld to a card and vice versa.

**1**

**Go to Favorites** and select Photos & Videos .

**2**

Open the Manage Albums screen:

- Open the menus** .
- Select Album, and then select Manage Albums.

**3**

Create an album:

- Select whether to create the album on your handheld or on an expansion card inserted into the expansion slot.
- Select New, enter the name of the new album, and select OK.
- Select OK on the Manage Albums screen.

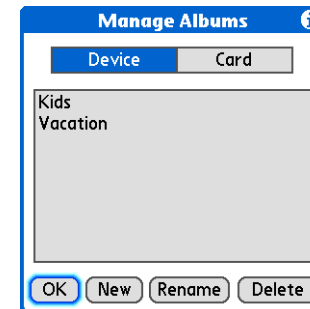

↘ **Continued**

\* **Tip**

If you are not already in the album in which you want to add or remove photos or videos, select the pick list in the upper-right corner and select the album you want.

\* **Tip**

If the buttons don't appear when you're viewing a photo, make sure the photo is fully zoomed out by pressing Down on the 5-way. Tap the photo to return to the original view.

**4**

Add or remove photos or videos in albums:

- Select Manage Albums .
- Select a photo or video without a plus sign to add it to the album.
- Select a photo or video with a plus sign to the left to remove it from the album.
- Select Done.

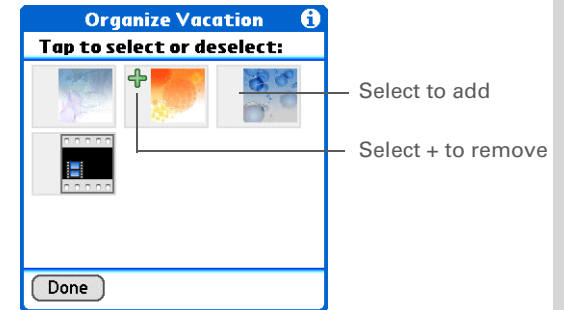
**5**

Move photos or videos within albums:

- Tap the pick list in the upper-right corner and select the album in which you want to move photos or videos.
- Select the photo you want to move, and drag the stylus to move the photo or video to the desired location.

↓ Done

## Sending a photo or video using Bluetooth technology

You can easily share photos with family and friends. Use your handheld's built-in Bluetooth® wireless technology to wirelessly send photos and videos to other Bluetooth devices within range. Sending a file using Bluetooth technology can take some time, so be patient

[ ! ] **Before You Begin**  
Set up a Bluetooth connection on your handheld.

+ **Did You Know?**  
If you select Send before selecting a photo or video, a dialog box appears from which you can select the item you want to send.

+ **Did You Know?**  
There are other ways to send photos wirelessly. Attach a photo or video to an email message. Beam a photo or video to other Palm Powered™ devices. Copy a photo or video to an expansion card and then move the card to another device that accepts MultiMediaCard or SD cards.

**1**

Go to Favorites and select Photos & Videos .

**2**

Send a photo or video:

- a. Tap the pick list in the upper-right corner and select the album containing the photos and/or videos you want to send.
- b. Select the photo or video you want to send.
- c. Select Send .
- d. Select Bluetooth, and then tap OK.
- e. Select the device to which you want to send the photo or video, and then tap OK. The file is sent automatically.

↓ Done

**User Guide**

For everything you need to know about your handheld—all that's in this guide, and much more—go to [www.palmOne.com/tungstene2-handbook](http://www.palmOne.com/tungstene2-handbook).

**Support**

If you're having problems with Media or with anything else on your handheld, go to [www.palmOne.com/intl/support](http://www.palmOne.com/intl/support).

## Beyond the basics

Go to the *User Guide* on the web and learn about these related topics:

**Media**

- Viewing photos and videos as thumbnails, lists, albums, and slide shows
- Copying photos and videos to other applications or expansion cards
- Enhancing photos and videos on your desktop computer
- Deleting photos and videos
- Sending photos from the Media desktop application by using email

**Email**

Sending photos and videos as attachments to email messages

# Listening to Music

## In this chapter

[Transferring MP3 files to an expansion card](#)

[Transferring music from a CD to an expansion card](#)

[Playing music on your handheld](#)

[Beyond the basics](#)

Are you tired of listening to small talk during that long commute on the bus or train? Do you need something smaller than a CD player when you're out for a walk or at the gym? RealPlayer® lets you play music on your handheld. Simply transfer songs onto an expansion card (sold separately) and then listen through the built-in speaker or stereo headphones (sold separately).

**[ ! ] IMPORTANT** You need to purchase an SD or MultiMediaCard [expansion card](#) to save your music files and play them on your handheld.



## Benefits

- Listen to songs in the popular MP3 format
- No separate MP3, CD, or mini-disc player required
- Carry tiny expansion cards instead of CDs
- Be your own DJ



## Transferring MP3 files to an expansion card

### [ ! ] Before You Begin

(Windows only) Install the RealPlayer software. Insert the Tungsten™ E2 software installation CD and follow the onscreen instructions for installing extra software.

### \* Tip

You can also use a card reader accessory (sold separately) to transfer MP3 files from your computer to your expansion card. Create an "SD\_Audio" folder on the card, and store your MP3 files in this folder.

The RealPlayer software that comes with your handheld is compatible with the popular MP3 audio file format. If your MP3 files are already on your computer's hard drive, you need to transfer them to an expansion card to listen to them on your handheld.

### WINDOWS ONLY

**1**

Prepare your computer and your handheld:

- a. **Connect your handheld and your computer to the USB sync cable.**
- b. **Go to Favorites** and then select Music .
- c. **Insert an expansion card** into your handheld.

➤ Continued

**2**

Prepare RealPlayer on your computer:

- a. Open the RealPlayer application.
- b. Select palmOne Handheld (Card) from the Current Burner/Device drop-down list.

Select  
palmOne  
Handheld  
(Card)

**3**

Drag the music files from your desktop onto the palmOne Handheld window. The files are transferred to the Audio folder on your handheld's expansion card.

↓ Done

\* **Tip**  
You can also use a card reader accessory (sold separately) to transfer MP3 files from your computer to your expansion card. Create an "SD\_Audio" folder on the card, and store your MP3 files in this folder.

\* **Tip**  
In Mac OS X, you can make the Send To Handheld droplet a permanent part of your desktop by dragging the droplet to the Dock. Then simply drag songs, and other files you want to transfer to your handheld, onto the droplet in the Dock.

**MAC ONLY****1**

Prepare your computer and your handheld:

- a. **Connect your handheld and your computer to the USB sync cable.**
- b. **Insert an expansion card** into your handheld.

**2**

Select the MP3 files you want to transfer:

- a. Drag and drop the MP3 files onto the Send to Handheld droplet in the palmOne folder.
- b. In the Send To Handheld dialog box, select your username and click OK.

**3**

**Synchronize your handheld with your computer.**

**NOTE** Be patient; transferring music to an expansion card can take several minutes.

↓ Done

## Transferring music from a CD to an expansion card

**+ Did You Know?**  
An interactive tutorial on the Tungsten™ E2 software installation CD guides you through adding music. Insert the CD and go to the My Music section of the tutorial and select Add music from a CD.

If your songs are on a CD and you want to listen to them on your handheld, you need to use RealPlayer on your computer to convert and transfer the files.

### WINDOWS ONLY

# 1

Access the music CD from RealPlayer on your computer:

- Double-click the RealPlayer icon  on your computer desktop.
- Insert the CD into your computer's CD drive.
- If the track listing does not appear, click Music & My Library, and then click CD/DVD in the View menu.



↘ Continued

## \* Tip

If you want to select only a few songs, click **Deselect All** and then click the check box next to the songs you want to select.

## + Did You Know?

A 64MB expansion card holds about an hour of music (capacity varies with sampling rates).

## 2

Select the songs you want to add to your library:

- a. Click **Save Tracks**.
- b. Follow the onscreen instructions to select and copy tracks.

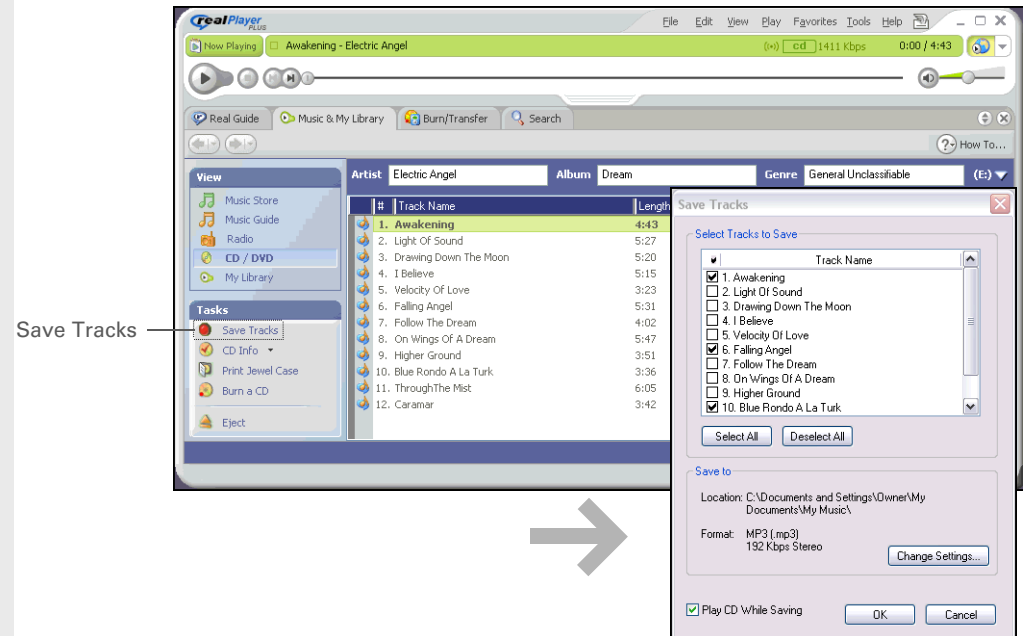

Continued

**\* Tip**

For tips on using RealPlayer on your computer, go to the Help menu in RealPlayer or visit [www.real.com](http://www.real.com).

**3**

Prepare your handheld:

- a. **Insert an expansion card** into your handheld.
- b. **Go to Favorites** and then select Music .
- c. **Connect your handheld and your computer to the USB sync cable.**

[ ! ] **IMPORTANT** Do not press the HotSync button on your cable.

↘ Continued

## 4

Select the songs you want to transfer:

- a. In RealPlayer on your computer, click Burn/Transfer.
- b. If necessary, select palmOne Handheld (Card) from the Current Burn/Transfer Device drop-down list.
- c. Drag the song files you want from the My Library window on the left into the palmOne Handheld window on the right.

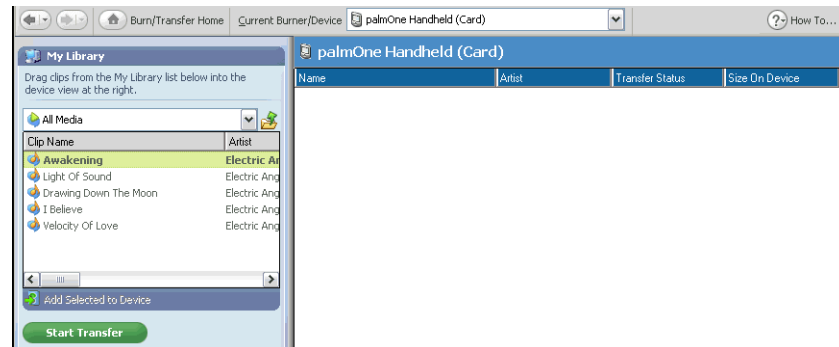

➤ Continued

**5**

Transfer the selected songs to your handheld:

- a. Be sure your handheld is on and that RealPlayer is open. If RealPlayer is open, a green Connected light appears in the lower-left corner of RealPlayer on your computer.
- b. Click Start Transfer. When the transfer is complete, the tracks you selected should say "On Device." The files are transferred to the Music folder on your handheld's expansion card.

**[ ! ] IMPORTANT** Do not press the HotSync button on your cable. RealPlayer is transferring the files, so there's no need to do anything.

 Done



## Playing music on your handheld

\* **Tip**  
For tips on using RealPlayer, [open the Options menu](#) and select Help.

+ **Did You Know?**  
RealPlayer continues playing the songs in your list until it reaches the end of your list or until you tap the Stop button, even if your handheld screen is off.

1

On your handheld, **go to Favorites** and then select Music .

2

Select a song to play:

- To play the current song, tap Play.
- To play a different song, tap Songs and select a song from the list.
- To play a song that is not located in the Songs list, **open the menus** , select Play Folder, and navigate to the song you want.

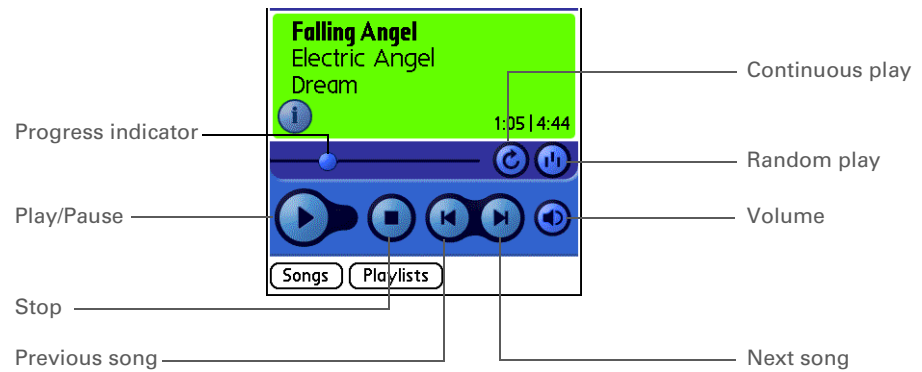

3

When you've finished listening, tap the Stop button.

↓ Done

**User Guide**

For everything you need to know about your handheld—all that's in this guide, and much more—go to [www.palmOne.com/tungstene2-handbook](http://www.palmOne.com/tungstene2-handbook).

**Support**

If you're having problems with RealPlayer, with RealPlayer on your computer, or with anything else on your handheld, go to [www.real.com](http://www.real.com).

## Beyond the basics

Go to the *User Guide* on the web and learn about these related topics:

**RealPlayer**

- Creating playlists by choosing which songs to play and the order to play them in
- Removing songs from an expansion card

# Managing Your Tasks

## In this chapter

[Creating a task](#)

[Organizing your tasks](#)

[Marking a task complete](#)

[Beyond the basics](#)

Some of the most successful people in the world are also the busiest. When asked how they manage to do it all, busy people usually say, “I make lists.” The Tasks application on your handheld is the perfect place to make lists of the things you need to do. For important tasks that you can’t afford to forget, set the alarm.



## Benefits

- Set priorities
- Track deadlines
- Stay focused

## Creating a task

\* **Tip**  
If no task is currently selected, you can create a new task simply by starting to write in the input area.

\* **Tip**  
Set an alarm for the selected task. Tap Details, check the Alarm box, tap the Alarm box, enter the alarm settings, and then select OK.

\* **Tip**  
You can beam tasks to anyone who has a handheld with an IR port. Just **open the Record menu** and select Beam Item or Beam Category.

1

**Go to Applications** and select Tasks .

2

Create a task:

- Select New.
- Enter a description of the task.

Tasks	All	Date	Category	
<input type="checkbox"/> 2	Distribute meeting notes	11/6!		Due date
<input type="checkbox"/> 1	Update project schedule	11/7		
<input type="checkbox"/> 2	Oil change	11/10		
<input type="checkbox"/> 1	Pay bills	11/14		
<input type="checkbox"/> 2	Get football tickets	11/14		
<input type="checkbox"/> 3	Buy anniversary gift for	11/26		Long description
	Midyne & Greg			
<input type="checkbox"/> 1	Submit monthly accruals	11/27		New task
<input checked="" type="checkbox"/> 1	Call painter	-		Priority number
<input type="checkbox"/> 4	Wash car	-		

New Details...  ↓

Note button

3

**[ & ] OPTIONAL** Assign a priority and due date:

- Tap the priority number and select a number (1 is the most important).
- Tap the due date and select a date from the list, or select Choose Date to select a date from the calendar.

↓ Done

That's it. Your handheld automatically saves the task. Make sure you have a current backup. **Synchronize** often.

## Organizing your tasks

Sometimes you want to look at all the things you need to do, while at other times you want to see only certain types of tasks.

**+ Did You Know?**  
Overdue tasks have an exclamation point (!) next to the due date.

**\* Tip**  
Your Task Preferences settings control which tasks appear in the Tasks list, such as completed or due tasks. To change these settings, open the Options menu and select Preferences.

**\* Tip**  
Create a new category for tasks by selecting Edit Categories in the Category pick list.

1

**Go to Applications** and select Tasks .

2

In the Tasks list, select one of these options:

**All** Displays all your tasks.

**Date** Displays tasks that are due in a specific time frame. Tap the pick list in the upper-right to select Due Today, Last 7 Days, Next 7 Days, or Past Due.

**Category** Displays tasks that are assigned to the selected category. Tap the pick list in the upper-right to select a different category.

Tasks	All	Date	Category
<input type="checkbox"/> 2 Distribute meeting notes		11/6!	
<input type="checkbox"/> 1 Update project schedule		11/7	
<input type="checkbox"/> 2 Oil change		11/10	
<input type="checkbox"/> 1 Pay bills		11/14	
<input type="checkbox"/> 2 Get football tickets		11/14	
<input type="checkbox"/> 3 Buy anniversary gift for Midyne & Greg		11/26	
<input type="checkbox"/> 1 Submit monthly accruals		11/27	
<input type="checkbox"/> 4 Call painter		-	
<input type="checkbox"/> 4 Wash car		-	

New Details... 

Tasks	All	Date	Category
<input type="checkbox"/> 2 Distribute meeting notes		Due Today - 1	
<input type="checkbox"/> 1 Update project schedule		Last 7 Days - 2	
		Next 7 Days - 3	
		Past Due - 1	

New Details... 

Tasks	All	Date	Category
<input type="checkbox"/> 2 Distribute meeting notes			Business
<input type="checkbox"/> 1 Update project schedule			Personal
<input type="checkbox"/> 1 Submit monthly accruals			Unfiled
			Edit Categories...

New Details... 

↓ Done

## Marking a task complete

You can check off a task to indicate that you've completed it.

### \* Tip

You can set Task Preferences to record the date that you finish your tasks, and you can show or hide finished tasks. To change these settings, **open the Options menu** and select Preferences.

1

**Go to Applications** and select Tasks .

2

Check the box on the left side of the task.

↓ Done

Tasks	All	Date	Category
▼ Personal			
<input checked="" type="checkbox"/> 4 Wash car		11/7	
<input checked="" type="checkbox"/> 2 Oil change		11/7	
<input type="checkbox"/> 1 Pay bills		11/14	
<input type="checkbox"/> 3 Buy anniversary gift for Midyne & Greg		11/26	
<input type="checkbox"/> 4 Call painter		-	

**NOTE** Palm® Desktop software and Microsoft Outlook handle completed repeating tasks differently. Palm Desktop software checks off all overdue instances of the task, and Microsoft Outlook checks off only the oldest instance of the task.

**User Guide**

For everything you need to know about your handheld—all that's in this guide, and much more—go to [www.palmOne.com/tungstene2-handbook](http://www.palmOne.com/tungstene2-handbook).

**Support**

If you're having problems with Tasks or with anything else on your handheld, go to [www.palmOne.com/intl/support](http://www.palmOne.com/intl/support).

## Beyond the basics

Go to the *User Guide* on the web and learn about these related topics:

**Tasks**

- Creating repeating tasks for things you need to do at regular intervals, such as taking out the trash on Thursday night or filing a weekly status report
- Setting alarms when you use tasks as reminders
- Setting preferences to choose which tasks appear in the Tasks list, whether to track completion dates, and which alarm sound plays
- Storing extra information about a task by adding a note

**Privacy**

Keeping tasks private by turning on security options

**Email**

Sending tasks as attachments to email messages

**Sharing**

- Beaming tasks to other Palm Powered™ devices
- Sending tasks to other Bluetooth® devices by using Bluetooth technology on your handheld

# Writing Memos

## In this chapter

[Creating a memo](#)

[Viewing and editing a memo](#)

[Beyond the basics](#)

Your handheld contains applications for storing the most common types of information: contact names and numbers, appointments, and so on. Memos is the tool to use for capturing information that is meaningful to you but does not fall into one of these categories. From meeting notes to recipes and favorite quotations, Memos provides a quick and easy way to enter, store, and share your important information.



## Benefits

- Store essential but hard-to-remember information
- Easily retrieve and share information



## Creating a memo

\* **Tip**  
In the Memos list, you can also just start writing to create a new memo. The first letter is automatically capitalized.

\* **Tip**  
Use **Phone Lookup** to quickly add a name and phone number to a memo.

**1** Go to Applications and select Memos .

**2** Create a memo:

a. Select New.

**Memos** ▼ All

- 1. Power Tips
- 2. Action Items 11/5
- 3. Quote of the Day
- 4. Birthday Wish List
- 5. Edits for Draft 2
- 6. Hot New Restaurants

New

➔

**Memo** ◀ 5 of 5 ▶ Unfiled

.....

.....

.....

.....

.....

.....

Done Details ↓

b. Enter your memo. Tap Enter on the onscreen keyboard or draw the **Graffiti® 2 writing** Return stroke / to move to a new line in the memo.

c. Select Done.

**↓ Done** That's it. Your handheld automatically saves the memo. Make sure you have a current backup. Synchronize often.

## Viewing and editing a memo

\* **Tip**  
The Memos list shows the first line of each memo, so make sure that first line is something you will recognize.



+ **Did You Know?**  
You can connect your handheld to a portable keyboard and type your memos on the go without carrying around a heavy laptop. You can purchase a variety of portable keyboards.

\* **Tip**  
You can **change the size of the text** in Memos to enhance readability.

**1** **Go to Applications** and select Memos .

**2** View or edit the memo:

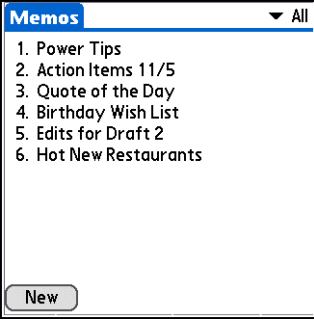
a. In the Memos list, select the memo you want.

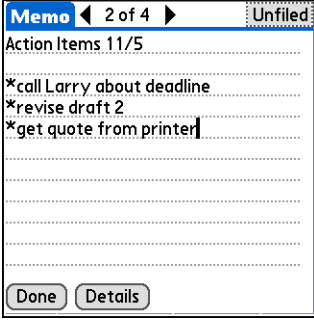
b. Read or edit the memo, and then select Done.

↓ Done

**User Guide**

For everything you need to know about your handheld—all that's in this guide, and much more—go to [www.palmOne.com/tungstene2-handbook](http://www.palmOne.com/tungstene2-handbook).

**Support**

If you're having problems with Memos or with anything else on your handheld, go to [www.palmOne.com/intl/support](http://www.palmOne.com/intl/support).

## Beyond the basics

Go to the *User Guide* on the web and learn about these related topics:

<b>Memos</b>	<ul style="list-style-type: none"><li>• Deleting memos</li><li>• Sending memos to your computer by synchronizing, so you can cut text from a memo and paste it into an application such as Microsoft Word</li></ul>
<b>Categories</b>	Organizing memos by arranging them into categories and sorting them
<b>Privacy</b>	Keeping memos private by turning on security options
<b>Sharing</b>	<ul style="list-style-type: none"><li>• Beaming memos to other Palm Powered™ devices</li><li>• Sending memos to other Bluetooth® devices using the Bluetooth wireless technology on your handheld</li></ul>
<b>Email</b>	Sending memos as attachments to email messages

# Writing Notes in Note Pad

## In this chapter

[Creating a note](#)

[Viewing and editing a note](#)

[Beyond the basics](#)

Need to jot down a phone number or a reminder to yourself? Avoid fumbling for scraps of paper, and write important reminders in Note Pad. You can use Note Pad to do everything you might do with a piece of paper and a pencil. Note Pad gives you a place to draw freehand and take notes in your personal handwriting, which is even faster and more flexible than creating a memo on your handheld.



## Benefits

- No learning curve
- Capture information in the moment
- A picture is worth a thousand words
- See reminders when you set alarms

## Creating a note

### [ ! ] Before You Begin

Make sure **Writing Area is turned off**. You cannot create or edit notes in Note Pad when full-screen writing is on.

### \* Tip

You can change the color of the pen and paper (background). From the Note Pad list screen, **open the Options menu**, select Preferences, and then tap Colors.

### \* Tip

Tap the pen selector to change the pen width or to select the eraser.

### + Did You Know?

You can set an alarm for a note to use it as a reminder.

# 1

**Go to Applications** and select Note Pad .

# 2

Create a note:

- Use the stylus to write your note directly on the handheld screen.
- Select the time at the top of the screen and enter a title using **Graffiti® 2 writing** or the **onscreen keyboard**.
- Select Done.

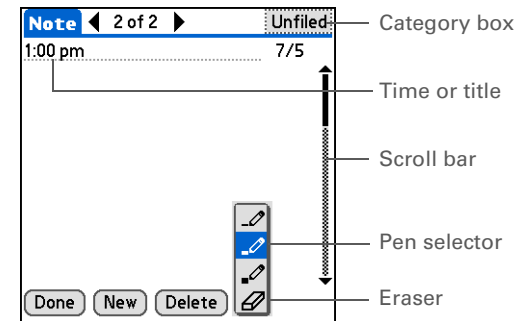

**Done**

That's it. Your handheld automatically saves the note. Make sure you have a current backup. **Synchronize** often.

## Viewing and editing a note

\* **Tip**  
Sort the Note Pad list alphabetically, by date, or manually. **Open the Options menu** from the Note Pad list screen, select Preferences, and then select the Sort by pick list.

If you sort manually, you can rearrange the list by dragging notes to another position in the list.

**1** **Go to Applications** and select Note Pad .

**2** Open the note:

- Select Done to display the Note Pad list.
- Select the note you want to view or edit.

Note Pad		All
1. Welcome to Note Pad	7/2	
2. Groceries	7/5	
3. Bob	7/5	
4. Flowers	7/5	
5. Bank	7/5	

→

Note ◀ 2 of 2 ▶ Errands: 7/5

Groceries

Milk  
Eggs  
Bread  
Lettuce

Done New Delete 

**3** Read or edit the note, and then select Done.

↓ Done

**User Guide**

For everything you need to know about your handheld—all that's in this guide, and much more—go to [www.palmOne.com/tungstene2-handbook](http://www.palmOne.com/tungstene2-handbook).

**Support**

If you're having problems with Note Pad or with anything else on your handheld, go to [www.palmOne.com/intl/support](http://www.palmOne.com/intl/support).

## Beyond the basics

Go to the *User Guide* on the web and learn about these related topics:

<b>Note Pad</b>	Setting alarms when you use notes as reminders
<b>Categories</b>	Organizing notes by arranging them into categories and sorting them
<b>Privacy</b>	Keeping notes private by turning on security options
<b>Sharing</b>	<ul style="list-style-type: none"><li>• Beaming notes to other Palm Powered™ devices</li><li>• Sending notes to other Bluetooth® devices by using Bluetooth wireless technology on your handheld</li></ul>
<b>Email</b>	Sending notes as attachments to email messages

# Making Wireless Connections

## In this chapter

[What can I do with the built-in Bluetooth wireless technology?](#)

[What types of connections can I make?](#)

[Entering basic Bluetooth settings](#)

[Setting up a phone connection](#)

[Accessing email and the web wirelessly](#)

[Setting up a connection for wireless synchronization](#)

[Beyond the basics](#)

Your handheld helps keep your world organized by storing contact information and documents, recording appointments, and so on. Now your handheld can actually connect you to the world—wirelessly, using Bluetooth<sup>®</sup> wireless technology. Need to make a phone call? Tap the number in Contacts, and your mobile phone begins dialing. How about browsing the web or sending an email message from your handheld—without a cable?

Your handheld's built-in Bluetooth functionality helps you easily set up wireless connections to a number of devices so you can enjoy the convenience of cable-free connectivity.



## Benefits

- Connect to your Bluetooth phone to send text or email messages or to access the web
- Reduce cable clutter by synchronizing wirelessly
- Connect to other devices to share files wirelessly



## What can I do with the built-in Bluetooth wireless technology?

### » Key Term

**Bluetooth** Technology that enables devices such as handhelds, mobile phones, and computers to connect wirelessly to each other.

### [ ! ] Before You Begin

Any device you connect to must also be a Bluetooth device with Bluetooth features enabled. Check the user guide that came with the device for information on how to enable the Bluetooth features.

#### **Connect to your Bluetooth phone to send text or email messages or to access the web.**

Whether you access the Internet or send text or email messages once a week or constantly throughout the day, wireless connectivity means that you can go online anytime by connecting by means of your mobile phone or your laptop connected to the Internet.

**Reduce cable clutter by synchronizing wirelessly.** Imagine your desk and workstation without cable clutter. Bluetooth wireless technology on your handheld replaces many of the connecting cables with a wireless connection for tasks such as synchronizing.

**Connect to other devices to share files wirelessly.** Wouldn't it be great if you could send files such as photos wirelessly or print wirelessly on a Bluetooth printer? Use the built-in Bluetooth wireless technology to set up connections to devices within approximately 30 feet of your handheld.

## What types of connections can I make?

With Bluetooth wireless technology, you can make connections using the following types of devices:

- To browse the Internet or access your email account, link through your desktop computer's network connection or establish a connection to a Bluetooth LAN Access Point.
- To access the Internet or an email account, connect to your mobile phone. To use a mobile phone, you must dial your ISP or sign up for an account with a high-speed wireless carrier.
- To send and receive text messages, connect to your mobile phone.
- To synchronize your handheld with your computer wirelessly, connect to your computer.
- To share files with another Bluetooth device such as a handheld or printer, form a trusted pair with that device.

## Entering basic Bluetooth settings

### » Key Term

**Discoverable** Setting that allows other devices to find and connect with your handheld using Bluetooth wireless technology. If your handheld is not discoverable, other devices cannot find it to make a connection. Your handheld must be powered on in order to be discoverable.

1

**Go to Favorites** and select Bluetooth .

2

Enter the basic Bluetooth settings:

- Select On.
- Tap the Device Name field and enter a name for your handheld. This is the name other Bluetooth devices see when they connect to your handheld. By default it is the username you use during synchronization, but you can change it.
- Select the Discoverable pick list and select Yes or No.

↓ Done

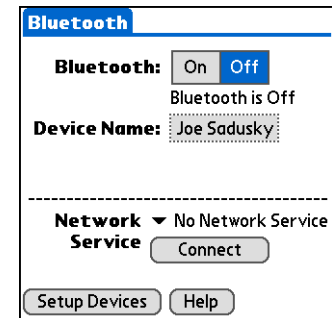

## Setting up a phone connection

\* **Tip**  
If you receive a message that your phone is not ready to accept a connection, check to make sure that your phone is prepared to make a Bluetooth connection. See the instructions included with your phone.

[ ! ] **IMPORTANT** To set up a phone connection, you must have a GSM or GPRS mobile phone enabled with data services.

**1**

**Go to Favorites** and select Bluetooth .

**2**

Select Setup Devices, select Phone Setup, select Phone Connection, and then select Next.

↘ **Continued**

**3**

Select the phone you want to connect to:

- a. Select the Manufacturer and Model pick lists, select the correct entries for your phone, and then select Next.
- b. The Connection Setup screen displays all Bluetooth phones within range. If your phone did not show up on the discovery results, select Find More to search again.

If the phone still does not appear, check if your phone is Bluetooth discoverable. See the instructions included with your phone.

If the phone still does not appear on the list, check for phone compatibility on [www.palmOne.com/bluetooth](http://www.palmOne.com/bluetooth). Try selecting Other in the Manufacturer or Model pick list.

- c. Select the phone you want, select OK, and then select Next again.

**NOTE** Not all features are available if your specific phone model is not in the pick list.

↘ **Continued**

## » Key Term

**Passkey** Like a password, the passkey is a security measure. Connections can happen only between your handheld and a device that has the same passkey. For example, to connect to your mobile phone, you need to enter the same passkey on your handheld and on your phone.

## » Key Term

**Trusted pair** Two devices—for example, your handheld and your mobile phone—that can connect to each other because each device can find the same passkey on the other device. Once you form a trusted pair with a device, you do not need to enter a passkey to connect with that device again.

**4**

Enter a passkey:

- a. Enter a passkey number. This can be any number you choose; it does not have to be, for example, a password you use to access a network or an email account.

[ ! ] **IMPORTANT** You must enter the same passkey on your handheld and your mobile phone in order to connect to your phone.

- b. Select OK.

**5**

Finish phone connection setup and begin network setup:

- a. Select Done, and then select Yes.

**NOTE** If you want to use your phone connection only to dial phone numbers from your handheld or send text messages, select Done and then select No. You have finished setup.

- b. Select Next.

**6**

Begin network setup:

- a. Select the pick list, select Yes or No, and then select Next. If you select Yes, go to step 7. If you select No, go to step 8.

↘ **Continued**

**» Key Term**

**GPRS** Acronym for General Packet Radio Service, a method of sending information wirelessly at high speeds. Select Yes in step 6 only if you have a GPRS account for your mobile phone.

**\* Tip**

Contact your ISP if you are not sure about any of the items to enter in step 8.

**7**

If you selected Yes in step 6:

- a. Select the pick lists and select the correct information for your cellular carrier.
- b. Select Next, and then select Done.

**8**

If you selected No in step 6:

- a. Select Next.
- b. Enter the phone number you use to dial in to your Internet service provider and the username for your dial-up account.
- c. Tap the Password box, enter your account password, and select OK. This is the password you use to access your dial-up account; it is not your passkey.
- d. Select Next, and then select Done.

**↓ Done**

**See the next procedure for steps on using your phone connection to browse the web or send and receive email messages.**

## Accessing email and the web wirelessly

After you set up a connection with a mobile phone, you can send and receive email or browse the web wirelessly using this connection.

**NOTE** Bluetooth functionality must be on if you want to use wireless features. You must also **set up an email account** on your handheld before you can send or receive email messages.

**1**

Open the **email application** or the **web browser**.

**2**

Verify Bluetooth status:

a. **Go to Favorites** and select

Bluetooth .

b. Make sure On is selected.

↘ **Continued**

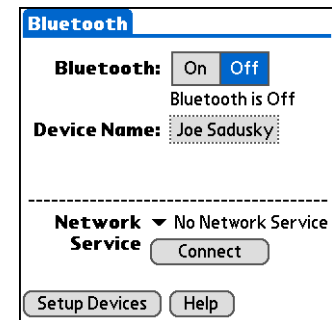

## » Key Term

**Service** Way of connecting to a mobile phone to send information wirelessly, for example, through a high-speed (GPRS) carrier or a dial-up account with an Internet service provider (ISP).

## \* Tip

When you **enter a URL** in the web browser or select **Get and Send** in the VersaMail® application, a connection automatically initiates with the last used service.

## 3

Connect to your phone:

- a. Select Prefs from the Bluetooth status screen.
- b. On the Bluetooth preferences screen, select the Network Service pick list and select the service that you want to use to connect to the Internet. If you **set up a phone connection**, the name of the service you configured is listed.
- c. Select Connect.



Done

You are now ready to **send and receive email messages** or to **browse the web**.



## Setting up a connection for wireless synchronization

### WINDOWS ONLY

\* **Tip**  
To open HotSync® Manager on your computer in step 2 of the onscreen instructions (see procedure step 3b, below), click the HotSync Manager icon on the taskbar in the lower-right corner of your computer screen.

\* **Tip**  
After the first time you set up a connection and wirelessly synchronize with a computer, you can synchronize with that computer at any time by choosing its device name from the Service pick list and tapping Connect.

- 1 **Go to Favorites** and select Bluetooth .
- 2 Select Setup Devices, select PC Setup, select Bluetooth HotSync, and then select Next.
 

**Setup Devices**

 Phone Setup  
Messaging, Dial from Contacts, Internet connectivity.

 PC Setup  
Browse the Web, Check Email, HotSync wirelessly.



 LAN Setup  
Browse the Web, check Email.

→

**PC Setup**

**To set up a connection or wireless HotSync, tap below:**

 PC Connection  
Set up a wireless connection and data service to your PC.

 Bluetooth HotSync  
Set up your PC to synchronize using Bluetooth.
- 3 Set up a connection for wireless synchronization:
  - a. Follow the onscreen instructions for steps 1–3, selecting Next after each step.
  - b. Select Launch HotSync Manager in step 4.
  - c. Select HotSync  to synchronize your handheld with your computer.

↓ Done

## MAC ONLY

1

**Go to Applications** and select **Prefs** .

2

Open the Edit Connection screen:

- a. From the Communications Preferences list, select Connection.
- b. Tap New.

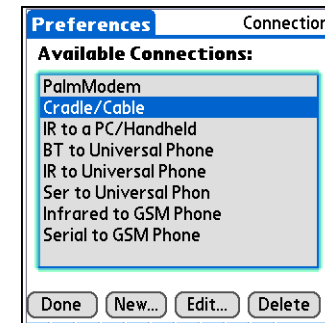

3

Set up the connection to your computer:

- a. Enter a name for the connection, such as BT to Mac.
- b. Select the Connect to pick list and select PC.
- c. Select the Via pick list and select Bluetooth.

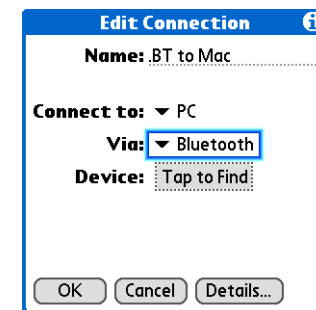

↘ Continued

**\* Tip**

Just as it is safer to use different personal identification numbers (PINs) for different bank accounts, your passkeys are more secure if you use a different passkey for each device with which you want to connect—one passkey for a connection to a phone, a different one for a connection to a computer, and so on. Just remember that you must enter the same passkey on your handheld and on the device with which you want to connect.

**Cont'd.**

d. Make sure the computer is ready to accept a Bluetooth connection.

**NOTE** See the documentation included with the computer for information on how to prepare it to accept a Bluetooth connection. The documentation might refer to a Bluetooth connection as a Bluetooth pairing or a Bluetooth link.

e. Select the Device box.

**4**

Select the computer:

- a. When the Discovery Results screen appears, select your computer. If your computer does not appear on the list, select Find More.
- b. Select OK.

**5**

**[ & ] OPTIONAL** If prompted, enter a passkey:

- a. Enter a passkey number. This can be any number you choose; it does not have to be, for example, a password you use to access a network or an email account.



**[ ! ] IMPORTANT** You must enter the same passkey on your handheld and your computer in order to wirelessly synchronize with your computer.

- b. Select OK.

↘ **Continued**

**6**

Synchronize your handheld with your computer:

- a. **Go to Applications** and select HotSync .
- b. Make sure Local is selected, and select the connection you created in step 3 from the pick list.
- c. Select HotSync .

↓ Done

## Beyond the basics

Go to the *User Guide* on the web and learn about these related topics:

### User Guide

For everything you need to know about your handheld—all that's in this guide, and much more—go to [www.palmOne.com/tungstene2-handbook](http://www.palmOne.com/tungstene2-handbook).

### Support

If you're having problems with your handheld's wireless capabilities or with anything else on your handheld, go to [www.palmOne.com/intl/support](http://www.palmOne.com/intl/support).

### Connecting

- Connecting to the Internet through your Bluetooth desktop computer to access the web wirelessly
- Connecting with a network using a Bluetooth Access Point to access the Internet and send and receive email messages
- Connecting to your Bluetooth phone by means of the infrared port on your handheld
- Setting the Bluetooth options on your handheld to allow your handheld to wake up and receive an incoming connection request when turned off

# Sending and Receiving Text Messages

## In this chapter

[Sending a text message](#)

[Viewing a text message](#)

[Beyond the basics](#)

If you need to get a short message to a friend or co-worker fast, send a text message from your handheld by means of your mobile phone (GSM phone required; sold separately) to their mobile phone. Messaging is a popular way for people to stay connected using the text messaging features of their mobile phone.



## Benefits

- Enjoy quick communication
- Use text messaging to chat with friends

## Sending a text message

### [ ! ] Before You Begin

**Set up a phone connection** on your handheld to send and receive information wirelessly.

### » Key Term

**SMS** A type of message that can be received by most mobile phones. More commonly known as text messaging.

1

**Go to Applications** and select SMS .

2

Send a text message:

a. Select New.

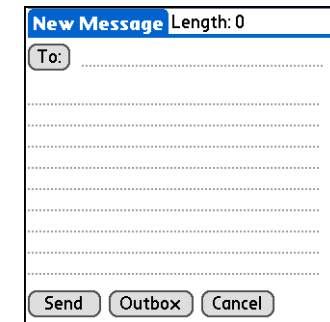
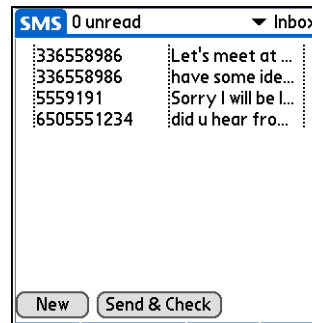

b. Select To. Select the recipient's name if it appears on the Mobile Number Lookup list, and then select Add. If the name does not appear on the list, select Cancel and enter the recipient's mobile phone number on the To line.

c. In the area below the To line, enter the text of your message.

d. Select Send.

 Done

## Viewing a text message

- \* **Tip**  
Use the buttons at the bottom of the message screen to reply to or delete a message after you open it.

- 1** **Go to Applications** and select SMS. 
- 2** Select Send & Check.
- 3** Read a message:
  - a. Select the message to open it.

SMS 0 unread ▾ Inbox

336558986	Let's meet at ...
336558986	have some ide...
5559191	Sorry I will be l...
6505551234	did u hear fro...

New Send & Check

➔

Message ◀ 2 of 4 ▶

From: 336558986  
Date: 6/27/04 2:59 pm  
have some ideas about the meeting

Done Reply Delete
  - b. Read the message, and then select Done.

↓ Done



**User Guide**

For everything you need to know about your handheld—all that's in this guide, and much more—go to [www.palmOne.com/tungstene2-handbook](http://www.palmOne.com/tungstene2-handbook).

**Support**

If you're having problems with SMS or with anything else on your handheld, go to [www.palmOne.com/intl/support](http://www.palmOne.com/intl/support).

## Beyond the basics

Go to the *User Guide* on the web and learn about these related topics:

**SMS**

- Replying to and deleting messages you receive
- Setting preferences for receiving messages
- Hearing an alert when you receive a message

**Customizing**

Setting preferences for connecting to a network

# Browsing the Web

## In this chapter

[Accessing a web page](#)

[Beyond the basics](#)

You use the web for so many things: checking email, finding driving directions, getting news, buying gifts. Now you can take the web with you almost anywhere you go. Make an Internet connection through your mobile phone, and the web browser opens the entire web to you.



## Benefits

- Carry the web with you
- View web pages in a handheld-friendly format
- Store pages for offline viewing

## Accessing a web page

### [ ! ] Before You Begin

To browse the web, you must **set up a connection to the Internet** from your handheld.

### » Key Term

**URL** Stands for “uniform resource locator,” the technical name for a web address. For example, the URL for Yahoo! is `http://www.yahoo.com`.

1

**Go to Applications** and select Web .

2

Go to the web page you want to view:

a. Select Go to Web Page .

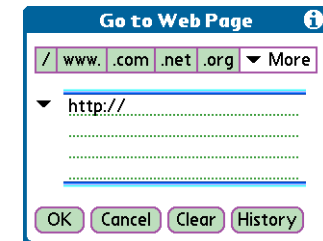
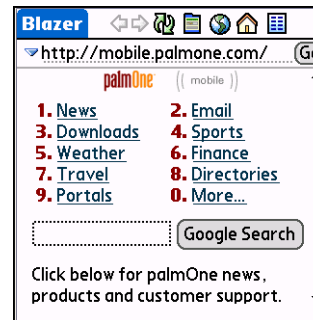

b. Enter the address of the web page you want to visit. Use the buttons in the Go to Web Page dialog box for quick entry of characters commonly used in web addresses. If you have previously visited a web page, the web browser recognizes the address when you begin entering it and automatically completes it.

c. Select OK.

↓ Done

**User Guide**

For everything you need to know about your handheld—all that's in this guide, and much more—go to [www.palmOne.com/tungstene2-handbook](http://www.palmOne.com/tungstene2-handbook).

**Support**

If you're having problems with the web browser or with anything else on your handheld, go to [www.palmOne.com/intl/support](http://www.palmOne.com/intl/support).

## Beyond the basics

Go to the *User Guide* on the web and learn about these related topics:

**Web**

- Refreshing a page to see updated information
- Using a bookmark for quick access to your favorite web pages
- Returning to a web page you just visited or to your home page
- Downloading a file from a web page
- Changing your start and home pages

**Customizing**

Setting preferences for connecting to a network

# Sending and Receiving Email Messages

## In this chapter

[Setting up an account](#)

[Getting and reading email](#)

[Sending an email message](#)

[Working with attachments](#)

[Beyond the basics](#)

You already know how efficient email is for staying in touch with personal and business contacts. Now the VersaMail® application brings you a new level of convenience: email on the go. Enjoy the ease and speed of communicating with friends, family, and colleagues anywhere you can make an Internet connection.

You can email photos to your friends and family. Or, use Documents on your handheld to create Microsoft Word or Excel files, and send them to your colleagues. You can also receive any of these file types as attachments to view and edit at your convenience. You can also synchronize email messages on your handheld with email on your desktop computer.



## Benefits

- Access email on the go
- Send and receive photos, sound files, Word and Excel files, and more
- Save messages from your computer to view at a convenient time

## Setting up an account

### [ ! ] Before You Begin

Install the VersaMail software. Insert the CD and follow the onscreen instructions for installing extra software.

### » Key Term

**Protocol** Settings your email provider uses to receive email messages. Most providers use the Post Office Protocol (POP); a few use the Internet Message Access Protocol (IMAP).

### \* Tip

If your email provider appears on the Mail Service pick list, you don't need to select a protocol. The correct protocol is automatically displayed.

1

**Go to Applications** and select VersaMail .

2

Open the Account Setup screen:

- Open the menus** , select Accounts, and then select Account Setup.
- Select New.

3

Enter the basic account information:

- In the Account Name field, enter a descriptive name.

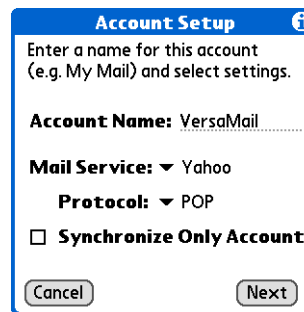

↘ Continued

\* **Tip**

Your username is usually the part of your email address appearing before the @ symbol, not your entire email address. Check with your ISP if you are not sure what username to enter.

+ **Did You Know?**

Your incoming mail server is also called your POP or IMAP server; your outgoing mail server is also called your Simple Mail Transfer Protocol (SMTP) server.

\* **Tip**

If you checked the Synchronize Only Account box in step 3, you need to **configure this account on your computer** before you can send or get email messages.

**Cont'd.**

- b. Select the Mail Service pick list, and then select your email provider. Select Other if your provider is not listed.
- c. If you chose Other, select the Protocol pick list, and then select POP or IMAP.
- d. Check the box if you intend *only* to synchronize email for this account on your handheld with a mail program on your computer such as Microsoft Outlook, Outlook Express, or Lotus Notes. If you intend to *ever* send or receive email for this account wirelessly from your handheld (even if you will also synchronize email), leave the box unchecked.
- e. Select Next.

**4**

Enter the account username and password:

- a. Enter the username you use to access your email.
- b. Select the Password box, enter your email account password, and then select OK.
- c. Select Next.

↘ **Continued**

\* **Tip**  
Check with your email service provider for the names of your incoming and outgoing mail servers.

**5**

Enter your email address and mail server info:

**NOTE** If you chose a common email provider from the Mail Services pick list on the Account Setup screen, this screen is already filled in.

- a. Enter your email address.
- b. Enter the names of your mail servers.
- c. Select Next.

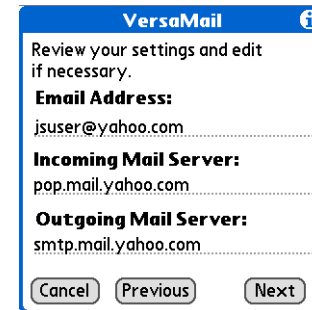

**VersaMail** ⓘ

Review your settings and edit if necessary.

**Email Address:**  
jsuser@yahoo.com

**Incoming Mail Server:**  
pop.mail.yahoo.com

**Outgoing Mail Server:**  
smtp.mail.yahoo.com

Cancel Previous Next

**6**

Select Done.

↓ Done



## Getting and reading email

### \* Tip



If you checked the Synchronize Only Account box, you must **synchronize your handheld with your computer** to download messages to your handheld.

### + Did You Know?

You can set up your handheld to **automatically check for and download** new email messages.

### \* Tip

If you select Messages, the first 5KB of each message is downloaded. You can **change the maximum size** for downloaded messages in the VersaMail preferences.

- 1 **Go to Applications** and select VersaMail .
- 2 Choose whether to get message subjects only or full messages:
  - a. **Open the menus** , select Accounts, and then select the account you want.
  - b. Select Get Mail or Get & Send.

New
Get Mail
Display

➔

Get Mail Options i

Subjects Only

Messages

OK

Cancel

Details...

  - c. In the Get Mail Options dialog box, select Subjects Only to download subjects only, or select Messages to download entire messages.
  - d. Select OK.
  - e. Select OK again if prompted.
- 3 In the Inbox, select the message to read it.
 

 Done

## Sending an email message

### \* Tip



If you checked the Synchronize Only Account box, you must **synchronize** so that messages you compose on your handheld can be sent out through your computer's email application.

### + Did You Know?

You can set up your handheld to **automatically try resending** any messages that are not sent correctly the first time.

### + Did You Know?

When you put addresses in the copies (cc:) field, they are visible to all other recipients. Addresses in the blind copies (bcc:) field are hidden from all other recipients.

- 1 **Go to Applications** and select VersaMail .
- 2 Send email:
  - a. **Open the menus** , select Accounts, and then select the account you want.
  - b. Select New.
 

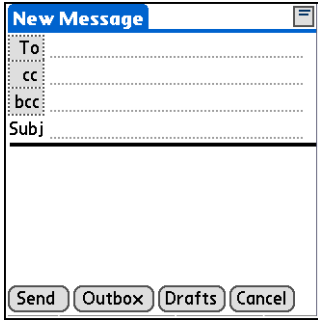
➔

  - c. In the To field, enter the recipient's email address. For multiple recipients, type a semicolon (;) between recipient names.
  - d. In the Subj field, enter the subject of your email. In the area below the Subj line, enter the text of your email.
  - e. Select Send.

↓ Done

## Working with attachments

You can easily download, view, save, and send attachments with email messages. Among the attachment types you can download and work with are Word documents, Excel spreadsheets, web pages, photos and videos, contacts, appointments, and tasks.

### Downloading an attachment to your handheld

In the message list, a paper clip on a message's envelope icon indicates that the message has an attachment that has been downloaded. You can view, edit, install, or save an attached file, depending on the file type.

**+ Did You Know?**  
When you see both a red paper clip icon and the More button in the Message screen, that means that some attachments to this message were downloaded, but others remain to be downloaded.

**\* Tip**  
If you choose to get messages by subject only, tap More for each downloaded message to view the body of the email message plus any attachments, up to the maximum message size.

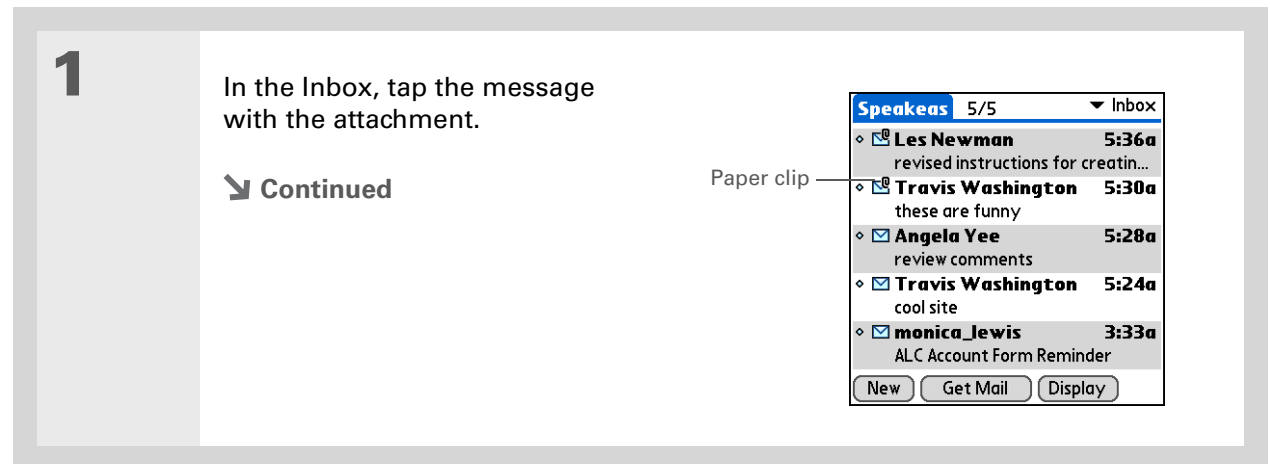

### + Did You Know?

The maximum message size you can download is 60KB for the body text and approximately 5MB total, including attachments. If an attachment is too large, it cannot be downloaded to the handheld. You can download a maximum of ten attachments for any received messages, regardless of message size.

### \* Tip

Because large messages can take up a lot of space on your handheld, the VersaMail application displays the size and asks if you want to continue downloading any message that exceeds your maximum message size, up to a total size of 5MB. Select Yes to download the message and any attachments.

## 2

Open the attachment(s):

- a. Tap the red paper clip icon in the upper-right corner.
- b. Select the attachment you want, and then select View, Install, or Unzip, depending on the attachment file type. Or select Save to save the attachment to an **expansion card**. If you select View and the Viewer pick list appears, select the application you want to use to view the attachment.

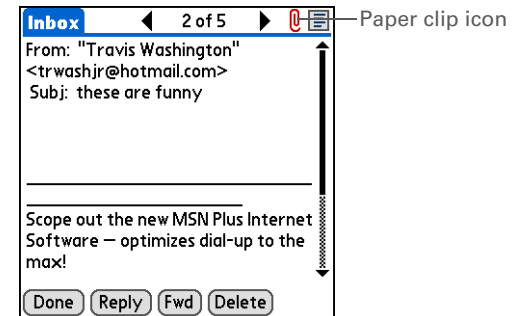

## 3

When you finish with the attachment, select Done to return to the Attachments dialog box. If there is no Done button, tap Home  and select VersaMail to return to the Inbox of the account you were in.

↓ Done

## Attaching a file from your handheld

You can attach files on your handheld to email messages you send. For example, you can attach photos or videos, Word documents, Excel spreadsheets, and entries from Contacts or Calendar.

- + Did You Know?**  
The maximum size message you can send is 60KB for the body text and approximately 5MB of total data for any attachments. The maximum number of attachments for any email message is ten, regardless of the attachments' total size.

- \* Tip**  
Repeat step 2 to attach more than one file to a message. To remove an attachment, select the file in the Attachments box, and then select Delete.

1

Open the Attachments screen:

- On the message screen, **open the menu** .
- Select Options, and then select Attachment.

2

Attach the file:

- Select the Type pick list, and then select the file type. Or select to browse files on an expansion card.

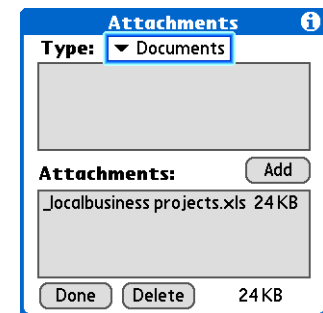
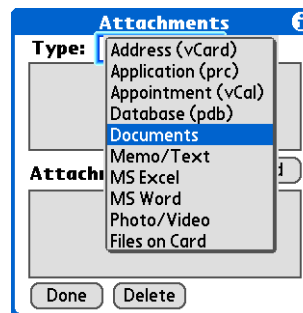

- Select the file that you want to attach, select Add or Attach, and then select Done.

↓ Done

**User Guide**

For everything you need to know about your handheld—all that's in this guide, and much more—go to [www.palmOne.com/tungstene2-handbook](http://www.palmOne.com/tungstene2-handbook).

**Support**

If you're having problems with the VersaMail application or with anything else on your handheld, go to [www.palmOne.com/intl/support](http://www.palmOne.com/intl/support).

## Beyond the basics

Go to the *User Guide* on the web and learn about these related topics:

**Email**

- Using the VersaMail application with Microsoft Outlook on your computer
- Setting basic email preferences such as changing the maximum message size, adding a signature to outgoing messages, and downloading files attached to email messages
- Using a virtual private network (VPN) to get and send email over your company's network
- Editing and deleting an email account
- Automatically retrieving email on your handheld
- Automatically trying to resend messages that weren't sent the first time
- Customizing your Inbox display options such as message summary view and font size and colors for read and unread mail
- Synchronizing email messages on your handheld with email messages on your computer

**Customizing**

Setting preferences for connecting to a network

# Expanding Your Handheld

## In this chapter

[What type of expansion cards can I use?](#)

[How can expansion cards help me?](#)

[Removing an expansion card](#)

[Inserting an expansion card](#)

[Beyond the basics](#)

A Chinese proverb says, “Life just gives you time and space; it's up to you to fill it.” But doesn't it always seem that no matter how much space you have, you still need more?

Expansion cards (sold separately) provide a compact and limitless answer to the storage dilemma. When one card becomes full, simply use another card. To enjoy some aspects of your handheld, such as listening to music, you need to use expansion cards. Also use expansion cards to install and run cool games and other types of software, from dictionaries to travel guides, on your handheld.



## Benefits

- Listen to music
- Back up info
- Add more games and other software
- Add accessories
- Store all your info

» **Key Term**  
**SDIO** An acronym for Secure Digital input/output.

## What type of expansion cards can I use?

Your handheld is compatible with SDIO, SD, and MultiMediaCard expansion cards. SDIO expansion cards let you add accessories to your handheld. SD and MultiMediaCard expansion cards let you store information and applications.

## How can expansion cards help me?

**Listen to music.** Store songs on expansion cards and use the included **RealPlayer software** to listen to music on your handheld.

**Back up info.** Make a copy of your important information for safekeeping in case your handheld becomes damaged or is stolen.

**Add accessories.** Attach SDIO accessories, such as a presentation module, to your handheld.

**Store all your info.** Never worry about running out of space on your handheld. Purchase as many expansion cards as you need to store your music, photos, videos, and other information. Expansion cards come in a variety of capacities, and they're very small, easy to store, and affordably priced.



## Removing an expansion card

\* **Tip**  
To prevent damaging the card and the info on it, always wait for your handheld to finish writing to the expansion card before you remove the card from the slot.

**NOTE** Your handheld comes with a dummy card inserted into the expansion card slot. You must remove this card before you can put a real card into the slot.

**1**

Push lightly against the card with your thumb until you hear the confirmation tone.

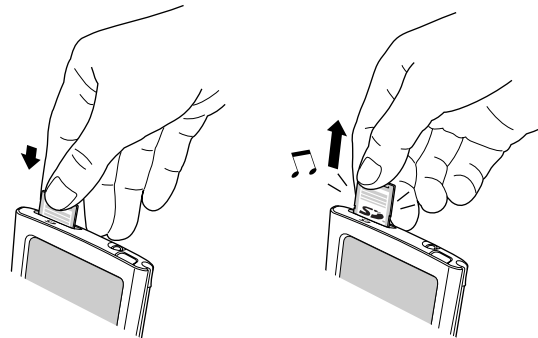
**2**

Slide the card out of the expansion slot.

↓ Done

## Inserting an expansion card

**1**

Insert the card into the expansion slot with the label side facing the front of the handheld.

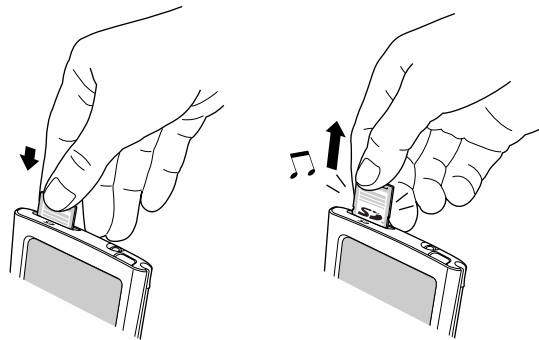
**2**

Push the card in with your thumb until you feel the card “click” in place and hear the confirmation tone.

**NOTE** No confirmation tone? Check the [Sounds & Alerts Preferences](#) to make sure the System Sound setting is turned on.

↓ Done

## Beyond the basics

Go to the *User Guide* on the web and learn about these related topics:

### User Guide

For everything you need to know about your handheld—all that's in this guide, and much more—go to [www.palmOne.com/tungstene2-handbook](http://www.palmOne.com/tungstene2-handbook).

### Support

If you're having problems with expansion cards or with anything else on your handheld, go to [www.palmOne.com/intl/support](http://www.palmOne.com/intl/support).

### Expansion Cards

- Opening applications that are stored on expansion cards
- Copying applications between your handheld and an expansion card
- Deleting applications and other files from an expansion card
- Reviewing information about the contents of an expansion card using the Card Info application
- Naming an expansion card so you can easily identify its contents

### Moving and Managing

Adding applications from your computer to an expansion card, and installing other files such as music

### Sharing

- Exchanging applications and information with other Palm Powered™ devices by exchanging cards or beaming items between handhelds
- Sending applications and information to other Bluetooth® devices by using Bluetooth wireless technology on your handheld

# Customizing Your Handheld

## In this chapter

[Setting the date and time](#)

[Preventing your handheld from turning on by accident](#)

[Changing the screen fonts](#)

[Changing the background of your screen](#)

[Correcting problems with tapping](#)

[Selecting sound settings](#)

[Changing entries in Favorites](#)

[Beyond the basics](#)

Although customizing your handheld is optional, it's like changing the preset radio stations in your car. Since you're probably not driving around with the dealer's preset radio stations, why not personalize your handheld, too?

You can easily customize the sound levels, fonts, and screen colors on your handheld by using preferences and menus. And preference settings can help extend the life of your handheld's battery.



## Benefits

- Access applications quickly
- Conserve power
- Enjoy your handheld more
- Make your screen easy to read

## Setting the date and time

- \* **Tip**  
 You can rename the location to the city where you live. Tap the Name field, and then modify the location name.

You can set the current date and time based on your location. These settings are used by all the applications on your handheld that require a date, time, or location.

### 1

Open Date & Time Preferences:

- a. **Go to Applications.**
- b. Select Prefs .
- c. Select Date & Time.

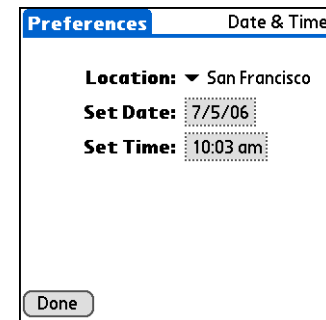

### 2

Select the location:

- a. Tap the Location pick list, and select a city in your time zone. No nearby city? Select Edit List and do steps b–c.
- b. Tap Add.
- c. Select a city in your time zone, and then select OK. Select OK again, and then select Done.

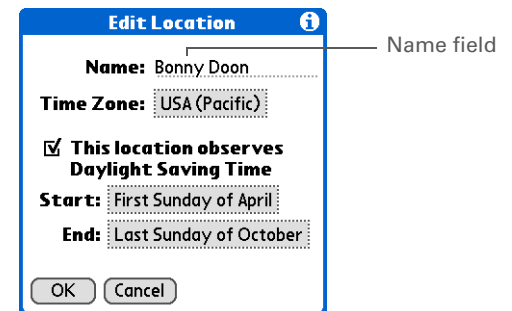

↘ Continued

**3**

Set the date:

- Tap the Set Date box.
- Tap the arrows to select the current year.
- Tap the current month.
- Tap the current date.

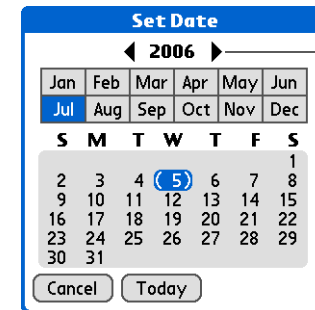
Year  
arrows**4**

Set the time:

- Tap the Set Time box.
- Tap the hour and minute boxes, and then tap the arrows to change them.
- Tap AM or PM, and then select OK.

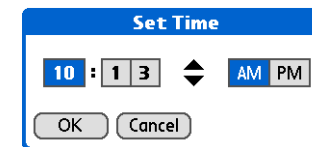
**5**

Select Done.

 Done

## Preventing your handheld from turning on by accident

Does your handheld turn itself on accidentally in your briefcase, pocket, or purse? You can lock the buttons on the front of your handheld so you prevent this from happening and don't drain the battery.

\* **Tip**  
When Keylock is on, your handheld does not respond when you press the buttons on the front of your handheld. To use your handheld again, slide the power button to the right and then tap Deactivate Keylock.

+ **Did You Know?**  
You can use **Owner Preferences** to enter your name, address, and phone number. If you also turn on **Security settings**, your Owner info appears when you turn on your handheld. This could help someone contact you if you ever lose your handheld.

### 1

Open Keylock Preferences:

- a. **Go to Applications.**
- b. Select Prefs .
- c. Select Keylock.

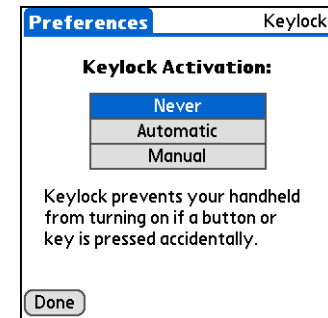

### 2

Select one of these settings, and then select Done.

**Never** Keylock always remains off.

**Automatic** Keylock turns on automatically when you turn off your handheld or when your handheld goes to sleep.

**Manual** Keylock turns on when you hold down the power button until the system sound confirms that Keylock is on.

↓ Done

## Changing the screen fonts

In many applications, you can change the font style to make text easier to read. There are four font styles available in applications that let you change the font style.

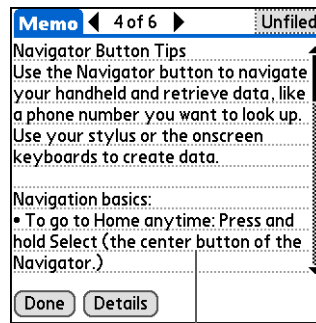

Small font

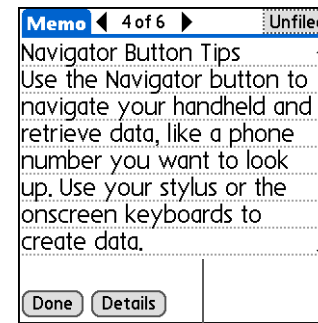

Large font

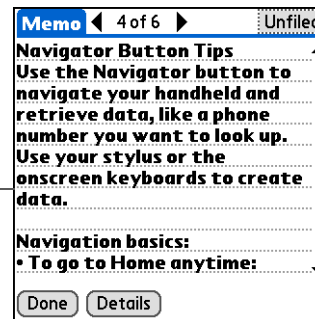

Small bold font

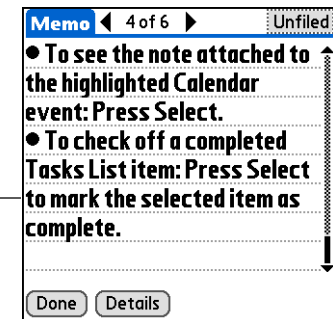

Large bold font



**1**

Open the Select Font dialog box:

- a. **Go to Applications.**
- b. **Open the menus** .
- c. Select Options, and then select Font.

**2**

Tap the font style you want to use, and then select OK.

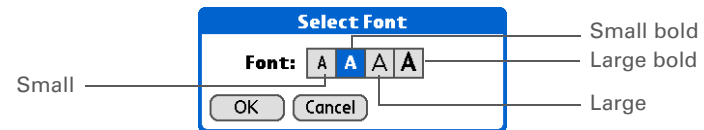





↓ Done

## Changing the background of your screen

Use your favorite photos as the background for the Favorites and Applications Views and the Agenda View in Calendar. Choose the same photo for all screens or make them different.

### 1

Open the Display Options dialog box:

- a. Tap Star  to open Favorites, or tap Home  to open Applications. Or, press the Calendar  button for Agenda View.
- b. **Open the menus** .
- c. Select Options, and then select Display Options. For Favorites, select Options, and then select Preferences.

### 2

Select a photo:

- a. Check the Background box.
- b. Tap the photo thumbnail and select a photo.
- c. Adjust the fade setting so that text and icons are easy to see against the photo.
- d. Select OK.

 Done

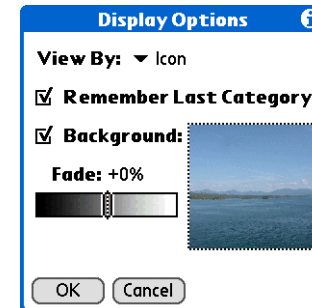

**NOTE** The screen for selecting a background photo appears differently in each of the three applications. The Applications Display Options screen is shown here.

## Correcting problems with tapping

Is your screen not responding to taps? Are you getting unexpected results when you tap? For example, when you tap the number keyboard icon, does the Find dialog box open instead? If this happens, it's time to align the screen.

» **Key Term**  
**Touchscreen** Another name for your handheld's screen and its internal circuitry.

\* **Tip**  
 If your screen is not responding to taps, use the 5-way navigator to open Touchscreen Preferences.

# 1

Open Touchscreen Preferences:

- a. **Go to Applications.**
- b. Select Prefs .
- c. Select Touchscreen.

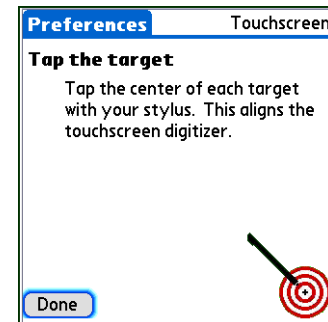

# 2

Tap the targets on the screen as precisely as possible, and then select Done.

**NOTE** You need to tap at least three targets—maybe more if you don't tap carefully.

↓ Done

## Selecting sound settings

Are sounds too soft or too loud? Set the volume levels for the system, game, and alarm tones, or turn sounds off altogether with the Silent profile.

\* **Tip**  
You can choose different types of sounds for Calendar, Tasks, and World Clock. Go to the application, open the Options menu, and then select Preferences.

+ **Did You Know?**  
When you connect headphones to your handheld, the external speaker is automatically silenced, the Sounds & Alerts settings are maintained, and all volume levels are automatically adjusted for use with headphones.

### 1

Open Sounds & Alerts Preferences:

- a. **Go to Applications.**
- b. Select Prefs .
- c. Select Sounds & Alerts.

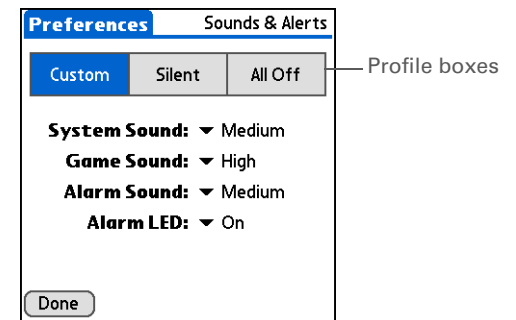

### 2

Select Custom, Silent, or All Off.

### 3

If you selected Silent or All Off in step 2, select Done.

If you selected Custom in step 2, tap the System Sound, Game Sound, and Alarm Sound pick lists and select the volume level for each sound; then select Done.

↓ Done



## Changing entries in Favorites

Change the entries in the Favorites View to include the applications or web links you use most often.

- + Did You Know?**  
 You can move a favorite to a different location on the Favorites list by opening the Favorite menu, and then selecting Rearrange Favorites. Drag the favorite you want to the new location.

### 1

Open the Edit Favorites dialog box:

- Tap Star  to open Favorites.
- Select the favorite you want to change.
- Open the menus** .
- Select Edit Favorites.

### 2

Change the favorite:

- Select the favorite type from the Type pick list: application or web link.

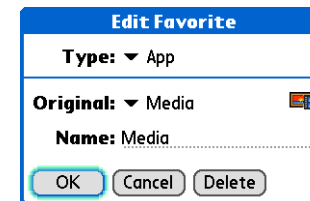

- Select the application from the Original pick list, or tap to enter the web address you want.
- Enter a name for your new favorite.
- Select OK.

 Done

**User Guide**

For everything you need to know about your handheld—all that's in this guide, and much more—go to [www.palmOne.com/tungstene2-handbook](http://www.palmOne.com/tungstene2-handbook).

**Support**

If you're having problems with customization or with anything else on your handheld, go to [www.palmOne.com/intl/support](http://www.palmOne.com/intl/support).

## Beyond the basics

Go to the *User Guide* on the web and learn about these related topics:

**Customizing**

- Setting power-saving features such as the auto-off interval
- Choosing formats for times, dates, calendar, and numbers based on a geographical region
- Selecting options for entering text, such as choosing how to enter certain Graffiti® 2 characters and using the full screen as the writing area
- Reassigning the buttons on the front of your handheld so that they open the applications you choose
- Protecting your information by turning on security options and entering information that identifies you as the owner of your handheld
- Configuring communication connections and network settings

# Common Questions

Although we can't anticipate all the questions you might have, this chapter provides answers to some of the most commonly asked questions.

## How do I upgrade from another Palm Powered™ device?

1. Synchronize your old handheld with your old desktop software.
2. Install the new Palm® Desktop software. There's no need to delete the old desktop software first.
3. Select the username you assigned to your old handheld during the desktop installation. This will transfer all your information from the old software to the new software.
4. Synchronize your new handheld with your new desktop software.
5. If any third-party applications do not transfer to your new handheld, reinstall them.
6. If you have problems with your third-party applications on your new handheld, you'll have to update them. If any of the following symptoms occur on your new handheld after you synchronize, remove the third-party applications and contact the vendor for updated versions:
  - Handheld freezes or resets when you open an application
  - Slow performance
  - Unusual screen display
  - Difficulties using handheld features
  - Uneven sound quality

### Why can't I find an icon in Applications View?

- Tap the category pick list in the upper-right corner of the Applications View screen and select All. You may need to scroll down a bit, but you should now see an icon for each of the applications on your handheld.
- Some of the applications that come with your handheld are not preinstalled. You need to **install these extra applications from your Tungsten™ E2 software installation CD.**

### How do I save my info?

Each time you complete an entry such as a contact, memo, or note, your handheld automatically saves the information you entered. You don't have to do anything special to save your info. To protect your info and create a backup of your info, we recommend that you synchronize your handheld with your computer often.

### How do I know when I need to recharge my handheld?

A battery icon  appears at the top of the Favorites and Applications screens. Check the gauge periodically to see if your handheld needs to be recharged. If the battery becomes low, a message appears on the screen prompting you to recharge the battery.

### Will I lose all my information if the battery becomes drained?

The memory on your handheld is designed to store your information even if the battery becomes drained to the point that you cannot turn on your handheld. When you recharge your handheld, all of your existing information should appear.



## How often should I recharge my handheld?

We recommend that you recharge your handheld for at least half an hour every day. Ideally, connect your handheld to a power source every night and recharge it while you sleep. Also, you can conserve battery life by doing any of the following:

- Reduce the **brightness** of the display.
- Reduce the **Auto-off after** setting.
- Use Keylock Preferences to **prevent your handheld from being turned on accidentally**.
- Minimize use of the expansion card slot.
- **Turn the Bluetooth® feature off** when you're not using it.

## What do I do if I can't synchronize with my computer?

Make sure the USB sync cable is connected securely.

\* **Tip**  
Need more help with synchronizing your handheld? Open Palm Desktop software, go to the Help menu, and then select HotSync Online Troubleshooting Guide.

### WINDOWS ONLY

- Click the HotSync Manager  icon in the Windows taskbar in the lower-right corner of your screen. Make sure Local USB has a checkmark next to it. If not, click it.



- If you don't see the HotSync Manager icon, click Start on the Windows taskbar, and then select Programs. Go to the Palm Desktop program group and select HotSync Manager. Click the HotSync Manager icon when it appears in the system tray. Make sure Local USB is selected.

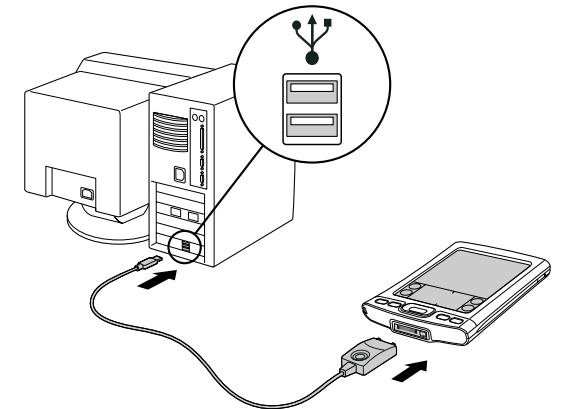

**MAC ONLY**

- Make sure HotSync Manager is enabled: Open the Palm folder and double-click the HotSync Manager icon. On the HotSync Controls tab, be sure Enabled is selected. If it is not, click it. On the Connection Settings tab, make sure USB has a checkmark next to it.
- Disconnect the USB sync cable from your computer, and then reconnect the cable and restart your computer.

**What do I do if my handheld doesn't respond to taps correctly?**

If your handheld is not responding to taps correctly, you need to **align the screen**.

**What do I do if my handheld is not responding?**

On rare occasions your handheld may not respond to tapping or pressing of buttons. If this happens, first check that **Keylock** is not turned on.

If Keylock is off and your handheld is still not responding, you need to reset your handheld. A soft reset tells your handheld to stop and start over again. This does not affect any of the information or applications on your handheld.

\* **Tip**  
After a soft reset, the Preferences screen appears with the Date & Time option highlighted so you can reset the date and time if necessary.

Use the tip of the stylus to gently press the reset button inside the hole on the back panel of your handheld.

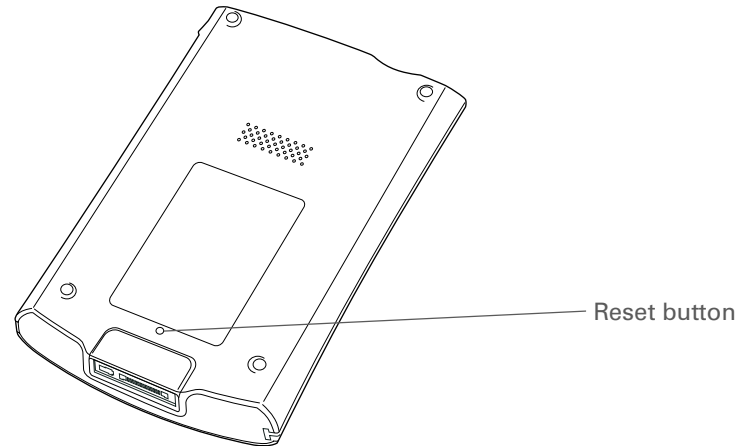

If a soft reset does not unfreeze your handheld, you need to **perform a hard reset**. For instructions see the *User Guide* on the web.

### Can I open my handheld?

No, do not open your handheld; there are no serviceable parts inside. Opening your handheld voids the warranty and is not recommended under any circumstances.

**User Guide**

For everything you need to know about your handheld—all that's in this guide, and much more—go to [www.palmOne.com/tungstene2-handbook](http://www.palmOne.com/tungstene2-handbook).

**Support**

If you're having problems with your handheld, go to [www.palmOne.com/intl/support](http://www.palmOne.com/intl/support).

## Beyond the basics

Go to the *User Guide* on the web and learn about these related topics:

**Common Questions**

- Troubleshooting software installation problems
- Solving problems with specific applications
- Troubleshooting synchronization problems
- Solving problems with beaming and communication settings

**Maintaining**

Performing a hard reset if a soft reset does not unfreeze your handheld

# Product Regulatory Information

## FCC Statement

This device complies with part 15 of the FCC rules. Operation is subject to the following two conditions: (1) This device may not cause harmful interference, and (2) this device must accept any interference received, including interference that may cause undesired operation.

This equipment has been tested and found to comply with the limits for a Class B digital device, pursuant to Part 15 of the FCC rules. These limits are designed to provide reasonable protection against harmful interference in a residential installation. This equipment generates, uses, and can radiate radio frequency energy and, if not installed and used in accordance with the instructions, may cause harmful interference to radio communications. However, there is no guarantee that interference will not occur in a particular installation. If this equipment does cause harmful interference to radio or television reception, which can be determined by turning the equipment off and on, the user is encouraged to try to correct the interference by one or more of the following measures:

- Reorient or relocate the receiving antenna.
- Increase the separation between the equipment and receiver.
- Connect the equipment into an outlet on a circuit different from that to which the receiver is connected.
- Consult the dealer or an experienced radio/TV technician for help.

The use of shielded I/O cables is required when connecting this equipment to any and all optional peripheral or host devices. Failure to do so may violate FCC rules.

**[ ! ] IMPORTANT** Changes or modifications not covered in this manual must be approved in writing by the manufacturer's Regulatory Engineering Department. Changes or modifications made without written approval may void the user's authority to operate this equipment.

In August 1996, the FCC of the United States with its action in Report and Order FCC 96-326 adopted an updated safety standard for human exposure to radio frequency electromagnetic energy emitted by FCC regulated transmitters. Those guidelines are consistent with the safety standard previously set by both U.S. and international standards bodies. The design of this product complies with the FCC guidelines and these international standards.

### Exposure to radio frequency energy (SAR)

In order to comply with FCC RF exposure safety guidelines, this device and its antenna must not be co-located or operating in conjunction with any other antenna or transmitter. The user of this device should ensure that the operation of this device is in compliance with these provisions.

FCC ID: O8FTUNGSTENE2

#### Responsible Party:

palmOne, Inc.  
400 N. McCarthy Blvd.  
Milpitas, California 95035  
United States of America  
(408) 503-7500



### Industry Canada

The term "IC:" before the certification/registration number only signifies that the Industry Canada technical specifications were met.

IC;3905A-TUNGSTENE2

### Canadian Wireless Regulatory Notice

This Class B digital apparatus meets all the requirements of the Canadian Interference Causing Equipment Regulations. Operation is subject to the following two conditions: a) this device may not cause any interference, and b) this device must accept any interference, including interference that may cause undesired operation of the device. To prevent radio interference to the licensed service, this device is intended to be operated indoors, and away from windows to prevent maximum shielding. Equipment (or its transmit antenna) that is installed outdoors is subject to licensing.



### CE Declaration of Conformity

**palmOne, Inc., Declares the Product:** Handheld PDA & HotSync® cable  
**Model Name/Number:** Tungsten E2  
**Manufacturer's Name:** palmOne

**Manufacturer's Address:** 400 N. McCarthy Blvd.  
Milpitas, 95035-5112

Meets the following European Council Directives:

- 89/336/EEC (EMC Directive)
- 99/5/EC (R&TTE Directive)
- 73/23/EEC (Low Voltage Directive).

Conforms with the following specifications:

- EN 55024: 1998 (Emissions & Immunity)
- EN55022:1998, CISPR 22 1997, Class B Radiated and Conducted Emissions
- IEC 61000-4-2, A1 1998-01, ESD Immunity, 4kV Contact, and 8kV Air Discharge
- IEC 61000-4-3: 1995 RF Immunity, 80-1000MHz, 3V/M, 1kHz, 80% A.M.
- ENV 50204:1996, RF Immunity, 895-905MHz, 3V/m, 200Hz, 50% AM
- IEC 61000-4-4: 1995 EFT Immunity, 1kV on AC port, 5/50nSec, 5kHs Rep. Freq.
- IEC 61000-4-5: 1995 Surge Immunity, 1.2/50uSec, 2kV(peak), Common Mode, 1kV(peak) Differential Mode
- EN61000-4-6:1996, Conducted Immunity, 150kHz-80MHz, 3V RMS, 1kHz, 80% AM
- IEC 61000-4-11: 1994, 100% Voltage Dip 0.5 period, 30% Dip 25 periods and >100% Dip 250 periods

**Authorized palmOne Representative:** David Waitt  
palmOne Compliance Engineer

**Date:** April 18, 2005

## Battery Warning

Do not mutilate, puncture, or dispose of batteries in fire. The batteries can burst or explode, releasing hazardous chemicals. Discard used batteries according to the manufacturer's instructions and in accordance with your local regulations.

### Warning

Eksplotionsfara vid felaktigt batteribyte. Använd samma batterityp eller en ekvivalent typ som rekommenderas av apparattillverkaren. Kassera använt batteri enligt fabrikantens instruktion.

### **Advarsel!**

Lithiumbatteri—Eksplodingsfare ved fejlagtig håndtering. Udskiftning må kun ske med batteri af samme fabrikat og type. Levér det brugte batteri tilbage tilleverandøren.

### **Varoitus**

Paristo voi räjähtää, jos se on virheellisesti asennettu. Vaihda paristo ainoastaan valmistajan suosittelemaan tyyppiin. Hävitä käytetty paristo valmistajan ohjeiden mukaisesti.

### **Advarsel**

Eksplodingsfare ved feilaktig skifte av batteri. Benytt samme batteritype eller en tilsvarende type anbefalt av apparatfabrikanten. Brukte batterier kasseres i henhold til fabrikantens instruksjoner.

### **Waarschuwing!**

Bij dit produkt zijn batterijen geleverd. Wanneer deze leeg zijn, moet u ze niet weggooien maar inleveren als KCA.

### **Uwaga**

Nie kroić lub przekłuwać baterii, ani nie wrzucać ich do ognia. Mogą się rozerwać lub wybuchnąć wydzielając trujące środki chemiczne. Zużytych baterii należy pozbywać się w sposób opisany przez producenta i zgodnie z miejscowymi przepisami.

אזהרה

יש סכנת התפוצצות אם מחליפים את הסוללה בצורה לא נכונה.  
יש להחליף את הסוללה בסוללה זהה או דומה, בהתאם להמלצת היצרן.  
יש להשליך סוללות משומשות בהתאם להוראות היצרן

## **Intrinsic Safety Warning**

### **Warning – Explosion Hazard**

- Substitution of components may impair suitability for Class I, Division 2;
- When in hazardous location, turn off power before replacing or wiring modules, and,
- Do not disconnect equipment unless power has been switched off or the area is known to be non-hazardous.

## **Wireless Notices— Usage Cautions**

In some situations, the user of the wireless device may be restricted. Such restrictions may apply aboard an airplane, in hospitals, near explosive environment, in hazardous locations etc. If you are not certain of the policy that applies to the use of this device, please ask for authorization prior to turning on the device.



## Static Electricity, ESD, and Your palmOne™ Handheld

Electrostatic discharge (ESD) can cause damage to electronic devices if discharged into the device, so you should take steps to avoid such an occurrence.

### Description of ESD

Static electricity is an electrical charge caused by the buildup of excess electrons on the surface of a material. To most people, static electricity and ESD are nothing more than annoyances. For example, after walking over a carpet while scuffing your feet, building up electrons on your body, you may get a shock -- the discharge event -- when you touch a metal doorknob. This little shock discharges the built-up static electricity.

### ESD-susceptible equipment

Even a small amount of ESD can harm circuitry, so when working with electronic devices, take measures to help protect your electronic devices, including your palmOne™ handheld, from ESD harm. While palmOne has built protections against ESD into its products, ESD unfortunately exists and, unless neutralized, could build up to levels that could harm your equipment. Any electronic device that contains an external entry point for plugging in anything from cables to docking stations is susceptible to entry of ESD. Devices that you carry with you, such as your handheld, build up ESD in a unique way because the static electricity that may have built up on your body is automatically passed to the device. Then, when the device is connected to another device such as a docking station, a discharge event can occur.

### Precautions against ESD

Make sure to discharge any built-up static electricity from yourself and your electronic devices *before* touching an electronic device or connecting one device to another. The recommendation from palmOne is that you take this precaution before connecting your handheld to your computer, placing the handheld in a cradle, or connecting it to any other device. You can do this in many ways, including the following:

- Ground yourself when you're holding your mobile device by simultaneously touching a metal surface that is at earth ground.
- For example, if your computer has a metal case and is plugged into a standard three-prong grounded outlet, touching the case should discharge the ESD on your body.
- Increase the relative humidity of your environment.
- Install ESD-specific prevention items, such as grounding mats.

### Conditions that enhance ESD occurrences

Conditions that can contribute to the buildup of static electricity in the environment include the following:

- Low relative humidity.

- Material type (The type of material gathering the charge. For example, synthetics are more prone to static buildup than natural fibers like cotton.)
- The rapidity with which you touch, connect or disconnect electronic devices.

While you should always take appropriate precautions to discharge static electricity, if you are in an environment where you notice ESD events, you may want to take extra precautions to protect your electronic equipment against ESD.

**SYMBOLS**

- \* (asterisk) characters 33
- ; (semicolon) characters 105

**NUMERICs**

- 5-way navigator 2, 11, 12, 14–16

**A**

- AC charger 4
- accessing
  - applications 127
  - email account 8
  - email accounts 84, 86, 90
  - information 12
  - web pages 98, 99
  - websites 80, 86, 97
- accessories 111
- Account Setup screen 101
- Accounts command 104
- adding
  - applications 26, 27, 31
  - contacts 33, 35
  - email messages 105
  - events 39
  - expansion cards 111
  - memos 71, 72, 73
  - notes 76
  - reminders 34, 75
  - tasks 66, 67
- Addit software 9
- Additional Software option 7
- add-on applications 27, 126
- addresses. *See* contacts
- addressing
  - email 37, 105

- text messages 94
- adjusting speaker volume 123
- Adobe Acrobat Reader 9
- agenda lists. *See* Calendar application
- Agenda View (Calendar) 41
- alarm clock 42
- Alarm Sound pick list 123
- alarms
  - See also* reminders
  - adjusting volume for 123
  - attaching to notes 76
  - customizing 43
  - incoming messages and 96
  - selecting sounds for 42, 70
  - setting 42, 67, 70, 78
- albums
  - additional information for 54
  - creating 51
  - moving photos in 52
  - selecting 52
- alerts. *See* alarms
- aligning screen 122
- anniversaries 40
- application buttons, location of 2
- application icons 127
- applications
  - accessing 127
  - adding contact information to 35
  - additional information for 24, 114
  - copying 114
  - deleting 24, 114
  - displaying list of 5
  - exchanging 24, 114
  - installing 7, 26, 27, 31
  - opening 10, 125

- preinstalled 5
  - setting local preferences for 116
  - soft resets and 129
  - storing on expansion cards 114
  - transferring information from 27
  - transferring third-party 126
  - transferring to handheld 7
  - troubleshooting 127, 131
- Applications View
  - adding background to 121
  - displaying application list for 5
  - displaying icons in 127
  - moving around in 13
  - opening applications in 11
  - using 11
  - using the 5-way 13
- appointments
  - See also* Calendar application; events
  - adding notes to 43
  - checking 41
  - color-coding 40, 43
  - combining tasks with 38
  - creating recurring 43
  - deleting 43
  - filing 40
  - repeating 42
  - scheduling 39–40
  - setting duration of 40
- ASF media files 49
- asterisk (\*) characters 33
- attachments
  - adding 108
  - downloading 106
  - sending events as 37, 43
  - sending files as 108

- sending memos as 74
- sending multimedia files as 54
- sending notes as 78
- sending tasks as 70
- Attachments screen 108
- Audible Player software 8
- audio
  - applications 3
  - files 56–58
- auto-off interval 125, 128

## **B**

- back panel controls 4
- backgrounds
  - changing 76
  - customizing 121
- backing up information. *See* synchronizing
- battery
  - cautions for 134
  - charging 23, 127
  - conserving power for 118
  - extending life of 115, 128
- battery icon 127
- Beam Category command 67
- Beam Contact command 36
- Beam Item command 67
- Beam Status dialog box 36
- beaming 3, 24, 36, 131
- birthdays 34
- Blazer application. *See* web browser
- blinking cursor 18
- Bluetooth
  - Access Points 92
  - icon 5
  - LAN Access Points 80

- radio 4
- Bluetooth application
  - additional information for 92
  - computer setup options for 88
  - features 80
  - opening 81, 82, 86, 88
  - setting connection information 81
  - setting up connections 82–85
- Bluetooth devices
  - built-in software for 5
  - connecting to 80
  - sending applications to 24, 114
  - sending entries to 24, 114
  - sending events to 43
  - sending memos to 74
  - sending notes to 78
  - sending task entries to 70
  - setting up 81
  - synchronizing with 31
  - turning off 128
  - verifying status of 86
- Bluetooth™ technology 79, 80
- BMP files 49
- bold fonts 120
- bookmarks 99
- brightness control 2
- Brightness icon 2
- browsing the web 5, 86, 97
- built-in applications 5
- Business Card command 36
- business cards 36
- buttons
  - activating 15
  - back panel 4
  - locking 118

- navigator 12
- reassigning application 125
- selecting dialog box 15

## **C**

- calculator 9
- Calculator icon 6
- calendar
  - color-coding appointments 40, 43
  - formatting 125
  - selecting dates on 67
- Calendar application
  - additional information for 43
  - benefits of 38
  - checking schedules in 41
  - customizing 121
  - entering birthdays for 34
  - opening 5, 39
  - scheduling appointments in 39–40
  - setting alarms 42
- Calendar icon 5
- calendar views 41
- calibration 122
- canceled actions 15
- capitalization 72
- Card Info application 6, 114
- card readers 56, 58
- categorizing
  - contacts 37
  - events 43
  - information 24, 40
  - memos 74
  - notes in Note Pad 78
  - tasks 68
- CDs 59

- changing
  - backgrounds 76
  - email accounts 109
  - fonts 119–120
  - memos 73
- character entry 98
  - Contacts 33
  - Graffiti 2 17
  - keyboards 19
  - options 125
- charging battery 23, 127
- check boxes, using the 5-way 15
- checking for email 104
- Choose Date command 67
- choosing
  - menu commands 16
  - options in dialog boxes 15
- cleaning your handheld 23
- clock 2, 116–117
- Clock icon 2
- Color Theme Preferences screen 124
- color-coding
  - appointments 40, 43
  - messages 109
- colors, applying to notes 76
- commands
  - See also* menus
  - moving around 16
  - using 22
- communication settings 131
- compact discs 59
- completed tasks 69
- computers
  - connecting to 80
  - preinstalled software for 7
  - synchronizing handheld with 88
  - troubleshooting synchronization problems 128
- conduit 27
- configuring connections 125
- confirmation tones 113
- conformity declaration 133
- connecting
  - to AC charger 4
  - to Bluetooth devices 80, 81
  - to mobile phones 87
  - to other devices 79
  - to personal computers 80
  - to the Internet 80
- connection types 80
- connections
  - additional information for 92
  - configuring 125
  - customizing 96, 99
  - omitting passkeys for 84
  - precautions for 23, 136
  - setting preferences for 109
  - setting up phone 82–85
  - setting up wireless 79, 88
  - troubleshooting 131
  - unable to establish 81
- conserving power 118
- contacting ISPs 85
- contacts
  - See also* Contacts application
  - adding 33, 35
  - beaming 36
  - categorizing 37
  - copying information for 34
  - deleting 37
  - entering in memos 72
  - keeping private 37
  - locating 35
  - managing 32
  - saving 34
- Contacts application
  - adding contact information 33–34
  - additional information for 37
  - benefits of 32
  - customizing 37
  - opening 5, 33
  - saving information in 34
  - searching from 35
- Contacts icon 5
- continuous events. *See* repeating events
- copying
  - applications 114
  - contacts 34
  - photos 54
  - videos 54
- corporate email accounts 109
- creating
  - appointments 39
  - contacts 33, 35, 36
  - email messages 105
  - memos 71, 72, 73
  - MP3 files 59
  - notes 76
  - photo albums 51
  - recurring events 42, 43
  - reminders 34, 75
  - song lists 60, 65
  - tasks 66, 67
- current date and time 116
- cursor 18

customer support 24, 47, 65, 109

customizing

alarms 43

backgrounds 121

connections 96, 99

Contact application 37

handheld 115, 125

Inbox 109

cutting and pasting 74

## D

data entry 2, 3, 18, 24, 125

Date & Time Preferences screen 116

dates

*See also* calendar

assigning to appointments 39

defining start and end times for 43

formatting 125

scheduling reminders for 34

selecting on calendar 67

setting 116–117

setting due 67

sorting by 77

Day View (Calendar) 39, 41

Day View icon 39

Deactivate Keyguard button 118

defaults 27, 43

deleting

*See also* removing

applications 24, 114

appointments 43

contacts 37

email accounts 109

files 114

memos 74

messages 96

photos 37, 52, 54

songs 65

videos 54

description fields 39

desktop software, installing 7

Device name field 81

dialing phone numbers 84

dialog boxes, using the 5-way 15

dial-up accounts 85, 87

Digitizer Preferences screen 122

Discoverable setting 81

display brightness 2, 128

Display icon 2

display options

*See also* preferences

Calendar 43

Favorites 121

VersaMail 109

Display Options command 121

displaying

application icons 127

current time and date 2

images 49

items in lists 13, 15

memos 73

notes 77

PDF files 9

personal calendars 38

photos 49, 54

schedules 41

tasks 68, 70

videos 54

web pages 98

do's and don'ts 23

documentation 8, 24

Documents application

creating files 45

editing files 45

opening files 46

viewing files 45

Documents To Go application 5, 26, 45

download options 107

downloading

attachments 106

email 104

files 99

drawing freehand 75

droplets 58

due dates 67

dummy expansion card 112

## E

eBooks 9

Edit Categories command 68

editing 77

*See also* changing

memo 73

note 76

VersaMail 109

electrostatic discharge 136–137

email

*See also* email accounts

accessing 8, 84, 86, 90

adding attachments to 108

additional information for 109

addressing 37, 105

attaching events to 37, 43

attaching memos to 74

attaching notes to 78

- attaching photos to 54
- attaching tasks to 70
- automatically checking for 104
- automatically retrieving 109
- changing maximum size 104
- composing 105
- deleting accounts for 109
- downloading 104
- downloading attachments 106
- receiving 86, 92, 102
- sending 86, 92, 102, 105
- setting preferences for 109
- synchronizing 102, 104, 109

email providers. *See* ISP

enhancing photos and videos 54

entering

- information 3, 17–21, 24, 125
- passwords 85, 102
- URLs 98

entries

- moving around in 15
- sorting 37, 74, 78

entry screens 14, 15

eraser 76

ESD (electrostatic discharge) 136–137

Essential Software option 7

Event Details dialog box 42

events

- See also* appointments
- adding notes for 43
- categorizing 43
- contact information and 34
- creating recurring 42, 43
- defined 39
- entering 40

- setting alarms for 42
- sharing 43

Excel

- creating and viewing files 45
- files 26, 100
- on handheld 5

exchanging

- applications 24, 114
- event entries 43
- expansion cards 114
- files 80
- information 3, 24
- memos 74
- notes from Note Pad 78
- task entries 70

expansion card slot 3, 128

expansion cards

- adding applications to 7, 114
- additional information for 114
- benefits of 111
- deleting applications from 114
- deleting songs on 65
- displaying contents of 114
- dummy card 112
- inserting 3, 113
- naming 114
- overview 110
- preventing damage to 112
- removing 112
- saving multimedia files on 49, 54
- transferring audio files to 56–63
- types of 111

Expense icon 6

## F

fade setting 121

FAQs 126

Favorites View

- adding background to 121
- changing entries 124
- defined 5
- moving around 12
- using 10
- using the 5-way 12

FCC Statement 132

features of handheld 1

file linking 31

file transfers 99

file types 49, 56

files

- attaching to email 108
- deleting 114
- removing from expansion cards 114
- sharing 80
- transferring to handheld 100

filing appointments 40

finding contacts 35

font styles 119, 120

fonts

- changing 119–120
- customizing email 109

formats

- audio files 55
- multimedia file types 49
- setting 125

formatting information 125

freehand drawing 75

frequently asked questions 126

frozen screen 4, 129, 131

full-screen writing 76

## G

Game Sound pick list 123

games 123

General Packet Radio Service (GPRS) 85

Get Mail Options dialog box 104

getting started 8

Getting Started Guide 8

Go To Date dialog box 39

going online 80

GPRS mobile phones 82, 85

Graffiti 2 writing 17, 24, 125

GSM mobile phones 82

## H

handheld

adding applications to 24, 126

additional information for 24, 65, 131

connecting to AC charger 4

controls described 2–4

copying applications on 114

customizing 115, 125

do's and don'ts 23

ESD and 136

losing 118

naming 81

not responding 118, 129, 131

opening 130

preinstalled applications on 5

protecting 84, 125

recharging 23, 127

removing applications from 24

resetting 4

restarting 129, 131

running out of space on 111

synchronizing 31, 126, 127, 128

synchronizing wirelessly 80

troubleshooting 122, 126, 131

turning on and off 3, 118

upgrading 126

hard resets 130, 131

headphone jack 3

headphones 123

headsets 3, 23

help 24

Help menu 128

highlighting menu commands. *See* selection highlight

high-speed

connections 87

wireless carrier 80

holidays 40

home page 99

Home screen *See* Applications View

HotSync

icon 6

technology 28

HotSync Manager 88, 128

HotSync Online Troubleshooting Guide 128

## I

icons 127

image files 49

IMAP protocol 101

IMAP servers 102

importing contact information 37

Inbox 109

incoming mail servers 102

incoming messages 96

information

accessing 12

backing up 7, 26, 111

categorizing 24, 40

entering 3, 17–21, 24, 125

formatting 125

losing 15, 129

managing 7

owner 118

receiving from outside sources 31

saving 127

security options for 125

sharing 3, 24, 34, 71, 114

synchronizing 25–28

transferring to CPU 27

updating 25, 26

infrared port. *See* IR port

input area 2

inserting expansion cards 3, 113

installation CD 7

installing

additional software 7

applications 7, 26, 27, 31

Palm Desktop software 7

third-party applications 126

VersaMail software 101

Int'l button 19

international keyboard 19

Internet

*See also* websites

accessing 80

Bluetooth 85

browsing 80

connecting to 80

selecting service provider for 87



- using web 97
- Internet Message Access Protocol (IMAP) 101
- Internet Service Provider 80, 102
- IR port
  - See also* beaming
  - beaming 36
  - Bluetooth phone 92
  - location 3

## J

- JPG files 49

## K

- keyboard
  - connecting to portable 73
  - entering information from 18
  - opening additional 19
- Keyguard 118
- Keyguard Preferences screen 118
- Keylock 128

## L

- laptops 80
- Large bold icon 120
- Large font icon 120
- letter keyboard 18
- linking to outside sources 31
- list screens 13
- listening to music 55, 56, 64, 110
- lists
  - additional information for 54
  - moving around items in 13
- local settings 116, 125
- locating contacts 35

- Location pick list 116
- locking handheld buttons 118
- Look Up line (Contacts) 35
- losing handheld 118
- losing information 15, 26, 129
- Lotus Notes 102
- low battery 127

## M

- Mac information
  - displaying videos 49
  - installing extra software from CD 7
  - Send To Handheld droplet 30
  - Send to Handheld droplet 58
  - synchronizing handheld 129
  - transferring MP3 files to handheld 58
- mail servers 102
- Mail Service pick list 102
- Media application
  - adding photo to contact 34
  - additional information for 54
  - annotating photos 53
  - backing up information in 7
  - benefits of 48
  - displaying multimedia files 51
  - displaying photos or videos 50
  - opening 50
  - overview 48
- Media icon 5
- memory cards 55
- Memos
  - icon 5
  - list 72, 73
- memos
  - See also* notes; Memos application

- adding contact information to 35, 72
- backing up 7
- categorizing 74
- creating 71, 72, 73
- deleting 74
- displaying 73
- editing 73
- exchanging 74
- keeping private 74
- saving 72
- sending as attachments 74
- synchronizing 74
- Memos application
  - additional information for 74
  - changing memos in 73
  - opening 72
  - overview 71
  - selecting memos 73
  - writing memos with 72
- menu bar 22
- menus 16, 22
- message summary view 109
- messages
  - See also* email; text messages
  - automatically resending 105, 109
  - color-coding 109
  - connection types for 80
  - deleting 96
  - receiving 53, 80, 94, 96
  - replying to 96
  - synchronizing 102, 104, 109
- Messages option 104
- Microsoft Outlook
  - applications that synchronize 27
  - synchronize with 20, 31

Microsoft Word  
documents 26, 100  
files 5  
Mini-USB connector icon 4  
missing applications 5  
mobile phones  
accessing Internet with 80  
compatibility 83  
connecting to 80, 87  
connecting to Internet from 87  
setting up connection 82  
Month View (Calendar) 41  
moving around in dialog boxes 15  
moving photos 52  
MP3  
files 55, 56–58  
players 55  
multiline descriptions 39  
multimedia file types 49  
MultiMediaCard expansion cards  
*See also* expansion cards  
music 55  
types 111  
multiple email recipients 105  
music  
creating song lists for 60  
listening to 55, 56, 110  
playing 64  
storing 111  
Music application 65  
music files  
*See also* sound files  
expansion card 60  
saving 55

## N

names *See* usernames; contacts  
naming  
email accounts 101  
handheld 81  
photo albums 51  
naming expansion cards 114  
navigator 2, 12, 14–16  
network connections  
additional information for 92  
setting preferences for 96, 99, 109  
setting up 84, 125  
networks  
accessing email from 80  
Bluetooth 31  
new lines 72  
Note Pad  
*See also* notes  
additional information for 78  
backing up information in 7  
creating notes from 76  
displaying notes in 77  
opening 76  
overview 75  
setting preferences for 76  
Note Pad icon 5  
notes  
*See also* memos; Note Pad  
adding to events 43  
adding to tasks 70  
attaching alarms to 78  
attaching to email 78  
backing up 7  
creating 76  
editing 76, 77

keeping private 78  
organizing 78  
saving 76  
selecting 77  
setting alarms for 76  
sharing 78  
sorting 77  
number keyboard 18  
numbers 17, 19, 125  
**O**  
Office files 44–??  
omitting passkeys 84  
online documentation 24, 114  
Online Troubleshooting Guide 128  
onscreen keyboard. *See* keyboard  
Open URL  
dialog box 98  
icon 98  
opening  
alternative keyboards 19  
applications 10, 125  
dialog boxes 15  
handheld 130  
handheld menus 22  
HotSync Manager 88  
Note Pad 76  
onscreen keyboards 18  
photo albums 52  
RealPlayer 8  
text messages 95  
outgoing mail servers 102  
Outlook  
marking completed tasks and 69  
synchronizing with 102

Outlook Express 102  
overdue tasks 68  
owner information 118, 125  
Owner Preferences screen 118

## P

Palm Desktop software  
  applications 20  
  completing repeated tasks and 69  
  described 7  
  installing 7  
  synchronize 26  
  upgrade 126  
Palm OS handhelds  
  beaming to 24, 43, 114  
  exchanging memos with 74  
  sharing notes with 78  
  sharing tasks with 70  
Palm Reader 9  
paper clip icon 106, 107  
passkeys 84, 90  
Password check box 102  
passwords  
  Bluetooth 84, 85, 90  
  entering 102  
pasting text 74  
PC Setup screen 88  
PCs *See* personal computers  
PDF files 9  
pen 76  
Pen selector 76  
pen widths 76  
performance 23  
personal calculator 9  
personal computers  
  connecting to 80  
  entering information with 20  
  preinstalled software for 7  
  synchronizing handheld with 25, 27  
  troubleshooting synchronization 128  
phone calls 37  
phone connections 82–85  
Phone Lookup 35  
phone numbers  
  Contacts 37  
  dialing 84  
  getting from contacts 35  
  temporary storage for 75  
photo albums  
  additional information for 54  
  creating 51  
  moving photos in 52  
  selecting 52  
photos  
  adding to albums 52  
  adding to contacts 34  
  copying 54  
  deleting 37, 52  
  displaying 54  
  emailing 54  
  moving 52  
  saving 49  
  selecting as backgrounds 121  
  sharing 29  
  storing 111  
pick lists, using the 5-way 15  
Picture box 34  
playing music 55, 56, 64  
playlists 60, 65  
POP protocol. *See* Post Office Protocol  
  (POP)  
POP servers. *See* Post Office Protocol (POP)  
portable keyboards 73  
Post Office Protocol (POP) 101, 102  
power adapter 23  
Power button 3  
PowerPoint files, creating and viewing 45  
power-saving features 125  
precautions 136  
preferences  
  additional information for 125  
  overview 115  
  setting connection 109  
  setting email 109  
  setting locale-specific 116  
  setting network connection 96, 99  
  setting text messaging 96  
Prefs icon 6  
preinstalled applications 5  
prioritizing tasks 67  
privacy settings  
  calendar 43  
  contacts 37  
  handheld 24  
  memos 74  
  notes 78  
  tasks 70  
programs. *See* software; applications  
protecting  
  information 111  
  your handheld 24, 125  
protecting your handheld 24  
protocol (defined) 101  
Protocol pick list 102  
purging old appointments 43

## Q

questions and answers 126  
Quick Connect option 37  
Quick Install software  
    installation 7  
    using 29  
Quick Look Up icon 35  
Quick Look Up line 35  
Quick Tour 6, 17

## R

radio 4  
reading text messages 95  
RealPlayer  
    compatible formats for 56  
    converting songs on CDs 59  
    getting help with 61, 64, 65  
    icon 8  
    opening 8  
    overview 55  
reassigning quick buttons 125  
reboots 129, 131  
receiving email 86, 92, 102  
receiving messages 53, 80, 94, 96  
recharging handheld 23, 127  
records  
    defined 18  
    moving between 14  
recurring events 42, 43  
recurring tasks 70  
refreshing web pages 99  
reminders  
    creating 75  
    entering 40  
    scheduling 34

    setting alarms for 70, 76, 78  
removing  
    *See also* deleting  
    expansion cards 112  
    selection highlight 12  
repeating events 42, 43  
repeating tasks 69, 70  
replying to text messages 96  
resending messages 105, 109  
reserving blocks of time 43  
reset button 4, 130  
resetting local settings 116  
resizing text 73  
restarting handheld 129, 131  
running out of space 111

## S

saving  
    attachments 106  
    contacts 34  
    information 127  
    memos 72  
    music files 55, 60  
    notes 76  
    photos 49  
    tasks 67  
schedules. *See* appointments; calendar  
scheduling  
    appointments 39–40  
    conflicts 38  
    reminders 34  
screen  
    adjusting brightness 2, 128  
    aligning 122  
    caring for 23

    changing colors of 124  
    changing fonts for 119, 120  
    described 2  
    frozen 4, 129, 131  
    not responding 4  
scrolling 13, 15, 16, 39  
SD memory cards 55, 111  
SDIO accessories 111  
SDIO cards 111  
searching for information 35  
Secure Digital input/output (SDIO) 111  
security options  
    calendar 43  
    contacts 37  
    handheld 24, 84, 125  
    memos 74  
    notes 78  
    tasks 70  
Security settings 118  
Select a Color Theme dialog box 124  
Select button (navigator) 16  
Select Font dialog box 120  
Select User dialog box 28  
selecting  
    menu commands 16  
    options in dialog boxes 15  
selection highlight 12, 13, 16  
semicolon (;) characters 105  
Send To Handheld droplet 8, 29  
Send to Handheld droplet 58  
sending  
    email 86, 92, 102, 105  
    text messages 80, 84, 93, 94  
service (defined) 87  
Service pick list 87

- services 87
- Set Date dialog box 117
- Set Time dialog box 40, 117
- setting alarms 42, 67, 70, 78
- setting up wireless connections 79
- settings
  - See also* preferences
  - menus 22
  - synchronizing 27
- sharing
  - files 80
  - information 34, 71
  - photos 29
- sharing information 3, 24, 114
- Short Message Service. *See* SMS application
- short messages 93
- Silent profile 123
- sketching 75
- slide shows 50, 54
- Small bold icon 120
- Small font icon 120
- SMS application
  - additional information for 96
  - benefits of 93
  - installing 5
  - messages 94
  - messaging 5
  - opening 94, 95
  - sending text messages 94
- SMTP servers 102
- soft resets 129
- software
  - installing 7
  - troubleshooting 131

- Solitaire 9
- song
  - deleting 65
  - expansion card 111
  - formats 55
  - lists 60
  - playing 64
- song files *See* music files; sound files
- song lists 65
- Sort by pick list 77
- sorting
  - information 37, 74, 78
  - notes 77
- sound files. *See* audio files; music files
- sounds 123
- Sounds & Alerts screen 123
- speaker 4, 123
- special characters 17, 19
- specifications 134
- spreadsheets
  - See also* Excel files
  - creating and viewing 45
  - Excel 100
  - on handheld 5
- static electricity 23, 136–137
- stopping MP3 player 64
- stopping slide shows 50
- storage 110, 111
- stylus 3, 23
- Subject fields 105
- subject lines (email) 105
- Subjects Only option 104
- supported file types 49, 56
- symbols 17, 19, 33
- Synchronize Only Account check box 102,

- 104
- synchronizing
  - backing up information 7, 26, 111
  - email 102
  - handheld 126, 127, 128
  - information 20, 25–28
  - messages 102, 104, 109
  - problems 131
  - software 27
  - wirelessly 31, 80, 88
  - with Microsoft Outlook 102
- system information 27
- System Sound pick list 123

## T

- tapping 122, 129
- Task Preferences settings 70
- tasks
  - adding contact information to 35
  - adding notes to 70
  - assigning due dates to 67
  - attaching to email 70
  - categorizing 68
  - combining with appointments 38
  - completing 69
  - creating 67
  - defining recurring 70
  - displaying 68, 70
  - managing 66
  - organizing 68
  - prioritizing 67
  - saving 67
  - setting alarms for 67, 70
  - sharing 70
- Tasks application

- adding tasks 67
- additional information for 70
- icon 5
- list 68
- marking completed tasks 69
- opening 67
- overview 66
- saving information in 67
- securing contents 70
- setting display options for 68
- technical assistance 24, 47, 65, 109
- telephone numbers. *See* phone numbers
- text
  - adjusting fade setting for 121
  - changing fonts for 119
  - cutting and pasting 74
  - entering 17, 19, 125
  - resizing 73
- text messages
  - additional information for 37
  - creating 37
  - deleting 96
  - managing 5
  - opening 95
  - sending 80, 84, 93, 94
  - setting preferences for 96
  - viewing 95
- third-party applications 126
- thumbnails 54
- TIFF files 49
- time
  - formatting 125
  - reserving blocks of 43
  - scheduling 40
  - setting 42, 116–117

- To Do lists. *See* tasks
- touchscreen
  - aligning screen 122
  - defined 122
- tracking completion dates 70
- transferring
  - applications 7
  - wirelessly 80
- transferring files 100
- transferring information 27
- troubleshooting 122, 126, 131
- trusted pairs 80, 84
- turning handheld on and off 3, 118
- Tutorial 9

**U**

- uniform resource locators (URLs) 98
- unread mail 109
- untimed events 34, 40
- updating information 25, 26
- upgrading 126
- URLs 98
- USB sync cable 28
- User Guide 24
- usernames
  - Bluetooth 85
  - finding in email addresses 102
  - multiple users 27
  - synchronize 28

**V**

- VersaMail application
  - adding attachments 108
  - additional information for 109
  - benefits of 100

- downloading attachments 106
- getting email 104
- opening 101
- sending email 105
- setting up email accounts 101–103
- software 8
- videos
  - copying 54
  - deleting 54
  - displaying 54
- view formats 43
- viewing
  - application icons 127
  - current time and date 2
  - images 49
  - items in lists 13, 15
  - memos 73
  - notes 77
  - PDF files 9
  - personal calendars 38
  - photos 49, 54
  - schedules 41
  - tasks 68, 70
  - videos 54
  - web pages 98
- views in Calendar 41
- virtual private networks 9, 109
- volume 123
- VPN Link 9

**W**

- warnings 134
- warranty 130
- web addresses 98
- web browser

additional information for 99  
displaying web pages 98  
overview 97  
web pages 98, 99  
websites  
    accessing 80, 86, 97  
    adding bookmarks for 99  
    browsing 5, 86  
    downloading files 99  
    navigating 98  
Week View (Calendar) 41  
Windows information  
    displaying videos 49  
    installing handheld software 7  
Windows Media Player 8  
wireless  
    carriers 80  
    connections 79, 80, 88, 94  
    email accounts 102  
    features 86  
    synchronization 31, 80, 88  
Word files  
    creating and viewing 45  
    on handheld 5  
    synchronizing 26  
    VersaMail 100  
World Clock  
    icon 6  
    setting alarm 42  
World Wide Web. *See* web pages; websites  
writing area 2, 125  
writing in your own handwriting 75  
writing tool 23

## Y

Year View 41