

# Read This First

Operating Instructions

**1** Setting up your  
CLIÉ™ handheld

**2** Basic operations of  
your CLIÉ™ handheld

**3** Supplied  
applications

**4** Using CLIÉ Manuals  
with your computer

Troubleshooting

CLIÉ™ handheld  
components

**Personal Entertainment Organizer  
PEG-TH55**

**CLIÉ™**

© 2004 Sony Corporation

For help, you can  
refer to **CLIE FAQ** on  
your CLIÉ handheld.



MEMORY STICK

The following manuals are included with your CLIÉ handheld.

### Printed manual

#### **Read This First (Operating Instructions), this manual\***

Explains how to set up your CLIÉ handheld and computer, and basic operations.

**For safe use, make sure you read the supplied “Safety & Regulations Guide”.**

\* If your CLIÉ handheld was purchased in Europe, the manual is not in printed format, but is included as a PDF file on the Installation CD-ROM.

#### **Internet Connection Guide**

Explains how to connect to the Internet by using the wireless LAN and Bluetooth® functions\*.

\* The Bluetooth® function is available for models containing the Bluetooth® wireless technology only.

### Manuals to be read on your computer

The following manuals are automatically installed on your computer after you set up your CLIÉ handheld and computer.

➤ For details on each manual, refer to “Using CLIÉ Manuals with your computer” on page 57.

#### **Handbook (PDF format\*)**

Explains the basic operations and advanced features of your CLIÉ handheld.

#### **CLIÉ Application Manual (HTML format\*\*)**

Explains how to use the supplied applications in detail.

#### **Troubleshooting Q&A (PDF format\*)**

Helps in solving common problems that you may have while using your CLIÉ handheld.

\* You can read the manual on your computer using **Adobe Reader**.

If **Adobe Reader** is not installed on your computer, install it from the supplied Installation CD-ROM.

\*\* You can read the manual on your computer using an Internet browser.

For questions about operations, refer to **CLIE FAQ** on your CLIÉ handheld.

# Before use

## Caution

IN NO EVENT SHALL SONY BE LIABLE FOR ANY INCIDENTAL, INDIRECT OR CONSEQUENTIAL DAMAGES OR OTHER DAMAGES INCLUDING WITHOUT LIMITATION LOSS OF PROFITS, LOSS OF REVENUE, LOSS OF DATA, LOSS OF USE OF THE PRODUCT OR ANY ASSOCIATED EQUIPMENT, DOWNTIME, AND PURCHASER'S TIME RELATED TO OR ARISING OUT OF THE USE OF THIS PRODUCT, ITS HARDWARE AND/OR ITS SOFTWARE.

## On the supplied software

- Copyright laws prohibit reproducing the software or the software manual in whole or in part or renting the software without the permission of the copyright holder.
- In no event will SONY be liable for any financial damage or loss of profits, including claims made by third parties, arising out of the use of the software supplied with this product.
- In the event a problem occurs with this software as a result of defective manufacturing, SONY will replace it at SONY's option or issue a refund. However, SONY bears no other responsibility.
- The software provided with this product cannot be used with equipment other than that which it is designated for use with.
- Please note that, due to continued efforts to improve quality, the software specifications may be changed without notice.
- The software library incorporated in the CLIE handheld is based in part on the work of the Independent JPEG Group.

## NOTES

- Sony does not support third party add-on applications. If you have a problem with a third party application, please contact the developer or publisher of that software.
- The illustrations in this manual may differ from the actual software.
- Explanations in this manual assume that you are familiar with basic operations of Windows®. For how to use your computer and operating system, please refer to their respective manuals.

Program © 2004 Sony Corporation, © 2004 PalmSource, Inc., or its subsidiaries. All rights reserved.

Documentation © 2004 Sony Corporation

# Table of Contents

## Setting up your CLIÉ™ handheld

**Confirming the package contents . . . . . 6**

**Setting up your CLIÉ™ handheld . . . . . 8**

Step 1: Charging your CLIÉ handheld . . . . . 8

Step 2: Performing the initial setup after turning on your CLIÉ handheld for the first time . . . . . 9

**Using your CLIÉ™ handheld with your computer . . . . . 17**

Before installing the software on your computer . . . . . 17

Step 1: Installing Palm™ Desktop for CLIÉ on your computer . . . . . 18

Step 2: Registering your CLIÉ handheld . . . . 20

Step 3: Connecting your CLIÉ handheld and computer via the USB cable . . . . . 20

Step 4: Entering a user name for your CLIÉ handheld . . . . . 22

Step 5: Installing CLIE Organizer for PC on your computer . . . . . 23

**Installing the supplied applications on your CLIÉ™ handheld . . . . . 25**



## CLIE™ handheld components

Front panel .....	85
Back panel .....	87

Locating the components of the Home screen (CLIE Organizer).....	91
<b>INDEX.....</b>	<b>98</b>

---

## Notes on this manual

- Screen shots in this manual may be different from the actual displays in the supplied software.
- The contents of this manual are written for users with a working knowledge of Windows®. For details on computer operations, refer to your computer manual.

## LCD display and camera lens

The LCD of your CLIE handheld is designed with precision technology. However, in some cases, individual pixels may remain lit or may not light at all. Also, the brightness of the display may appear inconsistent, depending on the angle of view. Such anomalies are caused by the nature of the LCD and do not indicate a malfunction.

Please note that Sony does not guarantee a replacement or refund for such cases.

Do not expose the LCD or camera lens to direct sunlight for prolonged periods of time. It may result in a malfunction. Do not store your CLIE handheld in areas subject to sunlight, such as near windows, and be careful when using outdoors.

## The built-in camera

Bright or dark pixels may appear on pictures taken with the built-in camera.

This phenomenon is not a malfunction and occurs due to the nature of the image sensor of the built-in camera.

## Before taking pictures (CLIE Camera), or recording sounds (Voice Recorder)

Sony recommends taking a test picture to confirm settings and light conditions before actual shooting.

Take a test shot, save it, and view it to check the result. Likewise, perform tests before actual sound clip recording (**Voice Recorder**).

## No guarantee for lost or damaged data

Sony does not provide any guarantee for lost or damaged data.

## Copyrights

Television programs, films, video tapes, and other materials may be copyrighted. Unauthorized recording of such materials may violate copyright laws.

# Setting up your CLIÉ™ handheld

This chapter explains how to charge your CLIÉ handheld, perform the initial setup, and use it with your computer.

## Confirming the package contents

Please confirm that all the following accessories are included in the package before setting up your CLIÉ handheld.

### CLIÉ handheld (1)

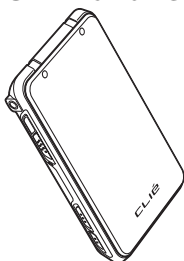

Some illustrations omit the protective cover in this manual.

### AC power adapter (1) (including AC cord)

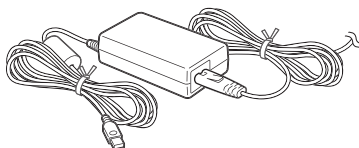

### USB cable (1)

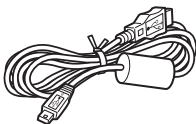

### Stylus (1)



The stylus is inserted into your CLIÉ handheld at the factory.

### Plug adapter (1)



### Installation CD-ROM

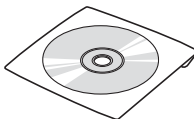

## Strap (1)

Refer to the illustration below to attach the strap.

## Read This First - Operating Instructions\* (1, this manual)

## Safety & Regulations Guide (1)

## Internet Connection Guide (1)

## Software license agreement (1)

## Graffiti 2 Card (1)

## Other printed materials

\* If your CLIE handheld was purchased in Europe, the manual is not in printed format, but is included as a PDF file on the Installation CD-ROM.

Make sure that the package contains all of the above contents. If any item is missing, contact the Sony Customer Information Service Center or a Sony dealer.

**Use the strap to avoid dropping your CLIE handheld**

## Attaching the strap

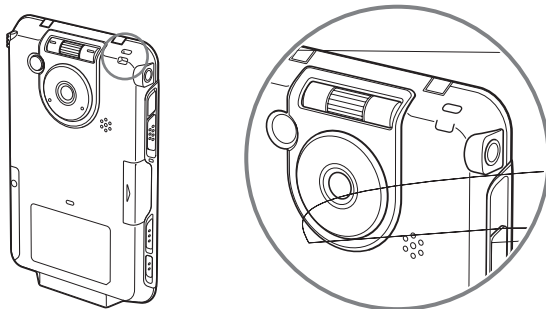

# Setting up your CLIÉ™ handheld

Perform the following before setting up your CLIÉ handheld.

## Step 1: Charging your CLIÉ handheld

**Before using your CLIÉ handheld for the first time, make sure you fully charge the battery.**

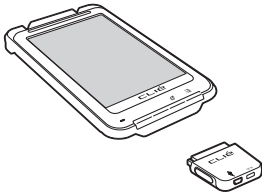

- 1** Connect the AC power adapter to the DC IN connector of the plug adapter.
- 2** Connect the plug adapter to the interface connector of your CLIÉ handheld .
- 3** Connect the AC cord to the AC power adapter (①). Then, plug the AC cord into a wall outlet (②).  
The POWER LED of your CLIÉ handheld turns on when charging starts.

It takes about five hours to fully charge your CLIÉ handheld for the first time. The POWER LED turns off when charging is complete.

### Tip

Subsequent charges will require less time if you charge your CLIÉ handheld frequently.





### Tips

#### If you cannot turn on your CLIÉ handheld

- Did you charge your CLIÉ handheld as described on page 8?
  - ➔ For details, refer to “Frequently Asked Questions: I cannot turn on my CLIÉ handheld” on page 67.
- Perform a soft reset if you cannot turn on your CLIÉ handheld even after charging it (page 47).

## 2 Take out the stylus.

You can use the stylus to enter text or to select applications.

Take out the stylus

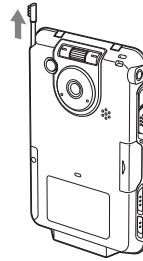

### Tip

You can extend or shorten the stylus, as shown in the illustration.

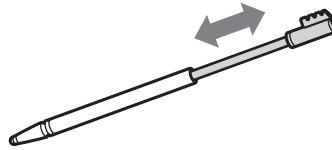

### Notes

- Never use a writing pen, pencil, or other sharp object instead of the stylus to write on your CLIÉ handheld, as the screen may get scratched.
- When you put the stylus back in its holder, push it in into place completely.

### 3 Following the on-screen instructions, tap exactly in the center of the displayed mark.

Tap the next targets, which are displayed at the bottom right and then in the center of the screen.

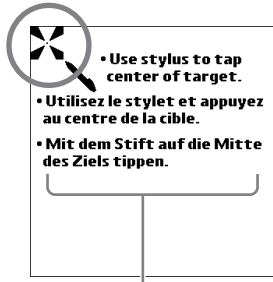

The display in the screen depends on where you purchased your CLIE handheld.

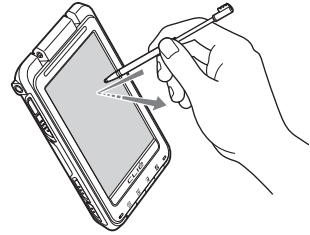

Open the protective cover, and press lightly on the screen. (Tap)

#### Note

If the stylus digitizer is not configured correctly, the scroll bar may not operate properly, “tapping” may not work as expected, or other problems may occur.

➔ For details on reconfiguring the stylus digitizer, refer to “Customizing your CLIE™ handheld (Preferences): Adjusting the Digitizer” in the “Handbook” (PDF format).

After the stylus adjustment is complete, a screen for selecting your language is displayed. (Only available for certain models or areas.)

### 4 Select your language. (Only available for certain models or areas.)

The **Important** screen is displayed.



The display in the screen depends on where you purchased your CLIE handheld.

Continued on next page

- 5** Click [Yes] to confirm.  
(Only available for certain models or areas.)

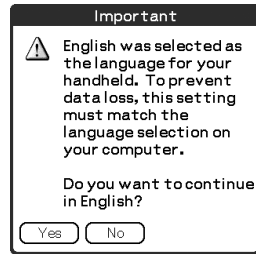

- 6** Tap the box next to [Set Time:].  
The **Set Time** dialog box is displayed.

**Tip**

You can reconfigure the date and time settings in the **Preferences** screen.

- For details, refer to “Customizing your CLIÉ™ handheld (Preferences): Setting up the Date & Time preferences” in the “Handbook” (PDF format).

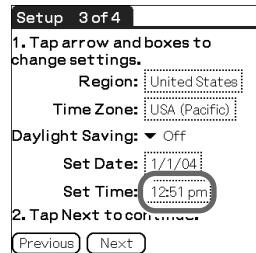

- 7** Tap ▲ or ▼ to set the current time.  
Tap each box to set the hour and minute.

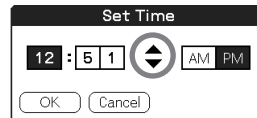

- 8** Tap [OK].  
The current time is set and the **Setup** screen is displayed.



**9** Tap the box next to [Set Date:].  
The **Set Date** screen is displayed.

**10** Tap ◀ or ▶ to select the current year.

**11**

**13** Tap the region to set the time zone, then tap [OK].



**14** Tap ▼ next to [Daylight Saving:] and select [On] or [Off].

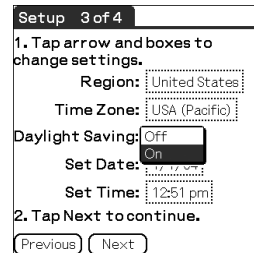

**15** Tap [Next].

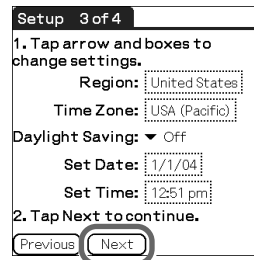

## 16 Tap [Next] and [Done].

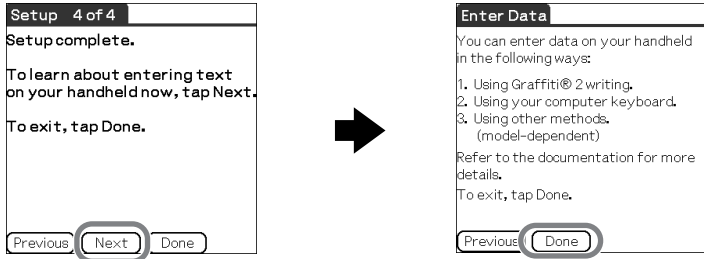

The **Holiday** screen is displayed.

## 17 Tap your country or region in the **Holiday** screen to set holidays, and tap [OK].

If your country or region is not displayed in the **Holiday** screen, tap **↑** or **↓** to scroll the list in the screen.

The **Confirmation** dialog box is displayed.

### Tip

If you do not want to set holidays, tap [Cancel].

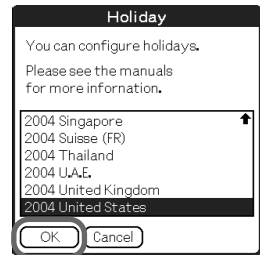

### Note

The holiday information should be used for guidelines only, it is not available for some countries or regions, and it may differ by areas or it could change in the future. This information is not intended for business or official use. Sony assumes no liability arising from the use of these data.

## 18 Tap [Yes].

The Home screen (**CLIE Organizer**) is displayed.

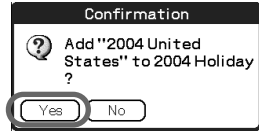

### Tip

The screen displayed when you turn on your CLIE handheld and tap  (Home) is called the Home screen.

- For details on the Home screen, refer to “Using an application: Displaying the Home screen” on page 27.



**The initial setup is complete.**



## Using your CLIÉ™ handheld with your computer

**CLIE Organizer for PC** and **Palm™ Desktop for CLIÉ** stored on the supplied Installation CD-ROM must be installed on your computer. The software is used for data transfer between your CLIÉ handheld and computer, and handling data on your computer such as **Address Book**.

When **Palm™ Desktop for CLIÉ** is installed on your computer, **CLIÉ Manuals** is also installed on your computer.

- For details on the system requirements of your computer, refer to “System requirements” on page 84.
- For details on **CLIÉ Manuals**, refer to “Using CLIÉ Manuals with your computer” on page 57.

## Before installing the software on your computer

**Do not connect your CLIÉ handheld to your computer before installing the software. Otherwise, the software may not be installed properly.**

### Notes

- Do not simply copy the CLIE Organizer for PC or Palm™ Desktop for CLIÉ folder from the supplied Installation CD-ROM to your computer. To install the software properly, follow the installation procedure described below.
- If you use Windows 2000 Professional or Windows XP, log on with a User Name in the Administrators group before installing the software.

### If you have more than one CLIÉ handheld

If you have more than one CLIÉ handheld and the older version of **Palm™ Desktop for CLIÉ** has already been installed on your computer, follow the installation procedure below to upgrade to the new version.

- \* If you are using PEG-N710C Series or PEG-S300 Series, refer to your CLIÉ handheld support website. (Refer to the URL shown on the back cover of this manual.)
- For details, refer to “Transferring data from another CLIÉ™ handheld” in the “Handbook” (PDF format).

### Tip

Even if you upgrade the old version of **Palm™ Desktop for CLIÉ** with the new one, the data saved on the old **Palm™ Desktop for CLIÉ** will not be deleted.

# Step 1: Installing Palm™ Desktop for CLIÉ on your computer

**Palm™ Desktop for CLIÉ** is the software supplied with the Palm OS® device. You can synchronize data between your CLIÉ handheld and computer using **Palm™ Desktop for CLIÉ**. Make sure you install this before installing **CLIE Organizer for PC** (page 23).

- 1** Quit all applications running on Windows®.
- 2** Insert the supplied Installation CD-ROM into the CD-ROM drive of your computer.  
The **Installation CD-ROM** window is displayed.

#### Note

Depending on the model or area, two Installation CD-ROMs are supplied. Insert the one that contains your language.

- 3** Select your language.  
(Only available for certain models or areas.)
- 4** Click [Next] or [CLIÉ Basic], then click [Install] to install **Palm™ Desktop for CLIÉ**.  
The setup program starts and the **InstallShield Wizard** window is displayed.

#### Note

If you try to install **Palm™ Desktop for CLIÉ** when an older version of **Palm™ Desktop for CLIÉ** has already been installed on your computer, a dialog box appears on your computer window.

Follow the instruction of the dialog box to install the new version of **Palm™ Desktop for CLIE** supplied with your CLIÉ handheld.

- 5** Click [Next].  
The **InstallShield Wizard** window for [Setup Type] is displayed.
- 6** Select the setup type, [Complete] or [Custom].  
When you select [Custom], you need to specify which software you want to install and where to be installed.  
The following steps explain when you select [Complete].

## 7 Click [Next].

The **InstallShield Wizard** window for [Select User] is displayed.

## 8 Enter a user name and click [Next].

The **InstallShield Wizard** window for [Ready to Install the Program] is displayed after entering any user name you prefer.

### Note

#### If you have more than one CLIÉ handheld

Enter a user name that is different from the one you use for another CLIÉ handheld. If you set an identical user name for multiple CLIÉ handhelds, errors may occur.

### Tip

#### If you want to transfer data between CLIÉ handhelds

Refer to “Transferring data from another CLIÉ™ handheld” in the “Handbook” (PDF format).

## 9 Click [Install].

Installation of **Palm™ Desktop for CLIÉ** starts.

“InstallShield Wizard Completed” message is displayed in the **InstallShield Wizard** window when the installation is complete.

## 10 Click [Finish].

The **Sony CLIÉ Handheld Registration** window is displayed for models for the U.S.A., Canada, and Europe only.

### Tip

If you do not want to sign up for the customer service, click  to deselect [Register your CLIÉ].

**Installation of Palm™ Desktop for CLIÉ on your computer is complete.**

**If you want to register your CLIÉ handheld, go to “Step 2: Registering your CLIÉ handheld”.**

## Step 2: Registering your CLIÉ handheld

You can register your CLIÉ handheld by following the on-screen instructions. With your permission, Sony will keep you informed of special opportunities. Also, your registration information helps Sony assist you if you call for customer support.

All of the information you provide is confidential.

### Notes

- To register your CLIÉ handheld online, you need to have an access to the Internet.
- You need to register again if you purchase a new CLIÉ handheld.

### Tip

If you want to register your CLIÉ handheld later, click  at the top right of the **Sony CLIÉ Handheld Registration** window to close.

When you complete the registration and close the **Sony CLIÉ Handheld Registration** window, the **Installation CD-ROM** window is displayed.

### Other ways to register your CLIÉ handheld

- You can register your CLIÉ handheld online by clicking [Start], selecting [Programs] ([All Programs] for Windows XP)-[Sony Handheld]-[About PEG-TH55], and clicking [CLIÉ Registration].
- Double-click  (CLIÉ Info) and follow the on-screen instructions.

## Step 3: Connecting your CLIÉ handheld and computer via the USB cable

You can synchronize data between your CLIÉ handheld and computer by connecting them with the supplied USB cable after installing **Palm™ Desktop for CLIÉ**.

### About the USB cable

The supplied USB cable has two connectors. Connect the “A” plug to the USB port of your computer and the mini “B” plug to the plug adapter.



- 1 Connect the mini "B" plug of the USB cable to the mini "B" adapter (①), then connect the mini "B" interface connector of the USB cable to the mini "B" interface connector of the device.

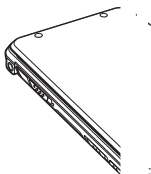

- 2 Connect the "A" plug of the USB cable to the USB port of your computer.





**Note**

Make sure you connect the USB cable to the USB port of your computer.  
If the USB cable is connected to a USB hub, the HotSync® operation will not work.

## Step 4: Entering a user name for your CLIÉ handheld

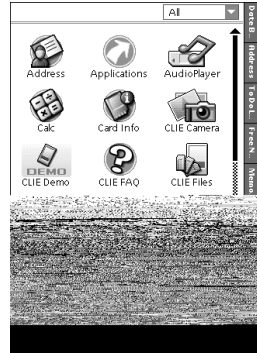
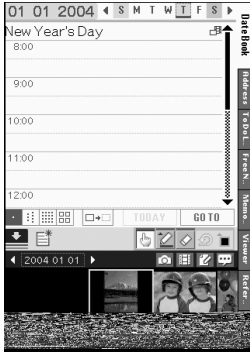
- 1 Tap [Applica...] from the Home screen of your CLIÉ handheld.  
The **Applications** screen is displayed.



- 2 Tap  (HotSync) in the **Applications** screen.  
The **HotSync** screen is displayed.

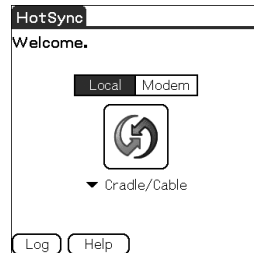

- 3 Tap  (HotSync) in the **HotSync** screen.

The HotSync® operation starts and the installation for the required software starts automatically.

#### 4 Click [OK] when your user name is displayed in the **Users** window of your computer.

A beep is heard from your CLIE handheld and the HotSync® operation starts.

Your user name entered for **CLIE Organizer for PC** is also registered in your CLIE handheld.

When the setup is complete, “HotSync operation complete.” will be displayed on your CLIE handheld.

#### Note

If you have more than one CLIE handheld, the user name for your old CLIE handheld may be displayed. In this case, select the user name you entered in step 8 in “Step 1: Installing Palm™ Desktop for CLIE on your computer” on page 18.

Follow the steps below to install **CLIE Organizer for PC** on your computer.

## Step 5: Installing CLIE Organizer for PC on your computer

To synchronize the data created on **CLIE Organizer** (a specific application to your CLIE handheld) between your CLIE handheld and computer, **CLIE Organizer for PC** must be installed on your computer.

#### Tip

If you want to assign the CLIE Launcher or Palm OS® Standard screen to the Home screen, and not using **CLIE Organizer**, you do not need to install **CLIE Organizer for PC** on your computer.

► For details on assigning the Home screen, refer to “CLIE handheld™ basic operations: Using the CLIE Launcher (or Using the Palm OS® Standard screen)” in the “Handbook” (PDF format).

**1** Click [Back] or [CLIE Basic], and click [Install] for **CLIE Organizer for PC** in the **Installation CD-ROM** window of your computer.

**2** Click [Install] to install **CLIE Organizer for PC**.  
The setup program starts and the **InstallShield Wizard** window for **CLIE Organizer for PC** is displayed.

**3** Click [Next].  
The **InstallShield Wizard** window for [Ready to Install the Program] is displayed.

*Continued on next page*

**4** Click [Install].

Installation of **CLIE Organizer for PC** starts. “InstallShield Wizard Complete” message is displayed in the **InstallShield Wizard** window when the installation is complete.

**5** Click [Finish].

The **Image Converter** window is displayed. **Image Converter** is required to be installed to use **CLIE Organizer for PC**. Follow the on-screen instructions. The **Installation CD-ROM** window is displayed again after installing **Image Converter**.

**6** Click [Finish] in the **Installation CD-ROM** window of your computer.

**Installation of CLIE Organizer for PC on your computer is complete.**



## Installing the supplied applications on your CLIÉ™ handheld

You can install applications from the supplied Installation CD-ROM by following the procedure below.

You must install **CLIE Organizer for PC** (or **Palm™ Desktop for CLIE**) on your computer, before installing the supplied applications on your CLIÉ handheld. Your CLIÉ handheld must be connected to your computer via the USB cable.

➤ For details on supplied applications, refer to “Supplied applications” on page 50.

### Note

The supplied applications are designed to operate on your CLIÉ handheld only. Compatibility with other CLIÉ handhelds or Palm OS® PDAs is not guaranteed.

## ..... Installing the applications from the supplied Installation CD-ROM

- 1** Quit all applications running on Windows®.
- 2** Insert the supplied Installation CD-ROM into the CD-ROM drive of your computer.  
The **Installaton CD-ROM** window is displayed.
- 3** Select the type of application you want to install, such as [CLIÉ Utilities].
- 4** Click [Install] to install the application.  
Follow the on-screen instructions.
- 5** To install the application on your CLIÉ handheld, tap  (HotSync) in the **HotSync** screen.  
The HotSync® operation starts and the selected application is transferred and installed on your CLIÉ handheld.
- 6** Click [Finish] in the **Installation CD-ROM** window of your computer.

### Tip

You can also install applications on your CLIÉ handheld using the function of **CLIE Organizer for PC** (or **Palm™ Desktop for CLIE**).

➤ For details, refer to “Enhancing features with add-on applications: Installing” in the “Handbook” (PDF format).

# Basic operations of your CLIÉ™ handheld

This chapter explains how to turn on/off your CLIÉ handheld, start an application, enter text, synchronize with your computer, take a picture, and perform a reset.

## Turning on/off your CLIÉ™ handheld

### Turning on your CLIÉ handheld

Slide down the POWER/HOLD switch.

Your CLIÉ handheld turns on, and the last screen you viewed is displayed.

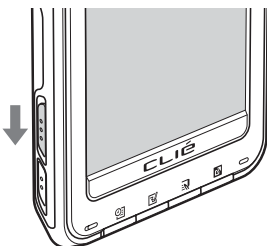

Slide down the POWER/HOLD switch

#### Note

When you slide and hold the POWER/HOLD switch for more than 2 seconds, the backlight of the LCD display turns on or off.

#### Tip

**If you cannot turn on your CLIÉ handheld**

Did you fully charge your CLIÉ handheld?

- ➔ For details, refer to “Frequently Asked Questions: I cannot turn on my CLIÉ handheld” on page 67.

### To turn off your CLIÉ handheld

Slide down the POWER/HOLD switch again.

# Using an application

To use your CLIÉ handheld, you need to start an application.

The following explains how to start an application from the Home screen (**CLIE Organizer**).

## Displaying the Home screen

### What is the Home screen?

The screen displayed when you turn on your CLIÉ handheld and tap  (Home) is called the Home screen. When you purchase your CLIÉ handheld, **CLIE Organizer** is assigned to the Home screen by default. When you turn on your CLIÉ handheld for the first time, the **Date Book** screen of **CLIE Organizer** is displayed. The next time you turn on your CLIÉ handheld, the last screen viewed of **CLIE Organizer** is displayed.

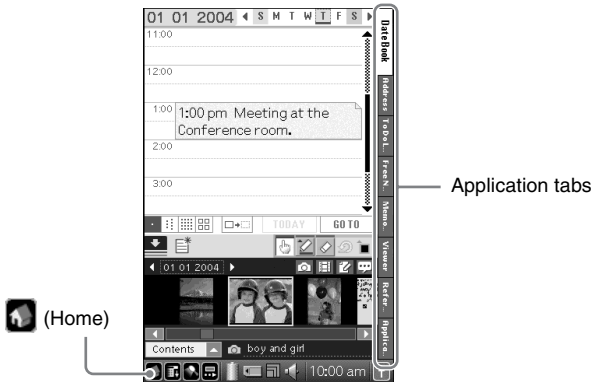

#### Tip

You can also assign the CLIE Launcher and Palm OS® Standard screen to the Home screen.

- For details on switching to the CLIE Launcher, refer to “CLIÉ™ handheld basic operations: Using the CLIE Launcher” in the “Handbook” (PDF format).
- For details on switching to the Palm OS® Standard screen, refer to “CLIÉ™ handheld basic operations: Using the Palm OS® Standard screen” in the “Handbook” (PDF format).

# Starting an application from CLIE Organizer

.....

## What is CLIE Organizer?

**CLIE Organizer** is an essential application that manages all applications installed on your CLIE handheld. You can start an application from the application tabs which include **Date Book, Address Book, To Do List, Free Notes, Memo Pad, Viewer, Reference,** and **Applications.**

You can also synchronize the data you entered in **CLIE Organizer** with **CLIE**

- **Memo Pad**

You can take text format memos. Text files created on your computer can also be read.

- **Viewer**

You can display the list of pictures, movie files, voice memos, and Free Notes memos.

You can also tap the files to view or play.

- **Reference**

You can use some reference items, such as [Conversion Table], [Sizes], and [Temperatures and Precipitations], for useful information. New items can be added later.

## Starting other applications

- 1 Tap [Applica...] in **CLIE Organizer**.  
The **Applications** screen is displayed.

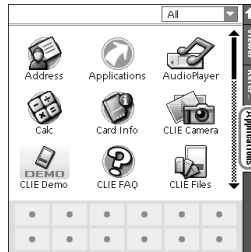

**Application launcher tab**  
Tap to display the list of application icons.

**Tip**

You can also display the **Applications** screen by tapping  (Home) repeatedly.

- 2 Tap the application icon you want to start.  
The selected application starts.

# Quitting the application

You do not need to save data manually on your CLIÉ handheld as you do on a computer, although some applications require data be saved.

➤ For details, refer to the “CLIÉ Application Manual” (HTML format).

To switch from one application to another, perform either of the following methods.

- ▶ **Tap a tab to start another application.**  
**If you are using an application other than the applications of CLIE Organizer, return to the Home screen once and tap a tab.**
- ▶ **Press the application button (page 32) to start another application.** (Only the application that is assigned to the application button.)

# Other ways to start an application

You can also start an application using the Jog Dial™ navigator, BACK button, or application buttons.

.....

# Using the Jog Dial™ navigator and the BACK button

## How to operate

Use your index finger to operate the Jog Dial™ navigator and the BACK button on the back of your CLIÉ handheld while you are looking at the screen of your CLIÉ handheld.

**On the back of your CLIÉ handheld**

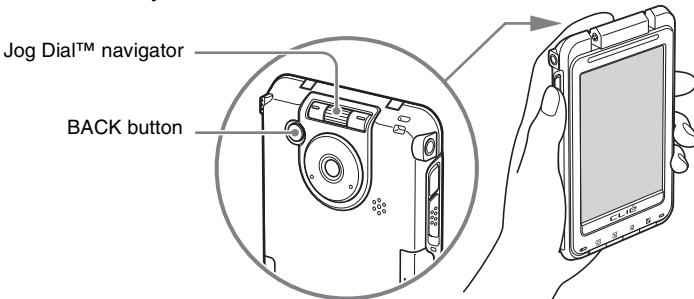

- 1** Press the BACK button when the Home screen is displayed.  
The current application is selected.

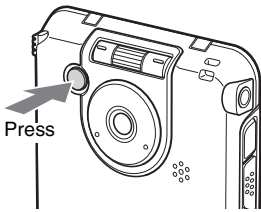

- 2** Rotate the Jog Dial™ navigator to select an application to start.  
An application is selected.

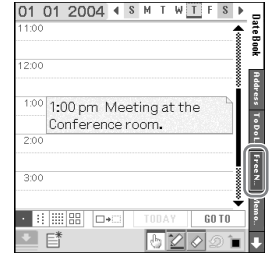
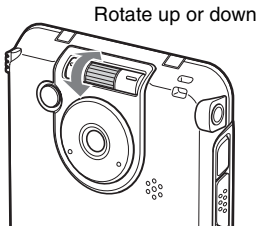

- 3** Press the Jog Dial™ navigator.  
The selected application starts.

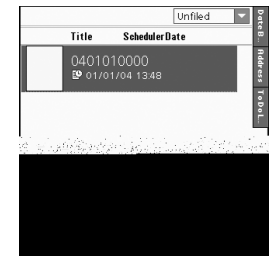
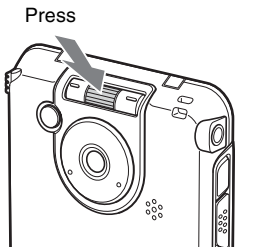

Continued on next page

**Tip**

**To select an application by category**

Tap  at the top right of the **Applications** screen to select the category you want.

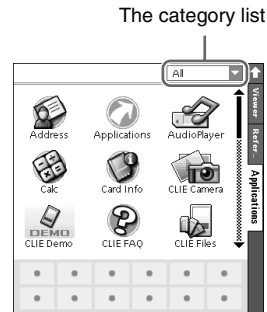

## Pressing the application buttons

You can also start the applications by pressing the application buttons.



The default setting of the application buttons are:

 **Date Book**,  **Free Notes**, and  **CLIE Organizer**.



Application buttons

**Tips**

- Even when your CLIÉ handheld is off, you can start an application by pressing one of the application buttons.
- When you press  (CLIE Organizer), the following occurs:  
**When operating CLIE Organizer:**  
The next screen of the CLIE Organizer application (PIM) will be displayed.  
**When operating applications other than CLIE Organizer, or your CLIÉ handheld is off:**  
The last screen viewed of the CLIE Organizer application (PIM) will be displayed.
- You can assign your favorite applications to the application buttons.  
➔ For details, refer to “Customizing your CLIÉ™ handheld (Preferences): Assigning applications to application buttons” in the “Handbook” (PDF format).
-  (Data Assistant) is not an application button (page 36). You cannot assign your favorite applications to this button. No application starts by pressing  (Data Assistant) while your CLIÉ handheld is off.



## Entering text

### Using Graffiti® 2 writing to enter text

Graffiti® 2 is a unique writing method for quickly and easily entering text into CLIÉ applications. Text is entered in the Graffiti® 2 writing area using the supplied stylus. Graffiti® 2 recognizes your handwriting and immediately converts it to typed text.

### Using the Graffiti® 2 writing area of your CLIÉ handheld

You need to write the Graffiti® 2 strokes in the Graffiti® 2 writing area in the lower screen of your CLIÉ handheld to enter text. The Graffiti® 2 writing area is divided into two parts.

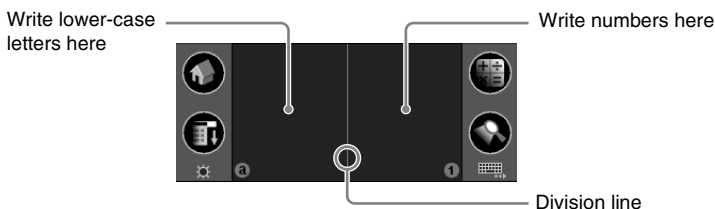

You need to write the Graffiti® 2 strokes in the left side of the Graffiti® 2 writing area for lower-case letters, the right side for numbers, or write the strokes across the division line for upper-case letters. Also, you need to activate Symbol mode to write symbols in the Graffiti® 2 writing area.

- For details on how to write the Graffiti® 2 strokes, refer to “Entering text on your CLIÉ™ handheld: Using Graffiti® 2 writing to enter text” in the “Handbook” (PDF format).

.....

## Entering text

You need to start an application and display the screen in which you want to enter text.

Follow the steps below to enter text.

- 1** Start an application, such as **Date Book**, in which you want to enter text.
- 2** Tap a line for the insertion point where text is to be entered.
- 3** Write the Graffiti<sup>®</sup> 2 strokes in the Graffiti<sup>®</sup> 2 writing area.

### Displaying the on-screen Graffiti 2 Help

To assist with the Graffiti<sup>®</sup> 2 writing, you can display the on-screen Graffiti 2 Help by dragging the stylus from the Graffiti<sup>®</sup> 2 writing area in the lower part of the screen, to the top of the screen. Graffiti 2 Help opens a series of screens that show the character set of Graffiti<sup>®</sup> 2 writing.

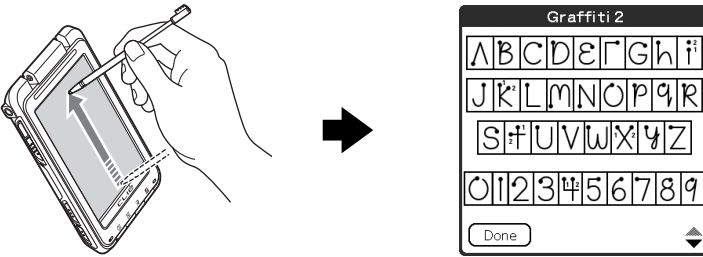

# Other ways to enter text

There are some other ways to enter text into your CLIÉ™ handheld. You can use whichever is the most comfortable for you.

## ● Handwriting system

There is another way of using the handwriting system besides **Graffiti® 2**.

➔ For details, refer to “Entering text on your CLIÉ™ handheld” in the “Handbook” (PDF format).

## ● Decuma Input

You can enter text using **Decuma Input**, which converts your handwriting into typed text as you write.

➔ For details on **Decuma Input**, refer to “Entering text on your CLIÉ™ handheld: Using Decuma Input to enter text” in the “Handbook” (PDF format).

## ● On-screen keyboard

You can enter text by tapping the on-screen keyboard.

➔ For details, refer to “Entering text on your CLIÉ™ handheld: Using the on-screen keyboard to enter text” in the “Handbook” (PDF format).

## ● Software Keyboard (page 95)

Operating the software keyboard is the same as the on-screen keyboard, however, you can use the applications without minimizing the current screen.

## ● The HotSync® operation with a computer

You can enter text on your computer using **CLIE Organizer for PC** (or **Palm™ Desktop for CLIÉ**) and then transfer it to your CLIÉ handheld via the HotSync® operation.

➔ For details, refer to [Help] in **CLIE Organizer for PC** (or **Palm™ Desktop for CLIÉ**).

# Using data

You can use data from another application to easily create new data in an application.

You can use data efficiently by following procedures.

## ..... Creating new data from the text data of other applications

For example, follow the steps below to use data from another application in **Address Book**.

- 1** In an application other than **Address Book**, drag the text you want to use with the stylus.
- 2** Press  (Data Assistant).  
The menu is displayed in the right of the screen.
- 3** Tap [New Address data].  
The **New Address data** screen is displayed and the text you selected is displayed in the center of the screen.
- 4** Select the portion of the text (**1**), tap ▼ to select an option (**2**), and then tap [Copy to field] (**3**).  
The text portion you selected is displayed in the upper screen (**4**).

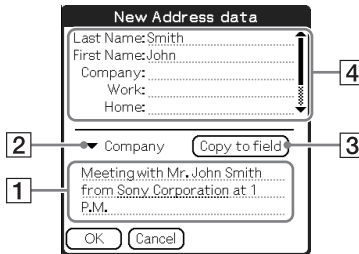

- 5 Tap [OK].  
**Address Book** starts and the data you created is displayed.

**Tips**

- If you want to create new data in **Date Book**, tap [New Date Book data] in step 3 and then tap [Time :] and [Date :] in the displayed **New Date Book data** screen.
- If you want to create new data in **To Do List**, **Memo Pad**, or **CLIE Mail**, tap [New To Do data (New Memo data, or New E-mail)] in step 3 to start the application. The text you selected will be displayed in the screen.
- If you select text that includes a mail address and tap [New E-mail], **CLIE Mail** starts. The text you selected will be displayed as the outgoing mail address.  
 If you select text that includes a URL and tap [Open with browser], **NetFront v3.1 for CLIE** starts.

.....

## Creating new data by searching the text data of other applications

For example, follow the steps below to create new data by searching the data in **Address Book**.

- 1 In an application other than **Address Book**, drag the text you want to search with the stylus.
- 2 Press  (Data Assistant).  
 The menu is displayed in the right of the screen.
- 3 Tap [Address Search].  
 The **Search** screen is displayed and the list you searched is displayed.

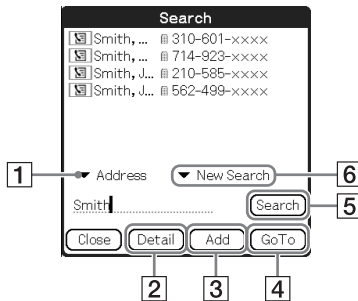

Continued on next page

## 4 Select the operation you want for the search results.

You can select the following operations.

- 1 [▼]: Tap to display the search results in other applications.
- 2 [Detail]: Select the data from the search results, and tap this to display detailed information on the data. When you select the data of **Date Book**, **Address Book**, or **Free Notes**, you can also select the item in the **To Do Detail**, **Address Detail**, or **Free Notes Detail** screen.
- 3 [Add]: Select the data from the search results, and tap this to add the data to the field in the application you previously worked.

### Note

[Add] is activated only when the cursor is focused on the field where entering text is possible and  (Data Assistant) is pressed.

- 4 [GoTo]: Select the data from the search results, and tap this to start the application in which the data is saved.
- 5 [Search]: Enter text in the text field, and tap this to search the data. You can also search the data within the search results by tapping ▼ of  and selecting [Within Results].

### When Searching data without selecting text

If you do not select text in step 1, but you press  (Data Assistant) for searching, no search result will be displayed in the **Search** screen.

In this case, you can still search by entering text in the text field.

# Synchronizing data between your CLIÉ handheld and computer by entering a schedule event (the HotSync® operation)



## What is the HotSync® operation?

The HotSync® operation is an easy operation that allows you to synchronize data between your CLIÉ handheld and computer, back up the data of your CLIÉ handheld to your computer, and install add-on applications.

➔ For details, refer to “Exchanging and updating files/data using the HotSync® operation (Other HotSync® operations)” in the “Handbook” (PDF format).

For example, follow the procedures below using **Date Book** and synchronize the data with your computer.

## Entering a schedule event in Date Book

- 1** Tap [Date B...] in **CLIE Organizer**.  
The **Date Book** screen is displayed.
- 2** Tap  (New) in the bottom left of the screen.  
The **Event Details** screen is displayed.
- 3** Enter a schedule event and tap [OK].  
The schedule event is displayed in the **Date Book** screen.  
➔ For details on how to enter text, refer to “Entering text” on page 33.
- 4** Tap  (Resize) in the status bar.  
The contents field is displayed in the Graffiti® 2 writing area.

Continued on next page

- 5** Drag an image file in the contents field with the stylus to where you want to put it.  
The image file is put.

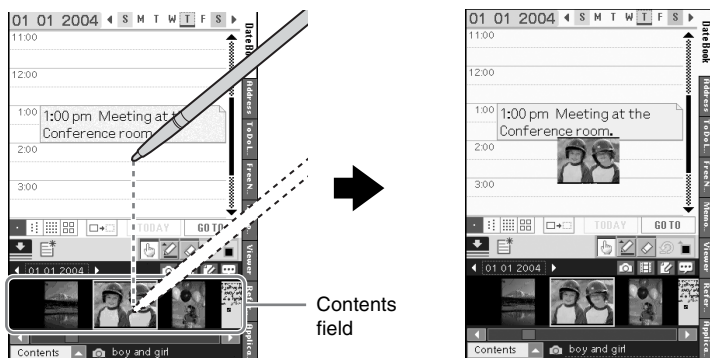

**Tip**

A movie file, voice memo, and Free Notes memo can also be put on the screen.  
► For details on how to use **Date Book**, refer to “CLIE Organizer-Date Book” in the “CLIE Application Manual” (HTML format).

.....  
**Performing the HotSync® operation**

- 1** Turn on your computer.
- 2** Connect your CLIE handheld and computer via the supplied USB cable (page 20).
- 3** Tap [Applica...] in **CLIE Organizer**.  
The **Applications** screen is displayed.
- 4** Tap  (HotSync).  
The **HotSync** screen is displayed.



- 5 Tap  (HotSync) in the **HotSync** screen.

The HotSync® operation starts.

When the HotSync® operation is complete, the following screen is displayed.



.....

## Viewing a synchronized schedule event on your computer

- 1 Double-click  (CLIE Organizer for PC) on the Windows desktop.  
**CLIE Organizer for PC** starts and the **Date Book** window is displayed.

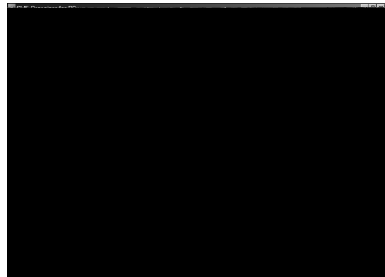

**Tip**

You can also click [Start], select [Programs] ([All Programs] for Windows XP)-[Sony Handheld], and click [CLIE Organizer for PC] to start the software.

- 2 Click the day you entered the schedule event in the calendar.

The schedule event you entered is displayed.

*Continued on next page*

.....

## To display other application windows (Address Book, To Do List, Memo Pad, Free Notes, and Reference)

Click any icon on the left side of the window.

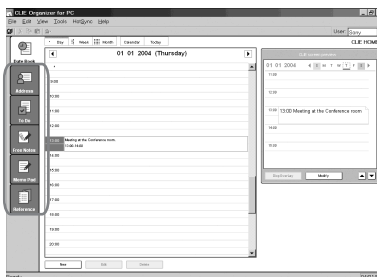

## Performing the HotSync® operation using the wireless LAN function

You can also synchronize data between your CLIE handheld and computer using the wireless LAN function.

- For details, refer to “Exchanging and updating files/data using the HotSync® operation (Other HotSync® operations): Performing the HotSync® operation via a wireless LAN” in the “Handbook” (PDF format).

## Making a backup is recommended

If problems occur, even those requiring a hard reset, you can restore your CLIE handheld to the same state as it was at the last HotSync® operation.

You may not be able to back up certain add-on applications installed after the initial setup or the data created by them.

- For backup details, refer to “Making a backup of the data or applications on your CLIE handheld” on page 64.

# Taking pictures using the built-in camera

You can take pictures and view image files using your CLIE handheld as a digital still camera.

- ➔ For details on **CLIE Camera**, refer to “Still images” in the “CLIE Application Manual” (HTML format).

## Taking pictures

- 1 Slide the Lens Cover Lever down, as shown in the illustration.

The lens cover is opened and **CLIE Camera** starts.

The first time you start **CLIE Camera**, a message about adjustment for the Flicker control setting is displayed.

- ➔ For details on the Flicker control setting, refer to “CLIE Camera” in the “CLIE Application Manual” (HTML format).

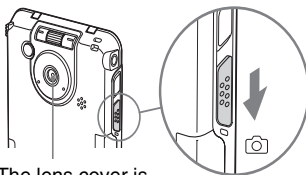

The lens cover is opened.

### Tip

You can also tap  (CLIE Camera) in the **Applications** screen or press the CAPTURE button to start **CLIE Camera**.

- 2 Position the subject in the viewfinder and press the CAPTURE button.

A picture is taken.

### Tip

You can also tap  (CAPTURE) on the **CLIE Camera** screen to take a picture.

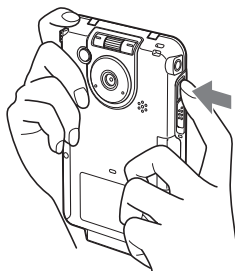

*Continued on next page*

### 3 Slide the Lens Cover Lever up.

The lens cover is closed.

#### Notes

- By taking pictures, hold your CLIÉ handheld firmly with both hands and press the CAPTURE button slowly.
- After the CAPTURE button is pressed when the viewfinder blacks out, your CLIÉ handheld captures an image. At this moment, do not move your CLIÉ handheld, otherwise the picture will be blurred.
- Your CLIÉ handheld is equipped with a flicker control feature. However, flicker may occur under certain conditions. To minimize flicker if it occurs, avoid using under fluorescent lighting.
- Since the brightness and color of the screen are in adjustment for the first 2-

## ..... Viewing pictures

You can view the last three pictures taken by tapping them in the Image Thumbnail Display below the **CLIE Camera** screen.

#### Tip

If the Decuma Input area or Graffiti<sup>®</sup> 2 writing area is displayed, tap (Resize) in the status bar to display the Image Thumbnail Display.

You can view other taken pictures in **CLIE Viewer** by tapping (CLIE Viewer) on the **CLIE Camera** screen.

- ➔ For details on **CLIE Viewer**, refer to “CLIE Viewer” in the “CLIÉ Application Manual” (HTML format).

## Recording/Playing back a voice memo (Voice Recorder)

You can record sounds using the built-in microphone of your CLIÉ handheld. You can also use the voice memo as an alarm sound or attach it to an e-mail.



- For details, refer to “Voice Recorder” in the “CLIÉ Application Manual” (HTML format).

### Recording a voice memo

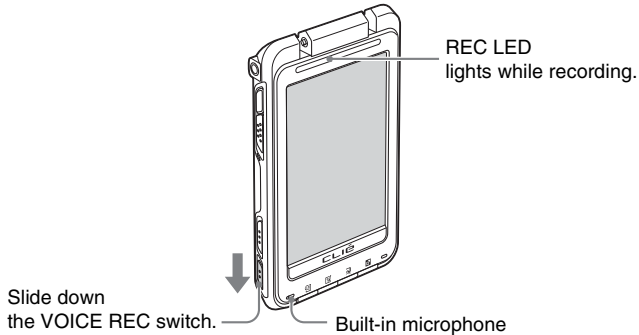
- 1 Slide down the VOICE REC switch.  
**Voice Recorder** starts, and voice memo recording starts.  
 Speak directly into the built-in microphone.



#### Tips

- You can also tap  (Voice Rec) in the **Applications** screen to start **Voice Recorder**, and tap  in the **Voice Recorder** screen to start recording.
- There are two modes of recording for voice memo, [High] (to record at meetings or in a quiet and/or spacious place) and [Low] (to record dictation or in a noisy place).
- For details, refer to “Voice Recorder” in the “CLIÉ Application Manual” (HTML format).

- 2 Slide down the VOICE REC switch again to stop recording.

#### Tip

You can also tap  or  in the **Voice Recorder** screen to stop recording.

.....

## Playing back a voice memo

You can play back a voice memo using **Voice Recorder**, [Viewer] of **CLIE Organizer**, or **CLIE Viewer**.

- ➔ For details on each application, refer to each application in the “CLIE Application Manual” (HTML format).

# Restarting your CLIÉ™ handheld

Normally, you do not need to reset your CLIÉ handheld. However, if your CLIÉ handheld does not turn on or respond, performing a soft reset may solve the problem. To reset your CLIÉ handheld, follow the procedure below.

## ..... Performing a soft reset

All records and add-on applications stored on your CLIÉ handheld are retained even after performing a soft reset.

**Gently press the RESET button with the stylus.**

The system shuts down and your CLIÉ handheld restarts.

After restarting, it displays “palm POWERED”, “SONY” and “CLIÉ”, followed by the **Preferences** screen for setting up the time and date.

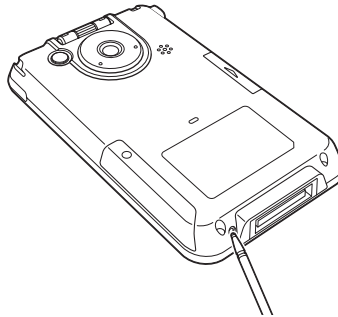

### Notes

- After the RESET button is pressed, it takes a while before the **Preferences** screen is displayed. Do not press the RESET button again while resetting.
- Do not press the RESET button with anything other than the stylus, as a malfunction may occur.
- Do not press any other buttons when you press the RESET button.

## .....

# Performing a hard reset

If a soft reset does not solve the problem, you may need to perform a hard reset to restart your CLIÉ handheld.

### Notes

- **All records and add-on applications stored on your CLIÉ handheld will be erased by performing a hard reset.**
- Perform a hard reset only if a soft reset does not solve the problem. However, you can restore the data if you have made a backup on your computer via the HotSync® operation\*.
  - \* Note that some data cannot be backed up.
  - ➔ For details, refer to “Backing up your CLIÉ™ handheld data and applications” in the “Handbook” (PDF format).
- Do not press any other buttons when you press the RESET button.

- 1** Slide down and hold the POWER/HOLD switch.
- 2** Press the RESET button gently with the stylus, and then release the stylus.

### Note

Keep the POWER/HOLD switch held down.

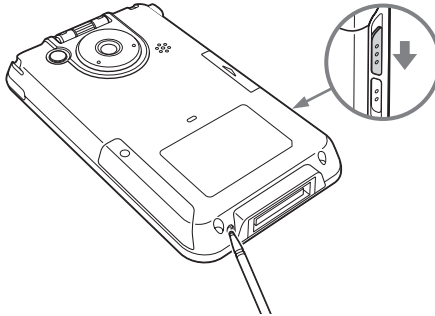

- 3** Wait for more than three seconds after the **palm POWERED** screen is displayed, and release the POWER/HOLD switch. The message “Erase all data?” is displayed.



#### 4 Press (the Left button) on your CLIÉ handheld.

The Left button is on the left side when the display of your CLIÉ handheld is face up.

Press  (the Left button)

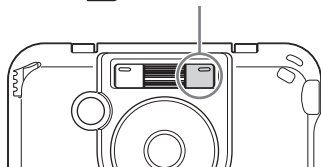

#### Tip

If you want to cancel the hard reset, press any button other than  (the Left button).

The hard reset is performed.

After restarting, your CLIÉ handheld displays “palm POWERED”, “SONY” and “CLIÉ”, followed by the **SETUP** screen. Refer to “Step 2: Performing the initial setup after turning on your CLIÉ handheld for the first time” on page 9 for the initial setup.

After a hard reset, only the current date and time are retained. Formats, Preferences, and other controls revert to the factory settings.

#### Notes

- After the RESET button is pressed, it takes a while before the **Setup** screen is displayed. Do not press the RESET button again while resetting.
- If  (the Left button) is not pressed long enough, the hard reset may not be performed.
- (Only available for certain models or areas.) In order to change the language setting that you have initially selected, you need to perform a hard reset.

# Supplied applications

The following applications are supplied with your CLIÉ handheld.

➔ For details, refer to the “CLIÉ Application Manual” (HTML format).

## Types of applications

There are two types of applications:

- **Applications already installed on your CLIÉ handheld**
- **Applications you need to install on your computer**

➔ For details on how to install applications, refer to “Installing the supplied applications on your CLIÉ™ handheld” on page 25.

## Basic application



### CLIÉ Organizer

This is a basic application that manages all applications for your CLIÉ handheld.

You can tap the application tabs to start the following applications of **CLIÉ Organizer** (PIM).

#### CLIÉ Organizer applications (PIM)

- **Date Book**
- **Address Book**
- **To Do List**
- **Free Notes**
- **Memo Pad**
- **Viewer**
- **Reference**

#### Another CLIÉ Organizer application

- **Applications**

➔ For details on **CLIÉ Organizer**, refer to “Starting an application from CLIÉ Organizer” on page 28.

## Other applications

### Applications that are run on your CLIÉ handheld.

To start the following applications, tap the application icon in the **Applications** screen, which can be displayed by tapping [Applica...] in **CLIE Organizer**.



#### Address Book

You can manage addresses and telephone numbers.



#### Applications

You can display the CLIE Launcher.

➔ For details on the CLIE Launcher, refer to “CLIÉ™ handheld basic operations: Using the CLIE Launcher” in the “Handbook” (PDF format).



#### Audio Player

You can play back audio files saved on a “Memory Stick” media.

Prepare a “Memory Stick” media. You can also use separately sold headphones/earphones.



#### Calculator

You can calculate with your CLIÉ handheld. You can save and recall calculations with the calculator's memory.



#### Card Info

You can check the used and free memory space in a “Memory Stick” media.

Prepare a “Memory Stick” media.



#### CLIE Camera

You can take pictures using the built-in camera of your CLIÉ handheld.

## CLIE Mail

You can browse, send, and receive e-mail messages with your CLIE handheld.

### Notes

- You must be connected to the Internet beforehand to send and receive e-mail messages.
- When you want to send an e-mail message from your computer to your CLIE handheld, you need to install **CLIE Mail Conduit** on your computer from “CLIE Utilities” of the Installation CD-ROM Menu.

## CLIE FAQ

You can refer to **CLIE FAQ** for questions about operations on your CLIE handheld.

## CLIE Files

You can exchange data (copy, move, delete) between your CLIE handheld and “Memory Stick” media.

Prepare a “Memory Stick” media.

## CLIE Viewer

You can manage and view image files and voice memos after selecting from the list.

## Date Book

You can manage schedule events.

## Data Import

With **Data Export** installed on your computer, you can install applications or copy data from your computer to a “Memory Stick” media in your CLIE handheld, without using the HotSync<sup>®</sup> operation.

## **HotSync**

You can synchronize data between your CLIÉ handheld and computer.  
You can also save backup data on your computer.

## **Macromedia Flash Player 5**

You can play the Macromedia Flash files.

Prepare a “Memory Stick” media.

## **Memo Pad**

You can take text format memos.

## **Memory Stick Backup**

You can make a backup of an application or data on your CLIÉ handheld to a “Memory Stick” media.

Prepare a “Memory Stick” media.

## **Mobile Manager** **(for customers in the supported areas only)**

With **Mobile Connection Wizard** installed on your computer, you can simply set up your CLIÉ handheld on a network.

Install **Mobile Connection Wizard** on your computer from “CLIÉ Utilities” of the Installation CD-ROM Menu.

➔ For details on how to install **Mobile Manager**, refer to “Mobile Manager” in the “CLIÉ Application Manual” (HTML format).

### **Note**

You must be connected to the Internet beforehand.

## **Movie Player**

You can play still pictures and movies with sound together.

Prepare a “Memory Stick” media.

## **NetFront v3.1 for CLIE**

You can browse website.

### **Note**

You must be connected to the Internet beforehand.

## **PicSel Viewer for CLIE**

You can view documents created in Microsoft Word/Excel/PowerPoint® or PDF files on your CLIE handheld.

Prepare a “Memory Stick” media.

## **Preferences**

You can customize various settings for your CLIE handheld.

## **Security**

You can lock your CLIE handheld with a password.  
You can also set to hide or mask private data.

## **SMS** **(for models containing the Bluetooth® wireless technology only)**

You can send/receive messages from your CLIE handheld via a connected GSM device, such as a mobile phone.

## **Sound Utility**

You can manage alarm sounds converted with **Voice Recorder**.

## **To Do List**

You can manage tasks and things to do.

## **Voice Recorder**

You can record and play voice memos using the built-in microphone.

## **Welcome**

You can go back to the initial settings in the **Welcome** screen.



## Intellisync Lite

You can synchronize data of **Date Book**, **Address Book**, **To Do List**, etc., on your CLIÉ handheld with **Microsoft Outlook** or **Lotus Organizer** on your computer.

Install **Intellisync Lite** on your computer from “CLIÉ Utilities” of the Installation CD-ROM Menu, and make sure you connect your CLIÉ handheld to your computer with the USB cable and plug adapter.



## Mobile Connection Wizard (for customers in the supported areas only)

With **Mobile Manager** on your CLIÉ handheld, you can simply set up your CLIÉ handheld on a network.

Install **Mobile Connection Wizard** on your computer from “CLIÉ Utilities” of the Installation CD-ROM Menu.

### Note

You must be connected to the Internet beforehand.

## SonicStage

You can manage and create music files on your computer, to be played back with your CLIÉ handheld.

Install **SonicStage** on your computer from “CLIÉ Audio” of the Installation CD-ROM Menu, and prepare a “MagicGate Memory Stick” media.



# Using CLIÉ Manuals with your computer

You can also use the other manuals of your CLIÉ handheld that are stored on the supplied Installation CD-ROM. The manuals are to be read on your computer.

## Note

Prior to using the manuals, refer to “Step 1: Installing Palm™ Desktop for CLIÉ on your computer” on page 18 to install **Palm™ Desktop for CLIÉ**. **CLIÉ Manuals** will be installed at the same time.

## Tip

You can open **CLIÉ Manuals** from the supplied Installation CD-ROM.

- For details, refer to “Opening CLIÉ Manuals from the supplied Installation CD-ROM” on page 60.

## Manuals Overview

You can read each manual installed on your computer to use your CLIÉ handheld more effectively.

### How to use the supplied applications

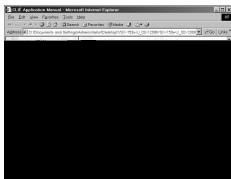

### CLIÉ Application Manual

“CLIÉ Application Manual” is an HTML format manual.

It explains how to use the supplied applications in detail.



# Opening CLIÉ Manuals

Follow the steps below to open **CLIÉ Manuals**.

- 1 Double-click  (CLIÉ Manuals PEG-TH55) on the Windows desktop.  
The **CLIÉ Application Guide PEG-TH55** window is displayed.

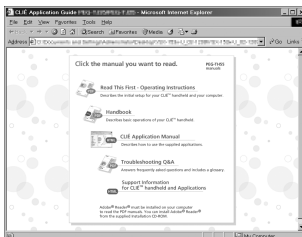

## Tip

You can also click [Start], select [Programs] ([All Programs] for Windows XP)-[Sony Handheld]-[About PEG-TH55], and click [CLIÉ Manuals] to start **CLIÉ Manuals**.

- 2 Click the manual you want to read.  
The selected manual is displayed.

## Note

To read the PDF manuals, **Adobe Reader** must be installed on your computer. If it is not installed on your computer, you can install it from the supplied Installation CD-ROM.

➔ For details on how to use PDF manuals or installation, refer to “Reading the PDF manuals on your computer” on page 61.

## Opening CLIÉ Manuals from the supplied Installation CD-ROM

- 1** Insert the supplied Installation CD-ROM into the CD-ROM drive of your computer.  
The **Installation CD-ROM** window is displayed.
- 2** Click [Finish] at the bottom left of the **Installation CD-ROM** window.
- 3** Double-click  (My computer) on the Windows desktop.  
For Windows XP, click [Start] at the bottom left of the Windows desktop, then click [My Computer] on the displayed screen.
- 4** Right-click [CLIE], and select [Open].

**Reading a manual in PDF format:** Double-click [EN]-[Manuals]-[PEG-TH55], and the manual icon you want to read.

**Reading "Read This First (Operating Instructions)" in PDF format:** Double-click [EN]-[Manuals]-[PEG-TH55]-[Manual Portal]-[index\_portal.html] and click [ReadThisFirst.pdf].

**Reading "Handbook" in PDF format:** Double-click [EN]-[Manuals]-[PEG-TH55]-[Manual Portal]-[index\_portal.html] and click [Handbook.pdf].

**Reading "Troubleshooting Q&A" in PDF format:** Double-click [EN]-[Manuals]-[PEG-TH55]-[Manual Portal]-[index\_portal.html] and click [FAQ.pdf].

**Reading "CLIÉ Application Manual" in HTML format:** Double-click [EN]-[Manuals]-[PEG-TH55]-[Manual Portal]-[index\_portal.html] and click [CLIÉ Application Manual].

# Reading the PDF manuals on your computer

The following explains how to read the PDF format manuals on your computer.

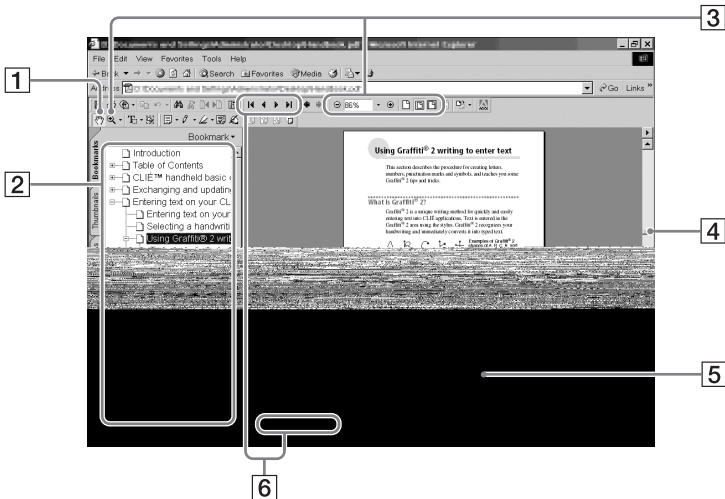

- 1 Use the Hand Tool to scroll the displayed page.
- 2 Bookmarks are displayed. Click each title to display the page. Click **+** to display the directories of the chapters.
- 3 Buttons for zooming in/out the page.
- 4 Click here and drag to scroll the page.
- 5 You can display the linked page by clicking a point where  is displayed.
- 6 Buttons for displaying the previous or next page. You can also enter a page number you want to display at the bottom of the page number area.

## Installing Adobe Reader on your computer

If **Adobe Reader** is not installed on your computer, follow the steps below to install it.

- 1 Quit all applications running on Windows®.
- 2 Insert the supplied Installation CD-ROM into the CD-ROM drive of your computer. The **Installation CD-ROM** window is displayed.
- 3 Click [CLIÉ Basic] in the left side of the window.

Continued on next page

**4** Click [Install] to install **Adobe Reader**.  
Follow the on-screen instructions.

**5** Click [Finish].  
The **Installation CD-ROM** window closes.

## Reading the HTML manual on your computer (CLÍÉ Application Manual)

The following explains how to read the HTML format manual on your computer.

### Note

You need Microsoft Internet Explorer version 5.0 or later to display “CLÍÉ Application Manual” properly.

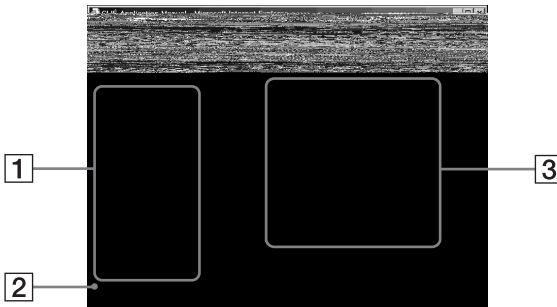

- 1** Click any application to display the explanation in detail.
- 2** Click to display the index of the supplied applications.
- 3** Click any application group to display the group. Then you can select a desired application from that group to display further instructions.

# Troubleshooting

If you have problems, please follow the procedure below.  
Make note of any messages or alerts that are displayed.

## Step 1: Refer to CLIE FAQ, this manual, “Troubleshooting Q&A”, or the manual of each application

- Refer to **CLIE FAQ** on your CLIE handheld
- Read “Frequently Asked Questions” on page 65.
- Refer to the “Troubleshooting Q&A” (PDF format).
- Click  (CLIE Manuals PEG-TH55) on the Windows desktop for more information on applications.

## Step 2: Refer to the Sony CLIE handheld Support website

Double-click  (CLIE Info) on the Windows desktop, and select [CLIE™ Handheld Support].

### Note

Thousands of third party add-on applications are available for the Palm OS® platform. Sony does not support third party applications. If you are having problems with a third party application, please contact the publisher of that application.

# Making a backup of the data or applications on your CLIÉ handheld

Sony recommends that you make a backup of your data in case of unexpected problems. Backing up your data will ensure that it can be restored again on your CLIÉ handheld, even if you have to perform a hard reset.

## Making a backup using Memory Stick Backup

Use “Memory Stick” media and **Memory Stick Backup** on your CLIÉ handheld to back up data and applications on your CLIÉ handheld.

➔ **“Memory Stick” media (sold separately) is required.**

For details, refer to “Backing up your CLIÉ™ handheld data and applications: Backing up data and applications to “Memory Stick” media using Memory Stick Backup” in the “Handbook” (PDF format).

## Making a backup using the HotSync® operation

Data or applications on your CLIÉ handheld is backed up to your computer when the HotSync® operation is performed. If you need to perform a hard reset, this would erase all user data and applications stored on your CLIÉ handheld. However, the erased data and applications can be restored with the next HotSync® operation.

### Notes

- Some add-on applications (not installed at the factory), and some application data and settings may not be backed up using the HotSync® operation. However, a backup of data on your CLIÉ handheld can be made with **Memory Stick Backup**.  
To make proper backups, using **Memory Stick Backup** periodically is recommended.
- When you need to restore data, and so on, make sure that you perform the HotSync® operation immediately after you perform a hard reset. Otherwise, if you create new data on your CLIÉ handheld between the hard reset and performing the HotSync® operation, the data may be lost.



# Frequently Asked Questions

If the solutions mentioned in this section do not solve your problem, refer to the “Troubleshooting Q&A” (PDF format).

## My CLIÉ handheld does not work properly (page 67)

- I cannot turn on my CLIÉ handheld
- The screen is not displayed even though the POWER LED is on
- My CLIÉ handheld does not respond
- My CLIÉ handheld keeps turning itself off
- My CLIÉ handheld does not produce any sounds
- The backlight does not turn on when I adjust the brightness level
- The LCD display cannot be viewed properly
- Applications do not operate properly after a soft reset is performed
- I cannot use the Jog Dial™ navigator

## Error messages (page 69)

- An error message appears repeatedly
- The message “Invalid process” appears when an application is started

## I cannot enter text properly (page 70)

- My CLIÉ handheld does not recognize handwritten characters (when using **Graffiti® 2**)
- My CLIÉ handheld does not recognize handwritten characters (when using **Decuma Input**)

## The HotSync® problems (page 71)

- I cannot perform the local HotSync® operation
- I cannot start the HotSync® operation by tapping  (HotSync) on the **HotSync** screen
- I cannot cancel the HotSync® operation
- It takes a long time to complete the HotSync® operation
- Data cannot be synchronized with some applications using the HotSync® operation
- I cannot back up some data using the HotSync® operation

- **Palm™ Desktop for CLIÉ** does not start or cannot be selected from the menu
- **CLIE Organizer for PC** does not start or cannot be selected from the menu
- **HotSync Manager** does not start.  (HotSync) is not displayed in the task tray (Notification area) at the bottom right of my computer window

### **I cannot play music (page 75)**

- Audio files cannot be read or played

### **I cannot use “Memory Stick” media (page 75)**

- My CLIÉ handheld does not recognize “Memory Stick” media, or an error occurs

## My CLIÉ handheld does not work properly

### I cannot turn on my CLIÉ handheld

- ▶ Is the POWER/HOLD switch of your CLIÉ handheld in HOLD mode (page 88) ?  
Your CLIÉ handheld does not work when the POWER/HOLD switch is in HOLD mode. Make sure you release HOLD mode.

#### Note

If you press the application buttons, Data Assistant button, or CAPTURE button, slide down the VOICE REC switch, or open the camera lens cover during HOLD mode, the POWER LED blinks 3 times. However, your CLIÉ handheld does not operate.

- ▶ Has the battery power of your CLIÉ handheld run out?  
Connect your CLIÉ handheld to the AC power adapter with the plug adapter, then allow it to be charged for a few minutes before turning it on. If it turns on, continue charging for approximately five hours and then perform a soft reset (page 47).
- ▶ Is the connector between your CLIÉ handheld and the plug adapter dirty?  
You cannot charge your CLIÉ handheld if the connector is dirty. Connect and disconnect your CLIÉ handheld and the plug adapter several times to clean the connector.
- ▶ Perform a soft reset by pressing the RESET button of your CLIÉ handheld (page 47).

### The screen is not displayed even though the POWER LED is on

- ▶ Is the POWER/HOLD switch of your CLIÉ handheld in HOLD mode (page 88) ?  
The screen is not displayed when the POWER/HOLD switch is in HOLD mode. Make sure you release HOLD mode.
- ▶ Perform a soft reset by pressing the RESET button of your CLIÉ handheld (page 47).

### My CLIÉ handheld does not respond

- ▶ Is the POWER/HOLD switch of your CLIÉ handheld in HOLD mode (page 88) ?  
Your CLIÉ handheld does not operate when the POWER/HOLD switch is in HOLD mode. Make sure you release HOLD mode.
- ▶ Is your CLIÉ handheld placed near the IR port of your computer?  
Move your CLIÉ handheld away from the IR port of your computer except when performing the IR HotSync® operation, as a malfunction may occur. You can also disable the IR feature by selecting [Off] next to [Beam Receive:] in [General] of the **Preferences** screen.
- ▶ Perform a soft reset by pressing the RESET button of your CLIÉ handheld (page 47).

---

## My CLIÉ handheld keeps turning itself off

- ▶ Your CLIÉ handheld is designed to turn itself off after a period of inactivity (Automatic power-off). You can set the automatic power-off time by selecting time for [Auto-off After:] in [General] of the **Preferences** screen.

### Note

The maximum idle time is 3 minutes.

- ➔ For details, refer to “Customizing your CLIÉ™ handheld (Preferences): Setting the automatic power-off time” in the “Handbook” (PDF format).
- ▶ Did you set [After a preset delay] from [Auto Lock Handheld:] in the **Security** screen? If you set [After a preset delay] from [Auto Lock Handheld:], your CLIÉ handheld may turn off after a shorter period even if you set the automatic power-off time.
  - ➔ For details, refer to “Protecting your data with a password: Locking your CLIÉ handheld with a password (Data protection)” in the “Handbook” (PDF format).

---

## My CLIÉ handheld does not produce any sounds

- ▶ Is [System Sound:] in [General] of the **Preferences** screen set to [Off]?
  - ➔ For details, refer to “Customizing your CLIÉ™ handheld (Preferences): Setting sounds” in the “Handbook” (PDF format).
- ▶ Adjust the volume settings in the **Adjust Volume** dialog box displayed by tapping  in the status bar (page 94).

### Tip

If [Muting] is selected in the **Adjust Volume** dialog box, all sounds, including audio, are muted.

---

## The backlight does not turn on when I adjust the brightness level

- ▶ If the brightness is set to the lowest level, the display may be illegible. However, this is not a malfunction.

---

## The LCD display cannot be viewed properly

- ▶ Depending upon the angle of vision, the brightness may be uneven, however, this is not a malfunction. You can adjust the brightness level in the **Adjust Brightness** dialog box displayed by tapping  at the bottom left of the Graffiti 2 writing area.
- ▶ If the backlight is off, you can turn it on by sliding down the POWER/HOLD switch and hold it for more than two seconds.

---

## Applications do not operate properly after a soft reset is performed

- ▶ If you encounter application problems (such as improper operations, unusual display, or freezing during a soft reset) after you performed a reset, the reset may not be completed properly. In such a case, perform a soft reset once again (page 47). If you still cannot solve your problem, try a hard reset (page 48).

### Notes on performing a reset

- After performing a reset, do not press the RESET button of your CLIÉ handheld again until the **Preferences** screen or the **Setup** screen is displayed.
- If you perform a hard reset, all records and add-on applications stored on your CLIÉ handheld will be deleted.

---

## I cannot use the Jog Dial™ navigator

- ▶ The Jog Dial™ navigator (page 87) is not available for some applications.

## Error messages

---

### An error message appears repeatedly

- ▶ Perform a soft reset by pressing the RESET button of your CLIÉ handheld (page 47).

---

### The message “Invalid process” appears when an application is started

- ▶ If there is insufficient memory space in your CLIÉ handheld or “Memory Stick” media, applications may not work properly. Delete any unnecessary data/files.

#### Tip

You can check the free memory space in your CLIÉ handheld or “Memory Stick” media by tapping  (MS) in the status bar and selecting [▼ Handheld] or [▼ MS] next to [Device:] in the displayed **Media Info** dialog box.

## I cannot enter text properly

---

### My CLIÉ handheld does not recognize handwritten characters (when using Graffiti® 2 )

- ▶ To have your CLIÉ handheld recognize handwritten characters entered with the stylus, you must use **Graffiti® 2**.
  - ➔ For details, refer to “Entering text on your CLIÉ™ handheld: Using Graffiti® 2 writing to enter text” in the “Handbook” (PDF format).
- ▶ Make sure you enter the Graffiti® 2 strokes in the Graffiti® 2 writing area.
- ▶ Make sure you enter the Graffiti® 2 strokes for letters in the left side of the Graffiti® 2 writing area and numbers in the right side.
- ▶ Check that **Graffiti® 2** is not shifted into Symbol mode.
  - ➔ For details, refer to “Entering text on your CLIÉ™ handheld: Using Graffiti® 2 writing to enter text” in the “Handbook” (PDF format).
- ▶ If the letter “L” is registered as a menu command for an application, the letters “K”, “T”, “I”, and “X” will not work as menu command.
- ▶ How to enter Graffiti® 2 characters faster and more accurately.
  - ➔ For details, refer to “Entering text on your CLIÉ™ handheld: Using Graffiti® 2 writing to enter text” in the “Handbook” (PDF format).
- ▶ Adjust the stylus periodically to reduce problems associated with stylus writing and reading, in **Graffiti® 2** for example.
  - ➔ For details, refer to “Customizing your CLIÉ™ handheld (Preferences): Adjusting the Digitizer” in the “Handbook” (PDF format).

---

### My CLIÉ handheld does not recognize handwritten characters (when using Decuma Input)

- ▶ Refer to “Decuma Input” in the “CLIÉ Application Manual” (HTML format) and try writing again using **Decuma Input**.
- ▶ If your handwriting cannot be recognized correctly as numbers or special characters in General characters mode, switch the Decuma Input area from General characters mode to Numbers and special characters mode.
  - ➔ For details, refer to “Entering text on your CLIÉ™ handheld: Using Decuma Input to enter text” in the “Handbook” (PDF format) or “Decuma Input” in the “CLIÉ Application Manual” (HTML format).
- ▶ **Decuma Input**, **Graffiti®**, and **Graffiti® 2** are different input systems, and **Decuma Input** does not recognize the strokes of either **Graffiti®**, or **Graffiti® 2**.

# The HotSync® problems

## I cannot perform the local HotSync® operation

### Verifying your CLIÉ handheld

- ▶ Is the connector between your CLIÉ handheld and the plug adapter dirty?  
Connect and disconnect your CLIÉ handheld and the plug adapter several times to clean the connector.
- ▶ Are your CLIÉ handheld with the plug adapter and the USB cable properly connected (page 20)?
- ▶ Is there sufficient memory space in your CLIÉ handheld?  
Delete any unnecessary data/files and then perform the HotSync® operation again.
- ▶ Are you using the same user name that is used for another CLIÉ handheld?  
Change the user name.

### Verifying your computer

- ▶ Are **Palm™ Desktop for CLIÉ** and **CLIE Organizer for PC** installed?



#### Note

**CLIE Organizer for PC** cannot be installed before installing **Palm™ Desktop for CLIÉ** on your computer.

- ▶ Is the operating system on your computer compatible?  
The following operating systems are compatible with your CLIÉ handheld. Operating systems other than the following are not supported.
  - Microsoft Windows 2000 Professional
  - Microsoft Windows Me
  - Microsoft Windows XP Home Edition
  - Microsoft Windows XP Professional

#### Note

Upgrade versions of operating systems are not supported.

- ▶ If you are using Windows 2000 Professional or Windows XP, log in as an “Administrator.”
- ▶ Is the USB cable properly connected to your computer (page 20)?
- ▶ Is  (HotSync) displayed in the task tray (Notification area) at the bottom right of your computer window?  
If not, click [Start], select [Programs] ([All Programs] for Windows XP)-[Sony Handheld], and click [HotSync Manager] to start **HotSync Manager**.
- ▶ Is [Local USB] in the menu selected? (You can display this by clicking  (HotSync) in the task tray (Notification area).)  
If not, select [Local USB].

- ▶ Is the USB port active?  
Check whether the USB port works normally by connecting another USB device, such as a USB mouse.
- ▶ If you use an extended terminal devices for laptop computers, such as a port replicator, you may not be able to use either the port replicator or the USB port of your computer.
- ▶ Quit all applications other than **CLIE Organizer for PC** (or **Palm™ Desktop for CLIE**).

If you cannot perform the HotSync® operation even after following the above instructions, perform a soft reset by pressing the RESET button of your CLIE handheld (page 47).

**For particular problems regarding the HotSync® operations, refer to the following.**

---

### **I cannot start the HotSync® operation by tapping (HotSync) on the HotSync screen**

- ▶ Ensure [Local] and [Cradle/Cable] are selected in the **HotSync** screen.
- ▶ Perform a soft reset by pressing the RESET button of your CLIE handheld (page 47).

---

### **I cannot cancel the HotSync® operation**

- ▶ You may not be able to stop the HotSync® operation by tapping [Cancel] for over ten seconds after you start the USB HotSync® operation. Try again after a while.
- ▶ If you disconnect your CLIE handheld and computer during the HotSync® operation, the HotSync® operation will not perform correctly.  
In such a case, perform a soft reset (page 47).
- ▶ If you cannot stop the HotSync® operation even by tapping [Cancel], perform a soft reset (page 47).

---

### **It takes a long time to complete the HotSync® operation**

- ▶ Depending on the application you are using, it may require time to complete the HotSync® operation because of large data/file sizes.

---

### **Data cannot be synchronized with some applications using the HotSync® operation**

- ▶ Do the user names for **CLIE Organizer for PC** and **Palm™ Desktop for CLIE** match the one for your CLIE handheld?  
In **CLIE Organizer for PC** and **Palm™ Desktop for CLIE**, select the user name corresponding to your CLIE handheld user name.



- ▶ Is the application set not to synchronize files?  
Click  (HotSync) in the task tray (Notification area) at the bottom right of your computer window and select [Custom...] from the menu. Check that the application is set to synchronize files.
- ▶ Is third party backup or synchronization software installed on your computer or CLIÉ handheld?  
In such a case, you may not synchronize some data/files using **CLIE Organizer for PC** (or **Palm™ Desktop for CLIÉ**).
- ▶ You can synchronize **Date Book**, **Address Book**, **To Do List**, and **Memo Pad** of your CLIÉ handheld with **Microsoft® Outlook** or **Lotus Organizer** after installing **Intellisync Lite** on your computer.  
However, if Date Book data is assigned to synchronize with **Microsoft® Outlook** or **Loutus Organizer** in **Intellisync Lite**, Date Book data cannot be synchronized with **CLIE Organizer for PC** and **Palm™ Desktop for CLIÉ**.  
Do not assign Date Book data to synchronize with **Microsoft® Outlook** or **Loutus Organizer** in **Intellisync Lite**.
  - For details, refer to "Intellisync Lite" in the "CLIÉ Application Manual" (HTML format).
- ▶ Is there sufficient memory space in your CLIÉ handheld?  
Delete unnecessary data/files and then perform the HotSync® operation again.
- ▶ Is private data hidden in the **Security** screen?  
Hidden data cannot be displayed in **CLIE Organizer for PC** (or **Palm™ Desktop for CLIÉ**). When you want to display hidden data, select [Show Records] below [Current Privacy:] in the **Security** screen and enter the password.

## I cannot back up some data using the HotSync® operation

- ▶ Some add-on applications (not installed at the factory), and some application data and settings may not be backed up using the HotSync® operation. However, a backup of data on your CLIÉ handheld can be made with **Memory Stick Backup**.  
To make proper backups, using **Memory Stick Backup** periodically is recommended.
  - For details, refer to "Backing up your CLIÉ™ handheld data and applications: Backing up data and applications to "Memory Stick" media using Memory Stick Backup" in the "Handbook" (PDF format).

## Palm™ Desktop for CLIÉ does not start or cannot be selected from the menu

- ▶ Is **Palm™ Desktop for CLIÉ** properly installed on your computer?  
The hardware or software of your computer may not be compatible with **Palm™ Desktop for CLIÉ**. Uninstall **Palm™ Desktop for CLIÉ** and reinstall it.

---

## **CLIE Organizer for PC does not start or cannot be selected from the menu**

- ▶ Is **CLIE Organizer for PC** properly installed on your computer?  
The hardware or software of your computer may not be compatible with **CLIE Organizer for PC**. Uninstall **CLIE Organizer for PC** and reinstall it.
- ▶ Is **Palm™ Desktop for CLIE** installed on your computer?  
**CLIE Organizer for PC** cannot be installed before installing **Palm™ Desktop for CLIE** on your computer.

---

## **HotSync Manager does not start. (HotSync) is not displayed in the task tray (Notification area) at the**

### **Do not use a USB hub**

If you connect your CLIÉ handheld to your computer via a USB hub, you may not be able to perform the HotSync® operation properly. Make sure you connect the USB cable directly to a USB port of your computer.

Some computers have the hub function built into their internal circuitry. Contact your computer manufacturer to check whether the USB port of your computer is connected to an internal USB hub.

### **Check that the USB port of your computer is enabled**

Test the USB port with another device, such as a USB mouse. If that device does not work, check the BIOS setting of your computer.

In addition, check the setting in the Device Manager: Right-click [My Computer] and select [Properties] from the menu. (If you are using Windows 2000 Professional/Windows XP, click [Hardware].) Click [Device Manager] and check that [USB controller] is displayed in the **Device Manager** window.

### **If USB controller is not displayed**

➔ For details, refer to the manual of your computer.

## **I cannot play music**

### **MP3 files cannot be read or played**

- ▶ Check that the MP3 files are located in [PALM/Programs/MSAUDIO] directory on the “Memory Stick” media.
- ▶ Check that the file format is supported by your CLIÉ handheld.
  - ➔ For details on file formats supported by your CLIÉ handheld, refer to “Audio Player” in the “CLIÉ Application Manual” (HTML format).

## **I cannot use “Memory Stick” media**

### **My CLIÉ handheld does not recognize “Memory Stick” media, or an error occurs**

- ▶ Remove the “Memory Stick” media and try inserting it again.
- ▶ If the terminal part of the “Memory Stick” media is dirty, your CLIÉ handheld cannot read the data/files. Wipe the terminal with a soft cloth, such as a cotton pad.
- ▶ You cannot use “Memory Stick” media that is formatted in a device other than your CLIÉ handheld. Format it on your CLIÉ handheld.
- ▶ When the battery power of your CLIÉ handheld is running low, data/files on “Memory Stick” media may not be displayed. Charge the battery of your CLIÉ handheld.

# Customer Support and Customer Registration

- **For customer support information**

Double-click  (CLIÉ Info) on the Windows desktop, and select [CLIÉ™ Handheld Support].

- **For online customer registration (For customers in the U.S.A. , Canada, and Europe only)**

Double-click  (CLIÉ Info) on the Windows desktop, and select [Sony CLIÉ™ Registration].

# Notes on use

## ..... Handling your CLIÉ handheld

- Make sure you do not scratch or damage your CLIÉ handheld's screen. Always use the supplied stylus to tap on the screen. Do not use a writing pen, pencil, or other sharp object on the screen.
- Do not expose your CLIÉ handheld to rain or moisture. Should water enter the circuitry through the buttons and switches, your CLIÉ handheld may be damaged.
- Your CLIÉ handheld's screen is made of glass. Do not drop or submit your CLIÉ handheld to excessive shock. Do not carry your CLIÉ handheld in your pocket. If you sit down with your CLIÉ handheld in the pocket, your CLIÉ handheld may break.
- Avoid using or storing your CLIÉ handheld in locations subject to:
  - extremely high temperatures, such as inside a car exposed to the sun, or near a heater.
  - direct sunlight
  - high humidity
  - excessive dust

### **Cleaning your CLIÉ handheld**

- Clean your CLIÉ handheld with a soft, dry cloth.
- Wipe any dirt and dust from the camera lens by using a soft damp cotton swab.

### **If condensation occurs**

Turn off your CLIÉ handheld for approximately one hour to clear condensation before use. If you leave condensation within the camera lens, you may not be able to take clear pictures.

### **Cleaning the stylus**

Tapping or dragging the screen with a dirty stylus may damage the screen surface.

Wipe the stylus with a dry cloth when it gets dirty.

# .....

## Battery considerations

### Battery safety

To avoid battery leakage, heat generation, firing, or bust, observe the following:

- Do not use any other type of battery in your CLIÉ handheld.
- Do not charge the battery in any other way than as specified in this manual.
- Do not throw the battery into fire.
- Do not attempt to short-circuit the battery.
- Do not take the battery apart.
- Do not modify the battery.
- Do not heat the battery in an oven or micro wave.
- Do not charge the battery near an open flame or in direct sunlight.
- Do not leave the battery in a car.
- Do not subject your CLIÉ handheld or the battery to excessive shock.
- Take care not to drop your CLIÉ handheld, give pressure to it with a sharp object, or crush with a heavy object.
- If you have skin contact with battery leakage or get some in your eye, wash with water immediately and consult a doctor.

### Charging

- It takes approximately five hours to charge your CLIÉ handheld when the battery is empty.
- If you charge your CLIÉ handheld every day, it takes only a few minutes to charge the battery.
- You can operate your CLIÉ handheld while the battery is being charged.

### Battery life

Battery life varies depending on the conditions and environment where you use your CLIÉ handheld and applications used.

➔ For details about battery life, refer to “Specifications” on page 80.

### Conserving the battery

- Turn off the backlight under good lighting conditions.
  - ➔ For details on the backlight, refer to “POWER/HOLD switch” on page 88.
- Change the automatic power-off time setting so that your CLIÉ handheld will automatically turn off after a short period of inactivity.
  - ➔ For details, refer to “Customizing your CLIÉ™ handheld (Preferences): Setting the automatic power-off time” in the “Handbook” (PDF format).

## Using peripheral devices

If a low battery warning is displayed while using peripheral devices, charge your CLIÉ handheld immediately. If you continuously use it, it automatically turns off and cannot operate until you charge it.

## When the battery power gets low

- When the battery power gets low, a warning message is displayed on the screen, “Memory Stick” media becomes inaccessible, and the backlight adjustment no longer operates. If this occurs, connect your CLIÉ handheld to wall outlet and perform the HotSync® operation.
- If your CLIÉ handheld does not turn on when you slide down the POWER/HOLD switch, charge your CLIÉ handheld immediately.
- The remaining battery indicator may not always reflect the actual battery power. To prevent loss of battery power, charge your CLIÉ handheld frequently.
- You do not have to replace batteries. When battery power gets low, charge your CLIÉ handheld immediately. Never disassemble your CLIÉ handheld to take out the battery.

### **Do not let the remaining battery power indicator reach 0**

If you leave your CLIÉ handheld in an uncharged state (the remaining battery power indicator reaches 0 ) , all user data stored on your CLIÉ handheld will be erased. To avoid this, you should charge your CLIÉ handheld frequently.

## Other information

Your CLIÉ handheld may get warm if turned on for long periods of time. This is not a malfunction.

## About replacing the battery

### **CAUTION**

Please contact with your nearest Sony dealer in connection with this product with problem.

# Specifications

## OS

Palm OS® 5 (Ver.5.2)

## CPU

Sony Handheld Engine

## Memory

Total: 32 MB (RAM)

User memory available:

Approx. 32 MB

## External input/output

Interface connector

IrDA (1.2)

Bluetooth® (for models containing the Bluetooth® wireless technology only)

Wireless LAN (IEEE 802.11b)

“Memory Stick” slot

## Display

TFT color display with backlight,  
480 × 320 dots, 65,536 colors

## Other functions

Monaural Speaker

Monaural Microphone

Jog Dial™ navigator

BACK button

Left/Right buttons

REC LED

POWER LED

WLAN LED (WIRELESS LAN  
LED)

“Memory Stick” LED

## Dimensions (excluding projections)

Approx.  $3 \times 4 \frac{7}{8} \times \frac{17}{32}$  inches  
(73.3 × 121.5 × 13.4 mm) (w/h/d)  
(when removing the protective cover)

Approx.  $3 \times 4 \frac{7}{8} \times \frac{5}{8}$  inches  
(73.3 × 121.5 × 15.7 mm) (w/h/d)  
(when attaching the protective cover)

## Weight

Approx. 5.8 oz (165 g)  
(including the supplied stylus)  
Approx. 6.5 oz (185 g)  
(when attaching the protective cover)

## Operating temperature

41 °F to 95 °F (5 °C to 35 °C)

## Audio frequency response

20 Hz to 20,000 Hz

## Audio recording format

ATRAC3

MP3 (32k~320kbps)

## Sampling frequency

44.1 kHz (ATRAC3, MP3)

## Maximum recording time

ATRAC3 format

(when using a 128MB “MagicGate  
Memory Stick” media, sold  
separately):

Approx. 120 minutes

(bit rate: 132 kbps)

Approx. 160 minutes

(bit rate: 105 kbps)

Approx. 240 minutes

(bit rate: 66 kbps)

MP3 format

(when using a 128MB “Memory  
Stick” media, sold separately):

Approx. 65 minutes

(bit rate: 256 kbps)

Approx. 130 minutes

(bit rate: 128 kbps)

Approx. 170 minutes

(bit rate: 96 kbps)



## Voice encoding/decoding format

- IMA ADPCM (1ch, 4bit)
- SP mode (22 kHz)
- LP mode (8 kHz)

## Maximum audio recording time

- (when using a 128MB “Memory Stick” media, sold separately):
- SP mode: Approx. 190 minutes
- LP mode: Approx. 520 minutes

## Output

- Headphones/Earphones: Stereo mini-jack

## Picture size (when recording)

- 640 × 480, 320 × 480(vertical frame),
- 320 × 240, 160 × 120 dots

## Formats (when recording)

- Image file: JPEG (DCF) format

## Picture size (when viewing)

- On the CLIE handheld display
- Image file: 320 × 480, 320 × 240, 160 × 120 dots
- Movie file: 426 × 320, 320 × 240, 160 × 112 dots

## Formats (when viewing)

- Image file: JPEG (DCF) format
- Movie file: QuickTime file format\*, MPEG-1 (MPEG Movie)

\* The playback is only capable for the files created for Mobile Movie products.

## Maximum image file recording capacity

- (when using a 128MB “Memory Stick” media in the standard mode)
- 640 × 480 dots: Approx. 1,000 files
- 320 × 480 dots: Approx. 1,500 files
- 320 × 240 dots: Approx. 2,000 files
- 160 × 120 dots: Approx. 6,000 files

## Power requirements

- AC power adapter (supplied):
- DC 5.2 V (dedicated connector)
- (Use an appropriate AC cord from the supplied AC cords)

- Battery:
- Lithium-ion polymer battery

## Battery life

- Operating PIMs (Personal Information Management applications):
- Approx. 15 days
- (when PIMs, such as **Date Book**, are operated for 30 minutes per day with the backlight off)
- Approx. 9 days
- (when PIMs, such as **Date Book**, are operated for 30 minutes per day with the backlight on\*)

- Playing audio files (in continuous mode):
- Approx. 24.5 hours
- (when playing audio files in HOLD mode)
- Approx. 7 hours
- (when playing audio files not in HOLD mode and the backlight on\*)

- Viewing movie files (in continuous mode):
- Approx. 7.5 hours
- (when viewing movie files with the backlight off)

- Viewing movie files (in continuous mode):
- Approx. 7.5 hours
- (when viewing movie files with the backlight off)

- Viewing movie files (in continuous mode):
- Approx. 7.5 hours
- (when viewing movie files with the backlight off)

- Viewing movie files (in continuous mode):
- Approx. 7.5 hours
- (when viewing movie files with the backlight off)

- Viewing movie files (in continuous mode):
- Approx. 7.5 hours
- (when viewing movie files with the backlight off)

*Continued on next page*

Approx. 4 hours  
(when viewing movie files with the  
backlight on\*)

Recording voice memos (in  
continuous mode):

Approx. 19.5 hours  
(when recording voice memos in  
HOLD mode)

Approx. 6 hours  
(when recording voice memos not  
in HOLD mode and the backlight  
on\*)

Performing data communication (for  
models containing the Bluetooth®  
wireless technology only):

Approx. 6 hours  
(when performing data  
communication with the backlight  
on\*)

Performing data communication (in  
continuous mode with the Wireless  
LAN function):

Approx. 5.5 hours  
(when performing data  
communication with the backlight  
on\*)

The battery life span varies depending on  
the temperature and the usage.

Your CLIE handheld supports “Memory Stick” media, “MagicGate Memory Stick” media, “Memory Stick Duo” media, “Memory Stick PRO” media, and “Memory Stick PRO Duo” media.

Note that data requiring the MagicGate function cannot be viewed or recorded with “Memory Stick PRO” media and “Memory Stick PRO Duo” media.

.....

## **Bluetooth® function (for models containing the Bluetooth® wireless technology only)**

### **Communication method**

Bluetooth® standard Ver.1.1

### **Output**

Bluetooth® standard Power Class 2

### **Communication range <sup>1)</sup>**

Line of sight approx. 10 m

### **Supported Bluetooth® profiles <sup>2)</sup>**

- Serial Port Profile
- Dial-up Networking Profile
- LAN Access Profile
- Object Push Profile
- Basic Imaging Profile

### **Frequency band**

2.4 GHz band  
(2.4000 GHz - 2.4835 GHz)

- 1) The actual range will vary depending on factors such as obstacles between devices, magnetic fields around a microwave oven, static electricity, areas with heavy radio and/or magnetic interference, radio wave conditions, reception sensitivity or antenna performance, and the operating system or software application, etc.
- 2) Bluetooth® standard profiles specify the requirements of the protocol software and application software for Bluetooth® devices to communicate with each other.

.....

## **Wireless LAN function**

### **Applied standard**

IEEE 802.11b

### **Frequency band**

2.4GHz band (1~11ch, ISM band)

### **WEP(data encryption)**

64,128 bits\*

### **Modulation method**

DS-SS(in conformity to IEEE  
802.11b)

\* The maximum key length available for entry is 40 bits (5 alphanumeric characters) for the 64-bit length and 104 bits (13 alphanumeric characters) for the 128-bit length.

.....

# System requirements

The following are the system specifications required to run **Palm™ Desktop for CLIÉ** and software supplied on the Installation CD-ROM:

- OS:  
Windows Millennium Edition,  
Windows 2000 Professional,  
Windows XP Home Edition,  
Windows XP Professional
- CPU: Pentium II 400MHz or faster  
(Pentium III 500MHz or faster is recommended)
- RAM: 96MB or more (128MB or more is recommended, 256MB or more is recommended for Windows XP)
- Hard disk drive space: 200MB or more (350MB or more is recommended)
- Display: High Color or better  
(800 × 600 dots or more is recommended)
- CD-ROM drive
- USB port
- Pointing device such as a mouse or touchpad

Design and specifications are subject to change without notice.



## 1 Headphone Jack

For headphones/earphones with a  $\phi 3.5$  stereo mini jack (commercially available).

## 2 CAPTURE Button

(Page 43)  
Press the CAPTURE button to take pictures.

## 3 Lens Cover Lever

(Page 43)  
Slide to open/close the lens-cover and start **CLIE Camera**.

## 4 "Memory Stick" LED

(Page 89)  
Blinks orange while your CLIE handheld is writing data to, or reading data from a "Memory Stick" media.

## 5 "Memory Stick" Slot

(Page 90)  
Insert a "Memory Stick" media into this slot.

## 6 POWER/HOLD Switch

(Pages 9, 88)  
Turns your CLIE handheld on and off, and sets your CLIE handheld to HOLD mode.

## 7 VOICE REC Switch

Slide to start/stop voice recording.

## 8 Microphone

Use to record sounds.

## 9 POWER LED

(Page 8)  
Lights or blinks when turned on. The LED shows the status of your CLIE handheld by its color.

**Lights green:** The power is on. (It also lights in HOLD mode.)

**Blinks green:** Blinks a few moments when you operate any button on your CLIE handheld in HOLD mode.

**Lights orange:** The battery is being charged.

**Blinks orange:** Alarm function that notifies you at a preset time if you have set an alarm in an application, such as **Date Book**.

**OFF:** The power is off.

## 10 REC LED

Lights when you are recording a voice memo.

## 11 Bluetooth LED (for models containing the Bluetooth® wireless technology only)

Lights during the data exchange using the Bluetooth® function and blinks when the function is on Waiting.

## 12 WLAN LED

### (Wireless LAN LED)

Lights when the wireless LAN function is in use.

## 13 Screen

(Page 91)

## 14 Data Assistant Button

(Page 36)  
Displays the menu of the Data Assistant.

## 15 Application Buttons

(Page 32)  
Even when your CLIE handheld is turned off, pressing an application button turns on your CLIE handheld and starts that application.

# Back panel

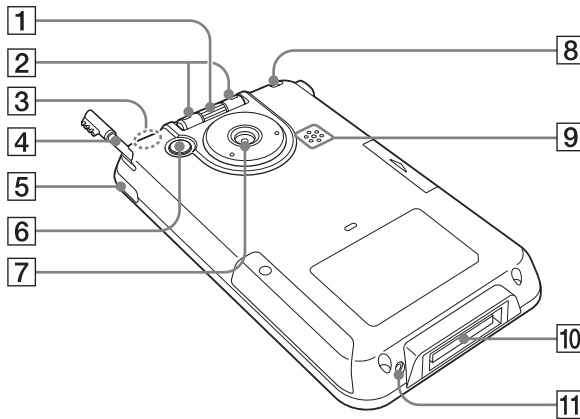

## 1 Jog Dial™ navigator

(Page 31)

Use to select and run applications or items. Depending on the application, unique features are assigned.

## 2 Left/Right Buttons

Moves the selection area of an item or an operation. Depending on the application, unique features such as displaying the previous or next screen are assigned.

## 3 Built-in wireless LAN and Bluetooth Antenna

An antenna is built here for the wireless LAN and Bluetooth® functions\*.

\* The Bluetooth® function is available for models containing the Bluetooth® wireless technology only.

## 4 Stylus

(Page 10)

A pointed tool to operate your CLIÉ handheld by touching the screen with it.

## 5 IR Port

(Page 90)

You can beam data between your CLIÉ handheld and another CLIÉ handheld or Palm OS® PDA.

## 6 BACK Button

Cancels the selection of an item or an operation. Depending on the application, unique features such as restoring to the previous screen are assigned.

## 7 Camera Lens

## 8 Strap Hook

## 9 Speaker

## 10 Interface Connector

(Page 8)

Use to connect the supplied plug adapter.

## 11 RESET Button

(Pages 47, 48)

Press to restart your CLIÉ handheld.

.....

## POWER/HOLD switch

### ► Turning on/off your CLIÉ handheld

#### Slide down the POWER/HOLD switch

The POWER/HOLD switch will return to the center position after being released. Your CLIÉ handheld powers on, the last screen viewed is displayed, and the POWER LED lights green. To turn off your CLIÉ handheld, slide down the POWER/HOLD switch again and then release.

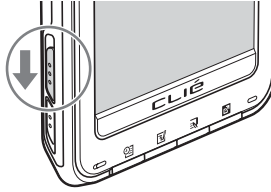

POWER/HOLD Switch

### ► Turning on/off the LCD backlight

Slide down the POWER/HOLD switch and hold it for more than two seconds.

### ► Turning on/off the HOLD mode

#### Slide up the POWER/HOLD switch

Putting your CLIÉ handheld in HOLD mode deactivates the touch screen. If you put the POWER/HOLD switch into the HOLD position while the power is on, the screen display turns off, even during an operation. To release the HOLD mode, slide down the POWER/HOLD switch to the center position.

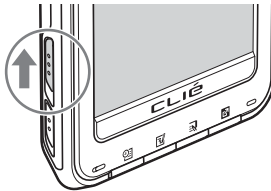



.....

## Using "Memory Stick" media

### ► Inserting "Memory Stick" media

**1** Pull out the "Memory Stick" slot cover.

**2** Open the "Memory Stick" slot cover.

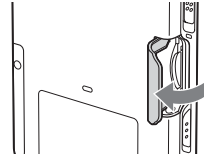
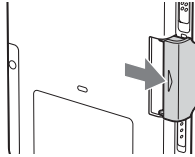

**3** Insert a "Memory Stick" media.

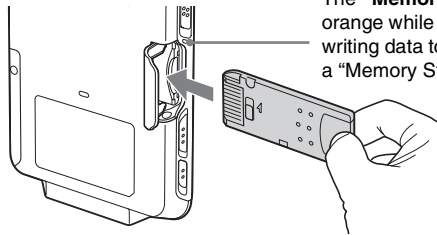

The "Memory Stick" LED blinks orange while your CLIÉ™ handheld is writing data to, or reading data from a "Memory Stick" media.

**Note**

Insert a "Memory Stick" media in the right direction. If you forcibly insert a "Memory Stick" media in the wrong direction, the "Memory Stick" slot may be damaged.

## ► Removing “Memory Stick” media

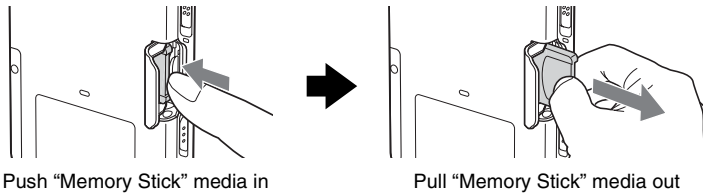

### Note

Make sure that your CLIÉ handheld is not writing data/files to, or reading data/files from a “Memory Stick” media before removing it. (The “Memory Stick” LED blinks when it is reading or writing data/files.) If you remove a “Memory Stick” media while the “Memory Stick” LED is blinking, recorded data/files may be deleted or damaged.

► For details on how to use “Memory Stick” media, refer to “Using “Memory Stick™” media” in the “Handbook” (PDF format).

## IR port

You can beam data or applications between your CLIÉ handheld and another CLIÉ handheld or Palm OS® PDA.

► For details, refer to “Beaming” in the “Handbook” (PDF format).

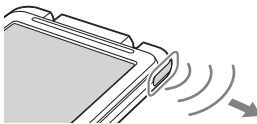

\* Move your CLIÉ handheld gradually to find the most sensitive direction.

# Locating the components of the Home screen (CLIE Organizer)

## Tip

If a different screen is displayed, tap  (Home).

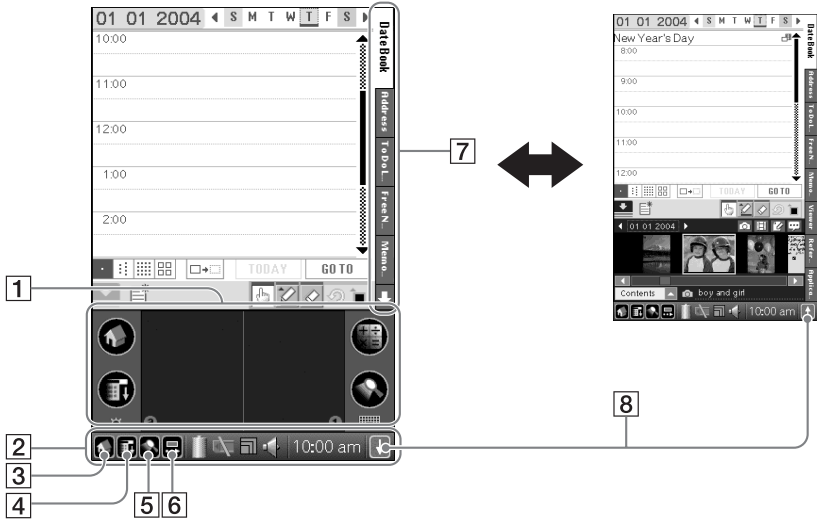

### 1 Silk Screen Area

(Page 92)

### 2 Status bar

(Page 92)

### 3 Home icon

Tap to display the Home screen.

### 4 Menu icon

Tap to display menu of the current application.

### 5 Find icon

Tap to display the dialog box finding data or applications.

### 6 Silk Plug-In icon

(Page 92)

### 7 Application Tabs

Tap to switch the application.

### 8 Resize icon

Tap to switch the screen view.

# Status bar



The status bar displays the following icons. Additional icons will be displayed according to the applications in use.

- 1 Tap to display the Home screen.
- 2 Tap to display the menus of the current application.
- 3 Tap to display the **Find** dialog box.
- 4 Tap to display the **Silk Plug-In** screen.

You can edit the display and functions of the Silk Screen area by switching the Silk Plug-In. [Decuma Latin Input] (**Decuma Input**) and [StandardInput] (**Graffiti® 2** and software keyboard) are installed by default.



Decuma Input area



Graffiti® 2 writing area

## Tips

- You can drag the stylus from left to right on the status bar to switch the Silk Screen area.
- You can tap in the top right of the **Silk Plug-In** screen to display the **Silk Plug-In Help** screen for tips and helpful advice.

Displays the battery's remaining charge. is displayed while the battery is being charged.



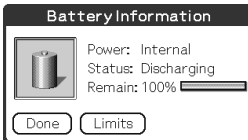

Tap to display the **Battery Information** dialog box.



Power: Power used  
Status: Battery status  
Remain: Remaining charge of the battery  
(This is not displayed while being charged.)

Tap [Limits] to display the **Battery Limits** dialog box.

Each icon indicates the information on the “Memory Stick” media inserted into your CLIE handheld.

-  “Memory Stick” media is inserted.
-  “Memory Stick” media is not inserted.
-  “Memory Stick” media is write-protected.
-  “Memory Stick” media is not read correctly.
-  A “Memory Stick” compatible device is inserted.

Tap the icon to display the **Media Info** dialog box when “Memory Stick” media is inserted.

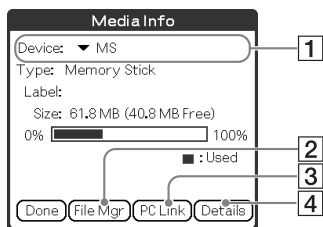



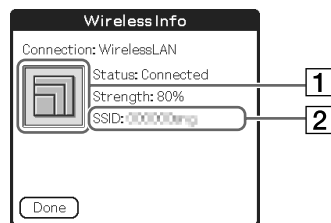

- 1** Media type  
You can choose another device by tapping ▼ next to [Device:].
- 2** Tap to display **CLIE Files**.
- 3** Tap to display **Data Import**.
- 4** Tap to display the **Device Detail** dialog box for information on the device or driver.

From the **Media Info** dialog box, tap  (Menu) and then tap [Preferences...] from [Option] to select operations for “Memory Stick” media.

Tap to display the **Wireless Info** dialog box.  
(This is displayed when the wireless LAN function is used.)



- 1** Reception level  
When connecting to the Internet via the wireless LAN, various reception levels are displayed as below.
  -  : off
  -  : 1-35%
  -  : 36-70%
  -  : 71-100%
- 2** SSID  
The currently used SSID of the wireless LAN access point is displayed.

 is displayed when the Bluetooth® function is used. (for models containing the Bluetooth® wireless technology only)

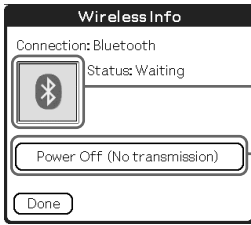

**1** Status for the Bluetooth®

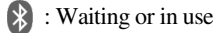

**2** Power On/Power Off

Tap to switch [Power On (Waiting for signal)] and [Power Off (No transmission)].

 Tap to display the **Adjust Volume** dialog box.

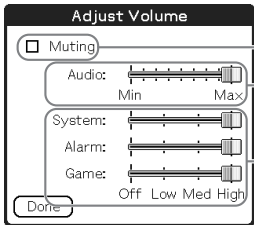

**1** Turns off the sound of your CLIÉ handheld.

When Muting mode is selected,  is displayed in the status bar.

**2** Adjusts the volume level for playing back audio files.

**3** Adjusts the volume level for System sound, Alarm sound, and Game sound. This affects the [General] settings in **Preferences**.

➔ For details, refer to “Customizing your CLIÉ™ handheld (Preferences): Setting sounds” in the “Handbook” (PDF format).

**10:00 am** Displays the current time. To change the display format, select **Preferences**, tap [Formats], and select a format for [Time:].

➔ For details, refer to “Customizing your CLIÉ™ handheld (Preferences): Setting up the Date & Time preferences” in the “Handbook” (PDF format).

 Tap to show or hide the silk screen area.

**Tip**

**When a dialog box or screen such as the below is displayed**

Tap the  icon to display tips and helpful advice.



## ..... Icons for switching Graffiti® 2/Software keyboard (When standard plug-in is selected)





You can switch between the Graffiti® 2 writing area and the software keyboard by tapping this icon.

Operating the software keyboard is the same as the on-screen keyboard, however applications can be used without minimizing the current screen.

### Tip

#### To switch the software keyboard display

You can switch the keyboard display by tapping the following icons:

-  The alphanumeric keyboard
-  The international keyboard
-  The symbol keyboard

.....

## Protective Cover

You can remove the protective cover as follows.

### Removing the protective cover

- 1** Push in the direction ① with your left hand.
- 2** Remove the right side of the protective cover from the hinge of your CLIÉ handheld by pulling it in the direction ②.
- 3** Remove the protective cover completely from your CLIÉ by pushing in the direction ③.

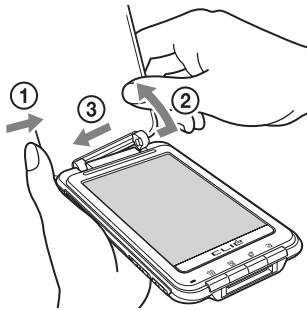

### Attaching the protective cover

- 1** Align the clasps of the protective cover with the hinges of your CLIÉ handheld.
- 2** Push each of the clasps onto the hinges of your CLIÉ handheld.

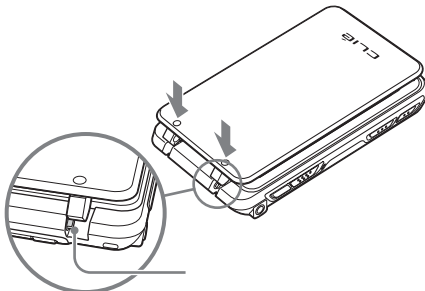



**3** After attaching the protective cover, open and close it to check.

**Notes**

- Do not open the protective cover too far or damage will occur.

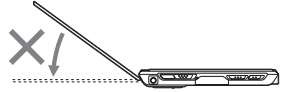

- Do not carry your CLIÉ handheld by the protective cover only or damage will occur.

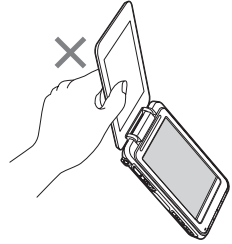

# INDEX

---

## A

---

- AC power adapter . . . . . 6, 8
- Address Book . . . . . 51
- Applications . . . . . 51
  - Installing . . . . . 25
  - Quitting . . . . . 30
  - Using . . . . . 27
- Audio Player . . . . . 51

---

## B

---

- Backup . . . . . 64
- Basic Operations . . . . . 26
- Battery considerations . . . . . 78
- Built-in antenna . . . . . 87

---

## C

---

- Calculator . . . . . 51
- Card Info . . . . . 51
- CLIE Camera . . . . . 51
- CLIE FAQ . . . . . 52
- CLIE Files . . . . . 52
- CLIE Mail . . . . . 52
- CLIE Manuals . . . . . 57
- CLIE Organizer . . . . . 27, 50
- CLIE Organizer for PC . . . . . 17
- CLIE Update Wizard . . . . . 55
- CLIE Viewer . . . . . 52
- Components . . . . . 85

---

## D

---

- Data Export . . . . . 55
- Data Import . . . . . 52
- Date Book . . . . . 52
- Decuma . . . . . 52
- Decuma Input . . . . . 35

---

## E

---

- Entering text . . . . . 33

---

## G

---

- Giga Pocket Plugin . . . . . 55

---

## H

---

- Home screen . . . . . 91
- HotSync . . . . . 53
- HotSync<sup>®</sup> operation . . . . . 39

---

## I

---

- Image Converter . . . . . 55
- Image Files
  - Taking pictures . . . . . 43
- Initial setup . . . . . 9
- Intellisync Lite . . . . . 56
- IR port . . . . . 90

---

## M

---

- Macromedia Flash Player 5 . . . . . 53
- Memo Pad . . . . . 53
- Memory Stick Backup . . . . . 53
- "Memory Stick" LED . . . . . 89
- "Memory Stick" Slot . . . . . 89
- Mobile Connection Wizard . . . . . 56
- Mobile Manager . . . . . 53
- Movie Player . . . . . 53

---

## N

---

- NetFront v3.1 for CLIE . . . . . 54

---

**P**

---

Palm™ Desktop for CLIE . . . . .	17
Picxel Viewer for CLIE . . . . .	54
Preferences . . . . .	54
Protective Cover . . . . .	96

---

**R**

---

Restarting	
Hard reset . . . . .	48
Soft reset . . . . .	47

---

**S**

---

Security . . . . .	54
Set date . . . . .	13
Set time . . . . .	12
Setting up . . . . .	8
SMS . . . . .	54
SonicStage . . . . .	56
Sound Utility . . . . .	54
Specifications . . . . .	80
Status bar . . . . .	92
Stylus . . . . .	10
Supplied applications . . . . .	50

---

**T**

---

Time zone . . . . .	13
To Do List . . . . .	54

---

**U**

---

USB cable . . . . .	20
USB port . . . . .	21

---

**V**

---

Voice Recorder . . . . .	45, 54
--------------------------	--------

---

**W**

---

Welcome . . . . .	54
-------------------	----







## On the trademarks

Before using your CLIÉ handheld, make sure you read the accompanying End-User's License Agreement.

- Sony, CLIÉ, "Memory Stick", "Memory Stick Duo", "Memory Stick PRO", "Memory Stick PRO Duo", "MagicGate Memory Stick", Jog Dial, and their logos are trademarks of Sony Corporation.
- Palm, Palm Powered, the Palm logo, the Palm Powered logo, Palm OS, Graffiti, HotSync and the HotSync logo are trademarks of PalmSource, Inc.
- Graffiti 2 powered by Jot®.
- Microsoft and Windows are registered trademarks of Microsoft Corporation.
- Pentium is a registered trademark of Intel Corporation.
- Intellisync is a trademark of Pumatech, Inc.
- Adobe and Acrobat are trademarks of Adobe Systems Incorporated.
- NetFront is a trademark of ACCESS CO, Ltd.
- Pícsel and the Pícsel logo are trademarks of Pícsel Technologies, Ltd.
- Macromedia and Flash are trademarks or registered trademarks of Macromedia, Inc. in the United States and internationally.
- Decuma is a trademark of Decuma AB in the United States and other countries.
- This product includes fonts owned by TypeBank Co., Ltd. under license.
- The Bluetooth word mark and logos are owned by the Bluetooth SIG, Inc. and any use of such marks by Sony Corporation is under license.

-  QuickTime and the QuickTime logo are trademarks used under license. The QuickTime logo is registered in the U.S. and other countries.

- All other trademarks are trademarks of their respective owners.

---

For the latest information on support, CLIÉ products and accessories, check our official Sony CLIÉ website

For customers in the U.S.A. and Canada

**<http://www.sony.com/clie/>**

For customers in Australia, Hong Kong, Malaysia, Mexico, New Zealand, Singapore, Taiwan, Thailand, and U.A.E.

**<http://www.sony.net/clie-online/>**

For customers in Europe

**<http://www.sony-europe.com/clie>**

---