

LCD TV

&%l ?8'+\$&\$J 9

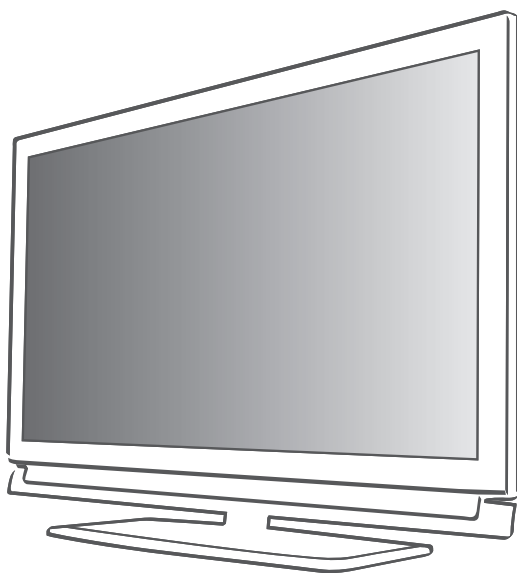

AUS GUTEM GRUND
GRUNDIG

CONTENTS

- 4 SETUP AND SAFETY**
- 6 GENERAL INFORMATION**
 - 6 Special features of your television set
 - 7 Receiving digital channels
 - 7 Important notes on environmental protection
- 8 CONNECTION AND PREPARATION**
 - 8 Connecting the antenna and power cord
 - 9 Inserting batteries into the remote control
- 10 OVERVIEW**
 - 10 Connections on the television set
 - 11 Controls on the television set
 - 12 The remote control - Main functions
 - 13 The remote control - All functions
- 14 SETTINGS**
 - 14 Initial set-up and tuning television channels
 - 14 Selecting language, country and operating mode
 - 15 Tuning terrestrial television channels (DVB-T)
 - 15 Tuning television channels from the cable provider (DVB-C)
 - 16 Changing the program table for the digital channels
 - 18 Picture settings
 - 19 Sound settings
- 21 TELEVISION - OPERATION**
 - 21 Basic functions
 - 22 Zoom function
 - 22 Eco mode
 - 22 Zapping function
 - 22 Electronic TV guide
 - 23 Changing the picture format
- 24 USB RECORDING**
 - 24 Information on recording and playing television programmes
 - 24 Possible limitations when using an external data medium
 - 25 Connecting external data media
 - 25 Settings for USB recording
 - 27 "Pausing" time shift programmes
 - 27 Recording programmes
 - 28 Presetting programmes to be recorded
 - 30 Playback
 - 30 Deleting programmes in the recording list
- 31 USB OPERATION**
 - 31 File formats
 - 32 Connecting external data media
 - 33 The file browser
 - 33 Settings in the USB setup menu
 - 34 Basic playback functions
 - 35 Additional playback functions
- 37 TELETEXT OPERATION**
 - 37 TOP text or FLOF text mode
 - 37 Additional functions
- 38 CONVENIENCE FUNCTIONS**
 - 38 Opening the SETTINGS menu
 - 38 Language settings
 - 39 Setting the date and time
 - 39 Timer settings
 - 40 Parental control settings
 - 41 Updating software
 - 41 Restoring the television to the default settings

CONTENTS

42 OPERATION USING EXTERNAL DEVICES

- 42 DIGI LINK
- 42 The DIGI LINK functions on your television
- 43 Device operation
- 44 High definition HD ready
- 44 Connection options
- 45 Connecting external devices
- 46 Using a DVD player, DVD recorder, video recorder or set-top box
- 46 Headphones
- 47 Hi-fi system/AV receiver

48 OPERATION AS A PC MONITOR

- 48 Connecting a PC
- 48 Selecting presets for the PC
- 48 Settings for PC mode

49 OPERATION WITH A COMMON INTERFACE

- 49 What is a Common Interface?
- 49 Inserting the CA module
- 49 Access control for CI module and smart card

50 SPECIAL SETTINGS

- 51 Searching for digital terrestrial TV channels automatically
- 52 Searching for digital terrestrial TV channels manually
- 53 Tuning analogue television channels
- 54 Changing stored analogue channels

56 INFORMATION

- 56 Displaying signal information
- 56 Pre-programming the remote control for other GRUNDIG devices
- 57 Technical data
- 57 Service information for retailers
- 57 Environmental note
- 58 Troubleshooting
- 59 Additional Information for units sold in the UK.

SETUP AND SAFETY

Please note the following instructions when setting up the television set:

- This television is designed to receive and display video and audio signals. All other uses are expressly prohibited.
- The ideal viewing distance is five times the diagonal screen size.
- Light falling on the screen impairs picture quality.
- To ensure the device is always adequately ventilated, make sure there is sufficient space between the television set and nearby furniture.
- The television is designed for use in dry rooms. If you do use it outdoors, make sure it is protected from moisture such as rain or splashing water. Never expose the television set to moisture.
- Do not place any vessels such as vases on the television, as they may spill liquid, thus presenting a safety risk.
- Place the television on a hard, level surface.
- Do not place any objects such as newspapers on the television or put cloth or similar items under it.
- Do not place the television close to heating units or in direct sunlight, as this will impair cooling.
- Heat build-up can be dangerous and shortens the service life of the television. For reasons of safety, have a repairman remove any dirt in the television from time to time.
- Never open the television under any circumstances. Warranty claims are excluded for damage resulting from improper handling.
- Make sure the power cord or the power supply unit (if provided) are not damaged.
- Only operate the television with the power supply/power cord provided.
- Thunderstorms are a danger to all electrical devices. Even when the television is switched off, it can be damaged by a lightning strike to the mains or the antenna. Always disconnect the mains and antenna plugs during a storm.
- Use a damp, soft cloth to clean the screen. Do not use water with soap or detergent.
- Only clean the housing of your television set with the cloth provided. Do not use water with soap or detergent.
- When deciding where to put the device, remember that furniture is often coated with various types of varnish and plastic. Many of these contain chemicals which can corrode the feet of the device, leaving marks on the surface of the furniture which can be difficult or impossible to remove.
- The screen of your LCD television meets the highest quality standards and has been checked for pixel faults. Despite the great care taken in manufacturing, technological reasons make it impossible to completely discount the possibility that some pixels may be faulty. Provided they are within the thresholds specified by the DIN norm, pixel faults of this kind cannot be regarded as a defect as defined by the warranty.
- To ensure fires do not occur, always keep candles and other open flames away from the device.



SETUP AND SAFETY

- Do not connect any other equipment while the device is switched on. Also switch off other equipment before connecting it.
- Do not plug in the power cord of the device until you have connected the external equipment and the antenna.
- Make sure the mains plug is freely accessible.

Caution:

- If you plan on using a wall bracket for your television, make sure you read the assembly manual for the wall bracket or have a specialist assemble it.
- When purchasing the wall bracket, make sure that all the fastening points on the television are also on the wall bracket and that they are all used when mounting it.

Special features of your television set

- You can receive and watch digital TV channels using your television set (via DVB-T and DVB-C) – including High Definition programmes (HD). However, the reception of digital TV channels in HD is currently limited to a few countries in Europe.
- Although this television set complies with the current DVB-T and DVB-C standards (status: August 2010), the compatibility with future terrestrial DVB-T and DVB-C cable programmes cannot be guaranteed.
- Your television set can receive and process all analogue and non-encrypted digital TV channels. The television set is also equipped with digital and analogue receivers.
- The electronic TV guide (for digital channels only) informs you about any schedule changes at short notice, and provides an overview of all the broadcasters' schedules for the next few days. Detailed information on the individual television programmes are – when provided by the broadcasting station – are also available in the electronic TV guide.
- You can connect various data media, such as an external hard drive, a USB memory stick or a digital camera, to the USB socket. Using the file browser, you can then select and play the file formats of your choice (for example, MP4, MP3 or JPEG data).
- Using the time shift function, you can quickly and easily pause a programme using the remote control and resume it at a later stage. The programme is recorded in an external data medium.
- You can record any digital TV channels you choose. The TV channels are converted by the television and saved on an external data medium which is connected to the USB socket. The saved programmes can be called up and played from the archive on the external data medium at any time. You can also play a programme from the archive while recording another. More information on recording and playing TV programmes can be found on page 24.

Receiving digital channels

- You require a digital roof antenna or indoor antenna (passive or active indoor antenna with its own power supply) to receive digital television channels (DVB-T).
- If you wish to receive digital television channels via your cable system (DVB-C), the antenna cable for your cable operator must be connected to the television set.
- Unlike analogue broadcasting, not every channel has its own transmission frequency. Instead, several channels are grouped into what are known as bouquets on a regional or national level. You can find the current transmission information on teletext from various broadcasters, or by consulting a current TV guide or the Internet.
- Various digital television channels from private broadcasters are encrypted (DVB-T and DVB-C). Watching these channels and the recording and playback functions are only possible with the appropriate CI module and a SmartCard. Ask your specialist dealer.
The range of channels available from the public broadcasting institutions (ARD with EinsExtra, EinsFestival or ZDF with ZDF Info and all third party broadcasters) are not encrypted and can be received without a SmartCard.

Important notes on environmental protection

- The following information will help you to save resources – and money as well.
- If you are not using your television set for several days, you should pull out the mains plug for environmental and safety reasons. This way the television does not consume any electricity.
- As switching off the television set does not completely disconnect it from the mains, pull out the plug to disconnect it from the mains completely.
- If the device is equipped with a power switch, switching it off using this switch will be sufficient. The energy consumed by the television set is reduced to virtually 0 W.
- In standby mode, the television set uses very little energy. However, it may be necessary to leave the television set in standby mode for certain functions (for example automatic switch-on and switch-off and for timer functions).
- The television set uses less energy when the brightness is reduced.

CONNECTION AND PREPARATION

Connecting the antenna and power cord

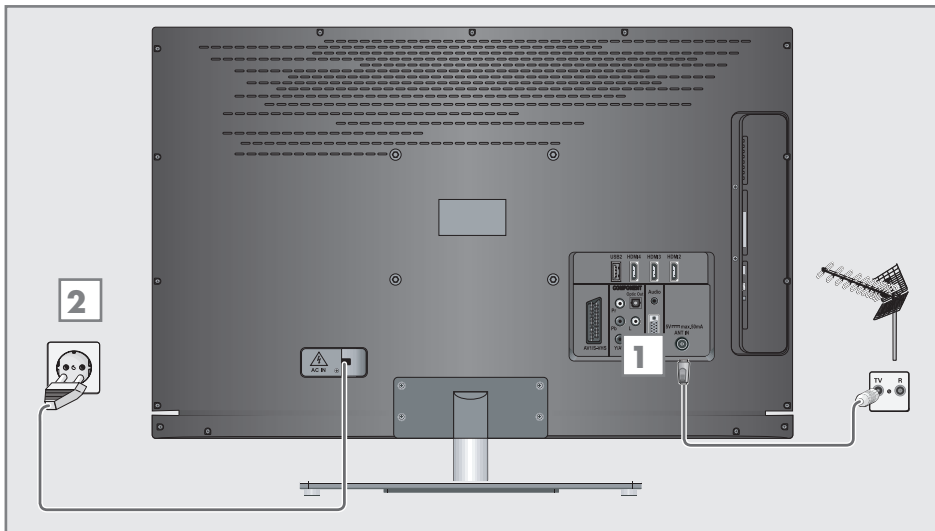

1a To receive terrestrial digital broadcasters (DVB-T) connect the cable for the rooftop or indoor antenna (passive or active indoor antenna with its own power supply) to the antenna socket »**ANT IN**« on the television set;
or

1b To receive digital cable channels (DVB-C) connect the cable for the rooftop antenna to the antenna socket »**ANT IN**« on the television set;
or

1c To receive analogue TV channels, connect the cable for the rooftop antenna to the antenna socket »**ANT IN**« on the television set

2 Plug the power cord into a wall socket.

Note:

- Do not plug in the power cord of the device until you have connected the external equipment and the antenna.
- Only use the power cord supplied to connect the television set to a suitable earthed safety socket.
- Do not use an adapter plug or extension lead which does not meet the applicable safety standards. Do not tamper with the power cord.

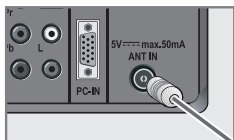

Note:

- When connecting an indoor antenna you may have to try it out at different positions until you get the best reception.

CONNECTION AND PREPARATION

Inserting batteries into the remote control

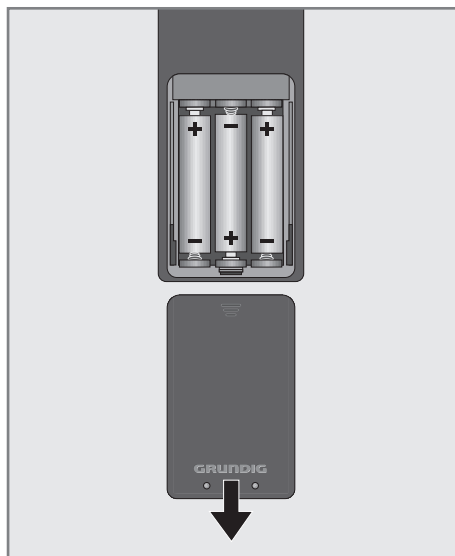

- 1 Open the battery compartment by removing the lid.
- 2 Insert the batteries (3 x 1.5 V micro, for example R03 or AAA). Observe the polarity marked in the bottom of the battery compartment.
- 3 Close the battery compartment.

Note:

- If the television no longer reacts properly to remote control commands, the batteries may be flat. Always remove used batteries.
- The manufacturer accepts no liability for damage caused by leaking batteries.

Environmental note



This symbol on rechargeable batteries/batteries or on the packaging indicates that the rechargeable battery/battery may not be disposed of with regular household rubbish. For certain rechargeable batteries/batteries, this symbol may be supplemented by a chemical symbol. Symbols for mercury (Hg) or lead (Pb) are provided if the rechargeable batteries/batteries contain more than 0.0005% mercury or more than 0.004% lead.

Rechargeable batteries/batteries, including those which do not contain heavy metal, may not be disposed of with household waste. Always dispose of used batteries in accordance with local environmental regulations. Make enquiries about the applicable disposal regulations where you live.

OVERVIEW

Connections on the television set

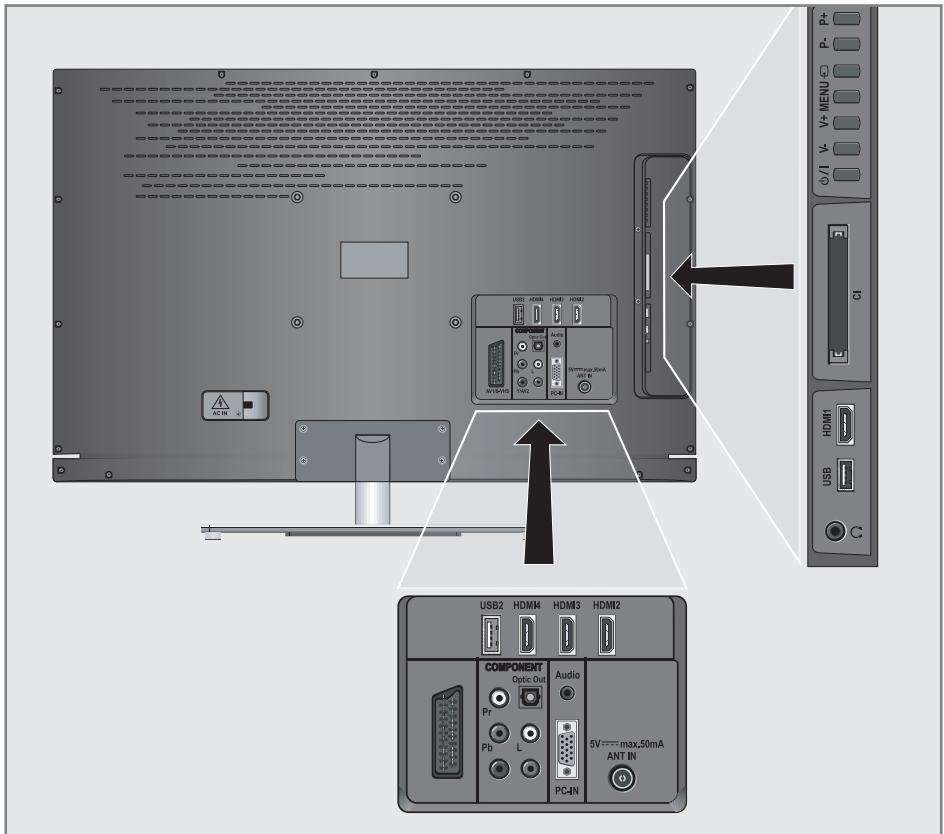

AV1 / S-VHS SCART socket (CVBS signal, RGB signal); Video and sound socket for S-Video camcorder.

COMPONENT
Pb Pr Y/AV2 Sockets for video input (YUV signal).

L R Sockets for audio input (YUV signal); Audio socket for camcorder.

Y/AV2 Video socket for camcorder

Optic Out Socket for audio output (optical) for PCM/AC3 signals. For connecting digital AV amplifiers or AV receivers.

Audio Socket for audio input for a PC.

PC-IN VGA socket, video input for PC.

ANT IN Antenna socket for a DVB-T, DVB-C and analogue antenna.

OVERVIEW

HDMI2	HDMI socket, audio/video input.
HDMI3	HDMI socket, audio/video input.
HDMI4	HDMI socket, audio/video input.
USB2	USB socket for external data media and PVR function.
	Headphone jack (3.5 mm jack plug); Sockets for audio output.
USB1	USB socket for external data media without a power supply of their own and PVR function.
HDMI1	HDMI socket, audio/video input.
CI	Common Interface Slot.

Controls on the television set

	Switches the television on and back into standby mode.
V- V+	Adjusts the volume; selects menu functions.
MENU	Opens the menu. Select a menu option with » P+ « or » P- «. Activate the function with » V+ «. Confirm the function with » V+ « or » V- «.. Press » MENU « to quit the menu.
SOURCE	Opens the pre-selection for AV channels. In the menu, press » P+ « or » P- « to select and press » SOURCE « to confirm.
P- P+	Switches the television on from standby; selects channels in steps; selects function in the menu.

OVERVIEW

The remote control – Main functions

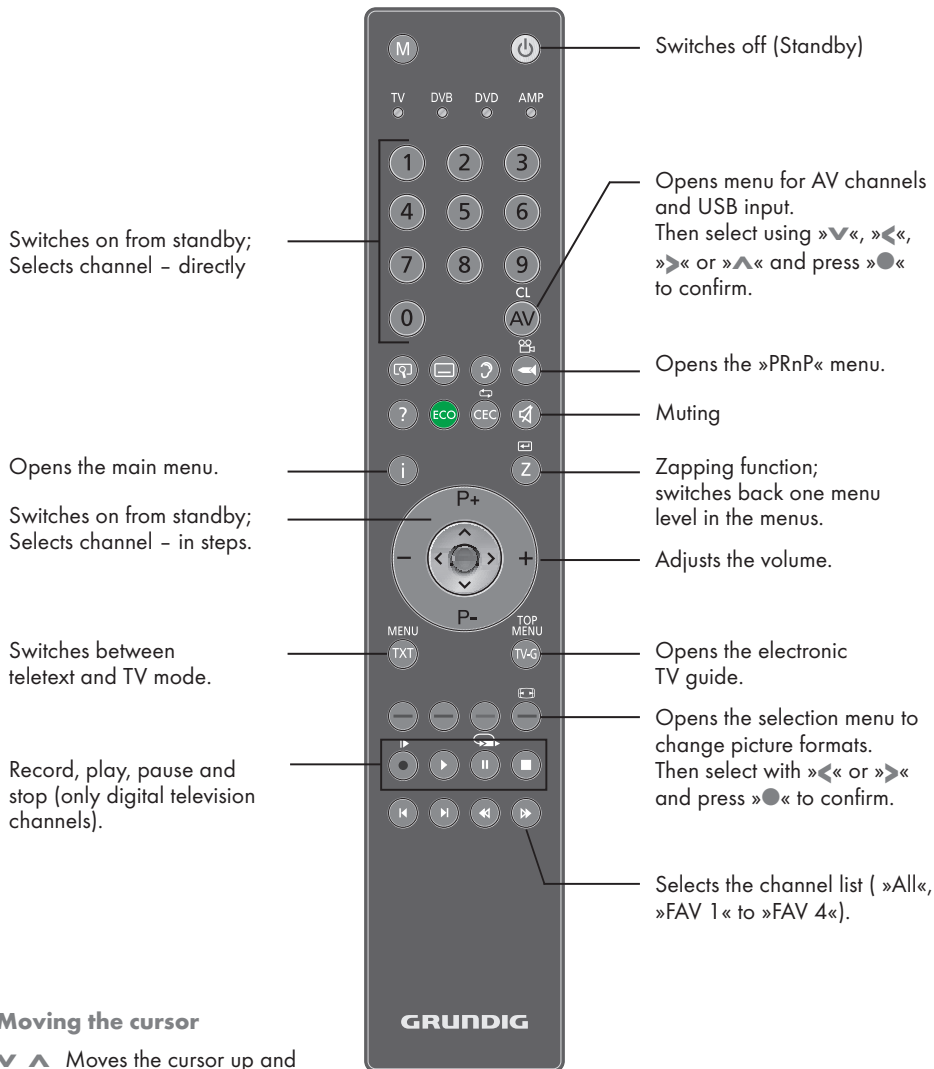

















Moving the cursor

- ✓ ▲ Moves the cursor up and down in the menus.
- ◀ ▶ Moves the cursor to the left and right in the menus.
- Opens the channel list; activates various functions.

OVERVIEW

The remote control – All functions

-  Enlarges the picture.
-  Selects different subtitles
(only for digital television channels)
-  Selects different audio languages
(only for digital television channels)
-  Displays information about the
television channel.
- ECO** Switches ECO mode on/off.
- CEC** Opens the »HDMI CEC Device List«;
selects the repeat function in the
file browser.
-  (red) Selects pages in teletext;
-  (green) Selects/activates various functions in
-  (yellow) the menus.
-  (blue)
-  Starts the recording (only for digital
television channels, the recording is
made on an external data medium).
-  Starts playing a programme from an
external data medium;
Repeats a recorded programme.
-  Freeze frame, if no external data
medium is connected;
Playback pause;
Time shift mode (only for digital
television channels and when an ex-
ternal data medium is connected).
-  Ends playback of a programme from
an external data medium;
Ends a recording or
playback in time shift mode;
Splits the screen in teletext.
-  Selects different audio settings;
Switches to double character size in
teletext;
Selects the next title/next picture in
the file browser.
-  Selects different picture settings;
Refreshes a teletext page;
Selects the previous track/previous
picture in the file browser.
-  Stops scrolling through pages in
teletext;
Starts a fast reverse search in the
file browser.
-  Selects the channel list (»All«, »FAV
1« to »FAV 4«);
Reveals answers in teletext;
Starts a fast forward search in the
file browser.
- M** Switches over to operate a
– GRUNDIG digital receiver,
– GRUNDIG digital receiver with
hard disk (PDR),
– GRUNDIG DVD player.
– GRUNDIG DVD recorder or
GRUNDIG AV receiver.
- Press »**M**« until the displays »DVB«,
»DVD« or »AMP« lights up.
Then make the selection.
- If you do not press a button within
10 seconds, the remote control
returns to television mode (»TV«).
- You can change this programming,
see page 56.

Initial set-up and tuning television channels

The television set is equipped with automatic channel search, which searches for terrestrial channels (DVB-T), cable channels (DVB-C) and analogue channels.

You start the search and can then copy the television channels into four favourite lists and sort them there into your order of preference.

For DVB-T and DVB-C channels 1000 presets, and 100 presets for analogue channels.

The various settings

Depending on the type of antenna connected, you can decide which channels you would like the television to search for.

- Tunes digital terrestrial television channels, on page 15.
- Tunes digital television channels from the cable provider, on page 15.
- Tunes analogue television channels, in the chapter "Special functions", starting on page 53.
- Further settings for digital television channels after the initial set-up can also be found in the chapter "Special functions", starting on page 50.









Note:

- Make the language and country selection for all types, then continue reading the respective chapter.





Selecting language, country and operating mode

- 1 Switch on the television set from standby with »«, »1...0« or »P+« or »P-«.
 - During initial set-up, the »Installation Guide« will be displayed.

Help:

- If this menu is not displayed, restore the television set to its default settings (see page 41).
- 2 Select the menu language with »«, »«, »« or »« and press »« to confirm.
 - 3 Select the mode with »« or »« and press »« to confirm.
 - The settings used in »Home Mode« help to save energy.
 - Alternatively, the menu item »Shop Mode« can be selected which the retailer can use for demonstrating the device functions.

Note:

- End the »Shop Mode« by restoring the television set to its default settings (see page 41).
- 4 Select the country in which the television set is operated with »«, »«, »« or »« and press »« to confirm.
 - The »Source Setup« menu appears with the »Connection Type« line marked.

Note:

- You can find a description of how to tune the television channel of your choice - depending on the antenna connected - in the following chapters.

Tuning terrestrial television channels (DVB-T)

- 1 In the »Source Setup« menu, in the »Connection Type« line, select the option »Air« with »◀« or »▶«.
- 2 Select the line »Scan Type« with »▼« or »▲«.
Use »◀« or »▶« to set the required scan type:
 - »DTV«, scan for digital television channels;
 - »ATV«, scan for analogue television channels;
 - »ATV & DTV«, scan for analogue and digital television channels.

Caution:

- The antenna power supply (5V ---) may only be switched on if the antenna is an active indoor antenna with a signal amplifier and it is not already supplied with a voltage via a mains plug (or similar supply). Otherwise you may cause a short circuit and irreparably damage your antenna.
- 3 Select the line »Active Antenna Power« with »▼« or »▲«.
Switch on the antenna power supply for the antenna with »◀« or »▶« (»On«).
 - 4 Start the scan with »■« (green).
 - The »Search Results« menu appears, and the search for TV channels begins.
 - Depending on the number of television channels received, this can easily take a few minutes.
 - The scan is complete as soon as the »PROGRAM TABLE« appears.

Note:

- You can abort the scan by pressing »i«.
- 5 Press »i« to end the setting.

Tuning television channels from the cable provider (DVB-C)

- 1 In the »Source Setup« menu, in the »Connection Type« line, select the option »Cable« with »◀« or »▶«.
- 2 Select the line »Scan Type« with »▼« or »▲«.
Use »◀« or »▶« to set the required scan type:
 - »DTV«, scan for digital television channels;
 - »ATV«, scan for analogue television channels;
 - »ATV & DTV«, scan for analogue and digital television channels.
- 3 Select the line »Cabel Scan Type« with »▼« or »▲«. Select the preferred option (»Quick« or »Full«) with »◀« or »▶«.
 - The search function »Quick« sets up the channels according to the information provided by your cable provider in the transmission signal.
 - If the option »Full« is selected, the entire frequency range will be scanned. The search can take a long time with this option. This option is recommended if your cable provider does not support the scan type »Quick«.

Note:

- You can accelerate the search. To do this, you need information about the frequency and network ID. You are usually able to get this data from your cable operator or find it in forums on the Internet.
- 4 Start the scan with »■« (green).
 - The »Search Results« menu appears, and the search for TV channels begins.
 - Depending on the number of television channels received, this can easily take a few minutes.
 - The scan is complete as soon as the »PROGRAM TABLE« appears.

Note:

- You can abort the scan by pressing »i«.
- 5 Press »i« to end the setting.

SETTINGS

Changing the program table for the digital channels

Channels which are found using the scan are saved in the »PROGRAM TABLE«.

You can delete channels which are not required from the programme table, and lock individual channels (Parental control).

You can also add channels to the favourites list; in addition, you can change the order of channels within the favourites list.

With »■« (green) you can display the channels which belong to one network.

Switch to the next page in the programme table with »P+« and to the previous page with »P-«.

With »■« (yellow) you can open the »LIST MANAGEMENT« within the programme table.

In this List Management you can create your own favourites lists.

Selecting channel lists

- 1 Open the menu with »i«.
- 2 Select the »SOURCE SETUP« menu with »▼« or »▲« and press »●« to confirm.
- The »SOURCE SETUP« menu appears.
- 3 Select the line »Programme Table« with »▼« or »▲« and press »●« to confirm.
- The menu »PROGRAM TABLE« appears.

Important:

- Programme table and favourites lists are saved separately according to the different input sources (cable and air).
- When opening the programme table, the respective channel list for the current input signal appears.

Note:

- If in the Program Table **CA** appears added to the name of the channel, you need a CI module and a Smart-Card for watching these channels.

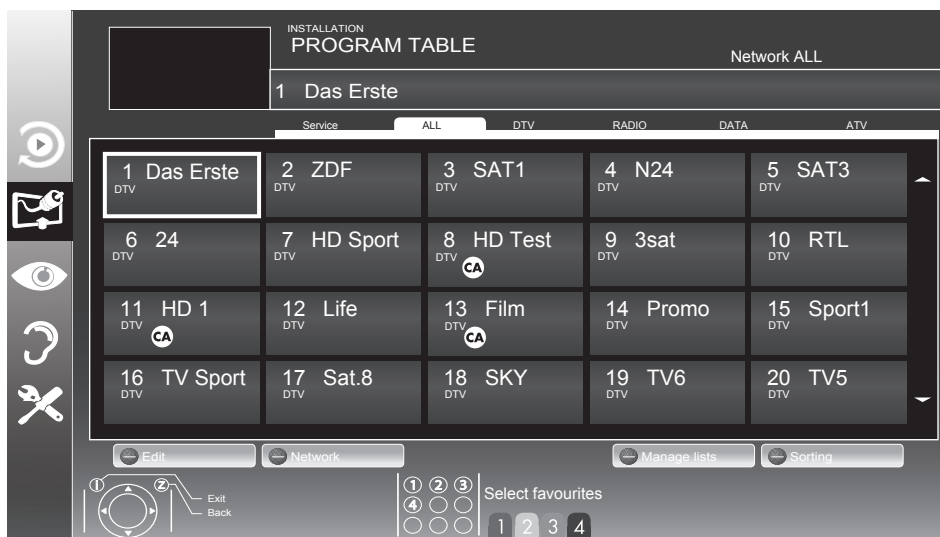

SETTINGS

Creating lists of favourites

You can save your favourite channels in up to four favourites lists (FAV 1 to FAV 4).

Notes:

- Favourites lists must be created separately for all input sources (cable and air).
 - You can select the favourites list by pressing »▶▶«.
- 1 In the »PROGRAM TABLE« menu, switch over to the list view with »■« (yellow).
 - 2 Select the channel of your choice with »▼« or »▲«.
 - 3 "Push" the channel into the favourites lists 1 to 4 with »◀« or »▶« and press »●« to confirm.
 - The position in the favourites list is marked with »✓«.
 - You can enter the same channel in more than one favourite list.
 - Each favourite list can store up to 255 channels.

Note:

- Channels can also be deleted from the favourites lists. Select the channel to be deleted with »▼«, »▲«, »◀« or »▶« and press »●« to delete it.
 - When deleting a channel from the favourites list, the order within the favourites list will be updated.
- 4 Press »i« to end the set-up.

Sorting channels in the favourite list

You can change the order of channels in the favourites list.

- 1 In the »PROGRAM TABLE« menu, select the favourites list »1« to »4«.
- 2 Select the channel which should be moved with »▼«, »▲«, »◀« or »▶« and mark it with »■« (red).
- 3 Move the channel to its new position with »▼«, »▲«, »◀« or »▶« and press »●« to confirm.

Notes:

- Repeat steps 2 and 3 if you would like to change other channels within the same favourites list.
 - Repeat steps 1 to 3 if you would like to change channels in a different favourites list.
- 4 Exit the current favourites list with »■« (blue).
 - The entire programme table will appear again.

Deleting channels

- 1 In the »PROGRAM TABLE« menu, select the television channel to be deleted with »▼«, »▲«, »◀« or »▶« and press »■« (red) to activate.
- 2 Delete the current channel with »■« (yellow); delete all channels with »■« (blue).
- 3 Confirm the deletion process with »■« (green).
- 4 Quit the deletion process with »Z«.

Skipping channels

You can mark television channels which should be skipped when selecting with »▲« or »▼«. It is still possible to select them using the number buttons.

- 1 In the »PROGRAM TABLE« menu, switch over to the list view with »■« (yellow).
- 2 Select the preferred channel with »▼« or »▲«.
- 3 Select the column »Skip« with »◀« or »▶« and use »●« to mark the channel.
 - The channel is marked by »✓«.

Note:

- Channels can also be reactivated. Select the channel with »▼« or »▲«, then select the column »Skip« and reactivate the channel with »●«.

Picture settings

- 1 Open the menu with »i«.
- 2 Select the menu item »PICTURE SETTINGS« with »▼« or »▲« and press »●« to confirm.
- The »PICTURE SETTINGS« menu appears.

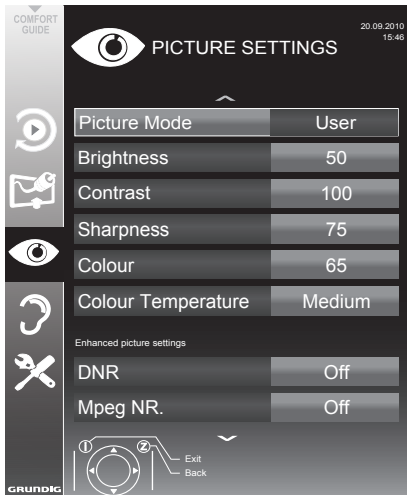

- 3 Select the line »Picture Mode«, »Brightness«, »Contrast«, »Sharpness«, »Colour«, or »Colour Temperature« with »▼« or »▲«. Select the value with »◀« or »▶« and press »●« to confirm.

Notes:

- When changing the values with »◀« or »▶«, the screen will be split. You can see the current setting on the left side, the new setting on the right side.
 - In the »PICTURE SETTINGS« menu you can also find other additional settings.
- 4 Select the line »DNR«, »Mpeg NR.«, »Vibrant Colour«, »Perfect Clear«, »Film Mode«, »Gamma«, »Dynamic Contrast«, »Dynamic Backlight«, »Backlight« or »MEMC« with »▼« or »▲«. Select the value with »◀« or »▶« and press »●« to confirm.

Notes:

- You can only select the »Mpeg NR« function on digital and AV presets.
»Mpeg NR« reduces any interference from artefacts (pixel blocks) from digital programmes due to MPEG compression (such as from DVB-T receivers or DVD players).
 - The »Film Mode« detects and processes feature films automatically for all channel sources. This means you will always receive an optimal picture.
This functions in the modi 480i, 576i and 1080i in TV playback and for other channel sources.
If the »Film mode« is switched on for programmes without a feature film signal, minor problems such as picture freeze, defective subtitles or fine lines in the picture could occur.
 - The function »Dynamic Contrast« adapts the contrast dynamically and optimally for the respective picture content.
 - With »Dynamic Backlight«, the device optimally adapts the background lighting to the picture content.
 - The »Backlight« can only be set manually when the function »Dynamic Backlight« is deactivated.
 - »MEMC« (Motion Estimation, Motion Compensation) provides fluidity for the picture in active pictures or fast camera shots. »MEMC« feature only appears in the menus of the 100Hz products. In 100Hz products, MEMC feature of the TV may not function properly for signals out of 60 Hz vertical scanning frequency (56Hz, 75Hz) as PC resolution from PC source. If you want MEMC feature to function properly for such resources, make sure that the source you have connected has 50Hz or 60Hz vertical scanning frequency.
- 5 Press »i« to end the setting.

Sound settings

- 1 Open the menu with »i«.
- 2 Select the menu item »SOUND SETTINGS« with »▼« or »▲« and press »●« to confirm.
- The »SOUND SETTINGS« menu appears.

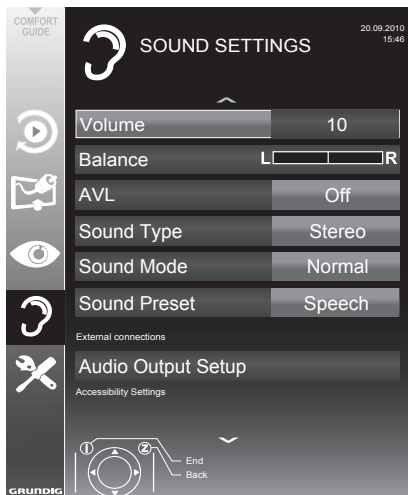

Note:

- Additional operations are explained in the following sections.

Volume

- 1 Select the line »Volume« with »▼« or »▲« and change the setting with »◀« or »▶«.

Balance

- 1 Select the line »Balance« with »▼« or »▲« and change the setting with »◀« or »▶«.

Automatic volume

Television stations broadcast at different volumes. The automatic volume limiting (AVL) function means the volume is kept the same when you switch between channels.

- 1 Select the line »AVL« with »▼« or »▲« and select the option »On« with »◀« or »▶«.

Note:

- If the »SRS TS HD« setting has been selected in the »Audio Mode« line, the AVL line cannot be selected.

Stereo/two channel sound, mono

If the device receives two-channel-sound programmes, e.g. a film with the original soundtrack on audio channel B (display: »Dual II«) and the dubbed version on sound channel A (display: »Dual I«), you can select the audio channel you prefer.

If the device receives stereo or Nicam programmes, it switches automatically to stereo sound (display: »Stereo«).

You can switch the sound to »Mono« if the stereo sound quality is poor.

- 1 Select the line »Audio Type« with »▼« or »▲« and adjust the setting with »◀« or »▶«.

Stereo width

This broadens the sound output for stereo programmes and improves the sound with mono reception.

- 1 Select the line »Audio Mode« with »▼« or »▲«.
- 2 Select the option »Spatial« with »◀« or »▶«.

SETTINGS

Soundeffects

This menu offers three preset sound effects (Music, Natural and Speech) and one setting to be created by you (User).

- 1 Select the line »Sound Preset« with »▼« or »▲«.
- 2 Select the sound effect »Music«, »Natural« or »Speech« by pressing »◀« or »▶«.

Note:

- »User« option is active when »Sound mode« setting is selected as »Normal« or »Spatial«.

SRS TruSurround HD

SRS TruSurround HD is a patented audio technology which is integrated into the television set and only requires the built-in speakers to generate a Surround Sound effect.

- 1 Select the line »Sound Mode« with »▼« or »▲«.
- 2 Select the option »SRS TS HD« with »◀« or »▶«.
- 3 Select the line »SRS Sound Preset« with »▼« or »▲«.
- 4 Select the sound effect »Music«, »Natural« or »Speech« with »◀« or »▶«.

Equalizer

Equalizer offers a sound setting that you can create.

Equaliser appears in the menu when »Sound mode« is selected as »Spatial« or »Normal«, and »Sound Medium« as »User«.

- 1 Select »Equalizer« with »▼« or »▲« and press »●« to confirm.
The »EQUALIZER« menu appears.

Note:

- If the »SRS TS HD« setting has been selected in the »Sound Mode« line, the »Equalizer« line will not indicate.
- 2 Select the frequency bandwidth »120Hz« with »▼« or »▲«.
Set the preferred value with »◀« or »▶«.
 - 3 Set the next frequency bandwidth with »▼« or »▲« and repeat the setting.
 - 4 Press »Z« to save the setting.

Audio description (Audio subtitles)

Audio description is an additional audio channel for visually-impaired persons. Descriptions are provided of activities, surroundings, changes of scene, gestures and actors' facial expressions.

This audio channel is transmitted simultaneously with the normal sound on digital channels. Availability depends on the respective channel and broadcaster.

- 1 Select the line »Audio Description« with »▼« or »▲« and select the option »On« with »◀« or »▶«.
- 2 Select the line »Volume« with »▼« or »▲« and change the volume with »◀« or »▶«.



Exiting the setting

- 1 Press »i« to end the setting.



* Under licence from SRS Labs, Inc. TruSurround HD, SRS and the  symbol are trademarks of SRS Labs, Inc.

Basic functions

Switching on and off



- 1 Press »«, »1...0« or »P+« or »P-« to switch on the television from standby mode.
- 2 Press »« to switch the television to standby.

Selecting channels

- 1 Press »1...0« to select presets directly.
- 2 Select channels step by step with »P+« or »P-«.
- 3 Open the channel list with »«, select the preferred television channel with »V«, »A«, »<« or »>« and press »« to confirm. Exit the channel list with »i«.

Selecting channels from lists

You can select channels from various lists (e.g. all channels, FAV 1 to FAV 4).

- 1 Press »« to open an overview of programme tables.
- The overview is displayed.
- 2 Select a channel list with »A« or »V« and open it with »«.
- 3 Select a television channel with »V«, »A«, »<« or »>« and press »« to confirm.
- 4 Press »i« to exit the channel list.

Selecting a preset AV channel

- 1 Open the »Select Source« menu with »AV«.
- 2 Select an AV preset with »V«, »A«, »<« or »>« and press »« to confirm.
- 3 Use »1...0« to switch back to the television channel.

Adjusting the volume

- 1 Adjust the volume with »-« or »+«.

Switching sound on/off



- 1 Press »« to mute the sound or switch it on again.

Displaying information

- 1 Display information with »?«.
- The display disappears automatically after a short while.

Freeze-frame

If you wish to view a particular scene for longer, you can "freeze" the frame of the current programme.

- 1 Activate the freeze-frame function with »«.
- 2 End the freeze-frame function with »«.

Note:

- If an external data medium is connected to the television, the time shift function is activated with »«. The time shift function is described on page 27.

Picture settings

Various picture settings are available.

- 1 Select »User«, »Eco TV«, »Vivid«, »Natural«, »Movie«, »Sports« or »Game« by pressing »«.
- You can change the »User« picture setting; see "Picture settings" on page 18.

Note:

- Picture setting »Game« can only be selected in »HDMI«, »Component« and »PC« modes.

Audio settings

Various audio settings are available.

- 1 Select the audio setting »User«, »Music«, »Natural« or »Speech« by pressing »«.
- You can change the »User« audio setting – see the "Soundeffects" chapter on page 20.

Note:

- »User« option is active when »Sound mode« setting is selected as »Normal« or »Spatial«.

TELEVISION - OPERATION

Audio language

Various languages are available on digital television channels. This depends on the programme being broadcast.

- 1 Open the selection menu with »?«.
- 2 Select the language by pressing »V« or »^« and press »●« to confirm.

Subtitles

Various subtitles are available on digital television channels. This depends on the programme being broadcast.

- 1 Open the selection menu with »□«.
- 2 Select the subtitles with »V« or »^« and press »●« to confirm.

Zoom function

This function allows you to enlarge the picture as required.

- 1 Press »□« repeatedly to enlarge the display in three steps.

Eco mode

This function allows you to reduce the power consumption.

- 1 Switch on the Eco mode with »ECO«.
- 2 Switch the Eco mode off again with »ECO«.

Zapping function

This function remembers the channel you are currently watching while you switch over to other ones (zapping).

- 1 Press »1...0« or »P+«, »P-« to select the channel to be stored in the zapping memory and press »Z« to confirm.
- 2 Press »1...0« or »^«, »V« to switch to another television channel.
- 3 Press »Z« to switch between the saved television channel and the last television channel viewed.
- 4 End the function with »i«.

Electronic TV guide

The electronic TV guide provides an overview of all programmes that will be broadcast in the next week (for digital channels only).

- 1 Press »TV-G« to display channel information.

Notes:

- Not all channels supply provide a detailed TV guide.
 - Many broadcasters transmit the current schedule, but do not offer detailed descriptions.
 - There are broadcasters which do not provide any information at all.
- 2 Press »V« or »^« to select a television channel.
- Today's programmes on the television channel selected are displayed.
 - 3 Switch to the information about the current programme with »>«.

Notes:

- You can open and switch off the extensive programme information with »?«.
 - You can add the selected broadcast to the memory timer by pressing »●«.
- 4 Press »V« to select information on the next programme and, »^« to return to the information for the current programme.
 - 5 Select programmes on over the coming days with »■« (green), and switch back to the current day with »■« (red).
 - 6 Switch back to the channel selection with »<«.

Note:

- Filter for certain programmes with »■« (blue), select the channel type with »<«, »>«, »V« or »^« and press »●« to confirm. Programmes which match the selected channel type are displayed.
- 7 Quit the electronic TV guide with »i«.

Changing the picture format

The television automatically switches to the 16:9 format if this format is detected via the SCART socket.

- 1 Select the picture format with »« (blue).
 - The picture format (for example »16:9«) is displayed.
 - You can choose between the following picture formats:

»Auto« format

The picture format is automatically switched to »16:9« for 16:9 programmes.

The picture format is automatically switched to »4:3« for 4:3 programmes.

»16:9« and »14:9« formats

For programmes in 4:3 format, the picture is stretched horizontally if the »16:9« format or »14:9« format is selected.

The picture geometry is stretched horizontally.

With actual 16:9 input sources (from a set-top box on the SCART socket) the picture fills the screen completely and with the correct geometry.

»4:3« format

The picture is shown in 4:3 format.

»LetterBox« format

The letterbox format is especially suitable for programmes in 16:9 format.

The black borders which are usually at the top and bottom of the screen are eliminated, 4:3 pictures fill the screen.

The transmitted pictures are enlarged, but are slightly cropped at the top and bottom. The picture geometry remains unchanged.

»Subtitle« format

If you cannot see the subtitles at the bottom of the screen, select »Subtitle«.

»Panorama« format

This setting is suitable for films in an especially wide format.

During programmes in 4:3 format, the picture is stretched horizontally if the »Panorama« function is selected. The picture geometry is stretched horizontally.

»Overscan« format

In this mode, HD pictures are not cropped by the HDMI sockets or component sockets, and are displayed in their original size. This only applies in HDMI mode and for resolutions of 720p or above.

Information on recording and playing television programmes

- Recording and playback of television programmes is only possible with digital television channels (DVB-T and DVB-C).
- The digital television channels (DVB-T and DVB-C) you are able to record and playback also depends on the broadcaster.
- Recording and playback of programmes, as well as the time shift function, can only be carried out using an external data medium (hard drive or USB stick). The data medium should have a minimum storage capacity of 2 GB.
- Recordings can be made with most data media on the market. However, we cannot guarantee operation for all data media.
- If a programme was recorded on an external data medium, it can only be played back on your television set. The playback of these programmes is not possible on other devices.
- If you send your television to be repaired and hardware components need to be replaced, you might not be able to play the recordings again on the repaired television.
- Reception for SKY broadcasting service is currently only possible in Germany with a suitable set-top box or suitable CA module.
- Grundig does not accept liability for any loss of saved data on an external data medium.

Possible limitations when using an external data medium

Depending on the broadcaster, you may experience various restrictions on some of the functions from some television channels.

GRUNDIG has no influence on these restrictions.

- Recording a programme on the external data medium can be disabled by the broadcaster. If the message »URI* protected! PVR function is blocked« appears on the screen, then recording or timeshift is restricted (one recording possible) or disabled (recording not possible) by the broadcaster.
* URI = User right information (Copyright information).
- If you record and save a programme on the archive of an external data medium, playback can be restricted.
The broadcaster can allow you to view this programme one or more times, but it may only be available for a certain period of time.
- Programmes not suitable for minors will require the input of a PIN number immediately before recording starts. If this authorisation is not given, the recording may not start.
- Copying a programme from a digital television channel onto a video or DVD recorder using the »AV 1« socket (analogue picture/sound signal) can also be restricted by the broadcaster. Prerequisite is that your device supports the copying function.

USB RECORDING

Connecting external data media

Notes:

- Before connecting the data medium, switch the television to standby with »**U**«. Connect the device and then switch the television on again.
- Before removing the external data medium, the television must be switched to standby, so that no data loss occurs.
- Your television features two USB sockets, »**USB1**« and »**USB2**«. »**USB1**« is used to connect data media, which require an additional power supply, - for example, external hard disks.

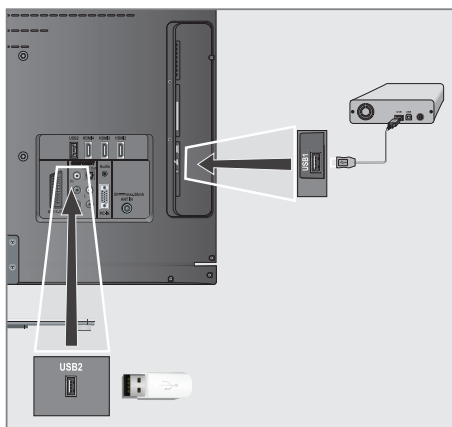

- 1 Connect the »**USB1**« socket of the television and the corresponding socket of the data medium (external hard disk) using a USB cable;

or

insert the USB plug of the USB memory stick into the »**USB2**« socket of the television.

- 2 Confirm the display »**USB**« with »**OK**« (green).
- The file browser appears.

Notes:

- The »**USB2**« socket of the television supplies a maximum power of 500 mA in accordance with USB specifications. External hard disks which require more power may therefore only be connected to the »**USB1**« of the television.
- If you use a network cable for external hard disks which have been connected to the »**USB1**« socket of the television, this network cable must also be disconnected from the power supply when the television is switched off.
- External data media may not be disconnected from the television while files on the data medium are being accessed.

Settings for USB recording

Selecting the menu

- 1 Open the menu with »**i**«.
- 2 Select the line »**USB RECORDING**« with »**V**« or »**A**« and press »**OK**« to confirm.
- The »**USB RECORDING**« menu appears.



USB RECORDING

Switching on automatic preview

If the automatic preview is switched on, a preview of the selected file appears in the file browser.

- 1 Select the line »Auto Preview« with »▼« or »▲«.
- 2 Switch on the function with »◀« or »▶« (»On«).
- 3 Press »i« to end the setting.

Safely remove disk

- 1 Select the line »Safely Remove Disk« with »▼« or »▲« and press »●« to confirm.

Note:

- The disk can now be removed from the socket.

Selecting external data media

If several external data media are connected to the television, you can select the preferred data medium.

- 1 Select the line »Disk« with »▼« or »▲«
- 2 Select the preferred data medium with »◀« or »▶«.
- 3 Press »i« to end the setting.

Selecting a partition on the external data medium

If the external data medium features several partitions, select the partition you would like to use.

- 1 Select the line »Partition« with »▼« or »▲«.
- 2 Select the partition you wish to use with »◀« or »▶«.
- 3 Press »i« to end the setting.

Testing the external data medium

You can subject external data media to a test and establish whether they are suitable for the chosen functionality.

- 1 Select the line »Disk« with »▼« or »▲«. If several data media are connected, select the preferred data medium with »◀« or »▶«.
- 2 Select the line »Partition« with »▼« or »▲«. If several partitions are available, select the partition you wish to use with »◀« or »▶«.
- 3 Select the line »Check Disk« with »▼« or »▲« and press »●« to confirm.
 - Information on the data medium is displayed.
- 4 Press »i« to end the setting.

“Pausing” time shift programmes

You can pause the programme you are watching. This is a useful function, for example if the telephone rings while you are watching a film and you do not want to miss anything.

A freeze-frame display of the last scene appears on the screen and the programme is recorded in the time shift memory of the external data medium.

In time shift mode you can record a maximum of 20 minutes of the current programme.

- 1 Press »**■**◀ to pause the current programme.
 - The picture is frozen, the time shift and the remaining recording time are displayed.
- 2 Press »▶◀ to resume the programme.
 - The programme will continue to be recorded.

Note:

- The following functions are possible when in time shift mode:
 - Rewind, press »◀◀ several times according to speed (the picture freezes while rewinding);
 - Fast forward, press »▶▶ several times according to speed;
 - Select pause with »**■**◀.
- 3 Press »**■**◀ to quit the time shift function.
 - The message »Live programme« appears, and you will see the current programme without time shift.
 - The scenes in the “time shift memory” are deleted.

Recording programmes

You can record programmes. The data for these programmes is recorded on an external data medium and this archive is administered via the television.

The following approximate values apply for recording:

Recording time for high-definition programmes (HD) is 7 minutes with 1 GB of memory, for standard programmes it is 26 minutes.

While recording, you can watch another programme from the archive.

You cannot change presets.

One-touch programme recording

- 1 Select the television channel to be recorded with »**1...0**◀ or »**P+**◀, »**P-**◀ and press »**●**◀ to start the recording.
 - Information on the recording is displayed: the recording symbol, the channel name, the programme, the recording time and the available memory space.
 - After a short time this information disappears.
- 2 End the recording with »**■**◀.
- 3 Confirm the display with »**■**◀ (green);
or
press »**■**◀ (red) to continue the recording.

Notes:

- After the recording is complete, the recording will be automatically saved on the external data medium.
- The »RECORDED FILES« menu, with the archived programmes, can be opened with »◀◀◀◀.
- If the external data medium is disconnected from the USB socket during recording, the recording will be stopped automatically and will not be saved.
- Play your recordings, that you have recorded with your FAT32 formatted HDDs, in USB mode.

Recording a programme from the channel list

- 1 Open the »CHANNEL LIST« with »●«.
- 2 Select a television channel with »▼«, »▲«, »◀« or »▶« and press »●« to confirm.
- 3 Press »i« to exit the channel list.
- 4 Press »●« to start recording.
 - Information on the recording is displayed: the recording symbol, the channel name, the programme, the recording time and the available memory space.
 - After a short time this information disappears.
- 5 Press »■« to stop recording.
- 6 Confirm the display with »■« (green);
or
press »■« (red) to continue the recording.

Presetting programmes to be recorded

... using the electronic TV guide

You can use data from the electronic TV guide for recording.

25 programmes can be preset for the timer recording or as a reminder.

- 1 Press »TV-G« to display channel information.
 - The electronic TV guide appears.
- 2 Select the preferred channel with »▼« or »▲«.
- 3 Switch to the information about the current programme with »▶«.
- 4 Select the programme of your choice with »▼« or »▲«.
- 5 Confirm the programme with »●«.
 - The symbol »●« appears after the name of the programme, and the data has been added to the timer.

Note:

- If the data for the recording is to be changed, use »■« (yellow) and »■« (blue) to switch to the »SCHEDULED EVENTS«, press »■« (green), change the data and save it with »■« (green).
- 6 Press »i« to exit the menu.

Notes:

- Before the timer recording begins, a warning message appears with a 20-second countdown. You can switch over to the programmed television channel.
- If the timer recording starts during playback, playback is not interrupted: Recording takes place automatically in the background as long as you do not select »Yes« when the timer countdown message is shown.

USB RECORDING

... by manual data entry

You can preset up to 25 programmes for timer recording.

- 1 Press »**TV-G**« to display channel information.
– The electronic TV guide appears.
- 2 Open the »**MAKE SCHEDULE**« menu by pressing »**■**« (yellow) twice.
- 3 Select the line »Type« with »**▼**« or »**▲**« and select the option »Recording« with »**◀**« or »**▶**«.
- 4 Select the line »Channel« with »**▼**« or »**▲**« and select the channel with »**◀**« or »**▶**«.
- 5 Select the line »Mode« with »**▼**« or »**▲**« and select the preferred mode (»Once«, »Every Day« or »Weekly«) with »**◀**« or »**▶**«.
- 6 Select the line »Start« (Start recording) with »**▼**« or »**▲**« and enter the date/time with »**1...0**«.
- 7 Select the line »End« (Stop recording) with »**▼**« or »**▲**« and enter the date/time with »**1...0**«.
- 8 Save the data with »**■**« (green).
– The programme is preset.
- 9 Press »**i**« to exit the menu.

Notes:

- Before the timer recording begins, a warning message appears with a 20-second countdown. You can switch over to the programmed television channel.
- If the timer recording starts during playback, playback is not interrupted: recording takes place automatically in the background as long as you do not select »Yes« when the timer countdown message is shown.

Editing recording data in the timer menu

You can edit the data for programmed timer recordings.

- 1 Select the timer menu by pressing »**TV-G**«, »**■**« (yellow) and »**■**« (blue) in succession.
– The »SCHEDULED EVENTS« menu appears.
- 2 Select the title of the programme to be changed with »**▼**« or »**▲**« and activate the timer position with »**■**« (green).
– The input menu is displayed.
- 3 Select the required option with »**▼**« or »**▲**« and edit the data with »**1...0**« and »**◀**« or »**▶**«.
- 4 Save the changes with »**■**« (green).
– The timer has been changed.
- 5 Press »**i**« to close the menu.

Deleting recording data in the timer menu

You can delete the data for programmed timer recordings.

- 1 Select the timer menu by pressing »**TV-G**«, »**■**« (yellow) and »**■**« (blue) in succession.
– The »SCHEDULED EVENTS« menu appears.
- 2 Select the title of the programme to be deleted with »**▼**« or »**▲**« and delete the timer position with »**■**« (yellow).
- 3 Press »**i**« to close the menu.

Playback

The recorded programmes – whether started manually or using the timer function – are stored on the external data medium. You can open the archive on the external data medium by pressing »◀◀◀«.

Selecting a programme from the archive

- 1 Open the »Recorded Event« menu with »◀◀◀«.
– The menu appears.
- 2 Select the programme of your choice with »▼« or »▲« and start playback with »▶«.
- 3 Press »■« to end playback.
– The television switches over to the current television channel.

Forward/reverse picture search

- 1 During playback, select the fast forward speed (2x, 4x, 8x, 16x or 32x) with »▶▶«;
or
during playback, select the rewind speed (2x, 4x, 8x, 16x or 32x) with »◀◀« (the picture freezes when rewinding).

Repeating a scene (A-B)

You can mark the starting and ending point of a scene. The scene is then repeated continuously.

- 1 Mark the starting point A by pressing »▶« at the required scene during playback.
– This scene is marked as the starting point A.
- 2 Mark the end point B by pressing »▶« once again at the required scene during playback.
– This scene is marked as the end point B.
– The television repeats the programme between these two points.
- 3 Quit the repeat function with »■«.

Playback during a recording

During a recording, you can either watch the programme you are currently recording or watch a different one that you have already recorded.

- 1 Select the channel to be recorded with »1...0« or »P+«, »P-« and press »●« to start the recording.
- 2 Select the »Recorded Event« menu by pressing »◀◀◀«.
- 3 Select the programme you want with »▼« or »▲« and press »▶« to start playback.
– The recording continues in the background.
- 4 Press »■« to end playback.
- 5 Press »■« to stop recording.

Deleting programmes in the recording list

You can delete programmes from the recording list.

- 1 Open the »Recorded Event« menu with »◀◀◀«.
– The menu appears.
- 2 Select the programme to be deleted with »▼« or »▲«.
- 3 Press ■ (blue) to delete the programme.
- 4 Confirm the security query with »■« (green).

Note:

- You cannot delete programmes in the »Recorded Event« menu which are currently being recorded or played back.
- 5 Press »i« to close the menu.

USB OPERATION

File formats

Your television can work with the following file formats using the USB sockets:

Video data

Special codecs for video compression and decompression provide more memory space without compromising the picture quality excessively.

Your television plays video files in the formats DIVX, XVID, H.264/MPEG-4 AVC (L4.1, 4 reference pictures), MPEG-4, MPEG-2, MPEG-1, MJPEG and MOV.

The following file name extensions are also supported: AVI, MKV, MP4, TS, MOV, MPG, DAT, VOB. These files can also contain audio files compressed using MP3, AAC or Dolby Digital®.

Audio data

Your television can play audio data in the formats MP3, AAC, WMA.

MP3 is the abbreviation for MPEG-1 Level 3 and is based on the MPEG-1 standard, which was developed by the MPEG (Motion Picture Expert Group).

AAC stands for Advanced Audio Coding and was also developed by MPEG. AAC provides better sound quality at an identical data rate.

WMA (Windows Media Audio) is a compression standard for audio data developed by Microsoft.

These formats allow audio files to be recorded and played which sound as good as a CD, while taking up only a fraction of the memory space.

File name extensions which are supported: MP3, MP2, WMA, M4A, AAC.

MP3 files can be organised into folders and subfolders, as on the computer.

Image data

Your television can display pictures in the formats JPEG, PNG and BMP.

JPEG stands for Joint Picture Experts Group. It denotes a process for compressing picture files.

PNG and BMP are process used to save image data with no, or very little, losses.

Picture files can be stored with other types of files on one medium.

These files can be organised into folders and subfolders.

USB OPERATION

Connecting external data media

Before connecting the data medium, switch the television to standby using **»⏻«**. Connect the device and then switch the television on again.

Before removing the external data medium, the television set must be switched to standby, so that no data loss occurs.

Notes:

- The **»USB2«** socket of the television set supplies a maximum power of 500 mA in accordance with USB specifications. External hard disks which require more power may therefore only be connected to the **»USB1«** of the television set.
- If you use a network cable for external hard disks which are connected to the **»USB1«** socket on the television, this network cable must also be disconnected from the power supply when the television is switched off.
- External data media may not be disconnected from the television set while files on the data medium are being accessed.
- A bi-directional data transfer as defined for ITE (Information Technology Equipment) devices in EN 55022/EN 55024 is not possible.
- USB transfer is not in itself an operating mode. It is only an additional function.

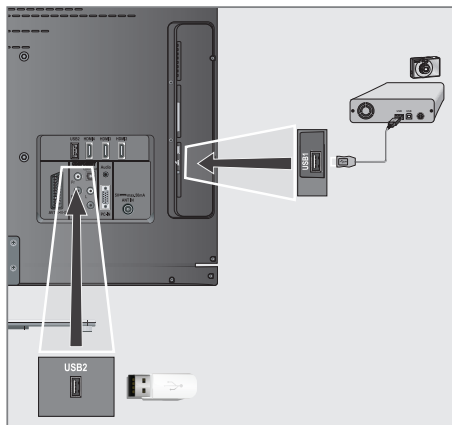

- 1 Connect the **»USB1«** socket of the television and the corresponding socket on the data device (external hard drive, digital camera, card reader or MP3 player) using a USB cable;

or

insert the USB plug of the USB memory stick into the **»USB2«** socket of the television set.

- 2 Confirm the display **»«** with **»■«** (green).
 - The file browser appears.

USB OPERATION

The file browser

The file browser displays video, audio and picture files stored on external data media.

If an external data medium contains files in different formats, you can, when necessary, filter out the formats not required.

Main menu of the file browser

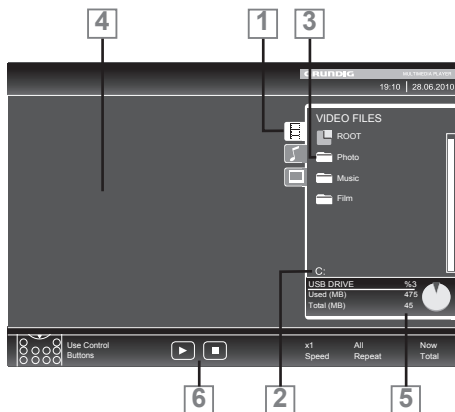

- 1 Selected data format.
- 2 Name of the data medium.
- 3 Total number of folders on the data medium.
- 4 Preview of the selected file.
- 5 Information on the external data medium.
- 6 Menu navigation.

Settings in the USB setup menu

Selecting the menu

- 1 Open the menu with »i«.
- 2 Select the »SOURCE SETUP« menu item with »▼« or »▲« and press »●« to confirm.
 - The »USB SETUP« menu appears.

Note:

- Additional functions are explained in the following sections.

Switching on automatic preview

If this function is switched on, a preview of the selected file then appears in the file browser.

- 1 Select the line »Auto Preview« with »▼« or »▲«.
- 2 Switch on the function with »◀« or »▶« (»On«).
- 3 Press »i« to end the setting.

Selecting the display mode

- 1 Select »View Mode« with »▼« or »▲«.
- 2 Select the preferred option with »◀« or »▶«.
- 3 Press »i« to end the setting.

Setting the display duration for pictures in a slideshow

- 1 Select »Slide Show Interval« with »▼« or »▲«.
- 2 Select the display duration (3, 5, 10 seconds) with »◀« or »▶«.
- 3 Press »i« to end the setting.

USB OPERATION

DivX® VOD

You must have your device registered in order to play the protected video that you will buy from DivX®.

- 1 Select »DivX® VOD« with »▼« or »▲« and confirm with »●«.
- Registration Code appears.
- 2 Visit "http://vod.divx.com" and register the device with the registration code.
- 3 Press »i« to end the setting.

DivX⁺ HD DivX Certified® to play DivX® and DivX Plus™ HD (H.264/MKV) video up to 1080p HD including premium content.

ABOUT DIVX VIDEO: DivX® is a digital video format created by DivX, Inc. This is an official DivX Certified® device that plays DivX video. Visit divx.com for more information and software tools to convert your files into DivX video.

ABOUT DIVX VIDEO-ON-DEMAND: This DivX Certified® device must be registered in order to play purchased DivX Video-on-Demand (VOD) movies. To obtain your registration code, locate the DivX VOD section in your device USB setup menu. Go to vod.divx.com for more information on how to complete your registration.

Basic playback functions

- 1 Select the data medium by pressing »AV«, use »▼«, »▲«, »◀« or »▶« to select the option »USB« and press »●« to confirm.
- The file browser appears.
- 2 Select the file format (video files, audio files, picture files) with »▼« or »▲«.
- 3 Switch to the folder/file list with »●«.

Note:

- USB data medium with several partitions is connected to the USB sockets, the letter for the respective drive (e.g. C) appears behind the folder symbol. Select the letter of the drive with »▼« or »▲« and press »●« to confirm.
- 4 Select the folder or file with »▼« or »▲« and press »●« to open it.
- A list of subdirectories appears.

Note:

- Switch back to the main folder with »Z«.
- 5 Select the track or picture with »▼« or »▲« and press »▶« to start playing.
- You can view information on the film data by pressing »?«.
- When playing MP3 or WMA data, information on the album, track and singer is displayed at the left of the menu.
- When playing picture files, you can use »?« to display information about the resolution and size.
- When playing picture data, press »?« twice to enter the DivX® Settings menu.

Note:

- When playing picture data, the file browser switches off. Press »■« to display the file browser again.
- 6 Press »■« to pause playback.
 - 7 Press »▶« to resume normal playback.
 - 8 Press »■« to end playback.
The file browser appears.

Notes:

- Use »^« to select »Up Folder«, when you would like to return to the last folder. Use »Root« (and then press »●«) to return to the main folder.
- It is possible that files which are actually supported do not function correctly in USB mode. This is because certain files are not recorded with standardised compression processes, although they feature the "right" file ending.
- If a video file features several audio tracks (audio streams), you can switch these over during playback in full screen mode with »?«.
- When playing music files, you can use other options in the USB mode at the same time. This way, you can, for example, enhance a slideshow with music.
- For films, only subtitles in the SRT format are supported. The names of the subtitle and film files must be identical. Otherwise, no subtitles will be shown.

Additional playback functions

Depending on the file format, the following additional functions are available:

Selecting chapters on DivX® files

(only video files)

- 1 During playback, select the next chapter with »>«.
- 2 During playback, select the previous chapter with »<«.

Note:

- You can also select chapters by entering the chapter number with »1...0«.

Selecting titles on DivX® files

(only video files)

- 1 During playback, select the next title with »^«.
- 2 During playback, select the previous title with »v«.

Playing selected titles

Only the marked tracks are played.

- 1 Select the titles with »v« or »^« and press »●« to mark it.
- 2 Select the next title with »v« or »^« and press »●« to mark it.
- 3 Start playback with »▶«.
- 4 Press »■« to end playback.

Note:

- To remove the marking, select the title with »v« or »^« and press »●« to remove the marking.

USB OPERATION

Selecting a track or picture in steps (SKIP)

- 1 During playback, select the next track/picture with »▶◀.
- 2 During playback, select the previous track/picture with »◀◀.
 - Playback begins with the track or picture you selected.

Selecting a certain passage for playback

(video files only)

- 1 During playback, press »●◀.
- 2 Enter the passage (time) with »1 ... 0◀ and press »■◀ (green) or »●◀ to confirm.

Fast forward

(for video and audio files only)

You can select different speeds (2-fold, 4-fold, 8-fold, 16-fold and 32-fold forwards and backwards).

- 1 Select the playback speed during playback with »◀◀◀ or »▶▶▶◀.
- 2 Press »▶◀◀ to resume normal playback.

Enlarging or reducing the display

(for video and audio files only)

This function allows you to enlarge or reduce various picture sections.

- 1 During playback or pause, press »[Q]◀.

Rotating pictures

(picture files only)

You can rotate pictures by 90°.

- 1 During playback, press »◀◀◀ or »▶▶▶◀ to rotate the pictures by 90°.

Repeat functions

Options:

- »One Repeat◀: the current track will be repeated.
- »All Repeat◀: all tracks will be repeated.

- 1 Switch off the repeat function before playback with »CEC◀.
- 2 Start playback with »▶◀.
- 3 Deactivate the repeat function with »CEC◀.
 - The display changes to »None Repeat◀.

TELETEXT OPERATION

TOP text or FLOF text mode

- 1 Press »TXT« to switch on teletext.
- 2 Select teletext pages directly with »1...0« or step by step with »▼« and »▲«.
Return to teletext page 100 with »?«.

Note:

- At the bottom of the screen there is an info bar with red, green and – depending on the channel – yellow and blue panels. Similarly, the remote control also features buttons with different colours with which these pages can be selected.
- 3 Go back a page with »■« (red).
 - 4 Go to the next page with »■« (green).
 - 5 Select a particular chapter with »■« (yellow).
 - 6 Select a particular subject with »■« (blue).
 - 7 Quit teletext with »TXT«.

Normal text mode

- 1 Press »TXT« to switch on teletext.
- 2 Press »1...0« to select teletext pages directly.
Return to teletext page 100 with »?«.
- 3 Go back a page with »▼«.
- 4 Go to the next page with »▲«.
- 5 Quit teletext with »TXT«.

Additional functions

Skipping the waiting time

While a page search is progressing, you can switch to the TV programme.

- 1 Enter the teletext page number with »1...0« and then press »▶|«.
– As soon as the page is found, the page number is displayed.
- 2 Press »▶|« to switch to the teletext page.

Enlarging the character height

If you have difficulty reading the text on the screen, you can increase the character height.

- 1 To enlarge the character height of a teletext page, keep pressing »|◀«.

Page hold

A multiple page may contain several sub-pages, which are automatically scrolled by the broadcasting station.

- 1 Stop the automatic scrolling of the sub-pages with »◀◀«.
- 2 Quit the function with »◀◀«.

Opening a sub-page directly

If the selected teletext page contains additional pages, the number of the current sub-page and the total number of pages are displayed.

- 1 Press »□« to open the sub-page function.
- 2 Use »◀« or »▶« to select the sub-page.
- 3 Quit the function with »□«.

Revealing answers

Certain teletext pages contain hidden answers or information.

- 1 Display information with »▶▶«.
- 2 Press »▶▶« to conceal the information.

Split screen

This function allows you to display the television channel on the left side, the teletext on the right side.

- 1 Switch the function on with »■«.
– The television channel and teletext are displayed next to each other.
- 2 Switch the function off with »■«.

Opening the SETTINGS menu

- 1 Open the menu with »i«.
- 2 Select the »SETTINGS« menu with »▼« or »▲« and press »●« to confirm.
- The »SETTINGS« menu appears.



Note:

- Additional operations are explained in the following sections.

Language settings

Changing the menu language

- 1 Select the line »Menu« with »▼« or »▲« and press »●« to confirm.
- The »Select Menu Language« menu appears.
- 2 Select the menu language with »◀«, »▶«, »▼« or »▲« and press »●« to confirm.
- 3 Press »i« to finish the setting.

Changing the audio language

(only for digital television channels)

You can define a primary and a secondary audio language.

- 1 Select the line »Audio« with »▼« or »▲« and press »●« to confirm.
- The »Select Audio Language« menu appears.
- 2 Select the audio language with »◀«, »▶«, »▼« or »▲« and then use »■« (red) to set it as the primary audio language, or use »■« (green) to set it as the secondary audio language.
- The primary and secondary language is displayed at the top right in the menu.
- 3 Press »i« to end the setting.

Changing the subtitle language and subtitle mode

(only for digital television channels)

You can switch the subtitles on and off, select the subtitle language and allocate a second subtitle language.

- 1 Select the line »Subtitle« with »▼« or »▲« and press »●« to confirm.
- The »Select Subtitle Language« menu appears.
- 2 Select the subtitle language with »▼«, »▲«, »◀« or »▶«, then use »■« (red) to set it as the primary subtitle language, or use »■« (green) to set it as the secondary subtitle language.
- The primary and secondary language is displayed at the top right in the menu.
- 3 To go back one menu level, press »Z«.
- 4 Select the line »Subtitle Mode« with »▼« or »▲« and then set the preferred option »Off«, »Hard of Hearing« or »Basic« with »◀« or »▶«.
- 5 Press »i« to end the setting.

CONVENIENCE FUNCTIONS

Setting the date and time

Automatic setting

Your television set detects the difference in time to Greenwich Mean Time (GMT) automatically, as long as the channel selected transmits a time signal.

- 1 Select the line »Time Adjustment« with »▼«, then select the option »Manual« with »◀« or »▶«.
 - The lines »Time Zone« and »Daylight Saving« are active.
- 2 Select the line »Time Zone« with »▼« and press »●« to confirm.
 - The »Select Time Zone« menu appears.
- 3 Select the appropriate time zone with »◀«, »▶«, »▼« or »▲« and press »●« to confirm.
- 4 Select the line »Daylight Saving« with »▼« and use »◀« or »▶« to set the option »Auto«, »Off« or »On«.
- 5 Press »i« to finish the setting.

Manual setting

You can also set the difference in time manually – for example, when the correct time is not detected automatically or does not correspond to local time for other reasons

- 1 Select the line »Date & Time« with »▼« or »▲« and press »●« to confirm.
- 2 Select the line »Auto« with »▼« or »▲« and press »●« to confirm.
 - Date and Time will be updated automatically;

or
- 3 Select the input box with »▼« or »▲«, enter the data for Date and Time with »1...0« and press »●« to confirm.

Timer settings

Entering the switch-off time (sleep timer)

In the »Sleep Timer« menu you can enter a time for the television to switch off. After this time has elapsed, the television switches to standby mode.

- 1 Select the line »Sleep Timer« with »▼« or »▲«.

- 2 Enter the switch-off time with »◀« or »▶«.

Note:

- To switch off the function, use »◀« or »▶« to set the switch-off time to »Off«.

- 3 Press »i« to end the set-up.

Switch-on timer

In the »Auto On« menu you can enter a switch-on time for the television. After the preset time has elapsed, the television switches on from standby – at the preselected volume and the preselected television channel.

- 1 Select the line »Auto On« with »▼« or »▲« and press »●« to confirm.

- 2 Select the line »Mode« with »▼« or »▲« and use »◀« or »▶« to select when the television should switch on.

- 3 Select the line »Input Source« with »▼« or »▲« and use »◀« or »▶« to select the input source.

- 4 Select the line »Service Type« with »▼« or »▲« and use »◀« or »▶« to select the preferred option (ATV, DTV, Radio or DATA).

- 5 Select the line »Channel« with »▼« or »▲« and use »◀« or »▶« to select the preferred channel.

Note:

- The line »Channel« is only active when the input signal currently in use has been set. If no entry has been made, then the first channel of the selected input source will be used.

CONVENIENCE FUNCTIONS

6 Select the line »Volume« with »V« or »^« and use »<« or »>« to set the volume.

7 Select the line »Set Hour« with »V« or »^« and enter the time with »1...0«.

8 Save the data with »■« (green).

Note:

■ You can abort the entry by pressing »■« (red).

9 Press »i« to end the setting.

Switch-off timer

In the »Auto Off« menu, you can enter a time for the television to switch off. After this time has elapsed, the television switches to standby mode.

1 Select the line »Auto Off« with »V« or »^« and press »●« to confirm.

2 Select the line »Mode« with »V« or »^« and use »<« or »>« to set the preferred mode.

3 Select the line »Set Hour« with »V« or »^« and enter the time with »1...0«.

4 Save the data with »■« (green).

Note:

■ You can abort the entry by pressing »■« (red).

5 Press »i« to end the setting.

Automatic switch-off (Auto Sleep)

If this function is activated, the television switches to standby after 5 minutes if no video signal is broadcast.

1 Select the line »Auto Sleep« with »V« or »^«.

2 Activate the function with »<« or »>« (»On«).

Note:

■ To switch off the function, use »<« or »>« to select the setting (»Off«).

3 Press »i« to end the setting.

Parental control settings

Authorising programmes

There are films which may be wholly or partially unsuitable for children.

These programmes contain information which marks the content or scenes with access levels of 4 to 18. You can select one of the access levels, thereby authorising playback.

1 Select the line »Parental Guidance« with »V« or »^« and press »●« to confirm.

2 Enter the PIN code »1234« with »1 ... 0«.

3 Select the access level with »<« or »>«.

4 Press »i« to end the setting.

Locking menus

This function allows you to lock the »Automatic Channel Search«, »Digital Manual Tuning«, »Analogue Manual Tuning« and »Program Table« menus so that they can be only accessed by entering a PIN code.

1 Select »Menu Lock« with »V« or »^«.

2 Enter the PIN code »1234« with »1 ... 0«.

3 Activate the lock with »<« or »>« (»On«).

Note:

■ To switch off the menu lock, use »<« or »>« to select the setting (»Off«).

4 Press »i« to end the setting.

Locking keys (Parental lock)

When the key lock is activated, the buttons on the television set do not function.

1 Select the line »Keypad Lock« with »V« or »^«.

2 Enter the PIN code »1234« with »1 ... 0«.

3 Activate (On) or deactivate (Off) the key lock with »<« or »>«.

4 Press »i« to end the setting.

CONVENIENCE FUNCTIONS

Changing the PIN code

You can also enter a personal PIN code instead of the default code »1234«. Please take note of your own PIN code.

- 1 Select »Set PIN« with »▼« or »▲« and press »●« to confirm.
- 2 Enter the current PIN code 1 2 3 4 with »1 ... 0«.
- 3 Enter your new four digit PIN code with »1 ... 0«.
- 4 Enter your new four digit PIN code with »1 ... 0« again.
- 5 Press »i« to end the setting.

Locking television channels

You can lock individual television channels, for example channels unsuitable for children, using a personal PIN code.

- 1 Open the menu with »i«.
- 2 Select the »SOURCE SETUP« menu with »▼« or »▲« and press »●« to confirm.
- 3 Select the line »Program Table« with »▼« or »▲« and press »●« to confirm.
- The »PROGRAM TABLE« menu is displayed.
- 4 In the »PROGRAM TABLE« menu, switch over to the list view with »■« (yellow).
- 5 Select the channel to be locked with »▼« or »▲«.
- 6 Select the column »Lock« with »◀« or »▶« and press »●« to lock the channel.
- 7 Enter the PIN code »1234« with »1 ... 0«.
- The channel is marked using »✓«.

Note:

- To remove the lock, select the channel again with »▼« or »▲«, press »●« to confirm and then enter the PIN code 1 2 3 4 using »1 ... 0«.
- 8 Press »i« to end the setting.

Updating software

(for digital channels only)

- 1 In the »SETTINGS« menu, select the line »Check For Updates updates« with »▼« or »▲« and press »●« to confirm.
- A search for new software will be made and - if available - it will be installed.

Note:

- If a search for software updates should be made automatically, select the line »Automatic OAD« with »▼« or »▲« and use »◀« or »▶« to select the option »On«.
- The software will be updated automatically as far as possible.
- 2 Press »i« to end the setting.

Restoring the television to the default settings

This function allows you to delete the channel lists and all custom settings.

- 1 In the »SETTINGS« menu, select the line »Restore Factory Defaults« with »▼« or »▲« and press »●« to confirm.
- 2 Press »■« (green) to confirm the warning message.
- The »Source Setup« menu appears.
- 3 Continue the settings with the chapter "Initial set-up and tuning television channels" on page 14.

OPERATION USING EXTERNAL DEVICES

DIGI LINK



Your television is equipped with the DIGI LINK function.

This function uses the CEC (Consumer Electronics Control) protocol.

CEC allows external devices which are connected to the »HDMI« sockets by an HDMI cable (e.g. DVD player) to be operated with a remote control.

Prerequisite is that the devices connected support CEC. Read the operating manual for the external device to find out how to activate the corresponding function.

The DIGI LINK functions on your television

Switching on the television automatically from standby

If the »Autom. switch-on TV« function is activated (»On«), then once the external device (e.g. DVD player) is switched on, the television also switches on and the appropriate HDMI preset is selected.

Automatic selection of the HDMI preset on the television

If your television is switched on and you then switch on the external device (e.g. DVD player), the appropriate HDMI preset on the television will be selected.

Selecting the menu language

The television menu language is automatically selected on the external device (e.g. DVD player). The external device must support this function.

Switching off the external device automatically

If you switch your television to standby, the external device (if it is switched on) will also be switched to standby.

DIGI LINK is always active on your television set.

Searching for and activating external devices

You can connect up to 11 devices with DIGI LINK functions to your television.

- 1 Open the CEC device list with »CEC«.
 - The »HDMI CEC Device List« appears.
- 2 Start the device search with »■« (red).
 - The devices found are displayed in the menu.
- 3 Select the device for operation with »▼«, »^«, »◀« or »▶« and press »●« to mark it.
 - If the selected device is connected to a different input to the current one, a switch to the respective input will occur automatically.
- 4 Press »i« to end the setting.

OPERATION USING EXTERNAL DEVICES

Device operation

You can decide whether external devices should react to your television's remote control.

- 1 Press »AV«, use »V«, »^«, »<« or »>« to select the preset »HDMI1« to »HDMI4« and press »●« to confirm.
- 2 Open the menu with »i«.
- 3 Select the menu item »SOURCE SETUP« with »V« or »^« and press »●« to confirm.
– The »SOURCE SETUP« menu appears.

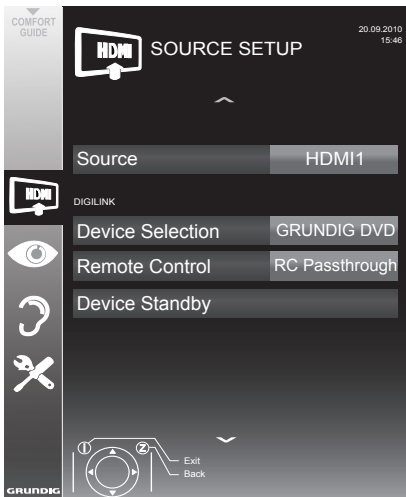

- 4 Select the line »Remote Control« with »V« or »^«.
- 5 Select the type of operation (»RC Passthrough«, »Deck« or »Tuner« with »<« or »>«.

Notes:

- »RC Passthrough« can be used for all devices. »Deck« and »Tuner« can be selected in accordance with the external device which has been connected.
 - Try out which type of remote control operation the external device reacts to the best.
 - Read about the scope of functions of the DIGILINK-compatible device in the respective operating manual.
- 6 Press »i« to end the setting.

Switching the device to standby

This option switches the external device to standby.

- 1 Press »AV«, use »V«, »^«, »<« or »>« to select the preset »HDMI1« to »HDMI4« and press »●« to confirm.
- 2 Open the menu with »i«.
- 3 Select the menu item »SOURCE SETUP« with »V« or »^« and press »●« to confirm.
– The »SOURCE SETUP« menu appears.
- 4 Select »Device Standby« with »V« or »^« and press »●« to confirm.
– The external device switches itself off.

OPERATION USING EXTERNAL DEVICES

High definition HD ready



Connect the corresponding input sources (e.g. HDTV receiver or HD-DVD player) to the »HDMI« sockets (for digital HDTV sources).

This ensures that you can view digital HDTV programmes, even if they are copy-protected (HDCP High Bandwidth Digital Content Protection), without encountering problems.

Connection options

- Which television socket(s) you connect your external devices to depends on the sockets the external device is equipped with and the signals which are available.
- Please note: With many external devices, the resolution of the video signal must be adjusted to the input sockets of the television (see the operating manual of the external device). You can find out which values you need to set by referring to the guidelines in the sections about the various connection options.
- Do not connect any other equipment while the device is switched on. Also switch off the other equipment before connecting it.
- Do not plug in the power cord of the device until you have connected the external equipment and the antenna.

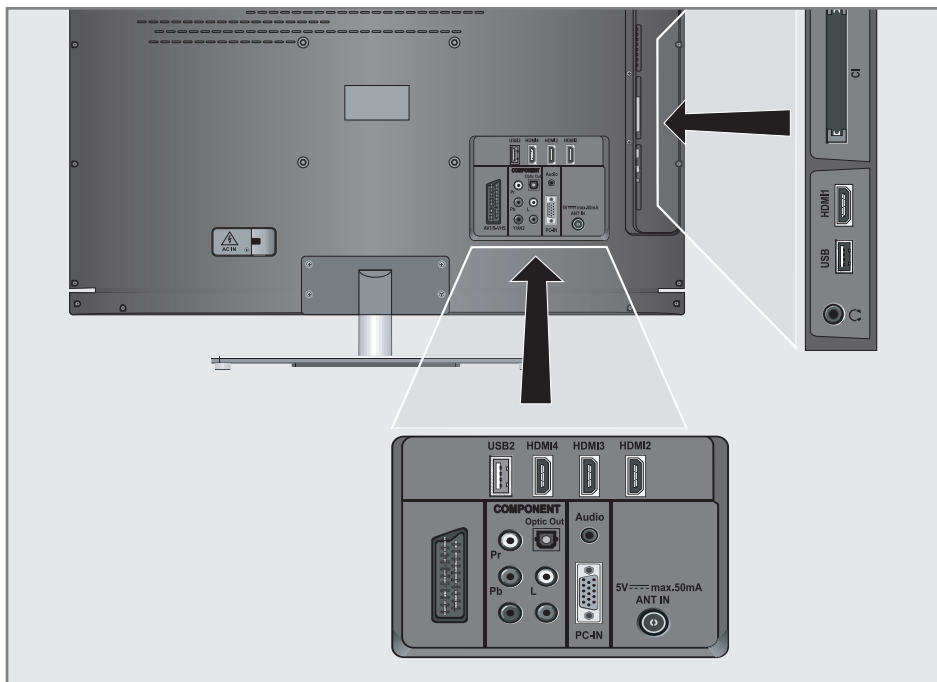

OPERATION USING EXTERNAL DEVICES

Connecting external devices

... with digital audio/video signals

- Suitable devices: Digital satellite receivers, Playstation, BluRay player, DVD player/recorder, set-top box, notebook, PCs.
- Video signal: Digital video; resolution: standard 576p; HDTV 720p, 1080i, 1080p.
- Audio signal: digital audio (stereo, multi-channel compression, uncompressed).
- Presets »HDMI 1«, »HDMI 2«, »HDMI 3« or »HDMI4«.

- 1 Connect the »HDMI1«, »HDMI2«, »HDMI3« or »HDMI4« socket on the television and the corresponding HDMI socket on the external device using a standard HDMI cable (digital video and audio signal).

... with analogue video signal (progressive)

- Suitable devices: DVD recorders/players, games consoles.
- Video signal: YUV; resolution: standard 576p; HDTV 720p, 1080i, 1080p.
- Audio signal: stereo, analogue.
- »Component« preset.

- 1 Connect the »COMPONENT Y/AV2 Pb Pr« sockets on the television to the corresponding sockets of the external device with RCA cables (video signal).
- 2 Connect the »COMPONENT L R« sockets on the television to the corresponding sockets of the external device with RCA cables (audio signal).

... using the SCART socket (CVBS/RGB signal)

- Suitable devices: Digital satellite receiver, DVD player/recorder, set-top box, games console, video recorder, decoder.
- Video signal: CVBS/RGB.
- Audio signal: stereo, analogue.
- »AV1« preset.

- 1 Connect the »AV1/S-VHS« socket on the television and the corresponding socket on the external device using a SCART cable (video and audio signal).

Activating a decoder

If a decoder is connected to the »AV1/S-VHS« socket, this must be activated to provide an unencrypted video/audio signal.

- 1 Open the menu with »i«.
- 2 Select »SETTINGS« with »v« or »^« and press »●« to confirm.
– The »SETTINGS« menu appears.
- 3 Select the »Decoder« with »v« or »^«.
- 4 Activate the function with »<<« or »>>« (»On«).
- 5 Press »i« to end the setting.

... with S-Video signal

- Suitable devices: DVD player/recorder, video recorder, camera recorder, notebook, PC.
- Video signal: Y/C.
- Audio signal: stereo, analogue.
- »S-VHS« preset.

- 1 Connect the »AV1/S-VHS« socket on the television and the corresponding socket on the external device using an EURO/AV cable (video and audio signal).

OPERATION USING EXTERNAL DEVICES

... with an analogue TV signal

- Suitable devices: Digital satellite receiver, DVD player/recorder, set-top box, camera recorder.
- Video signal: CVBS.
- Audio signal: stereo, analogue.
- »AV2« preset.

- 1 Connect the »Y/AV2« socket on the television to the corresponding socket of the external device with an RCA cable (video signal).
- 2 Connect the »L R« sockets on the television to the corresponding sockets of the external device with RCA cables (audio signal).

Note:

- There must not be a video signal at the »Y/AV2« and »AV1/S-VHS« socket at the same time. This could lead to picture disturbances.

Using a DVD player, DVD recorder, video recorder or set-top box

- 1 Switch on the external device and select the function you wish to use.
- 2 Press »AV«, use »V«, »^«, »<« or »>« to select the preset for the input signal (»AV1«, »AV2«, »S-VHS«, »HDMI1«, »HDMI2«, »HDMI3«, »HDMI4« or »Component«) and press »●« to confirm.

Headphones

Connecting the headphones

- 1 Plug the headphone jack (3.5 mm ø jack plug) into the headphone socket on the left side of the television.

Changing the headphone volume

- 1 Open the menu with »i«.
- 2 Select the menu item »SOUND SETTINGS« with »V« or »^« and press »●« to confirm.
 - The »SOUND SETTINGS« menu appears.
- 3 Select the menu item »Audio Output Setup« with »V« or »^« and press »●« to confirm.
 - The »Audio Output Setup« menu appears.
- 4 Select the line »Headphone« with »V« or »^«.
- 5 Set the preferred volume with »<« and »>«.
- 6 Press »i« to end the setting.

Note:

- Prolonged listening with headphones at loud volumes can damage your hearing.

OPERATION USING EXTERNAL DEVICES

Hi-fi system/AV receiver

Connecting the hi-fi system/ AV receiver

- 1 Connect the »Optic Out« socket on the television to the corresponding socket of the device with an optical digital cable (digital audio signal).

Setting the audio format

You can select whether the audio signal output via the »Optic Out« socket should be in the PCM or AC2 format.

- 1 Open the menu with »i«.
- 2 Select the menu item »SOUND SETTINGS« with »V« or »^« and press »●« to confirm.
– The »SOUND SETTINGS« menu appears.
- 3 Select »Audio Output Setup« with »V« or »^« and press »●« to confirm.
– The menu appears.
- 4 Select the »Optic Out« with »V« or »^«.
- 5 Select the preferred audio format (»PCM« or »Auto«) with »◀« or »▶«.

Note:

- If you wish to output the audio only via a multi-channel amplifier/AV receiver, set the option »TV Speaker« to »Off« in the menu.
- 6 Press »i« to end the setting.

Playing the audio signal via the HiFi system

- 1 Connect the »⌚« sockets on the television to the corresponding socket of the AV receiver with an cable (digital audio signal).

Note:

- If this function is not activated, the audio signal is transmitted to the HiFi system/AV receiver (connected to »⌚« 3.5 mm ø jack plug) into the headphone socket on the left side of the television.

- 1 Open the menu with »i«.
- 2 Select the menu item »SOUND SETTINGS« with »V« or »^« and press »●« to confirm.
– The »SOUND SETTINGS« menu appears.
- 3 Select »Audio Output Setup« with »V« or »^« and press »●« to confirm.
– The menu appears.
- 4 Select the line »Audio Out« with »V« or »^« and press »◀« or »▶« to activate the audio output (»Line Out«).
- 5 Select the line » Audio Out Status« with »V« or »^« and select the option »Fixed« or »Adjustable« with »◀« or »▶«.

Notes:

- If you select »Adjustable«, the volume can be changed in the menu option » Audio Out Volume«.
 - If the audio should only be output via the HiFi system/AV receiver, select the option »Off« in the line »TV Speaker« with »◀« or »▶«.
- 6 Press »i« to end the setting.

“Dolby” and the double-D logo are trademarks of Dolby Laboratories.
Manufactured under licence from Dolby Laboratories.

OPERATION AS A PC MONITOR

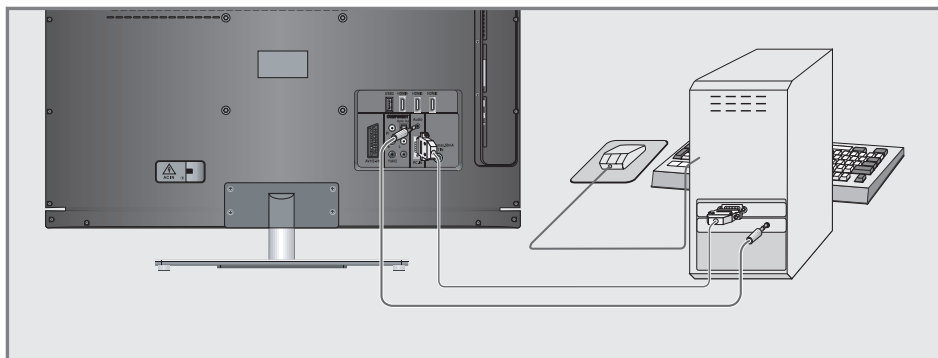

Connecting a PC

- 1 Connect the »PC-IN« socket on the television to the corresponding socket on the PC using a VGA cable (video signal).
- 2 Connect the »Audio« socket on the television to the corresponding socket on the PC using a suitable cable (audio signal).

Note:

- Adjust your PC to the monitor (for example, picture resolution 1280 x 768, picture frequency 60 Hz).

Selecting presets for the PC

- 1 Press »AV« and use »V«, »^«, »<« or »>« to select the preset »PC« and press »●« to confirm.

Settings for PC mode

- 1 Open the menu with »i«.
- 2 Select the »SOURCE SETUP« menu item with »V« or »^« and press »●« to confirm.
 - The »SOURCE SETUP« menu appears.
- 3 Select the function or setting with »V« or »^«, and then use »V«, »^« or »<«, »>« to implement it.

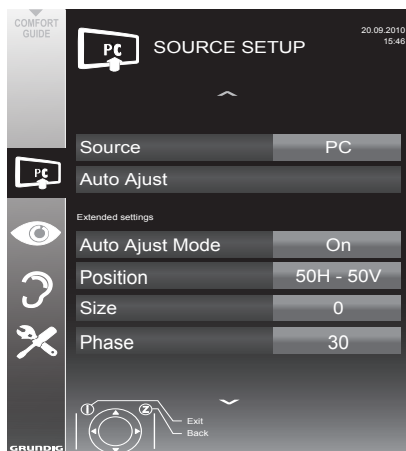

Options:

- »Auto Ajust« for automatic PC configuration.
 - »Auto Ajust Mode«, select the option »On« if the configuration should be implemented automatically in PC mode.
 - »Position« to configure the horizontal and vertical picture position.
 - »Size« to set the cycle frequency.
 - »Phase« to eliminate flicker, unfocused pictures or horizontal interference.
- 4 Press »i« to end the setting.

OPERATION WITH A COMMON INTERFACE

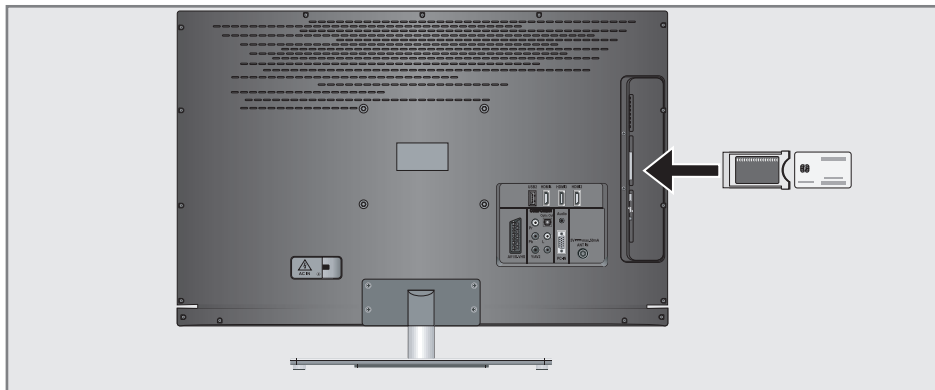

What is a Common Interface?

- Common Interface (CI) is an interface for DVB receivers.
- Encrypted channels can only be viewed with a CA module suitable for the encryption system and in conjunction with the corresponding smart card.
- The television set is equipped with a Common Interface slot into which CI modules from various providers can be inserted.
- You can insert the provider's smart card into the CA module in order to enable the encrypted channels you wish to view.

Inserting the CA module

Note:

- Switch the device off before you insert a CA module into the »CI« slot.
- 1 Insert the corresponding smart card into the CI module.
 - 2 Insert the CI module with the smart card into the »CI« slot on the television.

Note:

- In the »CA Module« sub-menu you can see which CA module has been inserted in the CI slot.
- If you are inserting a CA module into the CI slot of the television for the first time, you will need to wait a moment until the CA module is detected.

Access control for CI module and smart card

- 1 Open the menu with »i«.
- 2 Select the line »SOURCE SETUP« with »▼« or »▲« and press »●« to confirm.
– The »SOURCE SETUP« menu appears.
- 3 Select the line »CA-Module« with »▼« or »▲« and press »●« to confirm.

Notes:

- This menu provides operating instructions and – after you enter your PIN code – access to the PAY-TV provider's channels.
 - The remaining settings are described in the operating manuals for your CI module and smart card.
 - The CA modul is not supported in certain countries and regions; please consult your authorised dealer.
- 4 Press »i« to end the setting.

SPECIAL SETTINGS

Searching for television channels from the cable provider automatically

- 1 Open the menu with »i«.
- 2 Select the line »SOURCE SETUP« with »▼« or »▲« and press »●« to confirm.
- The »SOURCE SETUP« menu appears.
- 3 Select the line »Source« with »▼« or »▲« and press »●« to confirm.
Select the option »Cable« with »◀«, »▶«, »▼« or »▲« and press »●« to confirm.
- 4 Select the line »Automatic Channel Search« with »▼« or »▲« and press »●« to confirm.
- The menu appears.

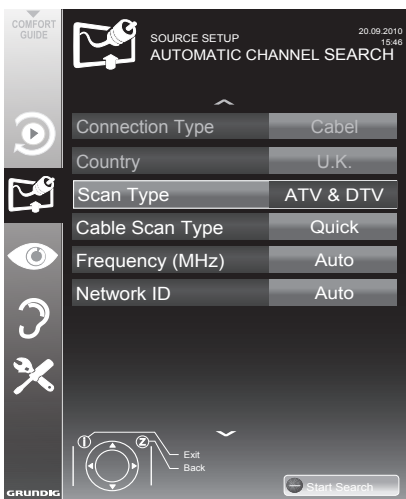

- 5 Select the line »Scan Typ« with »▼« or »▲« and set the option »DTV« with »◀« or »▶«.
- 6 Select the line »Cable Scan Type« with »▼« or »▲« and set the option »Quick« or »Full« with »◀« or »▶«.
- The search function »Quick« sets the channels according to the information provided by your cable provide in the transmission signal.
- If the option »Full« is selected, the entire frequency range will be scanned. The search can take a long time with this option. This option is recommended if your cable provider does not support the search type »Quick«.

Note:

- You can accelerate the search. To do this, you need information about the frequency and network ID. You are usually able to get this data from your cable operator or find it in forums on the Internet. For example, the frequency 402MHz and network ID 61441 can be entered for Germany.
- 7 Start the scan with »■« (red).
- All channel and favourites lists will be deleted and compiled anew.

Note:

- After starting the scan, a security query will appear. Press »■« (green) to confirm the option »Yes«.
- The »Results« menu appears, and the scan for TV channels begins. Depending on the number of television channels received, this can easily take a few minutes.
- The scan is complete as soon as the »PROGRAM TABLE« appears.

Note:

- You can abort the search by pressing »i«.
- 8 Press »i« to end the setting.

SPECIAL SETTINGS

Searching for television channels from the cable provider manually

- 1 Open the menu with »i«.
- 2 Select the line »SOURCE SETUP« with »V« or »^« and press »●« to confirm.
- The »SOURCE SETUP« menu appears.
- 3 Select the line »Source« with »V« or »^« and press »●« to confirm.
Select the option »Cable« with »<«, »>«, »V« or »^« and press »●« to confirm.
- 4 Select »Digital Manual Tuning« with »V« or »^« and press »●« to confirm.
- The menu appears.
- 5 Enter the four-digit frequency with »1 ... 0« and press »●« to confirm.
- The search starts after confirming, the channels found are displayed in the »Results« menu.
- 6 Press »i« to finish the setting.

Searching for digital terrestrial TV channels automatically

- 1 Open the menu with »i«.
- 2 Select the line »SOURCE SETUP« with »V« or »^« and press »●« to confirm.
- The »SOURCE SETUP« menu appears.
- 3 Select the line »Source« with »V« or »^« and press »●« to confirm.
Select the option »Air« with »<«, »>«, »V« or »^« and press »●« to confirm.

Caution:

- The antenna power supply (line »Active Antenna Power«) may only be switched on if the antenna is an active indoor antenna with a signal amplifier and it is not already supplied with a voltage via a mains plug (or similar supply). Otherwise you may cause a short circuit and irreparably damage your antenna.
- 4 Select the »Active Antenna Power« with »V« or »^«. Switch on the antenna power supply for the antenna with »<« or »>« (»On«).
 - 5 Select the line »Automatic Channel Search« with »V« or »^« and press »●« to confirm.
- The menu appears.

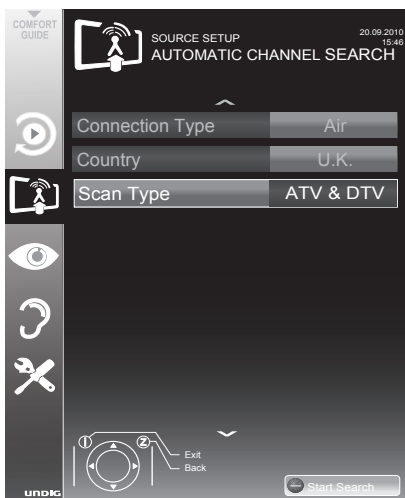

SPECIAL SETTINGS

- 6 Select the line »Scan Typ« with »▼« or »▲« and set the option »DTV« with »◀« or »▶«.
- 7 Start the scan with »■« (red).
 - All channel and favourites lists will be deleted and compiled anew.

Note:

- After starting the scan, a security query will appear. Press »■« (green) to confirm the option »Yes«.
- The »Reults« menu appears, and the scan for TV channels begins. Depending on the number of television channels received, this can easily take a few minutes.
- The scan is complete as soon as the »PROGRAM TABLE« appears.

Note:

- You can abort the search by pressing »i«.

- 8 Press »i« to end the setting.

Automatic service update

If this function is activated, possible changes of network operators are updated automatically.

The unit must be located in stand-by mode.

- 1 Open the menu with »i«.
- 2 Select the line »SOURCE SETUP« with »▼« or »▲« and press »●« to confirm.
- 3 Select the line »Automatic Service Update« with »▼« or »▲«.
- 4 Select the automatic update with »◀« or »▶« (»On«).
- 5 Press »i« to end setting.

Searching for digital terrestrial TV channels manually

- 1 Open the menu with »i«.
- 2 Select the line »SOURCE SETUP« with »▼« or »▲« and press »●« to confirm.
 - The »SOURCE SETUP« menu appears.
- 3 Select the line »Source« with »▼« or »▲« and press »●« to confirm.
Select the option »Air« with »◀«, »▶«, »▼« or »▲« and press »●« to confirm.

Caution:

- The antenna power supply (line »Active Antenna Power«) may only be switched on if the antenna is an active indoor antenna with a signal amplifier and it is not already supplied with a voltage via a mains plug (or similar supply). Otherwise you may cause a short circuit and irreparably damage your antenna.

- 4 Select the »Active Antenna Power« with »▼« or »▲«. Switch on the antenna power supply for the antenna with »◀« or »▶« (»On«).
- 5 Select »Digital Manual Tuning« with »▼« or »▲« and press »●« to confirm.
 - The menu appears.
- 6 Enter the channel number directly with »1 ... 0« and press »●« to confirm.
 - After the search is complete, the channels found are displayed in the »Results« menu.
- 7 Press »i« to finish the setting.

SPECIAL SETTINGS

Tuning analogue television channels

This setting is only necessary if you cannot receive any digital channels and you have not carried out an analogue search during initial setup. The television channels can be set directly or using the scan.

Setting all analogue television channels

Analogue channels are displayed in the channel list after the digital channels.

Note:

- Plug the rooftop antenna cable (for analogue television channels) into the »ANT IN« socket on the television.

- 1 Open the menu with »i«.
- 2 Select the line »SOURCE SETUP« with »▼« or »▲« and press »●« to confirm.
 - The »SOURCE SETUP« menu appears.
- 3 Select the line »Source« with »▼« or »▲« and press »●« to confirm.
Select the option »Air« or »Cable« with »◀«, »▶«, »▼« or »▲« and press »●« to confirm.
- 4 Select the line »Automatic Channel Search« with »▼« or »▲« and press »●« to confirm.

- 5 Select the line »Scan Typ« with »▼« or »▲« and set the option »ATV« with »◀« or »▶«.

- 6 Start the scan with »■« (red).

Note:

- After starting the scan, a security query will appear. Press »■« (green) to confirm the option »Yes«.
 - All channel and favourites lists for the analogue channels will be deleted and compiled anew.
 - The »Results« menu appears, and the scan for TV channels begins. Depending on the number of television channels received, this can easily take a few minutes.
 - The search is complete as soon as the »PROGRAM TABLE« appears.

Note:

- You can abort the search by pressing »i«.

- 7 Press »i« to end the setting.

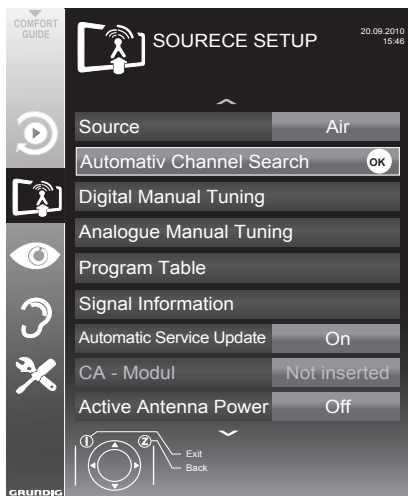

SPECIAL SETTINGS

Tuning the television channels by entering the channel numbers

- 1 Open the menu with »i«.
- 2 Select the line »SOURCE SETUP« with »▼« or »▲« and press »●« to confirm.
- The »SOURCE SETUP« menu appears.
- 3 Select the line »Analogue Manual Tuning« with »▼« or »▲« and press »●« to confirm.
- The menu appears.

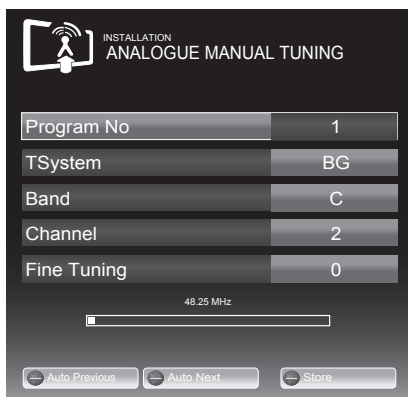

- 4 Select the line »Program No« by pressing »▼« or »▲« and use »◀« or »▶« to save the preset.
- 5 Select »Band« by pressing »▼« or »▲« and use »◀« or »▶« to choose between »S« (special channel) or »C« (normal channel).
- 6 Select the line »Channel« with »▼« or »▲« and enter the channel number with »◀« or »▶« step by step, or use »1...0« to enter it directly.

Notes:

- The current system is displayed in the »System« line. If the colour or sound is not functioning properly, select the line »System« with »▼« or »▲«. Use »◀« or »▶« to select the preferred setting.
- If fine tuning is necessary, select the line »Fine Tuning« with »▼« or »▲« and use »◀« or »▶« to make the setting.

- 7 Press »■« (blue) to save the setting.

Note:

- If you wish to remedy other television channels, repeat steps 4 to 8.

- 8 Press »i« to end the setting.

Changing stored analogue channels

If channels were stored with the automatic channel search while tuning the television channels, you can delete them. You can also store channels in a different preset, change or enter the name of a channel as well as skip channels.

Selecting a channel list

- 1 Open the menu with »i«.
- 2 Select the line »SOURCE SETUP« with »▼« or »▲« and press »●« to confirm.
- The »SOURCE SETUP« menu appears.
- 3 Select the line »Program Table« with »▼« or »▲« and press »●« to confirm.
- The »PROGRAMME TABLE« menu appears.

Note:

- Additional operations are explained in the following sections.

Deleting channels

- 1 In the »PROGRAMME TABLE« menu, select the television channel to be deleted with »▼«, »▲«, »◀« or »▶« and press »■« (red) to confirm.
- 2 Press »■« (yellow) to confirm the deletion process.

Note:

- »■« (blue) allows all television channels to be deleted.
- 3 Press »■« (green) to confirm the deletion process.

SPECIAL SETTINGS

Entering channel names (8 digit maximum)

- 1 In the »PROGRAMME TABLE« menu, select the television channel with »▼«, »▲«, »◀« or »▶« and press »■« (red) to confirm.
- 2 Open the input keyboard with »■« (green).

Note:

- If necessary, delete the current channel name. To do this, select the »◀x« button with »◀« or »▶« and delete repeatedly using »●«.
- 3 Select the required letters or numbers with »▼«, »▲«, »◀« or »▶« and confirm with »●«. Repeat the entry for further letters/numbers.

Note:

- Use the »ABC« button to switch to upper case letters and use the »?@123« button to switch to symbols and numbers.
- 4 Save the channel name by using »▼«, »▲«, »◀« or »▶« to select »Submit« and confirm with »●«.

Note:

- If you wish to enter other channel names, repeat steps 1 to 4.

Skipping television channels

You can highlight television channels to be skipped when you select with »▲« or »▼«. Selection is still possible using the number buttons.

- 1 In the »PROGRAMME TABLE« menu, switch over to the list view with »■« (yellow).
- 2 Select the preferred channel with »▼« or »▲«.
- 3 Select the column »Skip« with »◀« or »▶« and use »●« to mark the channel.
 - The channel is marked using »✓«.

Note:

- Channels can also be reactivated. Select the channel with »▼« or »▲«, then select the column »Skip« and reactivate the channel with »●«.

Creating lists of favourites

You can select your favourite channels and save them in up to four favourites lists (Fav 1 to Fav 4).

- 1 In the »PROGRAMME TABLE« menu, switch over to the list view with »■« (yellow).
- 2 Select the preferred channel with »▼« or »▲«.
- 3 Use »◀« or »▶« to "push" the channel into one of the favourites lists 1 to 4 and press »●« to confirm.
 - The position in the favourites list is marked with »✓«.
 - You can enter the same channel in more than one favourite list.
 - Each favourite list can store up to 255 channels.

Note:

- Channels can also be deleted from favourites lists. Select the channel to be deleted with »▼«, »▲«, »◀« or »▶« and delete it with »●«.

Exiting the settings

- 1 Press »i« to end the setting.

Displaying signal information

(for digital channels only)

- 1 Open the menu with »i«.
- 2 Select the line »SOURCE SETUP« with »V« or »^« and press »●« to confirm.
- 3 Select the line »Signal Information« with »V« or »^« and press »●« to confirm.
 - Information on the channel, network, modulation, symbol rate, quality and signal strength is displayed.

Notes:

- The signal information changes in accordance with the current input source.
 - The signal properties are displayed in the lower section of the menu. The further the bars for »Quality« and »Signal Strength« extend to the right, the better the reception signal.
 - The signal level not only depends on your receiver system, but also on the channel which is currently active. Remember this when aligning your antenna based upon the signal level display.
- 4 Press »i« to close the menu.

Pre-programming the remote control for other GRUNDIG devices

- »DVB« has been pre-programmed for operating a GRUNDIG digital receiver (remote control level 1).
- »DVD« has been pre-programmed for operating a GRUNDIG DVD player.
- »AMP« has been pre-programmed for operating a GRUNDIG AV receiver.
- The functions available depend on the model of the device you are using. Just try it out.

Changing the pre-programming of the remote control

- 1 Press and hold »M« and simultaneously enter the three numbers of the corresponding code:
 - »1«, »2«, »3« for a GRUNDIG DVD player.
 - »4«, »5«, »6« for a GRUNDIG DVD recorder.
 - »1«, »4«, »7« for a GRUNDIG digital receiver (remote control level 1).
 - »2«, »5«, »8« for a GRUNDIG digital receiver (remote control level 2).
 - »3«, »6«, »9« for a GRUNDIG digital receiver with a hard disk (PDR).

INFORMATION

GRUNDIG 32 VLE 8131 WF

Technical data

Operating voltage:

220-240 V, ~, 50-60 Hz

Power consumption:

On mode 58 W
Standby <0,50 W

Energy Efficiency class:

B

Maximum power consumption

Operational 110 W

Annual power consumption

85 kWh

Audio output:

2 x 20 W music power output
2 x 10 W Sine wave power

Rohs Limits: Pb (Lead)/Hg (Mercury)

Pb meets ROHS directive / 0 mg

Peak luminance ratio:

% 65

Digital reception ranges

Cable:

Overall band: 110 MHz - 862 MHz
Modulation: 16QAM, 32QAM, 64QAM,
128QAM and 256QAM
Symbol rate: 4.0 Msym/s to 7.0 Msym/s

Terrestrial:

VHF/UHF band, Bandwidth 7 MHz
and 8 MHz
COFDM modi: 2k and 8k
Constellation: 16QAM, 64QAM, QPSK

Analogue reception ranges:

C02 ... C80, special channels S01 ... S41

Preset channels:

TV/Radio 1000 (Cable - DVB-C) or
100 (Analogue)
1000 (Terrestrial - DVB-T) or
100 (Analogue)
9 AV, 2 USB

Screen (dm²):

28 dm²

Screen size:

80 cm/32 inch

Maximum resolution:

WUXGA, 1920 x 1080

Weight:

approx. 12,2 kg

Dimensions:

W H D 76,3 cm 53,5 cm 4,3 cm

Service information for retailers



Only operate the television with the power supply/power cord provided.

The product complies with the

following EU directives:

2006/95/EC directive on electrical equipment for use within certain voltage limits.

2004/108/EC directive on electromagnetic compatibility.

2009/125/EC directive on ecodesign requirements for energy-related products.

Power consumption values and classes are specified according to the regulations 2009/642 and 2010/1062 and the standards EN62087 and EN62301 as per European Union framework directives 2009/125/EC and 2010/30/EU

Environmental note



This product has been made from high-quality parts and materials which can be re-used and recycled.

Therefore, do not dispose of the product along with normal household waste at the end of its service life. Take it to a collection point for the recycling of electrical and electronic equipment. Dispose of the used device at a collection point for electrical and electronic equipment. The symbol on the product, in the operating manual or on the packaging indicates that recycling is possible.

Information on collection points is available from your local authorities.

Help protect the environment by recycling used products.

Technical changes and errors reserved.

INFORMATION

Troubleshooting

If the information provided below does not help, please consult an authorised GRUNDIG dealer. Please bear in mind that malfunctions can also be caused by external devices such as video recorders or satellite receivers.

Problem	Possible cause	Remedy
Screen lit (snow), but no station visible	Antenna cable	Is the antenna cable connected?
	No TV channel tuned	Start a channel scan
Insufficient contrast in picture	The picture settings are not correct	Adjust the brightness, contrast or colour setting
	Problem at station	Try another channel
Picture and/or sound distorted	Interference from other devices	Place the device in a different position
Ghosting, reflection	Channel setting	Automatic or manual tuning/fine tuning
	Antenna	Have antenna cable or system checked
No colour	Colour intensity too low	Turn up the colour
	Adjust TV standard (if setting option is available)	Select the correct colour standard
	Problem at station	Try a different channel
Picture but no sound	Volume is set to a minimum	Turn up or switch on the volume
Teletext impaired or absent	Problem at station	Try a different channel
	Television channel (no teletext) or antenna system	Try with a different TV channel, carry out fine tuning
	Station signal too weak	Check antenna
The remote control does not work	Obstacle between remote control and device.	Point remote control at television
	Battery problem	Check batteries and replace if necessary
	Operating mode undefined	Switch off the television at the mains switch for two minutes
Picture too dark in PC mode	Incorrect setting for picture resolution and picture frequency on the PC	Change settings on the PC (e.g. 1280 x 768 resolution, refresh rate 60 Hz)

Note:

- This is a Class A product. During operation the device could cause radio interference. In this case the user may have to remedy this. Please contact your specialist dealer.

Additional Information for units sold in the UK.

Units sold in the UK are suitable for operation from a 240V ac, 50Hz mains supply.

The range of multi-system receivers is built to work in most European countries. However, the mains plug and socket system for the UK differs from many European countries.

This appliance has been supplied with a fitted, non-removable, approved converter plug for use in the UK. This converter plug is fitted with a 5A rated fuse.

In case this appliance is supplied with a moulded 2-pin Euro plug only, which is unsuitable for UK operation, this must be cut off and immediately disposed of. An approved 13A, 3-pin UK plug should then be fitted by a qualified electrician.

Note:

■ The severed Euro plug must be destroyed to avoid a possible shock hazard should it be inserted into a socket elsewhere.

If a non-rewireable 3-pin plug or a rewireable 13A (BS1363) 3-pin plug is used, it must be fitted with a 5A ASTA or BSI approved BS1362 fuse. If any other type of plug is used it must be protected by a 5A fuse either in the plug, or at the distribution board. If this type of plug becomes defective, ensure that the fuse is removed before disposal, to eliminate potential shock hazard.

If it is necessary to change the fuse in the non-rewireable plug, the correct type and rating (5A ASTA or BSI approved BS1362) must be used and the fuse cover must be refitted. If the fuse cover is lost or damaged, the lead and plug must not be used until a replacement is obtained. Replacement fuse covers should be obtained from your dealer.

Important:

■ The wires in the mains lead are colour coded in accordance with the following code:

BLUE – NEUTRAL

BROWN – LIVE

As the colours of the wires in the mains lead of your appliance may not correspond with the coloured marking identifying terminals in your plug, proceed as follows:

Connect the BLUE coloured wire to plug terminal marked with the letter "N" or coloured black.

Connect the BROWN coloured wire to the plug terminal marked with the letter "L" or coloured red.

In no circumstance must any of the wires be connected to the terminal marked with the letter "E", earth symbol "V", coloured green, or green & yellow.