

KENWOOD

INSTRUCTION MANUAL



144 MHz FM TRANSCEIVER

TH-255A

Kenwood Corporation

© B62-1981-00 (K, M)
09 08 07 06 05 04 03 02 01 00

THANK YOU

We are grateful you decided to purchase this **Kenwood** FM transceiver. **Kenwood** always provides Amateur Radio products which surprise and excite serious hobbyists. This transceiver is no exception. **Kenwood** believes that this product will satisfy your requirements for both voice and data communications.

FEATURES

- Compact design
- Aluminum die-cast chassis
- High output power (up to 5 W operation)
- 100 memory channels or 50 channels with names
- Long operation period with a Ni-MH battery pack (optional)

WRITING CONVENTIONS FOLLOWED IN THIS MANUAL

The writing conventions described below have been followed to simplify instructions and avoid unnecessary repetition.

Instruction	Action
Press [KEY].	Momentarily press [KEY].
Press [KEY] (1s).	Press and hold [KEY] for 1 second or longer.
Press [F], [KEY].	Press the [F] key to enter Function mode, then press [KEY] to access its secondary function.
Press [KEY] + Power ON.	With the transceiver power OFF, press and hold [KEY] while turning the transceiver power ON.

NOTICES TO THE USER

- ◆ Government law prohibits the operation of unlicensed radio transmitters within the territories under government control.
- ◆ Illegal operation is punishable by fine and/or imprisonment.
- ◆ Refer service to qualified technicians only.

Safety: It is important that the operator is aware of, and understands, hazards common to the operation of any transceiver.

PRECAUTIONS

- Do not charge the transceiver and battery pack when they are wet.
- Ensure that there are no metallic items located between the transceiver and the battery pack.
- Do not use options not specified by **Kenwood**.
- If the die-cast chassis or other transceiver part is damaged, do not touch the damaged parts.
- If a headset or headphone is connected to the transceiver, reduce the transceiver volume. Pay attention to the volume level when turning the squelch off.
- Do not place the microphone cable around your neck while near machinery that may catch the cable.
- Do not place the transceiver on unstable surfaces.
- Ensure that the end of the antenna does not touch your eyes.
- When the transceiver is used for transmission for many hours, the radiator and chassis will become hot. Do not touch these locations when replacing the battery pack.
- Do not immerse the transceiver in water.
- Always switch the transceiver power off before installing optional accessories.

**WARNING**

Turn the transceiver power off in the following locations:

- In explosive atmospheres (flammable gas, dust particles, metallic powders, grain powders, etc.).
- While taking on fuel or while parked at gasoline service stations.
- Near explosives or blasting sites.
- In aircrafts. (Any use of the transceiver must follow the instructions and regulations provided by the airline crew.)
- Where restrictions or warnings are posted regarding the use of radio devices, including but not limited to medical facilities.
- Near persons using pacemakers.

**CAUTION**

- Do not disassemble or modify the transceiver for any reason.
- Do not place the transceiver on or near airbag equipment while the vehicle is running. When the airbag inflates, the transceiver may be ejected and strike the driver or passengers.
- Do not transmit while touching the antenna terminal or if any metallic parts are exposed from the antenna covering. Transmitting at such a time may result in a high-frequency burn.
- If an abnormal odor or smoke is detected coming from the transceiver, switch the transceiver power off immediately, remove the battery pack from the transceiver, and contact your **Kenwood** dealer.
- Use of the transceiver while you are driving may be against traffic laws. Please check and observe the vehicle regulations in your area.
- Do not expose the transceiver to extremely hot or cold conditions.
- Do not carry the battery pack (or battery case) with metal objects, as they may short the battery terminals.
- When operating the transceiver in areas where the air is dry, it is easy to build up an electric charge (static electricity). When using an earphone accessory in such conditions, it is possible for the transceiver to send an electric shock through the earphone and to your ear. We recommend you use only a speaker/microphone in these conditions, to avoid electric shocks.

One or more of the following statements may be applicable:

FCC WARNING

This equipment generates or uses radio frequency energy. Changes or modifications to this equipment may cause harmful interference unless the modifications are expressly approved in the instruction manual. The user could lose the authority to operate this equipment if an unauthorized change or modification is made.

INFORMATION TO THE DIGITAL DEVICE USER REQUIRED BY THE FCC

This equipment has been tested and found to comply with the limits for a Class B digital device, pursuant to Part 15 of the FCC Rules. These limits are designed to provide reasonable protection against harmful interference in a residential installation.

This equipment generates, uses and can generate radio frequency energy and, if not installed and used in accordance with the instructions, may cause harmful interference to radio communications. However, there is no guarantee that the interference will not occur in a particular installation. If this equipment does cause harmful interference to radio or television reception, which can be determined by turning the equipment off and on, the user is encouraged to try to correct the interference by one or more of the following measures:

- Reorient or relocate the receiving antenna.
- Increase the separation between the equipment and receiver.
- Connect the equipment to an outlet on a circuit different from that to which the receiver is connected.
- Consult the dealer for technical assistance.

FCC REGULATIONS REGARDING THE USE OF THE EMERGENCY CHANNEL

The communications must be for the purpose of soliciting or rendering assistance to a traveler, or for communicating in an emergency pertaining to the immediate safety of life or the immediate protection of property.

CONTENTS

PREPARATION	1
SUPPLIED ACCESSORIES	1
INSTALLING THE OPTIONAL PB-43N Ni-MH BATTERY PACK	2
INSTALLING ALKALINE BATTERIES	3
INSTALLING THE ANTENNA	4
INSTALLING THE BELT CLIP	4
GETTING ACQUAINTED	5
KEYS AND CONTROLS	5
DISPLAY	8
BASIC OPERATION	10
SWITCHING THE POWER ON/OFF	10
ADJUSTING THE VOLUME	10
VOLUME ADJUSTMENT OPERATION SELECTION	10
ADJUSTING THE SQUELCH LEVEL	11
SELECTING A FREQUENCY	12
DIRECT FREQUENCY ENTRY	13
TRANSMITTING	14
SELECTING AN OUTPUT POWER	14
MENU SETUP	15
WHAT IS A MENU?	15
MENU ACCESS	15
OPERATING THROUGH REPEATERS	18
REPEATER ACCESS	19
ACTIVATING THE TONE FUNCTION	20
SELECTING A TONE FREQUENCY	21
TONE FREQUENCY ID SCAN	22
AUTOMATIC REPEATER OFFSET (K TYPE ONLY)	23
REVERSE FUNCTION	24
AUTOMATIC SIMPLEX CHECKER (ASC)	24
MEMORY CHANNELS	26
NUMBER OF MEMORY CHANNELS	26
SIMPLEX & REPEATER OR ODD-SPLIT MEMORY CHANNEL?	27

STORING SIMPLEX FREQUENCIES OR STANDARD REPEATER FREQUENCIES ..	28
STORING ODD-SPLIT REPEATER FREQUENCIES	28
CONTINUOUSLY STORING IN SIMPLEX OR SPLIT CHANNELS	29
RECALLING A MEMORY CHANNEL	30
CLEARING A MEMORY CHANNEL	31
NAMING A MEMORY CHANNEL	32
MEMORY -TO- VFO TRANSFER.....	33
CALL CHANNEL	34
RECALLING THE CALL CHANNEL	34
REPROGRAMMING THE CALL CHANNEL	34
CHANNEL DISPLAY MODE	35
SCAN	36
SELECTING A SCAN RESUME METHOD	37
BAND SCAN.....	37
PROGRAM SCAN	38
MEMORY SCAN	39
CALL SCAN	40
PRIORITY SCAN.....	40
MEMORY CHANNEL LOCKOUT.....	42
SELECTIVE CALL	43
CONTINUOUS TONE CODED SQUELCH SYSTEM (CTCSS)	43
DIGITAL CODED SQUELCH (DCS)	46
DTMF FUNCTIONS	49
MANUAL DIALING	49
DTMF TX HOLD.....	50
AUTOMATIC DIALER	50
ADJUSTING THE DTMF TONE TRANSMISSION SPEED.....	52
ADJUSTING THE PAUSE DURATION	52
DTMF LOCK	53
AUXILIARY FUNCTIONS	54
APO (AUTO POWER OFF)	54
REMAINING BATTERY CAPACITY	54
BATTERY SAVER	55
BEAT SHIFT.....	56

BEEP FUNCTION	57
BUSY CHANNEL LOCKOUT	57
FREQUENCY STEP SIZE	58
BACK LIGHT	58
LOCK FUNCTION	59
SELECTOR UNLOCK	59
MICROPHONE KEY LOCK	60
MICROPHONE PF KEYS (OPTIONAL)	60
MONITOR	62
POWER ON MESSAGE	62
PROGRAMMABLE VFO	63
TIME-OUT TIMER	64
TX INHIBIT	64
EMERGENCY SIREN	65
MINIMUM/ MAXIMUM VOLUME	66
SPEAKER ATTENUATION	67
POWER ON PASSWORD	67
OPTIONAL ACCESSORIES	69
MAINTENANCE	70
GENERAL INFORMATION	70
SERVICE	70
CLEANING	71
MICROPROCESSOR RESET	71
OPERATION NOTICES	73
RECEIVING SIGNALS IN CITIES	73
TRANSMISSION	73
INTERNAL BEATS	73
TROUBLESHOOTING	74
SPECIFICATIONS	77

PREPARATION

SUPPLIED ACCESSORIES

After carefully unpacking the transceiver, identify the items listed in the table below. We recommend you keep the box and packings for the shipping.

Item	Part Number	Quantity
Antenna	T90-1018-XX	1
Belt clip	J29-0623-XX	1
Screw set	N99-2066-XX	1
Instruction manual	B62-1981-XX	1

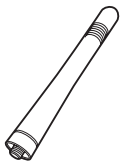

Antenna



Belt clip



Screw set

INSTALLING THE OPTIONAL PB-43N NI-MH BATTERY PACK

Note: The battery pack is not charged at the factory, you must charge the battery pack before using it with the transceiver.

- 1 Unlock (open) the safety catch located at the bottom of the battery pack.
- 2 Match the guides of the battery pack with the corresponding grooves on the upper rear of the transceiver, then firmly press the battery case to lock it in place.

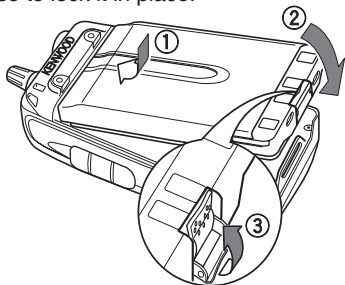

- 3 Flip the safety catch into place to prevent accidentally pressing the release latch and removing the battery pack.
- 4 To remove the battery pack, lift the safety catch, then press the release latch to unlock the battery pack. Lift the battery pack away from the transceiver.

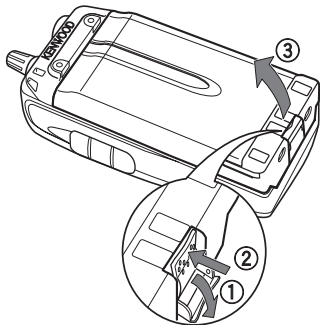

INSTALLING ALKALINE BATTERIES

- 1 To open the optional BT-14 battery case lid, insert your thumb or finger into the hole on the top of the battery case, then pull the cover up.

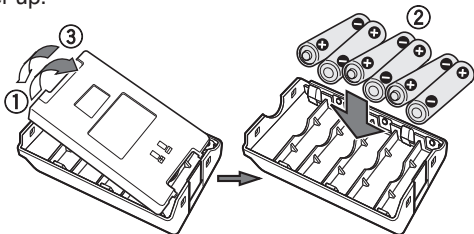

- 2 Insert (or remove) six AA (LR6) Alkaline batteries.
 - Be sure to match the battery polarities with those marked in the bottom of the battery case.
- 3 Align the two tabs at the bottom of battery case, then close the cover until the locking tabs on top click.
- 4 To install the battery case onto (or remove it from) the transceiver, follow steps 1 to 3 of "INSTALLING THE OPTIONAL PB-43N Ni-MH BATTERY PACK".

Note:

- ◆ Do not use Manganese batteries or Ni-Cd batteries in place of Alkaline batteries.
 - ◆ Always replace all batteries at the same time. Mixing old and new batteries or mixing types (such as Alkaline with zinc carbon) will reduce overall performance and could cause leakage or rupture.
 - ◆ Remove all batteries from the case when it is not expected to be in use for several months.
 - ◆ The voltage of new Alkaline batteries varies slightly, depending on the manufacturer. Thus, the high battery power indicator may not appear even though new Alkaline batteries are installed {page 54}.
 - ◆ To lift the battery pack safety catch, use a piece of hardened plastic or metal, such as a screwdriver, that is no more than 6 mm wide and 1 mm thick. It is imperative that you place the implement under only the lip of the safety catch so that you do not damage the release latch.
-

INSTALLING THE ANTENNA

Screw the antenna into the connector on the top of the transceiver by holding the antenna at its base and turning it clockwise until secure.

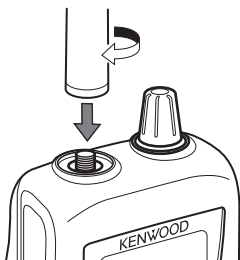

Note: The antenna is neither a handle, a key ring retainer, nor a speaker/ microphone attachment point. Using the antenna in these ways may damage the antenna and degrade your transceiver's performance.

INSTALLING THE BELT CLIP

If necessary, attach the belt clip using the two supplied 3 x 4 mm screws.

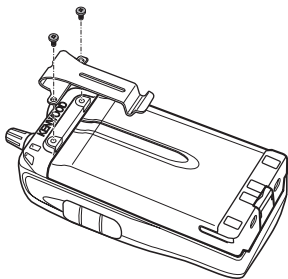

Note: If the belt clip is not installed, its mounting location may get hot during continuous transmission or when left sitting in a hot environment.

GETTING ACQUAINTED

KEYS AND CONTROLS

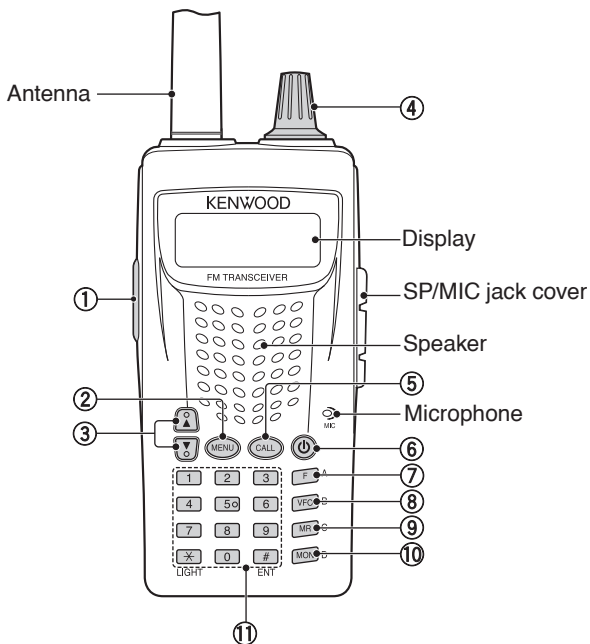

① **[PTT]**

Press and hold **[PTT]** to transmit.

Press **[F]**, **[PTT]** to toggle the transmit output power between High and Low {page 14}.

② **[MENU]**

Press **[MEMU]** to enter Menu mode {page 15}.

Press **[F]**, **[MEMU]** to turn the transceiver key lock function ON or OFF {page 59}

③ **[UP](▲)/ [DOWN](▼)**

Press **[UP]/ [DOWN]** to adjust the Volume Level {page 10}.

④ **Selector**

Rotate the Selector to select an operating frequency or Memory channel, change the scan direction, select a Menu, etc.

⑤ **[CALL]**

Press **[CALL]** to select the Call channel {page 34}.

Press **[CALL] (1s)** to start Call scan {page 40}.

Press **[F]**, **[CALL]** to store the current operating frequency to the Call channel {page 34}.

⑥ **[⏻]**

Press **[⏻]** (POWER) to turn the transceiver power ON and OFF.

⑦ **[F]**

Press **[F]** to enter MHz mode {page 12}.

⑧ **[VFO]**

Press **[VFO]** to enter VFO mode {page 12}.

Press **[VFO] (1s)** to start Band scan {page 37}.

Press **[F]**, **[VFO]** to copy the current Memory channel or Call channel to the VFO (memory shift) {page 33}.

⑨ **[MR]**

Press **[MR]** to enter Memory Channel mode {page 30}.

Press **[MR] (1s)** to start Memory scan {page 39}.

Press **[F]**, **[MR]** to store the current operating frequency in the Memory channel {page 28}.

⑩ [MON]

Press **[MON]** to turn the Monitor function ON and OFF {page 62}.

Press **[F]**, **[MON]** to enter Squelch Level Adjustment mode {page 11}.

⑪ Numeric Keypad

[1] Press **[F]**, **[1]** to select the Signaling (Tone, CTCSS and DCS) function {pages 20, 43, 46}.

[2] Press **[F]**, **[2]** to enter the Tone frequency setup mode {page 21}.

Press **[F]**, **[2]** (**1s**) to start Tone frequency ID scan {page 22}.

[3] Press **[F]**, **[3]** to change the Frequency step size {page 58}.

[4] Press **[F]**, **[4]** to enter the DCS code setup mode {page 46}.

Press **[F]**, **[4]** (**1s**) to start DCS code ID scan {page 47}.

[5] Press **[F]**, **[5]** to enter the CTCSS frequency setup mode {page 44}.

Press **[F]**, **[5]**(**1s**) to start CTCSS frequency ID scan {page 44}.

Press **[5]**(**1s**) to turn the Speaker Attenuation function ON and OFF {page 67}.

[6] Press **[F]**, **[6]** to turn the Priority Scan ON or OFF {page 41}.

[7] Press **[F]**, **[7]** to turn the Reverse function ON or OFF {page 24}.

Press **[7]** (**1s**) to turn the ASC function ON or OFF {page 24}.

[8] Press **[F]**, **[8]** to select an Offset direction {page 19}.

[9] Press **[F]**, **[9]** to turn Memory Channel Lockout ON or OFF {page 42}.

[0] Press **[0]** (**1.5s**) to turn the Emergency siren ON or OFF {page 65}.

[*] Press **[*]** to illuminate the display {page 58}.

Press **[*]** (**1s**) to keep the light ON continuously. {page 58}.



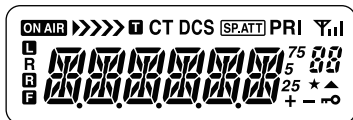

[#] Press **[#]** to enter the Direct frequency entry mode {page 13}.

Press **[F]**, **[#]** to enter the Volume Adjustment Operation Selection mode {page 10}.

DISPLAY



Indicator	Description
ON AIR	Appears while transmitting {page 14}.
▶▶▶▶▶	Remaining battery capacity indicator (when you transmit in low power) {page 54}.
T	Appears when the Tone function is ON {page 20}.
CT	Appears when the CTCSS function is ON {page 43}.
DCS	Appears when the DCS function is ON {page 46}.
SP.ATT	Appears when the Speaker Attenuation function is ON {page 67}.
PRI	Appears when a Priority Scan function is ON {page 40}.
Y,II	Displays the strength of received signals. An antenna and all 3 strength bars represents strong signals while the antenna by itself (no strength bars) represents weak signals.
00	Displays the Memory channel and Menu number.
75.500 25	Displays the operating frequency, Memory channel name, and Menu.
▲	Appears when the selected channel is registered while in Memory Input mode.
★	Appears when the Memory Channel Lockout function is ON {page 42}.

Indicator	Description
	Appears when the Key Lock function is ON {page 59}.
+	Appears when the Offset direction is set to plus {page 19}.
-	Appears when the Offset direction is set to minus {page 19}.
	Appears while using Low output power {page 14}.
R	Appears when the Reverse function is ON {page 24}.
	Appears when the ASC function is ON. Blinks when the ASC function is performing an OK check {page 24}.
	Appears when the [F] key is pressed.

Note: While the Battery Saver is operating {page 55}, the “” indicator may flash when receiving a CTCSS/DCS signal which does not match the CTCSS/DCS tone/code set up in your transceiver.

BASIC OPERATION

SWITCHING THE POWER ON/OFF

- 1 Press **[P]** (POWER) to switch the transceiver ON.
 - The power on message momentarily appears on the display.
 - If the transceiver power on password has been activated {page 67}, you must first enter your password before you can operate the transceiver.
- 2 To switch the transceiver OFF, press **[P]** (POWER) again.

ADJUSTING THE VOLUME

Press **[UP]** to increase the audio output level and press **[DOWN]** to decrease the output level.

- If you are not receiving a signal, press and hold **[MON]** to unmute the speaker, then adjust the volume control to a comfortable audio output level.

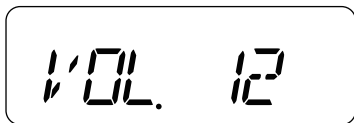

VOLUME ADJUSTMENT OPERATION SELECTION

With the setting described below, you can adjust the volume using either the **[UP]**/ **[DOWN]** keys or by operating the **Selector**.

- 1 Press **[F]**, **[#]**.
 - The selected display appears.

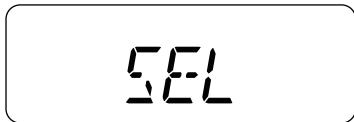



UP/DN

- 2 Press **[F]**, **[#]** to toggle the setting between “SEL” and “UP/DN”.

SEL: Adjust the volume using the **Selector**. To change the channel number or frequency, use **[UP]/ [DOWN]** keys.

UP/DN: Adjust the volume using **[UP]/ [DOWN]** keys. To change the channel number or frequency, use the **Selector**.

ADJUSTING THE SQUELCH LEVEL

The purpose of Squelch is to mute the speaker when no signals are present. With the squelch level correctly set, you will hear sound only while actually receiving signals. The higher the selected squelch level, the stronger the signals must be to receive. The appropriate squelch level depends on the ambient RF noise conditions.

- 1 Press **[F]**, **[MON]**.

- The current squelch level appears.



SQL. 2

- 2 Rotate the **Selector** (or press **[UP]/ [DOWN]**) to adjust the level.
 - Select the level at which the background noise is just eliminated when no signal is present.
 - The higher the level, the stronger the signals must be to receive.
 - 6 different levels can be set. 0: Minimum ~ 5: Maximum; 2 is the default value.
- 3 Press any key other than **[MON]**, **[UP]/ [DOWN]** or **[*]** to store the new setting and exit the squelch adjustment.

SELECTING A FREQUENCY

■ VFO Mode

This is the basic mode for changing the operating frequency. Rotate the **Selector** clockwise (or press **[UP]**) to increase the frequency and counterclockwise (or press **[DOWN]**) to decrease the frequency.

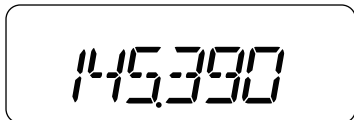

■ MHz Mode

If the desired operating frequency is far away from the current frequency, it is quicker to use the MHz Tuning Mode.

To adjust the MHz digit:

- 1 Press **[F]**.
 - The MHz digit blinks.



- 2 Rotate the **Selector** (or press **[UP]**/ **[DOWN]**) to select the desired MHz value.
- 3 After selecting the desired MHz value, press **[F]** or **[0]** to exit the MHz Tuning Mode and return to normal VFO Mode.
- 4 Continue adjusting the frequency as necessary, using the **Selector** (or press **[UP]**/ **[DOWN]**) keys.

DIRECT FREQUENCY ENTRY

In addition to rotating the **Selector** (or pressing **[UP]**/**[DOWN]**), there is another way to select the frequency. When the desired frequency is far away from the current frequency, you can directly enter a frequency using the numeric keypad.

- 1 Press **[VFO]**.
 - You must be in the VFO Mode to make the direct frequency entry.
- 2 Press **[#]**.

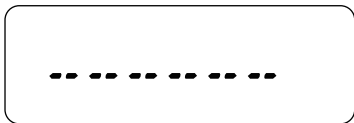

- 3 Press the numeric keys (**[0]** to **[9]**) to enter your desired frequency. **[*]** allows you to complete the MHz digits entry.
 - Pressing **[#]** fills all remaining digits (the digits you did not enter) with 0 and completes the entry. For example, to select 145.000 MHz, press **[1]**, **[4]**, and **[5]**, then press **[#]** to complete the entry.
 - If you want to revise the MHz digits only, leaving the kHz digits as they are, press **[VFO]** in place of **[#]**.

Note:

- ◆ If the entered frequency does not match the current frequency step size, the frequency is automatically rounded down to the next available frequency.
 - ◆ When the desired frequency cannot be entered exactly, confirm the frequency step size {page 58}.
 - ◆ If you rotate the **Selector** (or press **[UP]**/**[DOWN]**) while entering the frequency, the transceiver clears the entry.
-

TRANSMITTING

- 1 To transmit, hold the transceiver approximately 5 cm (2 inches) from your mouth, then press and hold **[PTT]** and speak into the microphone in your normal tone of voice.
 - The “**ON AIR**” icon appears.

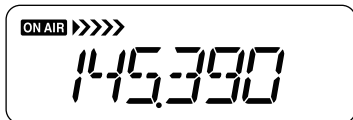

- If you press **[PTT]** while you are outside of the transmission coverage, a high pitched error beep sounds.
- 2 When you finish speaking, release **[PTT]**.

Note: If you continuously transmit for longer than the time specified in Menu No. 12 (default is 10 minutes) {page 64}, the internal timeout timer generates a warning beep and the transceiver stops transmitting. In this case, release **[PTT]** and let the transceiver cool down for a while, then press **[PTT]** again to resume transmission.

SELECTING AN OUTPUT POWER

Selecting a lower transmission power is the best way to reduce battery consumption, if communication is still reliable.

Press **[F]**, **[PTT]** to toggle between high and low (approx. 0.5 W).

- The “**L**” icon appears when the lower transmission power.
- “**▶▶▶▶▶**” shows the remaining battery capacity when you transmit in low power {page 54}.

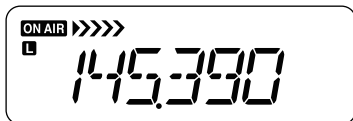

MENU SETUP

WHAT IS A MENU?

Many functions on this transceiver are selected or configured via a software-controlled Menu rather than through the physical controls of the transceiver. Once you become familiar with the Menu system, you will appreciate its versatility. You can customize the various timings, settings, and programming functions on this transceiver to meet your needs without using many controls and switches.

MENU ACCESS

1 Press [MENU].

- A brief explanation of the Menu, and the setting and Menu No. appear on the display.

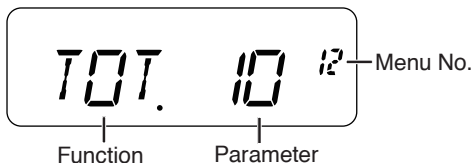

2 Rotate the **Selector** (or press [UP]/ [DOWN]) to select your desired Menu.

- As you change the Menu No., a brief explanation of each Menu appears along with its current parameter.

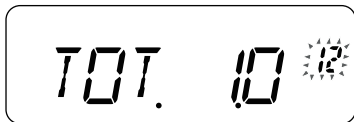

3 Press [MENU] to configure the parameter of the currently selected Menu No.

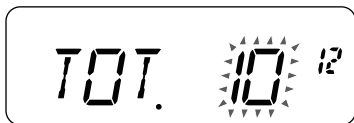

- 4 Rotate the **Selector** (or press **[UP]/ [DOWN]**) to select your desired parameter.

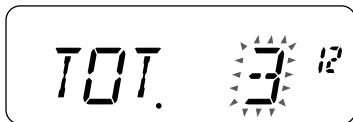

- 5 Press **[MENU]** to store the new setting.
- 6 Press any key other than **[MON]**, **[UP]/ [DOWN]** or **[*]** to exit Menu mode.

Menu Function List

Menu No.	Display	Description	Setting Values	Default Setting	Ref. Page
1	P.VFO	Programmable VFO	136 ~ 173 MHz	—	63
2	OFFSET	Repeater Offset Frequency	0.000 ~ 29.950 MHz	0.600	20
3	SCAN	Scan resume method	TO/ CO/ SE	TO	37
4	M.CH	Memory channel capacity	50/ 100	50	26
5	M.NAME	Memory name	6 characters	—	32
6	MDF	Memory name/ Frequency display	MN/ FRQ	MN	33
7	SAV	Battery saver	OFF/ 0.2/ 0.4/ 0.6/ 0.8/ 1.0/ 2.0/ 3.0/ 4.0/ 5.0	1.0	55
8	APO	Automatic Power-OFF	OFF/ 30/ 60/ 90/ 120/ 180 min.	30	54
9	VOLUME	Minimum volume/ Maximum volume	0 ~ 31	Mini: 0 Max: 31	66
10	PASSWD	Power On Password	6 characters	—	67

Menu No.	Display	Description	Setting Values	Default Setting	Ref. Page
11	EMG	Emergency siren	OFF/ VOL/ MED/ MAX	OFF	65
12	TOT	Time-out Timer	3/ 5/ 10 min	10	64
13	BCL	Busy channel lockout	ON/ OFF	OFF	57
14	TXI	TX inhibit	ON/ OFF	OFF	64
15	P.ON. MSG	Power On message	6 characters	–	62
16	BP	Beep	ON/ OFF	ON	57
17	BS	Beat Shift	ON/ OFF	OFF	56
18	SEL	Selector unlock	ON/ OFF	OFF	59
19	DTMF. MR	DTMF memory (Automatic dialer)	Up to 16 digits	–	50
20	SPD	DTMF TX speed	FA/ SL	FA	52
21	DT.H	DTMF TX hold	ON/ OFF	OFF	50
22	PA	DTMF pause time	100/ 250/ 500/ 750/ 1000/ 1500 / 2000 ms	500	52
23	DT.L	DTMF key Lock	ON/ OFF	OFF	53
24	M.PF	Microphone PF key	ON/ OFF	OFF	60
25	ARO	Automatic Repeater Offset (K type only)	ON/ OFF	ON	23

OPERATING THROUGH REPEATERS

Repeaters are often installed and maintained by radio clubs, sometimes with the cooperation of local businesses involved in the communications industry. Compared to simplex communication, you can usually transmit over much greater distances by using a repeater. Repeaters are typically located on mountain tops or other elevated locations. They generally operate at higher ERP (Effective Radiated Power) than a typical station. This combination of elevation and high ERP allows communications over considerable distances.

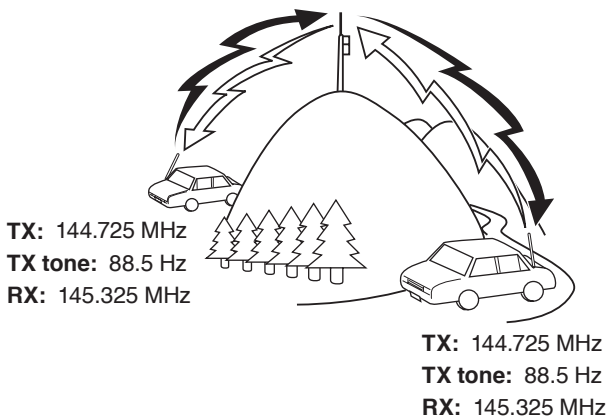

REPEATER ACCESS

Most repeaters use a receive and transmit frequency pair with a standard or non-standard offset (odd-split). In addition, some repeaters must receive a tone from the transceiver in order to gain access to the repeater. For details, consult your local repeater reference.

■ Selecting an Offset Direction

The offset direction allows your transmit frequency to be higher (+) or lower (-) than the receive frequency.

Press **[F]**, **[8]** to select an offset direction.

- Continually press **[F]**, **[8]** to toggle the functions as follows: “+” >> “-” >> OFF.
- The “+” or “-” icon appears, indicating which offset direction is selected.

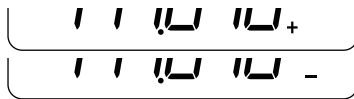

If the offset transmission frequency falls outside the allowable range, transmission is inhibited. In this case, adjust the reception frequency so that the transmission frequency is within the band limits.

Note: While using an odd-split memory channel or transmitting, you cannot change the offset direction.

■ Selecting an Offset Frequency

To access a repeater which requires an odd-split frequency pair, change the offset frequency from the default which is used by most repeaters.

- 1 Enter Menu mode and access Menu No. 2 (OFFSET).
- 2 Press **[MENU]**, then rotate the **Selector** (or press **[UP]/[DOWN]**) to select the appropriate offset frequency value.
 - The selectable range is from 0.000 MHz to 29.950 MHz, in steps of 50 kHz.



- 3 Press **[MENU]** to store the setting.
- 4 Press any key other than **[MON]**, **[UP]/[DOWN]** or **[*]** to exit Menu mode.

Note: After changing the offset frequency, the new offset frequency will also be used by Automatic Repeater Offset (K type only).

ACTIVATING THE TONE FUNCTION

Press **[F]**, **[1]** to turn the Tone function ON.

- Continually press **[F]**, **[1]** to toggle the functions as follows: Tone ON >> CTCSS ON >> DCS ON >> OFF.
- The “**T**” icon appears when the Tone function is ON.

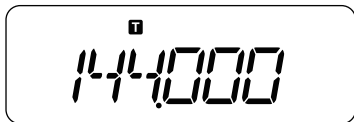

SELECTING A TONE FREQUENCY

To select the tone frequency required to access your desired repeater:

- 1 Press **[F]**, **[2]**.
 - The current tone frequency appears on the display. The default frequency is 88.5 Hz.



- 2 Rotate the **Selector** (or press **[UP]**/**[DOWN]**) to select your desired frequency.
- 3 Press any key other than **[MON]**, **[UP]**/**[DOWN]** or **[*]** to exit the tone frequency selection.

Note: If you have set up a Memory channel with a tone setting, simply recall the Memory channel instead of setting up the tone frequency every time.

Available Tone Frequencies

Tone Frequency (Hz)						
67.0	82.5	100.0	123.0	151.4	186.2	225.7
69.3	85.4	103.5	127.3	156.7	192.8	229.1
71.9	88.5	107.2	131.8	162.2	203.5	233.6
74.4	91.5	110.9	136.5	167.9	206.5	241.8
77.0	94.8	114.8	141.3	173.8	210.7	250.3
79.7	97.4	118.8	146.2	179.9	218.1	254.1

TONE FREQUENCY ID SCAN

This function scans through all tone frequencies to identify the incoming tone frequency on a received signal. You can use this function to find which tone frequency is required by your local repeater.

- 1 Press **[F]**, **[2]** (**1s**) to start the Tone Frequency ID scan.

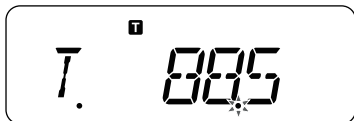

- When the transceiver receives a signal, scan starts. The decimal point blinks during scan.
- While the transceiver is receiving a signal during Tone Freq. ID Scan, the signal is emitted from the speaker.
- To reverse the scan direction, rotate the **Selector** (or press **[UP]/[DOWN]**).
- When the tone frequency is identified, a beep sounds and the identified frequency blinks.



- 2 Press **[MENU]** to program the identified frequency in place of the current tone frequency.
 - Press any key other than **[MON]**, **[UP]/[DOWN]** or **[*]** to exit the Scan function.

Note: Some repeaters do not re-transmit the access tone in the downlink signal. In this case, check the other station's uplink signal to detect the repeater access tone.

AUTOMATIC REPEATER OFFSET (K TYPE ONLY)

This function automatically selects an offset direction, according to the frequency on the 2 m band. The transceiver is programmed for offset directions as shown below. To obtain an up-to-date band plan for repeater offset direction, contact your national Amateur Radio association.

- 1 Enter Menu mode and access Menu No. 25 (ARO).
- 2 Press **[MENU]**, then rotate the **Selector** (or press **[UP]/ [DOWN]**) to select "ON".



- 3 Press **[MENU]** to store the setting.
 - You will be transmitting on an offset frequency value determined from your offset setting value {page 20} and an offset direction depending on your selected frequency. Refer to the settings below for offset directions:
- 4 Press any key other than **[MON]**, **[UP]/ [DOWN]** or **[*]** to exit Menu mode.

Under 145.100 MHz: No offset (Simplex operation)
145.100 ~ 145.499 MHz: Minus (-) offset
145.500 ~ 145.999 MHz: No offset (Simplex operation)
146.000 ~ 146.399 MHz: Plus (+) offset
146.400 ~ 146.599 MHz: No offset (Simplex operation)
146.600 ~ 146.999 MHz: Minus (-) offset
147.000 ~ 147.399 MHz: Plus (+) offset
147.400 ~ 147.599 MHz: No offset (Simplex operation)
147.600 ~ 147.999 MHz: Minus (-) offset
148.000 MHz and higher: No offset (Simplex operation)

REVERSE FUNCTION

After setting a separate receive and transmit frequency, you can exchange these frequencies using the Reverse function. This allows you to manually check the strength of signals you receive directly from other stations, while using a repeater. If the station's signal is strong, move to a simplex frequency to continue the contact and free up the repeater.

Press **[F]**, **[7]** to turn the Reverse function ON or OFF.

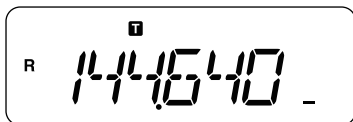

- When the Reverse function is ON, the “**R**” icon will appear on the display.

Note:

- ◆ If the transmit frequency is outside the allowable transmit frequency range when using Reverse, pressing **[PTT]** will cause an error tone to sound and transmission will be inhibited.
- ◆ If the receive frequency is outside the receive frequency range when using Reverse, an error tone will sound and Reverse will not operate.
- ◆ The ARO (Automatic Repeater Offset) will not function when Reverse is ON.
- ◆ You cannot switch Reverse ON or OFF while transmitting.

AUTOMATIC SIMPLEX CHECKER (ASC)

While using a repeater, ASC periodically monitors the strength of signals you receive directly from the other stations.

Press **[7]** (**1s**) to turn the ASC function ON or OFF.

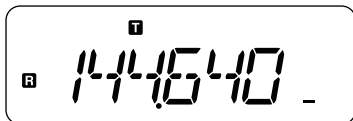

- When the ASC is ON, the “**R**” icon will appear on the display.

- While direct contact is possible, without the use of a repeater, the “**R**” icon will blink.

Note:

- ◆ Pressing **[PTT]** will cause the icon to stop flashing.
 - ◆ ASC does not function if you are using simplex operation.
 - ◆ ASC does not function while scanning.
 - ◆ Activating ASC while using Reverse will switch the Reverse function OFF.
 - ◆ If you recall a Memory channel or the Call channel, and those channels are set up with the Reverse function switched ON, the ASC will switch OFF.
 - ◆ ASC causes received signals to be momentarily intermitted every 3 seconds.
-

MEMORY CHANNELS

In memory channels, you can store frequencies and related data that you frequently use so that you do not need to reprogram that data every time. You can quickly recall a programmed channel through simple operation. A total of 100 memory channels (50 when using the Memory Name function) are available for storing frequencies, modes and other operating conditions.

NUMBER OF MEMORY CHANNELS

The transceiver must be configured to either 100 memory channels without using the Memory Name function or 50 memory channels with the Memory Name function (default).

To change the memory channel capacity:

- 1 Enter Menu mode and access Menu No. 4 (M.CH).
- 2 Press **[MENU]**, then rotate the **Selector** (or press **[UP]/ [DOWN]**) to select "50" or "100".

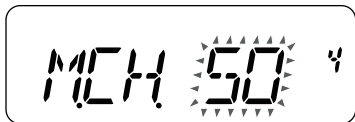

- 3 Press **[MENU]**.
 - "SURE ?" appears.



- 4 Press **[MENU]** to accept.
- 5 Press any key other than **[MON]**, **[UP]/ [DOWN]** or **[*]** to exit Menu mode.

Note:

- ◆ If you change the memory channel capacity from 100 channels to 50 channels after having stored data in channels 50 to 99, all memory channel data in channels 50 to 99 will be erased.

- ◆ If you change the memory channel capacity from 50 channels to 100 channels after storing Memory names in those channels, all Memory name data will be erased.

SIMPLEX & REPEATER OR ODD-SPLIT MEMORY CHANNEL?

You can use each memory channel as a simplex & repeater channel or as an odd-split channel. Store only one frequency to use as a simplex & repeater channel or two separate frequencies to use as an odd-split channel. Select either application for each channel depending on the operations you have in mind.

Simplex & repeater channels allow:

- Simplex frequency operation
- Repeater operation with a standard offset (if an offset direction is stored)

Odd-split channels allow:

- Repeater operation with a non-standard offset.

The data listed below can be stored in each Memory channel:

Parameter	Simplex & Repeater	Odd-split
Receive frequency	Yes	Yes
Transmit frequency		Yes
Tone ON	Yes	Yes
Tone frequency	Yes	Yes
CTCSS ON	Yes	Yes
CTCSS frequency	Yes	Yes
DCS ON	Yes	Yes
DCS code	Yes	Yes
Offset direction	Yes	No
Offset frequency	Yes	No
Reverse ON	Yes	Yes
Frequency step size	Yes	Yes
Beat Shift	Yes	Yes
Memory channel lockout	Yes	Yes
Memory channel name	Yes	Yes

STORING SIMPLEX FREQUENCIES OR STANDARD REPEATER FREQUENCIES

- 1 Press **[VFO]**, then rotate the **Selector** (or press **[UP]/ [DOWN]**) to select your desired frequency.
 - You can also directly enter a desired frequency using the keypad.

- 2 If storing a standard repeater frequency, select the following data:

- Offset direction
- Tone function, if necessary
- CTCSS/ DCS function, if necessary

If storing a simplex frequency, you may select other related data (CTCSS or DCS settings, etc.).

- 3 Press **[F]**, **[MR]**.
 - A memory channel number appears and blinks.
 - The “▲” icon appears when the channel contains data.
 - Memory channel number L0/U0 ~ L2/U2 {page 38} and Pr (Priority Channel) {page 40} are reserved for other functions.
- 4 Rotate the **Selector** (or press **[UP]/ [DOWN]**) to select the memory channel in which you want to store the data.
- 5 Press **[MR]** to store the data to the channel.

STORING ODD-SPLIT REPEATER FREQUENCIES

Some repeaters use a pair of reception and transmission frequencies with a non-standard offset. If you store two separate frequencies in a memory channel, you can operate on those repeaters without programming the offset frequency and direction.

- 1 Store the desired reception frequency and related data by following the procedure given for simplex or standard repeater frequencies.
- 2 Press **[VFO]**, then rotate the **Selector** (or press **[UP]/ [DOWN]**) to select the desired transmission frequency.
- 3 Press **[F]**, **[MR]**, then rotate the **Selector** (or press **[UP]/ [DOWN]**) to select the memory channel you programmed in step 1.

4 Press **[PTT]** + **[MR]**.

- The transmission frequency is stored in the memory channel.

Note: When you recall an odd-split memory channel, “+” and “-” appear on the display. To confirm the transmission frequency, press **[F]**, **[7]** (Reverse function).

CONTINUOUSLY STORING IN SIMPLEX OR SPLIT CHANNELS

Using the following procedure will be easier to sequentially store frequencies and related data in more than one simplex or split memory channel.

- 1 Press **[PTT]** + **[MON]** + **Power ON** to enter Memory Storage mode.
- 2 Press **[*]**, then rotate the **Selector** (or press **[UP]**/**[DOWN]**) to select the desired frequency and select related data as required (Tone, CTCSS, DTSS, etc.).
 - Pressing **[*]** toggles frequency select (the MHz dot blinks) or channel select (the channel number blinks).

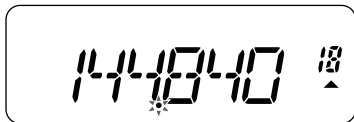
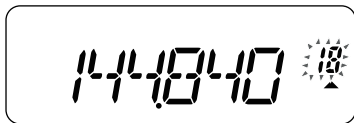

- 3 Press **[*]** again, then rotate the **Selector** (or press **[UP]**/**[DOWN]**) to select the desired memory channel.
- 4 Press **[MR]**.
 - The selected frequency and related data are stored in the memory channel, and the memory channel number is incremented.
- 5 Turn the transceiver power OFF, then ON to exit Memory Storage mode.

To also store a transmit frequency, proceed to step 6; otherwise proceed to step 10.

- 6 Press [**✖**], then rotate the **Selector** (or press [**UP**]/ [**DOWN**]) to select the desired transmit frequency.
 - The frequency selected in step 3 will be used as a receive frequency.
- 7 Press [**✖**], then rotate the **Selector** (or press [**UP**]/ [**DOWN**]) to select the memory channel that you selected in step 4.
- 8 Press [**F**].
- 9 Press [**PTT**] + [**MR**].
 - The selected transmit frequency is stored in the memory channel, and the memory channel number is incremented.
- 10 Repeat steps 3 to 5 (simplex) or 3 to 9 (split) to sequentially store in memory channels.
 - Turn the transceiver power OFF, then ON to exit Continuous Memory Storage mode.

Note:

- ◆ If you use Direct Frequency Entry {page 13} to select a frequency in step 2, you need not press [**✖**].
 - ◆ You cannot start Storage mode when in Channel Display mode.
 - ◆ You cannot start Menu mode when in Memory Storage mode.
-

RECALLING A MEMORY CHANNEL

■ Using the Selector (or [**UP**]/ [**DOWN**] keys)

- 1 Press [**MR**] to enter Memory Recall Mode. The memory channel last used is recalled.
- 2 Rotate the **Selector** (or press [**UP**]/ [**DOWN**]) to select your desired memory channel.
 - You cannot recall an empty memory channel.
 - To restore VFO Mode, press [**VFO**].

■ Using a Numeric Keypad

You can also recall a memory channel by entering a desired memory channel number with the keypad.

- 1 Press **[MR]** to enter Memory Recall Mode.
- 2 Press **[#]**, then enter the channel number using 2 digits.
 - For example, to recall channel 49, press **[#]**, **[4]**, **[9]**.
 - You can also enter a memory channel number that is less than 10 by pressing **[#]** after entering the channel number. For example, to recall memory channel 9, press **[#]**, **[9]**, **[#]**. You can also press **[#]**, **[0]**, **[9]**.

Note:

- ◆ You cannot recall an empty memory channel. An error beep sounds.
 - ◆ You cannot recall the Program Scan memory channels (L0/U0 ~ L2/U2), Priority Channel (Pr) using the numeric keypad.
 - ◆ When you recall an odd-split memory channel, “+” and “-” appear on the display. Press **[F]**, **[7]** (Reverse function) {page 24} to display the transmission frequency.
 - ◆ After recalling a memory channel, you may modify data such as Tone or CTCSS. However, these settings are cleared once you select another channel or the VFO Mode. To permanently store the data, overwrite the channel contents {page 28}.
-

CLEARING A MEMORY CHANNEL

To clear the data from an individual memory channel:

- 1 Recall the memory channel you want to clear.
- 2 Press and hold **[P]** (POWER) to switch the transceiver OFF.
- 3 Press **[MR]** + **Power ON**.
 - A confirmation message appears.

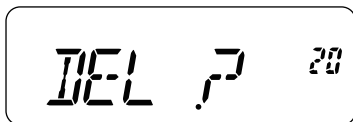

- 4 Press **[MR]** to clear the channel data.
 - The contents of the memory channel are cleared.
 - To exit clearing the memory channel, press any key other than **[*]** or **[MR]**.

Note:

- ◆ Call Channel data cannot be cleared.
 - ◆ You can also clear the Priority Channel, and L0/U0 ~ L2/U2 channels.
 - ◆ While the transceiver is in Channel Display Mode or Lock function is activated, you cannot clear the channel data.
-

NAMING A MEMORY CHANNEL

You can name memory channels using up to 6 alphanumeric characters. When you recall a named memory channel, its name appears on the display in place of the stored frequency. Names can be call signs, repeater names, cities, names of people, etc. In order to use the Memory Name function, the memory channel capacity must be set to 50 channels. To change the memory channel capacity from 100 to 50, access Menu No. 4 (M.CH).

- 1 Press **[MR]**, then rotate the **Selector** (or press **[UP]/ [DOWN]**) to select your desired memory channel.
- 2 Enter Menu mode and access Menu No. 5 (M.NAME).
- 3 Press **[MENU]**.
 - A blinking cursor appears.

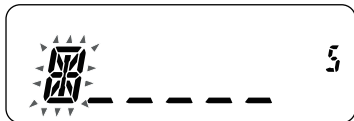

- 4 Rotate the **Selector** (or press **[UP]/ [DOWN]**) to select a desired alphanumeric character.
 - You can enter the following alphanumeric characters:
0 ~ 9, A ~ Z, -(hyphen), / (slash), and a space.
 - Press **[CALL]** to delete the character at the current cursor position.
- 5 Press **[MENU]**.
 - The cursor moves to the next digit.
- 6 Repeat steps 4 and 5 to enter up to 6 digits.
 - To complete the entry, press **[MENU]** without selecting a character.

- After storing a Memory name, the Memory name appears in place of the operating frequency. However, you can still display the operating frequency, if desired. To display the frequency rather than Memory name, access Menu No. 6 (MDF) and select “FRQ”. This menu toggles the display mode between the Memory name (“MN”) and frequency display (“FRQ”).



- 7 Press any key other than [MON], [UP]/ [DOWN] or [*] to exit Menu mode.

Note:

- ◆ You cannot name the Call Channel {page 34}.
 - ◆ You cannot assign a Memory name to a channel that does not contain data.
 - ◆ You can overwrite stored names by repeating steps 2 to 6.
 - ◆ The stored name is erased when you clear the Memory channel data.
-

MEMORY -TO- VFO TRANSFER

Transferring the contents of a Memory channel or the Call channel to the VFO can be useful if you want to search for other stations or a clear frequency, near the selected Memory channel or Call channel frequency.

- 1 Press [MR] or [CALL] to enter Memory Recall mode or select the Call channel.
- 2 Rotate the **Selector** (or press [UP]/ [DOWN]) to select your desired channel. (This step is not necessary when selecting the Call channel.)
- 3 Press [F], [VFO].
 - The entire contents of the Memory channel or Call channel are copied to the VFO, and VFO mode is selected after the transfer is complete.

- When copying a transmit frequency from an odd-split Memory or Call channel, you must first turn the Reverse function ON before pressing [F], [VFO].

CALL CHANNEL

The Call Channel can be recalled instantly no matter what frequency the transceiver is operating on. For instance, you may use the Call Channel as an emergency channel within your group. In this case, Call Scan {page 40} will be useful.

The default Call Channel frequency is 144.000 MHz.

Note: Unlike memory channels 0 to 99, the Call Channel cannot be cleared.

RECALLING THE CALL CHANNEL

Press [CALL] to recall the Call Channel.

- The Call Channel frequency and “C” appear.
- To return to the previous frequency, press [CALL] again.

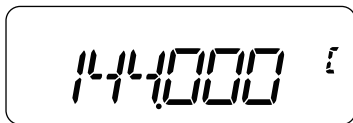

REPROGRAMMING THE CALL CHANNEL

- 1 Select your desired frequency and related data (Tone, CTCSS, DCS, or offset direction, etc.).
 - When you program the Call Channel as an odd-split channel, select a reception frequency first.
- 2 Press [F], [CALL].
 - The selected frequency and related data are stored in the Call Channel.

To also store a separate transmit frequency, continue with the following steps.

- 3 Select the desired transmission frequency.
- 4 Press [F], then press [PTT] + [CALL].

- The separate transmission frequency is stored in the Call Channel.

Note:

- ◆ When you recall an odd-split Call Channel, “+” and “-” appear on the display.
 - ◆ Transmit offset status and Reverse status are not stored in an odd-split Call Channel.
-

CHANNEL DISPLAY MODE

While in this mode, the transceiver displays only memory channel numbers (or Memory names if they have been stored) instead of frequencies.

Press **[PTT] + [MR] + Power ON**.

- The transceiver displays the memory channel number in place of the operating frequencies.



To recover normal operation, turn the transceiver OFF and press **[PTT] + [MR] + Power ON** again.

- The following transceiver keys cannot be used while in Channel Display mode:
 - **[MENU]/ [VFO]**
 - **[F]** then **[VFO]** (Memory to VFO transfer)
 - **[F]** then **[MR]** (Storing Memory channel)
 - **[VFO] (1s)** (Band scan) / **[7] (1s)** (ASC)
 - **[PTT] + [F] + Power ON** (Full reset)
 - **[VFO] + Power ON** (VFO reset)
 - **[MR] + Power ON** (Clearing Memory channel)

Note:

- ◆ To enter the Channel Display Mode, you must have at least one memory channel that contains the data.
 - ◆ If the memory channel contains the Memory name data, the Memory name is displayed in place of the “CH” characters.
-

SCAN

Scan is a useful feature for hands-off monitoring of your favorite frequencies.

Becoming comfortable with all types of Scan will increase your operating efficiency.

This transceiver provides the following types of scans:

◆ **Band Scan**

Scans all frequencies on the current band.

◆ **Program Scan**

Scans the specified frequency ranges stored in Memory channels L0/U0 ~ L2/U2.

◆ **Memory Scan**

Scans all frequencies stored in the Memory channels.

◆ **Call Scan**

Scans the Call channel as well as the currently selected VFO frequency or Memory channel.

◆ **Priority Scan**

Checks the activities on the Priority channel (Pr) every 3 seconds.

Note:

- ◆ When the CTCSS or DCS function is activated, the transceiver stops at a busy frequency and decodes the CTCSS tone or DCS code. If the tone or code matches, the transceiver unmutes. Otherwise, it resumes scanning.
 - ◆ Press and hold **[MON]** to pause scan in order to monitor the scanning frequency. Release **[MON]** to resume scanning.
 - ◆ Pressing **[MENU]** causes scan to stop.
 - ◆ Starting scan switches OFF the Automatic Simplex Check (ASC).
 - ◆ If you press any key other than the following keys during scan, the transceiver exits scan (excluding Priority Scan). Priority Scan stops while "PRI" is blinking: **[F]**, **[*]**, **[*] (1s)**, **[MON]**, **[UP]/ [DOWN]**, Selector, **[F]** then **[MENU]**, and **[F]** then **[MON]**.
-

SELECTING A SCAN RESUME METHOD

The transceiver stops scanning at a frequency or Memory channel on which a signal is detected. It then continues scanning according to which resume mode you have selected. You can choose one of the following modes. The default is Time-operated mode.

◆ Time-Operated mode (TO)

The transceiver remains on a busy frequency or Memory channel for approximately 5 seconds, and then continues to scan even if the signal is still present.

◆ Carrier-Operated mode (CO)

The transceiver remains on a busy frequency or Memory channel until the signal drops out. There is a 2 second delay between signal drop-out and scan resumption.

◆ Seek mode (SE)

The transceiver remains on a busy frequency or Memory channel even after the signal drops out and does not automatically resume scanning.

- 1 Enter Menu mode and access Menu No. 3 (SCAN).
- 2 Press **[MENU]**, then rotate the **Selector** (or press **[UP]/ [DOWN]**) to select a Scan Resume mode to "TO", "CO" or "SE".



- 3 Press **[MENU]** to store the setting.
- 4 Press any key other than **[MON]**, **[UP]/ [DOWN]** or **[*]** to exit Menu mode.

BAND SCAN

The transceiver scans the entire band of the frequency you selected. For example, if you are operating and receiving at 144.525 MHz, it scans all the frequencies available for the 2 m band. When the current VFO receive frequency is outside the Program Scan frequency range {page 38}, the transceiver scans the entire frequency range available for the current VFO.

- 1 Press **[VFO]**.
- 2 Rotate the **Selector** (or press **[UP]/ [DOWN]**) to select the frequency outside of the Program Scan frequency range.
- 3 Press **[VFO] (1s)**.
 - Scan starts at the current frequency.
 - The 1 MHz decimal blinks while scanning is in progress.
 - To reverse the scan direction, rotate the **Selector** clockwise (or press **[UP]**) <upward scan> or counterclockwise (or press **[DOWN]**) <downward scan>.
- 4 To exit Band Scan, press any key other than **[MON]**, **[UP]/ [DOWN]** or **[*]**.

PROGRAM SCAN

You can limit the scanning frequency range. There are 3 memory channel pairs (L0/U0 ~ L2/U2) available for specifying the start and end frequencies. Program Scan monitors the range between the start and end frequencies that you have stored in these memory channels. Before performing Program Scan, store the Program Scan frequency range to one of the memory channel pairs (L0/U0 ~ L2/U2).

■ Storing a Program Scan Frequency Range

- 1 Press **[VFO]**, then rotate the **Selector** (or press **[UP]/ [DOWN]**) to select your desired start frequency.
- 2 Press **[F]**, **[MR]** then rotate the **Selector** (or press **[UP]/ [DOWN]**) to select a memory channel from L0 ~ L2.

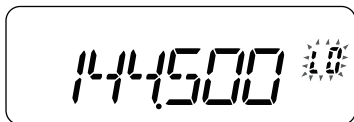

- 3 Press **[MR]** to store the start frequency in the memory channel.
- 4 Rotate the **Selector** (or press **[UP]/ [DOWN]**) to select your desired end frequency.

- 5 Press **[F]**, **[MR]** then rotate the **Selector** (or press **[UP]/[DOWN]**) to select a channel from U0 ~ U2, corresponding to the channel selected in step 4.

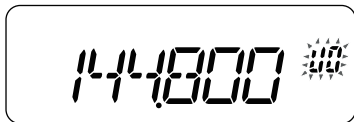

- For example, if you selected L0 in step 3, select U0 for the end frequency.
- 6 Press **[MR]** to store the end frequency in the memory channel.

■ Using Program Scan

- 1 Press **[VFO]**, then rotate the **Selector** (or press **[UP]/[DOWN]**) to select a frequency within the frequency range of memory channel L0/U0 ~ L2/U2.
- 2 Press **[VFO] (1s)** to start Program Scan.
- 3 To stop Program Scan, press any key other than **[MON]**, **[UP]/[DOWN]** or **[*]**.

Note:

- ◆ If you press **[MON]**, Program Scan temporarily pauses. Release **[MON]** to resume scanning.
 - ◆ The transceiver stops scanning when it detects a signal.
 - ◆ If more than 2 Program Scan channel pairs are stored and overlaps the frequency range among the pairs, the smaller Program Scan memory channel number has priority.
 - ◆ To perform Program Scan, the “L” channel must be lower than the “U” channel.
-

MEMORY SCAN

- 1 Press **[MR] (1s)**.
 - Scan starts from the last memory channel number and ascends up through the channel numbers (default).
 - Rotate the **Selector** (or press **[UP]/[DOWN]**) to change the scanning direction.

- 2 To stop Memory Scan, press any key other than **[MON]**, **[UP]/[DOWN]** or **[*]**.
-

Note:

- ◆ You must have 2 or more memory channels that contain data, excluding special function memory channels (L0/U0 ~ L2/U2, and PRI).
 - ◆ You can perform Memory Scan in Channel Display Mode {page 35}.
-

CALL SCAN

- 1 Select the frequency (in VFO or Memory Recall Mode) you want to monitor.
 - In VFO Mode, rotate the **Selector** (or press **[UP]/[DOWN]**) to select the desired frequency.
 - In Memory Recall Mode, rotate the **Selector** (or press **[UP]/[DOWN]**) to select the memory channel you want to monitor.
 - 2 Press **[CALL] (1s)** to start the Call Scan.
 - 3 The Call Channel and the selected VFO frequency or memory channel are monitored.
 - 4 To stop Call Scan, press any key other than **[MON]**, **[UP]/[DOWN]** or **[*]**.
-

Note:

- ◆ The transceiver stops scanning when it detects a signal.
 - ◆ You can perform Call Scan even if the recalled memory channel has been locked out {page42}.
-

PRIORITY SCAN

You may sometimes want to check your favorite frequency activities while monitoring other frequencies. In this case, use the Priority Scan function. Priority Scan checks the activities of the Priority Channel every 3 seconds. If the transceiver detects a signal on the Priority Channel, it recalls the frequency.

Note: If you do not operate any control or key for 3 seconds after the signal drops, the transceiver returns to the original frequency and resumes Priority Scan.

■ Programming a Priority Channel

- 1 Press **[VFO]**, then rotate the **Selector** (or press **[UP]/[DOWN]**) to select your desired Priority Channel frequency.
- 2 Select selective call functions, if necessary.
- 3 Press **[F]**, **[MR]**.
 - The memory channel number appears and blinks.
- 4 Rotate the **Selector** (or press **[UP]/[DOWN]**) to select “Pr”.

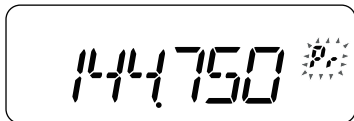

- 5 Press **[MR]** to store the data on the Priority Channel.

■ Using Priority Scan

- 1 Press **[F]**, **[6]** to turn the Priority Scan ON or OFF.
 - The “**PRI**” icon appears when the Priority Scan is ON.

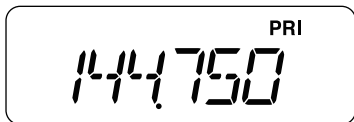

Note:

- ◆ If a signal is received on a Priority Channel with a CTCSS or DCS code programmed, the Priority Channel is recalled only when the programmed tone/ code matches.
 - ◆ Press and hold **[MON]** to pause Priority Scan when the transceiver is not displaying the Priority Channel. Release **[MON]** to resume Priority Scan.
 - ◆ If you clear the Priority Channel, Priority Scan stops.
 - ◆ You can also press any key other than **[*]**, **[MON]**, **[F]** then **[MON]** (Squelch level adjustment), **[F]** then **[MENU]** (Key lock) and **[PTT]** to exit Priority Scan while “**PRI**” is blinking.
-

MEMORY CHANNEL LOCKOUT

You can lock out memory channels that you prefer not to monitor during Memory Scan.

- 1 Press **[MR]** to enter Memory Recall Mode.
- 2 Rotate the **Selector** (or press **[UP]**/**[DOWN]**) to select the memory channel to be locked out.
- 3 Press **[F]**, **[9]** to toggle locked out ON and OFF.
 - The “★” icon appears below the memory channel number, indicating the channel is locked out.

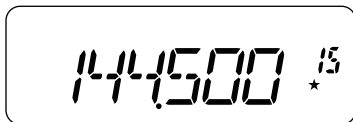

Note:

- ◆ The Program Scan memories (L0/U0 ~ L2/U2), Priority Channel (Pr) cannot be locked out.
 - ◆ Even if a memory channel is locked out, you can perform Call Scan between the Call Channel and the memory channel.
-

SELECTIVE CALL

CONTINUOUS TONE CODED SQUELCH SYSTEM (CTCSS)

You may sometimes want to hear calls only from specific persons. The Continuous Tone Coded Squelch System (CTCSS) allows you to ignore (not hear) unwanted calls from other persons who are using the same frequency. To do so, select the same CTCSS tone as selected by the other persons in your group. A CTCSS tone is subaudible and is selectable from among 42 tone frequencies.

Note: CTCSS does not cause your conversation to be private. It only relieves you from listening to unwanted conversations.

■ Using CTCSS

Press **[F]**, **[1]** 2 times to turn the CTCSS function ON.

- Continually press **[F]**, **[1]** to cycle through the functions as follows: Tone ON >> CTCSS ON >> DCS ON >> OFF.
- The “**CT**” icon appears when the CTCSS function is ON.

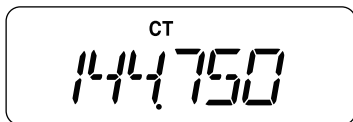

Note:

- ◆ You cannot use the CTCSS and Tone/ DCS functions simultaneously. Switching the CTCSS function ON after having activated the Tone/ DCS functions deactivates the Tone/ DCS functions.
 - ◆ If you select a high CTCSS frequency, receiving audio or noise that contains the same frequency portions may cause CTCSS to function incorrectly. To prevent noise from causing this problem, select an appropriate squelch level.
-

■ Selecting a CTCSS Frequency

1 Press **[F]**, **[5]**.

- The current CTCSS frequency appears on the display.



2 Rotate the **Selector** (or press **[UP]**/**[DOWN]**) to select your desired frequency.

3 Press any key other than **[MON]**, **[UP]**/**[DOWN]** or **[*]** to store the setting.

- The selectable CTCSS frequencies are the same as those for the Tone frequency. Refer to the table on the following page for the available CTCSS frequencies.

Available CTCSS Tone Frequencies

Tone Frequency (Hz)						
67.0	82.5	100.0	123.0	151.4	186.2	225.7
69.3	85.4	103.5	127.3	156.7	192.8	229.1
71.9	88.5	107.2	131.8	162.2	203.5	233.6
74.4	91.5	110.9	136.5	167.9	206.5	241.8
77.0	94.8	114.8	141.3	173.8	210.7	250.3
79.7	97.4	118.8	146.2	179.9	218.1	254.1

■ CTCSS Frequency ID Scan

This function scans through all CTCSS frequencies to identify the incoming CTCSS frequency on the received signal. You may find this useful when you cannot recall the CTCSS frequency that the other persons in your group are using.

1 Press **[F]**, **[5]** (**1s**) to start the CTCSS Frequency ID scan.

- While scanning, the decimal point of CTCSS frequency blinks.

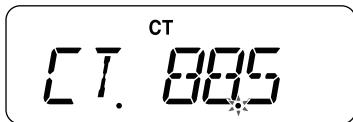

- To reverse the scan direction, rotate the **Selector** (or press **[UP]/ [DOWN]**).
- When a CTCSS frequency is identified, the identified frequency appears and blinks.



- 2 Press **[MENU]** to program the identified frequency in place of the current CTCSS frequency.
 - Press any key other than **[MON]**, **[UP]/ [DOWN]** or **[*]** to exit the Scan function.

Note:

- ◆ Received signals are monitored through the speaker while scanning is in progress.
 - ◆ CTCSS Frequency ID Scan does not scan the tone if a signal is not detected.
-

DIGITAL CODED SQUELCH (DCS)

Digital Code Squelch (DCS) is another application which allows you to ignore (not hear) unwanted calls. It functions the same way as CTCSS. The only differences are the encode/ decode method and the number of selectable codes. For DCS, you can select from 104 different codes.

■ Using DCS

Press **[F]**, **[1]** 3 times to turn the DCS function ON.

- Continually press **[F]**, **[1]** to cycle through the functions as follows: Tone ON >> CTCSS ON >> DCS ON >> OFF.
- The “**DCS**” icon appears when the DCS function is ON.

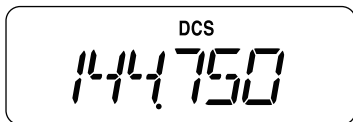

Note: You cannot use the DCS function and CTCSS/ Tone functions simultaneously. Switching the DCS function ON after having activated the CTCSS/ Tone functions deactivates the CTCSS/ Tone functions.

■ Selecting a DCS Code

1 Press **[F]**, **[4]**.

- The current DCS code appears on the display.



- 2 Rotate the **Selector** (or press **[UP]**/ **[DOWN]**) to select your desired code.
- 3 Press any key other than **[MON]**, **[UP]**/ **[DOWN]** or **[*]** to store the setting.

Available DCS Code

023	025	026	031	032	036	043	047
051	053	054	065	071	072	073	074
114	115	116	122	125	131	132	134
143	145	152	155	156	162	165	172
174	205	212	223	225	226	243	244
245	246	251	252	255	261	263	265
266	271	274	306	311	315	325	331
332	343	346	351	356	364	365	371
411	412	413	423	431	432	445	446
452	454	455	462	464	465	466	503
506	516	523	526	532	546	565	606
612	624	627	631	632	654	662	664
703	712	723	731	732	734	743	754

■ DCS Code ID Scan

This function scans through all DCS codes to identify the incoming DCS code on the received signal. You may find this useful when you cannot recall the DCS code that the other persons in your group are using.

1 Press **[F], [4] (1s)** to start the DCS code ID scan.

- While scanning, the decimal point between “DCS” and the DCS code blinks.



- To reverse the scan direction, rotate the **Selector** (or press **[UP]/ [DOWN]**).
- When a DCS code is identified, the identified DCS code appears and blinks.

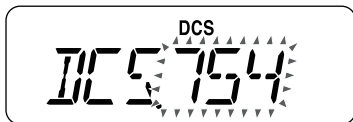

- 2 Press **[MENU]** to program the identified DCS code in place of the current DCS code.
- Press any key other than **[MON]**, **[UP]/ [DOWN]** or **[*]** to exit the Scan function.

Note:

- ◆ Received signals are monitored through the speaker while scanning is in progress.
 - ◆ DCS Code ID Scan does not scan the code if a signal is not detected.
-

DTMF FUNCTIONS

This transceiver provides you with 10 dedicated DTMF memory channels. You can store a DTMF code (16 digits max.) in each of these channels to recall later for speed dialing.

MANUAL DIALING

The numeric keypad functions as a DTMF keypad; the 12 keys found on a touch-tone phone plus 4 additional keys (A, B, C, D) on the rightmost column.

To perform Manual Dialing, follow the steps below.

- 1 Press and hold **[PTT]** to transmit.
- 2 While transmitting, press the keys in sequence on the keypad, to send the DTMF tones.
 - The corresponding DTMF tones are transmitted and monitored through the speaker.

Frequency (Hz)	1209	1366	1477	1633
697	1	2	3	A
770	4	5	6	B
852	7	8	9	C
941	*	0	#	D

- When DTMF TX Hold is ON, you do not need to continuously press **[PTT]** to remain in Transmission Mode. However, Transmission Mode is retained for only 2 seconds after pressing a key, so if the next key is not pressed within this time limit, the transceiver stops transmitting.

DTMF TX HOLD

This function causes the transceiver to remain in Transmission Mode for 2 seconds after you release each key. So, you can release [PTT] while sending the DTMF tones.

- 1 Enter Menu mode and access Menu No. 21 (DT.H).
- 2 Press [MENU], then rotate the **Selector** (or press [UP]/ [DOWN]) to select "ON".

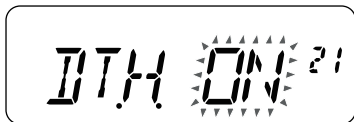

- 3 Press [MENU] to store the setting.
- 4 Press any key other than [MON], [UP]/ [DOWN] or [*] to exit Menu mode.

AUTOMATIC DIALER

If you use the 10 dedicated memory channels to store DTMF codes, you do not need to remember a long string of digits.

■ Storing a DTMF Code in Memory

- 1 Enter Menu mode and access Menu No. 19 (DTMF.MR).
- 2 Press [MENU], then rotate the **Selector** (or press [UP]/ [DOWN]) to select your desired DTMF memory channel number from 0 to 9.

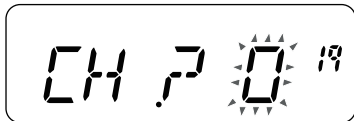

- 3 Press [MENU].
 - The DTMF code entry display appears and the last digit blinks.
- 4 Rotate the **Selector** (or press [UP]/ [DOWN]) to select a DTMF code.

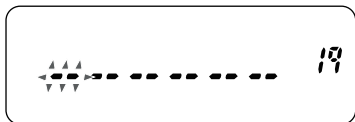

- Press **[CALL]** to delete the character at the current cursor position.
 - On the transceiver display, DTMF code “*” is represented by “E” and “#” is represented by “F”.
 - You can also enter a DTMF code using the keypad. Simply enter your desired DTMF codes on the keypad.
- 5 Press **[MENU]** to select the DTMF code and move the cursor to the next digit.
 - 6 Repeat steps 5 and 6 to enter up to 16 digits.
 - 7 To complete the entry, press **[MENU]** without selecting a DTMF code. To confirm the stored DTMF code, perform steps 1 and 2, then press **[MON]**. The programmed DTMF code scrolls through the display without transmitting.
 - 8 Press any key other than **[MON]**, **[UP]/ [DOWN]** or **[*]** to exit Menu mode.

■ TRANSMITTING A STORED DTMF CODE

- 1 While pressing and holding **[PTT]**, press **[MENU]**.
- 2 Release **[MENU]** (continue pressing **[PTT]**), then rotate the **Selector** (or press **[UP]/ [DOWN]**) to select the desired DTMF memory channel number.
- 3 While still holding **[PTT]**, press **[MENU]** again to transmit the selected DTMF tones.
 - The code stored in the channel scrolls across the display, accompanied by DTMF tones from the speaker.
 - After transmission, the frequency display is restored.
 - If you do not need to confirm the memory channel contents, press **[0] ~ [9]** instead of turning the **Selector** (or pressing **[UP]/ [DOWN]**) in step 2, to select a channel number. The stored DTMF code will be immediately transmitted. (You do not have to press **[MENU]** in step 3.)

Note: If you select an empty DTMF memory channel and press **[MENU]**, the frequency display is restored.

ADJUSTING THE DTMF TONE TRANSMISSION SPEED

This transceiver allows you to configure the DTMF code transmission speed between Fast (default) and Slow. If a repeater cannot respond to the fast speed, adjust this parameter.

- 1 Enter Menu mode and access Menu No. 20 (SPD).
- 2 Press **[MENU]**, then rotate the **Selector** (or press **[UP]/ [DOWN]**) to select “FA” (Fast) or “SL” (Slow).

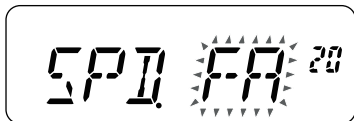

- The tone duration of FAST is 50 ms and SLOW is 100 ms. “FA” (Fast) is the default setting.
- 3 Press **[MENU]** to store the setting.
 - 4 Press any key other than **[MON]**, **[UP]/ [DOWN]** or **[*]** to exit Menu mode.

ADJUSTING THE PAUSE DURATION

You can change the pause duration (a space digit) stored in memory channels. The default setting is 500 milliseconds.

- 1 Enter Menu mode and access Menu No. 22 (PA).
- 2 Press **[MENU]**, then rotate the **Selector** (or press **[UP]/ [DOWN]**) to select 100, 250, 500, 750, 1000, 1500, 2000 ms.



- 3 Press **[MENU]** to store the setting.
- 4 Press any key other than **[MON]**, **[UP]/ [DOWN]** or **[*]** to exit Menu mode.

DTMF Lock

Assuming you have a transceiver with the optional speaker microphone installed and you are carrying it in the holder or bag, you sometimes may want to disable the keypad to avoid accidental DTMF transmission. In this case, turn the DTMF Lock function ON.

- 1 Enter Menu mode and access Menu No. 23 (DT.L).
- 2 Press **[MENU]**, then rotate the **Selector** (or press **[UP]/ [DOWN]**) to select "ON".

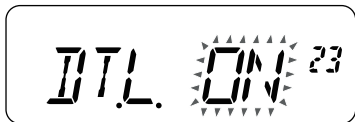

- 3 Press **[MENU]** to store the setting.
- 4 Press any key other than **[MON]**, **[UP]/ [DOWN]** or **[*]** to exit Menu mode.

AUXILIARY FUNCTIONS

APO (AUTO POWER OFF)

The transceiver switches OFF automatically if no keys or controls are pressed or adjusted for 30 minutes (default). One minute before the transceiver switches OFF, warning beeps sound for a few seconds and “APO” blinks. You can select the APO time from OFF (disable), 30 (default), 60, 90, 120, or 180 minutes.

- 1 Enter Menu mode and access Menu No. 8 (APO).
- 2 Press **[MENU]**, then rotate the **Selector** (or press **[UP]/ [DOWN]**) to select the APO time.

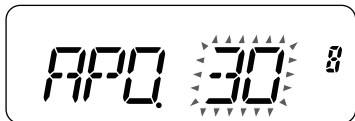

- 3 Press **[MENU]** to store the setting.
- 4 Press any key other than **[MON]**, **[UP]/ [DOWN]** or **[*]** to exit Menu mode.

Note:

- ◆ APO does not function while the transceiver is scanning.
 - ◆ The APO timer starts counting down the time when no key presses, no control adjustments.
 - ◆ The APO warning beep sounds and “APO” appears 1 minute before the transceiver turns OFF.
 - ◆ The APO warning beep sounds even if Menu No. 16 (BP) is set to “OFF”.
-

REMAINING BATTERY CAPACITY

You can confirm the remaining battery capacity when you transmit in low power.

To check the remaining capacity:

- 1 Press and hold **[PTT]**.

- The bar-graph shows the remaining battery capacity.

▶▶▶▶▶: High battery power

▶▶▶▶: ↑

▶▶▶: ↑

▶▶: Low battery power

▶ or no display : Recharge or replace the batteries.

2 Release [PTT] to exit.

Note: You may not be able to transmit at high power if the battery remaining indicator shows low battery power

■ Battery Life

Before you operate the transceiver outside using a battery pack, it is important to know how long the battery pack will last. The operating times listed in the table below are measured under the following cyclic conditions:

TX : RX : Stand-by = 5 : 5 : 90

We recommend you carry extra battery packs with you, in case the battery pack becomes discharged.

Battery Type	Output Power	Operating Time/ Hours (Approx.)
PB-43N (7.2 V)	High	8
	Low	15
BT-14 (9.0 V)	High	8
	Low	15

BATTERY SAVER

The Battery Saver extends the operating time of the transceiver. It automatically activates when the squelch is closed and no key is pressed for more than 10 seconds. To reduce battery consumption, this function shuts the receiver circuit OFF for the programmed time, then momentarily turn it back ON to detect a signal.

To program the receiver shut-off period for the battery saver:

- 1 Enter Menu mode and access Menu No. 7 (SAV).

- 2 Press **[MENU]**, then rotate the **Selector** (or press **[UP]/ [DOWN]**) to select the receiver shutoff period from OFF, 0.2, 0.4, 0.6, 0.8, 1.0, 2.0, 3.0, 4.0, or 5.0 seconds.

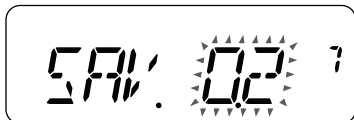

- 3 Press **[MENU]** to store the setting.
- 4 Press any key other than **[MON]**, **[UP]/ [DOWN]** or **[*]** to exit Menu mode.

Note:

- ◆ The longer the shut-off period, the more you can save on battery consumption. However, there is a greater chance of missing a signal.
- ◆ When the CTCSS/ DCS code matches during reception, the battery saver function is turned OFF.
- ◆ Battery Saver does not function while scanning.

BEAT SHIFT

Since the transceiver uses a microprocessor to control various functions of the transceiver, the CPU clock oscillator's harmonics or image may appear on some spots of the reception frequencies {page 73}. In this case, turn the Beat Shift function ON.

- 1 Enter Menu mode and access Menu No. 17 (BS).
- 2 Press **[MENU]**, then rotate the **Selector** (or press **[UP]/ [DOWN]**) to select "ON".



- 3 Press **[MENU]** to store the setting.
- 4 Press any key other than **[MON]**, **[UP]/ [DOWN]** or **[*]** to exit Menu mode.

Note: Beat Shift status can be stored to each Memory channel.

BEEP FUNCTION

The Beep function provides confirmation of entry, error status, and malfunctions of the transceiver. We recommend you leave this function ON in order to detect erroneous operations and malfunctions.

However, to turn the beep function OFF:

- 1 Enter Menu mode and access Menu No. 16 (BP).
- 2 Press **[MENU]**, then rotate the **Selector** (or press **[UP]/ [DOWN]**) to select "OFF".



- 3 Press **[MENU]** to store the setting.
- 4 Press any key other than **[MON]**, **[UP]/ [DOWN]** or **[*]** to exit Menu mode.

The transceiver generates the following warning beeps even if the beep function is turned OFF.

- APO warning beeps
- Time-Out Timer warning beep

Note: The beep output level is linked to the volume control position.

BUSY CHANNEL LOCKOUT

This function is used in order to prevent transmitting on a channel or frequency that somebody else is currently using. When turned ON, an error beep sounds and you cannot transmit even if you press **[PTT]**.

- 1 Enter Menu mode and access Menu No. 13 (BCL).
- 2 Press **[MENU]**, then rotate the **Selector** (or press **[UP]/ [DOWN]**) to select "ON".

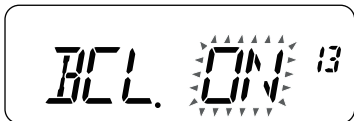

- 3 Press **[MENU]** to store the setting.
- 4 Press any key other than **[MON]**, **[UP]/ [DOWN]** or **[✖]** to exit Menu mode.

FREQUENCY STEP SIZE

Choosing the correct frequency step size is essential in order to select your exact receive frequency using the **Selector** (or **[UP]/ [DOWN]**). You can select your desired frequency step size from: 5, 6.25, 10, 12.5, 15, 20, 25, 30, 50, or 100 (kHz).

To change the frequency step size:

- 1 Press **[VFO]**, then press **[F]**, **[3]**.
 - The current frequency step size appears.

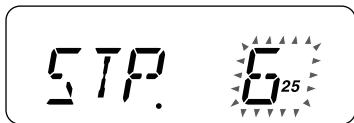

- 2 Rotate the **Selector** (or press **[UP]/ [DOWN]**) to select your desired frequency step size.
- 3 Press any key other than **[MON]**, **[UP]/ [DOWN]** or **[✖]** to exit the frequency step size selection.

Note: If you change to a frequency step size that does not match the current operating frequency, the transceiver automatically adjusts the frequency to match the new frequency step size.

BACK LIGHT

To illuminate the display:

Press **[✖]**.

- If no other key is pressed, the light turns OFF approximately 5 seconds after releasing **[✖]**.
- Press any key (including **[PTT]**) other than **[✖]** while the display is lit to restart the 5-second timer.
- Press **[✖]** while the display is lit to immediately turn the light OFF.

To keep the light ON continuously:

Press [**✖**] (1s).

- The light remains ON until you press [**✖**] (1s) again.

LOCK FUNCTION

The lock function disables most of the keys to prevent you from accidentally activating a function.

- 1 Press [**F**], [**MENU**] to turn the Lock function ON.
 - The “**no**” icon appears when the Lock function is ON.

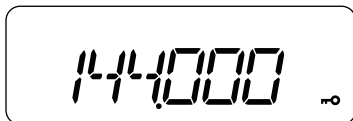

- The following keys cannot be locked:
[**F**], [**⏻**] (POWER), [**PTT**], [**✖**], [**MON**], Volume control and microphone PF key.
- 2 Press [**F**], [**MENU**] to unlock the keys.

Note: You cannot perform the Microprocessor Reset {page 71} while the Lock function is ON.

SELECTOR UNLOCK

While the Lock function is ON, you sometimes may want to rotate the **Selector** (or press [**UP**]/ [**DOWN**]) to change the frequency. In this case, turn the Selector unlock function ON.

- 1 Enter Menu mode and access Menu No. 18 (SEL).
- 2 Press [**MENU**], then rotate the **Selector** (or press [**UP**]/ [**DOWN**]) to select “ON”.



- 3 Press [**MENU**] to store the setting.
- 4 Press any key other than [**MON**], [**UP**]/ [**DOWN**] or [**✖**] to exit Menu mode.

MICROPHONE KEY LOCK

The Microphone Key Lock function will lock the microphone PF keys.

- 1 Enter Menu mode and access Menu No. 24 (M.PF.).
- 2 Press **[MENU]**, then rotate the **Selector** (or press **[UP]/ [DOWN]**) to select "OFF".



- 3 Press **[MENU]** to store the setting.
- 4 Press any key other than **[MON]**, **[UP]/ [DOWN]** or **[*]** to exit Menu mode.

MICROPHONE PF KEYS (OPTIONAL)

If you have an optional SMC-33 or SMC-34 speaker microphone, you can access many transceiver settings without using transceiver keys or controls. Microphone keys 1, 2, and 3, located on the top of the microphone, are programmable with transceiver functions.

The microphone key default assignments are as follows:

Mic [1]: VFO Mic [2]: MR Mic [3]: CALL

Note:

- ◆ Turn the transceiver OFF before connecting the optional speaker microphone.
- ◆ While Menu No. 24 (M.PF.) is "OFF" or the Lock function is ON, you cannot program PF keys.
- ◆ If the LOCK switch on the rear of the microphone is ON, you must move the switch to the OFF position to program the keys.

-
- 1 Press one of the following key combinations to reprogram the keys on the speaker microphone.
 - Press Mic **[1]** + **Power ON** to reprogram Mic [1].
 - Press Mic **[2]** + **Power ON** to reprogram Mic [2].
 - Press Mic **[3]** + **Power ON** to reprogram Mic [3].
 - 2 Press a key or the key combination you want to assign to the microphone key.

Key name	[KEY]	[F] + [KEY]	[KEY] (1s or 1.5s)
[UP]	Volume or Function Up ¹		–
[DOWN]	Volume or Function Down ¹		–
[MENU]	MENU	Key lock	–
[CALL]	CALL	CALL IN	–
[VFO]	VFO	MR to VFO	–
[MR]	MR	MR IN	–
[MON]	MON	Squelch level	–
[1]	Recalling CH 1	Signaling	–
[2]	Recalling CH 2	Tone frequency	–
[3]	Recalling CH 3	Frequency step	–
[4]	Recalling CH 4	DCS code	–
[5]	Recalling CH 5	CTCSS frequency	Speaker attenuation ²
[6]	Recalling CH 6	Priority scan	–
[7]	Recalling CH 7	Reverse	–
[8]	Recalling CH 8	Offset direction	–
[9]	Recalling CH 9	Channel lock out	–
[0]	Recalling CH 0	–	–
[*]	Back light On	–	To keep the light ON ²
[#]	Direct entry	Volume adjustment operation selection	–
[PTT]	VFO <> MR	Transmit power	–
Selector	Volume or Function Up or Down ¹		
[REMO 1] ³ ~ [REMO 3]	REMO 1 ~ REMO 3	REMO 1 ~ REMO 3	–

¹ After saving a function to a microphone PF key, changing the volume adjustment operation selection setting of the transceiver will not cause the operation of the microphone PF key to change.

² You do not need to continuously hold the PF key.

³ “REMO 1” ~ “REMO 3” are the current settings for the microphone PF keys.

MONITOR

When you are receiving while the squelch function is ON, weak signals may become intermittent. If the CTCSS or DCS function is ON, you may want to disable the squelch function temporarily to monitor the current channel activities. In both of these cases, use the Monitor function to temporarily disable the squelch function.

To activate the Monitor function:

- 1 Press and hold **[MON]**.
 - The speaker is unmuted and you can monitor the signals.
- 2 Release **[MON]** to return to normal operation.

POWER ON MESSAGE

You can change the Power ON Message (a maximum of 6 characters) when the transceiver is turned ON.

- 1 Enter Menu mode and access Menu No. 15 (P.ON.MSG).
- 2 Press **[MENU]**.
 - A blinking cursor appears.



- 3 Rotate the **Selector** (or press **[UP]/ [DOWN]**) to select a character.
 - You can enter the following alphanumeric characters:
0 ~ 9, A ~ Z, - (hyphen), / (slash) and a space.
- 4 Press **[MENU]**.
 - The cursor moves to the next digit.
- 5 Repeat steps 3 and 4 to enter up to 6 digits.



- Press [**CALL**] to delete the character at the current cursor position.
- 6 Press any key other than [**MON**], [**UP**]/ [**DOWN**] or [**✖**] to exit Menu mode.

PROGRAMMABLE VFO

If you want to limit the operating frequencies within a certain range, program the upper and lower frequency limits to the programmable VFO parameters. For example, if you select 144 MHz for the lower limit and 145 MHz for the upper limit, the tunable range will be limited from 144.000 MHz to 145.995 MHz.

- 1 Press [**VFO**].
- 2 Enter Menu mode and access Menu No. 1 (P.VFO).
- 3 Press [**MENU**].
 - The current programmable frequency range for the band appears.
- 4 Rotate the **Selector** (or press [**UP**]/ [**DOWN**]) to select the lower limit frequency in MHz.

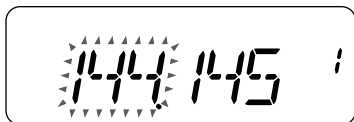

- 5 Press [**MENU**] to store the lower limit frequency.
 - The upper limit frequency blinks.
- 6 Rotate the **Selector** (or press [**UP**]/ [**DOWN**]) to select the upper limit frequency in MHz.

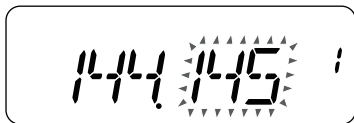

- 7 Press [**MENU**] to store the upper limit frequency.
- 8 Press any key other than [**MON**], [**UP**]/ [**DOWN**] or [**✖**] to exit Menu mode.

Note:

- ◆ You cannot program the 100 kHz or lower digits.
 - ◆ The upper limit frequency cannot be set lower than the selected lower limit frequency.
-

TIME-OUT TIMER

The Time-out Timer limits the time of each transmission. The built-in Time-out Timer limits each transmission time to a maximum of 3, 5 or 10 (default) minutes. Just before the transceiver stops the transmission, a warning beep sounds. This function is necessary to protect the transceiver from thermal damage and can therefore not be turned OFF.

- 1 Enter Menu mode and access Menu No. 12 (TOT).
- 2 Press **[MENU]**, then rotate the **Selector** (or press **[UP]/ [DOWN]**) to select "3", "5" or "10".

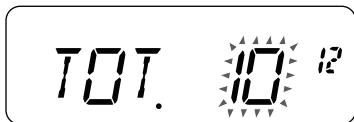

- 3 Press **[MENU]** to store the setting.
- 4 Press any key other than **[MON]**, **[UP]/ [DOWN]** or **[*]** to exit Menu mode.

Note: A warning beep sounds even if you set Menu No. 16 (BP) to OFF.

TX INHIBIT

You can inhibit the transmission to prevent unauthorized individuals from transmitting, or to eliminate accidental transmissions while carrying the transceiver.

- 1 Enter Menu mode and access Menu No. 14 (TXI).
- 2 Press **[MENU]**, then rotate the **Selector** (or press **[UP]/ [DOWN]**) to select "ON".

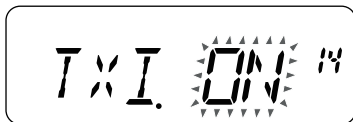

- 3 Press **[MENU]** to store the setting.
- 4 Press any key other than **[MON]**, **[UP]/ [DOWN]** or **[*]** to exit Menu mode.
 - “TX INH” appears and an error beep sounds if the transceiver tries to transmit while TX Inhibit is ON.

EMERGENCY SIREN

Press and hold the **[0]** key for at least 1.5 seconds to emit the siren from the speaker at the selected volume level.

To set the Emergency siren volume level:

- 1 Enter Menu mode and access Menu No. 11 (EMG).
- 2 Press **[MENU]**, then rotate the **Selector** (or press **[UP]/ [DOWN]**) to select “OFF”, “VOL”, “MED” or “MAX”.



OFF: The Emergency siren does not sound.

VOL: The Emergency siren sounds at the same level as the current volume setting.

MED: The Emergency siren sounds using volume level 8, no matter what the current volume level setting is.

MAX: The Emergency siren sounds using volume level 31, no matter what the current volume level setting is.

- 3 Press **[MENU]** to store the setting.
- 4 Press any key other than **[MON]**, **[UP]/ [DOWN]** or **[*]** to exit Menu mode.

■ Using the Emergency Siren

- 1 Press **[0]** (1.5s), to turn the Emergency siren ON.
 - “EMG” appears.

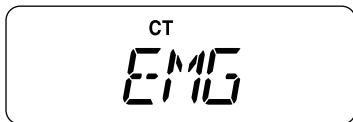

- 2 Press **[0]** (1.5s), **[PTT]** or power OFF, to turn the Emergency siren OFF.
 - When the Emergency siren sounds, press **[PTT]** to turn it OFF.
 - While the Emergency siren is sounding and a signal is being received (as shown by the signal meter), you will be unable to hear the signal from the speaker.
 - The Emergency siren will continue to sound until it has been turned OFF.



CAUTION

When using an earphone or headset, do not turn the Emergency Siren function ON.

MINIMUM/ MAXIMUM VOLUME

The transceiver retains the same volume level when the Volume control is turned to the lowest limit. Maximum Volume level allows you to limit the volume level to be no higher than the configured level even if a user attempts to increase the volume level.

- 1 Enter Menu mode and access Menu No. 9 (VOLUME).
- 2 Press **[MENU]**, then rotate the **Selector** (or press **[UP]/ [DOWN]**) to select the minimum volume level (0 - 31).

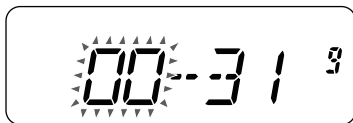

- 3 Press **[MENU]**, then rotate the **Selector** (or press **[UP]/ [DOWN]**) to select the maximum volume level (0 - 31).



- 4 Press **[MENU]** to store the setting.
- 5 Press any key other than **[MON]**, **[UP]/ [DOWN]** or **[*]** to exit Menu mode.

SPEAKER ATTENUATION

Speaker Attenuation decreases the volume level of the Speaker/ Microphone by approximately 10 dB.

- 1 Press **[5] (1s)** to turn the Speaker Attenuation function ON.
 - The "**SP.ATT**" icon appears when the Speaker Attenuation function is ON.

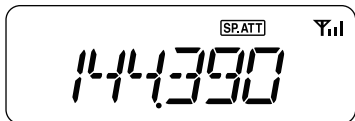

- 2 Press **[PTT]** or **[5] (1s)** to turn the Speaker Attenuation function OFF.

POWER ON PASSWORD

If power on password is activated, you cannot operate the transceiver without first entering your password after turning the transceiver power ON. The password can contain up to 6 digits.

- 1 Enter Menu mode and access Menu No. 10 (PASSWD).
- 2 Press **[MENU]**.
 - A blinking cursor appears.

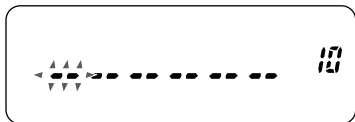

- 3 Press the [0] ~ [9] keys corresponding to the password.

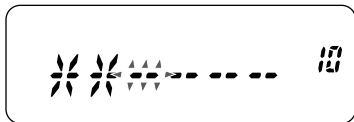

- Power on password will activate when one or more characters are set.
- Press [CALL] to delete an incorrect character.

- 4 Press [MENU].

- “RE-ENT” appears.

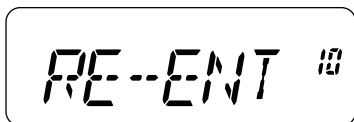

- 5 Re-enter the same password, for conformation.

- If you enter an incorrect password, an error tone sounds and return to Menu No.10 (PASSWD).

- 6 Press [MENU] to confirm the password.

- 7 Press any key other than [MON], [UP]/ [DOWN] or [✳] to exit Menu mode.

When turning the transceiver power ON while the Password function is programmed, “PASSWD” appears on the display. You must enter the password to unlock the transceiver.

To enter the password:

- 1 Press the [0] ~ [9] keys corresponding to the password.

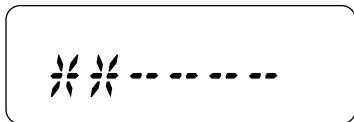

- Press [CALL] to delete an incorrect character.

- 2 Press [MENU] to confirm the password.

- If you enter an incorrect password, an error tone sounds and the transceiver remains locked.

OPTIONAL ACCESSORIES

The following options are available for use with this transceiver:

- PB-43N Ni-MH battery pack
- BT-14 Battery case
- SMC-32 Speaker microphone
- SMC-33 Speaker microphone
- SMC-34 Speaker microphone
- HMC-3 Headset
- HMC-4 Headset
- KHS-21 Headset
- EMC-3 Clip microphone
- HS-9 Earphone
- KSC-24 Rapid Charger

Note: Optional accessories for use with this transceiver may change, post-production. (New options may become available and/or current options may be discontinued.) Please refer to the options catalog(s) for applicable transceivers.

MAINTENANCE

GENERAL INFORMATION

This product has been factory aligned and tested to specification before shipment. Attempting service or alignment without factory authorization can void the product warranty.

SERVICE

When returning this product to your dealer or service center for repair, pack it in its original box and packing material. Include a full description of the problem(s) experienced. Include your telephone number along with your name and address in case the service technician needs to contact you; if available, also include your fax number and e-mail address. Don't return accessory items unless you feel they are directly related to the service problem. You may return this product for service to the authorized Kenwood dealer from whom you purchased it, or any authorized Kenwood service center. Please do not send subassemblies or printed circuit boards; send the complete product. A copy of the service report will be returned with the product.

■ Service Note

If you desire to correspond on a technical or operational problem, please make your note legible, short, complete, and to the point. Help us help you by providing the following:

- Model and serial number of equipment
- Question or problem you are having
- Other equipment in your station pertaining to the problem



CAUTION

Do not pack the equipment in crushed newspapers for shipment! Extensive damage may result during rough handling or shipping.

Note:

- ◆ Record the date of purchase, serial number and dealer from whom this product was purchased.
 - ◆ For your own information, retain a written record of any maintenance performed on this product.
 - ◆ When claiming warranty service, please include a photocopy of the bill of sale or other proof-of-purchase showing the date of sale.
-

CLEANING

To clean the case of this product, use a neutral detergent (no strong chemicals) and a damp cloth.

MICROPROCESSOR RESET

If your transceiver seems to be malfunctioning, resetting the microprocessor may solve the problem. The following 2 reset Modes are available. When performing the reset, you may lose memory data and stored information. Write down important data before performing the reset.

VFO Reset

This resets the transceiver parameters excluding the stored DTMF Numbers in Memory {page 50} and memory channel contents.

Full Reset

This resets all transceiver parameters to the factory default values.

Note: While operating the transceiver in Channel Display Mode {page 35}, you cannot reset the transceiver.

■ VFO Reset

When the transceiver is turned OFF:

1 Press [VFO] + Power ON.

- The VFO reset confirmation message, “VF.RST?” appears.

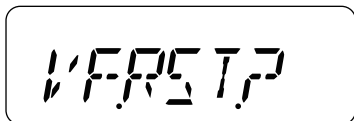

2 Press **[VFO]** to proceed.

- “SURE ?” appears.

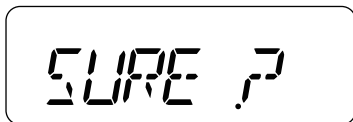

- Press any key other than **[*]** or **[VFO]** to exit the Reset Mode.

3 Press **[VFO]** to reset the transceiver.

■ Full Reset

When the transceiver is turned OFF:

1 Press **[PTT] + [F] + Power ON**.

- The full reset confirmation message, “FL.RST?” appears.

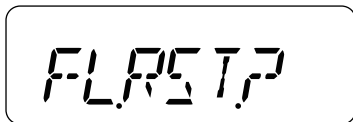

2 Press **[F]** to proceed.

- “SURE ?” appears.
- Press any key other than **[*]** or **[F]** to exit the Reset Mode.

3 Press **[F]** to reset the transceiver.

OPERATION NOTICES

The transceiver has been designed and engineered to avoid possible hardware glitches. However, you may notice the following symptoms when you operate the transceiver. These symptoms are not malfunctions.

RECEIVING SIGNALS IN CITIES

When you receive signals in cities, the receiver's entire antenna indicator may light up without receiving any strong signals. This happens when the RF amplifier in the receiver is overloaded by strong interference signals that are nearby.

TRANSMISSION

If you continuously transmit for more than 8 minutes at high power (5 W), the transceiver becomes warm.

If you continue or repeat the transmission before the transceiver cools down, the thermal protector gradually decreases the output power down to 1.5 W.

INTERNAL BEATS

On some spots of the frequency, the antenna indicator moves without receiving any signals or you cannot receive any signals. This is inevitable when you use super-heterodyne receivers. If this happens, access Menu No. 17 (BS) and select "ON".

Internal Beats Frequency

140.800 MHz, 153.600 MHz, 166.400 MHz

TROUBLESHOOTING

The problems described in this table are commonly encountered operational malfunctions and are usually not caused by circuit failure.

Problem	Solution
Nothing appears on the display when the transceiver is switched ON, or the display is blinking ON and OFF.	The battery pack is discharged. Recharge the battery pack or replace the batteries.
Most keys and the Selector do not function.	Transceiver Lock function is ON (the “  ” icon is visible). Press [F] , [MUNU] to turn OFF Transceiver Lock.
	The transceiver is in Channel Display Mode. Press [PTT] + [MR] + Power ON to exit Channel Display Mode.
You cannot recall any memory channel.	You have stored no data in any of the memory channels. Store the desired frequencies in the memory channels.
You cannot select the exact desired frequency using the selector.	The current frequency step size does not allow the frequency to be selected. Select an appropriate frequency step size. Press [F] , [3] to change the frequency step size.
	Programmable VFO frequency range is too narrow. Expand the frequency range in Menu No. 1 (P.VFO).
Increasing the Volume control does not allow you to hear audio.	The selective call function (CTCSS or DCS) is ON. Turn OFF the selective call function.

Problem	Solution
<p>You cannot transmit by pressing [PTT].</p>	<p>You selected a frequency outside the allowable range. Select a frequency within the allowable transmit frequency range.</p>
	<p>You selected a transmit offset that places the transmit frequency outside the limit. Select a proper offset direction or offset frequency.</p>
	<p>TX inhibit is ON. Access Menu No.14 (TXI) and select "OFF".</p>
	<p>The battery pack voltage is too low to transmit. Change or replace the battery.</p>
<p>Repeater cannot be accessed.</p>	<p>Wrong tone frequency is selected. Select a proper repeater access tone.</p>
	<p>Wrong repeater offset frequency is selected. Access Menu No. 2 (OFFSET) and select an appropriate offset frequency.</p>
	<p>Wrong offset direction is selected. Try other offset directions.</p>
<p>DTMF tone cannot be transmitted.</p>	<p>DTMF Lock is ON. Access Menu No. 23 (DT.L) and select "OFF".</p>

Problem	Solution
<p>The transceiver switches OFF for no apparent reason.</p>	<p>The Automatic Power OFF (APO) function is ON. Access Menu No. 8 (APO) and select your desired time length or "OFF".</p>
<p>The transceiver returns to Reception Mode during a long transmission.</p>	<p>The transmission time exceeded the programmed TOT time. Access Menu No. 12 (TOT) to select your desired transmission length. The TOT cannot be turned OFF, protecting the transceiver from the thermal damage.</p>
<p>The Scan function does not resume scanning after the transceiver detects a signal.</p>	<p>You have selected "SE" (SEEK) for Menu No. 3 (SCAN). Select either "TO" (Time-Operated) or "CO" (Carrier-Operated) for Menu No. 3 (SCAN).</p>

SPECIFICATIONS

Note: All specifications are guaranteed within the amateur radio band.

Specifications are subject to change without notice due to advancements in technology.

General			
Frequency range	TX	K type	144 ~ 148 MHz
		M type	136 ~ 174 MHz
	RX		136 ~ 174 MHz
Mode			F3E
Antenna impedance			50 Ω
Operating temperature range			-10°C ~ +50°C (+14°F ~ +122°F)
Operating Voltage			DC 6.0 ~ 9.0 V (7.5 V nominal)
Frequency stability			Within ± 5 ppm
Dimensions (W x H x D include projections)			58.0 x 129.7 x 37.8 mm 2 9/32 x 5 3/32 x 1 31/64 inches with PB-43N 58.0 x 129.7 x 39.0 mm 2 9/32 x 5 3/32 x 1 1/2 inches with BT-14
Weight (approx.) <Included antenna, Belt clip, and Battery>			375 g/ 13.2 oz. with PB-43N/ BT-14

Transmitter	
RF output power (approx.)	High: 5.5 W
	Low: 0.5 W
Modulation	Reactance modulation
Maximum frequency deviation	Within ± 5 kHz
Spurious emission	Less than -60 dB
Modulation distortion (300 Hz ~ 3 kHz)	Less than 3 %

Receiver		
Circuit type		Double super heterodyne
Intermediate Frequency (IF)		1st IF: 38.85 MHz 2nd IF: 450 kHz
Sensitivity (12 dB SINAD)		Less than 0.18 μ V
Squelch sensitivity		Less than 0.13 μ V
Selectivity	-6 dB	More than 10 kHz
	-40 dB	Less than 28 kHz
Audio output (10 % distortion)		More than 400 mW

KENWOOD