SIEMENS

CL-010/CL-010-I ADSL2+ Router

User's Manual



Rev: 1.5

2007/03/30

No part of this publication may be reproduced in any form by any means without the prior written permission. Other trademarks or brand names mentioned herein are trademarks or registered trademarks of their respective companies.

This manual currently suits for CL-010/CL-010-I.

Safety Notes

- For Installation**
- Use only the type of power source indicated on the marking labels.
 - Use only power adapter supplied with the product.
 - Do not overload wall outlet or extension cords as this may increase the risk of electric shock or fire. If the power cord is frayed, replace it with a new one.
 - Proper ventilation is necessary to prevent the product overheating. Do not block or cover the slots and openings on the device, which are intended for ventilation and proper operation. It is recommended to mount the product with a stack.
 - Do not place the product near any source of heat or expose it to direct sunlight.
 - Do not expose the product to moisture. Never spill any liquid on the product.
 - Do not attempt to connect with any computer accessory or electronic product without instructions from qualified service personnel. This may result in risk of electronic shock or fire.
 - Do not place this product on unstable stand or table.
- For Using**
- Power off and unplug this product from the wall outlet when it is not in use or before cleaning. Pay attention to the temperature of the power adapter. The temperature might be high.
 - After powering off the product, power on the product at least 15 seconds later.
 - Do not block the ventilating openings of this product.
 - When the product is expected to be not in use for a period of time, unplug the power cord of the product to prevent it from the damage of storm or sudden increases in rating.
- For Service**
- Do not attempt to disassemble or open covers of this unit by yourself. Nor should you attempt to service the product yourself, which may void the user's authority to operate it. Contact qualified service personnel under the following conditions:
- If the power cord or plug is damaged or frayed.
 - If liquid has been spilled into the product.
 - If the product has been exposed to rain or water.
 - If the product does not operate normally when the operating instructions are followed.
 - If the product has been dropped or the cabinet has been damaged.
 - If the product exhibits a distinct change in performance.
- Warning**
- This device complies with Part 15 of the FCC Rules. Operation is subject to the following two conditions: (1) this device may not cause harmful interference, and (2) this device must accept any interference received, including interference that may cause undesired operation.
- Caution**
- Any changes or modifications not expressly approved by the party responsible for compliance could void the authority to operate equipment.

FCC

FCC Class B Notice

This device complies with Part 15 of the FCC Rules. Operation is subject to the following two conditions:

- (1) this device may not cause harmful interference, and
- (2) this device must accept any interference received, including interference that may cause undesired operation.

Note: This equipment has been tested and found to comply with the limits for a Class B digital device, pursuant to Part 15 of the FCC Rules. These limits are designed to provide reasonable protection against harmful interference in a residential installation. This equipment can generate, use and radiate radio frequency energy and, if not installed and used in accordance with the instructions, may cause harmful interference to radio communications. However, there is no guarantee that interference will not occur in a particular installation. If this equipment does cause harmful interference to radio or television reception, which can be determined by turning the equipment off and on, the user is encouraged to try to correct the interference by one or more of the following measures:

- Reorient or relocate the receiving antenna.
- Increase the separation between the equipment and receiver.
- Connect the equipment into an outlet on a circuit different from that to which the receiver is connected.
- Consult the dealer or an experienced radio/television technician for help.

IC Statement

To prevent radio interference to the licensed service, this device is intended to be operated indoors and away from windows to provide maximum shielding. Equipment (or its transmit antenna) that is installed outdoors is subject to licensing

ICES-003 Class B Notice - Avis NMB-003, Classe B

This Class B digital apparatus complies with Canadian ICES-003.

Cet appareil numérique de la classe B est conforme à la norme NMB-003 du Canada.

Preface

Thank you for choosing the Asymmetric Digital Subscriber Line (ADSL2+) Router. With the asymmetric technology, this device runs over standard copper phone lines. In addition, ADSL2+ allows you to have both voice and data services in use simultaneously all over one phone line.

CL-010/CL-010-I ADSL2+ Router is a DSL broadband access device which allows ADSL2+ connectivity capabilities for home or office users. It supports ADSL2/ADSL2+ and is backward compatible to ADSL, even offers auto-negotiation capability for different flavors (G.dmt, G.lite, or T1.413 Issue 2) according to central office DSLAM's settings (Digital Subscriber Line Access Multiplexer). Also the feature-rich routing functions are seamlessly integrated to ADSL2+ service for existing corporate or home users. Now users can enjoy various bandwidth-consuming applications via CL-010/CL-010-I ADSL2+ Router.

Features

ADSL Compliance

- ☒ ANSI T1.413 Issue 2
- ☒ ITU G.992.1 Annex A (G.dmt)
- ☒ ITU G.992.2 Annex A (G.lite)
- ☒ ITU G.994.1 (G.hs)
- ☒ Support dying gasp
- ☒ Maximum Rate: 8 Mbps for downstream and 1 Mbps for upstream

ADSL2 Compliance

- ☒ ITU G.992.3 Annex A (G.dmt)
- ☒ ITU G.992.4 Annex A (G.lite)
- ☒ Maximum Rate: 12 Mbps for downstream and 1 Mbps for upstream

ADSL2+ Compliance

- ☒ ITU G.992.5 Annex A (G.dmt)
- ☒ Maximum Rate: 24 Mbps for downstream and 1.2 Mbps for upstream

ATM Features

- ☒ Compliant to ATM Forum UNI 3.1 / 4.0 Permanent Virtual Circuits (PVCs)
- ☒ Support up to 16 PVCs for UBR, CBR, VBR-nrt, VBR-rt with traffic shaping

- ✧ RFC2684 LLC Encapsulation and VC Multiplexing over AAL5
- ✧ RFC2364 Point-to-Point Protocol (PPP) over AAL5
- ✧ RFC2225 Classical IP and ARP over ATM
- ✧ RFC2516 PPP over Ethernet: support Relay (Transparent Forwarding and Client functions)
- ✧ Support PPPoA or PPPoE Bridged mode (the IP address got from ISP can be passed to the user's PC and behave as the IP address of the user's PC.)
- ✧ OAM F4/F5 End-to-End/Segment Loopback Cells

Bridging Features

- ✧ Supports self-learning bridge specified in IEEE 802.1D Transparent Bridging
- ✧ Supports up to 4096 learning MAC addresses
- ✧ Transparent Bridging among 10/100 Mb Ethernet
- ✧ Support Virtual LAN function specified in IEEE 802.1q

Routing Features

- ✧ Compliance to IPv4 which include RFC791, RFC792, RFC826, RFC768, and RFC793
- ✧ NAT (Network Address Translation) / PAT (Port Address Translation) let multiple users (up to 128) on the LAN to access the Internet for the cost of only one IP address.
- ✧ ALGs (Application Level Gateways): such as NetMeeting, MSN Messenger, FTP, Quick Time, mIRC, Real Player, CuSeeMe, VPN pass-through with multiple sessions, etc.
- ✧ Port Forwarding: the users can setup multiple virtual servers (e.g., Web, FTP, Mail servers) on user's local network.
- ✧ Support DMZ
- ✧ UPnP IGD (Internet Gateway Device) with NAT traversal capability
- ✧ Static routes, RFC1058 RIPv1, and RFC1723 RIPv2
- ✧ DNS Relay, Dynamic DNS
- ✧ DHCP Client/Relay/Server
- ✧ Time protocol can be used to get current time from network time server
- ✧ Support IGMP Proxy/Snoop
- ✧ Support IP/Bridge QoS for prioritize the transmission of different traffic classes
- ✧ Support port mapping function which allows you to assign all data traffic transmitted among specific Internet connections and LAN ports

Security Features

- ✧ PAP (RFC1334), CHAP (RFC1994), and MS-CHAP for PPP session
- ✧ Firewall support IP packets filtering based on IP address/Port number/Protocol type
- ✧ Bridge packet filtering (optional)
- ✧ URL filtering (optional)
- ✧ Support DoS (Deny of Services) which detect & protect a number of attacks (such as SYN/FIN/RST Flood, Smurf, WinNuke, Echo Scan, Xmas Tree Scan, etc)

Configuration and Management

- ✧ User-friendly embedded web configuration interface with password protection
- ✧ Remote management access control via HTTP, TFTP, FTP, Telnet, SSH, SNMP
- ✧ Telnet session for local or remote management

- ⌘ Firmware upgrades through HTTP, TFTP, or FTP
- ⌘ The boot loader contains very simple web page to allow the users to update the run-time firmware image.
- ⌘ Configuration file backup and restore
- ⌘ SNMPv1/v2 agent with MIB-II, ADSL Line MIB

Unpacking

Check the contents of the package against the pack contents checklist below. If any of the items is missing, then contact the dealer from whom the equipment was purchased.

- ⌘ ADSL Router
- ⌘ Power Adapter and Cord
- ⌘ RJ-11 ADSL Line Cable
- ⌘ RJ-45 Ethernet Cable
- ⌘ Quick Start Guide
- ⌘ Driver & Utility Software CD

Subscription for ADSL Service

To use the ADSL Router, you have to subscribe for ADSL service from your broadband service provider. According to the service type you subscribe, you will get various IP addresses:

Dynamic IP: If you apply for dial-up connection, you will be given an Internet account with username and password. You will get a dynamic IP by dialing up to your ISP.

Static IP address: If you apply for full-time connectivity, you may get either one static IP address or a range of IP addresses from your ISP. The number of IP addresses varies according to different ADSL service provider.

Chapter 1: Overview

This chapter provides you the description for the LED and connector for front and rear view of the router. Before you use/install this router, please take a look at this information first.

Physical Outlook

Front Panel

The following illustrations show the front panel of the ADSL Router:

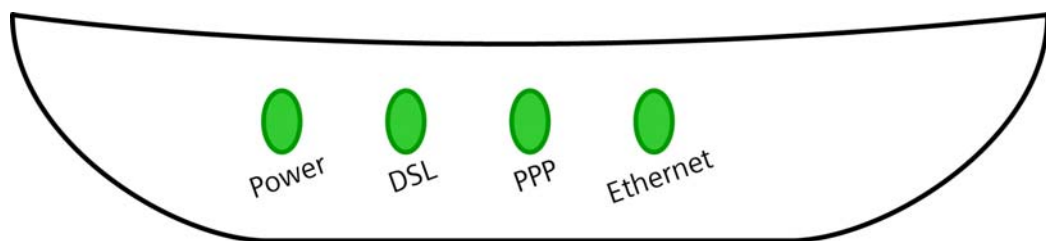

LED Indicators

The ADSL Router is equipped with five LEDs on the front panel as described in the table below (from left to right):

LED	Color	Status	Description
Ethernet	Green	Unlit	Power off or no Ethernet carrier is present.
		Blinking	Ethernet carrier is present and user data is going through Ethernet port.
		Solid	Ethernet carrier is present.
PPP	Green	Unlit	No PPPoA or PPPoE connection
		Solid	At least one PPPoA or PPPoE connection is up. The users can access the Internet now.
DSL	Green	Unlit	Power off or ADSL line connection is handshaking or training is in progress.
		Blinking	User data is going through ADSL port.
		Solid	ADSL line connection is OK.
Power	Green	Unlit	Power off.
		Solid	Power on.

Rear Panel

The following figures illustrate the rear panel of your ADSL Router.

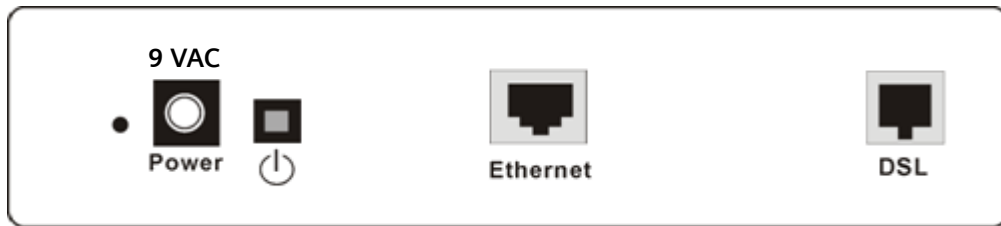

Connector	Description
9VAC	9 VAC Power connector
⏻	Power switch
Ethernet	Ethernet RJ-45 connector
DSL	RJ-11 connector

Chapter 2: System Requirement and Installation

System Requirement

To access the ADSL Router via Ethernet, the host computer must meet the following requirements:

- ❖ With Ethernet network interface.
- ❖ Must have TCP/IP installed.
- ❖ Set client PC with obtain an IP address automatically or set fix IP address.
- ❖ With a web browser installed: Internet Explorer 5.x or later.

The ADSL Router is configured with the **default IP address of 192.168.1.1** and subnet mask of **255.255.255.0**. As the DHCP server is **Enable** by default, The DHCP clients should be able to access the ADSL Router. Or you could assign an IP address to the host PC first for initial configuration.

You also can manage the ADSL Router through a web browser-based manager: **ADSL ROUTER CONTROL PANEL**. The ADSL Router manager uses the HTTP protocol via a web browser to allow you to set up and manage the device.



To configure the device via web browser, at least one properly-configured PC must be connected to the network (either connected directly or through an external hub/switch to the LAN port of the device).

Choosing a place for the ADSL Router

- ❶ Place the ADSL Router close to ADSL wall outlet and power outlet for the cable to reach it easily.
- ❷ Avoid placing the device in places where people may walk on the cables. Also keep it away from direct sunlight or heat sources.
- ❸ Place the device on a flat and stable stand.

Connecting the ADSL Router

Follow the steps below to connect the related devices.

- 1 Connecting the ADSL line. Connect the DSL port of the device to your ADSL wall outlet with RJ-11 cable.

- 2 Please attach one end of the Ethernet cable with RJ-45 connector to the **LAN** port of your ADSL Router.

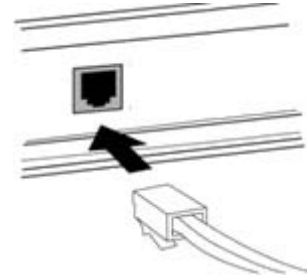

- 3 Connect the other end of the cable to the Ethernet port of the client PC.

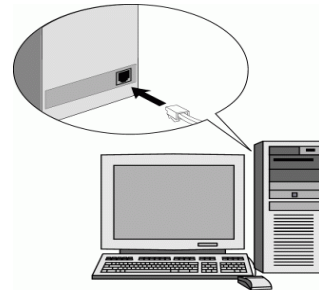

- 4 Connect the supplied power adapter to the **PWR** port of your ADSL Router, and plug the other end to a power outlet.

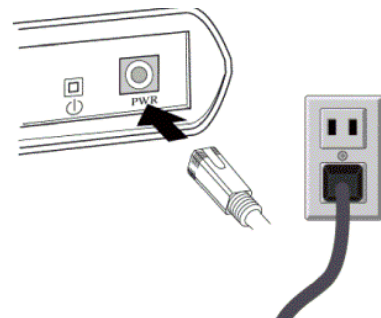

- 5 Turn on the power switch.

For connecting through a hub, please refer to the following diagram for an example.

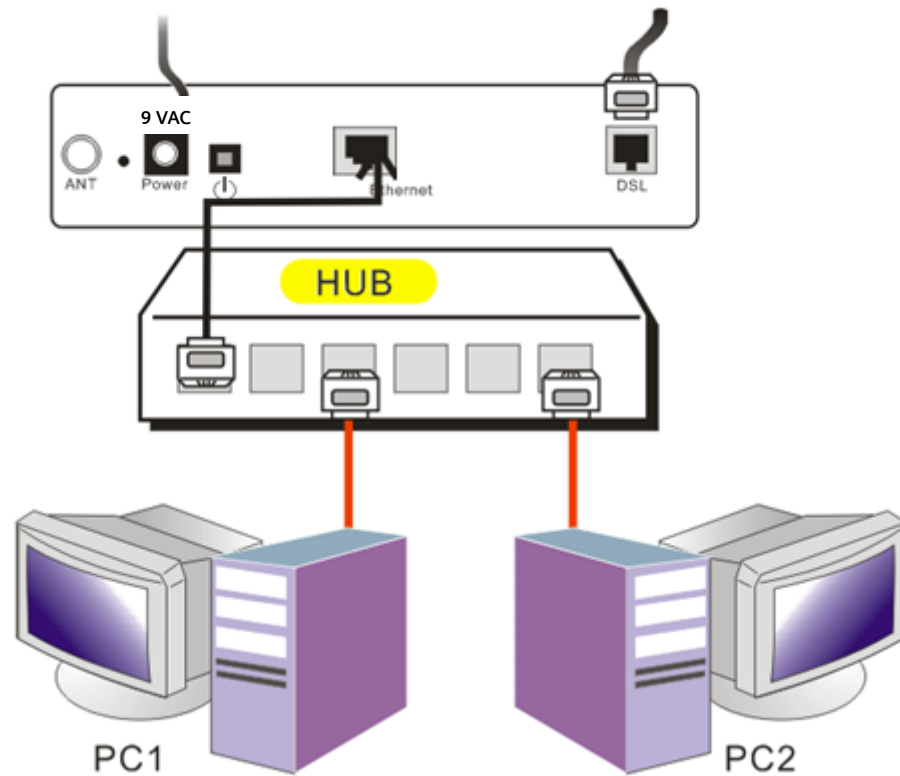

Setting TCP/IP



In order to access the Internet through the router, each host on your network must install/setup TCP/IP. Please follow the steps below for select a network adapter.

For Windows 98

1. Click on the **Start** menu, point to **Settings** and click on **Control Panel**.

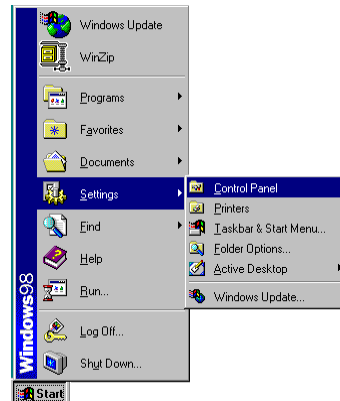

2. Double-click the **Network** icon

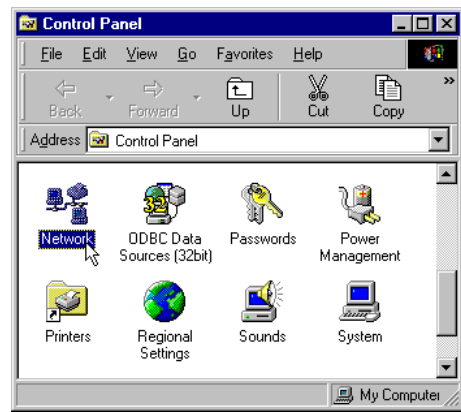

3. The **Network** window appears. On the **Configuration** tab, check out the list of installed network components.

Option 1: If you have **no** TCP/IP protocol, click **Add**.

Option 2: If you have TCP/IP protocol, go to Step 6

Your network interface card.

Check out if TCP/IP for your NIC is installed or not.

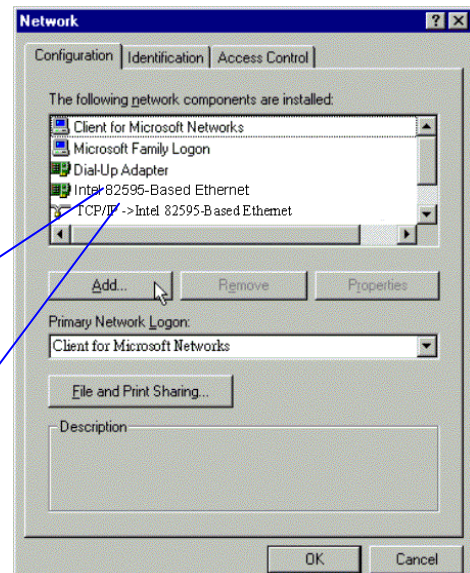

4. Highlight **Protocol** and click **Add**.

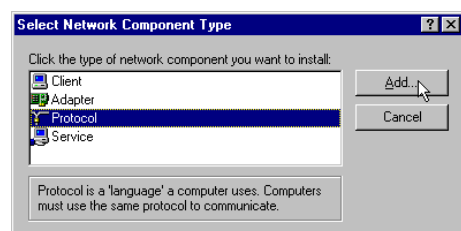

5. On the left side of the windows, highlight **Microsoft** and then select **TCP/IP** on the right side. Then click **OK**

6. When returning to **Network** window, highlight **TCP/IP** protocol for your NIC and click **Properties**.

7. On **IP Address** tab:
 - Enable **Specify an IP address** option.
 - Enter the **IP Address**: 192.168.1.x (x is between 2 and 254) and **Subnet Mask**: 255.255.255.0 as in figure below. On **Gateway** tab: Add a gateway IP address: 192.168.1.1 and click **OK**

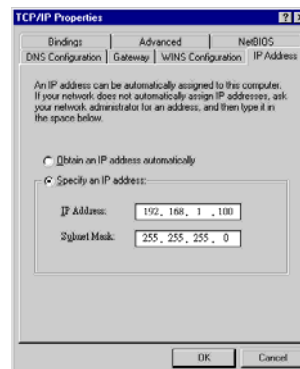
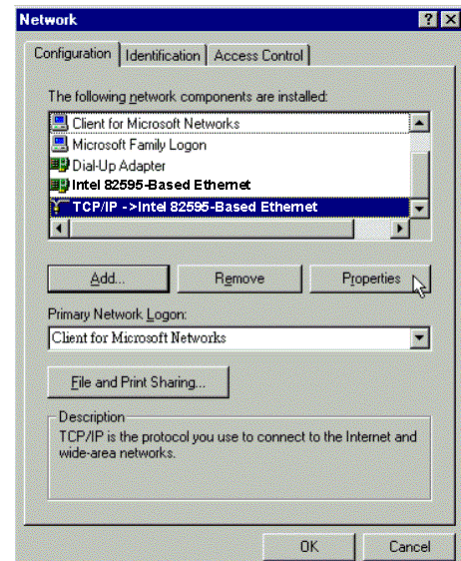
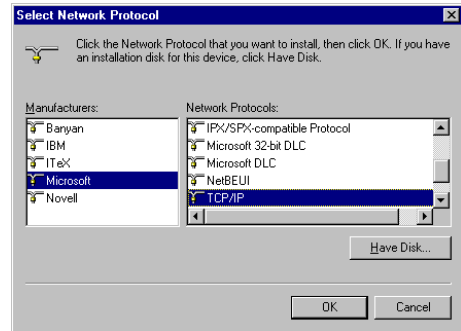

8. When returning to **Network** window, click **OK**

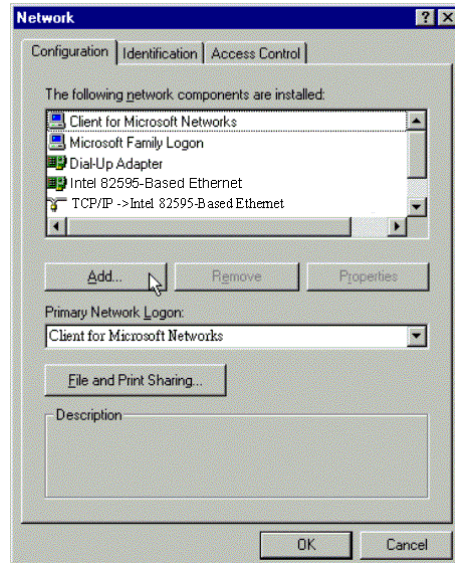

9. Wait for Windows copying files.

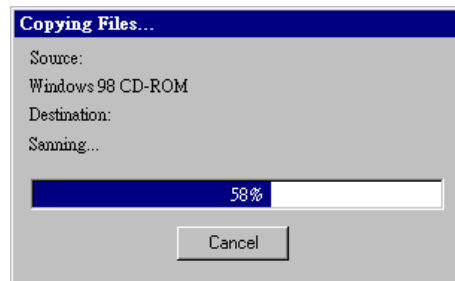

10. When prompted with **System Settings Change** dialog box, click **Yes** to restart your computer.

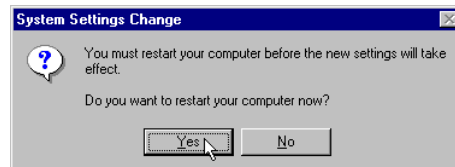

For Windows ME

1. Click on the **Start** menu, point to **Settings** and click on **Control Panel**.
2. Double-click the **Network** icon.
3. The **Network** window appears. On the **Configuration** tab, check out the list of installed network components.
Option 1: If you have **no** TCP/IP protocol, click **Add**.
Option 2: If you have TCP/IP protocol, go to Step 6.
4. Highlight **Protocol** and click **Add**.
5. On the left side of the windows, highlight **Microsoft** and then select **TCP/IP** on the right side. Then click **OK**.
6. While returning to **Network** window, highlight **TCP/IP** protocol for your NIC and click **Properties**.

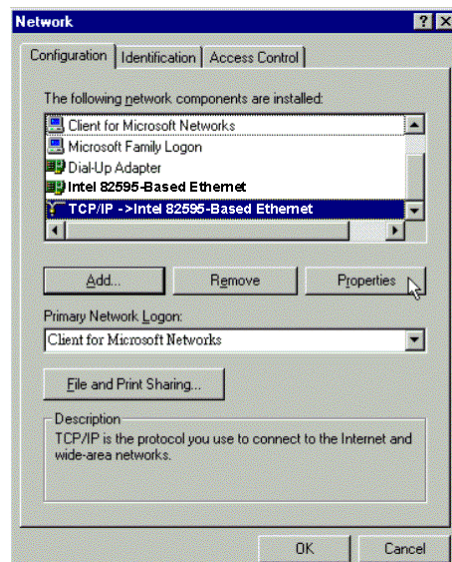

7. On the **IP Address** tab, select **Specify an IP address**. Enter the **IP address: 192.168.1.x** (x is between 2 and 254), **Subnet Mask: 255.255.255.0** and **Default gateway: 192.168.1.1**. Then click **OK**.

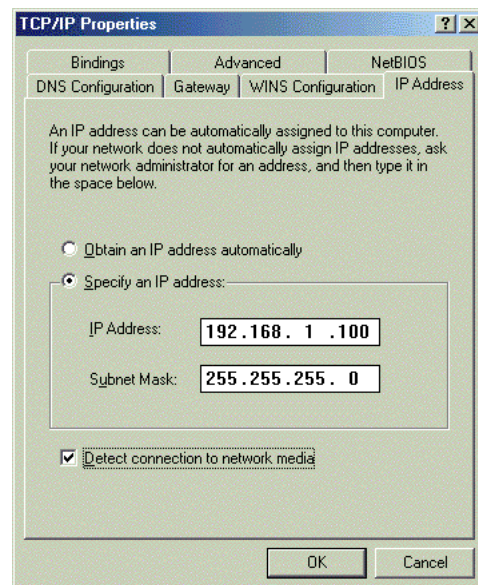

8. While returning to the **Network** window, click **OK**.

9. Wait for Windows copying files.
10. When prompted with the **System Settings Change** dialog box, click **Yes** to restart your computer.

For Windows NT

1. Click **Start**, point to **Settings**, and then click **Control Panel**.

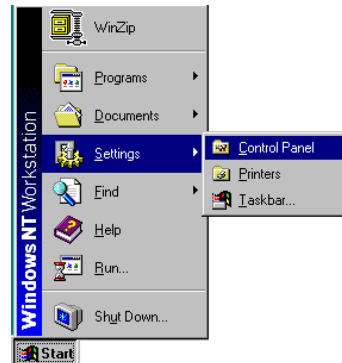

2. Double-click the **Network** icon.

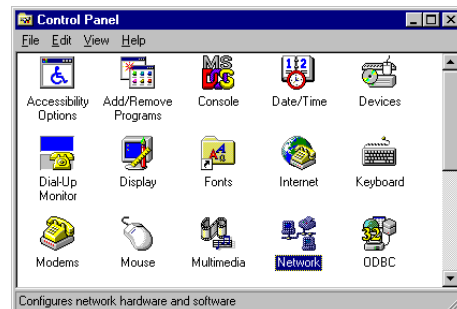

3. The **Network** window appears. On the **Protocols** tab, check out the list of installed network components.
Option 1: If you have **no** TCP/IP Protocol, click **Add**.
Option 2: If you have TCP/IP Protocol installed, go to Step 7.

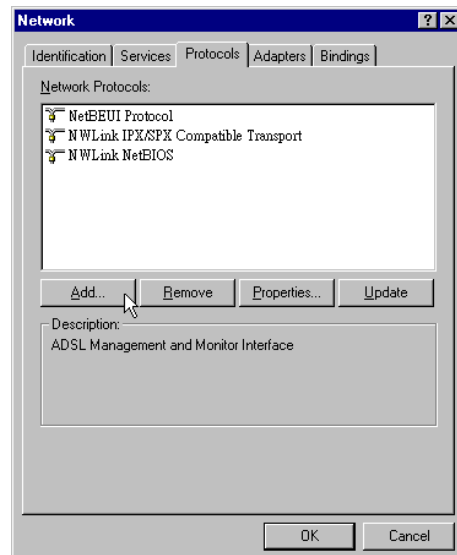

4. Highlight **TCP/IP Protocol** and click **OK**.

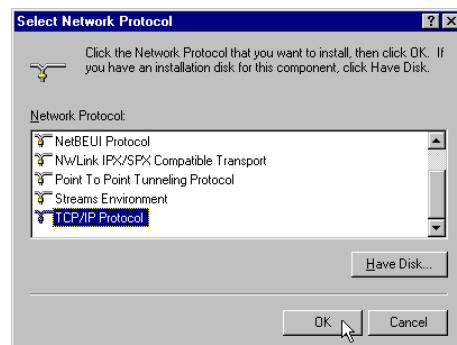

5. Click **Yes** to use DHCP.
6. Insert the Windows NT CD into your CD-ROM drive and type the location of the CD. Then click **Continue**.
7. Returning to the **Network** window, you will find the **TCP/IP Protocol** among the list. Select **TCP/IP Protocol** and click **Properties**.
8. Enable **Specify an IP address** option. Enter the **IP Address**: 192.168.1.x (x is between 2 and 254) and **Subnet Mask**: 255.255.255.0 and **Default Gateway**: 192.168.1.1 as in figure below.

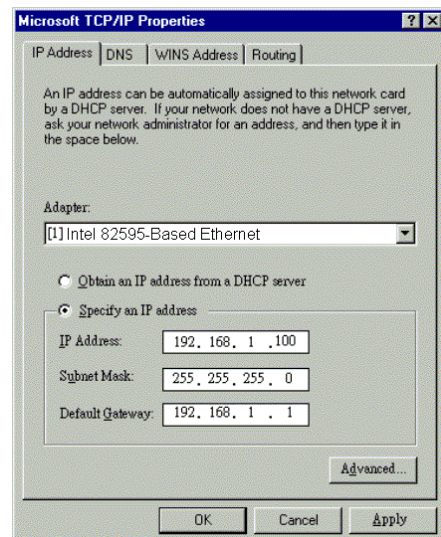
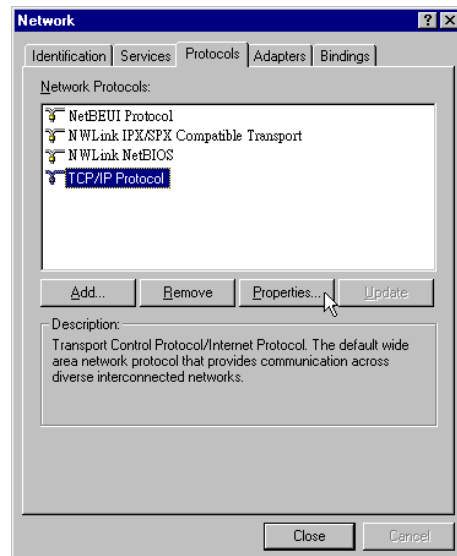
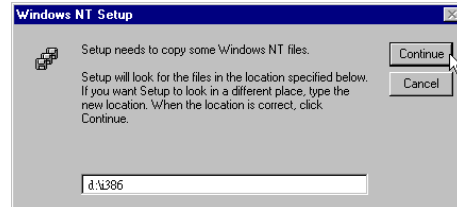
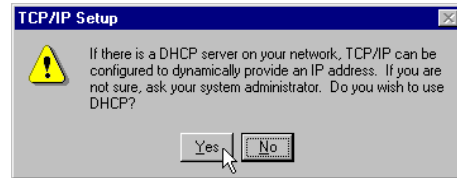

9. When returning to **Network** window, click **Close**.

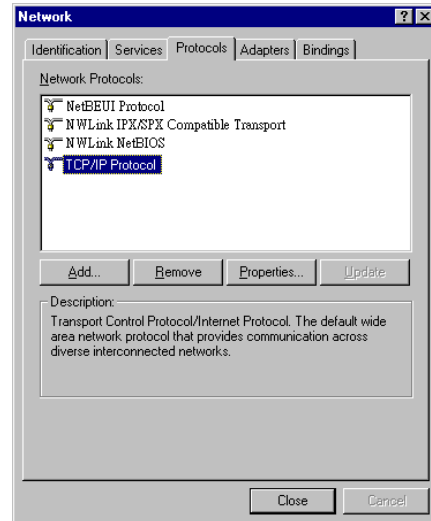

10. When prompted with **Network Settings Change** dialog box, click **Yes** to restart your computer.

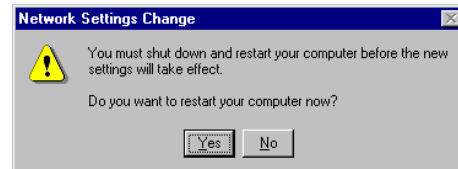

For Windows 2000

1. From the Start menu, point to Settings and then click Network and Dial-up Connections.

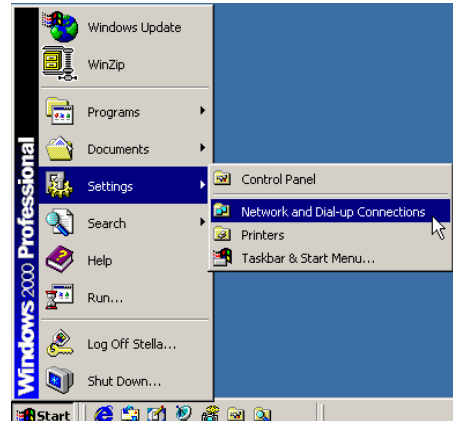

2. Right-click the **Local Area Connection** icon and then click **Properties**.

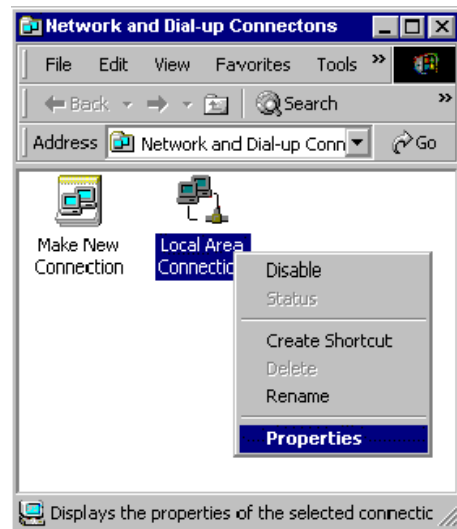

3. On the **General** tab, check out the list of installed network components.

Option 1: If you have **no** TCP/IP Protocol, click **Install**.

Option 2: If you have TCP/IP Protocol, go to Step 6.

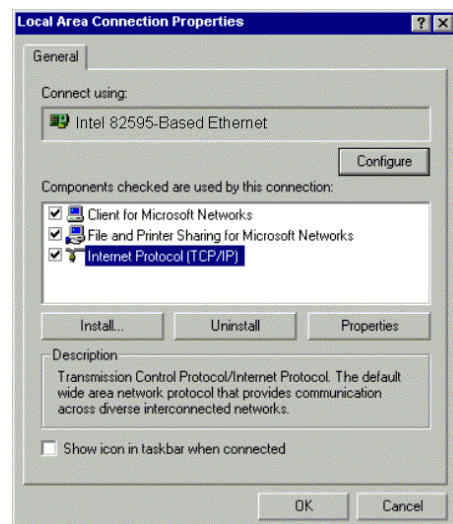

4. Highlight **Protocol** and then click **Add**.

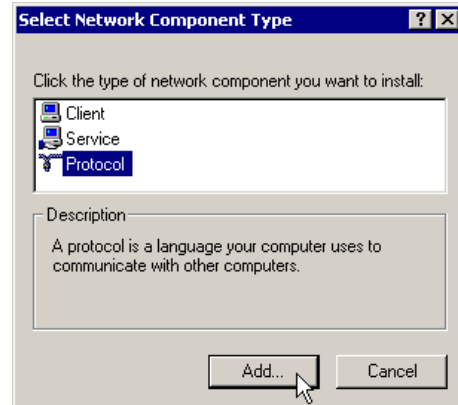

5. Click **Internet Protocol (TCP/IP)** and then click **OK**.

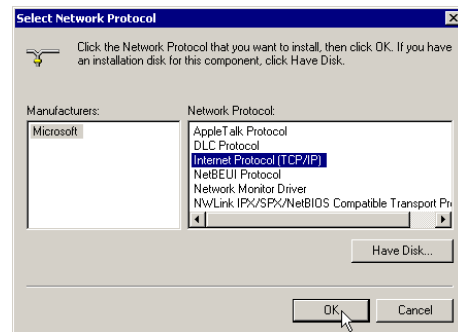

6. When returning to Local Area Connection Properties window, highlight **Internet Protocol (TCP/IP)** and then click **Properties**.

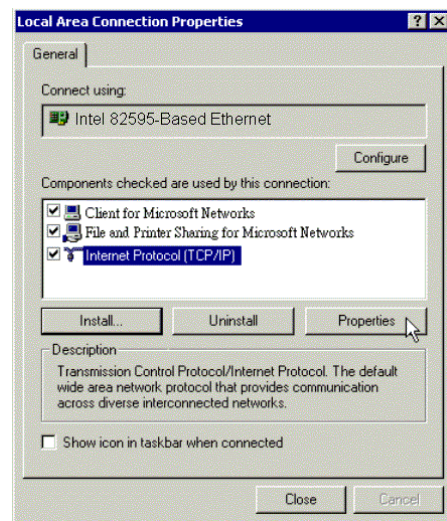

7. Under the **General** tab, enable **Use the following IP Address**. Enter the **IP address: 192.168.1.x** (x is between 2 and 254), **Subnet Mask: 255.255.255.0** and **Default gateway: 192.168.1.1**. Then click **OK**.

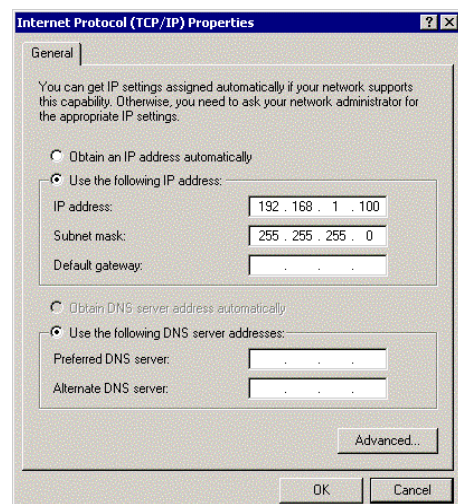

For Windows XP

From the **Start** menu, point to **Control Panel** and then click **Network and Internet Connections**.

Click **Network Connection** and then click **Properties**.

Click **Network Connection** and then click **Properties**.3.On the **General** tab, check out the list of installed network components.

Option 1: If you have **no** TCP/IP Protocol, click **Install**.

Option 2: If you have TCP/IP Protocol, go to Step 6.

Highlight **Protocol** and then click **Add**.

Click **Internet Protocol(TCP/IP)** and then click **OK**.

On the **Local Area Connection Properties** window, highlight **Internet Protocol (TCP/IP)** and then click **Properties**.

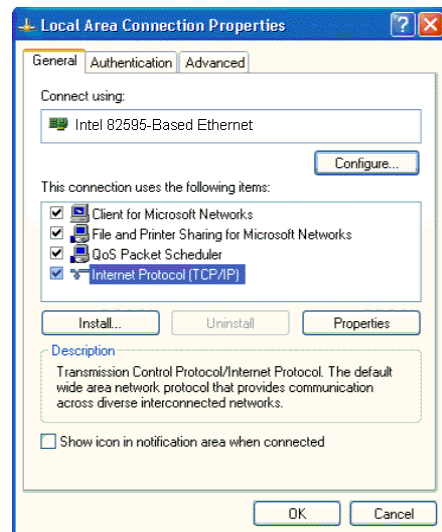

Under the **General** tab, enable **Use the following IP address**. Enter the **IP address: 192.168.1.x** (x is between 2 and 254), **Subnet Mask: 255.255.255.0** and **Default gateway: 192.168.1.1**. Then click **Ok**.

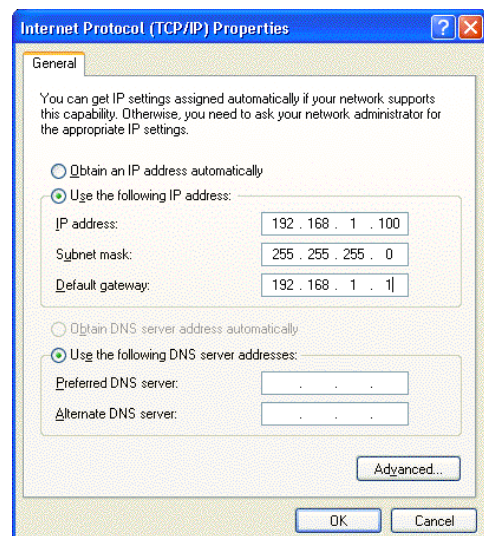

For Windows Vista

8. Open the **Start** menu, point to **Control Panel** and click it.

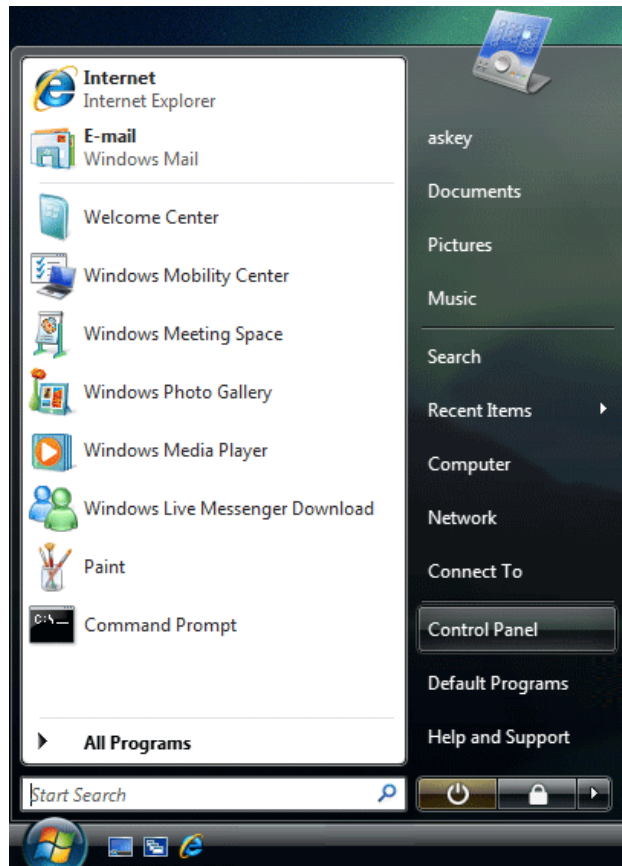

9. Click **Network and Internet**.

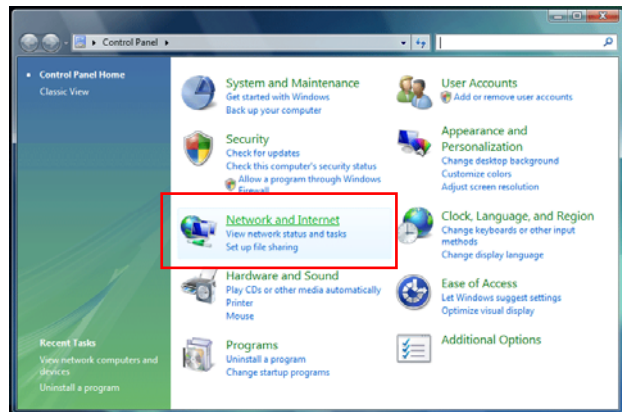

10. Select **Network and Sharing Center**.



11. Click **Manage Network Connection** on the left side.

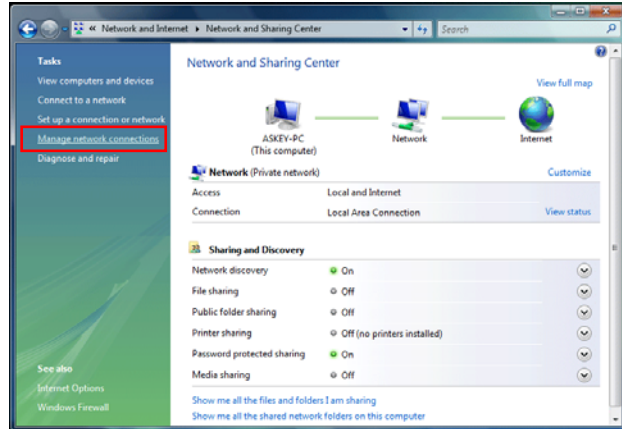

12. Right click **Local Area Connection** and select **Properties**.

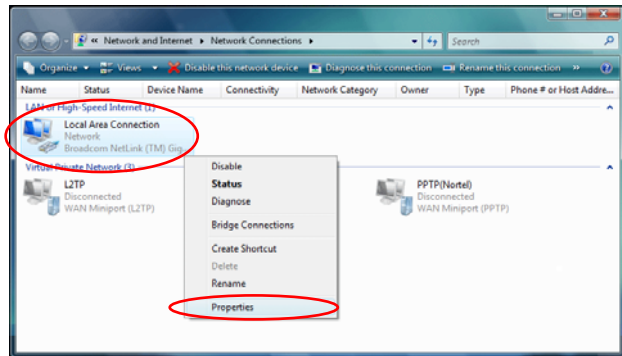

13. On the **Networking** tab, you will find Internet Protocol Version 6 and Version 4. Contact your ISP to confirm which one will be used. (We take TCP/IPv4 for example here.)
Select **Internet Protocol Version 4 (TCP/IPv4)** and press **Properties**.

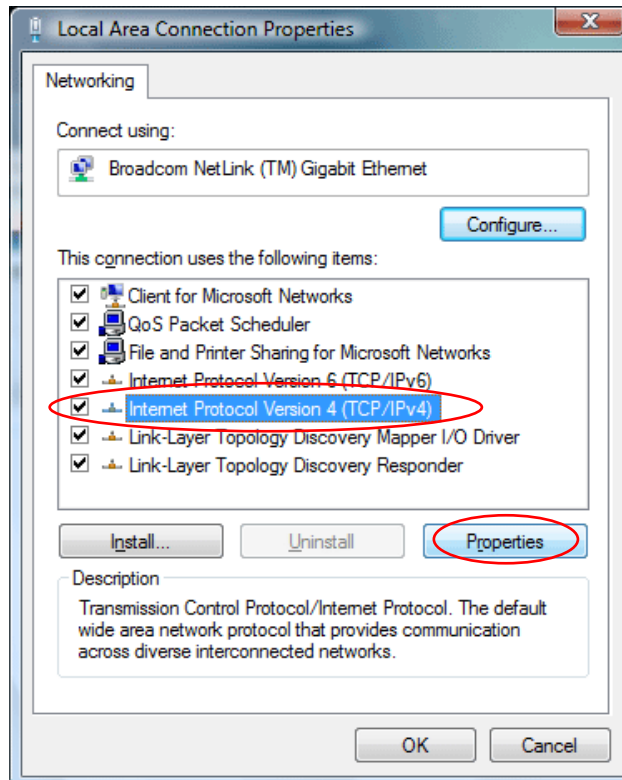

14. Under the **General** tab, enable **Use the following IP address**. Enter the **IP address: 192.168.1.x** (x is between 2 and 254), **Subnet Mask: 255.255.255.0** and **Default gateway: 192.168.1.1**. Then click Ok.

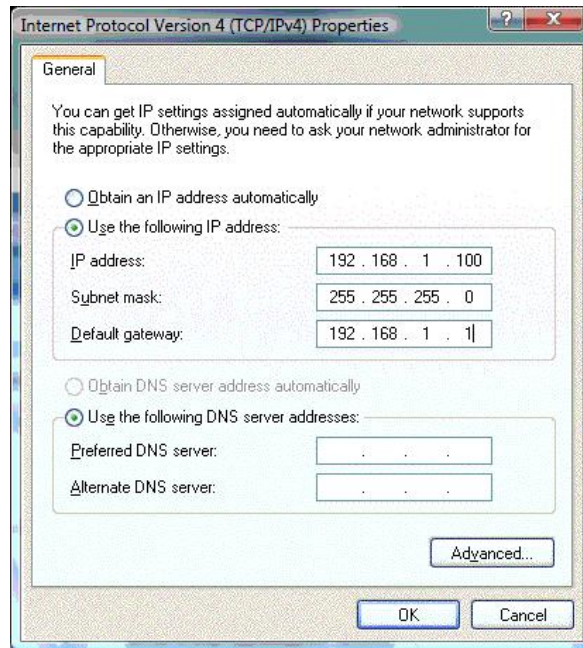

Renewing IP Address on Client PC

After the ADSL Router gets on line, there is a chance that your PC does not renew its IP address and thus causes the PC not able to access the Internet. To solve this problem, please follow the procedures below to renew PC's IP address.

Configure PC to get IP address from DHCP

If your ADSL Router operates as a DHCP server for the client PCs on the LAN, you should configure the client PCs to obtain a dynamic IP address. Please follow the previous section to install TCP/IP component. Only that you do not need to specify an IP address when configuring TCP/IP properties.

The following section describe the procedures for CPEs to get IP address:

For Windows 98

On the **IP Address** tab, select **Obtain an IP address automatically**. Then click **OK**.

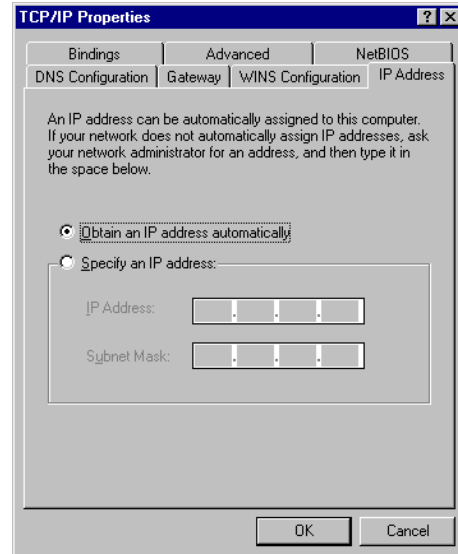

For Windows ME

On the **IP Address** tab, select **Obtain an IP address automatically**. Then click **OK**.

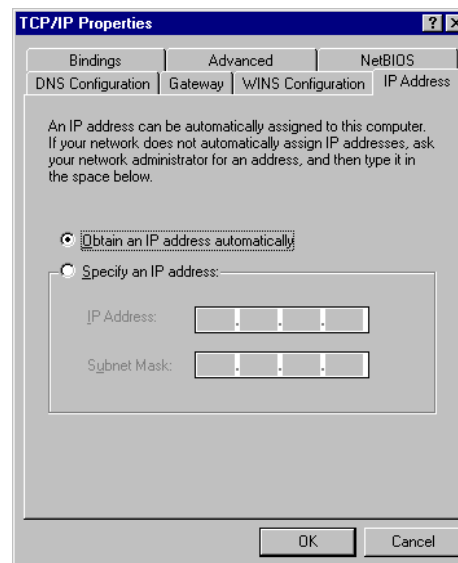

For Windows NT

On the **IP Address** tab, click on the drop-down arrow of **Adapter** to select required adapter. Enable **Obtain an IP address from a DHCP server** and then click **OK..**

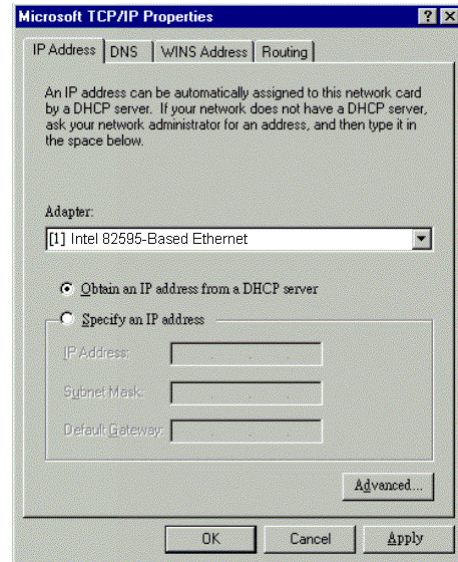

When prompted with the message below, click **Yes** to continue.

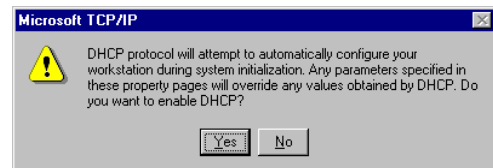

For Windows 2000

Enable **Obtain an IP address automatically** and then click **OK.**

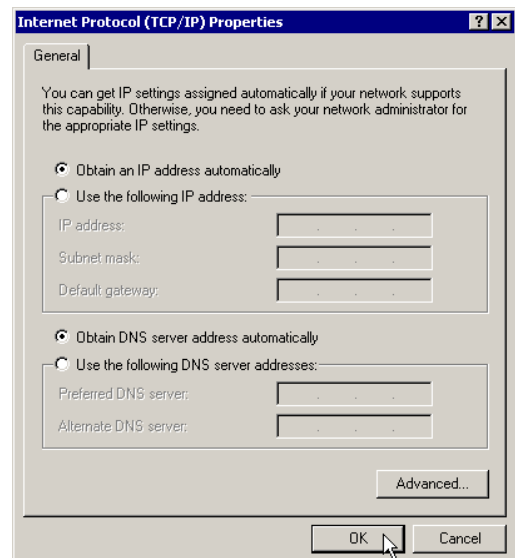

For Windows XP

On the **IP Address** tab, select **Obtain an IP address automatically**. Then click **OK**.

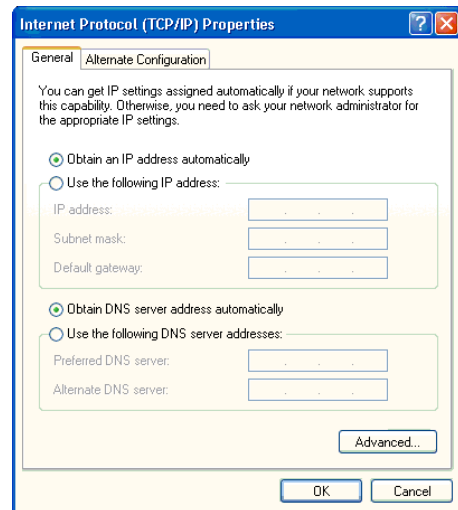

Windows Vista

On the **IP Address** tab, select **Obtain an IP address automatically**. Then click **OK**.

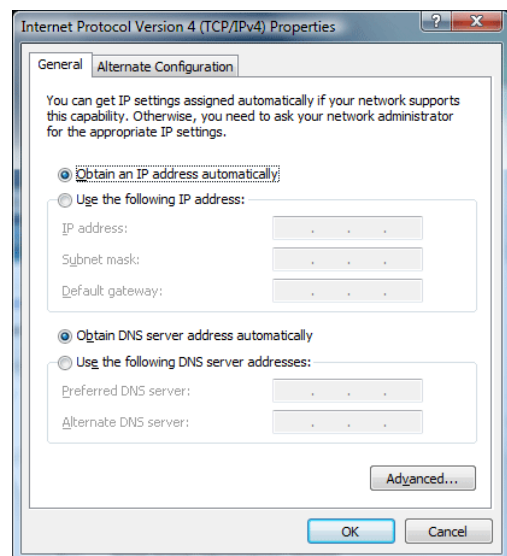

Renew IP Address on Client PC

There is a chance that your PC does not renew its IP address after the ADSL Router is on line and the PC cannot access the Internet. Please follow the procedures below to renew PC's IP address.

For Windows 98ME

1. Select **Run** from the **Start** menu.

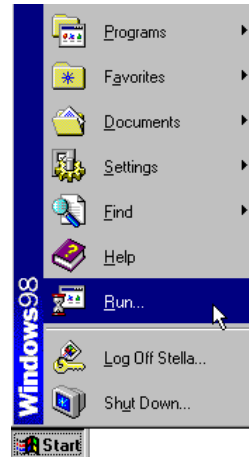

2. Type **wiipcfg** in the dialog box and the click **OK**.

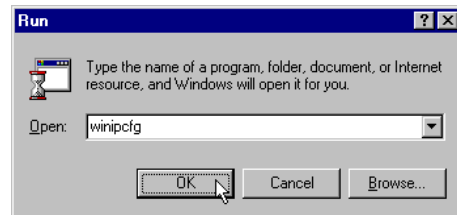

3. When the figure below appears, click Release and then Renew to get an IP address.

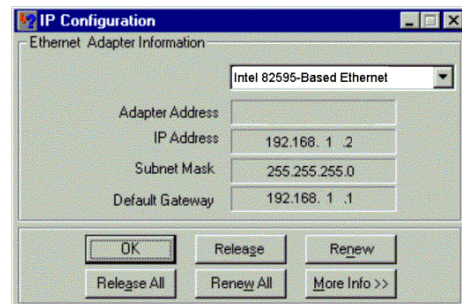

For Windows NT

1. Select **Run** from the **Start** menu.

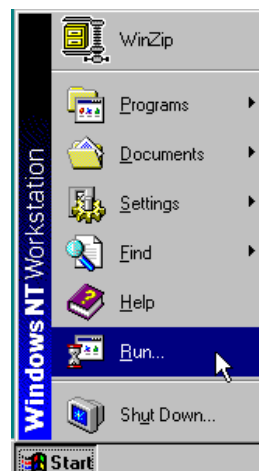

2. Select **Run** from the **Start** menu.
3. Type **cmd** in the dialog box and the click **OK**.



4. Type **ipconfig** at prompt. Then you will see the IP information from DHCP server.
5. If you want to get a new IP address, type **ipconfig /release** to release the previous IP address and then type **ipconfig /renew** to get a new one.

For Windows 2000

1. From the **Start** menu, point to **Programs, Accessories** and then click **Command Prompt**.
2. Type **ipconfig** at prompt. Then you will see the IP information from DHCP server.
3. If you want to get a new IP address, type **ipconfig /release** to release the previous IP address and then type **ipconfig /renew** to get a new one.

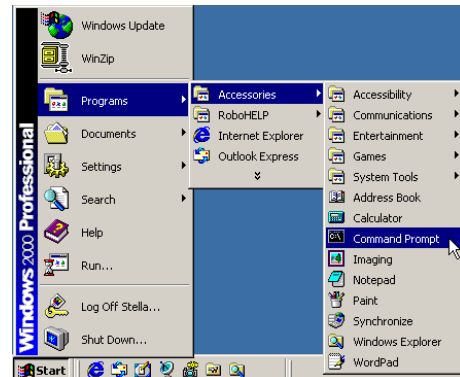

For Windows XP

1. Type **ipconfig** at prompt. Then you will see the IP information from DHCP server.
2. From the **Start** menu, point to **Programs, Accessories** and then click **Command Prompt**.
3. Type **ipconfig** at prompt. Then you will see the IP information from DHCP server.
4. If you want to get a new IP address, type **ipconfig /release** to release the previous IP address and then type **ipconfig /renew** to get a new one.

For Windows Vista

1. Open the **Start** menu, and type **cmd** in the text box then click **OK**.

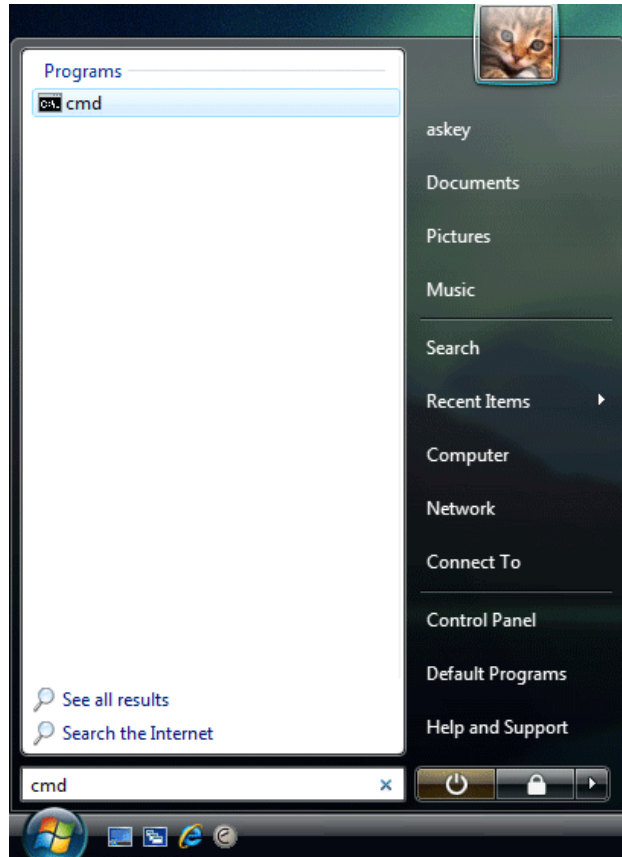

2. The command prompt window will appear.



3. Type **ipconfig** at the command window and press **Enter** to view the computer's IP information from DHCP server.

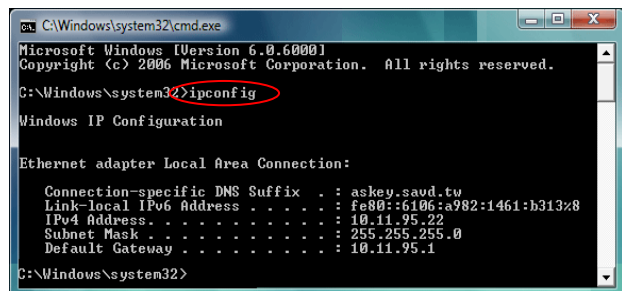

4. If the computer is holding a current IP address, type **ipconfig /release** to let go of the address, then type **ipconfig /renew** to obtain a new one.

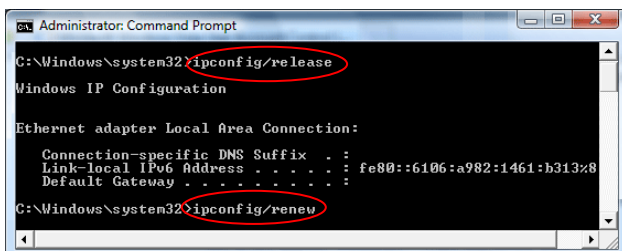

Note:

If you cannot release the IP address successfully and see the message “**The requested operation requires elevation.**” please go to the **Start** menu and right click **Command Prompt**, then set **Run as administrator**.

Press **Continue** when a dialog asking for permission to continue prompts.

After then, repeat the above instruction to release and renew the IP address.

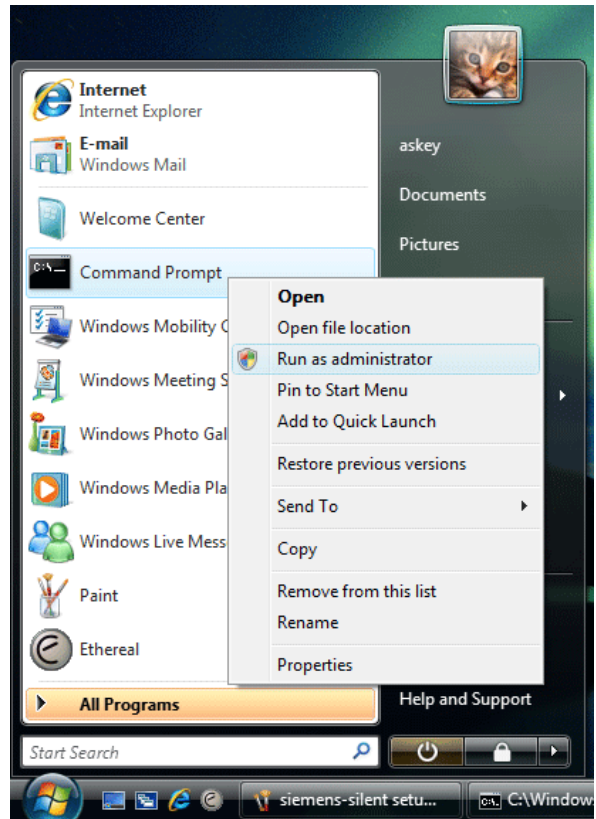

Chapter 3: Connecting and Accessing Internet



This chapter is to help you accessing into Internet with a quick and convenient way. If you need more detailed information for web configuration, please get into the next chapter for the advanced configuration.

Prior to configuring the ADSL Router, you must decide whether to configure the ADSL Router as a bridge or as a router. This chapter presents some deployment examples for your reference. Each mode includes its general configure procedures. For more detailed information about web configuration, refer to "Web Configuration".

- PPP over ATM (PPPoA)
- PPPoA IP Extension
- PPP over Ethernet (PPPoE)
- PPPoE IP Extension
- Numbered IP over ATM (IPoA)
- Numbered IP over ATM (IPoA)+NAT
- Unnumbered IP over ATM (IPoA)
- Unnumbered IP over ATM (IPoA)+NAT
- Bridging

For making sure that you can connect the ADSL to your computer well and get into Internet successfully, please make sure the following first.

- Make sure you have installed a network interface card into your computer.
- Make sure the connection between the ADSL and your computer is OK.
- Check to see the TCP/IP protocol and set the IP address as "Auto Get IP Address".

When you are sure all above is Ok, you can open the Browser and type in "192.168.1.1" and start to do the web configuration with different connection modes.

This chapter is going to introduce the function of each connection mode and tell you the basic configuring steps that you have to do. If you did not follow the configuring steps for using these connection modes, you might get some connection problems and cannot connect to Internet well.

PPP over ATM (PPPoA) Mode

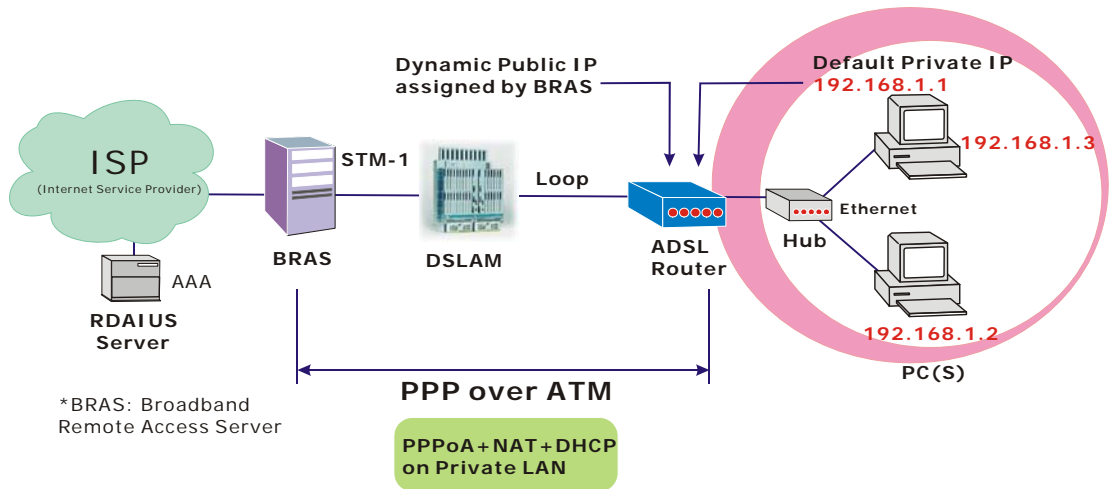

Description:

In this deployment environment, the PPPoA session is between the ADSL WAN interface and BRAS. The ADSL Router gets a public IP address from BRAS when connecting to DSLAM. The multiple client PCs will get private IP address from the DHCP server enabled on private LAN. The enabled NAT mechanism will translate the IP information for clients to access the Internet.

Configuration:

1. Start up your browser and type **192.168.1.1** as the address to enter this ADSL web-based manager.
2. Go to **Quick Start -Quick Setup**. Uncheck **Auto Scan Internet Connection (PVC)**. Type in the **VCI** and **VPI** value. Then click the **Next** button. eg:
VPI – 0
VCI – 38
3. On the **Configure Internet Connection -Connection Type** page, select the **PPP over ATM (PPPoA)** then click the **Next** button.
4. In the **WAN IP Settings** page, select **Obtain an IP address automatically** and check **Enable NAT** box. Click **Next**.
5. In the **PPP Username and Password** page, enter the PPP username and password that you got from your ISP. Select **Dial on Demand** and type in the number for inactivity timeout. The default is 20. Or select **Always on**. Then click **Next**.
6. In the **Configure LAN side Settings** page, type in the IP address and subnet mask for your LAN. Check **DHCP Server on** box. And type in the start and end points. Then type in the leased time that you want. And click **Next**. eg:
Primary IP address:192.168.1.1
Subnet Mask:255.255.255.0
Start IP Address:192.168.1.2
End IP Address: 192.168.1.254
7. Check the network information. Make sure the settings match the settings provided by ISP. Click **Finish**.

PPP over Ethernet (PPPoE) Mode

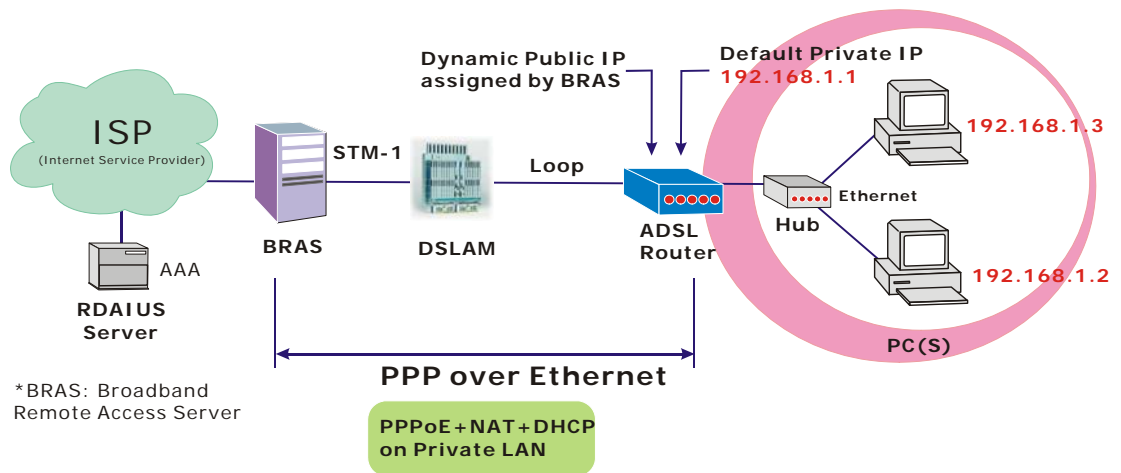

Description:

In this deployment environment, the PPPoE session is between the ADSL WAN interface and BRAS. The ADSL Router gets a public IP address from BRAS when connecting to DSLAM. The multiple client PCs will get private IP address from the DHCP server enabled on private LAN. The enabled NAT mechanism will translate the IP information for clients to access the Internet.

Configuration:

1. Start up your browser and type **192.168.1.1** as the address to enter this ADSL web-based manager.
2. Go to **Quick Start -Quick Setup**. Uncheck **Auto Scan Internet Connection (PVC)**. Type in the **VCI** and **VPI** value. Then click the **Next** button. eg:
VPI – 0
VCI – 39
3. On the **Configure Internet Connection -Connection Type** page, select the **PPP over Ethernet (PPPoE)** then click the **Next** button.
4. In the **WAN IP Settings** page, select **Obtain an IP address automatically** and check **Enable NAT** box. Click **Next**.
5. In the **PPP Username and Password** page, enter the PPP username and password that you got from your ISP. Select **Dial on Demand** and type in the number for inactivity timeout. The default is 20. Or select **Always on**. Then click **Next**.
6. In the **Configure LAN side Settings** page, type in the IP address and subnet mask for your LAN. Check **DHCP Server on** box. And type in the start and end points. Then type in the leased time that you want. And click **Next**. eg:
Primary IP address:192.168.1.1
Subnet Mask:255.255.255.0
Start IP Address:192.168.1.2
End IP Address: 192.168.1.254
7. Check the network information. Make sure the settings match the settings provided by ISP. Click **Finish**.

PPP over Ethernet (PPPoE) IP Extension Mode

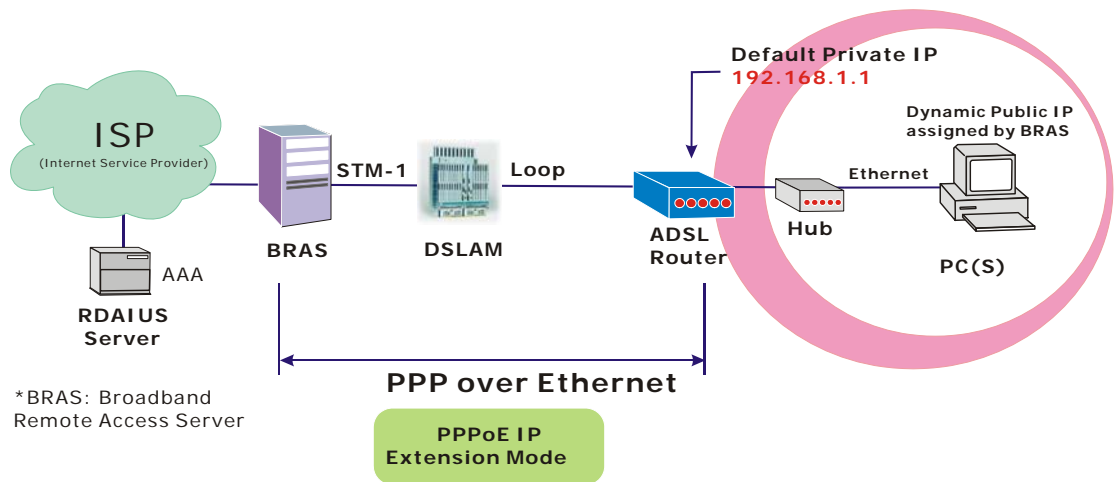

Description:

In this deployment environment, the PPPoE session is between the ADSL WAN interface and BRAS. The ADSL Router acts as a bridge and gets a public IP address from BRAS for your computer. And only the one that got the public IP address is allowed to access into Internet. The real IP that you got is acquired from ISP. Moreover, no NAT translation will be done at this case.

Configuration:

1. Start up your browser and type **192.168.1.1** as the address to enter this ADSL web-based manager.
2. Go to **Advanced - Internet - Connections**. And click **Add**.
3. Type in the **VCI** and **VPI** value. Then click the **Next** button. eg:
VPI – 0
VCI – 39
4. On the **Configure Internet Connection -Connection Type** page, select the **PPP over Ethernet (PPPoE)** then click the **Next** button.
5. In the **WAN IP Settings** page, select **Obtain an IP address automatically**, uncheck **Enable NAT** box and check **PPP IP extension** then click **Next**.
6. In the **PPP Username and Password** page, enter the PPP username and password that you got from your ISP. Select **Dial on Demand** and type in the number for inactivity timeout. The default is 20. Or select **Always on**. Then click **Next**.
7. In the **Configure LAN side Settings** page, type in the IP address and subnet mask for your LAN. And click **Next**. eg:
Primary IP address:192.168.1.1
Subnet Mask:255.255.255.0
8. Check the network information. Make sure the settings match the settings provided by ISP. Click **Finish**.

Numbered IP over ATM (IPoA)

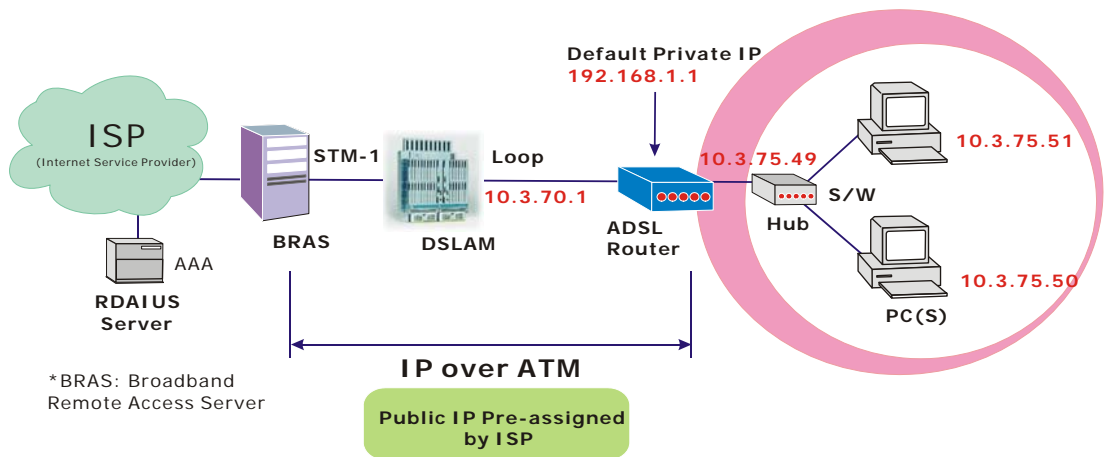

Description:

If you apply for multiple IP addresses from your ISP, you can assign these public IP addresses to the ADSL Router and public server, e.g., Web or FTP server. Typically the first IP is network address, the second is used as router IP address and the last one is subnet broadcasting. Other remaining IP addresses can be assigned to PCs on the LAN.

The following example uses the LAN IP address ranging from 10.3.75.49 to 10.3.75.54 and the subnet mask for LAN is 255.255.255.248. The WAN address is 10.3.70.1, and the subnet mask for WAN is 255.255.255.252.

Configuration:

1. Start up your browser and type **192.168.1.1** as the address to enter this ADSL web-based manager.
2. Go to **Quick Start -Quick Setup**. Uncheck **Auto Scan Internet Connection (PVC)**. Type in the **VCI** and **VPI** value. Then click the **Next** button.
VPI – 0
VCI – 32
3. On the **Configure Internet Connection -Connection Type** page, select the **IP over ATM (IPoA)** then click the **Next** button.
4. In the **WAN IP Settings** page, select **Use the following IP address** and type in the IP address, subnet mask and gateway that you got from ISP. Then, select **Use the following DNS Server Address**. Type in the Primary DNS server and Secondary DNS server. Uncheck **Enable NAT**. Click **Next** for next page.
WAN IP Address: 10.3.70.1
WAN Subnet Mask: 255.255.255.252
Primary DNS server: 168.95.1.1
Secondary DNS server: 168.95.192.1
5. In the **Configure LAN side Settings** page, type in the IP address and subnet mask for your LAN.
Primary IP Address: 192.168.1.1
Subnet mask: 255.255.255.0
Start IP Address: 192.168.1.2
End IP Address: 192.168.1.254
6. Check **Configure the second IP Address and Subnet Mask for LAN Interface** and type in the second IP address and subnet mask. Then click **Next**.
Secondary IP Address: 10.3.75.49
Subnet mask: 255.255.255.248

7. Check the network information. Make sure the settings match the settings provided by ISP. Click **Finish**.
8. Set TCP/IP for your computer. Specify an IP Address, subnet mask and set default gateway. eg:
IP Address: 10.3.75.51
Subnet Mask: 255.255.255.248
Gateway: 10.3.75.49
9. Now the router is well configured. You can access into Internet.

Numbered IP over ATM (IPoA) + NAT

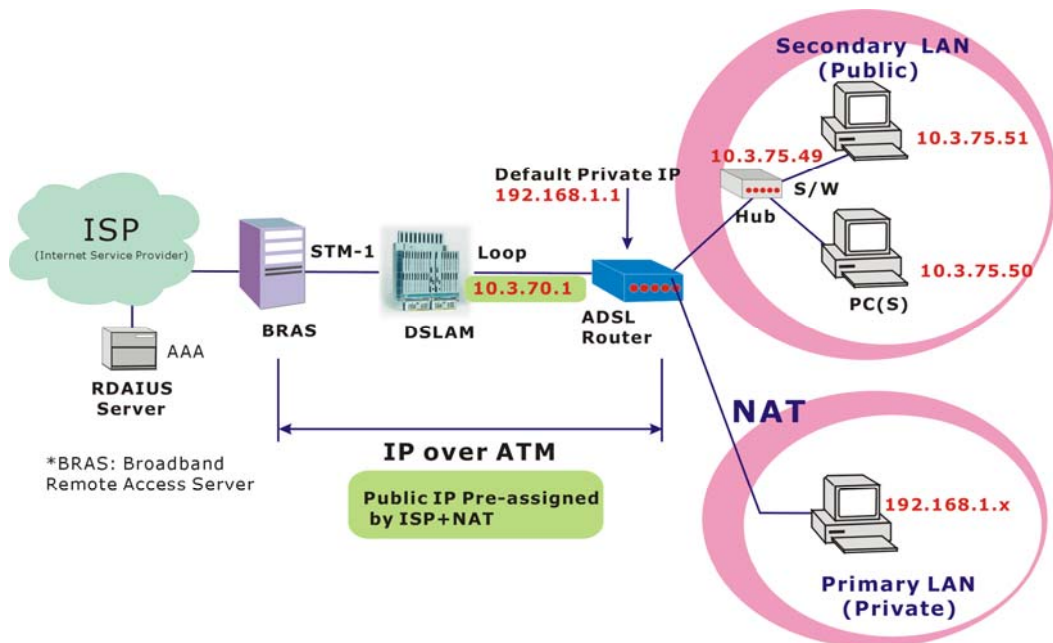

Description:

In this deployment environment, we make up a private IP network of 192.168.1.1. NAT function is enabled (on ADSL Router or use another NAT box connected to hub) to support multiple clients to access the Router and some public servers (WWW, FTP).

If you apply for multiple IP addresses from your ISP, you can assign these public IP addresses to the ADSL Router and public server, e.g., Web or FTP server. Typically the first IP is network address, the second is used as router IP address and the last one is subnet broadcasting. Other remaining IP addresses can be assigned to PCs on the LAN.

The following example uses the LAN IP address ranging from 10.3.75.49 to 10.3.75.54 and the subnet mask for LAN is 255.255.255.248. The WAN address is 10.3.70.1, and the subnet mask for WAN is 255.255.255.252.

Configuration:

1. Start up your browser and type **192.168.1.1** as the address to enter this ADSL web-based manager.
2. Go to **Quick Start -Quick Setup**. Uncheck **Auto Scan Internet Connection (PVC)**. Type in the **VCI** and **VPI** value. Then click the **Next** button.
VPI – 0
VCI – 32
3. On the **Configure Internet Connection -Connection Type** page, select the **IP over ATM (IPoA)** then click the **Next** button.
4. In the **WAN IP Settings** page, select **Use the following IP address** and type in the IP address, subnet mask and gateway that you got from ISP. Then, select **Use the following DNS Server Address**. Type in the Primary DNS server and Secondary DNS server.
WAN IP Address: 10.3.70.1
WAN Subnet Mask: 255.255.255.252
Primary DNS server: 168.95.1.1
Secondary DNS server: 168.95.192.1
5. Check the **Enable NAT** box. And click **Next**.
6. In the **Configure LAN side Settings** page, type in the IP address and subnet mask for your

LAN.

Primary IP Address: 192.168.1.1

Subnet mask: 255.255.255.0

Start IP Address: 192.168.1.2

End IP Address: 192.168.1.254

7. Check **Configure the second IP Address and Subnet Mask for LAN Interface** and type in the second IP address and subnet mask. Then click **Next**.
Secondary IP Address: 10.3.75.49
Subnet mask: 255.255.255.248
8. Check the network information. Make sure the settings match the settings provided by ISP. Click **Finish**.
9. Now the router is well configured. You can access into Internet.

Unnumbered IP over ATM (IPoA)

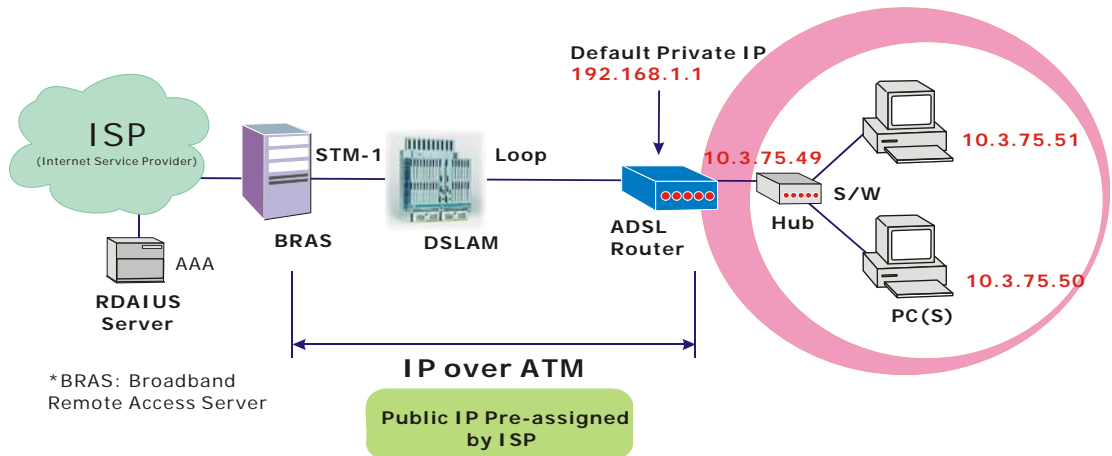

Description:

If you apply for multiple IP addresses from your ISP, you can assign these public IP addresses to the ADSL Router and public server, e.g., Web or FTP server. Typically the first IP is network address, the second is used as router IP address and the last one is subnet broadcasting. Other remaining IP addresses can be assigned to PCs on the LAN.

The following example uses the LAN IP address ranging from 10.3.75.49 to 10.3.75.54 and the subnet mask for LAN is 255.255.255.248. The WAN address is 10.3.70.1, and the subnet mask for WAN is 255.255.255.252.

In such circumstance, we do not assign any WAN IP.

Configuration:

1. Start up your browser and type **192.168.1.1** as the address to enter this ADSL web-based manager.
2. Go to **Quick Start -Quick Setup**. Uncheck **Auto Scan Internet Connection (PVC)**. Type in the **VCI** and **VPI** value. Then click the **Next** button.
VPI – 0
VCI – 32
3. On the **Configure Internet Connection -Connection Type** page, select the **IP over ATM (IPoA)** then click the **Next** button.
4. In the **WAN IP Settings** page, select **None** for WAN IP address settings. Then, select **Use the following DNS Server Address**. Type in the Primary DNS server and Secondary DNS server. Uncheck **Enable NAT**. Then Click **Next** for next page.
Primary DNS server: 168.95.1.1
Secondary DNS server: 168.95.192.1
5. In the **Configure LAN side Settings** page, type in the IP address and subnet mask for your LAN.
Primary IP Address: 192.168.1.1
Subnet mask: 255.255.255.0
Start IP Address: 192.168.1.2
End IP Address: 192.168.1.254
6. Check **Configure the second IP Address and Subnet Mask for LAN Interface** and type in the second IP address and subnet mask. Then click **Next**.
Secondary IP Address: 10.3.75.49
Subnet mask: 255.255.255.248
7. Check the network information. Make sure the settings match the settings provided by ISP. Click **Finish**.

8. Set TCP/IP for your computer. Specify an IP Address, subnet mask and set default gateway. eg:
IP Address: 10.3.75.51
Subnet Mask: 255.255.255.248
Gateway: 10.3.75.49
9. Now the router is well configured. You can access into Internet.

Unnumbered IP over ATM (IPoA) + NAT

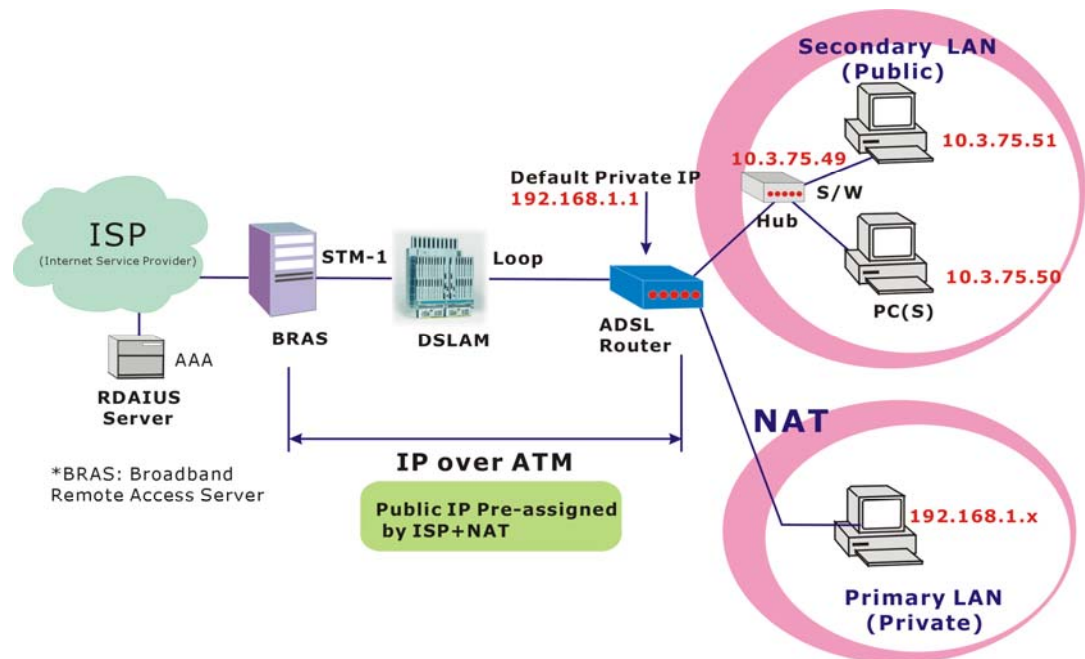

Description:

If you apply for multiple IP addresses from your ISP, you can assign these public IP addresses to the ADSL Router and public server, e.g., Web or FTP server. Typically the first IP is network address, the second is used as router IP address and the last one is subnet broadcasting. Other remaining IP addresses can be assigned to PCs on the LAN.

The following example uses the LAN IP address ranging from 10.3.75.49 to 10.3.75.54 and the subnet mask for LAN is 255.255.255.248. The WAN address is 10.3.70.1, and the subnet mask for WAN is 255.255.255.252.

In such circumstance, we enable NAT function but not assign any WAN IP.

Configuration:

1. Start up your browser and type **192.168.1.1** as the address to enter this ADSL web-based manager.
2. Go to **Quick Start -Quick Setup**. Uncheck **Auto Scan Internet Connection (PVC)**. Type in the **VCI** and **VPI** value. Then click the **Next** button.
VPI – 0
VCI – 32
3. On the **Configure Internet Connection -Connection Type** page, select the **IP over ATM (IPoA)** then click the **Next** button.
4. In the **WAN IP Settings** page, select **None** for WAN IP address settings. Then, select **Use the following DNS Server Address**. Type in the Primary DNS server and Secondary DNS server. Click **Next** for next page.
Primary DNS server: 168.95.1.1
Secondary DNS server: 168.95.192.1
5. Check the **Enable NAT** box. And click **Next**.
6. In the **Configure LAN side Settings** page, type in the IP address and subnet mask for your LAN.
Primary IP Address: 192.168.1.1
Subnet mask: 255.255.255.0

Start IP Address: 192.168.1.2
End IP Address: 192.168.1.254

7. Check **Configure the second IP Address and Subnet Mask for LAN Interface** and type in the second IP address and subnet mask. Then click **Next**.
Secondary IP Address: 10.3.75.49
Subnet mask: 255.255.255.248
8. Check the network information. Make sure the settings match the settings provided by ISP. Click **Finish**.
9. Now the router is well configured. You can access into Internet.

Bridge Mode

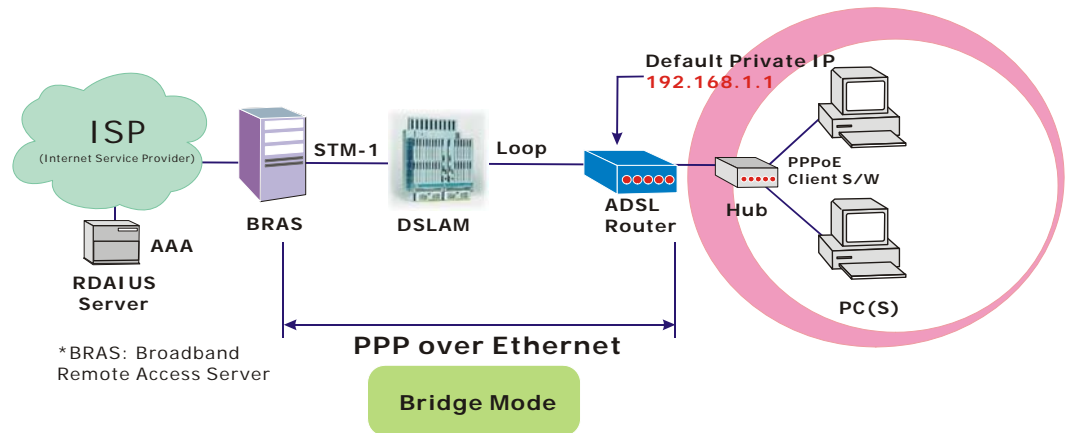

Description:

In this example, the ADSL Router acts as a bridge which bridging PC IP address from LAN to WAN. PC IP address can be a static public address that is pre-assigned by ISP or a dynamic public address that is assigned by ISP DHCP server, or can be got from PPPoE software.

Therefore, it does not require a public IP address. It only has a default private IP address (192.168.1.1) for management purpose.

Configuration:

1. Choose a client PC and set the IP as 192.168.1.x (x is between 2 and 254) and the gateway as 192.168.1.1.
2. Start up your browser and type **192.168.1.1** as the address to enter the web-based manager.
3. Go to **Quick Start -Quick Setup**. Uncheck **Auto Scan Internet Connection (PVC)**. Type in the **VCI** and **VPI** value. Then click the **Next** button. eg:
VPI – 0
VCI – 32
4. On the **Configure Internet Connection -Connection Type** page, select the **Bridging** then click the **Next** button.
5. In the **Configure LAN side Settings** page, type in the IP address and subnet mask for your LAN. Finally click **Next**. eg:
Primary IP address:192.168.1.1
Subnet Mask:255.255.255.0
6. Check the network information. Make sure the settings match the settings provided by ISP. Click **Finish**.
7. Set TCP/IP for your computer. Specify an IP Address, subnet mask and set default gateway. eg:
IP Address: 10.3.86.81
Subnet Mask: 255.255.255.248
Gateway: 10.3.86.1
8. Click **OK**. Now the router is well configured. You can access into Internet.

Chapter 4: Web Configuration



Some users might want to set specific configuration for the router such as firewall, data transmission rate... and so on. This chapter will provide you advanced information of the web pages for the router for your reference.

Using Web-Based Manager

Once your host PC is properly configured, please proceed as follows:

Connect to 192.168.1.1

WebAdmin

User name: admin

Password:

Remember my password

OK Cancel

1. Start your web browser and type the private IP address of the ADSL Router in the URL field: **192.168.1.1**.
2. After connecting to the device, you will be prompted to enter username and password. By default, the username is **admin** and the password is **admin**. See the example for running under Windows XP.

If you login successfully, the main page will appear. From now on the ADSL Router acts as a web server sending HTML pages/forms on your request. You can fill in these pages/forms and apply them to the ADSL Router.

Outline of Web Manager

For configure the web page, please use **admin** as the username and the password. The main screen will be shown as below.

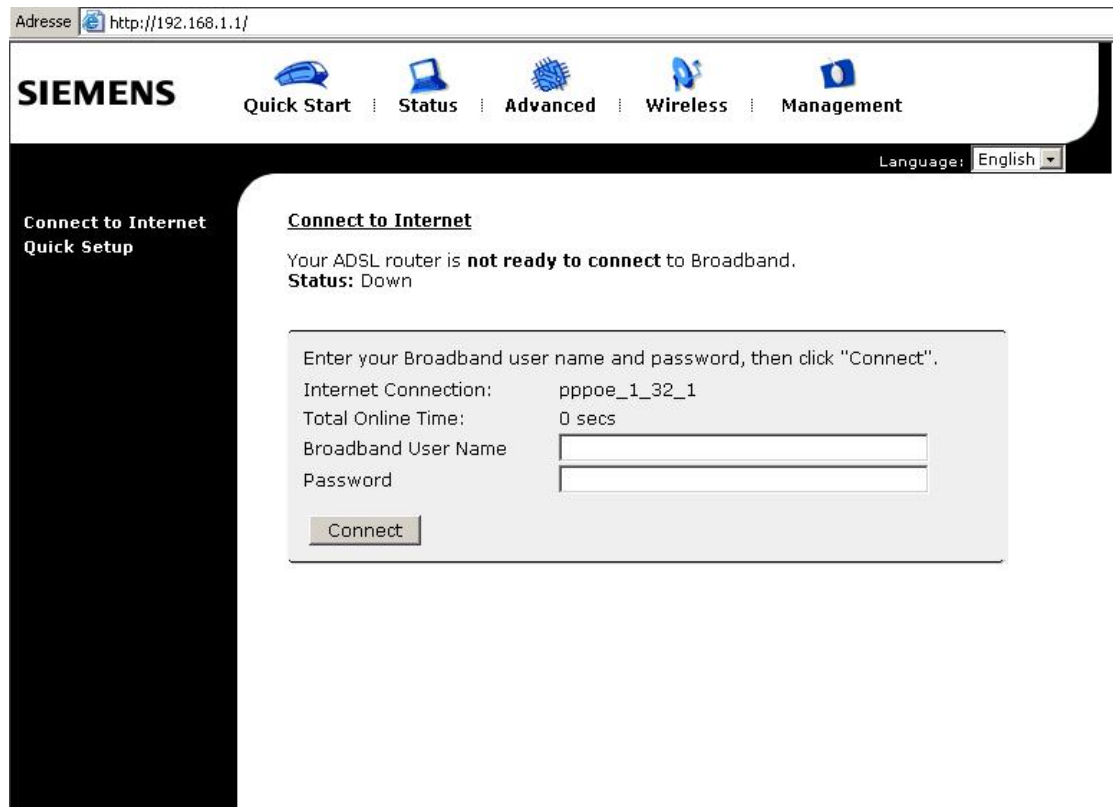

Title: It indicates the title of this management interface.

Main Menu: Includes Quick Start, Status, Advanced and Management.

Main Window: It is the current workspace of the web management, containing configuration or status information.

To Have the New Settings Take Effect

After select or adjust the settings to your desire, your customizations will be saved to the flash memory before you restart the router. And only after restarting the router, your customizations take effect.

Language

On the top to the right of this web page, it provides a language drop down menu for you to choose proper language to help you to set.



Quick Start

The pages for the Quick Start provide user a quick way to set for the router. If you do not know more about the router, you can use the Quick Start pages to adjust basic settings to make your router activating.

Connect to Internet

This is a quick way to connect to Internet by using PPPoE interface, click **Connect to Internet** to open the web page.

Enter the user name and password for your ADSL router and click **Connect**.

The system will connect automatically, then you can access Internet.

Connect to Internet

Your ADSL router is **not ready to connect** to Broadband.
Status: Down

Enter your Broadband user name and password, then click "Connect".

Internet Connection:	pppoe_8_35_1
Total Online Time:	0 secs
Broadband User Name	<input type="text"/>
Password	<input type="password"/>

Quick Setup

The quick setup wizard will guide you to configure the DSL router through some steps.

Auto Scan Internet Connection (PVC):

The default setting is checked. If there is no any PVC configured in your ADSL router, you can check this item. Otherwise, please uncheck this box.

VPI (Virtual Path Identifier): Identifies the virtual path between endpoints in an ATM network. The valid range is from 0 to 255. To enter the setting, please refer to the setting that the ISP gave you.

VCI (Virtual Channel Identifier):

Identifies the virtual channel endpoints in an ATM network. The valid range is from 32 to 65535 (1 to 31 is reserved for well-known protocols). To enter the setting, please refer to the setting that the ISP gave you.

After finished entering the VPI/VCI value, please click **Next** for next step.

Quick Setup

This Quick Setup will guide you through the steps necessary to configure your ADSL router.

Select the check box below to scan the Internet connection automatically. It is recommended that there is no any PVC configured in your ADSL router before performing auto-scanning connection.

Auto Scan Internet Connection (PVC)

Configure Internet Connection -- ATM PVC

Please enter VPI and VCI numbers for the Internet connection which is provided by your ISP.

VPI: (0-255)
VCI: (32-65535)

All original settings will be replaced by new settings after you finish these steps.

Connection Type

The system provides several protocols for you to choose. Your ISP will offer you the most suitable settings of the protocol. Before you set this page, please refer to the protocol that your ISP gave you.

After clicking on the **Next** button from the VPI/VCI web page, the following screen will appear. Please choose the connection type and encapsulation mode that you want to use and click **Next** for next page.

For example, PPP over Ethernet (PPPoE) in this screen is selected. Next, we are going to tell you different webpage for different protocol that you choose in this page.

Configure Internet Connection - Connection Type

Select the protocol and encapsulation type with the ATM PVC that your ISP has instructed you to use.

- Protocol:
- PPP over ATM (PPPoA)
 - PPP over Ethernet (PPPoE)
 - IP over ATM (IPoA)
 - Bridging

Encapsulation Type: LLC/SNAP ▾

< Back

Next >

PPP over ATM/ PPP over Ethernet

If the type you choose is PPP over ATM or PPP over Ethernet, please refer to the following information.

According to the ISP's configuration on the server, you can choose PPPoE and PPPoA modes. If the ISP provides PPPoE service, the connection type selection will be decided as whether the LAN side device is running a PPPoE client or the router is to run the PPPoE client. This router supports both situations simultaneously.

Choose **PPPoA** or **PPPoE** and click **Next**.

In this screen, you have to choose the settings for WAN IP. To get the IP address automatically, click the **Obtain an IP address automatically** radio button. Or click **Use the following IP address** button and enter the IP address for WAN interface.

Click **Enable NAT** if you want. As for the detailed NAT settings, it will be described in later sections.

Click **Enable QoS** for your necessity. It can improve the performance for selected classes of applications. Before you check this item, please assign the priorities for various applications from the Quality of Service menu of Advanced web page. Be aware that IP QoS also consumes system resources, the number of created PVCs will be reduced consequently.

The **MTU** means the maximum size of the packet that transmitted in the network. The packet of the data greater than the number set here will be divided into several packets for transmitting. Type in the number into the field of **MTU**. The default setting is 1492.

Click **Next** for next screen.

Configure Internet Connection - Connection Type

Select the protocol and encapsulation type with the ATM PVC that your ISP has instructed you to use.

Protocol: PPP over ATM (PPPoA)
 PPP over Ethernet (PPPoE)
 IP over ATM (IPoA)
 Bridging

Encapsulation Type:

Configure Internet Connection - WAN IP Settings

Enter information provided to you by your ISP to configure the WAN IP settings.

Obtain an IP address automatically
 Use the following IP address:

WAN IP Address:

Enable NAT

Enable QoS

Enabling IP QoS for a PVC can improve performance for selected classes of applications. Please assign the priorities for various applications from the [Advanced > Quality of Service](#) menu. Be aware that IP QoS also consumes system resources, the number of created PVCs will be reduced consequently.

MTU: (default: 1492)

PPP Username:

Type in the username that you got from your ISP.

PPP Password:

Type in the password that you got from your ISP.

Always On:

Check this button to make the connection is always active.

Dial on Demand:

Click this button to make a connection while in demand. Enter the timeout to cut off the network connection if there is no activity for this router.

Manually Connect:

Click this button to make a connection by pressing the Connect button on the Advanced Setup- Internet-Connections web page.

In the **Configure LAN side Settings** web page, you have to fill in the data requested here.

Primary IP Address:

Type in the first IP address that you got from your ISP for your LAN connection.

Subnet Mask:

Type in the subnet mask that you got from your ISP for your LAN connection.

Configure the second IP Address and Subnet Mask for LAN interface:

Check this box to make another set of IP Address and Subnet Mask to connect to your router if they are not included in the range that DHCP server accepts.

Secondary IP Address:

Type in the second IP address that you got from your ISP for your LAN connection.

Subnet Mask:

Type in the subnet mask that you got from your ISP for your LAN connection.

MTU:

It means the maximum size of the packet that transmitted in the network. The packet of the data greater than the number set here will be divided into several packets for transmitting. Type in the number into the field of MTU. The default setting is 1500.

DHCP Server On:

Check this item if DHCP service is needed on the LAN. The router will assign IP address, gateway address for each of your

Configure Internet Connection - PPP User Name and Password

In order to establish the Internet connection, please enter PPP user name and password that your ISP has provided.

PPP User Name :

PPP Password:

Session established by: Always On
 Dial on Demand, Idle Timer
 Disconnect if no activity for minutes
 Manually Connect
 Disconnect if no activity for minutes

[< Back](#) [Next >](#)

Please type the username and password that you got from your ISP. Then click **Next**.

Configure LAN side Settings

Enter the ADSL router IP address and subnet mask for LAN interface and then enable DHCP server on LAN interface to provide IP address settings for your computers.

Primary IP Address:

Subnet Mask:

Configure secondary IP address and subnet mask

MTU: (default: 1500)

DHCP Server On Start IP:
 End IP:
 Lease Time: days hours minutes

DHCP Server Off

[< Back](#) [Next >](#)

On the Configure LAN side Settings web page, the IP address and subnet mask will be shown on it. You can modify them if needed.

Type in all the necessary settings and click **Next** for next page.

PCs.

Start IP Address:

Type in the start point IP address.

End IP Address:

Type in the end point IP address.

Leased Time:

Type in the duration for the time. The default is 1day.

DHCP Server Off:

Check this item if DHCP service isn't needed on the LAN.

You can check it at this time. If you find something is incorrect, click **Back** to change the settings.

If everything is OK, click **Finish** to accept these settings.

Now, the system will reboot to activate the new settings that you have done in this section.

Please wait for 2 minutes for restarting the router.

This Internet Connection -- Summary

Make sure that the settings below match the settings provided by your ISP.

Internet (WAN) Configuration:

VPI / VCI	8 / 35
Connection Type	PPPoE LLC/SNAP, Dial on Demand, Idle Timer 20 mins
NAT	Enabled
WAN IP Address	Automatically Assigned
Default Gateway	Automatically Assigned
DNS Server	Automatically Assigned
QoS	Enabled

LAN Configuration:

Primary LAN IP	192.168.1.1 / 255.255.255.0
Secondary LAN IP	0.0.0.0 / 0.0.0.0
DHCP Server	On 192.168.1.2 ~ 192.168.1.254
DHCP Lease Time	1 days 0 hours 0 minutes

Click "Finish" to accept these settings, and reboot the system.
Click "Back" to make any modifications.

< Back Finish

Reboot DSL Router

The DSL Router has been configured and is rebooting.

Close the DSL Router Configuration window and wait for 2 minutes before reopening your web browser. If necessary, reconfigure your PC's IP address to match your new configuration.

IP over ATM

If the type you have to choose is IP over ATM, please refer to the following information.

IPoA is an alternative of LAN emulation. It allows TCP/IP network to access ATM network and uses ATM quality of service's features.

Choose **IPoA** and click **Next**.

Configure Internet Connection - Connection Type

Select the protocol and encapsulation type with the ATM PVC that your ISP has instructed you to use.

Protocol: PPP over ATM (PPPoA)
 PPP over Ethernet (PPPoE)
 IP over ATM (IPoA)
 Bridging

Encapsulation Type: LLC/SNAP

< Back Next >

None:

If it is not necessary to set the WAN IP address, please click this button.

Obtain an IP address automatically:

Click this button to make the system get an IP address automatically.

WAN IP Address:

Type in the IP address that you got from ISP for the WAN interface.

WAN Subnet Mask:

Type in the subnet mask address that you got from ISP for the WAN interface.

Obtain DNS server address automatically:

Click this button to make the system get DNS server automatically.

Use the following DNS server address:

If you want to set DNS server by yourself, you have to click on this button to invoke the following entries.

Primary DNS server:

Type in your preferred DNS server that you got from ISP.

Secondary DNS server:

Type in the alternate DNS server that you got from ISP.

Click **Enable NAT** if you want. As for the detailed NAT settings, it will be described in later sections.

Click **Enable QoS** for your necessity.

It can improve the performance for selected classes of applications. Before you check this item, please assign the priorities for various applications from the Quality of Service menu of Advanced web page. Be aware that IP QoS also consumes system resources, the number of created PVCs will be reduced consequently.

Please type in the WAN IP address, Subnet Mask and DNS server addresses. Then Click **Next** to get the following page.

Configure Internet Connection - WAN IP Settings

Enter information provided to you by your ISP to configure the WAN IP settings.

None
 Obtain an IP address automatically
 Use the following IP address:
WAN IP Address:
WAN Subnet Mask:
 Obtain DNS server address automatically
 Use the following DNS server addresses:
Primary DNS server:
Secondary DNS server:

Enable NAT

Enable QoS

Enabling IP QoS for a PVC can improve performance for selected classes of applications. Please assign the priorities for various applications from the [Advanced...Quality of Service](#) menu. Be aware that IP QoS also consumes system resources, the number of created PVCs will be reduced consequently.

< Back Next >

In the **Configure LAN side Settings** web page, you have to fill in the data requested here.

Primary IP Address:

Type in the first IP address that you got from your ISP for your LAN connection.

Subnet Mask:

Type in the subnet mask that you got from your ISP for your LAN connection.

Configure the second IP Address and Subnet Mask for LAN interface:

Check this box to make another set of IP Address and Subnet Mask to connect to your router if they are not included in the range that DHCP server accepts.

Secondary IP Address:

Type in the second IP address that you got from your ISP for your LAN connection.

Subnet Mask:

Type in the subnet mask that you got from your ISP for your LAN connection.

DHCP Server On:

Check this item if DHCP service is needed on the LAN. The router will assign IP address, gateway address for each of your PCs.

Start IP Address:

Type in the start point IP address.

End IP Address:

Type in the end point IP address.

Leased Time:

Type in the duration for the time. The default is 1 day.

DHCP Server Off:

Check this item if DHCP service isn't needed on the LAN.

You can check it at this time. If you find something is incorrect, click **Back** to change the settings. If everything is OK, click **Finish** to accept these settings. And the following page will appear.

Configure LAN side Settings

Enter the ADSL router IP address and subnet mask for LAN interface and then enable DHCP server on LAN interface to provide IP address settings for your computers.

Primary IP Address:
 Subnet Mask:

Configure secondary IP address and subnet mask

Secondary IP Address:
 Subnet Mask:

DHCP Server On Start IP:
 End IP:
 Lease Time: days hours minutes

DHCP Server Off

[< Back](#) [Next >](#)

On the Configure LAN side Settings web page, the IP address and subnet mask will be shown on it. You can modify them if needed. Click **Next** for next page.

This Internet Connection -- Summary

Make sure that the settings below match the settings provided by your ISP.

Internet (WAN) Configuration:

VPI / VCI	8 / 35
Connection Type	IPoA LLC/SNAP
NAT	Enabled
WAN IP Address	Automatically Assigned
Default Gateway	Automatically Assigned
DNS Server	Automatically Assigned
QoS	Enabled

LAN Configuration:

Primary LAN IP	192.168.1.1 / 255.255.255.0
Secondary LAN IP	0.0.0.0 / 0.0.0.0
DHCP Server	On 192.168.1.2 ~ 192.168.1.254
DHCP Lease Time	1 days 0 hours 0 minutes

Click "Finish" to accept these settings, and reboot the system.
 Click "Back" to make any modifications.

[< Back](#) [Finish](#)

Now, the system will reboot to activate the new settings that you have done in this section.

Please wait for 2 minutes for restarting the router.

Reboot DSL Router

The DSL Router has been configured and is rebooting.

Close the DSL Router Configuration window and wait for 2 minutes before reopening your web browser. If necessary, reconfigure your PC's IP address to match your new configuration.

Bridging

If the type you choose is **Bridging**, please refer to the following information.

The bridging mode can configure your router to send packets received on any port such as ATM PVC or Ethernet with a broadcast MAC address to all other ports.

Choose **Bridging** and click **Next**.

Configure Internet Connection - Connection Type

Select the protocol and encapsulation type with the ATM PVC that your ISP has instructed you to use.

- Protocol:
- PPP over ATM (PPPoA)
 - PPP over Ethernet (PPPoE)
 - IP over ATM (IPoA)
 - Bridging

Encapsulation Type:

[< Back](#) [Next >](#)

None:

If it is not necessary to set the WAN IP address, please click this button.

Obtain an IP address automatically: Click this button to make the system get an IP address automatically.

WAN IP Address:

Type in the IP address that you got from ISP for the WAN interface.

WAN Subnet Mask:

Type in the subnet mask address that you got from ISP for the WAN interface.

Obtain DNS server address automatically:

Click this button to make the system get DNS server automatically.

Use the following DNS server address:

If you want to set DNS server by yourself, you have to click on this button to invoke the following entries.

Primary DNS server:

Type in your preferred DNS server that you got from ISP.

Secondary DNS server:

Type in the alternate DNS server that you got from ISP.

Click **Enable NAT** if you want. As for the detailed NAT settings, it will be described in later sections.

Click **Enable QoS** for your necessity.

It can improve the performance for selected classes of applications. Before you check this item, please assign the priorities for various applications from the Quality of Service menu of Advanced web page. Be aware that IP QoS also consumes system resources, the number of created PVCs will be reduced consequently.

In the **Configure LAN side Settings** web page, you have to fill in the data requested here.

Configure Internet Connection - WAN IP Setting

Enter information provided to you by your ISP to configure the WAN IP settings.

- None
- Obtain an IP address automatically
- Use the following IP address:
 - WAN IP Address:
 - WAN Subnet Mask:
 - Default Gateway:
- Obtain DNS server address automatically
- Use the following DNS server addresses:
 - Primary DNS server:
 - Secondary DNS server:

Enable NAT

Enable QoS

Enabling IP QoS for a PVC can improve performance for selected classes of applications. Please assign the priorities for various applications from the [Advanced...Quality of Service](#) menu. Be aware that IP QoS also consumes system resources, the number of created PVCs will be reduced consequently.

[< Back](#) [Next >](#)

Primary IP Address:

Type in the IP address that you got from your ISP for LAN interface.

Subnet Mask:

Type in the subnet mask that you got from your ISP for LAN interface.

MTU:

It means the maximum size of the packet that transmitted in the network. The packet of the data greater than the number set here will be divided into several packets for transmitting. Type in the number into the field of MTU. The default setting is 1500.

DHCP Server On:

Check this item if DHCP service is needed on the LAN. The router will assign IP address, gateway address for each of your PCs.

Start IP Address:

Type in the start point IP address.

End IP Address:

Type in the end point IP address.

Leased Time:

Type in the duration for the time. The default is 1day.

DHCP Server Off:

Check this item if DHCP service isn't needed on the LAN.

Click **Next** to get into next web page.

You can check it at this time. If you find something is incorrect, click **Back** to change the settings. If everything is OK, click **Finish** to accept these settings. And the following page will appear.

Now, the system will reboot to activate the new settings that you have done in this section.

Please wait for 2 minutes for restarting the router.

Configure LAN side Settings

Enter the ADSL router IP address and subnet mask for LAN interface and then enable DHCP server on LAN interface to provide IP address settings for your computers.

Primary IP Address:
Subnet Mask:

Configure secondary IP address and subnet mask

MTU: (default: 1500)

DHCP Server On Start IP:
End IP:
Lease Time: days hours minutes

DHCP Server Off

This Internet Connection -- Summary

Make sure that the settings below match the settings provided by your ISP.

Internet (WAN) Configuration:

VPI / VCI	8 / 35
Connection Type	Bridge LLC/SNAP
NAT	Enabled
WAN IP Address	Automatically Assigned
Default Gateway	Automatically Assigned
DNS Server	Automatically Assigned
QoS	Enabled

LAN Configuration:

Primary LAN IP	192.168.1.1 / 255.255.255.0
Secondary LAN IP	0.0.0.0 / 0.0.0.0
DHCP Server	On 192.168.1.2 ~ 192.168.1.254
DHCP Lease Time	1 days 0 hours 0 minutes

Click "Finish" to accept these settings, and reboot the system. Click "Back" to make any modifications.

Reboot DSL Router

The DSL Router has been configured and is rebooting.

Close the DSL Router Configuration window and wait for 2 minutes before reopening your web browser. If necessary, reconfigure your PC's IP address to match your new configuration.

Status

Overview

This page is displaying the current status for the DSL connection. It includes if the lists the LAN IP address, default gateway, DNS servers IP address, firmware version, the period of activating the router, and so on. The system status will be changed according to the settings that you configured in the web pages.

Overview of Device Information

This information reflects the current status of your ADSL router.

System Up Time	00:01:03:38
ADSL Speed (DS/US)	
LAN IP Address	192.168.1.1
Default Gateway	
Primary DNS server	
Secondary DNS server	
Firmware Version	2.21.05.06_A2pB018c1.d16d
Boot Loader Version	1.0.37-21.6.4
Wireless Driver Version	3.91.39.0 (Wireless is enabled)
Wireless BSSID	00:11:F5:4B:9E:45
Ethernet MAC Address	00:11:F5:4B:9E:42

ADSL Line

This page shows all information for ADSL. For knowing the quality of the ADSL connection, please click ADSL BER Test button to have advanced information.

Click More Information to show more detailed information about ADSL Line Status.

ADSL Line Status

Current adsl line status is as the below.

Line Mode		Line State	Down
Latency Type		Line Up Time Duration	N/A
Line Coding		Line Up Count	0

Statistics	Downstream	Upstream
Line Rate		
Attainable Line Rate		
Noise Margin		
Line Attenuation		
Output Power		

[More Information](#) 

ADSL BER Test

ADSL BER Test

This test determines the quality of the ADSL connection. It is done by transferring idle cells containing a known pattern and comparing the received data with this known pattern to check for errors.



After select the test duration time and click **Start**, the following dialog appears to tell you the test is running. You can stop the test by click **Stop** or close this dialog by click **Close**.

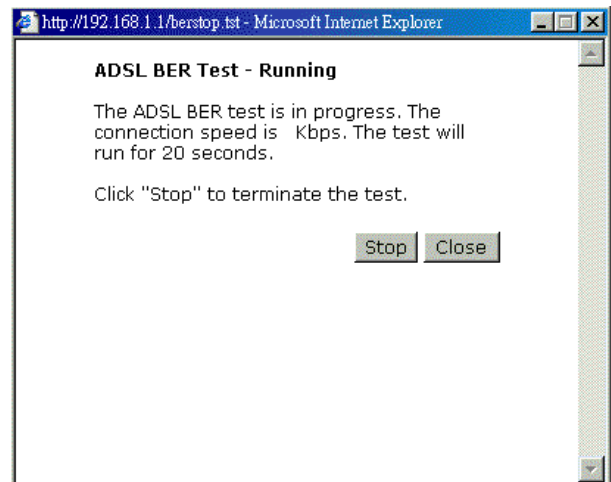

When the test is over, the result will be shown on the following dialog for your reference. Click **Close** to close this dialog.

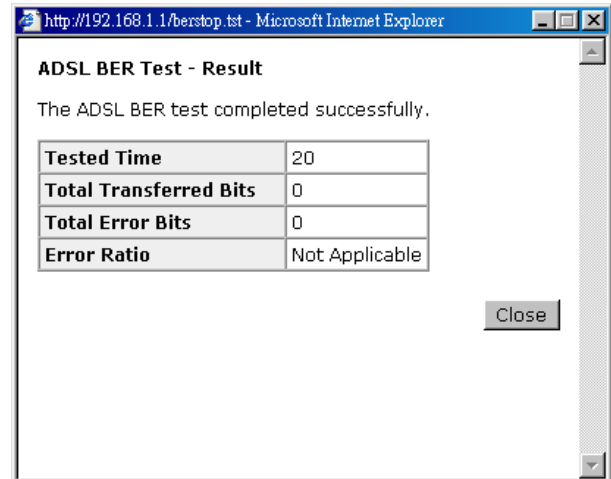

Internet Connection

This page displays the connection information for your router, such as PVC name, category, protocol, invoking NAT or not, IP address, link status and so on.

Internet Connection

Current Internet connections are listed below.

PVC Name	VPI/VCI	Category	Protocol	NAT	QoS	WAN IP Address	Status / Online Time
pppoe_8_35_1	8/35	UBR	PPPoE LLC/SNAP	On	On		Down 00:00:00:00

Traffic Statistics

This table shows the records of data going through the LAN and WAN interface. For each interface, cumulative totals are displayed for **Received** and **Transmitted**.

Traffic Statistics

The statistics of user data going through your ADSL router are listed below.

Interface	Received				Transmitted			
	Bytes	Packets	Errors	Drops	Bytes	Packets	Errors	Drops
Ethernet	315800	2958	0	0	1168808	3846	0	0
Wireless	0	0	0	0	0	0	5	0
WAN	0	0	0	0	0	0	0	0

Reset

DHCP Table

This table shows all DHCP clients who get their IP addresses from your ADSL Router. For each DHCP client, it shows the **Host Name**, **MAC Address**, **IP Address** and the **Lease Time**.

DHCP Table

Those devices which get their IP addresses from your ADSL router are listed below.

Host Name	MAC Address	IP Address	Lease Time
CN	00:C1:26:0A:69:2B	192.168.1.2	00:23:47:17

Routing Table

This table shows the routing method that your router uses.

Routing Table

All of current routing rules in your DSL Router are listed below.

Destination	Netmask	Gateway	Interface	Metric
192.168.1.0	255.255.255.0	0.0.0.0	br0	0

ARP Table

This table shows the IP address record for IP-to-Physical translation in your router.

ARP Table

The IP-to-Physical address translation entries recorded in your DSL Router are listed below.

IP address	Physical Address	Interface	Type
192.168.1.2	00:C1:26:0A:69:2B	br0	Dynamic

Advanced Setup

Local Network- IP Address

This page is the same as you can see in the **Configure LAN side Settings** page while running the **Quick Setup**. It allows you to set IP Address and Subnet Mask values for LAN interface.

Primary IP Address:

Type in the first IP address that you got from your ISP for your LAN connection.

Subnet Mask:

Type in the subnet mask that you got from your ISP for your LAN connection.

Host Name:

List the host name of this device.

Domain Name:

List the name of domain.

Configure the second IP Address and Subnet Mask for LAN interface:

Check this box to make another set of IP Address and Subnet Mask to connect to your router if they are not included in the range that DHCP server accepts.

Secondary IP Address:

Type in the second IP address that you got from your ISP for your LAN connection.

Subnet Mask:

Type in the subnet mask that you got from your ISP for your LAN connection.

MTU:

It means the maximum size of the packet that transmitted in the network. The packet of the data greater than the number set here will be divided into several packets for transmitting. Type in the number into the field of MTU. The default setting is 1500.

Apply:

Click this button to activate the settings listed above.

LAN IP Address Configuration

Enter the ADSL router IP address and subnet mask for LAN interface.

Primary IP Address:
 Subnet Mask:
 Host Name:
 Domain Name:

Configure secondary IP address and subnet mask.

MTU: (default: 1500)

Apply

New settings only take effect after your ADSL router is rebooted. If necessary, reconfigure your PC's IP address to match new settings.

Local Network - DHCP Server

This allows you to set DHCP server on LAN interface.

DHCP Server On:

Check this item if DHCP service is needed on the LAN. The router will assign IP address, gateway address for each of your PCs.

Start IP Address:

Type in the start point IP address.

End IP Address:

Type in the end point IP address.

Leased Time:

Type in the duration for the time. The default is 1day.

Relay On:

Click this button to have a relay setting. And type in the Server IP in this field.

Server and Relay Off:

Check this item if DHCP service isn't needed on the LAN.

Apply:

Click this button to activate the settings listed above.

You can reserve one specific IP address for a certain PC for certain purpose. Simply add a mapping entry of MAC address & IP address for that PC by pressing the **View Reserved IP Address List** button. The following picture will appear.

Click the **Add** button to open another dialog as follows. On PCs MAC Address and Assigned IP Address boxes, please type in the correct information for the one that you want to add and click **Apply**.

DHCP Server Configuration

Enabling DHCP Server on LAN interface can provide the proper IP address settings to your computer.

NOTE: New settings only take effect after the router is rebooted. If necessary, reconfigure your PC's IP address to match new settings.

DHCP Server On Start IP:
End IP:
Lease Time: days hours minutes

Relay On Relay to Server IP:

Server and Relay Off

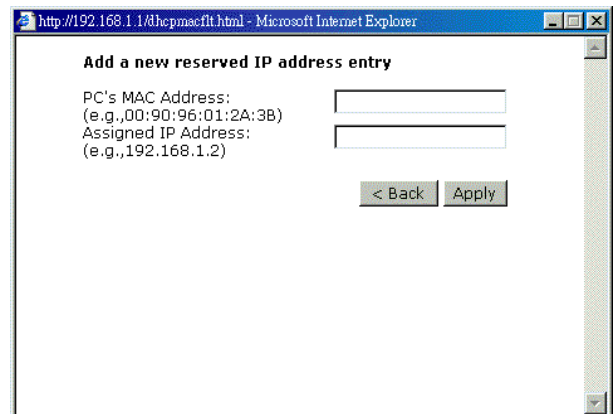
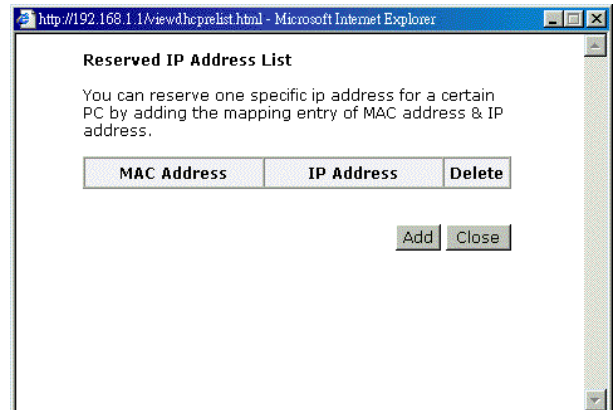

The new one will be shown on the dialog right away. That is, the specified address will be reserved and not be assigned by DHCP for other computer.

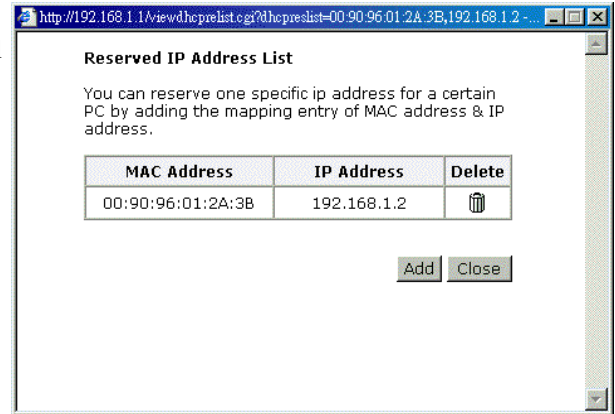

Local Network – UPnP

The UPnP is available only for Windows XP. If you are not user of Windows XP, this page does not have any meaning to you.

This page allows you to enable the UPnP function through the web page for your router.

UPnP Configuration

Enabling the UPnP IGD and NAT Traversal function allows the users to perform more applications behind NAT without additional configuration settings or ALG support on your ADSL router.

Enable UPnP

Apply



Internet-Connections Setting

To set WAN settings for each service, please open **Advanced– Internet Setting**. This page allows you to add new WAN settings, to edit or remove created WAN settings.

If you click the **Connect** line under the PVC Name item, the system will connect to WAN automatically. If the WAN connection is OK, you can check the detailed information directly.

Internet Connection Configuration

Choose Add or Edit to configure Internet connection.
Choose Finish to apply the changes and reboot the system.

PVC Name	VPI/VCI	Category	Protocol	NAT	QoS	WAN IP Address	MTU	Edit
pppoe_8_35_1 Connect	8/35	UBR	PPPoE LLC/SNAP	On	On	Auto assigned	1492	 

The Internet connection is NOT active if PVC name is marked with (?). You need to click "Finish" to apply changes and reboot the system for activating this PVC.

Add Finish

Adding a New One

You have to type in the VPI and VCI values in the entry boxes. Then click **Next**. The screen will get into the **Connection Type** page of **Quick Setup** and ask you to fill in the data according to the request of the screen. Refer to **Quick Setup** for more information if you don't know how to set the configuration.

To add a new WAN connection, please click the **Add** button. The following screen appears.

VPI (Virtual Path Identifier):

Identifies the virtual path between endpoints in an ATM network. The valid range is from 0 to 255. You cannot type in the number randomly if you desire. Please refer to the value that your ISP gave.

VCI (Virtual Channel Identifier):

Identifies the virtual channel endpoints in an ATM network. The valid range is from 32 to 65535 (1 to 31 is reserved for well-known protocols). You cannot type in the number randomly if you desire. Please refer to the value that your ISP gave.

Service Category:

It decides the size and rate for the packets of the data in different service type. There are five categories provided here for your selection. Please choose any one of it as you desired.

Configure Internet Connection -- ATM PVC

Please enter VPI and VCI numbers for the Internet connection which is provided by your ISP.

VPI: (0-255)

VCI: (32-65535)

Service Category: ▼

< Back Next >

If you choose Non Realtime VBR, you have to type in the following data.

The range for Peak Cell Rate is from 1 to 1690.

The range for Sustainable Cell Rate is from 1 to 1689 and must be smaller than Peak Cell Rate.

The range for Maximum Burst Size is from 1 to 100.

Configure Internet Connection -- ATM PVC

Please enter VPI and VCI numbers for the Internet connection which is provided by your ISP.

VPI: (0-255)
VCI: (32-65535)

Service Category:
Peak Cell Rate: cells/s (1-1690)
Sustainable Cell Rate: cells/s (1-1689)
Maximum Burst Size: cells/s (1-100)

< Back Next >

After click **Next**, you will see the web page listed as the right. Choose the protocol that you want. And click **Next** again.

Configure Internet Connection - Connection Type

Select the protocol and encapsulation type with the ATM PVC that your ISP has instructed you to use.

- PPP over Ethernet (PPPoE)
 Bridging

Encapsulation Type:

< Back Next >

The WAN IP settings will differ slightly according to the protocol that you choose. This graphic is the one that you will get if you choose to add a new interface of PPPoA/PPPoE mode. You can check **Enable NAT** or **Enable QoS** for your necessity. And you can set the MTU value in this page.

Configure Internet Connection - WAN IP Settings

Enter information provided to you by your ISP to configure the WAN IP settings.

- Obtain an IP address automatically
 Use the following IP address:

WAN IP Address:

- Enable NAT
 Enable QoS

Enabling IP QoS for a PVC can improve performance for selected classes of applications. Please assign the priorities for various applications from the [Advanced... Quality of Service](#) menu. Be aware that IP QoS also consumes system resources, the number of created PVCs will be reduced consequently.

MTU: (default: 1492)

< Back Next >

If you want to add a new interface of **PPPoE** mode and choose **PPPoE** from the previous web page, you will get a web page as the graphic listed in right side.

Please refer to **Quick Setup** for more information if you don't know how to set the configuration.

Configure Internet Connection - PPP User Name and Password

In order to establish the Internet connection, please enter PPP user name and password that your ISP has provided.

PPP User Name:
PPP Password:

- Session established by: Always On
 Dial on Demand
Disconnect if no activity for minutes
 Manually Connect
Disconnect if no activity for minutes

< Back Next >

If you want to add a new interface of **Bridging** mode and choose **Bridging** from the previous web page, you will get a web page as the graphic listed in right side.

Please refer to **Quick Setup** for more information if you don't know how to set the configuration.

Configure Internet Connection - WAN IP Setting

Enter information provided to you by your ISP to configure the WAN IP settings.

- None
 Obtain an IP address automatically
 Use the following IP address:

WAN IP Address:
WAN Subnet Mask:
Default Gateway:

- Obtain DNS server address automatically
 Use the following DNS server addresses:

Primary DNS server:
Secondary DNS server:

- Enable NAT

- Enable QoS

Enabling IP QoS for a PVC can improve performance for selected classes of applications. Please assign the priorities for various applications from the [Advanced... Quality of Service](#) menu. Be aware that IP QoS also consumes system resources, the number of created PVCs will be reduced consequently.

< Back Next >

Internet-DNS Server

If **Enable Automatic Assigned DNS** checkbox is selected, this router will accept the **first** received DNS assignment from one of the PPPoA, PPPoE or MER/DHCP enabled PVC(s) during the connection establishment. If the checkbox is not selected, it is necessary for you to enter the primary and optional secondary DNS server IP addresses. After type in the address, click **Apply** button to save it and invoke it.

Enable Automatic Assigned DNS:

Check this box to enable this function, or uncheck this box to disable it.

Primary DNS server:

Type in your primary DNS server.

Secondary DNS server:

Type in the secondary DNS server.

If you are satisfied the settings, click **Apply**.

DNS Server Configuration

If Enable Automatic Assigned DNS checkbox is selected, this router will accept the first received DNS assignment from the PPPoA, PPPoE or MER/DHCP enabled PVC(s) during the connection establishment. If the checkbox is not selected, enter the primary and optional secondary DNS server IP addresses. Click "Apply" to save it.

Enable Automatic Assigned DNS

Primary DNS server:

Secondary DNS server:

Apply If changing from unselected Automatic Assigned DNS to selected Automatic Assigned DNS, you must restart your ADSL router to get DNS addresses automatically.

Internet-IGMP Proxy

The Internet Group Management Protocol (IGMP) is an Internet protocol that provides a way for an Internet computer to report its multicast group membership to adjacent routers.

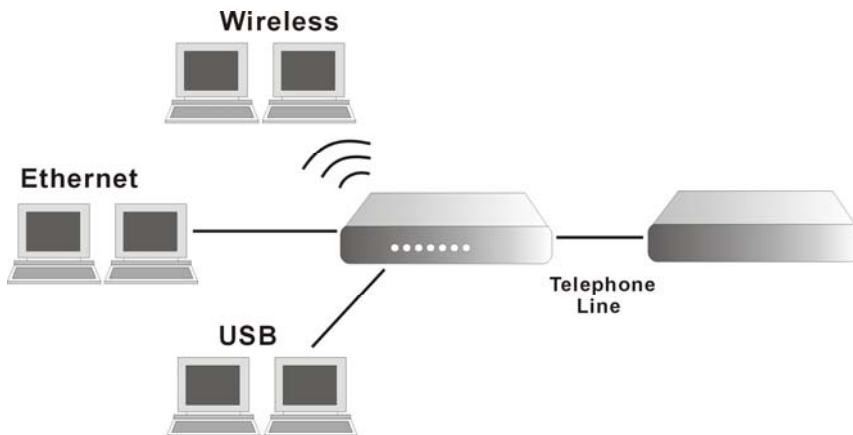

The hosts interact with the system through the exchange of IGMP messages. When you want to configure IGMP proxy, the system will interact with other router through the exchange of IGMP messages. However, when acting as the proxy, the system performs the host portion of the IGMP task as follows:

- When it is queried, the system will send group membership reports to the group.
- When one of the hosts joins a multicast address group to which none of other hosts belong, the system will send unsolicited group membership reports to that group.
- When the last of hosts in a particular multicast group leaves the group, the system will send a leave group membership report to the routers group.

Internet Connection:

This field displays the internet connection that you currently use.

IGMP Proxy Enabled:

Check this box to enable this function or uncheck this box to disable this function.

After finish the settings, click **Apply**.

IGMP Proxy Configuration

Enabling IGMP proxy function can allow the users on your local network to play the multimedia (video or audio) which sent from the servers on the Internet.

Internet Connection	IGMP Proxy Enabled
pppoe_8_35_1	<input type="checkbox"/>

Apply

Internet - ADSL Settings

Enable ADSL Port:

Check this box to enable this function. It simply invokes the line mode that you choose here for the router.

Select the support of line modes:

There are several selections for your choosing. Select the one that you need. For Example, if you want to change one or more physical layer parameters while the ATU-x is in data transfer state, and the transmission errors will not be present, please choose ADSL2.

Capability Enabled:

Two items are provided here for you to choose.

Bitswap:

It is a mandatory receiver initiated feature to maintain the operating conditions of the modem during changing environment conditions. It reallocates the data bits and power among the allowed carriers without modification of the higher layer control parameters in the ATU. After a bit swapping reconfiguration, the total data rate and the data rate on each latency path is unchanged. Check this box to enable the function. If not, uncheck this box to close the function.

Seamless Rate Adaptation:

It enables the ADSL2 system to change the data rate of the connection while in operation without any service interruption or bit errors. Check this box to enable the function. If not, uncheck this box to close the function.

ADSL Settings

Enable ADSL Port

Select the support of line modes: G.dmt G.lite T1.413
 ADSL2 READSL2 ADSL2+
 Annex M

Capability Enabled: Bitswap Seamless Rate Adaptation

Apply

IP Routing - Static Route

Routing Table shows all static route status and allows you to add new static IP route or delete IP route. A Static IP Routing is a manually defined path, which determines the data transmitting route. If your local network is composed of multiple subnets, you may want to specify a routing path to the routing table.

Destination Network Address:

Display the IP address that the data packets are to be sent.

Netmask:

Display the subnet mask that the data transmitting is passing through.

Gateway:

Display the gateway that the data transmitting is passing through.

WAN Interface:

Display the interface that the data transmitting is passing through.

Delete:

Static Route

Current static routes:

Destination	Netmask	Gateway	WAN Interface	Delete

Add

Allow you to remove the selected static route settings.

Adding a New One

To add a static route, please choose Static Route - Add. Type the destination network address, subnet mask and gateway that you get from ISP and click **Apply**.

Destination Network Address:

The destination IP address of the network where data packets are to be sent.

Subnet Mask:

Type in the subnet mask that you got from ISP.

Gateway IP Address:

Click this button to invoke this function. Type in the gateway that you got from ISP.

WAN Interface:

Click this button to invoke this function and choose the one from the drop down menu.

Add New Static Route

Enter the Destination Network Address, Netmask, Gateway or available WAN interface then click "Apply" to add the entry to the routing table.

Destination Network (For default route, type 0.0.0.0 or leave blank)

IP Address:

Netmask:

Forward Packets to

Gateway IP Address:

WAN Interface:

Click **Apply** to view the routing result. This page shows all the routing table of data packets going through your ADSL Router.

Remove Static Route

If you don't want the static route that you created, please click the icon under **Delete** from Routing Table.

Static Route

Current static routes:

Destination	Netmask	Gateway	WAN Interface	Delete
0.0.0.0	255.255.255.0	192.168.1.1		

A dialog appears to ask you to confirm the action. Click Yes to remove the static route, or click No to keep the setting.

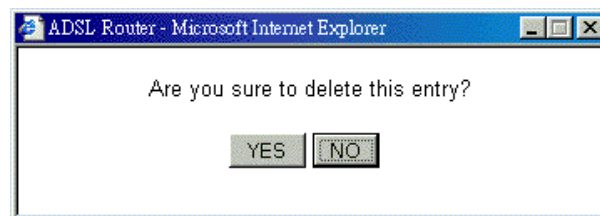

Configuring Other Routers on Your LAN

It is essential that all IP packets for devices that are not on the local LAN can be passed to the Router, so that they can be forwarded to the external LAN, WAN, or Internet. To achieve this, the local LAN must be configured to use the Router as the default route or default gateway.

Local Router

The local router is the Router installed on the same LAN segment as the Router. This router requires that the default route is the Router itself. Typically, routers have a special entry for the default route. It should be configured as follows.

Destination: Normally 0.0.0.0 but check your router documentation.

Subnet Mask: Normally 0.0.0.0 but check your router documentation.

Gateway: The IP Address of the Router.

Other Routers on the Local LAN

Other routers on the local LAN must use the Router's Local Router as the Default Route. The entries will be the same as the Router's local router, with the exception of the Gateway IP Address.

- For a router with a direct connection to the Router's local Router, the Gateway IP Address is the address of the Router's local router.
- For routers which must forward packets to another router before reaching the Router's local router, the Gateway IP Address is the address of the intermediate router.

Example – Static Route

Here provides you an example of Static Route.

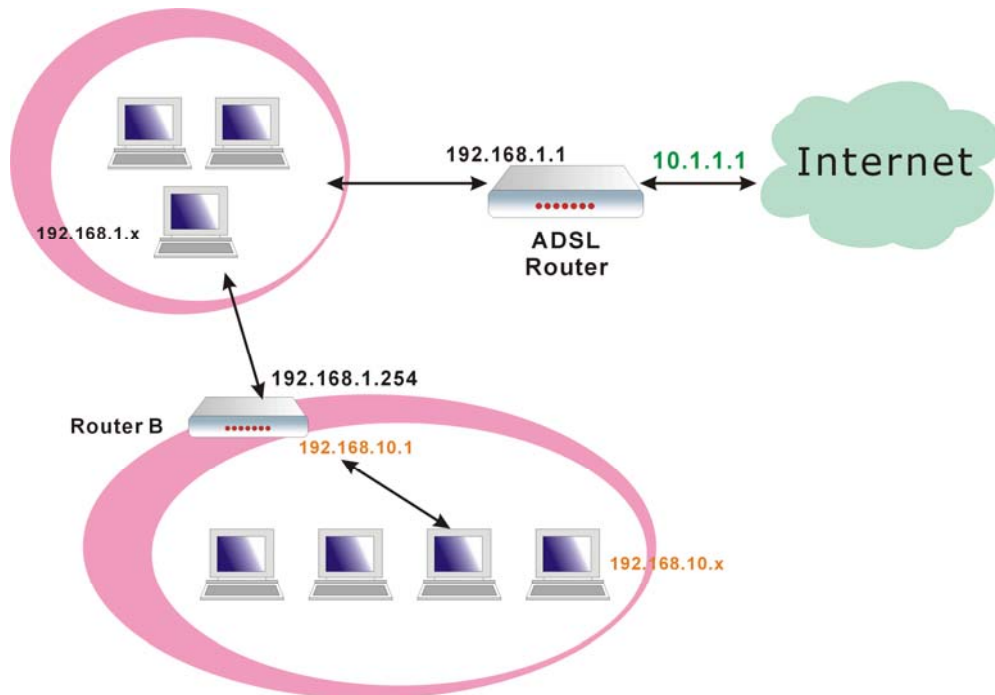

For the Router's Routing Table

For the LAN shown above, with 2 routers and 3 LAN segments, the Router requires to add 2 static routes as follows:

ADSL Router	Destination	192.168.10.0
	Subnet Mask	255.255.255.0 (Standard Class C)
	Gateway	192.168.1.254 (Router B)

IP Routing – Dynamic Routing

Routing Information Protocol (RIP) is utilized as a means of exchanging routing information between routers. It helps the routers to determine optimal routes. This page allows you to enable/disable this function.

RIP Version:

It incorporates the RIP information when receiving and broadcasting the RIP packets. From the drop down list, select a RIP version to be accepted, 1, 2 or both.

Operation Mode:

There are two modes for you to choose, Active and Passive. Select Active for transmitting and receiving data, or select Passive for receiving data only.

Enabled:

Click Enabled to enable the RIP function on

Dynamic Routing

You can enable RIP function on several interfaces of your ADSL router. Select the desired RIP version and operation mode, then tick the 'Enabled' checkbox to enable RIP when you click "Apply", or leave it unticked if you would like to disable RIP on those interfaces.

Interface	RIP Version	Operation Mode	Enabled
LAN	2	Active	<input type="checkbox"/>
pppoe_8_35_1	2	Passive	<input type="checkbox"/>

Apply

different interface. Otherwise, disable this function.

Click **Apply** to invoke the settings set here.

Virtual Server-Port Forwarding

The Router implements NAT to let your entire local network appear as a single machine to the Internet. The typical situation is that you have local servers for different services and you want to make them publicly accessible. With NAT applied, it will translate the internal IP addresses of these servers to a single IP address that is unique on the Internet. NAT function not only eliminates the need for multiple public IP addresses but also provides a measure of security for your LAN.

When the router receives an incoming IP packet requesting for access to your local server, the router will recognize the service type according to the port number in this packet (e.g., port 80 indicates HTTP service and port 21 indicates FTP service). By specifying the port number, you tell the router which service should be forwarded to the local IP address you specify.

After you setting the virtual server you should modify the filter rule whichever port and service you set on virtual server. Because the firewall has protect the route by filter rule so that you should update the filter rule after you set up virtual server.

Virtual Server allows you to make servers on your LAN accessible to Internet users. Normally, Internet users would not be able to access a server on your LAN because:

- Your server does not have a valid external IP Address.
- Attempts to connect to devices on your LAN are blocked by the firewall in this device.

The Virtual Server feature solves these problems and allows Internet users to connect to your servers, as illustrated below:

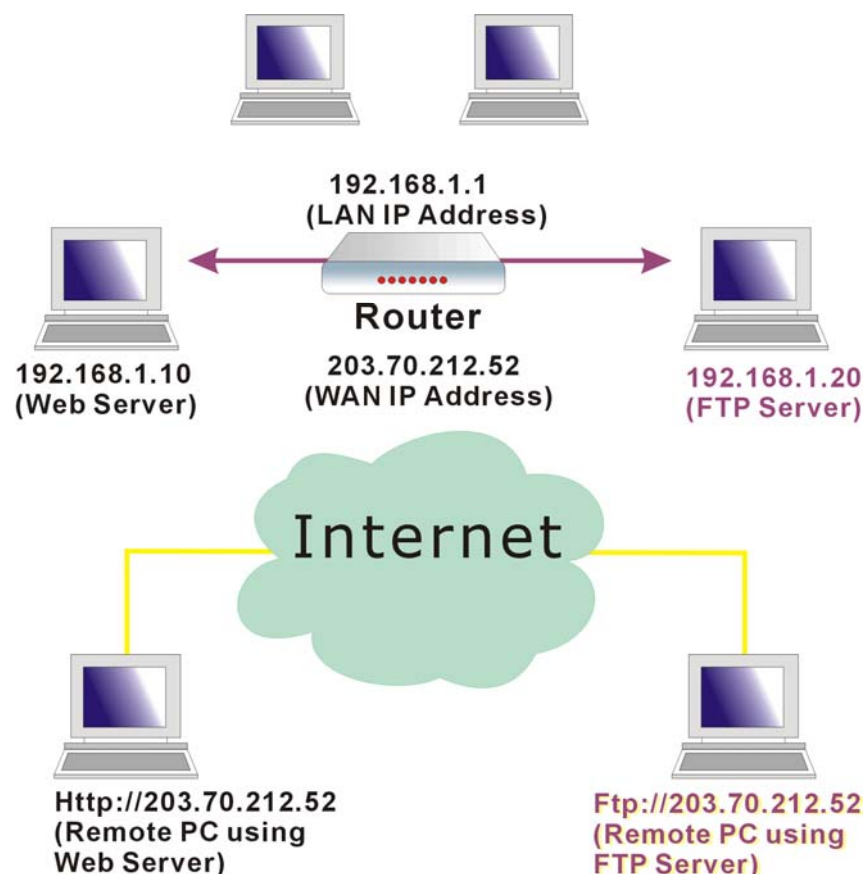

IP Address seen by Internet Users

Please note that, in the above picture, both Internet users are connecting to the same IP address, but using different protocols.

To Internet users, all virtual servers on your LAN have the same IP Address. This IP Address is allocated by your ISP. This address should be static, rather than dynamic, to make it easier for Internet users to connect to your Servers. However, you can use Dynamic DNS feature to allow users to connect to your virtual servers by using a URL, instead of an IP address.

To set a virtual server, please open the **Virtual Servers** item from the **Advanced Setup - NAT** menu.

Port Forwarding

Create the port forwarding rules to allow certain applications or server software to work on your computers if the Internet connection uses NAT.

Application Name	External Packet			Internal Host		Delete
	IP Address	Protocol	Port	IP Address	Port	

Add

Add New Port Forwarding

To add a new Port Forwarding, please click **Add** from the Port Forwarding web page.

Pre-defined

Choose one of the services type from the first drop down list, such as Audio/Video, Games and so on. In the second drop down list, choose the name of the application that you want to use with the type that you select in the first list.

User defined:

Type a new service name for building a customized service for specific reason.

Add New Port Forwarding Rule

Application Name:

Pre-defined:
 User defined:

From Internet Host IP Address:

Forward to Internal Host IP Address:

< Back Apply

Add New Port Forwarding Rule

Application Name:

Pre-defined:
 User defined:

From Internet Host IP Address:

Forward to Internal Host IP Address:

< Back Apply

Add New Port Forwarding Rule

Application Name:

Pre-defined:
 User defined:

From Internet Host IP Address:

Forward to Internal Host IP Address:

< Back Apply

From Internet Host IP Address:

Select the initial place for port forwarding. If you choose SINGLE, a box will appear for you to fill in the IP address for the specific host. And, if you choose SUBNET, the boxes of IP and Subnet will appear for you to fill in the IP address and subnet mask for the specific host as the start point.

From Internet Host IP Address: ALL

Forward to Internal Host IP Address: ALL
SINGLE
SUBNET

< Back Apply

Forwarded to Internet Host IP Address:

Type in the address for the host used as the place that information will be forwarded.

IP addresses can be automatically redirected to local servers configured with private IP addresses. In other words, depending on the requested service (TCP/UDP port number), the router redirects the external service request to the appropriate server (located at another internal IP address).

After adding a new virtual server, click **Apply**.

The following screen will be shown to display the status for new ones.

If you do not want the new server that you added, please check the **Delete** box of that one and click the **Delete** button to discard it.

Or if you want to add another one again, click **Add** to add a new one.

Port Forwarding

Create the port forwarding rules to allow certain applications or server software to work on your computers if the Internet connection uses NAT.

Application Name	External Packet			Internal Host		Delete
	IP Address	Protocol	Port	IP Address	Port	
Camerades	ALL	TCP/UDP	2047 - 2048	192.168.1.200	2047 - 2048	<input type="checkbox"/>

Select All

Add Delete

Connecting to the Virtual Servers

Once configured, anyone on the Internet can connect to your Virtual Servers. They must use the Internet IP Address (the IP Address allocated to you by your ISP) For example,

Http://203.70.212.52

Ftp://203.70.212.52

It is more convenient if you are using a Fixed IP Address from your ISP, rather than Dynamic. However, you can use the Dynamic DNS feature to allow users to connect to your Virtual Server through a URL, rather than an IP Address.

Virtual Server-Port Triggering

When the router detects outbound traffic on a specific port, it will set up the port forwarding rules temporarily on the port ranges that you specify to allow inbound traffic. It is supposed to increase the support for Internet gaming, video conferencing, and Internet telephony due to the applications require multiple connection.

Port Triggering

Port triggering function is a conditional port forwarding feature. When your ADSL router detects outbound traffic on a specific port (trigger port), it will set up the port forwarding rules temporarily on the port ranges you specify to allow inbound traffic. This is supposed to increase the support for Internet gaming, video conferencing, and Internet telephony due to these applications require multiple connection.

Application Name	Trigger		Open		Delete
	Protocol	Port	Protocol	Port	

Add

To add a new port triggering, click **Add** to open this web page. Than choose an application name from the Pre-defined list box. The system provides 9 items for your choice.

Add New Port Triggering Rule

Application Name: Pre-defined: Amn Talk
 User defined:

Apply

Add New Port Triggering Rule

Application Name: Pre-defined: User defined:

Aim Talk

Aim Talk

Asheron's Call

Calista IP Phone

Delta Force (Client/Server)

ICQ

Napster

Net2Phone

QuickTime 4 Client

Rainbow Six

Rogue Spear

Or define by yourself by typing the words into the field of User defined.

Click **Apply** to complete the setting.

Virtual Server - DMZ Host

Direct Mapping Zone (DMZ) uses a technology that makes Router forwarding all incoming packet to internal specific server.

To close the function of DMZ Host, please click Discarded.

To activate a DMZ host, please click Forwarded to the DMZ host radio button and type the IP Address into the field of IP address of DMZ host, then click **Apply**.

DMZ Host

A DMZ host is a computer on your local network that can be accessed from the Internet regardless of port forwarding and firewall settings.

Those IP packets from the Internet that do NOT belong to any applications configured in the port forwarding table will be:

Discarded

Forwarded to the DMZ host

IP address of DMZ host:

This feature allows one computer on your LAN to be exposed to all users on the Internet, allowing unrestricted 2-way communication between the specified IP address and other Internet users or Servers.

- This allows almost any application to be used on the specified IP address.
- The specified IP address will receive all "Unknown" connections and data.
- If the DMZ feature is enabled, you must type in numbers to specify an IP address.
- The DMZ feature can be Enabled and Disabled on the NAT setting screen.

Virtual Server - Dynamic DNS

The Dynamic DNS (Dynamic Domain Name System) combines both functions of DNS and DHCP to map a dynamic IP into a fixed domain name. This page allows you to access into virtual servers with a domain name and password.

Dynamic DNS :

Selects Enable to enable DDNS; select Disabled to disable this function.

Internet Connection :

Selects the interface that you want to use for connecting Internet.

User Name :

Type in the user name that you registered in www.dyndns.org.

Password :

Type in the password that you registered in www.dyndns.org.

Domain Name :

Type in the domain name that you registered in www.dyndns.org. You can use letters and dash for naming, yet other characters are not allowed to use for preventing from making troubles.

Status :

It displays current status.

Dynamic DNS Configuration

This page allows you to provide Internet users with a domain name (instead of an IP address) to access your virtual servers. This ADSL router supports dynamic DNS service provided by the provider '<http://www.dyndns.org>' or '<http://www.tzo.com>'. Please register this service at these providers first.

Dynamic DNS: Disabled Enabled

Dynamic DNS Provider:

Internet Connection:

User Name:

Password:

Domain Name:

Status:

Firewall

The firewall is a software that interrupts the data between the Internet and your computer. It is the TCP/IP equivalent of a security gate at the entrance to your company. All data must pass through it, and the firewall (functions as a security guard) will allow only authorized data to be passed into the LAN.

What the firewall can do? It can:

- deny or permit any packet from passing through explicitly
- distinguish between various interfaces and match on the following fields:
 - ◆ source and destination IP address
 - ◆ port

To keep track of the performance of IP Filter, a logging device is used which supports logging of the TCP/UDP and IP packet headers and the first 129 bytes of the packet (including headers) when a packet is successfully **passed** through, a packet is **blocked** from passing through and it matches a rule setup to look for suspicious packets

Filtering by IP address

An example for firewall setup:

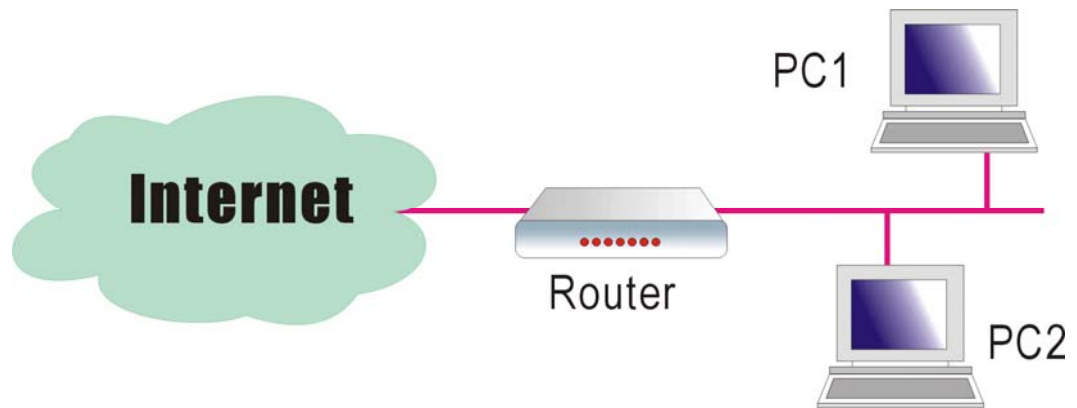

This picture is the most common and easiest way to employ the firewall. Basically, you can install a packet-filtering router at the Internet gateway and then configure the filter rule in the router to block or filter protocols and addresses. The systems behind the router usually have a direct access to the Internet, however some dangerous services such as NIS and NFS are usually blocked.

For the security of your router, setting the firewall is an important issue.

Choose **Disabled** to disable the firewall function. Click **Enabled** to invoke the settings that you set in this web page.

IP Filtering

This page allows you to specify the IP packet filtering rules to prevent the services accessed from the Internet hosts or limit the Internet access for local hosts.

IP Filtering: Disabled Enabled

To open the IP Filtering, please click the **Enabled** radio button. The web page will be shown as the right picture.

Select the direction to filter packets:

The way of the data transmission. In Bound means the data is transferred from outside onto your computer. Out Bound means the data is transferred from your computer onto outside through Internet. Please choose **Outbound traffic** or **Inbound traffic** as the direction for filtering packets.

IP Filtering

This page allows you to specify the IP packet filtering rules to prevent the services accessed from the Internet hosts or limit the Internet access for local hosts.

IP Filtering: Disabled Enabled

Select the direction to filter packets: Outbound traffic Inbound traffic

Protocol	Source IP addr	Dest IP addr	Port Range		Allow	Edit
			Start	End		

Then, to add a new IP Filtering, click **Add**.

This page provides some settings for you to adjust for adding a new outbound IP Filtering.

Allow Traffic:

No stops the data transmission, **Yes** lets the data pass through.

Protocol:

Here provide several default policies for security levels for you to choose. If you don't want to use the predefined setting, you can use **User Defined** to set a customized protocol for your necessity. When you choose **User Defined** setting, you have to type in a port number in the "as" field.

Source/Destination IP address:

To specify IP address to allow or deny data transmission, please pull down the drop-down menu to choose a proper one.

All: This setting means that all the IP addressed in the network are allowed or denied to pass through in Internet. If you choose **Single**, an IP address field will appear to the right side. You have to type in the specific IP address as the start/end point to let the router identify for granting or denying pass through. If you choose **Subnet**, the IP address and Netmask will appear to the right side. Please type in the specific IP address and Netmask as the start/end point to let the router identify for granting or denying pass through.

Port Range:

The port range is from 0 to 65535. Please type in the start point and end point for the IP Filtering.

After finish the settings, click **Apply**. A new one will be added and shown on the web page.

Add New Outbound IP Filtering Rule

Allow Traffic Yes No

Protocol:

Source IP address:

Destination IP address:

Port Range: Start End

Protocol:

- TCP
- UDP
- ICMP
- AH
- ESP
- GRE
- ALL
- User Defined

Add New Outbound IP Filtering Rule

Allow Traffic Yes No

Protocol: as

Source IP address:

- ALL
- SINGLE
- SUBNET

Add New Outbound IP Filtering Rule

Allow Traffic Yes No

Protocol:

Source IP address: IP addr:

Destination IP address: Netmask:

Port Range: Start End

A new IP filtering setting for Outbound traffic is created in the web page. To edit the setting, please click the pencil mark to get into the editing page. To delete the setting, click the trash mark to erase it. To set another IP filtering, click **Add** again.

IP Filtering

This page allows you to specify the IP packet filtering rules to prevent the services accessed from the Internet hosts or limit the Internet access for local hosts.

IP Filtering: Disabled Enabled

Select the direction to filter packets: Outbound traffic Inbound traffic

Protocol	Source IP addr	Dest IP addr	Port Range		Allow	Edit
			Start	End		
UDP	ALL	ALL	0	65535	✔	✖ 🗑️

For adding a new Inbound IP Filtering, click **Inbound traffic** in the item of **Select the direction to filter packets**. Use the same way to add a new one as stated above.

Add New Inbound IP Filtering Rule

Allow Traffic: Yes No

Protocol:

Source IP address:

Destination IP address:

Port Range: Start End

Quality of Service

QoS (Quality of Service) is an industry-wide initiative to provide preferential treatment to certain subsets of data, enabling that data to traverse the Internet or intranet with higher quality transmission service.

Bridge QoS

To classify the upstream traffic by assigning the transmission priority for data of different users, please use Bridge QoS to prioritize the data transmission.

The Bridge QoS allows you to set the settings based on layer two IP packets.

Bridge QoS

This page allows you to classify the upstream traffic (to the Internet) by assigning the transmission priority for various user data. Bridge QoS function prioritizes the data transmission based on layer 2 bridge packets.

Traffic Name	Priority	IP Precedence	IP TOS	802.1p	Delete
					✖ 🗑️

Traffic Class Name:

Type in a name as the traffic class for identification.

802.1p Priority:

Each incoming packet will be mapped to a specific priority level, so that these levels may be acted on individually to deliver traffic differentiation. Please choose the number (from 0 to 7) for the 802.1p Priority.

Traffic Priority:

There are three options – Low, Medium, and High that you can choose.

IP Precedence:

The number you choose here decides the type of the IP address processed. No change

Add New Bridge QoS Traffic Rule

All of specified conditions in the traffic rule must be satisfied for the rule to take effect.

Traffic Class Name:

Traffic Conditions

802.1p Priority:

Assign Priority for this Traffic Rule

Traffic Priority:

IP Precedence:

IP Type of Service:

The corresponding "Precedence" value in the IP header of the upstream packets will be overwritten by selected value.

The corresponding "TOS" value in the IP header of the upstream packets will be overwritten by selected value.

is the default setting.

IP type of Service:

The system provides some types of service for you to choose. The meaning of each type is the same as the denotation. The default one is No change.

IPQoS

To classify the upstream traffic by assigning the transmission priority of the data for different users, please use IP QoS to prioritize the data transmission.

The IP QoS allows you to set the settings based on layer three IP packets.

To add a new QoS setting, please **Add** in the page of Quality of Service, a page same as the right side will appear.

Traffic Class Name:

Type in a name as the traffic class for identification.

Protocol:

Choose the proper interface for this function. If you don't know how to select, simply use the default one, TCP/UDP.

Source IP Address/ Subnet Mask:

You have to type in the source IP address (ex: 192.168.1.50) and subnet mask (ex:255.255.255.0) for the application (ex: FTP, HTTP and so on) that you want to invoke the QoS traffic rule.

Source Port:

Except the IP address, you also have to enter the source port. Type in the source port for the traffic rule. The range is from 0 to 65535.

Destination IP Address/Subnet Mask:

You have to type in the destination IP address (ex: 192.168.1.254) and subnet mask (ex:255.255.255.0) for the application that

IP QoS

This page allows you to classify the upstream traffic (to the Internet) by assigning the transmission priority for various user data. IP QoS function prioritizes the data transmission based on layer 3 IP packets.

Traffic Name	Priority	IP Precedence	IP TOS	Protocol	Source IP Source port	Dest IP Dest port	Delete
--------------	----------	---------------	--------	----------	-----------------------	-------------------	--------

Add

Add New IP QoS Traffic Rule

All of specified conditions in the traffic rule must be satisfied for the rule to take effect.

Traffic Class Name:

Traffic Conditions

Protocol:

Source IP Address: Subnet Mask:

Source Port (start-end): -

Destination IP Address: Subnet Mask:

Destination Port(start-end): -

Assign Priority for this Traffic Rule

Traffic Priority:

IP Precedence: The corresponding 'Precedence' value in the IP header of th upstream packets will be overwritten by selected value.

IP Type of Service: The corresponding 'TOS' value in the IP header of the upstream packets will be overwritten by selected value.

< Back Apply

Protocol:

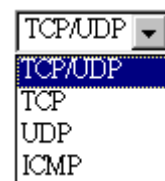

you want to invoke the QoS traffic rule.

Destination Port:

Type in the destination port for the traffic rule. The range is from 0 to 65535.

Traffic Priority:

There are three options – Low, Medium, and High that you can choose. It decides the order of each data transmitted through this device.

IP Precedence:

The number you choose here decides the type of the IP address processed. No change is the default setting.

IP type of Service:

The system provides some types of service for you to choose. The meaning of each type is the same as the denotation. The default one is No change.

Traffic Priority:

Low
 Low
 Medium
 High

IP Precedence:

No Change
 No Change
 0
 1
 2
 3
 4
 5
 6
 7

IP Type of Service:

Apply

IP Type of Service:

No Change
 No Change
 Normal Service
 Minimize Cost
 Maximize Reliability
 Maximize Throughput
 Minimize Delay

Apply

After you click **Apply**, the new QoS setting will be shown on the graphic as the right side. To delete the one you set, simply click the check button below **Delete** item and click **Delete** button.

Quality of Service

Traffic Name	Priority	IP Precedence	IP TOS	802.1P	Source IP		Destination IP		Delete
					Address Netmask	Start Port End Port	Address Netmask	Start Port End Port	
Number	Low	No Change	No Change		192.168.1.25 255.255.255.0	123 321	192.168.1.100 255.255.255.0	123 321	<input type="checkbox"/>

[Add](#) [Delete](#)

Port Mapping

This page allows you to configure various port mapping groups which contains specific Internet connections and LAN ports. All the user data can be only transmitted and received among the interfaces in the groups that you specified in this page.

Port Mapping Configuration

This page allows you to configure various port mapping groups which contains specific Internet connections and LAN ports. The user data are only transmitted and received among the interfaces in the group.

NOTE: DHCP server and all routing/firewall functions are only available at the Default group.

Virtual LAN Function on Ethernet: Disabled Enabled [Apply](#)

Group Name	Internet Connections	LAN Ports	Edit
Default	pppoe_8_35_1	Ethernet, USB, Wireless	

[Add](#)

Group Name:

Type in a name here as a group name. It must be unique. The word length must not be over the length of the field.

Available Interfaces:

The available interfaces (such as Ethernet) will be displayed in the left side box. When you choose it and click **Add**, it will be transferred into the right side box of **Grouped Interfaces**. Yet, if you want to remove the interface from the current group, it will be returned back to the Default group (left side box) after you click **Remove**.

After finish the settings, click **Apply**.

Add New Port Mapping Group

Available interfaces can be LAN ports or Internet connections of ATM PVC bridge mode.

Group Name: The group name must be unique.

Available Interfaces**Grouped Interfaces**

Selected interfaces will be removed from their existing groups and added to the new group. If you remove one interface from current group, this interface will be returned back to the Default group.

Management

Diagnostics

To check the link status for the network and your computer, a diagnostic test can guide you to detect the network problem. The testing items are listed and accomplished one by one. If the previous one is failed, than the items below that failed one will be failed too. Use this diagnostic test to detect the connectivity mistakes whenever you happen to the linked problem.

For the item which passes through the diagnostics, a PASS word will be shown on the right side of that item.

If not, a Fail word will be there.

N/A means that item is not necessary for the system to test.

Diagnostic Tests

This DSL Router is capable of testing your DSL connection. The individual tests are listed below. If a test displays a fail status, click "Run Diagnostic tests" again to make sure the fail status is consistent. If the test continues to fail, click "Help" and follow the troubleshooting procedures.

Select the Internet Connection:

[Run Diagnostic Tests](#)

Test the connection to your local network

Test your Ethernet Connection: **PASS** [Help](#)

Test the connection to your DSL service provider

Test ADSL Synchronization: **FAIL** [Help](#)

Test ATM OAM F5 segment ping: N/A [Help](#)

Test ATM OAM F5 end-to-end ping: N/A [Help](#)

Test ATM OAM F4 segment ping: N/A [Help](#)

Test ATM OAM F4 end-to-end ping: N/A [Help](#)

Test the connection to your Internet service provider

Test PPP server connection: N/A [Help](#)

Test authentication with ISP: N/A [Help](#)

Test the assigned IP address: N/A [Help](#)

Ping default gateway: N/A [Help](#)

Ping primary Domain Name Server: N/A [Help](#)

The Help link lets you know what the result (Pass, Down, Fail) represents for. In this page you still can rerun diagnostic test at any time.

ADSL Synchronization Test

Pass:	Indicates that the DSL router has detected a DSL signal from the telephone company. A solid DSL LED on the router also indicates the detection of a DSL signal from the telephone company.
Fail:	Indicates that the DSL router does not detect a signal from the telephone company's DSL network. The DSL LED will continue to flash green.

If the test fails, follow the troubleshooting procedures listed below and rerun the diagnostics tests by clicking "Rerun Diagnostic Tests" at the bottom of this page. If all the tests pass, close and restart your Web browser to access the Internet.

Troubleshooting:

1. Make sure your phone line is plugged into the router.
2. After turning on your DSL router, wait for at least one minute to establish a connection. Run the diagnostic tests again by clicking "Rerun Diagnostic Tests" at the bottom of this page.
3. Make sure there is no DSL micro filter on the phone cord connecting the DSL router to the wall jack.
4. Make sure you are using the phone cord that was supplied with your DSL router or another similar phone cord with four copper wires visible in the plug.
5. If your DSL has been functioning properly for a long period of time and you suddenly are experiencing this problem, there may be a problem with the DSL network. You may need to wait from 30 minutes to a couple of hours, and if you still do not have a solid DSL LED on your router, call Technical Support.
6. Turn off the power to the DSL router, wait 10 seconds and turn it back on. Wait at least one minute and if the DSL LED on the router remains a solid color, close your Web browser and restart it.

[Rerun Diagnostic Tests](#)

Contact ISP Technical Support if you have tried all of the above and still are experiencing a fail condition.

Admin Account

This page allows you to type in the password for accessing into your DSL Router.

For the **Admin Account**, the default setting for user password is **admin**. If you want to change the username and the password, please retype the new password in the Confirm field for confirmation. Then click **Apply**.

Admin Account

Admin account has unrestricted access to change and view configuration of your DSL Router.

User Name:
 New Password:
 Confirm New Password:

Remote Access

There are four interfaces for the remote access. Please choose one of them if you want to enable the remote access control.

Select the Internet Connection:

Select one connection item from the drop down list to enable the function.

Web Browser:

Choose this box if you want to have remote control through HTTP. The default port number will be shown in the box. Modify this number whenever you want.

Telnet:

Choose this box if you want to have remote control through telnet.

FTP:

Choose this box if you want to have remote control through FTP.

SNMP:

Choose this box if you want to have remote control through SNMP agent.

TFTP:

Choose this box if you want to have remote control through TFTP.

Secure Shell (SSH):

Choose this box if you want to have remote control through SSH.

Ping:

Choose this box if you want to have remote control through ping command under DOS prompt.

Remote Access Control

Enable remote access to let an expert, e.g. helpdesk, configure your ADSL router remotely.

Select the Internet Connection:

To allow remote access to your router via

Web Browser

Web server port on WAN interface:

Telnet

FTP

SNMP

TFTP

Secure Shell (SSH)

PING

If enabling remote access to your router via PING, all Internet hosts can ping to your router.

Internet Time

The router's clock must synchronize with global Internet's time. The time you set in the screen will be adapted to system log.

Update:

Click this button to refresh the current time.

Set Time by:

The default setting is Manual. If you select Time Server, you don't need to type in the time setting manually. The system will set automatically.

Time:

Set the start time by typing the year, the month, the day, the hour, and the date to help the router perform tasks.

Timezone:

Choose the time zone of your country where you are going to use the router.

Apply:

Save the data on the screen and apply the data after restarting the router.

Internet Time

To synchronize your router with other network devices, you can set its time manually or with an Internet time server.

Current time: 2004/01/01, 00:09

Set Time by: Time Server Manual

Year: Month: Day:

Hour: Minute:

Time Zone:

Internet Time

To synchronize your router with other network devices, you can set its time manually or with an Internet time server.

Current time: 2004/01/01, 00:09

Set Time by: Time Server Manual

Primary Time Server:

Secondary Time Server:

Time Zone:

System Log

As shown in the web page, you can view the system log and configure system log whenever you want.

System Log

The System Log dialog allows you to view the System Log and configure the System Log options.

Click "View System Log" to view the System Log.

Click "Configure System Log" to configure the System Log options.

Configure System Log

After you click **Configure System Log**, the following screen will appear. You can enable or disable the log function, choose log level, display level and proper mode as you like. Then click **Apply**.

System Log Configuration

This dialog allows you to configure System Log settings. All events greater than or equal to the selected level will be logged or displayed. If the selected mode is "Remote" or "Both" events will be sent to the specified UDP port of the specified log server.

Select the desired values and click "Apply" to configure the system log options.

Log: Disabled Enabled

Log Level:

Display Level:

Mode:

There are 8 types for log level and display level for your choose. The default is **Debugging**.

Log Level:

Display Level:

Mode:

Apply

The mode selection includes **Local**, **Remote** and **Both**. The default one is Local. If you choose **Remote** or **Both**, all the events will be sent to the specified UDP port of the specified log server.

Log Level:

Display Level:

Mode:

Apply

Viewing System Log

For viewing the system log, please click the **View System Log** button.

System Log

The System Log dialog allows you to view the System Log and configure the System Log options.

Click "View System Log" to view the System Log.

Click "Configure System Log" to configure the System Log options.

View System Log

Configure System Log

The screen will be shown immediately for your reference.

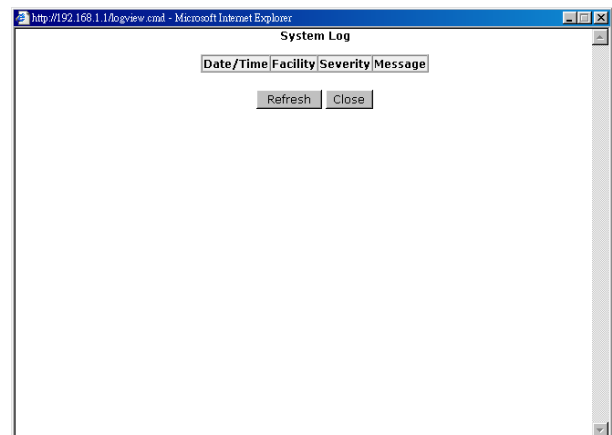

SNMP Setting

The SNMP, the abbreviation of Simple Network Management Protocol, is used to refer to a collection of specifications for network management that include the protocol itself, the definition of data structures and associated concepts.

A management station performs the monitoring function by retrieving the value of MIB objects. The management station and agents are linked by a network management protocol that is SNMP. The SNMP includes three key capabilities, get, set and trap. A single management station can handle many agents as long as SNMP remains relatively “simple”, so the number can be high (hundreds or so).

The **following picture** is the typical configuration of protocols for SNMP. As for a stand-alone management station, a manager process controls access to a central MIB at the management station and provides an interface to the network manager. The manager process achieves network management by using SNMP, which will be implemented on top of the UDP, IP and the relevant network-dependent protocols (e.g., Ethernet).

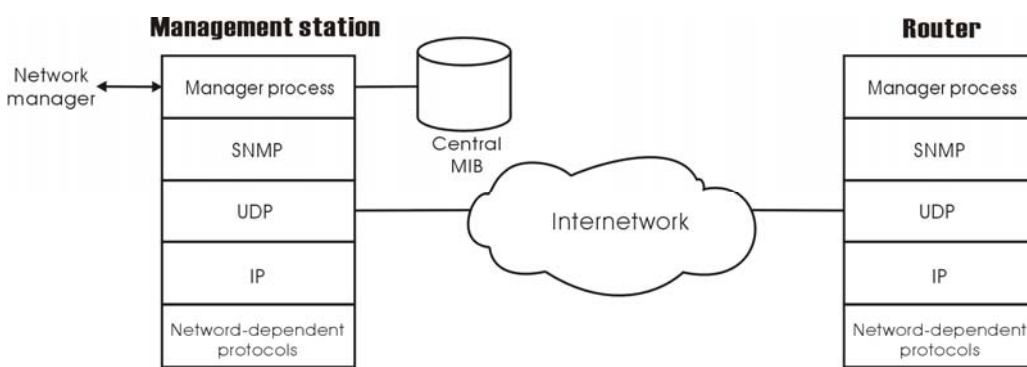

For an agent device that supports other applications, such as FTP, both TCP and UDP are required. An agent may issue a trap message in response to an event that effects the MIB and the underlying managed resources.

Note: There are no ongoing connections are maintained between a management station and its agents. Instead, each exchange is a separate transaction between a management station and an agent.

Each agent is responsible for notifying the management station of any **unusual event**; for example, if the agent crashes and is rebooted, a link fails or an overload condition as defined by the packet load crosses some threshold. These events are communicated in SNMP messages known as traps.

Please select the **SNMP** menu from **Management**. The dialog will appear.

SNMP Agent:

Choose Disable to close this function; choose Enabled to open this function.

Read Community:

The default setting is **public**, please type in the data that your ISP provided.

Write Community:

The default setting is **private**, please type in the data that your ISP provided.

Enable TRAP Service:

Check this box to enable this function, otherwise uncheck this box to disable this function.

TRAP Manager IP:

Type in an IP address as the remote workstation. If there is any abnormal condition happened, you can advice remote

SNMP Configuration

Simple Network Management Protocol (SNMP) allows a management application to retrieve statistics and status from the SNMP agent in this device.

Select the desired values and click "Apply" to configure the SNMP options.

SNMP Agent Disabled Enabled

Read Community

Write Community

Enable Trap Service

Trap Manager IP

workstation by way of SNMP agent.

Backup Config

To backup your configuration for the router to your computer, you can use **Backup Config** web page to save the settings.

And when you want to restore the settings in the future, simply open Backup Config web page and use **Browse** button to locate the file and click **Restore**.

Backup Configuration

Use to save your DSL Router's current settings into the computer.

Backup

Restore Configuration

Use to reset your DSL Router with settings previously saved on the computer.

Backup File: **Browse...**

Restore

Update Firmware

If you have to or want to update the firmware for this router, you can open the update software web page and choose the correct file by pressing **Browse**. Then click the **Update Software** button. The system will execute the update procedure automatically. When it is finished, the system will tell you the update is successfully.

Update Firmware

Step 1: Obtain an updated firmware image file from your ISP.

Step 2: Enter the path to the image file location in the box below or click "Browse" to locate the image file.

Step 3: Click "Update Firmware" once to upload the new image file.

Current Firmware Version: 2.21.05.06_A2pB018c1.d16d

New Firmware File Name: **Browse...**

Update Firmware

The update process takes about 2 minutes to complete, then your ADSL router will reboot.

Reset Router

To make effect the settings that you set for this router, please open the **Reset Router** web page and click the **Reboot** button to invoke all settings.

Reset Router

This page allows you to restart your ADSL router after changing settings that require rebooting. It also allows you to reset all settings to factory default settings if you have problems with your current configuration.

Reset to factory default settings

Reboot

After clicking "Reboot", please wait for 2 minutes to let the system reboot.

You can restore your web pages default settings. Simply check **Reset to factory default settings** and click **Reboot**.

Restore Factory Default Settings

The DSL Router configuration has been restored to factory default settings and the router is rebooting.

Close the DSL Router Configuration window and wait for 2 minutes before reopening your web browser. If necessary, reconfigure your PC's IP address to match your new configuration.

UPnP for XP

Universal plug and play (UPnP) is an architecture for pervasive peer to peer network connectivity of intelligent appliances and PCs of all form factors. It is designed to bring easy-to-use, flexible, standards-based connectivity to ad-hoc or unmanaged networks whether in the home, in a small business, public spaces, or attached to the Internet.

Only **Windows XP** supports UPnP function.

Please follow the steps below for installing UPnP components.

1. Click on the **Start** menu, point to **Settings** and click on **Control Panel**.

2. Select **Add or Remove Programs > Add/Remove Windows Components** to open **Windows Components Wizard** dialog box

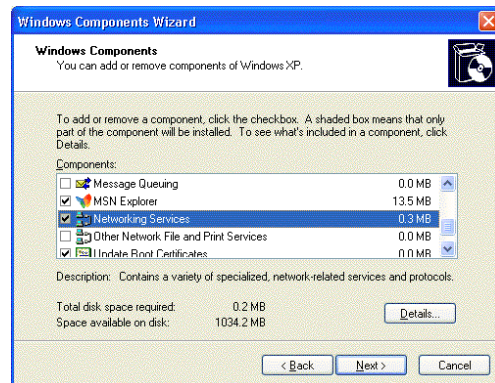

3. Select **Network Services** and click **Details**. Click the **Universal Plug and Play** check box.

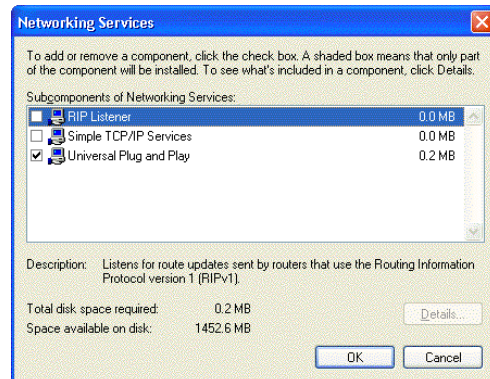

4. Click **Ok**. The system will install UPnP components automatically

5. After finishing the installation, go to **My Network Places**. You will find an icon (e.g., SL-XXX) for UPnP function.

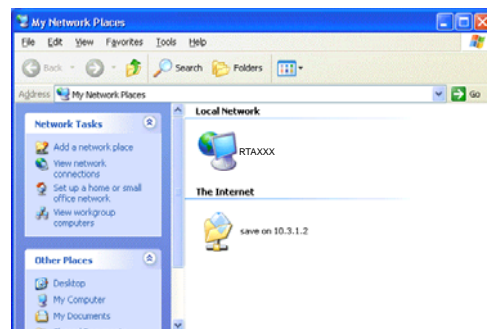

6. Double click on the icon, the ADSL router will open another web page with port for UPnP function. The IE address will be changed as shown as the graphic.

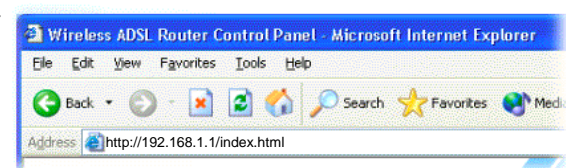

7. Now, the NAT traversal function will be provided. The ADSL router will create a new virtual server automatically for mapping while the router detecting the computer running some Internet applications.

Chapter 5: Troubleshooting

If the suggested solutions in this section do not resolve your issue, contact your system administrator or Internet service provider.

Problems with LAN

PCs on the LAN cannot get IP addresses from the ADSL Router.

The chances are that the interface used as DHCP server is modified and the client PCs do not renew IP addresses.

If your DHCP server is enabled on Private IP Address previously and you modify the interface to Public IP Address, the client PCs should renew IP addresses.

The PC on the LAN cannot access the Web page of the ADSL Router.

Check that your PC is on the same subnet with the ADSL Router.

The virtual server can't be access after setting virtual server.

Check the filter rule of the port that virtual server service setting for example, the virtual server service set FTP 21 you need update the filter rule of the ftp 21 **Direction** setting: Choose filter the packets that incoming action (In Bound) are **Allow** on the interface.

Problems with WAN

You cannot access the Internet.

- Check the physical connection between the ADSL Router and the LAN.

If the LAN LED on the front panel is off or keeps blinking, there may be problem on the cable connecting to the ADSL Router.

At the DOS prompt, ping the IP address of the ADSL Router, e.g, ping 192.168.1.1. If the following response occurs:

```
Relay from 192.168.1.1 bytes=32 time=100ms TTL=253
```

Then the connection between the ADSL Router and the network is OK.

If you get a failed ping with the response of:

```
Request time out
```

Then the connection is fail. Check the cable between the ADSL Router and the network.

- Check the DNS setting of the ADSL Router.

At the DOS prompt, ping the IP address of the DNS provided by your ISP. For example, if your DNS IP is 168.95.1.1, then ping 168.95.1.1. If the following response occurs:

```
Relay from 168.95.1.1 bytes=32 time=100ms TTL=253
```

Then the connection to the DNS is OK.

If you get a failed ping with the response of:

Request time out

Then the DNS is not reachable. Check your DNS setting on the ADSL Router.

Problems with Upgrading

The following lists the error messages that you may see during upgrading and the action to take.

- **Error:** All the ADSL LEDs light up and cannot light off as usual.
Possible cause: When users execute firmware upgrade and save settings to the router, the power for the router is lost for some unknown reasons, the normal web page for the router might be damaged. After power on your router, the LEDs might not work normally.

Boot Loader, Version 1.0.37-5.5.05

This device is currently running on the boot loader.

Update Firmware

Step 1: Obtain an updated firmware image file from your ISP.

Step 2: Enter the path to the image file location in the box below or click "Browse" to locate the image file.

Step 3: Click "Update Firmware" once to upload the new image file.

NOTE: The update process takes about 2 minutes to complete, and your DSL Router will reboot.

New Firmware File Name:

Action: Use the browser to connect to the router for executing image upgrade.

- **Error Message:** Image uploading failed. The selected file contains an illegal image.
Possible cause: The firmware file format is invalid.
Action: Check the file format is correct, otherwise download a firmware file with correct format.
- **Error Message:** Image uploading failed. The system is out of memory.
Possible cause: It may be caused by the lack of memory.
Action: Reboot your ADSL Router and perform the upgrade task again.
- **Error Message:** Image uploading failed. No image file was selected.
Possible cause: You did not select a file correctly.
Action: Download a compatible firmware from the web.

Chapter 6: Glossary

ARP (Address Resolution Protocol)

ARP is a TCP/IP protocol for mapping an IP address to a physical machine address that is recognized in the local network, such as an Ethernet address.

A host wishing to obtain a physical address broadcasts an ARP request onto the TCP/IP network. The host on the network that has the IP address in the request then replies with its physical hardware address.

Inverse ARP (In-ARP), on the other hand, is used by a host to discover its IP address. In this case, the host broadcasts its physical address and a RARP server replies with the host's IP address.

DHCP (Dynamic Host Configuration Protocol)

When operates as a DHCP server, the ADSL Router assign IP addresses to the client PCs on the LAN. The client PCs "leases" these Private IP addresses for a user-defined amount of time. After the lease time expires, the private IP address is made available for assigning to other network devices.

The DHCP IP address can be a single, fixed public IP address, an ISP assigned public IP address, or a private IP address.

If you enable DHCP server on a private IP address, a public IP address will have to be assigned to the NAT IP address, and NAT has to be enabled so that the DHCP IP address can be translated into a public IP address. By this, the client PCs are able to access the Internet.

LAN (Local Area Network) & WAN (Wide Area Network)

A LAN is a computer network limited to the immediate area, usually the same building or floor of a building. A WAN, on the other hand, is an outside connection to another network or the Internet.

The Ethernet side of the ADSL Router is called the LAN port. It is a twisted-pair Ethernet 10Base-T interface. A hub can be connected to the LAN port. More than one computers, such as server or printer, can be connected through this hub to the ADSL Router and composes a LAN.

The DSL port of the ADSL Router composes the WAN interface, which supports PPP or RFC 1483 connecting to another remote DSL device.

NAT (Network Address Translation) IP Address

NAT is an Internet standard that translates a private IP within one network to a public IP address, either a static or dynamic one. NAT provides a type of firewall by hiding internal IP addresses. It also enables a company to use more internal IP addresses.

If the IP addresses given by your ISP are not enough for each PC on the LAN and the ADSL Router, you need to use NAT. With NAT, you make up a private IP network for the LAN and assign an IP address from that network to each PC. One of some public addresses is

configured and mapped to a private workstation address when accesses are made through the gateway to a public network.

For example, the ADSL Router is assigned with the public IP address of 168.111.2.1. With NAT enabled, it creates a Virtual LAN. Each PC on the Virtual LAN is assigned with a private IP address with default value of 192.168.1.2 to 192.168.2.254. These PCs are not accessible by the outside world but they can communicate with the outside world through the public IP 168.111.2.1.

Private IP Address

Private IP addresses are also LAN IP addresses, but are considered “illegal” IP addresses to the Internet. They are private to an enterprise while still permitting full network layer connectivity between all hosts inside an enterprise as well as all public hosts of different enterprises.

The ADSL Router uses private IP addresses by assigning them to the LAN that cannot be directly accessed by the Internet or remote server. To access the Internet, private network should have an agent to translate the private IP address to public IP address.

Public IP Address

Public IP addresses are LAN IP addresses that can be considered “legal” for the Internet, because they can be recognized and accessed by any device on the other side of the DSL connection. In most cases they are allocated by your ISP.

If you are given a range of fixed IP addresses, then one can be assigned to the router and the others to network devices on the LAN, such as computer workstations, ftp servers, and web servers.

PVC (Permanent Virtual Circuit)

A PVC is a logical point-to-point circuit between customer sites. PVCs are low-delay circuits because routing decisions do not need to be made along the way. Permanent means that the circuit is preprogrammed by the carrier as a path through the network. It does not need to be set up or turned down for each session.

RIP (Routing Information Protocol)

RIP is a routing protocol that uses the distance-vector routing algorithms to calculate least-hops routes to a destination. It is used on the Internet and is common in the NetWare environment. It exchanges routing information with other routers. It includes V1, V2 and V1&V2, which controls the sending and receiving of RIP packets over Ethernet.

UDP (User Datagram Protocol)

UDP is a connectionless transport service that dispenses with the reliability services provided by TCP. UDP gives applications a direct interface with IP and the ability to address a particular application process running on a host via a port number without setting up a connection session.

Virtual Server

You can designate virtual servers, e.g., a FTP, web, telnet or mail server, on your local network and make them accessible to the outside world. A virtual server means that it is not a dedicated server -- that is, the entire computer is not dedicated to running on the public network but in the private network.

VPI (Virtual Path Identifier) & VCI (Virtual Channel Identifier)

A VPI is a 8-bit field while VCI is a 16-bit field in the ATM cell header. A VPI identifies a link formed by a virtual path and a VCI identifies a channel within a virtual path. In this way,

the cells belonging to the same connection can be distinguished. A unique and separate VPI/VCI identifier is assigned in advance to indicate which type of cell is following, unassigned cells, physical layer OAM cells, metasingaling channel or a generic broadcast signaling channel. Your ISP should supply you with the values.

Appendix A: Specifications

Interface	<ul style="list-style-type: none">● One RJ-11 port for ADSL connection● Four RJ-45 ports for IEEE 802.3/802.3u 10/100 Base-T auto-sensing and auto-crossover Ethernet connection● One hidden reset button for restoring to factory default settings
Regulatory Approvals and Compliance	EMI: FCC part 15 Class B, CE Immunity: FCC part 68 Class B Safety: UL, CB, LVD
Power Requirement and Operation Environment Requirement	Power Adaptor: Input 110±10 or 230±10 VAC; Output 9 VAC, 1A Power Consumption: less than 10 Watt Ambient Temperature: 0 to 40°C (32 to 96°F) Relative Humidity: 20% to 90% (non-condensing)
Physical	Dimensions: 190mm(L) x 130mm(W) x 40mm(H) Weight: 350g

Appendix B: Server Setup for 802.1x Client

Getting Client Certificate

1. Please connect the client to a network that doesn't require port authentication.
2. Open up Microsoft Explorer in Windows XP, and go to `http://<yourserver>/certsrv`.
3. Authenticate to the server using your account that you created at the end of the server setup. (e.g. 123) and click OK. A dialog box might appear for you to choose.
4. Make sure that **Request a certificate** is selected, and click **Next**.

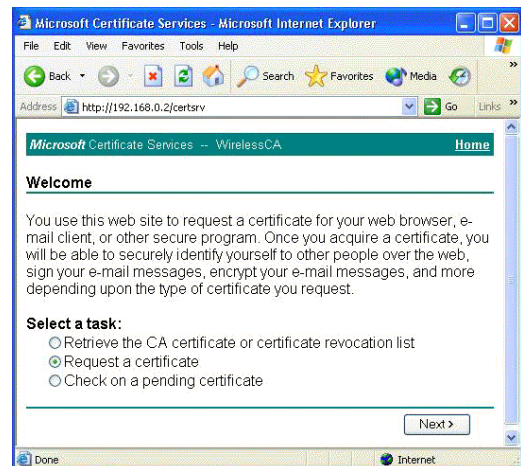

5. Make sure that **User certificate request: User Certificate** is selected, and click **Next**.

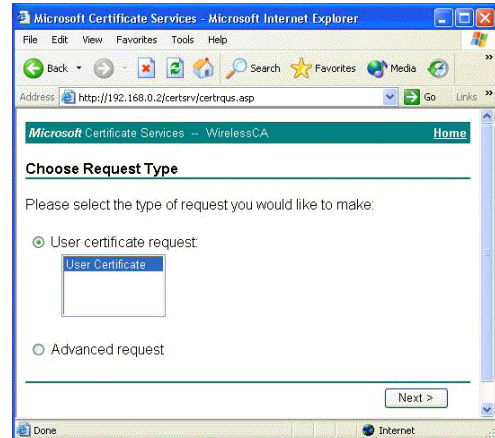

6. Click **Submit** in this dialog.

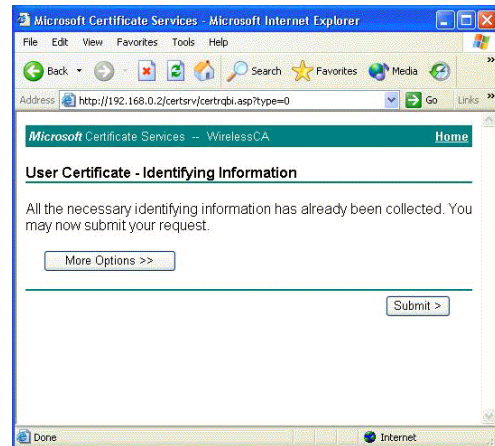

7. Now, you'll see status messages on the screen, then your certificate will be returned to you. Click **Install this certificate**.

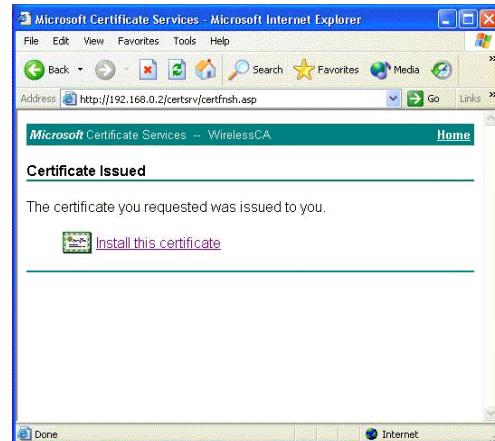

8. You'll receive a confirmation message about accepting the certificate, click **Yes**

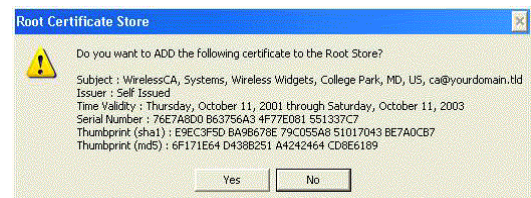

Appendix C: WEEE – B2C



All electrical and electronic products should be disposed of separately from the municipal waste stream via designated collection facilities appointed by the government or the local authorities.

The correct disposal and separate collection of your old appliance will help prevent potential negative consequences for the environment and human health. It is a precondition for reuse and recycling of used electrical and electronic equipment.

For more detailed information about disposal of your old appliance, please contact your city office, waste disposal service, the shop where you purchased the product or your SIEMENS partner.

The statements quoted above are only fully valid for equipment which is installed in the countries of the European Union and is covered by the directive 2002/96/EC.

Countries outside the European Union may have other regulations regarding the disposal of electrical and electronic equipment.