



# **ADSL Bridge Router**

**ADE-3000**

User's Manual

Copyright (C) 2002 PLANET Technology Corp. All rights reserved.

The products and programs described in this User's Manual are licensed products of PLANET Technology. This User's Manual contains proprietary information protected by copyright, and this User's Manual and all accompanying hardware, software, and documentation are copyrighted.

No part of this User's Manual may be copied, photocopied, reproduced, translated, or reduced to any electronic medium or machine-readable form by any means by electronic or mechanical. Including photocopying, recording, or information storage and retrieval systems, for any purpose other than the purchaser's personal use, and without the prior express written permission of PLANET Technology.

## Disclaimer

PLANET Technology does not warrant that the hardware will work properly in all environments and applications, and makes no warranty and representation, either implied or expressed, with respect to the quality, performance, merchantability, or fitness for a particular purpose.

PLANET has made every effort to ensure that this User's Manual is accurate; PLANET disclaims liability for any inaccuracies or omissions that may have occurred.

Information in this User's Manual is subject to change without notice and does not represent a commitment on the part of PLANET. PLANET assumes no responsibility for any inaccuracies that may be contained in this User's Manual. PLANET makes no commitment to update or keep current the information in this User's Manual, and reserves the right to make improvements to this User's Manual and/or to the products described in this User's Manual, at any time without notice.

If you find information in this manual that is incorrect, misleading, or incomplete, we would appreciate your comments and suggestions.

## CE mark Warning

This is a class B device. In a domestic environment, this product may cause radio interference, in which case the user may be required to take adequate measures.

## Trademarks

The PLANET logo is a trademark of PLANET Technology. This documentation may refer to numerous hardware and software products by their trade names. In most, if not all cases, these designations are claimed as trademarks or registered trademarks by their respective companies.

## Revision

User's Manual for PLANET ADSL Bridge/Router:

Model: ADE-3000

Rev: 2.0 (August 2002)

Part No.: EM-ADE3000V2

# TABLE OF CONTENTS

---

<b>CHAPTER 1 INTRODUCTION</b> .....	<b>1</b>
<b>ADE-3000 Features</b> .....	<b>1</b>
Internet Access Features .....	1
Advanced Functions.....	2
LAN Features.....	2
Configuration & Management .....	2
Security Features.....	2
<b>Package Contents</b> .....	<b>2</b>
<b>Physical Details</b> .....	<b>3</b>
Front Panel.....	3
Rear Panel.....	3
Restore Default IP Address and Clear Password.....	3
<b>CHAPTER 2 INSTALLATION</b> .....	<b>4</b>
<b>System Requirements</b> .....	<b>4</b>
<b>Installation Procedure</b> .....	<b>4</b>
<b>CHAPTER 3 LOGIN AND SYSTEM STATUS</b> .....	<b>6</b>
<b>Login</b> .....	<b>6</b>
Preparation.....	6
Connecting to ADE-3000.....	6
<b>Status</b> .....	<b>8</b>
<b>CHAPTER 4 SYSTEM CONFIGURATION</b> .....	<b>10</b>
<b>Overview</b> .....	<b>10</b>
<b>WAN configuration</b> .....	<b>10</b>
System Wide Settings .....	10
Per VC Setting .....	10
<b>Internet connection services</b> .....	<b>11</b>
Bridge Mode .....	11
PPPoE, PPPoA Connection for WAN (Routing mode) .....	13
Fixed IP for WAN.....	14
Dynamic IP for WAN .....	15
Other settings .....	16
<b>LAN Configuration</b> .....	<b>19</b>
DHCP Setting .....	19
<b>NAT Settings</b> .....	<b>20</b>
<b>Virtual Servers</b> .....	<b>23</b>
<b>Bridge Filtering</b> .....	<b>24</b>
<b>DNS Configuration</b> .....	<b>25</b>
<b>CHAPTER 5 PC CONFIGURATION</b> .....	<b>27</b>
<b>Overview</b> .....	<b>27</b>
<b>Windows Clients</b> .....	<b>27</b>
TCP/IP Settings .....	27
Windows 9x/ME.....	28
Windows 2000.....	29
Windows XP.....	32
Internet Access.....	33
Windows 9x/2000 .....	33

Windows XP.....	33
<b>Macintosh Clients</b> .....	<b>34</b>
<b>Linux Clients</b> .....	<b>34</b>
<b>CHAPTER 6 ADMIN PRIVILEGE</b> .....	<b>35</b>
<b>WAN Status</b> .....	<b>35</b>
<b>ATM Status</b> .....	<b>35</b>
<b>PPP Status</b> .....	<b>36</b>
<b>TCP Status</b> .....	<b>37</b>
<b>Route Table</b> .....	<b>37</b>
<b>Learned MAC Table</b> .....	<b>38</b>
<b>ADSL Configuration</b> .....	<b>38</b>
<b>RIP Configuration</b> .....	<b>39</b>
<b>Password Configuration</b> .....	<b>40</b>
<b>Miscellaneous Configuration</b> .....	<b>41</b>
<b>Reset to Factory Default</b> .....	<b>43</b>
<b>Diagnostic Test</b> .....	<b>43</b>
<b>Code Image Update</b> .....	<b>43</b>
<b>Network Code Image Update</b> .....	<b>43</b>
<b>System Log</b> .....	<b>44</b>
<b>APPENDIX A TROUBLESHOOTING</b> .....	<b>45</b>
<b>Overview</b> .....	<b>45</b>
<b>General Problems</b> .....	<b>45</b>
<b>Configuration and Internet Access</b> .....	<b>45</b>
<b>APPENDIX B SPECIFICATIONS</b> .....	<b>47</b>
<b>ADE-3000</b> .....	<b>47</b>

# Chapter 1

## Introduction



*This Chapter provides an overview of ADE-3000's features and capabilities.*

Congratulations on the purchase of ADE-3000. The ADSL Bridge Router will allow multiple LAN users to share an Internet user account, via a DSL connection. Once the ADSL Bridge Router is installed and configured, the Internet is just a click away.

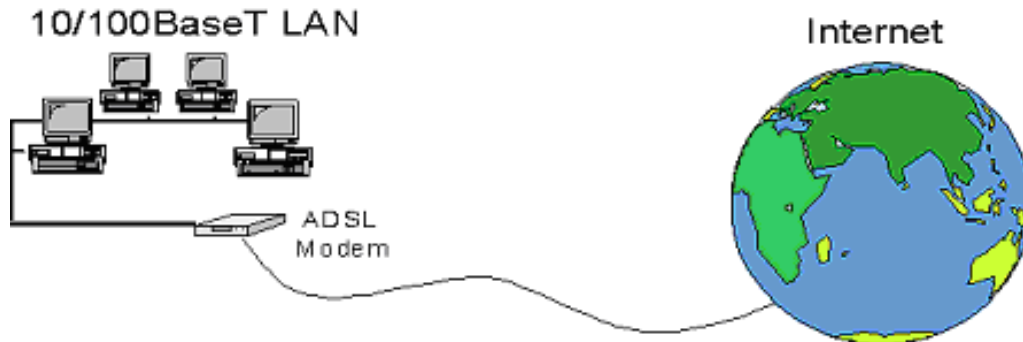

Figure 1-1: ADSL Bridge Router

### ADE-3000 Features

ADE-3000 incorporates many advanced features, carefully designed to provide sophisticated functions for user's convenience while surfing in the net.

#### Internet Access Features

- **Shared Internet Access.** All users on the LAN (up to 253 users) can access the Internet through ADE-3000, using only a single external IP Address. (router mode).
- **DSL Service Support.** ADE-3000 has a RJ-11 port for connecting a DSL connection to provide Internet resource sharing feature. All popular DSL service providers are supported.
- **Standard Compliance.** ADSL-Compliant with ANSI T1.413 Issue 2, ITU G.992.1 (G.dmt) Annex A , and G.992.2 (G.lite).
- **Data Transfer Rate.** Data rate up to 8 Mbps downstream and up to 1 Mbps upstream
- **Multi-system Support.** USB interface driver supports Microsoft Windows 98/ME/2000 and Windows XP.
- **User Friendly Interface.** Simple, intuitive, yet powerful graphical user interface can be accessed from common web browsers nowadays
- **Fixed or Dynamic IP Address.** On the Internet (WAN port) connection, ADE-3000 supports both Dynamic IP Address (IP Address is allocated on connection) and Fixed IP Address.

## Advanced Functions

- **Virtual Servers.** This feature allows Internet users to access Internet servers on your LAN. The required setup is quick and easy.
- **DMZ.** One (1) PC on your local LAN can be configured to allow unrestricted 2-way communication with Servers or individual users on the Internet. This provides the ability to run programs, which demand for bi-directional communication.
- **System Log & Internet Access diagnostics** ADE-3000 implements system log and Internet access diagnostic help users to diagnose what could be wrong via system log or Internet access diagnostics.
- **VPN Support.** VPN (Virtual Private Networking) connections using PPTP, L2TP and IPSec are transparently supported - no configuration is required.

## LAN Features

- **Dual Ethernet and USB ports.** One (the Ethernet RJ-45 port) is used to connect to your network adapter. The other (the USB port) can be connected to USB interface DSL/Cable router or directly with computer.
- **DHCP Server support.** Dynamic Host Configuration Protocol provides a dynamic IP address to PCs and other devices upon request. ADE-3000 can act as a DHCP Server for devices on your local LAN.

## Configuration & Management

- **Easy Setup.** Use WEB browser from anywhere to begin the configuration.
- **Remote Management.** The ADE-3000 can be managed from any PC on your LAN. And, if the Internet connection exists, it can also (optionally) be configured via the Internet.

## Security Features

- **Two-level password protected Configuration.** Two-level password protection can provide stronger protection to prevent unauthorized users from modifying the configuration data and settings.
- **NAT Protection.** An intrinsic side effect of NAT (Network Address Translation) technology is that by allowing all LAN users to share a single IP address, the location and even the existence of each PC is hidden. From the external viewpoint, there is no network, only a single device - ADE-3000.

## Package Contents

The following items should be included:

- ADE-3000 Unit
- Power Adapter
- Quick Installation Guide
- CD-ROM containing USB port driver
- USB cable
- RJ-11 cable

If any of the above items are damaged or missing, please contact your dealer immediately.

## Physical Details

### Front Panel

The front panel of ADE-3000 has 2 LEDs for one LAN port and one ADSL port. Figure 2 displays a front panel of the router.



Figure 1-2: *Front Panel*

LED definitions

Status ADSL	On – ADSL LED status will be on after chaining procedure with DSLAM is completed
Status LAN	On –LAN LED will be on while RJ-45 connector is plugged in.

### Rear Panel



Figure 1-3: *Rear Panel*

Button definition

Reset Button	<p>This button has two (2) functions:</p> <ul style="list-style-type: none"> <li>• When pressed and released, ADE-3000 will reboot (restart).</li> <li>• When reset button is pressed over 5 seconds and then release. ALL data will be clear and restore ALL settings to the factory default values.</li> </ul>
--------------	--

### Restore Default IP Address and Clear Password

If ADE-3000's IP Address or password is lost, the following procedure can be used to recover from this situation.

Pressing the Reset button for more than 5 seconds. ADE-3000 will restore to factory default setting. Note that this should be done only when you had tried all the troubleshooting options. Pressing the Reset button during operation may bring you into the risk of creating IP address conflict between your PC and the router. In such a case, you may be compelled to reboot your entire system(s).

# Chapter 2

## Installation

# 2

*This Chapter covers the physical installation of ADE-3000.*

### System Requirements

#### Computer

- PC or TCP/IP compliant workstations
- 32 MB RAM
- 20 MB of free disk space minimum (for USB driver installation)
- Ethernet Network Interface Controller (NIC) RJ45 Port
- USB Port
- Internet Browser

### Installation Procedure

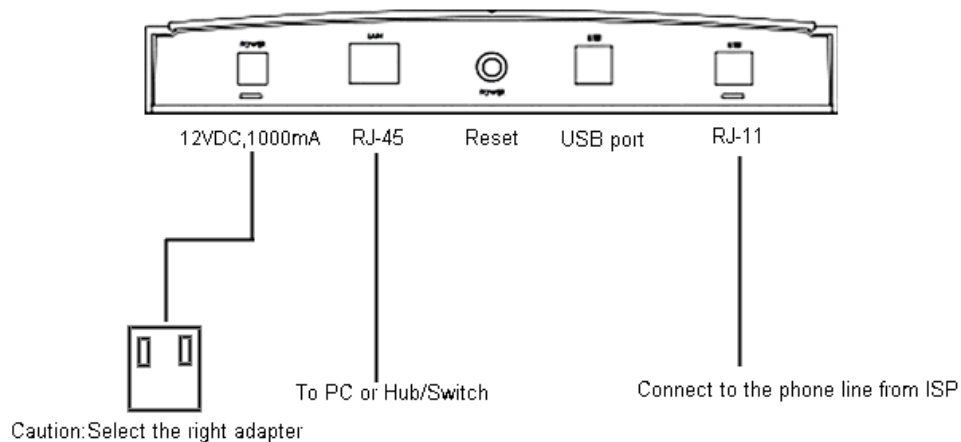

**Figure 2-1: Installation Diagram**

#### Step 1

##### Choose an Installation Site

Select a suitable place on the network to install ADE-3000. Ensure ADE-3000 is powered OFF.

#### Step 2

##### Connect LAN Cables

Use standard LAN cables to connect PCs to the ETHERNET port on ADE-3000. Either 10BaseT or 100BaseT connections can be used.



If required, use a standard LAN cable to connect the "Uplink" port to a standard port on another hub.

### Step 3

#### Connect WAN Cable

Connect one end of the RJ-11 phone cord to the LINE port on your ADSL modem. Connect the other end of the RJ-11 phone cord to your wall phone jack.

### Step 4

#### Power Up

Connect the supplied power adapter to ADE-3000 and power up. Use only the power adapter provided. Using a different one may cause hardware damage

### Step 5

#### Check the LEDs

If there is no cable or wrong cable connected, *LAN* LED on ADE-3000 should flash in Red, then turn OFF. If it stays Red, there might be a hardware error.

For each LAN (PC) connection, the LAN *Link/Act* LED should be **ON** (provided the PC is also ON.)

The *ADSL* LED should be **ON**.

## Chapter 3

# Login And System Status



*This Chapter details the first time login procedure and the Status screen*

### Login

ADE-3000 contains an HTTP server. This enables you to connect to it, and configure it, using your Web Browser. **Your Browser must have JavaScript support.** The configuration program has been tested on the following browsers:

- Netscape V4.08 or later
- Internet Explorer V4 or later

### Preparation

Before attempting to configure ADE-3000, please ensure that:

- Your PC can establish a physical connection to ADE-3000. The PC and ADE-3000 must be directly connected (using the ETHERNET port on ADE-3000) or on the same LAN segment.
- ADE-3000 must be installed and powered ON.
- If ADE-3000's default IP Address (**10.0.0.2**) is already used by another device, the other device must be turned OFF until ADE-3000 is allocated a new IP Address during configuration.

### Connecting to ADE-3000

To establish a connection from your PC to ADE-3000:

1. After installing ADE-3000 in your LAN, start your PC. If your PC is already running, restart it.
2. Start your WEB browser.
3. In the *Address* box, enter "HTTP://" and the IP Address of ADE-3000, as in this example, which uses ADE-3000's default IP Address:  
<http://10.0.0.2>
4. If connection is established, a pop-up password request page will show up. The default login User Name of ADE-3000 administrator is "**admin**", and Password is "**conexant**". The default login User Name for non-administrator is "**user**", and Password is "**password**".



Figure 3-1: Logon Window

### If you can't connect

If ADE does not respond, check the following:

- Machine is properly installed, LAN connection is OK, and it is powered ON. You can test the connection by using the "Ping" command:
  - Open the MS-DOS window or command prompt window.
  - Enter the command:  
ping 10.0.0.2  
If no response is received, either the connection is not working, or your PC's IP address is not compatible with ADE-3000's IP Address. (See next item.)
- If your PC is using a fixed IP Address, its IP Address must be within the range 10.0.0.3 to 10.255.255.254 to be compatible with ADE-3000's default IP Address of 10.0.0.2. Also, the *Network Mask* must be set to 255.0.0.0. See *Chapter 5 - PC Configuration* for details on checking your PC's TCP/IP settings.
- Ensure that your PC and ADE-3000 are on the same network segment. (If you don't have a router, this must be the case.)

## Status

### Home

Once you login in ADE-3000, its Home page will appear. It shows the firmware versions and WAN and LAN interface status.



Figure 3-2: Home page

### ADSL

The **ADSL Status** page shows the ADSL physical layer status.



Figure 3-3: ADSL status

## LAN

The **LAN** page shows the information and status of LAN port, DHCP client table, linking status of Ethernet and USB interface.

CONEXANT

Status

[Home](#)

[ADSL](#)

[LAN](#)

Configuration

[WAN](#)

[LAN](#)

[NAT](#)

[Virtual Server](#)

[Bridge Filtering](#)

IP Address	Subnet Mask	MAC Address
10.0.0.2	255.0.0.0	02:30:CD:00:07:FA

Number of ethernet devices connected to the DHCP server: 0

Ethernet Link Status: UP

USB Link Status: DOWN

Figure 3-4: LAN status

# Chapter 4

## System Configuration

# 4

*This Chapter details the configurations for ADE-3000*

### Overview

This chapter describes the setup procedure for:

- WAN Access
- LAN configuration

PCs on your local LAN may also require configuration. For details, see *Chapter 5 - PC Configuration*.

### WAN configuration

Select the WAN link under Configuration column to set up WAN connection. It is required to know the type of Internet connection service used by your ISP.

Note: You only need to fill in the fields that your ISP provided, and leave the others as default.

The screenshot shows the WAN Configuration page. On the left is a navigation menu with links for Home, ADSL, LAN, Configuration, WAN, LAN, NAT, Virtual Server, and Bridge Filtering. The main content area is titled 'WAN Configuration' and is divided into two sections: 'System Wide Settings' and 'Per VC Settings'. Under 'System Wide Settings', there is a 'Default Gateway' field containing '0.0.0.0'. Under 'Per VC Settings', there is a table with the following data:

Enabled?	VPI	VCI	Static IP Address	Subnet Mask
Yes	0	33	0.0.0.0	0.0.0.0

Below the table is a 'MAC SPOOFING' section with a 'Mac Spoofing' dropdown menu set to 'Disable' and a 'Mac Address' field containing '00:00:00:00:00:00'.

Figure 4-1: WAN Configuration

### System Wide Settings

Under the **System Wide Settings**, the configuration will take effect on all WAN PVCs.

**Default Gateway:** The default gateway is the next-hop router IP address on the Internet.

### Per VC Setting

Under **Per VC Setting**, it provides the configurations for IP address and VPI/VCI.

**Per VC Settings**

Enabled?	VPI	VCI	Static IP Address	Subnet Mask
Yes ▾	0	33	0.0.0.0	0.0.0.0

These two fields must be filled.

Figure 4-2: Per VC Settings

To switch between the PVCs, please choose the options of virtual circuit and click on the **Submit** button to switch over.

**DHCP**

DHCP client enable

Host Name

---

Virtual Circuit:

Submit Reset

Figure 4-3: Switch between PVCs

## Internet connection services

Types of Internet connection services supported by ADE-3000 are explained below.

### Bridge Mode

#### Step 1

At the WAN Configuration page, insert the VCI/VPI provided by ISP. Enable "**Bridge**", and choose suitable packet encapsulation.

**BRIDGE**

---

Enabled  
Disabled  
Enabled

Figure 4-4: Bridge status

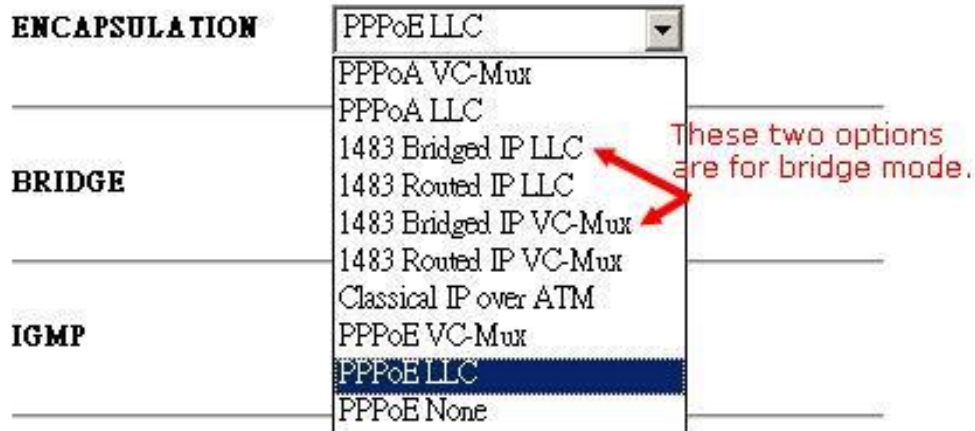

Figure 4-5: Encapsulation types of Bridge mode

**Step 2**

Click “**submit**” to commit modifications you’ve done, then click “**Save Configuration**” to store settings. (Modifications will not take effects until next reboot.)

**Step 3**

Click on “**NAT**” tab on left panel, and **disable** the NAT function in the option menu.

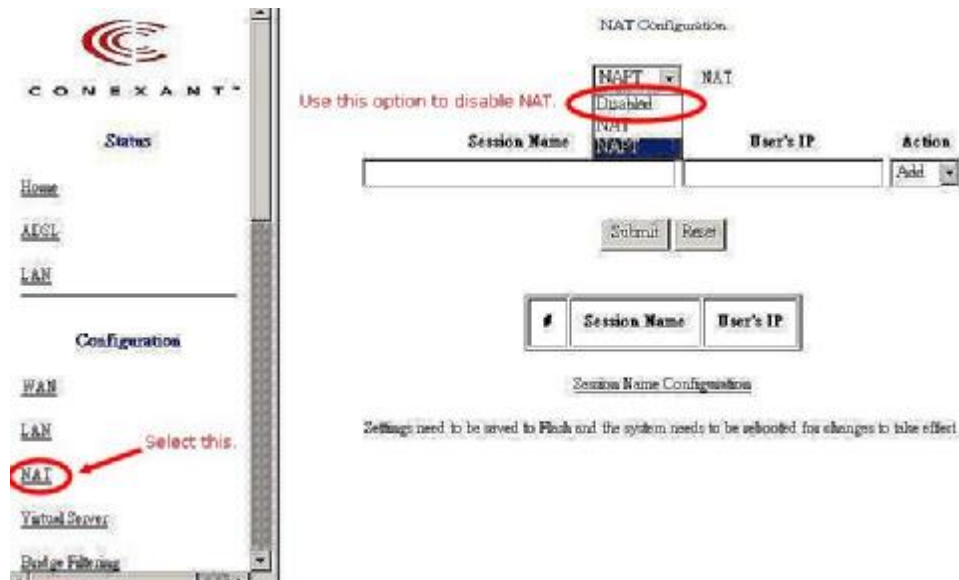

Figure 4-6: NAT Disable screen

**Step 4**

Click “**Save settings**” on left panel to write configuration into machine, and reboot to make settings effective.



## PPPoE, PPPoA Connection for WAN (Routing mode)

If PPPoE (Point-to-Point Over Ethernet) or PPPoA (Point-to-Point Over ATM) is provided to establish communications, **User Name** and **Password** are required to be obtained from ISP. And **VCI/VPI** values must be obtained from them as well, for some local ISPs don't offer this information actively.

To set up a PPPoE or PPPoA connection for WAN, follow the instructions below:

### Step 1

Fill in the VCI/VPI entries with the information you get from ISP.

### Step 2

Choose suitable packet encapsulation (PPPoA LLC/VC-Mux, PPPoE LLC/VC-Mux). Disable "Bridge". (Packet encapsulation information also has to be obtained from ISP.)

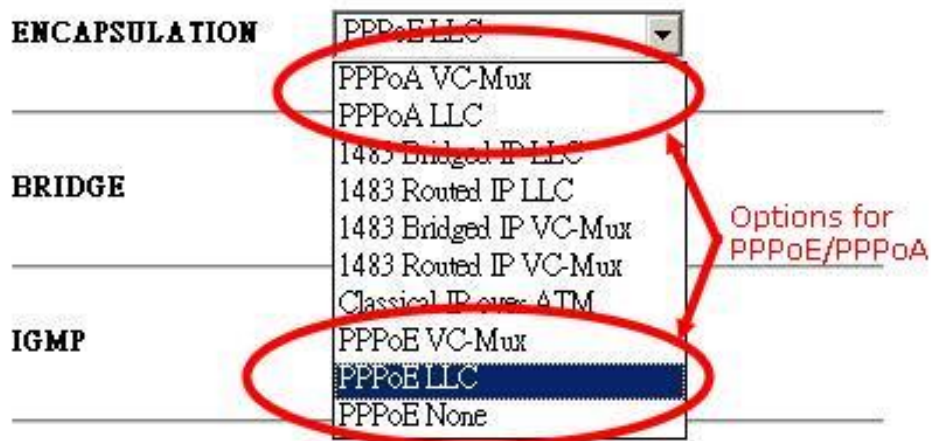

Figure 4-7: Encapsulation types of PPPoE/PPPoA

### Service Name

If your ISP provides this info, please type it into the field or leave it blank (factory default).

### User Name and Password

Fill in the entries with the information provided by ISP.

### Disconnect Timeout

It is the amount of time you would like to pass before the Router drops your Internet connection due to inactivity. Enter zero (0) in the field to remain Internet connection on at all time. The idle time ranges from 0 to 32767 seconds.

### Authentication

When **AUTO** option is chosen, the PAP mode will run first then CHAP.

### Automatic Reconnect

If you check this option, the Disconnect Timeout should set to 0 second. Otherwise there will be a conflict between them.

### DHCP

Leave this option unchecked.

**PPP**

Service Name	<input type="text"/>
Username	<input type="text" value="t0195090"/>
Password	<input type="password" value="*****"/>
Disconnect Timeout	<input type="text" value="0"/> seconds ( <b>Max:32767</b> )
Authentication	<input type="text" value="Auto"/> ▼
<input checked="" type="checkbox"/> Automatic Reconnect	

---

**DHCP**

<input type="checkbox"/> DHCP client enable	Don't check this in PPP settings.
Host Name	<input type="text"/>

Figure 4-8: PPP setting Screen

**Step 3**

Click on “NAT” tab on left panel, and **enable** the **NAPT** function in the option menu.

**Step 4**

Click “**Save settings**” on left panel to write configuration into machine, and reboot to make settings effective.

**Fixed IP for WAN**

If your ISP has assigned static IP address (See Appendix A *About Static and Dynamic IP Address*), you may connect to the Internet by using a fixed, or static address. To set up a Fixed IP for WAN, do the following steps as an example.

**Step 1**

Enter the information of **Default Gateway**, **IP Address**, and **Subnet Mask** provided by ISP. Note: These parameters are required for building up connection. If one of these information incorrect or unavailable, please contact your ISP for correct information.

**WAN Configuration**

---

**System Wide Settings**

Default Gateway:

You should obtain these info from ISP.

---

**Per VC Settings**

Enabled?	VPI	VCI	Static IP Address	Subnet Mask
Yes	0	33	0.0.0.0	0.0.0.0

**MAC SPOOFING**

Mac Spoofing:

Mac Address:

Figure 4-9: Fixed IP set-up screen

**Step 2**

Choose suitable packet encapsulation (1483 Bridged/ Routed LLC, 1483 Bridged/ Routed Mux, Classical IP over ATM). And **Disable** “Bridge” function.

**Step 3**

Click “**submit**” to commit modifications you’ve done, then click “**Save Configuration**” to store settings. (Modifications will not take effects until next reboot.)

**Step 3**

Click on “**NAT**” tab on left panel, and **enable** the **NAPT** function in the option menu.

**Step 4**

Click “**Save settings**” on left panel to write configuration into machine, and reboot to make settings effective.

**Dynamic IP for WAN**

If ISP provides a dynamic IP for Internet connection, following steps illustrate how to enable the connection via ADE-3000.

**Step 1**

Choose suitable packet encapsulation (1483 Bridged/ Routed LLC, 1483 Bridged/ Routed Mux, Classical IP over ATM). And **Disable** “Bridge” function.

**Step2**

Check the **DHCP** option, and fill in the Host Name field (if required.) (This information should be obtained from ISP. If there is no special demand for this, leave this column blank.)

Figure 4-10: DHCP client enable

**Step 3**

Click on “NAT” tab on left panel, and **enable** the **NAPT** function in the option menu.

**Step 4**

Click “**Save settings**” on left panel to write configuration into machine, and reboot to make settings effective.

**Other settings**

Here are explanations about some fields not mentioned above.

**MAC Spoofing**

The **MAC Spoofing** is developed to solve the scenario when the ISP only recognizes one MAC address. Copy the ISP-recognized MAC address here.

Figure 4-11: MAC Spoofing

**ATM**

If your ISP provides this information to you, fill it in appropriate field.

**Service Category**

UBR and CBR are two different types of service supported from the ATM.

**Bandwidth**

Bandwidth setting takes effect only when the CBR is selected. The maximum available bandwidth is from the upstream data rate of ADSL status page (see Section, ADSL).

Figure 4-12: ATM Bandwidth Category

**IGMP**

Support IGMP proxy/relay function for ADSL modem, based on the following

requirement and case:

- On CO side, there must be at least one IGMP querier (router) present. IGMP querier will send IGMP query packet. The ADSL modem is responsible to relay these IGMP query to Ethernet.
- End-user multicast application device send IGMP report while receiving IGMP query or being activated by user, the ADSL modem should be responsible to proxy (that is, change source IP to ADSL modem's WAN IP) the IGMP report to ADSL WAN side, include all PVCs. The same case is for IGMP leave packet.
- It is not necessary to relay multicast routing between two ADSL PVCs or two interfaces in LAN side.
- Special purpose multicast packet (such as RIP 2 packet) should run without interference.

Table 4-1 IGMP packets process

Rx Entity	Packet Class	TTL	Action	Notes
ADSL	IGMP query	1	Relay to Ethernet	
	IGMP report	1	Ignore	
	IGMP leave	1	Ignore	
	General Multicast IP	-	Relay it to Ethernet.	
Ethernet	IGMP query	1	Ignore	
	IGMP report	1	Relay to all ADSL PVC	
	IGMP leave	1	Relay to all ADSL PVC	
	General Multicast IP	-	Ignore	

**Note:** Before the IGMP mode is enabled; please go to the **Miscellaneous Configuration** page to enable the IGMP proxy. Otherwise, the IGMP selection will not be valid.

Table 4-1 WAN configurations Overview

	Bridge Mode (Dynamic IP)	Router Mode (Dynamic IP)	Router Mode (Static IP)
<b>WAN Configuration</b>			
VC0 Enabled	Yes	Yes	Yes
VC1 - VC7 Enabled	No	No	No
VC0 Static IP Address	N/A (0.0.0.0)	N/A (0.0.0.0)	Provided by ISP
VC0 Subnet Mask	N/A (0.0.0.0)	N/A (0.0.0.0)	Provided by ISP
<b>WAN Advanced Configuration</b>			
Encapsulation*	1483 Bridged IP LLC	PPPoE LLC / PPPoA VCM	1483 Routed IP LLC
Bridge	Enabled	Disabled	Disabled
PPP Service Name	N/A	Blank	N/A
PPP User Name	N/A	Provided by ISP	N/A
PPP Password	N/A	Provided by ISP	N/A
DHCP client enable	Check None	Checked	Check None
<b>LAN Configuration</b>			
DHCP Server	Not Checked	Checked	Checked
<b>NAT Configuration</b>			
NAT	Disabled	NAPT	NAPT
<b>DNS Configuration</b>			
Default Gateway	N/A (0.0.0.0)	N/A (Automatically Assigned by ISP)	Provided by ISP
Preferred DNS Server	N/A (0.0.0.0)	N/A (Automatically Assigned by ISP)	Provided by ISP
Alternate DNS Server	N/A (0.0.0.0)	N/A (Automatically Assigned by ISP)	Provided by ISP
<b>RIP Configuration</b>			
RIP	Disabled	Disabled	Disabled

**Note:** Encapsulation is based on the ISP configuration. It may be different for different ISPs and countries.

## LAN Configuration

The LAN IP and Subnet Mask of ADE-3000 are the values seen by the users on their internal network. The default IP is **10.0.0.2** for IP and **255.0.0.0** for Subnet Mask.

LAN Configuration

IP Address	<input type="text" value="10.0.0.2"/>
Subnet Mask	<input type="text" value="255.0.0.0"/>

Figure 4-13: LAN Configuration

## DHCP Setting

A DHCP (Dynamic Host Configuration Protocol) Server automatically assigns IP address to each computer on your network. Unless you already have one, it is highly recommended that your router be set up as a DHCP server..

- **System Allocated**

The DHCP address pool is based on LAN port IP address plus 12 IP addresses. For example, the LAN IP address is 10.0.0.2; the DHCP address pool is at the range of 10.0.0.3 to 10.0.0.14.

- **User Defined**

The DHCP address pool is at the range of **User Defined Start Address** and **User Defined End Address**. **Maximum IP pool size in ADE-3000 is 253**.  
IP address range: 255 total IP addresses – 1 broadcast address – 1 LAN port IP address.

- **Lease time**

The Lease time is the amount of time of a network user will be allowed to connect with DHCP server. **If all fields are 0, the allocated IP addresses will be effective forever.**

- **User mode**

**Single User** mode: DHCP server only allocates one IP address to local PC.

**Multiple User** mode: DHCP server allocates the IP addresses specified by the DHCP address pool.

**DHCP Server**

DHCP address pool selection  System Allocated  
 User Defined

User Defined Start Address

User Defined End Address

Lease Time  days  hours  minutes  seconds

User Mode  ▼

[Ethernet Mode Setting](#)

Settings need to be saved to Flash and the system needs to be rebooted for changes to take effect.

Figure 4-14: DHCP server settings

• **Ethernet Mode Setting:**

By clicking this link, you will be directed to Ethernet Mode page. You can specify the type of LAN connection or use AutoSense. Default is AutoSense.

[Ethernet Mode](#)

**Ethernet Mode:**  ▼

Settings need to be saved to Flash and the system needs to be rebooted for changes to take effect.

Figure 4-15: Ethernet Mode

## NAT Settings

By clicking NAT link under Configuration column, NAT Configuration page will be shown. You have to define the session used for NAT first. Click the Session Name Configuration link below, you will see NAT Session Name Configuration page.





Figure 4-16: NAT configuration

Enter the session name you want to use for NAT. Select VC number, which is assigned to the session. Choose **Add**, and then click **Submit** button, the new defined session should be added to the table below immediately. If you want to remove an existing session, the procedures are similar as above, just choose **Delete** instead.

#### NAT Session Name Configuration

Session Name

Virtual Circuit:

Interface Name	Session Name
PVCO	NewSession

[Go back to NAT Configuration](#)

Settings need to be saved to Flash and the system needs to be rebooted for changes to take effect.

Figure 4-17: NAT Session Name Configuration

After session defining, click the Go back to NAT Configuration link.

Two types of **NAT** (Network Address Translation) service are provided by ADE-3000.

**NAT**

**NAT** option only maps single WAN IP address to the local PC IP address. This is peer-to-peer mapping (1 on 1). For each PVC, only one local PC IP address can be associated with each WAN PVC. **If more than one IP address is inserted for one NAT session, only the first IP address of each session takes effect.**

**NAPT**

**NAPT** option maps the IP address and UDP/TCP port ID of the WAN PVC to the IP address and UDP/TCP port ID of the local PCs. (1 to N). It is the multiple-mapping mechanism. More than one local PC can be associated with one WAN PVC.

The setting procedures are as follows:

NAT Configuration

Choose which type of NAT mapping you want to use

NAPT NAT

Disabled NAT NAPT

Session Name	User's IP	Action
		Add

Submit Reset

#	Session Name	User's IP
---	--------------	-----------

Session Name Configuration

Settings need to be saved to Flash and the system needs to be rebooted for changes to take effect.

Figure 4-18: NAPT configuration screen

NAT Configuration

NAPT NAT

Session Name	User's IP	Action
		Add

Submit Reset

Enter the session name here Specify which IP address assigned for this session

#	Session Name	User's IP
---	--------------	-----------

Session Name Configuration

Settings need to be saved to Flash and the system needs to be rebooted for changes to take effect.

Figure 4-19: Enter Session name and User's IP

After all these settings are done, click “**Submit**” button, the record will be added to the table below immediately.

NAT Configuration

NAT

Session Name	User's IP	Action
<input type="text" value="NewSession"/>	<input type="text" value="10.0.0.3"/>	<input type="button" value="Add"/>

#	Session Name	User's IP
1	NewSession	10.0.0.3

Session Name Configuration

Settings need to be saved to Flash and the system needs to be rebooted for changes to take effect.

Figure 4-20: Adding a new record

## Virtual Servers

Virtual server feature allows users to make Servers on your LAN accessible to Internet users. Normally, Internet users would not be able to access a server on your LAN because of native NAT protection.

The "Virtual Server" feature solves these problems and allows Internet users to connect to your servers.

**For Internet users to access all virtual Servers on LAN side, they have to connect to WAN port IP on ADE-3000 allocated by ISP.**

To provide server-based service, WAN IP address should be static, rather than dynamic, to make it easier for Internet users to connect to your Servers.

However, *DDNS (Dynamic DNS)* service allows users to connect to your Virtual Servers using a URL, instead of an IP Address.

You can set up public services on your network by configuring the values in the Virtual Server Configuration page. You may assign certain IP addresses as the destination of the network information. When users from the Internet make certain requests of your network, ADE-3000 will forward those requests to the appropriate computer. (Note: DHCP function must be disabled or the local server itself has to be fix-IP addressed to use this function.)

This function is generally used to set up a web server, ftp server, or e-mail server on your network. Figure shows the screen of Virtual Server Configuration page,

**To add a Virtual Server:**

**Step 1**

Select the **public port** number used by the service, ranged from 0 to 65535.

**Step 2**

Select the **private port** number used on internal server mapping to public port, it is not required to be the same as public port number.

**Step 3**

Select appropriate communication type via **type of port** checkbox.

**Step 4**

Enter the **Host IP Address** of local server that you want the Internet users to be able to access.

**Step 5**

Click the “**Add This Setting**” button to save the settings.

**Step 6**

Click “**Save settings**” on left panel to write configuration into machine, and reboot to make settings effective.

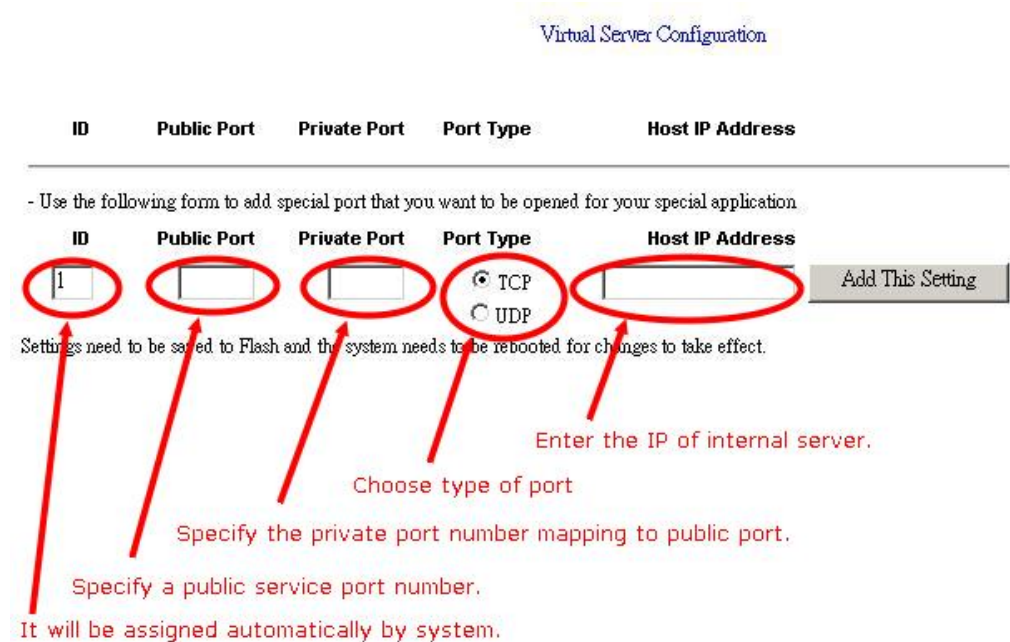

Figure 4-21: Virtual Server Configuration Screen

**Bridge Filtering**

The **Bridge Filtering** configuration page allows you to set the configuration of IP filtering. You can add 4 records max.

**Source MAC**

When the bridge filtering is enabled, enter the **Source MAC address**, select **Block** and click **Add**. Then all incoming WAN and LAN Ethernet packets matched with this source MAC address will be filtered out. If the **Forward** is selected, then the packets will be forwarded to the destination PC.

### Destination MAC

When the bridge filtering is enabled, enter **the Destination MAC address**, select **Block** and click **Add**. Then all incoming WAN and LAN Ethernet packets matched with this destination MAC address will be filtered out. If the **Forward** is selected, then the packets will be forwarded to the destination PC.

### Type

Enter the hexadecimal number for the Ethernet type field in Ethernet\_II packets. For example, 0800 is for IP protocol.

Bridge Filtering

Enable Bridge Filtering:  Yes  No

ID	Source MAC*	Destination MAC*	TYPE**			
1	<input type="text"/>	<input type="text"/>	<input type="text"/>	<input checked="" type="radio"/> Block	<input type="radio"/> Forward	<input type="button" value="Add"/>

\* MAC address should look like 000002fa6fab  
 \*\* TYPE is Ethernet type should look like a5ff

Figure 4-22: Bridge Filtering Screen

## DNS Configuration

The **DNS Configuration** page allows you to set the configuration of DNS proxy. The Conexant firmware supports the DNS proxy function. For the DHCP requests from local PCs, the DHCP server will set the LAN port IP as the default DNS server. Thus, all DNS query messages will come into LAN port first. The DNS proxy on the ADSL modem recorded the available DNS servers, and forward DNS query messages to one of DNS server.

Four DNS proxy modes available in ADE-3000:

### Disable DNS Proxy

The LAN port does not process the DNS query message. For the DHCP requests from local PCs, the DHCP server will set the user-configured preferred DNS server or alternate DNS server whichever is available as the DNS server. Then all DNS query messages will be directly sent to the DNS servers.

### Use Auto Discovered DNS Servers Only

The DNS proxy will store the DNS server IP addresses obtained from DHCP client or PPP into the table. And all DNS query messages will be sent to one of the dynamically obtained DNS servers.

### Use User Configured DNS Servers Only

The DNS proxy will use the user-configured preferred DNS server and alternate DNS server. And all DNS query message will be sent to one of DNS servers.

### Auto Discovery + User Configured

The DNS proxy's table has all the IP addresses of dynamically obtained and user configured DNS servers.

DNS Configuration

DNS Proxy Selection

**User Configuration**

Preferred DNS Servers

Alternate DNS Server

Settings need to be saved to Flash and the system needs to be rebooted for the changes to take effect.

Figure 4-23: DNS Configuration Screen

**Note:** Before the DNS proxy mode is enabled; please go to the **Miscellaneous Configuration** to enable the DNS proxy. Otherwise, DNS Proxy selection will not be valid.

## Chapter 5

# PC Configuration



*This Chapter details the PC Configuration required on the local ("Internal") LAN.*

### Overview

For each PC, the following may to be configured:

- TCP/IP network settings
- Internet Access configuration

### Windows Clients

This section describes how to configure Windows clients for Internet access via ADE-3000.

The first step is to check the PC's TCP/IP settings.

ADE-3000 uses the TCP/IP network protocol for all functions, so it is essential that the TCP/IP protocol be installed and configured on each PC.

### TCP/IP Settings

**If default ADE-3000 settings are loaded, and default Windows 95/98/ME/2000 TCP/IP configuration, no changes need to be made.**

- By default, ADE-3000 will act as a DHCP Server, automatically providing a suitable IP Address (and related information) to each PC when the PC boots.
- For all non-Server versions of Windows, the default TCP/IP setting is to act as a DHCP client.
- If you wish to check your TCP/IP settings, the procedure is described in the following sections.

## Windows 9x/ME

1. Select *Control Panel - Network*. You should see a screen like the following:

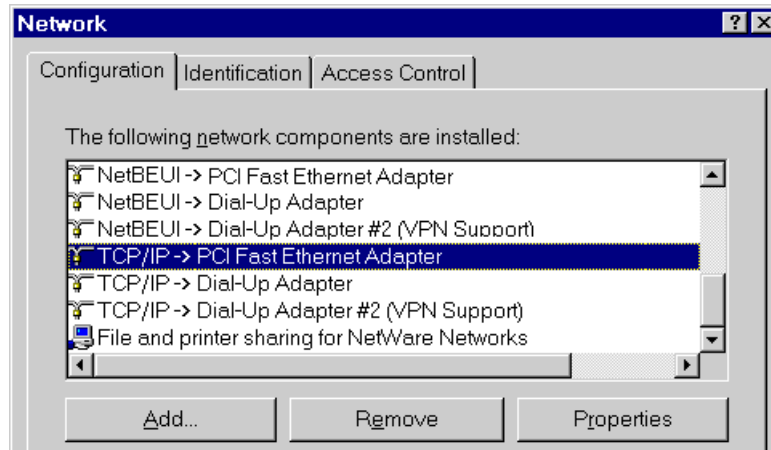

Figure 5-1: Network Configuration

2. Select the *TCP/IP* protocol for your network card.
3. Click on the *Properties* button. You should then see a screen like the following.

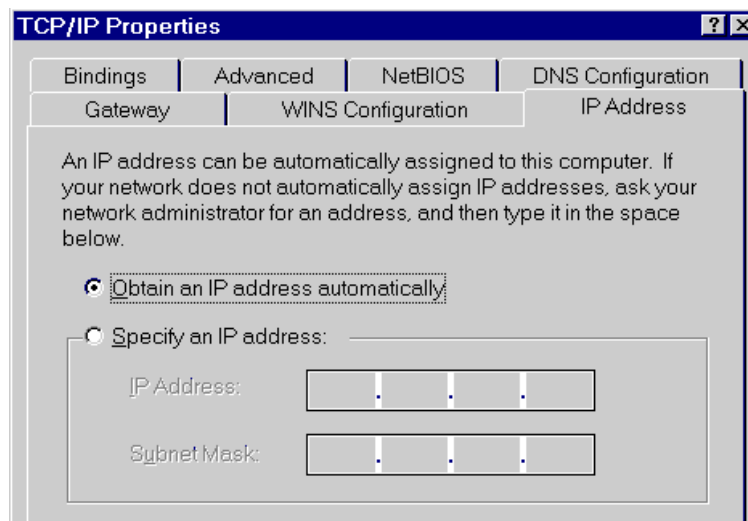

Figure 5-2: IP Address (Win 95)

Ensure your TCP/IP settings are correct, as follows:

### Using DHCP

To use DHCP, select the radio button *Obtain an IP Address automatically*. This is the default Windows settings.

Restart your PC to ensure it obtains an IP Address from ADE-3000.

### Using "Specify an IP Address"

- If your PC is already configured, do NOT change the settings on the IP Address tab shown in **Figure** above.
- On the *Gateway* tab, enter ADE-3000's IP address in the *New Gateway* field and click *Add*, as shown below. Your LAN administrator can advise you of the IP Address they assigned to ADE-3000.



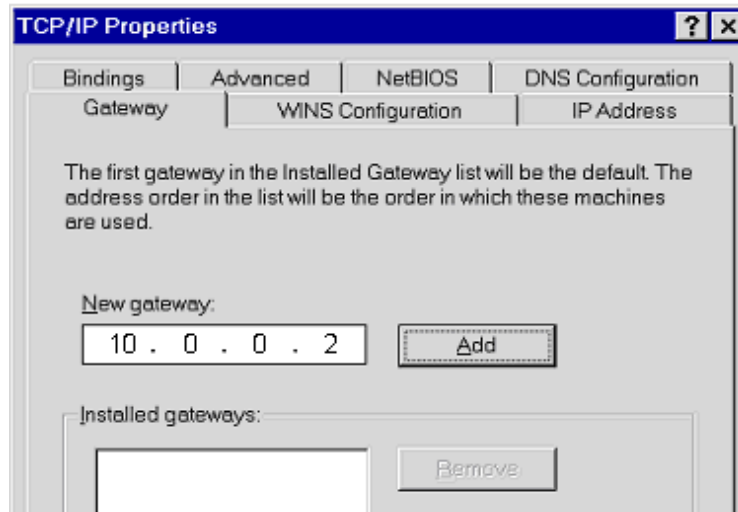

Figure 5-3: Gateway Tab (Win 95/98)

- On the *DNS Configuration* tab, ensure *Enable DNS* is selected. If the *DNS Server Search Order* list is empty, enter the DNS address provided by your ISP in the fields beside the *Add* button, then click *Add*.

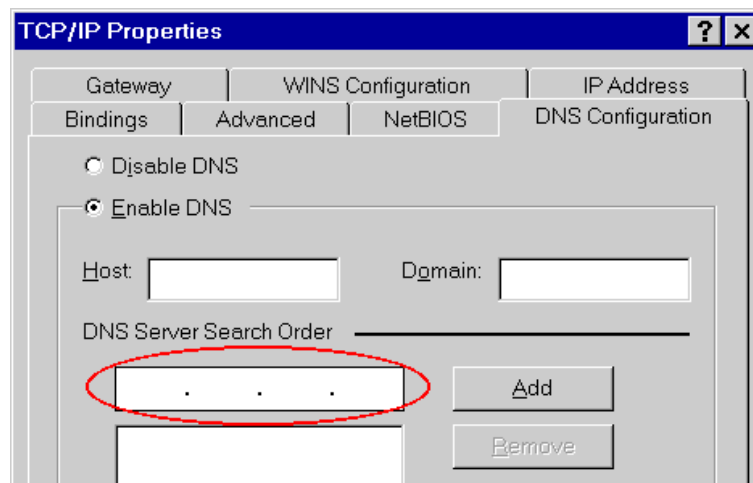

Figure 5-4: DNS Tab (Win 95/98)

### Windows 2000

1. Select *Control Panel - Network and Dial-up Connection*.
2. Right click the *Local Area Connection* icon and select *Properties*. You should see a screen like the following:

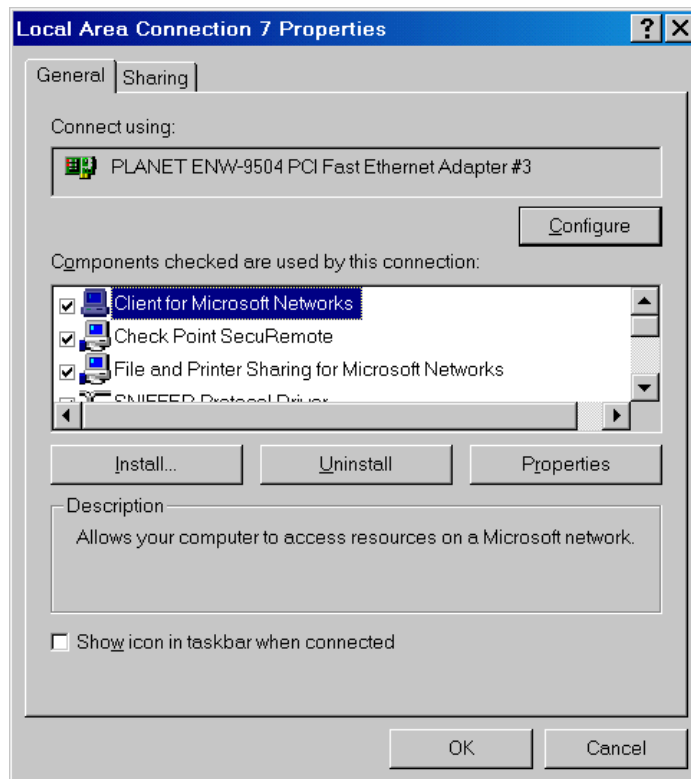

Figure 5-5: Network Configuration (Win 2000)

3. Select the *TCP/IP* protocol for your network card.
4. Click on the *Properties* button. You should then see a screen like the following.

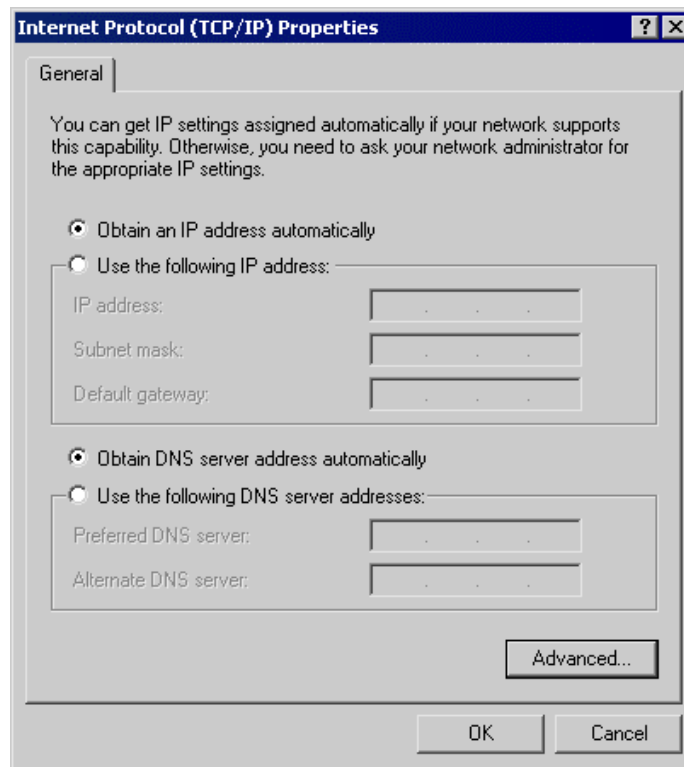

Figure 5-6: TCP/IP Properties (Win 2000)

5. Ensure your TCP/IP settings are correct:

### Using DHCP

To use DHCP, select the radio button *Obtain an IP Address automatically*. This is the default Windows settings.

Restart your PC to ensure it obtains an IP Address from ADE-3000.

### Using a fixed IP Address ("Use the following IP Address")

If your PC is already configured, check with your network administrator before making the following changes.

- Enter ADE-3000's IP address in the *Default gateway* field and click *OK*. (Your LAN administrator can advise you of the IP Address they assigned to ADE-3000.)
- If the *DNS Server* fields are empty, select *Use the following DNS server addresses*, and enter the DNS address or addresses provided by your ISP, then click *OK*.

## Windows XP

1. Select Control Panel - Network Connection.
2. Right click the *Local Area Connection* and choose *Properties*. You should see a screen like the following:

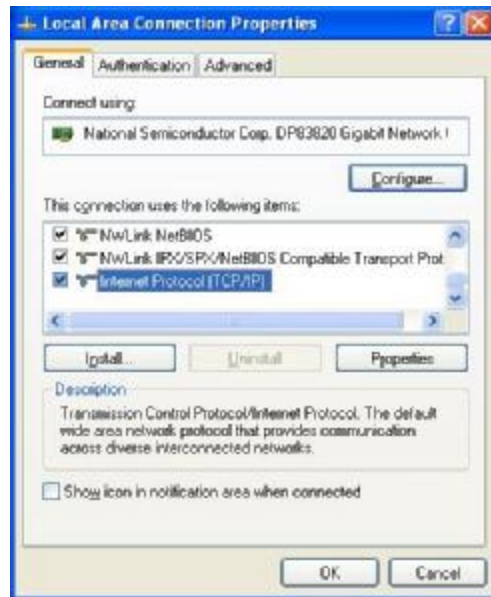

Figure 5-7: Network Configuration (Windows XP)

3. Select the *TCP/IP* protocol for your network card.
4. Click on the *Properties* button. You should then see a screen like the following.



Figure 5-8: TCP/IP Properties (Windows XP)

5. Ensure your TCP/IP settings are correct.

## Using DHCP

To use DHCP, select the radio button *Obtain an IP Address automatically*. This is the default Windows settings.

Restart your PC to ensure it obtains an IP Address from ADE-3000.

## Using a fixed IP Address ("Use the following IP Address")

- If your PC is already configured, do NOT change the settings on the screen shown in **Figure** above, unless advised to do so by your network administrator.
- You can enter ADE-3000's IP address in the *Default gateway* field and click *OK*. Your LAN administrator can advise you of the IP Address they assigned to ADE-3000.
- If the *DNS Server* fields are empty, select *Use the following DNS server addresses*, and enter the DNS address or addresses provided by your ISP, then click *OK*.

## Internet Access

To configure your PCs to use ADE-3000 for Internet access:

- Use the following procedure to configure your Browser to access the Internet via the LAN, rather than by a Dial-up connection.

### Windows 9x/2000

1. Select *Start Menu - Settings - Control Panel - Internet Options*.
2. Select the *Connection* tab, and click the *Setup* button.
3. Select "I want to set up my Internet connection manually, or I want to connect through a local area network (LAN)" and click *Next*.
4. Select "I connect through a local area network (LAN)" and click *Next*.
5. Ensure all of the boxes on the following *Local area network Internet Configuration* screen are **unchecked**.
6. Check the "No" option when prompted "Do you want to set up an Internet mail account now?".
7. Click *Finish* to close the Internet Connection Wizard.  
Setup is now completed.

### Windows XP

1. Select *Start Menu - Control Panel - Network and Internet Connections*.
2. Select *Set up or change your Internet Connection*.
3. Select the *Connection* tab, and click the *Setup* button.
4. Cancel the pop-up "Location Information" screen.
5. Click *Next* on the "New Connection Wizard" screen.
6. Select "Connect to the Internet" and click *Next*.
7. Select "Set up my connection manually" and click *Next*.
8. Check "Connect using a broadband connection that is always on" and click *Next*.
9. Click *Finish* to close the New Connection Wizard.  
Setup is now completed.

## Macintosh Clients

From your Macintosh, you can access the Internet via ADE-3000. The procedure is as follows.

1. Open the TCP/IP Control Panel.
2. Select *Ethernet* from the *Connect via* pop-up menu.
3. Select *Using DHCP Server* from the *Configure* pop-up menu. The DHCP Client ID field can be left blank.
4. Close the TCP/IP panel, saving your settings.

### Note:

If using manually assigned IP addresses instead of DHCP, the only change required is to set the *Router Address* field to ADE-3000's IP Address.

## Linux Clients

To access the Internet via ADE-3000, it is only necessary to set ADE-3000 as the "Gateway".

**Ensure you are logged in as "root" before attempting any changes.**

### Fixed IP Address

By default, most Unix installations use a fixed IP Address. If you wish to continue using a fixed IP Address, make the following changes to your configuration.

- Set your "Default Gateway" to the IP Address of ADE-3000.
- Ensure your DNS (Name server) settings are correct.

### To act as a DHCP Client (recommended)

The procedure below may vary according to your version of Linux and X -windows shell.

1. Start your X Windows client.
2. Select *Control Panel - Network*
3. Select the "Interface" entry for your Network card. Normally, this will be called "eth0".
4. Click the *Edit* button, set the "protocol" to "DHCP", and save this data.
5. To apply your changes
  - Use the "Deactivate" and "Activate" buttons, if available.
  - OR, restart your system.

# Chapter 6

## Admin Privilege

# 6

*This Chapter details the operation of ADE-3000 and the status screens.*

The links under **Admin Privilege** are only to be accessed and configured, when it is login with administrator login name and password.

### WAN Status

The **WAN Status** page shows the information and status of WAN PVCs. Select the VC number to view connection status.

The **DHCP Release and Renew** allows users to release and renew the WAN IP address in the WAN DHCP Client Enabled (dynamic) mode.

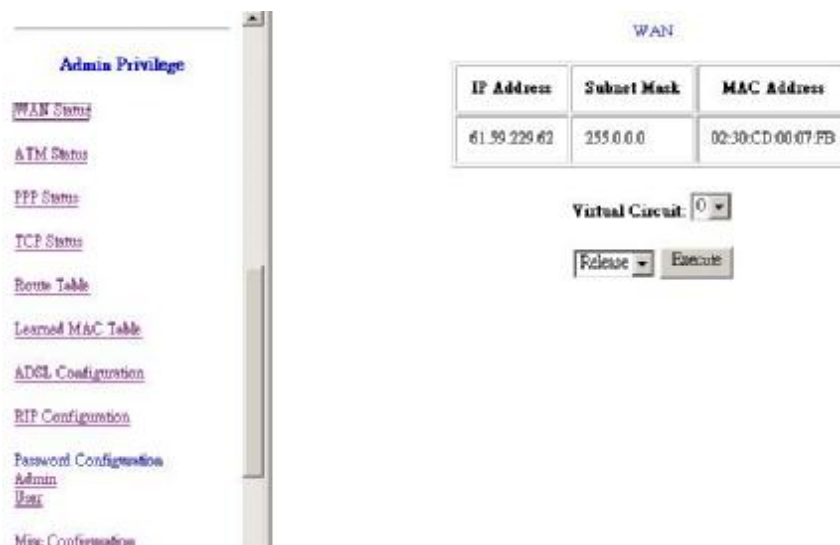

Figure 6-1: WAN Status Screen

### ATM Status

The **ATM Status** page shows all the statistics information of ATM cells.



Figure 6-2: ATM Status Screen

## PPP Status

The **PPP Status** page shows the status of PPP for each PVC. Connect and Disconnect allows you to manually connect/disconnect the PPP connection for specified PVC.

If current connection is disconnected after the **Disconnect Timeout**, you will have to go to this page, choose the correct **PVC** and **Connect** option, and then click **Execute** to restart a new PPP session.

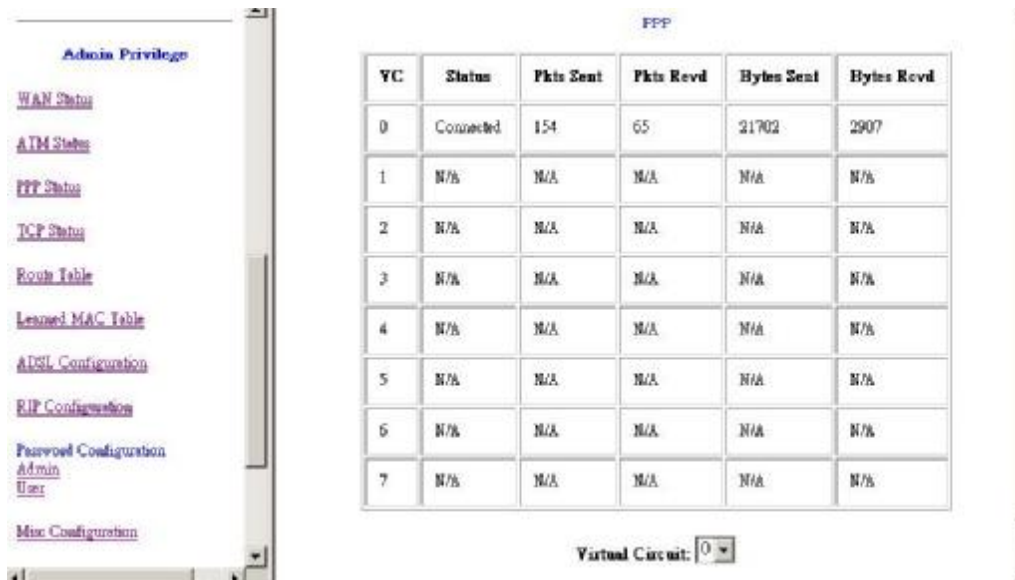

Figure 6-3: PPP Status Screen



## TCP Status

The **TCP Status** page shows the statistics for all TCP connections. This is for internal network only.

The screenshot shows the 'TCP STATUS' page. On the left is a sidebar menu with 'Admin Privilege' selected. The main content area displays a table with the following data:

TCP STATUS	
Total Packets Sent	1701
Data Packets Sent	1083
Data Bytes Sent	592812
Total Packets Received	1376
Packets Received in-sequence	206
Bytes Received in-sequence	76086
Out of Order Packets	205
Out of Order Bytes	0
Packets discarded for bad checksum	3
Packets discarded for bad header offset	0
Packets discarded because too short	0

Figure 6-4: TCP Status Screen

## Route Table

The **Route Table** page displays routing table and allows you to manually enter the routing entry. The interface br0 means the USB interface; lo0 means the loop back interface.

The screenshot shows the 'Route Table' page. On the left is a sidebar menu with 'Admin Privilege' selected. The main content area displays a table with the following data:

Destination	Netmask	Gateway	Interface
0.0.0.0	0.0.0.0	61.59.229.1	ppp1
10.0.0.0	255.0.0.0	10.0.0.2	br0
61.59.229.1	255.255.255.255	61.59.229.62	ppp1
127.0.0.1	255.0.0.0	127.0.0.1	lo0

Below the table is a form to add a new entry:

Destination	Gateway	Netmask	Action
<input type="text"/>	<input type="text"/>	<input type="text"/>	Add <input type="button" value="v"/>

Below the form are 'Submit' and 'Reset' buttons. A note at the bottom reads: "Note: Save changes to flash to secure on power up."

Figure 6-5: Route Table Screen

## Learned MAC Table

The **Learned MAC Table** page shows the current learned Bridge MAC table. The **Aging Timeout** is for determining the update period for the MAC table.



Figure 6-6: *Learned MAC Table Screen*

## ADSL Configuration

The **ADSL Configuration** page allows you to set the configuration for ADSL protocols.

### Trellis

Trellis Code. By default, it is always enabled.

### Handshake Protocol

This is for the ADSL handshake protocol.

### Wiring Selection

The wiring selection for the RJ-11.

### Bit Swapping

Bit swapping enables an ADSL system to change the number of bits assigned to a subcarrier, or change the transmit energy of a subcarrier without interrupting data flow. (No need to configure this item unless it is necessary)

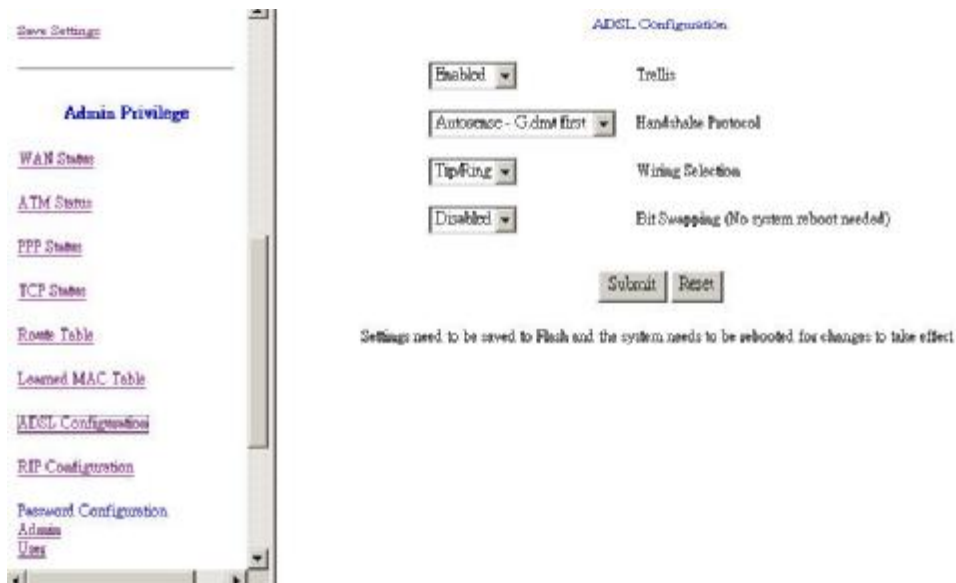

Figure 6-7: ADSL Configuration Screen

## RIP Configuration

**RIP Configuration** allows users to setup RIPv1/v2 support and related parameters in ADE-3000.

### RIP

Start or Stop a RIP session. The resulting RIP session will monitor all network interfaces that are currently available for messages from other RIP routers.

### Supplier

If the supplier parameter is true, it will also respond to specific requests from other routers and transmit route updates over every known interface at the interval specified by Interval.

### Gateway

Specifying a gateway setting of true establishes this router as a gateway to the wider Internet, capable of routing packets anywhere within the local networks.

### Multicast

The value True indicates that the RIP messages are sent to the pre-defined multicast address of 224.0.0.9 (which requires a version setting of 2). Otherwise, it will use broadcast address.

### Interval

The interval of the RIP information will be advertised.

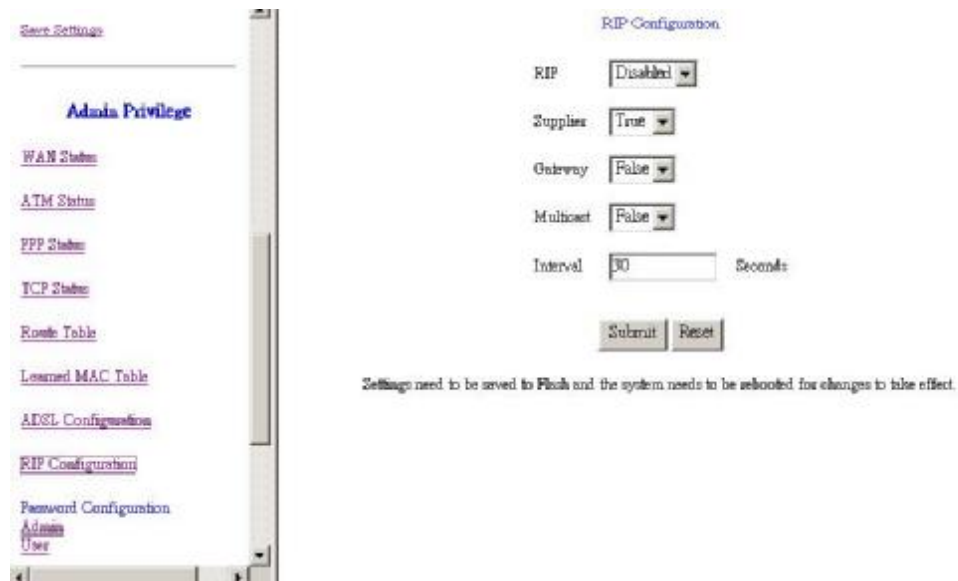

Save Settings

**Admin Privilege**

[WAN Status](#)

[ATM Status](#)

[PPP Status](#)

[TCP Status](#)

[Route Table](#)

[Learned MAC Table](#)

[ADSL Configuration](#)

[RIP Configuration](#)

[Password Configuration](#)

[Admin](#)

[User](#)

RIP Configuration

RIP

Supplier

Gateway

Multicast

Interval  Seconds

Settings need to be saved to Flash and the system needs to be rebooted for changes to take effect.

Figure 6-8: RIP Configuration Screen

## Password Configuration

The **Password Configuration** page allows users to set the passwords for user and administrator.

## Miscellaneous Configuration

The **Miscellaneous Configuration** allows users to set all the miscellaneous configurations in ADE-3000.

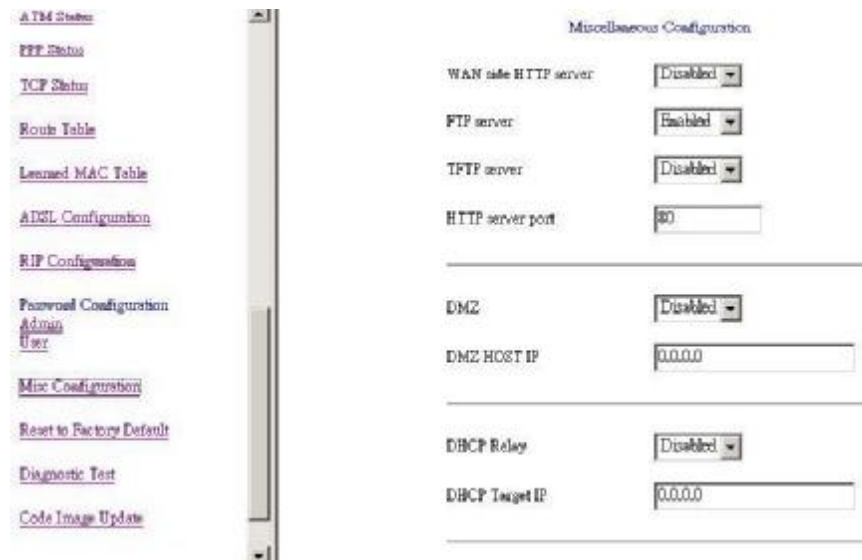

Figure 6-9: Miscellaneous Configuration Screen

### WAN side HTTP server

When it is enabled, the Web setting pages of ADE-3000 can be accessed from the WAN side. When it is disabled, you can only access the Web pages from the LAN side.

### FTP server

When it is enabled, the FTP connection can be established from both the LAN and WAN sides.

### TFTP server

When it is enabled, it can upgrade the image code with the TFTP client application run at either the LAN or WAN sides.

An example for the TFTP client updating the vxworks.z product image code is:

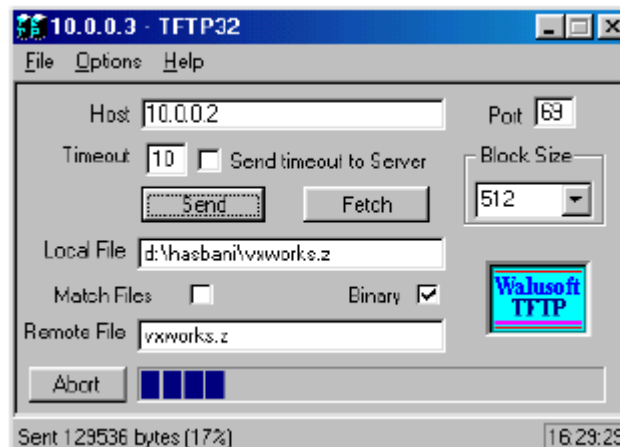

Figure 6-10: Example for TFTP server

### HTTP server port

The HTTP server port can be changed to other secure port number. For example, when it is changed to 1001, the HTTP server address for the LAN side is <http://10.0.0.2:1001>.

### DMZ

A DMZ (De-Militarized Zone) is added between a protected network and an external network, in order to provide an additional layer of security. When there is a suspected packet coming from WAN, the firewall will forward this packet to the DMZ host.

### DMZ Host IP

The IP address of the DMZ host at LAN side.

### DHCP Relay

If it is enabled, the DHCP requests from local PCs will forward to the DHCP server runs on WAN side. To have this function working properly, please disable the NAT to run on router mode only, disable the DHCP server on the LAN port, and make sure the routing table has the correct routing entry.

### DHCP Target IP

The DHCP server runs on WAN side.

### IGMP Proxy

Here is the global setting for IGMP Proxy. If it is enabled, then the enabled IGMP Proxy on WAN PVCs will be working. Otherwise, no WAN PVC can have IGMP Proxy working on it.

### PPP connect on WAN access

If it is enabled, the PPP session will be automatically established when there is a packet wants to go out the WAN.

The differences between PPP connect on WAN access and the Automatic Reconnect:

Some ISPs would terminate the PPP session due to the inactivity.

For the **PPP connect on WAN access**, the PPP will be automatically reconnected when an URL is entered in the browser (packet interested in going out the WAN).

For the **Automatic Reconnect**, it will reconnect the PPP session whenever it is terminated by ISP.

### PPP Half Bridge:

When the PPP Half Bridge is enabled, only one PC is able to access the Internet, and the DHCP server will duplicate the WAN IP address from the ISP to the local client PC.

**Only the PC with the WAN IP address can access the Internet.**

## Reset to Factory Default

The **Reset to Factory Default** page allows you to reset the modem to original factory default configuration (factory.reg).

## Diagnostic Test

Click this link; system will perform diagnostic tests automatically. And show the testing result in **Diagnostic Test** page. If some of the tests fail, related help links are available for reference while troubleshooting.



Figure 6-11: Diagnostic Test Result Screen

## Code Image Update

The **Code Image Update** page allows you to upgrade the image code locally. Browse the location of firmware file, and click the **Upload** to start the update.

## Network Code Image Update

The **Network Code Image Update** page allows user to upgrade the image code from remote FTP server.

Assume an FTP server stores the updated image on Internet. Click Image Download to initiate the updating. To set up the ftp server IP address, please save the UpdateHost parameter under [Class\ Service\System] in the config.reg file as the IP address of the specific Ftp server on Internet.

## System Log

Users may acquire information of the system from this screen, including the time, and connection process related messages.

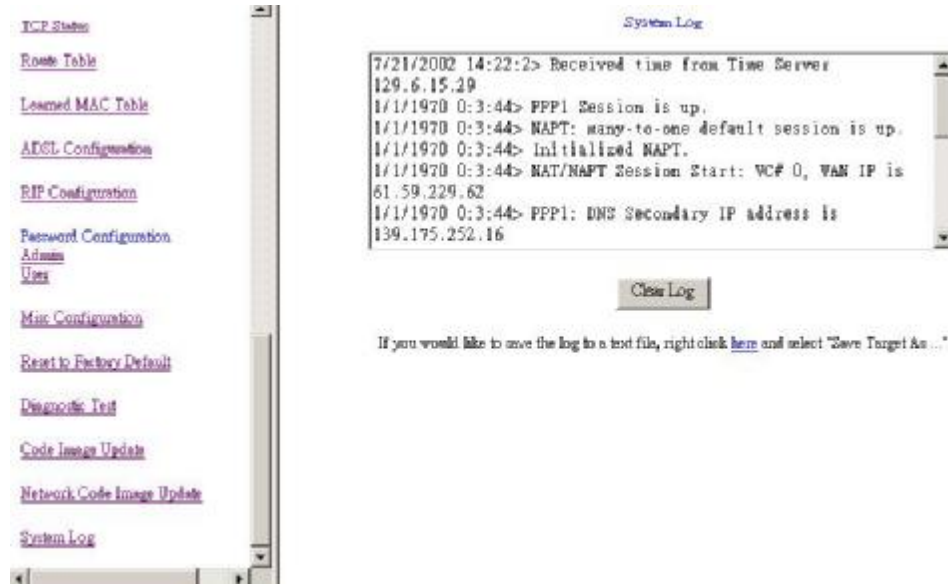

Figure 6-12: System Log Screen



# Appendix A

## Troubleshooting



*This Appendix covers the most likely problems and their solutions.*

### Overview

This chapter covers some common problems that may be encountered while using ADE-3000 and some possible solutions to them. If you follow the suggested steps and ADE-3000 still does not function properly, contact your dealer for further advice.

### General Problems

<b>Question 1:</b>	<b>Can't connect to ADE-3000 to configure it.</b>
<b>Answer 1:</b>	<p>Check the following:</p> <ul style="list-style-type: none"><li>• ADE-3000 is properly installed, LAN connections are OK, and it is powered ON.</li><li>• Ensure that your PC and ADE-3000 are on the same network segment. (If you don't have a router, this must be the case.)</li><li>• If your PC is set to "Obtain an IP Address automatically" (DHCP client), restart it.</li><li>• If your PC uses a Fixed (Static) IP address, ensure that it is using an IP Address within the range 10.0.0.3 to 10.255.255.254 and thus compatible with ADE-3000's default IP Address of 10.0.0.2. Also, the Network Mask should be set to 255.0.0.0 to match ADE-3000.</li></ul> <p>In Windows, you can check these settings by using <i>Control Panel-Network</i> to check the <i>Properties</i> for the TCP/IP protocol.</p>

### Configuration and Internet Access

<b>Question 1</b>	<b>When I enter a URL or IP address I get a time out error.</b>
<b>Answer 1</b>	<p>A number of things could be causing this.</p> <p>Try the following troubleshooting steps.</p> <ul style="list-style-type: none"><li>• Check if other PCs work. If they do, ensure that your PCs IP settings are correct. If using a Fixed IP Address, check the Network Mask, Default gateway and DNS configured on PC.</li><li>• If the PCs are configured correctly, but still not working, check ADE-3000. Ensure that it is connected and ON. Connect to it and check its settings. (If you can't connect to it, check the LAN and power connections.)</li><li>• If ADE-3000 is configured correctly, contact your ISP to see if Internet connection is working correctly.</li></ul>
<b>Question 2</b>	<b>If the PPP is disconnected after the Disconnect Timeout and how can I reconnect it?</b>

	I reconnect it?
<b>Answer 2</b>	You have to go to the PPP Status under Admin Privileged column, choose the correct <b>PVC</b> and <b>Connect</b> option, and then click <b>Execute</b> to restart a new PPP secession.
<b>Question 3</b>	Since only one PVC is mapped to one local PC IP address, why can I input more than one IP address for one NAT session?
<b>Answer 3</b>	Even it is applicable to insert multiple IPs for NAT mapping, only the first IP address of each session takes effect.

# Appendix B

## Specifications



### ADE-3000

Model	ADE-3000
Dimensions	175 mm (W) * 130 mm (D) * 32 mm (H)
Operating temperature	0° C to 40° C
Storage temperature	-10° C to 70° C
Network Protocol:	UDP, TFTP, TCP/ IP, ICMP, ARP, RIP I/ II, N .T, HTTP, DHCP, IGMP, IPSec, PPPoE, PPTP, L2TP, NAPT,
ATM Protocol and Encapsulations	RFC 2364 – PPP over ATM VCMUX RFC 2364 – PPP over ATM LLC RFC 2516 – PPP over Ethernet VCMUX RFC 2516 – PPP over Ethernet LLC SNAP RFC 1577 - Classic IP over ATM RFC 1483 – Bridged IP over ATM LLC SNAP RFC 1483 – Routed IP over ATM LLC SNAP RFC 1483 – Bridged IP over ATM VCMUX RFC 1483 – Routed IP over ATM VCMUX ATM AAAL5 AAAL5 UBR & CBR OAM F4/F5 VPI/VCI range: 0 to 255/0 to 65536 Up to 8 PVCs (simultaneous and encapsulation independent)
Network Interface:	LAN port: RJ-45 interface: 10/100M, Half or Full Duplex, auto-negotiation USB interface: USB 1.1 Type B full speed 12Mbps WAN port: RJ11 for ADSL connection
External Power Adapter	12V AC, 1000mA

#### FCC Statement:

This device complies with Part 15 of the FCC Rules. Operation is subject to the following two conditions:

- (1) This device may not cause harmful interference.
- (2) This device must accept any interference received, including interference that may cause undesired operation.

**CE Marking Warning**

This is a Class B product. In a domestic environment this product may cause radio interference in which case the user may be required to take adequate measures.