

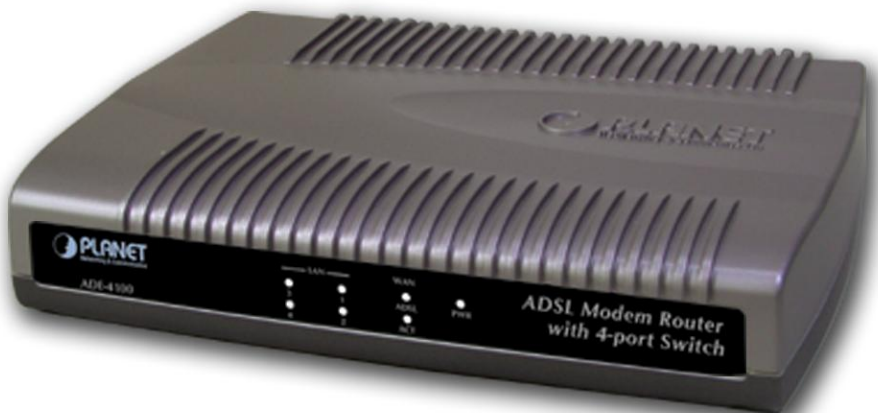

ADSL Modem Router With 4-port Switch

ADE-4100

User's Manual



Copyright

Copyright (C) 2003 PLANET Technology Corp. All rights reserved.

The products and programs described in this User's Manual are licensed products of PLANET Technology. This User's Manual contains proprietary information protected by copyright, and this User's Manual and all accompanying hardware, software, and documentation are copyrighted.

No part of this User's Manual may be copied, photocopied, reproduced, translated, or reduced to any electronic medium or machine-readable form by any means by electronic or mechanical. Including photocopying, recording, or information storage and retrieval systems, for any purpose other than the purchaser's personal use, and without the prior express written permission of PLANET Technology.

Disclaimer

PLANET Technology does not warrant that the hardware will work properly in all environments and applications, and makes no warranty and representation, either implied or expressed, with respect to the quality, performance, merchantability, or fitness for a particular purpose.

PLANET has made every effort to ensure that this User's Manual is accurate; PLANET disclaims liability for any inaccuracies or omissions that may have occurred.

Information in this User's Manual is subject to change without notice and does not represent a commitment on the part of PLANET. PLANET assumes no responsibility for any inaccuracies that may be contained in this User's Manual. PLANET makes no commitment to update or keep current the information in this User's Manual, and reserves the right to make improvements to this User's Manual and/or to the products described in this User's Manual, at any time without notice.

If you find information in this manual that is incorrect, misleading, or incomplete, we would appreciate your comments and suggestions.

FCC Compliance Statement

This equipment generates and uses radio frequency energy and if not installed and used properly, that is, in strict accordance with the instructions provided with the equipment, may cause interference to radio and TV communication. The equipment has been tested and found to comply with the limits for a Class A computing device in accordance with the specifications in Subpart B of Part 15 of FCC rules, which are designed to provide reasonable protection against such interference in a residential installation. However, there is no guarantee that interference will not occur in a particular installation. If you suspect this equipment is causing interference, turn your Ethernet Switch on and off while your radio or TV is showing interference, if the interference disappears when you turn your Ethernet Switch off and reappears when you turn it back on, there is interference being caused by the Ethernet Switch.

You can try to correct the interference by one or more of the following measures:

- w Reorient the receiving radio or TV antenna where this may be done safely.
- w To the extent possible, relocate the radio, TV or other receiver away from the Switch.
- w Plug the Ethernet Switch into a different power outlet so that the Switch and the receiver are on different branch circuits.

If necessary, you should consult the place of purchase or an experienced radio/television technician for additional suggestions.

CE mark Warning

The is a class B device, In a domestic environment, this product may cause radio interference, in which case the user may be required to take adequate measures.

Trademarks

The PLANET logo is a trademark of PLANET Technology. This documentation may refer to numerous hardware and software products by their trade names. In most, if not all cases, these designations are claimed as trademarks or registered trademarks by their respective companies.

Revision

User's Manual for PLANET ADSL Modem Router:

Model: ADE-4100A/ADE-4100B

Rev: 1.0 (August 2003)

Part No.: EM-ADE4100

TABLE OF CONTENTS

CHAPTER 1 INTRODUCTION	1
ADE-4100 FEATURES	1
<i>Internet Access Features</i>	1
<i>Advanced Functions</i>	1
<i>LAN Features</i>	2
<i>Configuration & Management</i>	2
<i>Security Features</i>	2
PACKAGE CONTENTS	2
PHYSICAL DETAILS.....	3
<i>Front Panel</i>	3
<i>Rear Panel</i>	3
CHAPTER 2 INSTALLATION	5
SYSTEM REQUIREMENTS.....	5
INSTALLATION PROCEDURE	5
CHAPTER 3 LOGIN AND SYSTEM STATUS.....	7
LOGIN.....	7
<i>Preparation</i>	7
<i>Connecting to ADE-4100</i>	7
STATUS	9
CHAPTER 4 SYSTEM CONFIGURATION.....	11
OVERVIEW.....	11
WAN CONFIGURATION	11
<i>Per VC Setting</i>	11
INTERNET CONNECTION SERVICES	12
<i>Bridge Mode</i>	12
<i>PPPoE, PPPoA Connection for WAN (Routing mode)</i>	13
<i>Fixed IP for WAN</i>	16
<i>Dynamic IP for WAN</i>	16
<i>Other settings</i>	17
LAN CONFIGURATION	20
<i>DHCP Setting</i>	20
PPP CONFIGURATION.....	21
NAT SETTINGS.....	23
VIRTUAL SERVERS	25
DNS CONFIGURATION	27
BRIDGE FILTERING	27
SAVE SETTINGS	28
CHAPTER 5 PC CONFIGURATION.....	29
OVERVIEW.....	29
WINDOWS CLIENTS.....	29
<i>TCP/IP Settings</i>	29
<i>Internet Access</i>	35
MACINTOSH CLIENTS	36
LINUX CLIENTS	36
CHAPTER 6 ADMIN PRIVILEGE	37
WAN STATUS	37
ATM STATUS	37

TCP STATUS.....	38
ROUTE TABLE.....	39
LEARNED MAC TABLE.....	40
ADSL CONFIGURATION.....	41
RIP CONFIGURATION.....	41
PASSWORD CONFIGURATION.....	43
MISC CONFIGURATION.....	43
RESET TO FACTORY DEFAULT.....	46
DIAGNOSTIC TEST.....	46
CODE IMAGE UPDATE.....	47
NETWORK CODE IMAGE UPDATE.....	47
SYSTEM LOG.....	47
APPENDIX A TROUBLESHOOTING.....	48
OVERVIEW.....	48
GENERAL PROBLEMS.....	48
CONFIGURATION AND INTERNET ACCESS.....	48
APPENDIX B SPECIFICATIONS.....	50
ADE-4100A/ADE-4100B.....	50

Chapter 1

Introduction

1

This Chapter provides an overview of ADE-4100's features and capabilities.

Congratulations on the purchasing of ADE-4100. The ADSL Modem Router will allow multiple LAN users to share an Internet user account, via a DSL connection. Once the ADSL Modem Router is installed and configured, the Internet is just a click away.

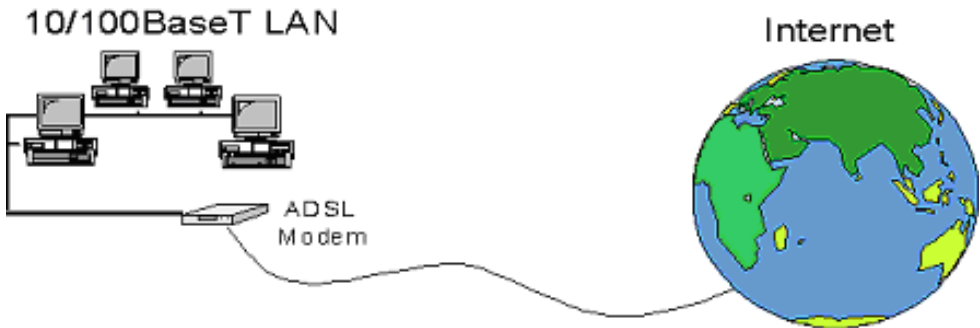

Figure 1-1: ADSL Modem Router

ADE-4100 Features

ADE-4100 incorporates many advanced features, carefully designed to provide sophisticated functions for user's convenience while surfing in the net.

Internet Access Features

- w **Shared Internet Access.** All users on the LAN can access the Internet through ADE-4100, using only a single external IP Address. (Routing mode)
- w **Standard Compliance.** ADSL-Compliant with ANSI T1.413 Issue 2, ITU G.992.1 (G.DMT), and G.992.2 (G.lite).
- w **Data Transfer Rate.** Data rate up to 8 Mbps downstream and up to 1 Mbps upstream
- w **User Friendly Interface.** Simple and intuitive graphical user interface
- w **Fixed or Dynamic IP Address.** On the Internet (WAN port) connection, ADE-4100A/4100B supports both Dynamic IP Address (IP Address is allocated on connection) and Fixed IP Address.

Advanced Functions

- w **Virtual Servers.** This feature allows Internet users to access Internet servers which located on LAN side. The required setup is quick and easy.
- w **DMZ.** One (1) PC on your local LAN can be configured to allow unrestricted 2-way communication with Servers or individual users on the Internet. This provides the ability to run programs which demand for bi-directional communication.

LAN Features

- w **Built-in 4-port switch.** Four Auto-Negotiation, Auto-MDI/MDI-X Ethernet RJ-45 ports are used to connect office network or workstations.
- w **DHCP Server support.** Dynamic Host Configuration Protocol provides a dynamic IP address to PCs and other devices upon request. ADE-4100 can act as a DHCP Server for devices on your local LAN.

Configuration & Management

- w **Easy Setup.** Use WEB browser from anywhere to begin the configuration.
- w **Remote Management.** PLANET ADE-4100 can be managed from any PC on your LAN. And, if the Internet connection exists, it can also (optionally) be configured via the Internet.
- w **System Diagnostic & Log:** 7 layer diagnostics with links to help pages and system event logs can greatly help network administrator solve network problem.

Security Features

- w **Two-level password protected Configuration.** Two-level password protection can provided stronger protection to prevent unauthorized users from modifying the configuration data and settings.
- w **NAT Protection.** An intrinsic side effect of NAT (Network Address Translation) technology is that by allowing all LAN users to share a single IP address, the location and even the existence of each PC is hidden. From the external viewpoint, there is no network, only a single device - ADE-4100.

Package Contents

The following items should be included:

- ADE-4100 Unit
- Power Adapter
- CD-ROM containing user's manual
- Quick Installation Guide
- RJ-45 cable
- RJ-11 cable

If any of the above items are damaged or missing, please contact your dealer immediately.

Physical Details

Front Panel

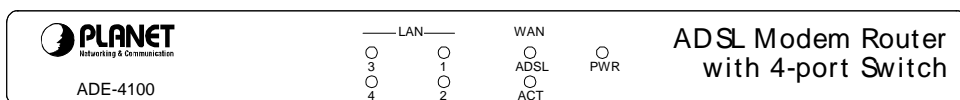

Figure 1-2: *Front Panel*

LED definitions

LEDs		Color	Active	Description
PWR		Green	ON	The power adaptor is connected to the Modem.
WAN	ADSL	Green	ON	ADSL connection is established.
	ACT	Green	ON	Transmit data or receive data via ADSL link.
LAN	1	Green	ON	Transmit data or receive data over Ethernet link.
	2			
	3			
	4			

Rear Panel

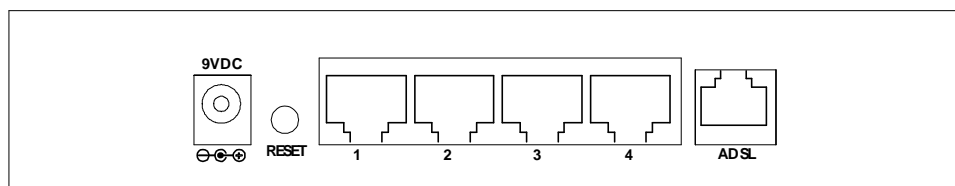

Figure 1-3: *Rear Panel*

Button definition

Reset Button	<p>This button has two (2) functions:</p> <ul style="list-style-type: none"> When pressed and released, ADE-4100 will reboot (restart). When reset button is pressed over 10 seconds and then release. ALL data will be clear and restore ALL settings to the factory default values.
--------------	---

Restore Default IP Address and Clear Password

If ADE-4100's IP Address or password is lost, the following procedure can be used to recover from this situation.

Pressing the Reset button for more than 10 seconds. ADE-4100 will restore to factory default setting. Note that this should be done only when you had tried all the troubleshooting options. Pressing the Reset button during operation may bring you into the risk of creating IP address conflict between your PC and the router. In such case, you may be compelled to reboot your entire system(s).

Chapter 2

Installation

2

This Chapter covers the physical installation of ADE-4100.

System Requirements

- PC or TCP/IP compliant workstations
- 32 MB RAM
- Ethernet Network Interface Controller (NIC) RJ45 Port
- Internet Browser

Installation Procedure

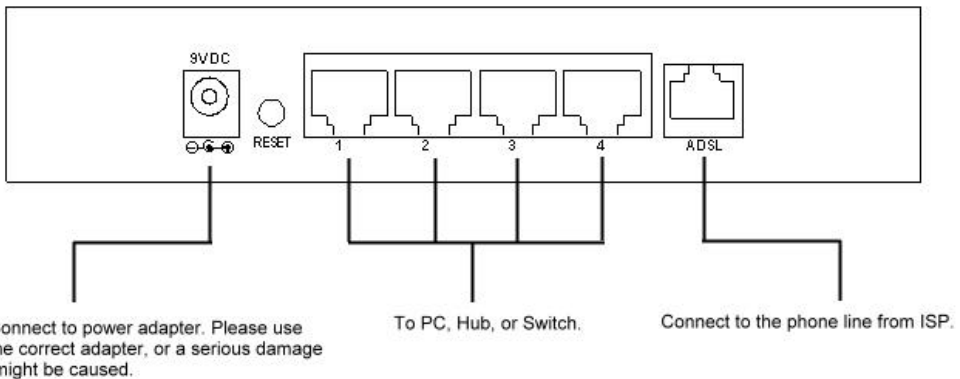

Figure 2-1: Installation Diagram

Step 1

Choose an Installation Site

Select a suitable place on the network to install ADE-4100. Ensure ADE-4100 is powered OFF.

Step 2

Connect LAN Cables

Use standard LAN cables to connect PCs to the LAN port on ADE-4100. Either 10BaseT or 100BaseT connections can be used.

Step 3

Connect WAN Cable

Connect one end of the RJ-11 phone cord to the LINE port on your ADSL modem. Connect the other end of the RJ-11 phone cord to your wall phone jack.

Step 4

Power Up

Connect the supplied power adapter to ADE-4100 and power up.
Use only the power adapter provided. Using a different one may cause hardware damage.

Step 5

Check the LEDs

For each LAN (PC) connection, the corresponding LAN LED should be **ON** (provided the PC is also ON.).

The *ADSL* LED should be also **ON**.

Chapter 3

Login And System Status

3

This Chapter details the first time login procedure and the Status screen

Login

ADE-4100 contains an HTTP server. This enables you to connect to it, and configure it, using your Web Browser. **Your Browser must have JavaScript support.** The configuration program has been tested on the following browsers:

- Netscape V4.08 or later
- Internet Explorer V4 or later

Moreover, it is suggested to use an Ethernet LAN PC for the initial configuration of ADE-4100.

Preparation

Before attempting to configure ADE-4100, please ensure that:

- Your PC can establish a physical connection to ADE-4100. The PC and ADE-4100 must be directly connected (using the LAN port on ADE-4100) or on the same LAN segment.
- ADE-4100 must be installed and powered ON.
- If ADE-4100's default IP Address (**10.0.0.2**) is already used by another device, the other device must be turned OFF until ADE-4100 is allocated a new IP Address during configuration.

Connecting to ADE-4100

To establish a connection from your PC to ADE-4100:

1. After installing ADE-4100 in your LAN, start your PC. If your PC is already running, restart it.
2. Start your WEB browser.
3. In the *Address* box, enter "HTTP://" and the IP Address of ADE-4100, as in this example, which uses ADE-4100's default IP Address:
<http://10.0.0.2>
4. If connection is established, a pop-up password request page will show up. The default login User Name of ADE-4100 administrator is "**admin**", and Password is "**epicrouter**". The default login User Name for non-administrator is "**user**", and Password is "**password**".



Figure 3-1: Logon Window

If you can't connect

If ADW does not respond, check the following:

- Machine is properly installed, LAN connection is OK, and it is powered ON. You can test the connection by using the "Ping" command:
 - Open the MS-DOS window or command prompt window.
 - Enter the command:
ping 10.0.0.2
If no response is received, either the connection is not working, or your PC's IP address is not compatible with ADE-4100's IP Address. (See next item.)
- If your PC is using a fixed IP Address, its IP Address must be within the range 10.0.0.3 to 10.255.255.254 to be compatible with ADE-4100's default IP Address of 10.0.0.2. Also, the *Network Mask* must be set to 255.0.0.0. See *Chapter 5 - PC Configuration* for details on checking your PC's TCP/IP settings.
- Ensure that your PC and ADE-4100 are on the same network segment. (If you don't have a router, this must be the case.)

Status

Home

Once you login in ADE-4100, its Home page will appear. It shows the firmware versions and WAN and LAN interface status.

The screenshot shows the Planet ADE-4100 Home Page. On the left is a navigation menu with 'Status' and 'Configuration' sections. The 'Status' section includes links for Home, ADSL, LAN, and PPP. The 'Configuration' section includes links for WAN, LAN, PPP, NAT, Virtual Server, DNS, and Bridge Filtering. The main content area displays the following information:

Home Page
 Firmware Version: ETHADSL_USB_080902_REL8G
 Customer Software Version: 080902_REL8G

WAN

IP Address	Subnet Mask	MAC Address
203.73.254.218	255.255.255.0	00:05:B4:06:01:25

LAN

IP Address	Subnet Mask	MAC Address
10.0.0.2	255.0.0.0	00:05:B4:06:01:24

Total Number of Lan Interfaces: 1
 Number of ethernet devices connected to the DHCP server: 0

Figure 3-2: Home page

ADSL

The **ADSL Status** page shows the ADSL physical layer status.

The screenshot shows the Planet ADE-4100 ADSL Status page. The navigation menu is the same as in Figure 3-2. The main content area displays the following information:

ADSL STATUS
 Showtime Firmware Version: 3.21
 Line State: **SHOWTIME**
 Modulation: **G.dmt**
 Annex Mode: **ANNEX_A**
 Startup Attempts: **1**
 Max Tx Power: **-38 dBm/Hz**
 CO Vendor: **ANALOG_DEVICES**
 Elapsed Time: **0 days 0 hours 3 minutes 6 seconds**

	Downstream	Upstream	
SNR Margin	39.7	26.0	dB
Line Attenuation	23.1	14.0	dB
Errored Seconds	0	0	
Loss of Signal	0	0	
Loss of Frame	0	0	
CRC Errors	0	0	
Data Rate	512	64	kbps

Figure 3-3: ADSL status

LAN

The **LAN** page shows the information and status of LAN port, DHCP client table, and linking status of Ethernet interface.

LAN

IP Address	Subnet Mask	MAC Address
10.0.0.2	255.0.0.0	00:05:B4:06:01:24

Total Number of Lan Interfaces: 1
 Number of ethernet devices connected to the DHCP server: 0
 Ethernet Link Status: UP
 USB Link Status: DOWN

Figure 3-4: LAN status

PPP

The **PPP** page shows the status of PPP for each PPP interface.

PPP

#	Connection Name	Interface	Mode	Status	Pkts Sent	Pkts Rcvd	Bytes Sent	Bytes Rcvd
1	simple ppp session 0	Pvc 0	PPPoE	Connected	60	40	4707	1080

If a * appears under Mode column, you need to [check the WAN configuration](#) to make sure the VC has the correct encapsulation.

Connection #

Figure 3-5: PPP status

Chapter 4

System Configuration



This Chapter details the configurations for ADE-4100

Overview

This chapter describes the setup procedure for:

- WAN Access
- LAN configuration

PCs on your local LAN may also require configuration. For details, see *Chapter 5 - PC Configuration*.

WAN configuration

Select the WAN link under Configuration column to set up WAN connection. It is required to know the type of Internet connection service used by your ISP.

Note: You only need to fill in the fields that your ISP provided, and leave the others as default.

Enabled?	VPI	VCI	Static IP Address	Subnet Mask	Gateway
Yes	0	33	0.0.0.0	0.0.0.0	0.0.0.0

MAC SPOOFING

Mac Spoofing:

Mac Address:

ATM

Service Category:

Bandwidth: kbps

ENCAPSULATION:

BRIDGE:

Figure 4-1: WAN Configuration

Per VC Setting

Under **Per VC Setting**, it provides the configurations for IP address, subnet mask, gateway, and VPI/VCI, where VPI and VCI must be filled.

Per VC Settings

Enabled?	VPI	VCI	Static IP Address	Subnet Mask	Gateway
Yes	0	33	0.0.0.0	0.0.0.0	0.0.0.0

Figure 4-2: Per VC Settings

To switch between the PVCs, please choose the options of virtual circuit and click on the **Submit** button to switch over.

DHCP

DHCP client enable

Host Name

Virtual Circuit:

Figure 4-3: Switch between PVCs

Internet connection services

Types of Internet connection services supported by ADE-4100 are explained below.

Bridge Mode

Step 1

At the WAN Configuration page, insert the VCI/VPI provided by ISP. Enable **“Bridge”**, and choose suitable packet encapsulation.

BRIDGE

Figure 4-4: Bridge status

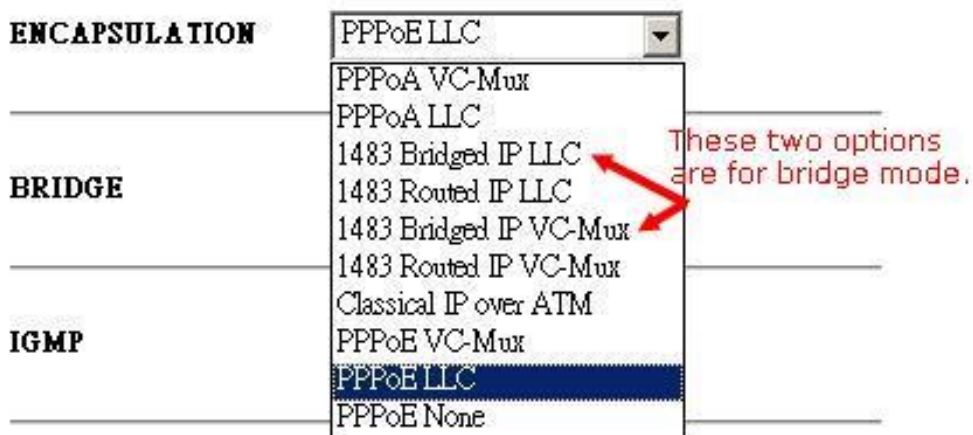

Figure 4-5: Encapsulation types of Bridge mode

Step 2

Click “**submit**” to commit modifications you’ve done, then click “**Save Configuration**” to store settings. (Modifications will not take effects until next reboot.)

Step 3

Click on “**NAT**” tab on left panel, and **disable** the NAT function in the option menu.

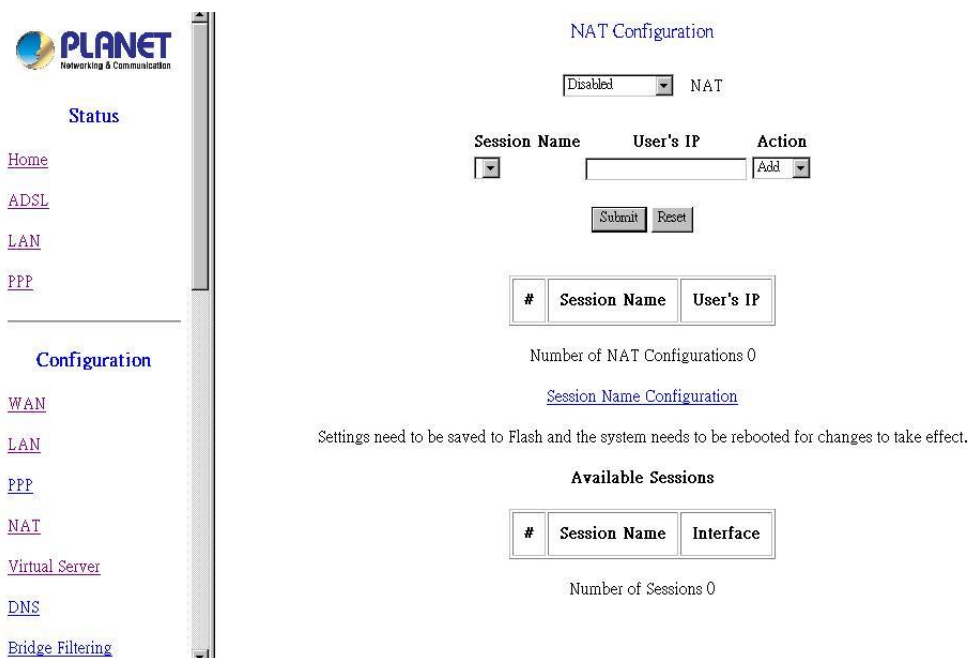

Figure 4-6: NAT Disable screen

Step 4

Click “**Save settings**” on left panel to write configuration into machine, and reboot to make settings effective.

PPPoE, PPPoA Connection for WAN (Routing mode)

If PPPoE (Point-to-Point Over Ethernet) or PPPoA (Point-to Point Over ATM) is provided to establish communications, **User Name** and **Password** are required to

be obtained from ISP. And **VCI/VPI** values must be obtained from them as well, for some local ISPs don't offer this information actively.

To set up a PPPoE or PPPoA connection for WAN, follow the instructions below:

Step 1

Fill in the VCI/VPI entries with the information you get from ISP.

Step 2

Choose suitable packet encapsulation (PPPoA LLC/VC-Mux, PPPoE LLC/VC-Mux). Disable "Bridge". (Packet encapsulation information also has to be obtained from ISP.)

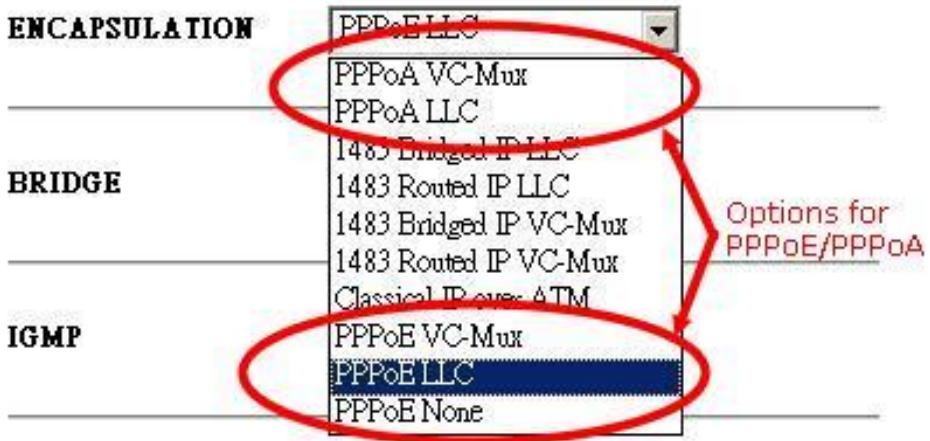

Figure 4-7: Encapsulation types of PPPoE/PPPoA

Service Name

If your ISP provides this info, please type it into the field or leave it blank (factory default).

User Name and Password

Fill in the entries with the information provided by ISP.

Disconnect Timeout

It is the amount of time you would like to pass before the Router drops your Internet connection due to inactivity. Enter zero (0) in the field to remain Internet connection on at all time. The idle time ranges from 0 to 32767 seconds.

MRU

Maximum Receive Unit indicates the peer of PPP connection the maximum size of the PPP information field this device can be received. The default value is 1492 and is used in the beginning of the PPP negotiation. In the normal negotiation, the peer will accept this MRU and will not send packet with information field larger than this value.

MTU

Maximum Transmission Unit indicates the network stack of any packet is larger than this value will be fragmented before the transmission. During the PPP negotiation, the peer of the PPP connection will indicate its MRU and will be accepted. The actual MTU of the PPP connection will be set to the smaller one of MTU and the peer's MRU. The default is value 1492.

MSS

Maximum Segment Size is the largest size of data that TCP will send in a single IP packet. When a connection is established between a LAN client and a host in the WAN side, the LAN client and the WAN host will indicate their MSS during the TCP

connection handshake. The default value is 1432.

Authentication

When **AUTO** option is chosen, the PAP mode will run first then CHAP.

Automatic Reconnect

If you check this option, the Disconnect Timeout should set to 0 second. Otherwise there will be a conflict between them.

DHCP

Leave this option unchecked.

PPP

Service Name	<input type="text"/>
Username	<input type="text" value="t0195090"/>
Password	<input type="password" value="*****"/>
Disconnect Timeout	<input type="text" value="0"/> seconds (Max:32767)
MRU	<input type="text" value="1492"/>
MTU	<input type="text" value="1492"/>
MSS	<input type="text" value="1432"/>
Authentication	<input type="text" value="Auto"/> ▼
<input checked="" type="checkbox"/> Automatic Reconnect	Advanced PPP configuration

DHCP

<input type="checkbox"/> DHCP client enable	
Host Name	<input type="text"/>

Figure 4-8: PPP setting Screen

Step 3

Click on “**NAT**” tab on left panel, and **enable** the **NAPT** function in the option menu.

Step 4

Click “**Save settings**” on left panel to write configuration into machine, and reboot to make settings effective.

Fixed IP for WAN

If your ISP has assigned static IP address, you may connect to the Internet by using a fixed, or static address. To set up a Fixed IP for WAN, do the following steps as an example.

Step 1

Enter the information of **Static IP Address**, **Subnet Mask** and **Gateway** provided by ISP. Note: These parameters are required for building up connection. If one of these information incorrect or unavailable, please contact your ISP for correct information.

Per VC Settings

Enabled?	VPI	VCI	Static IP Address	Subnet Mask	Gateway
Yes	0	33	0.0.0.0	0.0.0.0	0.0.0.0

Figure 4-9: Fixed IP set-up screen

Step 2

Choose suitable packet encapsulation (1483 Bridged/ Routed LLC, 1483 Bridged/ Routed Mux, Classical IP over ATM). And **Disable** "Bridge" function.

Step 3

Click "**submit**" to commit modifications you've done, then click "**Save Configuration**" to store settings. (Modifications will not take effects until next reboot.)

Step 3

Click on "**NAT**" tab on left panel, and **enable** the **NAPT** function in the option menu.

Step 4

Click "**Save settings**" on left panel to write configuration into machine, and reboot to make settings effective.

Dynamic IP for WAN

If ISP provides a dynamic IP for Internet connection, following steps illustrate how to enable the connection via ADE-4100.

Step 1

Choose suitable packet encapsulation (1483 Bridged/ Routed LLC, 1483 Bridged/ Routed Mux, Classical IP over ATM). And **Disable** "Bridge" function.

Step2

Check the **DHCP** option, and fill in the Host Name field (if required.) (This information should be obtained from ISP. If there is no special demand for this, leave this column blank.)

DHCP

DHCP client enable

Host Name

Check this, then fill in the Host Name obtained from ISP.

Figure 4-10: *DHCP client enable***Step 3**

Click on “**NAT**” tab on left panel, and **enable** the **NAPT** function in the option menu.

Step 4

Click “**Save settings**” on left panel to write configuration into machine, and reboot to make settings effective.

Other settings

Here are explanations about some fields not mentioned above.

MAC Spoofing

The **MAC Spoofing** is developed to solve the scenario when the ISP only recognizes one MAC address. Copy the ISP-recognized MAC address here.

MAC SPOOFING

Mac Spoofing	<input type="text" value="Disable"/>
Mac Address	<input type="text" value="00:00:00:00:00:00"/>

Figure 4-11: *MAC Spoofing***ATM**

If your ISP provides this information to you, fill it in appropriate field.

Service Category

UBR and CBR are two different types of service supported from the ATM.

Bandwidth

Bandwidth setting takes effect only when the CBR is selected. The maximum available bandwidth is from the upstream data rate of ADSL status page.

ATM

Service Category	<input type="text" value="UBR"/>
Bandwidth	<input type="text" value="0"/> kbps

Figure 4-12: *ATM Bandwidth Category***IGMP**

Support IGMP proxy/relay function for ADSL modem, based on the following requirement and case:

- On CO side, there must be at least one IGMP querier (router) present. IGMP querier will send IGMP query packet. The ADSL modem is responsible to relay these IGMP query to Ethernet.
- End-user multicast application device send IGMP report while receiving IGMP query or being activated by user, the ADSL modem should be responsible to proxy (that is, change source IP to ADSL modem's WAN IP) the IGMP report to ADSL WAN side, include all PVCs. The same case is for IGMP leave packet.
- It is not necessary to relay multicast routing between two ADSL PVCs or two interfaces in LAN side.

- Special purpose multicast packet (such as RIP 2 packet) should run without interference.

Table 4-1 IGMP packets process

Rx Entity	Packet Class	TTL	Action	Notes
ADSL	IGMP query	1	Relay to Ethernet	
	IGMP report	1	Ignore	
	IGMP leave	1	Ignore	
	General Multicast IP	-	Relay it to Ethernet.	
Ethernet	IGMP query	1	Ignore	
	IGMP report	1	Relay to all ADSL PVC	
	IGMP leave	1	Relay to all ADSL PVC	
	General Multicast IP	-	Ignore	

Note: Before the IGMP mode is enabled; please go to the **Misc Configuration** page to enable the IGMP proxy. Otherwise, the IGMP selection will not be valid.

Table 4-2 WAN configurations Overview

	Bridge Mode (Dynamic IP)	Router Mode (Dynamic IP)	Router Mode (Static IP)
Configuration - WAN			
Enabled?	Yes	Yes	Yes
VPI	Provided by ISP	Provided by ISP	Provided by ISP
VCI	Provided by ISP	Provided by ISP	Provided by ISP
Static IP Address	N/A (0.0.0.0)	N/A (0.0.0.0)	Provided by ISP
Subnet Mask	N/A (0.0.0.0)	N/A (0.0.0.0)	Provided by ISP
Gateway	N/A (0.0.0.0)	N/A (0.0.0.0)	Provided by ISP
Encapsulation	1483 Bridged IP LLC	PPPoE LLC or PPPoA VC-Mux	1483 Routed IP LLC
Bridge	Enabled	Disabled	Disabled
PPP Service Name	N/A	Blank	N/A
PPP User Name	N/A	Provided by ISP	N/A
PPP Password	N/A	Provided by ISP	N/A
Virtual Circuit	0	0	0
Configuration - LAN			
DHCP Server	Unchecked	Checked	Checked
Configuration - NAT			
NAT	Disabled	NAPT	NAPT
Configuration - DNS			
DNS Proxy Selection	Disabled DNS Proxy	Use Auto Discov- ered	Use User Config- ured
Prefer DNS Server	N/A (0.0.0.0)	N/A (0.0.0.0)	Provided by ISP
Alternate DNS Server	N/A (0.0.0.0)	N/A (0.0.0.0)	Provided by ISP

Note: Encapsulation is based on the ISP configuration. It may be different for different ISPs and countries.

LAN Configuration

The LAN IP and Subnet Mask of ADE-4100 are the values seen by the users on their internal network. The default IP is **10.0.0.2** for IP and **255.0.0.0** for Subnet Mask.

LAN Configuration

IP Address	<input type="text" value="10.0.0.2"/>
Subnet Mask	<input type="text" value="255.0.0.0"/>

Figure 4-13: LAN Configuration

DHCP Setting

A DHCP (Dynamic Host Configuration Protocol) Server automatically assigns IP address to each computer on your network. Unless you already have one, it is highly recommended that your router be set up as a DHCP server..

- **System Allocated**

The DHCP address pool is based on LAN port IP address plus 12 IP addresses. For example, the LAN IP address is 10.0.0.2; the DHCP address pool is at the range of 10.0.0.3 to 10.0.0.14.

- **User Defined**

The DHCP address pool is at the range of **User Defined Start Address** and **User Defined End Address**. **Maximum IP pool size in ADE-4100 is 253**. IP address range: 255 total IP addresses – 1 broadcast address – 1 LAN port IP address.

- **DHCP gateway selection**

The default setting for the DHCP Gateway Selection is “Automatic”. The user can select the “User Defined” to specify “User Defined Gateway Address”. The DHCP server will issue the “User Defined Gateway Address” to the LAN DHCP clients.

- **Lease time**

The Lease time is the amount of time of a network user will be allowed to connect with DHCP server. **If all fields are 0, the allocated IP addresses will be effective forever.**

- **User mode**

Single User mode: DHCP server only allocates one IP address to local PC.

Multiple User mode: DHCP server allocates the IP addresses specified by the DHCP address pool.

DHCP Server

DHCP address pool selection System Allocated
 User Defined

User Defined Start Address

User Defined End Address

DHCP gateway selection Automatic
 User Defined

User Defined Gateway Address

Lease Time days hours minutes seconds

User Mode ▾

[Ethernet Mode Setting](#)

Figure 4-14: DHCP server settings

- **Ethernet Mode Setting:**

By clicking this link, you will be directed to Ethernet Mode page. You can specify the type of LAN connection or use AutoSense. Default is AutoSense.

[Ethernet Mode](#)

Ethernet Mode: ▾

Settings need to be saved to Flash and the system needs to be rebooted for changes to take effect.

Figure 4-15: Ethernet Mode

PPP Configuration

This page allows the user to configure multiple PPP sessions for each PVC. It can support up to total of 16 PPP sessions, and each PVC can support up to 8 PPP sessions. The multiple PPP sessions may be configured with any combination over 8 PVCs.

Configuration

[WAN](#)

[LAN](#)

[PPP](#)

[NAT](#)

[Virtual Server](#)

[DNS](#)

[Bridge Filtering](#)

[Wireless](#)

[Save Settings](#)

[Reboot without saving](#)

Admin Privilege

[WAN Status](#)

[ATM Status](#)

PPP Configuration

Session Name

PVC

Service Name (PPPoE only)

Account to Use

Disconnect Timeout seconds (Max:32767)

MRU

MTU

MSS

Authentication

Automatic Reconnect

#	Session Name	Adapter	Mode	Service Name	Account to Use	Disconnect Timeout (sec)	MRU	MTU	MSS	Authentication Mode

Figure 4-16: PPP Configuration

Y Session Name

This field allows the user to enter his/her own session Name to distinguish different session for different PPP accounts and different PVCs.

Y PVC

This field allows the user to choose the specific PVC for PPP session.

Y Service Name

The service name of PPP is required by some ISPs. If the ISP does not provide the Service Name, please leave it blank.

Y Disconnect Timeout

The Disconnect Timeout allows the user to set the specific period of time to disconnect from the ISP. The default is 0, which means never disconnect from the ISP.

Y MRU

Maximum Receive Unit indicates the peer of PPP connection the maximum size of the PPP information field this device can be received. The default value is 1492 and is used in the beginning of the PPP negotiation. In the normal negotiation, the peer will accept this MRU and will not send packet with information field larger than this value.

Y MTU

Maximum Transmission Unit indicates the network stack of any packet is larger than this value will be fragmented before the transmission. During the PPP negotiation, the peer of the PPP connection will indicate its MRU and will be accepted. The actual MTU of the PPP connection will be set to the smaller one of MTU and the peer's MRU. The default is value 1492.

Y MSS

Maximum Segment Size is the largest size of data that TCP will send in a single IP packet. When a connection is established between a LAN client and a host in the WAN side, the LAN client and the WAN host will indicate their MSS during the TCP connection handshake. The default value is 1432.

Y Automatic Reconnect

When it is checked, it will maintain the PPP connection all the time. If the ISP shut down the PPP connection, it will automatically reconnect PPP session.

Y Authentication

When AUTO option is chosen, the PAP mode will run first then CHAP.

PPP Configuration Status will be displayed at the bottom of this page to show all the Session Names with its Adapter (PVC number), Mode (PPPoA or PPPoE), Service Name, Account to Use (PPP Account ID), Disconnect Timeout configuration, MRU, MTU, MSS, Authentication Mode (Auto, CHAP or PAP), and Auto Reconnect configuration.

To configure the above settings, you must go to the PPP Account Configuration page first to configure Account ID, Users Name and Password.

PPP Account Configuration

Acct Id

User Name

Password

#	Account Name	User Name
1	simple ppp account 0	t0195090

The number of PPP accounts is 1

Figure 4-17: PPP Account Configuration

Y Account ID

This field allows the user to enter his/her own account ID to distinguish different accounts.

Y User Name

Enter the PPP user name (usually provided buy the ISP).

Y Password

Enter the PPP password (usually provided buy the ISP).

PPP Account Configuration Status will be displayed at the bottom of this page to show all the accounts with its Account Name and User Name. (It does not show the password.)

The Number of PPP Accounts displays the total number of PPP Accounts is entered.

NAT Settings

The NAT Configuration page allows the user to set the configuration for the Network Address Translation.

Dynamic NAPT

The default setting is Dynamic NAPT. It provides dynamic Network Address Translation capability between LAN and multiple WAN connections, and the LAN traffic is routed to appropriate WAN connections based on the destination IP addresses and Route Table. This eliminates the need for the static NAT session configuration between multiple LAN clients and multiple WAN connections. When the Dynamic NAPT is chosen, there is no need to configure the NAT Session and NAT Session Name Configuration..

NAPT (Static)

The NAPT option maps the single WAN IP addresses to many local PCs IP addresses (1xN). It is the multiple-mapping mechanism. For each WAN Interface,

more than one local PC can be associated with one WAN Interface. Click the Session Name Configuration link to add the session name for WAN interface.

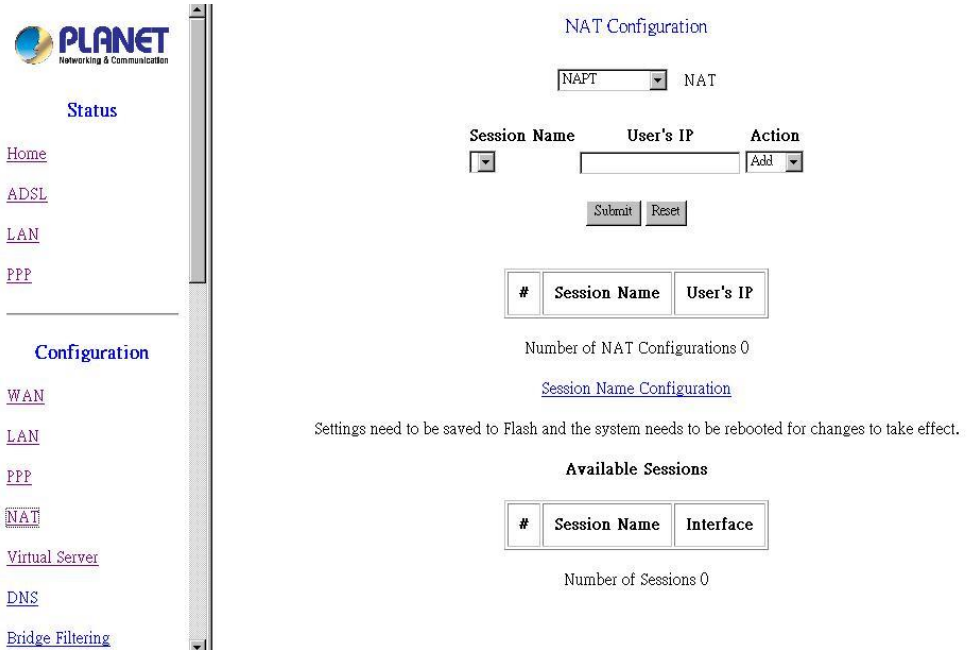

Figure 4-18: NAT configuration

Y Session Name

This field allows the user to select the session from the configured NAT Session Name Configuration.

Y User's IP

This field allows the user to assign the IP address to map the corresponding NAT/NAPT sessions.

Session Name Status will be displayed at the middle of this page to show the corresponding Session Name with its IP address.

Number of NAT Configurations displays the total number of NAT Sessions is entered.

Available Sessions Status will be displayed at the end of this page to show all the Session Names with its WAN Interface.

Number of Session displays the total number of NAT Sessions Name is entered.

NAT (Static)

The NAT option only maps single WAN IP address to the local PC IP address. It is a peer to-peer mapping. (1x1) For each WAN interface, only one local PC IP address can be associated with each WAN interface. Click the Session Name Configuration link to add the session name for WAN interface.

NAT Session Name Configuration

Session Name	Interface	Action
<input type="text"/>	Ip Pvc 0	Add

#	Session Name	Interface

[Go back to NAT Configuration](#)

Settings need to be saved to Flash and the system needs to be rebooted for changes to take effect.

Number of NAT Sessions 0

Figure 4-19: NAT Session Name Configuration

Y Session Name

This field allows the user to enter his/her own session Name to distinguish different NAT session for different interfaces among different PPP sessions and different PVCs.

Y Interface

This field allows the user to choose specific WAN Interface (PVC or PPP Session) for NAT Session.

NAT Session Name Status displays at the bottom of this page to show all the NAT Session Names with its WAN Interface.

Number of NAT Configurations displays the total number of NAT Sessions Name is entered.

Click the Go back to NAT Configuration link to the NAT configuration page. Select the NAT option. Select the Session Name and assign the PC IP address, and choose the Add action. Click the Submit button and go to the Save Settings to save this configuration.

Virtual Servers

Virtual server feature allows users to make Servers on your LAN accessible to Internet users. Normally, Internet users would not be able to access a server on your LAN because of native NAT protection.

The "Virtual Server" feature solves these problems and allows Internet users to connect to your servers.

For Internet users to access all virtual Servers on LAN side, they have to connect to WAN port IP on ADE-4100 allocated by ISP.

To provide server-based service, WAN IP address should be static, rather than dynamic, to make it easier for Internet users to connect to your Servers.

However, *DDNS (Dynamic DNS)* service allows users to connect to your Virtual Servers using a URL, instead of an IP Address.

You can set up public services on your network by configuring the values in the Virtual Server Configuration page. You may assign certain IP addresses as the destination of the network information. When users from the Internet make certain

requests of your network, ADE-4100 will forward those requests to the appropriate computer. (Note: DHCP function must be disabled or the local server itself has to be fix-IP addressed to use this function.)

This function is generally used to set up a web server, ftp server, or e-mail server on your network. Figure shows the screen of Virtual Server Configuration page,

To add a Virtual Server:

Step 1

Select the **public port** number used by the service, ranged from 0 to 65535.

Step 2

Select the **private port** number used on internal server mapping to public port, it is not required to be the same as public port number.

Step 3

Select appropriate communication type via **type of port** checkbox.

Step 4

Enter the **Host IP Address** of local server that you want the Internet users to be able to access.

Step 5

Click the **“Add This Setting”** button to save the settings.

Step 6

Click **“Save settings”** on left panel to write configuration into machine, and reboot to make settings effective.

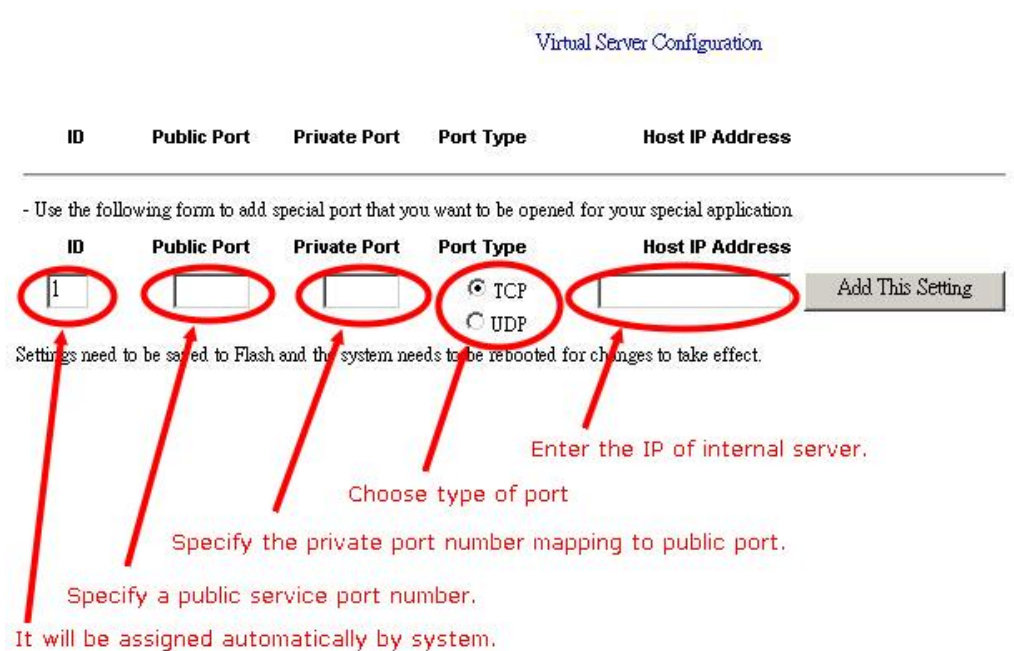

Figure 4-20: Virtual Server Configuration Screen

DNS Configuration

The **DNS Configuration** page allows you to set the configuration of DNS proxy. ADE-4100 supports the DNS proxy function. For the DHCP requests from local PCs, the DHCP server will set the LAN port IP as the default DNS server. Thus, all DNS query messages will come into LAN port first. The DNS proxy on the ADSL modem recorded the available DNS servers, and forward DNS query messages to one of DNS server.

Four DNS proxy modes available in ADE-4100:

Disable DNS Proxy

The LAN port does not process the DNS query message. For the DHCP requests from local PCs, the DHCP server will set the user-configured preferred DNS server or alternate DNS server whichever is available as the DNS server. Then all DNS query messages will be directly sent to the DNS servers.

Use Auto Discovered DNS Servers Only

The DNS proxy will store the DNS server IP addresses obtained from DHCP client or PPP into the table. And all DNS query messages will be sent to one of the dynamically obtained DNS servers.

Use User Configured DNS Servers Only

The DNS proxy will use the user-configured preferred DNS server and alternate DNS server. And all DNS query message will be sent to one of DNS servers.

Auto Discovery + User Configured

The DNS proxy's table has all the IP addresses of dynamically obtained and user configured DNS servers.

DNS Configuration

DNS Proxy Selection:

User Configuration:

Preferred DNS Server:

Alternate DNS Server:

Settings need to be saved to Flash and the system needs to be rebooted for the changes to take effect.

Figure 4-21: DNS Configuration Screen

Bridge Filtering

The **Bridge Filtering** configuration page allows you to set the configuration of IP filtering. You can add 4 records max.

Source MAC

When the bridge filtering is enabled, enter the **Source MAC address**, select **Block** and click **Add**. Then all incoming WAN and LAN Ethernet packets matched with this source MAC address will be filtered out. If the **Forward** is selected, then the

packets will be forwarded to the destination PC.

Destination MAC

When the bridge filtering is enabled, enter the **Destination MAC address**, select **Block** and click **Add**. Then all incoming WAN and LAN Ethernet packets matched with this destination MAC address will be filtered out. If the **Forward** is selected, then the packets will be forwarded to the destination PC.

Type

Enter the hexadecimal number for the Ethernet type field in Ethernet_II packets. For example, 0800 is for IP protocol.

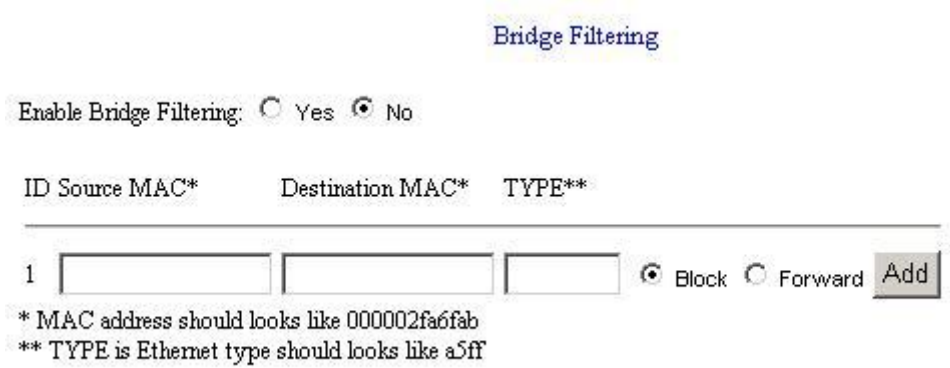

Figure 4-22: Bridge Filtering Screen

Save Settings

If any modification is made by administrator via web interface, the new settings need to be saved into the flash and reboot ADE-4100 to make the changes effective.

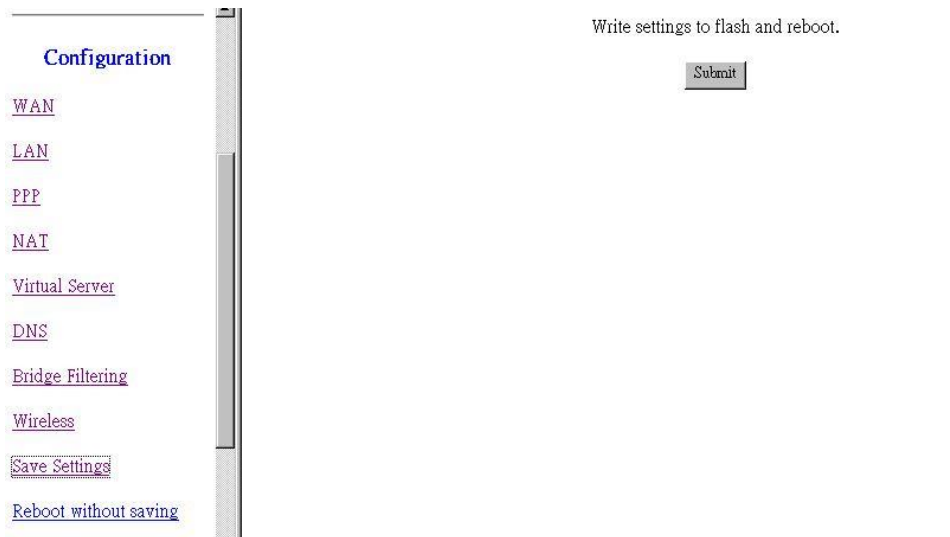

Figure 4-24: Save Settings

Chapter 5

PC Configuration

5

This Chapter details the PC Configuration required on the local ("Internal") LAN.

Overview

For each PC, the following may to be configured:

- TCP/IP network settings
- Internet Access configuration

Windows Clients

This section describes how to configure Windows clients for Internet access via ADE-4100.

The first step is to check the PC's TCP/IP settings.

ADE-4100 uses the TCP/IP network protocol for all functions, so it is essential that the TCP/IP protocol be installed and configured on each PC.

TCP/IP Settings

If default ADE-4100 settings are loaded, and default Windows 95/98/ME/2000 TCP/IP configuration, no changes need to be made.

- By default, ADE-4100 will act as a DHCP Server, automatically providing a suitable IP Address (and related information) to each PC when the PC boots.
- For all non-Server versions of Windows, the default TCP/IP setting is to act as a DHCP client.
- If you wish to check your TCP/IP settings, the procedure is described in the following sections.

Windows 9x/ME

1. Select *Control Panel - Network*. You should see a screen like the following:

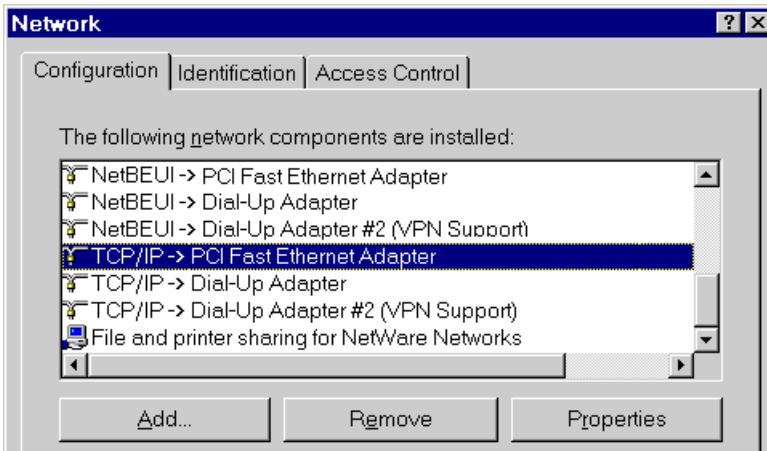

Figure 5-1: Network Configuration

2. Select the *TCP/IP* protocol for your network card.
3. Click on the *Properties* button. You should then see a screen like the following.

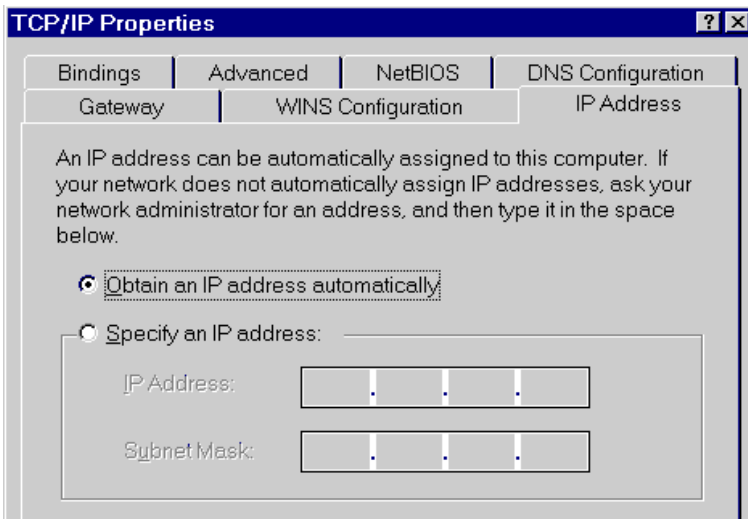

Figure 5-2: IP Address (Win 95)

Ensure your TCP/IP settings are correct, as follows:

Using DHCP

To use DHCP, select the radio button *Obtain an IP Address automatically*. This is the default Windows settings.

Restart your PC to ensure it obtains an IP Address from ADE-4100.

Using "Specify an IP Address"

- If your PC is already configured, do NOT change the settings on the IP Address tab shown in **Figure** above.
- On the *Gateway* tab, enter ADE-4100's IP address in the *New Gateway* field and click *Add*, as shown below. Your LAN administrator can advise you of the IP Address they assigned to ADE-4100.

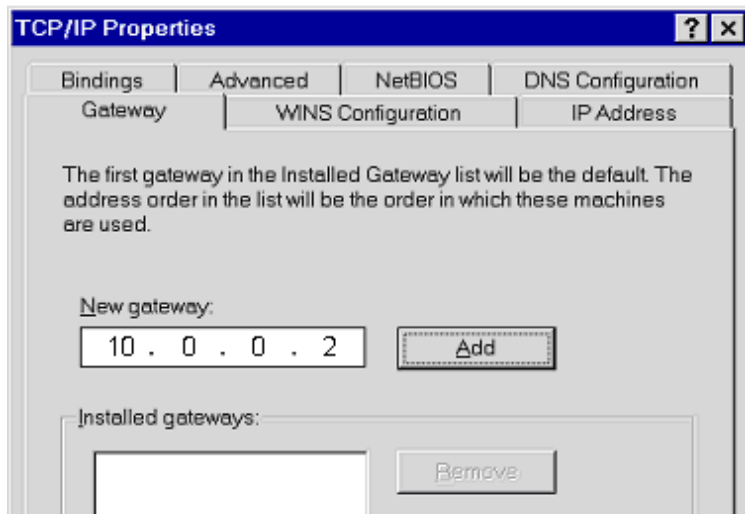

Figure 5-3: Gateway Tab (Win 95/98)

- On the *DNS Configuration* tab, ensure *Enable DNS* is selected. If the *DNS Server Search Order* list is empty, enter the DNS address provided by your ISP in the fields beside the *Add* button, then click *Add*.

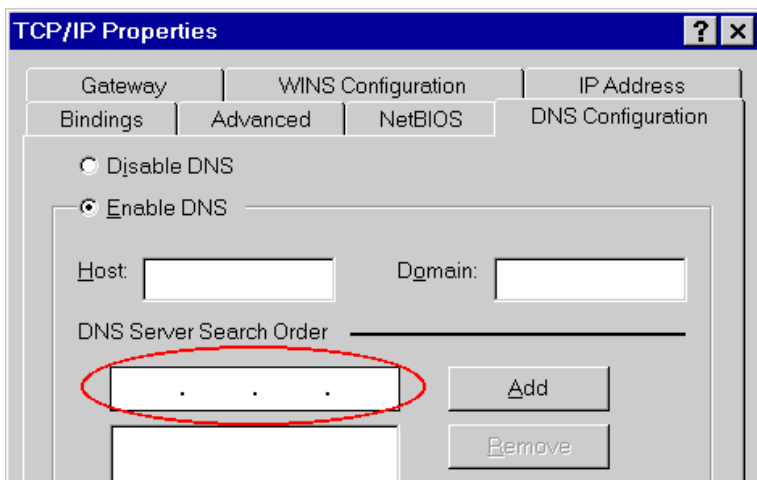

Figure 5-4: DNS Tab (Win 95/98)

Windows 2000

1. Select *Control Panel - Network and Dial-up Connection*.
2. Right click the *Local Area Connection* icon and select *Properties*. You should see a screen like the following:

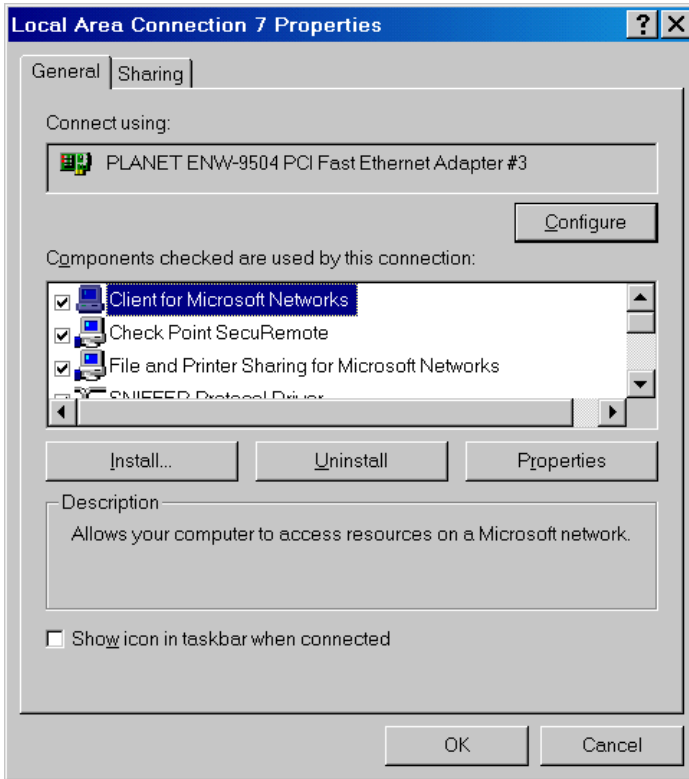

Figure 5-5: Network Configuration (Win 2000)

3. Select the *TCP/IP* protocol for your network card.
4. Click on the *Properties* button. You should then see a screen like the following.

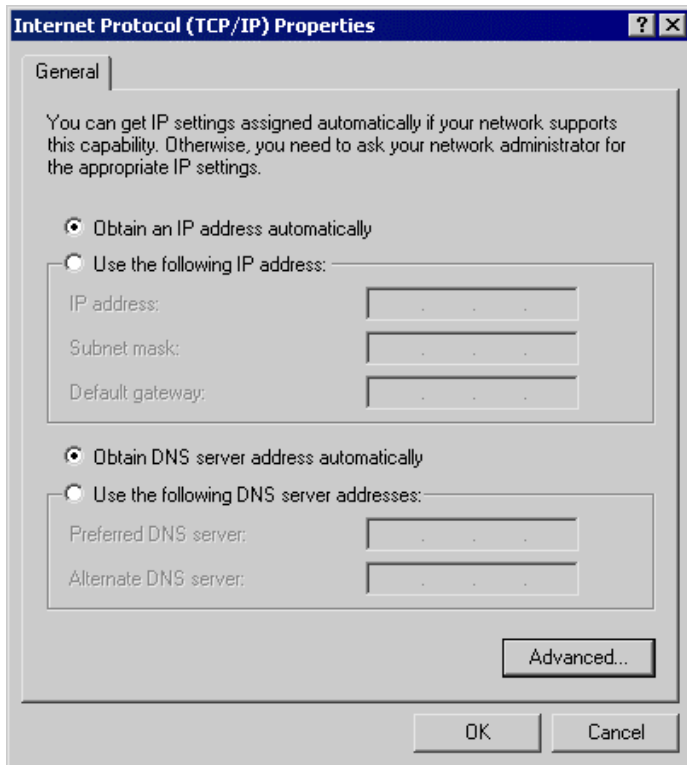

Figure 5-6: TCP/IP Properties (Win 2000)

5. Ensure your TCP/IP settings are correct:

Using DHCP

To use DHCP, select the radio button *Obtain an IP Address automatically*. This is the default Windows settings.

Restart your PC to ensure it obtains an IP Address from ADE-4100.

Using a fixed IP Address ("Use the following IP Address")

If your PC is already configured, check with your network administrator before making the following changes.

- Enter ADE-4100's IP address in the *Default gateway* field and click *OK*. (Your LAN administrator can advise you of the IP Address they assigned to ADE-4100.)
- If the *DNS Server* fields are empty, select *Use the following DNS server addresses*, and enter the DNS address or addresses provided by your ISP, then click *OK*.

Windows XP

1. Select Control Panel - Network Connection.
2. Right click the *Local Area Connection* and choose *Properties*. You should see a screen like the following:

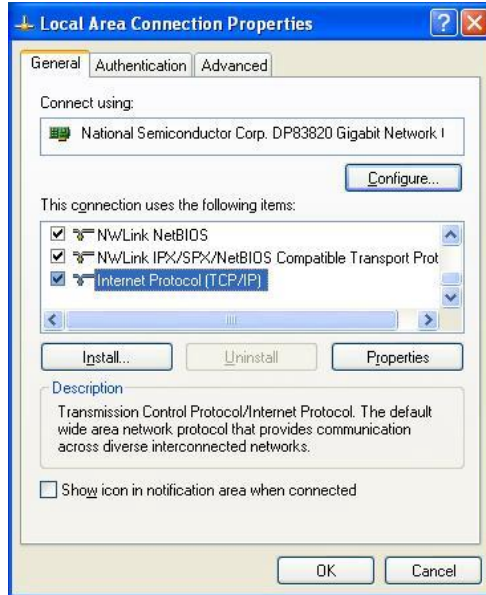

Figure 5-7: Network Configuration (Windows XP)

3. Select the *TCP/IP* protocol for your network card.
4. Click on the *Properties* button. You should then see a screen like the following.

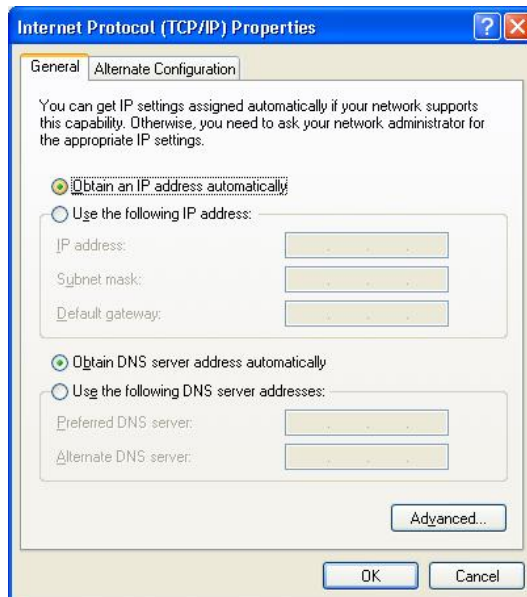

Figure 5-8: TCP/IP Properties (Windows XP)

5. Ensure your TCP/IP settings are correct.

Using DHCP

To use DHCP, select the radio button *Obtain an IP Address automatically*. This is the default Windows settings.

Restart your PC to ensure it obtains an IP Address from ADE-4100.

Using a fixed IP Address ("Use the following IP Address")

- If your PC is already configured, do NOT change the settings on the screen shown in **Figure** above, unless advised to do so by your network administrator.
- You can enter ADE-4100's IP address in the *Default gateway* field and click *OK*. Your LAN administrator can advise you of the IP Address they assigned to ADE-4100.
- If the *DNS Server* fields are empty, select *Use the following DNS server addresses*, and enter the DNS address or addresses provided by your ISP, then click *OK*.

Internet Access

To configure your PCs to use ADE-4100 for Internet access:

- Use the following procedure to configure your Browser to access the Internet via the LAN, rather than by a Dial-up connection.

Windows 9x/2000

1. Select *Start Menu - Settings - Control Panel - Internet Options*.
2. Select the *Connection* tab, and click the *Setup* button.
3. Select "I want to set up my Internet connection manually, or I want to connect through a local area network (LAN)" and click *Next*.
4. Select "I connect through a local area network (LAN)" and click *Next*.
5. Ensure all of the boxes on the following *Local area network Internet Configuration* screen are **unchecked**.
6. Check the "No" option when prompted "Do you want to set up an Internet mail account now?"
7. Click *Finish* to close the Internet Connection Wizard.
Setup is now completed.

Windows XP

1. Select *Start Menu - Control Panel - Network and Internet Connections*.
2. Select *Set up or change your Internet Connection*.
3. Select the *Connection* tab, and click the *Setup* button.
4. Cancel the pop-up "Location Information" screen.
5. Click *Next* on the "New Connection Wizard" screen.
6. Select "Connect to the Internet" and click *Next*.
7. Select "Set up my connection manually" and click *Next*.
8. Check "Connect using a broadband connection that is always on" and click *Next*.
9. Click *Finish* to close the New Connection Wizard.
Setup is now completed.

Macintosh Clients

From your Macintosh, you can access the Internet via ADE-4100. The procedure is as follows.

1. Open the TCP/IP Control Panel.
2. Select *Ethernet* from the *Connect via* pop-up menu.
3. Select *Using DHCP Server* from the *Configure* pop-up menu. The DHCP Client ID field can be left blank.
4. Close the TCP/IP panel, saving your settings.

Note:

If using manually assigned IP addresses instead of DHCP, the only change required is to set the *Router Address* field to ADE-4100's IP Address.

Linux Clients

To access the Internet via ADE-4100, it is only necessary to set ADE-4100 as the "Gateway".

Ensure you are logged in as "root" before attempting any changes.

Fixed IP Address

By default, most Unix installations use a fixed IP Address. If you wish to continue using a fixed IP Address, make the following changes to your configuration.

- Set your "Default Gateway" to the IP Address of ADE-4100.
- Ensure your DNS (Name server) settings are correct.

To act as a DHCP Client (recommended)

The procedure below may vary according to your version of Linux and X -windows shell.

1. Start your X Windows client.
2. Select *Control Panel - Network*
3. Select the "Interface" entry for your Network card. Normally, this will be called "eth0".
4. Click the *Edit* button, set the "protocol" to "DHCP", and save this data.
5. To apply your changes
 - Use the "Deactivate" and "Activate" buttons, if available.
 - OR, restart your system.

Chapter 6

Admin Privilege

6

This Chapter details the operation of ADE-4100 and the status screens.

The links under **Admin Privilege** are only to be accessed and configured, when it is login with administrator login name and password.

WAN Status

The **WAN Status** page shows the information and status of WAN PVCs. Select the VC number to view connection status.

The **DHCP Release and Renew** allows users to release and renew the WAN IP address in the WAN DHCP Client Enabled (dynamic) mode.

IP Address	Subnet Mask	MAC Address
203.73.254.218	255.255.255.0	00:05:B4:06:01:25

Virtual Circuit: 0

Release Execute

Figure 6-1: WAN Status Screen

ATM Status

The **ATM Status** page shows all the statistics information of ATM cells.

Admin Privilege

[WAN Status](#)

[ATM Status](#)

[TCP Status](#)

[Route Table](#)

[Learned MAC Table](#)

[ADSL Configuration](#)

[RIP Configuration](#)

Password Configuration

[Admin](#)

[User](#)

[Misc Configuration](#)

[Reset to Factory Default](#)

[Diagnostic Test](#)

[Code Image Update](#)

ATM STATUS

[Reset Counters](#)

Tx Bytes	327858
Rx Bytes	219685
Tx Cells	6186
Rx Cells	4145
Rx HEC Errors	0
Tx Mgmt Cells	2
Rx Mgmt Cells	0
Tx CLP0 Cells	6186
Rx CLP0 Cells	4145
Tx CLP1 Cells	0

Figure 6-2: ATM Status Screen

TCP Status

The **TCP Status** page shows the statistics for all TCP connections. This is for internal network only.

Admin Privilege

[WAN Status](#)

[ATM Status](#)

[TCP Status](#)

[Route Table](#)

[Learned MAC Table](#)

[ADSL Configuration](#)

[RIP Configuration](#)

Password Configuration

[Admin](#)

[User](#)

[Misc Configuration](#)

[Reset to Factory Default](#)

[Diagnostic Test](#)

[Code Image Update](#)

TCP STATUS

[Reset Counters](#)

Total Packets Sent	2098
Data Packets Sent	1192
Data Bytes Sent	583100
Total Packets Received	2215
Packets Received in-sequence	300
Bytes Received in-sequence	124262
Out of Order Packets	291
Out of Order Bytes	0
Packets disgarded for bad checksum	0
Packets disgarded for bad header offset	0

Figure 6-3: TCP Status Screen

Route Table

The **Route Table** page displays routing table and allows you to manually enter the routing entry. The interface br0 means the USB interface; lo0 means the loop back interface.

Admin Privilege

[WAN Status](#)

[ATM Status](#)

[TCP Status](#)

[Route Table](#)

[Learned MAC Table](#)

[ADSL Configuration](#)

[RIP Configuration](#)

[Password Configuration](#)

[Admin](#)

[User](#)

[Misc Configuration](#)

[Reset to Factory Default](#)

[Diagnostic Test](#)

[Code Image Update](#)

[Network Code Image Update](#)

Route Table

Destination	Netmask	Gateway	Interface
0.0.0.0	0.0.0.0	203.73.254.1	ppp1
10.0.0.0	255.0.0.0	10.0.0.2	br0
127.0.0.1	255.0.0.0	127.0.0.1	lo0
203.73.254.1	255.255.255.255	203.73.254.218	ppp1

System Default Gateway Configuration

None

Auto

Select Interface Ip Ethernet 0

Route Configuration

Destination	Netmask	Gateway
<input style="width: 100%;" type="text"/>	<input style="width: 100%;" type="text"/>	<input checked="" type="radio"/> Specify IP <input style="width: 100%;" type="text"/> <input type="radio"/> Select Interface Ip Ethernet 0

Figure 6-4: Route Table Screen

Routing Table

- The Gateway field of the static route entry allows users to either enter a Gateway IP address or select a Network Interface.
- All user-defined routes retained in the CPE memory, regardless if they are already in the Routing Table, are displayed on the same Route Table page.
- All user defined route entries kept in the CPE memory during run time are saved to flash when the user chooses to save and reboot the CPE. When CPE restarts, it reloads all saved user-defined routes to the CPE memory and tries to apply to the system.
- A user-defined route entry is added to the Routing Table whenever the system provides an environment that makes the route entry applicable. It is removed from the Routing Table whenever the route entry becomes not applicable. e.g. If the route entry's Gateway is associated with a dynamic Network Interface but the connection is not established, then the route entry does not appear in the Routing Table. When that interface comes up later, the route entry is then added.
- If the selected Network Interface is static or is dynamic and the connection is already up, then the route entry appears in the Routing Table immediately. If there is a Gateway associated with the selected Network Interface, then that Gateway's IP address appears in the Gateway field of the route entry
- If the selected Network Interface is dynamic but the connection is not established, then the route entry does not appear in the Routing Table. When the interface comes up later, the route entry is then added.

System Default Gateway Configuration

The system-wide Default Gateway now provides three options: Auto, User-selected Network Interface, and None.

None

This field allows the user to choose to have no Default Gateway in the CPE

Auto

This field allows the user to select the CPE to automatically decide the Default Gateway. (System Default)

User-selected Network Interface

This field allows user to select a Network Interface from a list (PVCs, PPP Sessions, USB and LAN). This option lets the user to associate the system-wide Default Gateway to a Network Interface, static or dynamic, and provides a way to fix the Default Gateway to a dynamic Network Interface before the interface is established.

Route Configuration

Destination

This field allows the user to enter the remote network or host IP address for the static routing.

Netmask

This field allows the user to enter the Subnet Mask for the static routing.

Gateway

This field allows the user to enter the IP address of the gateway device that allows the router to contact the remote network or the host for Specified IP or select an Interface for the Gateway.

Manually Configured Routes displays the static route entries entered by the user

Learned MAC Table

The **Learned MAC Table** page shows the current learned Bridge MAC table. The **Aging Timeout** is for determining the update period for the MAC table.

Admin Privilege

- [WAN Status](#)
- [ATM Status](#)
- [TCP Status](#)
- [Route Table](#)
- [Learned MAC Table](#)**
- [ADSL Configuration](#)
- [RIP Configuration](#)
- Password Configuration
 - [Admin](#)
 - [User](#)
- [Misc Configuration](#)
- [Reset to Factory Default](#)
- [Diagnostic Test](#)

Bridge MAC Table

MAC Address	Expiration
00:01:29:40:49:E1	100
00:03:79:01:0C:FF	60
00:A0:CC:D5:DF:9C	49
00:C0:02:44:67:52	12
00:C0:26:66:04:74	93
00:C0:CA:10:A4:FD	94

Aging Timeout: Seconds

Figure 6-5: *Learned MAC Table Screen*

ADSL Configuration

The **ADSL Configuration** page allows you to set the configuration for ADSL protocols.

Trellis

Trellis Code. By default, it is always enabled.

Handshake Protocol

This is for the ADSL handshake protocol.

Wiring Selection

The wiring selection for the RJ-11.

Bit Swapping

Bit swapping enables an ADSL system to change the number of bits assigned to a subcarrier, or change the transmit energy of a subcarrier without interrupting data flow. (No need to configure this item unless it is necessary)

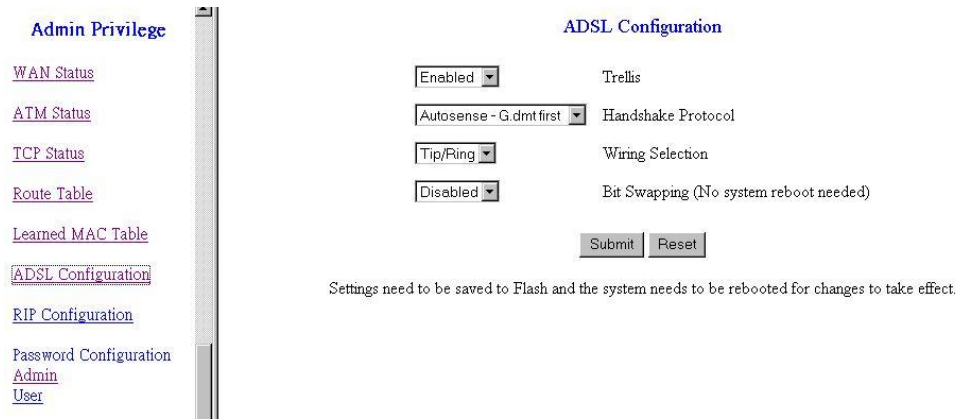

Figure 6-6: ADSL Configuration Screen

RIP Configuration

The **RIP Configuration** page allows the user to set the configuration for the system wide configuration of RIP. The actual RIP configuration is in the RIP Per Interface Configuration.

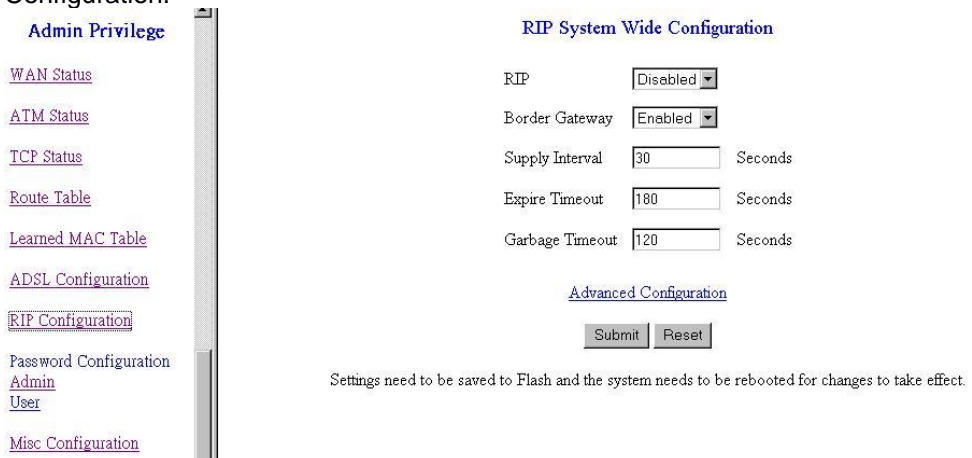

Figure 6-7: RIP System Wide Configuration Screen

RIP

This field allows the user to Enable or Disable the RIP session. The resulting RIP session will monitor all network interfaces that are currently available for messages from other RIP routers.

Supplier Interval

This field allows the user to enter the Supplier Interval timer in second. This timer specifies how often RIP sends announcements as a RIP Supplier.(Default = 30 seconds)

Expire Timeout

This field allows the user to enter the Expire timer in second. This timer specifies the expiration time of a route. When a route has not been updated for more than “expire” period of time, it is removed from the Route Table. This route is invalidated and remains in the internal RIP Route Table. It will be included in the RIP announcements to let other routers know the changes. (Default = 180 seconds)

Garbage Timeout

This field allows the user to enter the Garbage timer in second. This timer specifies how long the expired and invalidated routes are kept in the Internal RIP Route Table before it is removed from it. (Default = 300 seconds)

RIP Per Interface Configuraiton

The RIP Per Interface Configuration page allows the user to set the configuration for each Interface (PVCs, PPP Sessions, and LAN).

#	Interface	Enabled?	Supplier Mode	Listener Mode
1	Ip Ethernet 0	No	V2 BC	V1+V2
2	Ip Usb 0	No	V2 BC	V1+V2
3	Ip Pvc 0	No	Disabled	V1+V2
4	Ip Pvc 1	No	Disabled	V1+V2
5	Ip Pvc 2	No	Disabled	V1+V2

Figure 6-8: RIP Per Interface Configuration Screen

Interface

This field allows the user to choose the Interface (PVCs, PPP Sessions, USB and LAN), for the RIP to be configured.

Enable

This field allows the user to Enable (Yes) or Disable (No) the specified interface for RIP.

Supplier

This field allows the user to select the Supplier Mode (RIP Transmit).

- Disabled: The supplier transmit is disabled.
- V1 BC: The supplier transmits in RIPv1 Broadcast.
- V2 BC: The supplier transmits in RIPv2 Broadcast.

- V2 MC: The supplier transmits in RIPv2 Multicast.

Listener

This field allows the user to select the Listener Mode (RIP Receive)

- V1: The listener receives the RIPv1 only.
- V2: The listener receives the RIPv2 only.
- V1+V2: This listener receives the both RIPv1 and RIPv2.
- Supplier and Listener are based on section 4.1 “Compatibility Switch” in RFC 1723.

Current RIP Settings displays the each interface’s RIP status.

Password Configuration

The **Password Configuration** page allows users to set the passwords for user and administrator.

Misc Configuration

The **Misc Configuration** allows users to set all the miscellaneous configurations in ADE-4100.

Miscellaneous Configuration

HTTP server access

All

Restricted

LAN

WAN Specify IP

Subnet Mask

HTTP server port

FTP server

TFTP server

DMZ

DMZ HOST IP

DHCP Relay

DHCP Target IP

IGMP Proxy

PPP reconnect on WAN access

PPP Half Bridge

Settings need to be saved to Flash and the system needs to be rebooted for changes to take effect.

Figure 6-9: Miscellaneous Configuration Screen

WAN side HTTP server

When it is enabled, the Web setting pages of ADE-4100 can be accessed from the WAN side. Users can limit the administration privileges to a specified IP address or limit to LAN side user. Meantime,

FTP server

When it is enabled, the FTP connection can be established from both the LAN and WAN sides.

TFTP server

When it is enabled, it can upgrade the image code with the TFTP client application run at either the LAN or WAN sides.

An example for the TFTP client updating the vxworks.z product image code is:

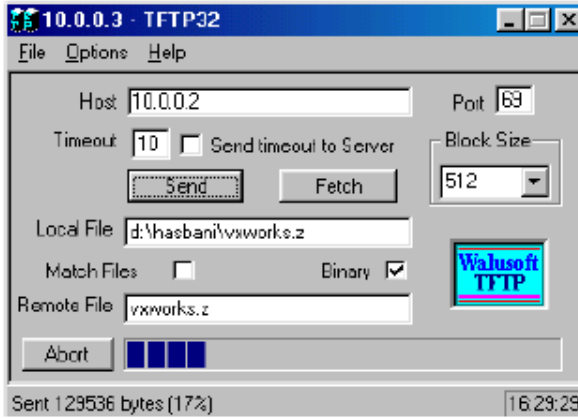

Figure 6-10: Example for TFTP server

HTTP server port

HTTP server port in ADE-4100 can be changed to other secure port number. For example, when it is changed to 8888, the HTTP server address for the LAN side is <http://10.0.0.2:8888>.

DMZ

A DMZ (De-Militarized Zone) is added between a protected network and an external network, in order to provide an additional layer of security. DMZ feature allows unrestricted 2-way communication with Servers or individual users on the Internet. This provides the most flexibility and compatibility toward Internet applications or programs, which are often restricted access with firewalls.

DMZ Host IP

The IP address of the DMZ host at LAN side.

DHCP Relay

If it is enabled, the DHCP requests from local PCs will forward to the DHCP server runs on WAN side. To have this function working properly, please disable the NAT to run on router mode only, disable the DHCP server on the LAN port, and make sure the routing table has the correct routing entry.

DHCP Target IP

The DHCP server runs on WAN side.

IGMP Proxy

Here is the global setting for IGMP Proxy. If it is enabled, then the enabled IGMP Proxy on WAN PVCs will be working. Otherwise, no WAN PVC can have IGMP Proxy working on it.

PPP connect on WAN access

If enabled, the PPP session will be automatically established when there is a packet wants to go out the WAN.

The differences between PPP connect on WAN access and the Automatic Recon-

nect:

Some ISPs would terminate the PPP session due to the inactivity.

For the **PPP connect on WAN access**, the PPP will be automatically reconnected when an URL is entered in the browser (packet interested in going out the WAN).

For the **Automatic Reconnect**, it will reconnect the PPP session whenever it is terminated by ISP.

PPP Half Bridge:

When the PPP Half Bridge is enabled, only one PC is able to access the Internet, and the DHCP server will duplicate the WAN IP address from the ISP to the local client PC. **Only the PC with the WAN IP address can access the Internet when PPP-half-bridge feature is assigned.**

Reset to Factory Default

The **Reset to Factory Default** page allows you to reset the modem to original factory default configuration (factory.reg).

Diagnostic Test

Click this link; system will perform diagnostic tests automatically. And show the testing result in **Diagnostic Test** page. If some of the tests fail, related help links are available for reference while troubleshooting.

The screenshot shows a web interface with a left sidebar and a main content area. The sidebar contains the following links: Admin Privilege, WAN Status, ATM Status, TCP Status, Route Table, Learned MAC Table, ADSL Configuration, RIP Configuration, Password Configuration, Admin, User, Misc Configuration, Reset to Factory Default, Diagnostic Test (highlighted with a dashed border), and Code Image Update. The main content area is titled 'Diagnostic Test' and displays the following results:

Test Category	Test Description	Result	Help Link
Checking LAN Connection	Testing Ethernet LAN connection	: PASS	HELP
	Testing ADSL Connection		
Checking ADSL Connection	Testing ADSL Synchronization	: PASS	HELP
	Testing Ethernet connect to ATM	: PASS	HELP
Checking Circuit 0 for Network Connection	Test ATM OAM Segment Loop Back	: PASS	HELP
	Test ATM OAM End-to-End Loop Back	: PASS	HELP
	Test Ethernet connect to ATM	: PASS	HELP
	Test simple ppp session 0 PPPOE connection	: PASS	HELP
	Test simple ppp session 0 PPP Layer connection	: PASS	HELP
Testing Internet Connection	Test simple ppp session 0 IP connect to PPP	: PASS	HELP
	Ping default gateway 203.73.254.1	: PASS	HELP
	Ping primary DNS	: N/A	HELP
	Query DNS for www.conexant.com	: SKIPPED	HELP
	Ping www.conexant.com	: SKIPPED	HELP

Figure 6-11: Diagnostic Test Result Screen

Code Image Update

The **Code Image Update** page allows you to upgrade the image code locally. Browse the location of firmware file, and click the **Upload** to start the update.

Network Code Image Update

The **Network Code Image Update** page allows user to upgrade the image code from remote FTP server.

Assume an FTP server stores the updated image on Internet. Click Image Download to initiate the updating. To set up the ftp server IP address, please save the UpdateHost parameter under [Class\ Service\System] in the config.reg file as the IP address of the specific Ftp server on Internet.

System Log

Users may acquire information of the system from this screen, including the time, and connection process related messages.

The screenshot shows the 'System Log' interface. On the left is a vertical menu with the following items: ATM Status, TCP Status, Route Table, Learned MAC Table, ADSL Configuration, RIP Configuration, Password Configuration, Admin, User, Misc Configuration, Reset to Factory Default, Diagnostic Test, Code Image Update, Network Code Image Update, Firmware, Boot Code, and System Log. The main area displays the following log entries:

```

8/22/2003 20:19:40 Received time from Time Server
128.138.140.44
L/L/1970 0:0:16> PPP1 Session is up.
L/L/1970 0:0:16> NAT: many-to-one default session is up.
L/L/1970 0:0:16> Initialized NAT.
L/L/1970 0:0:16> NAT/NAPT Session Start: interface pppl,
WAN IP is 211.74.54.189
L/L/1970 0:0:16> PPP1: DNS Secondary IP address is
139.175.252.16
L/L/1970 0:0:16> PPP1: DNS Primary IP address is
  
```

Below the log entries is a 'Clear Log' button. A note below the button reads: "If you would like to save the log to a text file, right click [here](#) and select "Save Target As ..."

Figure 6-12: System Log Screen

Appendix A

Troubleshooting



This Appendix covers the most likely problems and their solutions.

Overview

This chapter covers some common problems that may be encountered while using ADE-4100 and some possible solutions to them. If you follow the suggested steps and ADE-4100 still does not function properly, contact your dealer for further advice.

General Problems

Question 1:	Can't connect to ADE-4100 to configure it.
Answer 1:	<p>Check the following:</p> <ul style="list-style-type: none">• ADE-4100 is properly installed, LAN connections are OK, and it is powered ON.• Ensure that your PC and ADE-4100 are on the same network segment. (If you don't have a router, this must be the case.)• If your PC is set to "Obtain an IP Address automatically" (DHCP client), restart it.• If your PC uses a Fixed (Static) IP address, ensure that it is using an IP Address within the range 10.0.0.3 to 10.255.255.254 and thus compatible with ADE-4100's default IP Address of 10.0.0.2. Also, the Network Mask should be set to 255.0.0.0 to match ADE-4100. <p>In Windows, you can check these settings by using <i>Control Panel-Network</i> to check the <i>Properties</i> for the TCP/IP protocol.</p>

Configuration and Internet Access

Question 1	When I enter a URL or IP address I get a time out error.
Answer 1	<p>A number of things could be causing this.</p> <p>Try the following troubleshooting steps.</p> <ul style="list-style-type: none">• Check if other PCs work. If they do, ensure that your PCs IP settings are correct. If using a Fixed IP Address, check the Network Mask, Default gateway and DNS configured on PC.• If the PCs are configured correctly, but still not working, check ADE-4100. Ensure that it is connected and ON. Connect to it and check its settings. (If you can't connect to it, check the LAN and power connections.)• If ADE-4100 is configured correctly, contact your ISP to see if Internet connection is working correctly.
Question 2	If the PPP is disconnected after the Disconnect Timeout and how can I reconnect it?

	I reconnect it?
Answer 2	You have to go to the PPP link under Status column, choose the correct PVC and Connect option, and then click Execute to restart a new PPP secession.
Question 3	Since only one PVC is mapped to one local PC IP address, why can I input more than one IP address for one NAT session?
Answer 3	Even it is applicable to insert multiple IPs for NAT mapping, only the first IP address of each session takes effect.

Appendix B

Specifications



ADE-4100A/ADE-4100B

Product	ADSL Modem Router	
Model	ADE-4100A	ADE-4100B
ADSL Standards	Annex A	Annex B
	Full-rate ANSI T1.413 issue 2 and ITU-T G.992.1 (G.DMT), Splitterless ITU-T G.992.2 (G.lite)	
Protocol Support	RFC2364 - PPP over ATM (LLC/VCMUX) RFC2516 - PPP over Ethernet (LLCSNAP/VCMUX) RFC1577 - Classic IP over ATM RFC1483 - Bridged IP over ATM(LLCSNAP/VCMUX) RFC1483 - Routed IP over ATM (LLCSNAP/VCMUX)	
AAL & ATM Support	Integrated ATM AAL 5 support	
Data Rate	UP / DOWN Stream: 1 / 8 Mbps	
Power Supply	9V DC, 1.5A	
Environment	Operating temperature: 0°C to 40°C Operating humidity: 0% to 90% Storage temperature: -10°C to 70°C Storage humidity: 0% to 95%	
Dimension	184 mm x 143 mm x 35 mm (L x W x H)	
ADSL Interface	RJ-11 Modular Jack	