

SmartNode 4960 Series **T1/E1 PRI VoIP Router**

Getting Started Guide



Trademark Statement

The terms *SmartNode* and *SmartWare* are trademarks of Patton Electronics Company. All other trademarks presented in this document are the property of their respective owners.

Copyright © 2005–2006, Patton Electronics Company. All rights reserved.

The information in this document is subject to change without notice. Patton Electronics assumes no liability for errors that may appear in this document.

Important Information

To use virtual private network (VPN) and/or AES/DES/3DES encryption capabilities with the SmartNode 4960, you may need to purchase additional licenses, hardware, software, network connection, and/or service. Contact sales@patton.com or +1 (301) 975-1000 for assistance.

Warranty Information

The software described in this document is furnished under a license and may be used or copied only in accordance with the terms of such license. For information about the license, see [Appendix F, "End user license agreement"](#) on page 65 or go to www.patton.com.

Patton Electronics warrants all SmartNode router components to be free from defects, and will—at our option—repair or replace the product should it fail within one year from the first date of the shipment.

This warranty is limited to defects in workmanship or materials, and does not cover customer damage, abuse or unauthorized modification. If the product fails to perform as warranted, your sole recourse shall be repair or replacement as described above. Under no condition shall Patton Electronics be liable for any damages incurred by the use of this product. These damages include, but are not limited to, the following: lost profits, lost savings and incidental or consequential damages arising from the use of or inability to use this product. Patton Electronics specifically disclaims all other warranties, expressed or implied, and the installation or use of this product shall be deemed an acceptance of these terms by the user.

Summary Table of Contents

- 1 General information 13
- 2 Applications overview..... 20
- 3 SmartNode installation..... 24
- 4 Initial configuration 29
- 5 G.SHDSL Basic Configuration 38
- 6 Contacting Patton for assistance 43
- A Compliance information 46
- B Specifications 49
- C Cabling 55
- D Port pin-outs 60
- E SmartNode 4960 factory configuration 63
- F End user license agreement 65

Table of Contents

Summary Table of Contents	3
Table of Contents	4
List of Figures	7
List of Tables	8
About this guide	9
Audience.....	9
Structure.....	9
Precautions	10
Safety when working with electricity	10
General observations	11
Typographical conventions used in this document.....	11
General conventions	11
1 General information	13
SmartNode 4960 overview	14
SmartNode 4960 rear panel	16
SmartNode 4960 front panel	18
2 Applications overview	20
Introduction	21
Application—Edge intelligence of enterprise communication.....	21
Application—Multi-service ISDN Internet telephony IAD	22
3 SmartNode installation	24
Planning the installation	25
Site log	25
Network information	25
Network Diagram	25
IP related information	25
Software tools	26
Power source	26
Location and mounting requirements	26
Installing the gateway router.....	26
Placing the SmartNode	26
Installing cables	26
Connecting the PRI	27
Connecting the 10/100/1000Base-T Ethernet LAN and WAN cables	27
Installing the DSL WAN cable	27
Connecting the power supply	28
4 Initial configuration	29
Introduction	30
1. Connecting the SmartNode to your laptop PC.....	30

2. Configuring the desired IP address	31
Factory-default IP settings	31
Login	31
Changing the WAN IP address	31
3. Connecting the SmartNode to the network	32
4. Loading the configuration (optional)	33
Bootloader	34
Start Bootloader	34
Start-up with factory configuration	34
Load a new application image (SmartWare) via TFTP	34
Load a new application image (SmartWare) via the serial link	36
Additional information	37
5 G.SHDSL Basic Configuration	38
Introduction	39
Line Setup	39
Configuring PPPoE	39
Configuration Summary	40
Setting up permanent virtual circuits (PVC)	41
Using PVC channels in bridged Ethernet mode	41
Using PVC channels with PPPoE	41
Diagnostics	42
Troubleshooting DSL Connections	42
6 Contacting Patton for assistance	43
Introduction	44
Contact information	44
Patton support headquarters in the USA	44
Alternate Patton support for Europe, Middle East, and Africa (EMEA)	44
Warranty Service and Returned Merchandise Authorizations (RMAs)	44
Warranty coverage	44
Out-of-warranty service	45
Returns for credit	45
Return for credit policy	45
RMA numbers	45
Shipping instructions	45
A Compliance information	46
Compliance	47
EMC	47
Safety	47
PSTN Regulatory	47
Radio and TV Interference	47
FCC Part 68 (ACTA) Statement	47
Industry Canada Notice	48
CE Declaration of Conformity	48

B Specifications	49
DSP.....	50
Voice connectivity	50
Data connectivity	50
Voice processing (signalling dependent).....	50
Fax and modem support	51
Voice signalling	51
Voice routing—session router.....	51
IP services	52
Management	52
System	52
Physical	52
G.SHDSL Daughter Card (if applicable).....	53
Identification of the SmartNode devices via SNMP.....	54
C Cabling	55
Introduction	56
Console	56
Ethernet	57
E1 PRI	58
T1 PRI	59
D Port pin-outs	60
Introduction.....	61
Console port.....	61
Ethernet	61
PRI port	62
G.SHDSL port.....	62
E SmartNode 4960 factory configuration	63
Introduction	64
F End user license agreement	65
End User License Agreement	66
1. Definitions	66
2. Title	66
3. Term	66
4. Grant of License	66
5. Warranty	66
6. Termination	67
7. Other licenses	67

List of Figures

1	SmartNode 4960	14
2	SN4960 rear panel	16
3	SmartNode 4960 front panel	18
4	Edge intelligence of enterprise communication application	21
5	Internet telephony IAD application	22
6	Power LED (SmartNode 4960 shown)	28
7	Connecting the SmartNode to your laptop PC	30
8	Connecting the SmartNode to the network	32
9	Configuring the G.SHDSL card for PPPoE	39
10	Connecting a serial terminal	56
11	Typical Ethernet straight-through cable diagram for 10/100Base-T	57
12	Typical Ethernet straight-through cable diagram for 1000Base-T	57
13	Connecting an E1 PRI port to an NT1	58
14	E1 PRI port crossover cable	58
15	Connecting a T1 PRI port to an NT device	59
16	T1 PRI crossover cable	59
17	EIA-561 (RJ-45 8-pin) port	61

List of Tables

1	General conventions	11
2	SmartNode 4960 PRI Ports and Voice Channels	14
3	SmartNode 4960 models with integrated G.SHDSL interface	15
4	Rear panel ports	17
5	SN4960 Front and Rear panel LEDs	19
6	Sample site log entries	25
7	Factory default IP address and network mask configuration	31
8	PVC Commands	41
9	PVC channels in bridged Ethernet mode	41
10	PVC channels in PPPoE mode	41
11	Diagnostics commans	42
12	G.SHDSL Daughter Card Specifications	53
13	SmartNode Models and their Unique sysObjectID	54
14	RJ45 socket 10/100Base-T	61
15	RJ45 socket 1000Base-T	62
16	RJ-45 socket	62
17	RJ-11 connector	62

About this guide

This guide describes the SmartNode 4960 hardware, installation and basic configuration. For detailed software configuration information refer to the *SmartWare Software Configuration Guide* and the available Configuration Notes.

Audience

This guide is intended for the following users:

- Operators
- Installers
- Maintenance technicians

Structure

This guide contains the following chapters and appendices:

- [Chapter 1](#) on page 13 provides information about router features and capabilities
- [Chapter 2](#) on page 20 contains an overview describing router operation and applications
- [Chapter 3](#) on page 24 provides hardware installation procedures
- [Chapter 4](#) on page 29 provides quick-start procedures for configuring the SmartNode router
- [Chapter 5](#) on page 38 provides information on G.SHDSL basic configuration
- [Chapter 6](#) on page 43 contains information on contacting Patton technical support for assistance
- [Appendix A](#) on page 46 contains compliance information for the router
- [Appendix B](#) on page 49 contains specifications for the routers
- [Appendix C](#) on page 55 provides cable recommendations
- [Appendix D](#) on page 60 describes the router's ports and pin-outs
- [Appendix E](#) on page 63 lists the factory configuration settings for SmartNode 4960
- [Appendix F](#) on page 65 provides license information that describes acceptable usage of the software provided with the SmartNode 4960

For best results, read the contents of this guide *before* you install the router.

Precautions

Notes, cautions, and warnings, which have the following meanings, are used throughout this guide to help you become aware of potential problems. **Warnings** are intended to prevent safety hazards that could result in personal injury. **Cautions** are intended to prevent situations that could result in property damage or impaired functioning.

Note A note presents additional information or interesting sidelights.



IMPORTANT

The alert symbol and IMPORTANT heading calls attention to important information.



CAUTION

The alert symbol and CAUTION heading indicate a potential hazard. Strictly follow the instructions to avoid property damage.



CAUTION

The shock hazard symbol and CAUTION heading indicate a potential electric shock hazard. Strictly follow the instructions to avoid property damage caused by electric shock.



WARNING

The alert symbol and WARNING heading indicate a potential safety hazard. Strictly follow the warning instructions to avoid personal injury.



WARNING

The shock hazard symbol and WARNING heading indicate a potential electric shock hazard. Strictly follow the warning instructions to avoid injury caused by electric shock.

Safety when working with electricity



WARNING

This device contains no user serviceable parts. The equipment shall be returned to Patton Electronics for repairs, or repaired by qualified service personnel.



WARNING

Ensure that the power cable shipped with this device meets all applicable standards for the country in which it is to be installed. If it is not, refer to chapter Chapter 6, “[Contacting Patton for assistance](#)” on page 43 for help in replacing it with a compliant cable.



Mains Voltage: Do not open the case when the power cord is attached. For systems without a power switch, line voltages are present within the power supply when the power cords are connected. The mains outlet that is utilized to power the device shall be within 10 feet (3 meters) of the device, shall be easily accessible, grounded, and protected by a circuit breaker.



Hazardous network voltages are present in WAN ports regardless of whether power to the SmartNode is ON or OFF. To avoid electric shock, use caution when near WAN ports. When detaching cables, detach the end away from the SmartNode first.



Do not work on the system or connect or disconnect cables during periods of lightning activity.



In accordance with the requirements of council directive 2002/96/EC on Waste of Electrical and Electronic Equipment (WEEE), ensure that at end-of-life you separate this product from other waste and scrap and deliver to the WEEE collection system in your country for recycling.

General observations

- Clean the case with a soft slightly moist anti-static cloth
- Place the unit on a flat surface and ensure free air circulation
- Avoid exposing the unit to direct sunlight and other heat sources
- Protect the unit from moisture, vapors, and corrosive liquids

Typographical conventions used in this document

This section describes the typographical conventions and terms used in this guide.

General conventions

The procedures described in this manual use the following text conventions:

Table 1. General conventions

Convention	Meaning
Garamond blue type	Indicates a cross-reference hyperlink that points to a figure, graphic, table, or section heading. Clicking on the hyperlink jumps you to the reference. When you have finished reviewing the reference, click on the Go to Previous View button  in the Adobe® Acrobat® Reader toolbar to return to your starting point.
Futura bold type	Commands and keywords are in boldface font.
<i>Futura bold-italic type</i>	Parts of commands, which are related to elements already named by the user, are in boldface italic font.
<i>Italicized Futura type</i>	Variables for which you supply values are in <i>italic</i> font

Table 1. General conventions

Convention	Meaning
Futura type	Indicates the names of fields or windows.
Garamond bold type	Indicates the names of command buttons that execute an action.
< >	Angle brackets indicate function and keyboard keys, such as <SHIFT>, <CTRL>, <C>, and so on.
[]	Elements in square brackets are optional.
{a b c}	Alternative but required keywords are grouped in braces ({ }) and are separated by vertical bars ()
screen	Terminal sessions and information the system displays are in <i>screen font</i> .
node	The leading IP address or nodename of a SmartNode is substituted with node in boldface italic font.
SN	The leading SN on a command line represents the nodename of the SmartNode
#	An hash sign at the beginning of a line indicates a comment line.

Chapter 1 **General information**

Chapter contents

SmartNode 4960 overview	14
SmartNode 4960 rear panel	16
SmartNode 4960 front panel	18

SmartNode 4960 overview

The SmartNode 4960 T1/E1 PRI VoIP Router (see [figure 1](#)) combines IP routing, VPN/Security, and Quality of Service with high-quality Voice over IP (VoIP) delivered on 1 to 4 Primary Rate Interfaces (PRI T1/E1). This combination allows you to leverage low-cost Internet Telephony on existing ISDN Phones and PBX equipment for complete SoHo and branch office voice and data connectivity.



Figure 1. SmartNode 4960

The SmartNode 4960 series consists of several models. They differ in the number of PRI ports and voice channels supported. All models come equipped with two 10/100/1000Base-T Ethernet ports. The SmartNode 4960 PRI ports and voice channels are listed in [table 2](#). The SmartNode 4960 G.SHDSL models are listed in [table 3](#).

Table 2. SmartNode 4960 PRI Ports and Voice Channels

Model	PRI Ports	Voice Channels
SN4960/1E24V/UI	1	24
SN4960/1E30V/UI	1	30
SN4960/4E24V/UI	4	24
SN4960/4E30V/UI	4	30
SN4960/4E48V/UI	4	48
SN4960/4E60V/UI	4	60
SN4960/4E96V/UI	4	96
SN4960/4E120V/UI	4	120

Table 3. SmartNode 4960 models with integrated G.SHDSL interface

Model	PRI Ports	Voice Channels
SN4960/1E24VG/UI	1	24
SN4960/1E30VG/UI	1	30
SN4960/4E24VG/UI	4	24
SN4960/4E30VG/UI	4	30
SN4960/4E48VG/UI	4	48
SN4960/4E60VG/UI	4	60
SN4960/4E96VG/UI	4	96
SN4960/4E120VG/UI	4	120

The SmartNode 4960 Gateway-Router performs the following major functions:

- Up to 120 channels of Voice over IP and local voice switching via 1 or 4 PRI ports. PRI ports can be operated in user or net mode. Any port can be used as clock source.
- Standard compliant VoIP in accordance with SIP or H.323 protocols.
- Internet access and IP Routing with IP Quality of Service (QoS) support for mixed voice and data traffic.
- Optional integrated G.SHDSL.bis WAN interface. Up to 5.7 Mbps symmetrical throughput, supporting ATM QoS. Supports multiple PVC and DSLAM interoperability.

SmartNode 4960 rear panel

The SmartNode 4960 rear panel ports are described in [table 4](#).

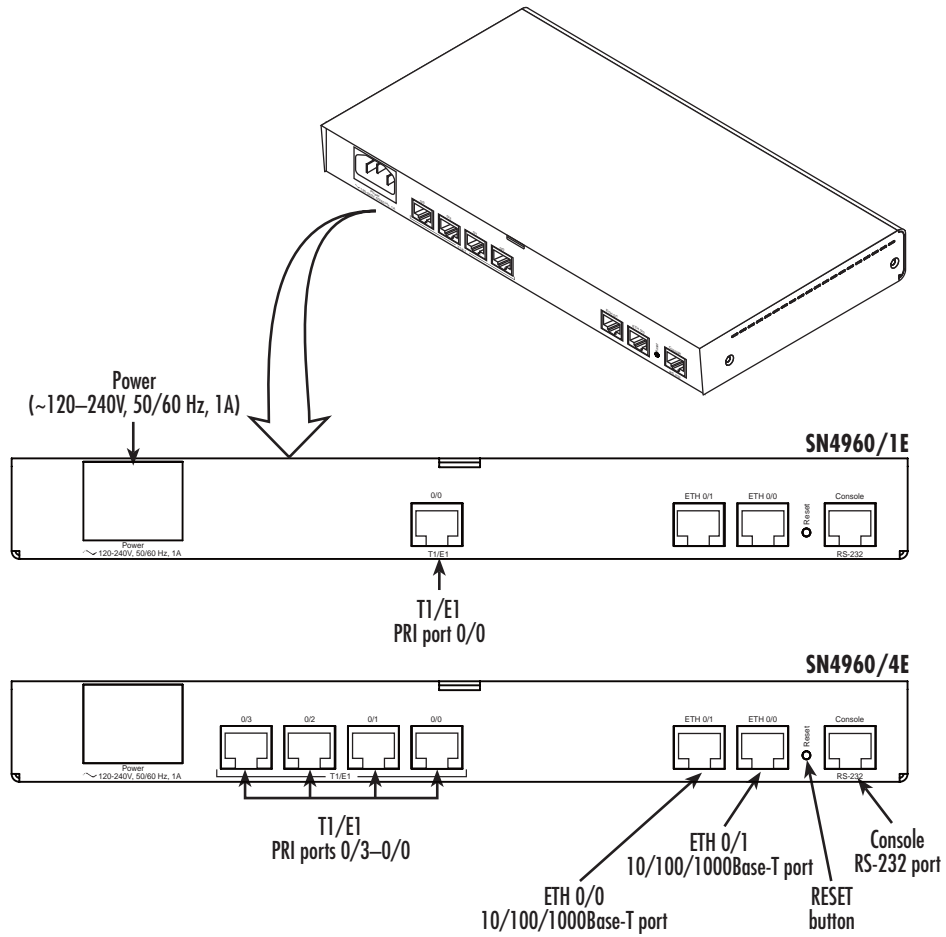

Figure 2. SN4960 rear panel

Table 4. Rear panel ports

Port	Description
WAN ETH 0/0	Auto-MDX Gigabit-Ethernet port, RJ-45 (see figure 2), connects the unit to an Ethernet WAN device (for example, a cable modem, DSL modem, or fiber modem). Note: Only full duplex modes are supported.
LAN ETH 0/1	Auto-MDX Gigabit-Ethernet port, RJ-45 (see figure 2), connect the unit to an Ethernet LAN (for example, a PC, printer, or wireless bridge). Note: Only full duplex modes are supported.
PRI 0/0	RJ-45 connector providing E1 (2.048Mbps) or T1(1.533 Mbps) PRI interface, meeting all requirements of ITU-T recommendations for G.703. Use a shielded E1 or T1 interface cable for 120 Ohm balanced connections to connect the SmartNode with an NT or ET, e.g. a PBX or LE.
PRI 0/1	RJ-45 connector providing E1 (2.048Mbps) or T1(1.533 Mbps) PRI interface, meeting all requirements of ITU-T recommendations for G.703. Use a shielded E1 or T1 interface cable for 120 Ohm balanced connections to connect the SmartNode with an NT or ET, e.g. a PBX or LE.
PRI 0/2	RJ-45 connector providing E1 (2.048Mbps) or T1(1.533 Mbps) PRI interface, meeting all requirements of ITU-T recommendations for G.703. Use a shielded E1 or T1 interface cable for 120 Ohm balanced connections to connect the SmartNode with an NT or ET, e.g. a PBX or LE.
PRI 0/3	RJ-45 connector providing E1 (2.048Mbps) or T1(1.533 Mbps) PRI interface, meeting all requirements of ITU-T recommendations for G.703. Use a shielded E1 or T1 interface cable for 120 Ohm balanced connections to connect the SmartNode with an NT or ET, e.g. a PBX or LE.
Console	Used for service and maintenance, the Console port (see figure 2), an RS-232 RJ-45 connector, connects the product to a serial terminal such as a PC or ASCII terminal (also called a dumb terminal).
100-240 VAC 50-60 Hz	Electricity supply socket for mains power cable. (see figure 2).
Reset	The reset button (see figure 2) has three functions: <ul style="list-style-type: none"> • Restart the unit with the current startup configuration—Press (for less than 1 second) and release the <i>Reset</i> button to restart the unit with the current startup configuration. • Restart the unit with factory default configuration—Press the <i>Reset</i> button for 5 seconds until the <i>Power</i> LED (see figure 3 on page 18) starts blinking to restart the unit with factory default configuration. • Restart the unit in bootloader mode (to be used only by trained SmartNode technicians)—Starting with the unit powered off, press and hold the <i>Reset</i> button as you apply power to the unit. Release the <i>Reset</i> button when the <i>Power</i> LED starts blinking so the unit will enter bootloader mode.
G.SHDSL port (option)	Provides up to 5.7 Mbps symmetrical throughput, supporting ATM QoS. Supports multiple PVC and DSLAM interoperability. The G.SHDSL LEDs are located on either side of the DSL port. ACT (when lit or blinking) shows Activity, and LINK (when lit) shows that the DSL port is connected.

SmartNode 4960 front panel

Figure 3 shows SmartNode 4960 front panel LEDs, the LED definitions are listed in table 5.

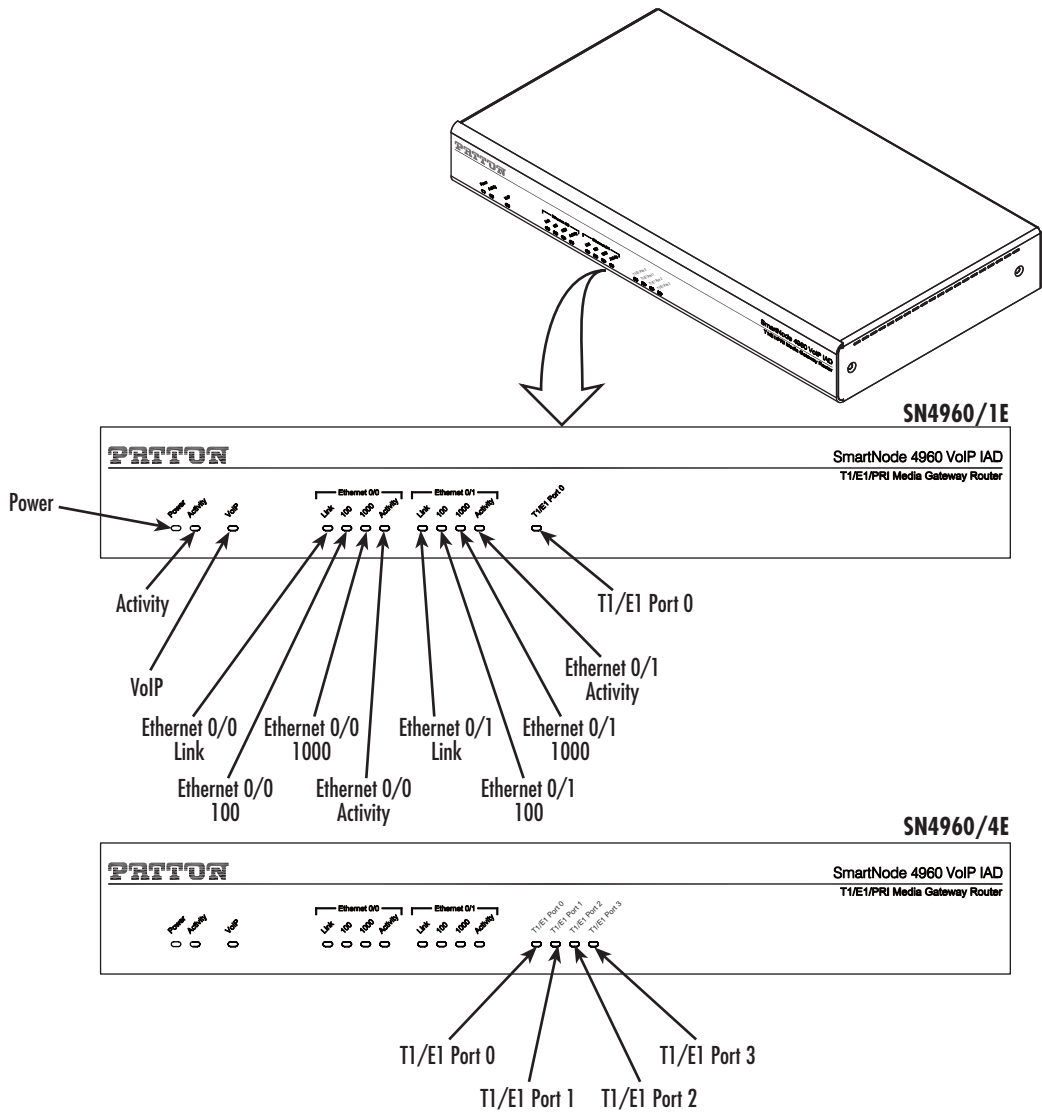

Figure 3. SmartNode 4960 front panel

Table 5. SN4960 Front and Rear panel LEDs

LED	Description
Note	If an error occurs, all LEDs will flash once per second.
Power	When lit, indicates power is applied.
Run	When lit, the unit is in normal operation. Flashes once per second during boot (startup).
VoIP Link	<ul style="list-style-type: none"> On indicates the gateway is registered to an H.323 gatekeeper/SIP server, or, in the case of direct routing, has at least one active VoIP connection. Off indicates the unit is not configured or registered, or has no active direct-routed VoIP connection. Flashing green indicates that the unit is attempting to register or has failed to register.
Ethernet Link	<ul style="list-style-type: none"> On when the Ethernet connection on the corresponding port has a link indication.
Ethernet Speed 10/100	When the Ethernet Link LED is on, then: <ul style="list-style-type: none"> On when the Ethernet is connected to a 100Mb network. Off when the Ethernet is connected to a 10Mb network.
Ethernet Speed 1000	<ul style="list-style-type: none"> On when the Ethernet is connected to a 1000Mb network.
Ethernet Activity	<ul style="list-style-type: none"> Flashes when data is received or transmitted at the corresponding Ethernet port.
PRI Link/Status	<ul style="list-style-type: none"> On = in frame, no errors Flash = Error Fast Flash = Signal detected but no frame synchronization or acquisition is in process Slow Flash = Framing synchronized, Signaling not established
G.SHDSL ACT (Rear panel)	<ul style="list-style-type: none"> Flashes when data is received or transmitted Off = No activity
G.SHDSL LINK (Rear panel)	<ul style="list-style-type: none"> On when the G.SHDSL connection on the corresponding port has a link indication. Off = No G.SHDSL connection

Chapter 2 **Applications overview**

Chapter contents

Introduction	21
Application—Edge intelligence of enterprise communication	21
Application—Multi-service ISDN Internet telephony IAD	22

Introduction

Patton's SmartNode VoIP Media Gateway Routers deliver the features you need for advanced multiservice voice and data network applications. They combine high quality voice-over-IP with powerful *quality of service* routing functions to build professional and reliable VoIP and data networks. This chapter describes typical applications for which this SmartNode is uniquely suited.

Note Detailed configuration information for the applications can be found on the CD-ROM that was included with your SmartNode device or online from the Patton webserver at www.patton.com.

Application—Edge intelligence of enterprise communication

Enterprises are excited about voice over IP and convergence for the following reasons:

- Bypassing the PSTN. Using Internet telephony service providers (ITSPs) instead of incumbent carriers dramatically reduces telephony costs
- IP PBXs, with their full suite of features and ease of integration into existing IT environments are very appealing
- Convergence lowers technology ownership costs and enables enterprises to deploy new integrated applications

However, there are several concerns about migrating the whole telephony infrastructure to VoIP:

- Loss of voice quality
- Unknown reliability
- Lack of experience/expertise in voice over IP

Patton's SmartNode series of VoIP gateways address these concerns enabling enterprises to safely migrate to VoIP. SmartNodes enable system administrators to gradually introduce VoIP, using it as the edge communication device for all worlds, connecting PSTN, legacy PBX, ITSPs and an IP PBX.

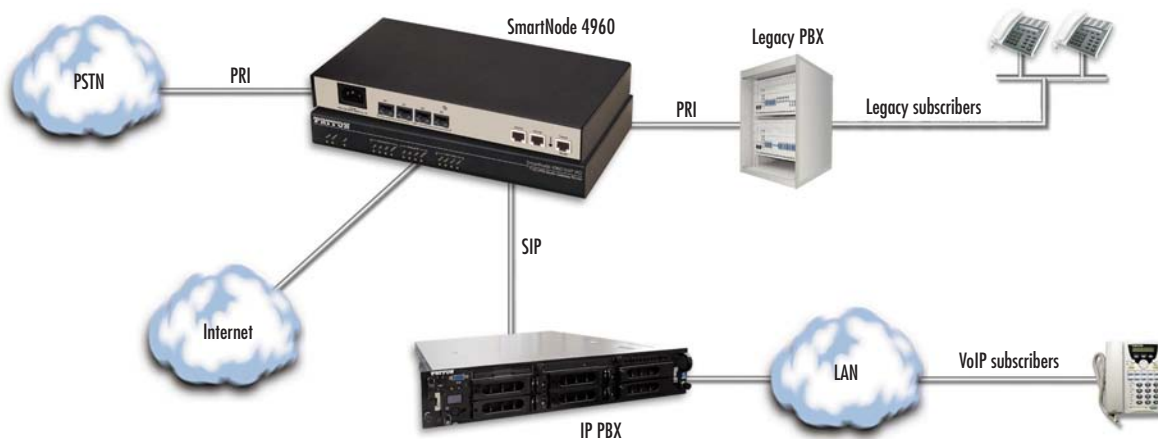

Figure 4. Edge intelligence of enterprise communication application

How it works:

1. Connect the SmartNode to the PSTN and legacy PBX, and configure the call router to pass all calls from the PBX to the PSTN and vice versa. This first step will not affect any uses in the enterprise
2. Choose your ITSPs, and configure as many on the SmartNode as you need. Use the intelligent call router in the SmartNode to decide which call is forwarded to which ITSP, and which calls should go to the PSTN. This may be based upon least-cost routing criteria, or for example, on calling party number. The latter is ideal if you want to test calls to an ITSP before enabling it for all users within the enterprise.
3. Voice over IP can be switched off instantly on one single box (the SmartNode) to revert the system back to as it was before.
4. Build up an IP PBX system that uses the SmartNode as PSTN gateway. For all calls from this IP PBX, you can direct them to the PSTN or to ITSPs. Numbering plan adaptations are handled through regular expression matching by the SmartNode. No need to change anything on the PBXs.
5. Once the IP PBX is ready, you can choose on incoming calls from the PSTN, for each extension whether this extension is to be directed to the IP PBX or on the legacy PBX.

Application—Multi-service ISDN Internet telephony IAD

The SmartNode 4960 Series can be used to make and receive calls to and from the public ISDN network and Internet Telephony services on any ISDN Terminal (Phone or PBX) (see figure 5). Using individually configurable routing tables, an outbound call can be directed to the local PSTN connection or to an Internet telephony service provider (ISTP). Inbound calls from the Internet and the PSTN can ring the same phone.

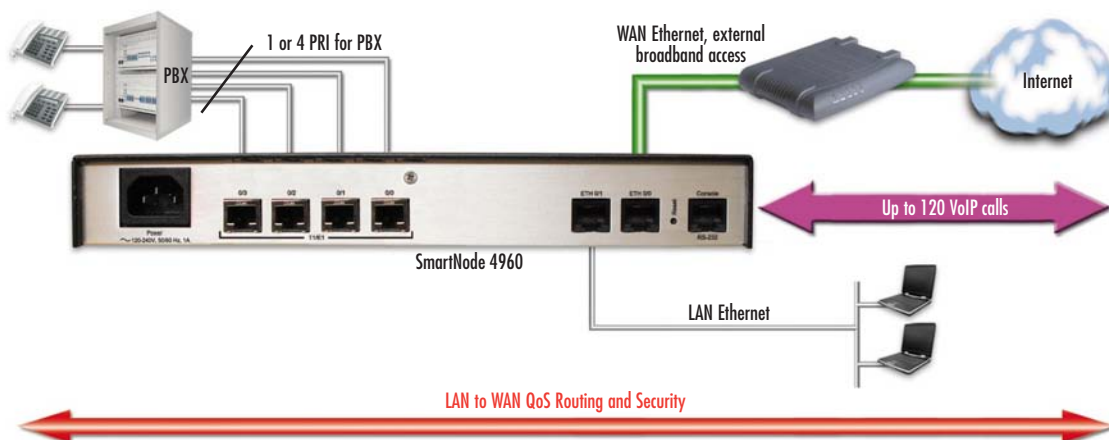

Figure 5. Internet telephony IAD application

Broadband network connectivity integrates with any fixed IP, DHCP or PPPoE service. An integrated Gigabit Ethernet LAN port, with advanced routing features such as NAT, Firewall/ACL, DynDNS as well as optional IPSec VPN, fulfills the requirements of demanding network users.

Quality of Service (QoS) features complete the offering with advanced voice prioritization and traffic management. Patton's patent-pending DownStreamQoS™ ensures voice without interruptions even over best-effort Internet connections.

Chapter 3 **SmartNode installation**

Chapter contents

Planning the installation	25
Site log	25
Network information	25
Network Diagram	25
IP related information	25
Software tools	26
Power source	26
Location and mounting requirements	26
Installing the gateway router	26
Placing the SmartNode	26
Installing cables	26
Connecting the PRI	27
Connecting the 10/100/1000Base-T Ethernet LAN and WAN cables	27
Installing the DSL WAN cable	27
Connecting the power supply	28

Planning the installation

Before installing the gateway router device, the following tasks should be completed:

- Create a **network diagram** (see section “[Network information](#)” on page 25)
- Gather **IP related information** (see section “[IP related information](#)” on page 25 for more information)
- Install the hardware and software needed to configure the SmartNode. (See section “[Software tools](#)” on page 26)
- Verify **power source reliability** (see section “[Power source](#)” on page 26).

After you have finished preparing for gateway router installation, go to section “[Installing the gateway router](#)” on page 26 to install the device.

Site log

Patton recommends that you maintain a site log to record all actions relevant to the system, if you do not already keep such a log. Site log entries should include information such as listed in [table 6](#).

Table 6. Sample site log entries

Entry	Description
Installation	Make a copy of the installation checklist and insert it into the site log
Upgrades and maintenance	Use the site log to record ongoing maintenance and expansion history
Configuration changes	Record all changes and the reasons for them
Maintenance	Schedules, requirements, and procedures performed
Comments	Notes, and problems
Software	Changes and updates to SmartWare software

Network information

Network connection considerations that you should take into account for planning are provided for several types of network interfaces are described in the following sections.

Network Diagram

Draw a network overview diagram that displays all neighboring IP nodes, connected elements and telephony components.

IP related information

Before you can set up the basic IP connectivity for your SmartNode 4960 you should have the following information:

- IP addresses used for Ethernet LAN and WAN ports
- Subnet mask used for Ethernet LAN and WAN ports

- IP addresses of central H.323 gatekeeper (if used)
- IP addresses and/or URL of SIP servers or Internet telephony services (if used)
- Login and password for PPPoE Access
- Login and password for SIP or H.323 based telephony services
- IP addresses of central TFTP server used for configuration upload and download (optional)

Software tools

You will need a PC (or equivalent) with Windows Telnet or a program such as *Tera Term Pro Web* (included on the SmartNode CD-ROM) to configure the software on your SmartNode router.

Power source

If you suspect that your AC power is not reliable, for example if room lights flicker often or there is machinery with large motors nearby, have a qualified professional test the power. Patton recommends that you include an uninterruptible power supply (UPS) in the installation to ensure that VoIP service is not impaired if the power fails.

Location and mounting requirements

The SmartNode router is intended to be placed on a desktop or similar sturdy, flat surface that offers easy access to the cables. Allow sufficient space at the rear of the chassis for cable connections. Additionally, you should consider the need to access the unit for future upgrades and maintenance.

Note Under the rack mount option, the chassis can be equipped with rack mount ears that allow for use in a 19" rack.

Installing the gateway router

SmartNode hardware installation consists of the following:

- Placing the device at the desired installation location (see section “Placing the SmartNode” on page 26)
- Connecting the interface and power cables (see section “Installing cables”)

When you finish installing the SmartNode, go to chapter 4, “Initial configuration” on page 29.

Placing the SmartNode

Place the unit on a desktop or similar sturdy, flat surface that offers easy access to the cables. The unit should be installed in a dry environment with sufficient space to allow air circulation for cooling.

Note For proper ventilation, leave at least 2 inches (5 cm) to the left, right, front, and rear of the unit.

Installing cables



WARNING

Do not work on the system or connect or disconnect cables during periods of lightning activity.

Connect the cables in the following order:



The interconnecting cables shall be acceptable for external use and shall be rated for the proper application with respect to voltage, current, anticipated temperature, flammability, and mechanical serviceability.

1. Connect the T1/E1 cables to the PRI T1/E1 ports (see [Appendix C on page 55](#) and [Appendix D on page 60](#)).
2. Connect the 10/100/1000Base-T Ethernet LAN and WAN (see section “[Connecting the 10/100/1000Base-T Ethernet LAN and WAN cables](#)” on page 27)
3. Connect the power mains cable (see section “[Connecting the power supply](#)” on page 28)

Connecting the PRI

The SmartNode comes with one or four PRI ports. These ports are usually connected to a PBX or switch (local exchange (LE)). Each PRI T1/E1 port is a RJ-48C receptacle. In most cases, a straight-through RJ-45 can be used to connect the PRI. Each port can be configured as NT (clock master) or TE (clock slave).

For details on the PRI port pin-out and ISDN cables, refer to [Appendix C, “Cabling”](#) on page 43 and [Appendix D, “port pin-outs”](#) on page 47.

Connecting the 10/100/1000Base-T Ethernet LAN and WAN cables

The SmartNode 4960 has automatic MDX (auto-crossover) detection and configuration on all Ethernet ports. Any of the ports can be connected to a host or hub/switch with a straight-through or cross-over wired cable.

1. Connect to the subscriber port of the broadband access modem (DSL, cable, WLL) to *ETH 0/0*.

Note The SmartNode Ethernet ports operate in Full Duplex mode only. Do not connect to Half Duplex ports. For best results, use auto-negotiation. Auto negotiation is mandatory when using 1000BaseT (Gigabit) Ethernet.

2. Connect port ETH 0/1 to your LAN.

Installing the DSL WAN cable. The SmartNode Model 4960 comes with an option for a G.SHDSL WAN interface. Use a straight-through RJ-11 cable to connect the G.SHDSL port.

For details on the Ethernet port pinout and cables, refer to [Appendix C, “Cabling”](#) on page 55 and [Appendix D, “Port pin-outs”](#) on page 60.

Connecting the power supply

Do the following to connect the main power to the Model 4960:

Note *Do not connect the power cord to the AC power outlet at this time.*

1. Insert the female end of the AC power to the mains port (see [figure 2](#) on page 16).



The internal power supply automatically adjusts to accept an input voltage from 100 to 240 VAC (50/60 Hz).

Verify that the proper voltage is present before plugging the power cord into the receptacle. Failure to do so could result in equipment damage.

2. Verify that the AC power cord included with your router is compatible with local standards. If it is not, refer to “[Contacting Patton for assistance](#)” on page 43 to find out how to replace it with a compatible power cord.
3. Connect the male end of the AC power cord to an appropriate AC power outlet.

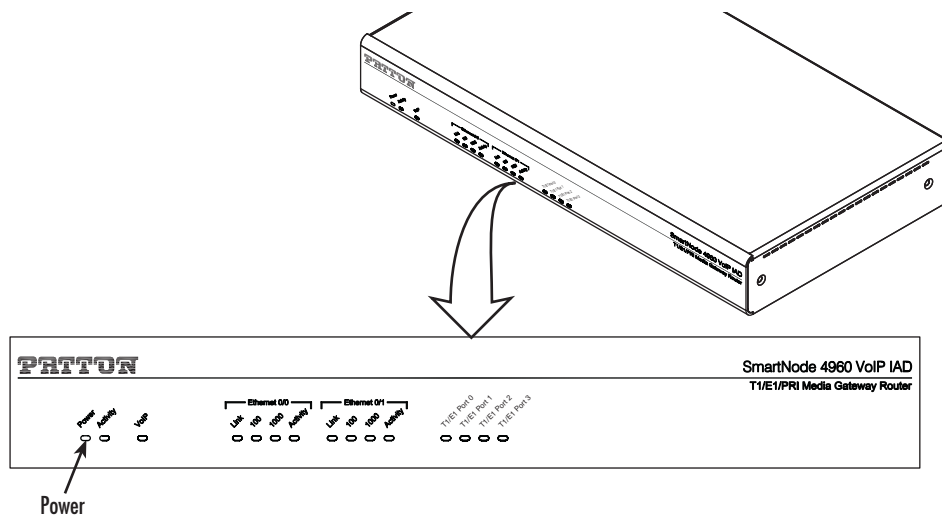

Figure 6. Power LED (SmartNode 4960 shown)

4. Verify that the green *Power* LED is lit (see [figure 6](#)).

Chapter 4 **Initial configuration**

Chapter contents

Introduction	30
1. Connecting the SmartNode to your laptop PC.....	30
2. Configuring the desired IP address	31
Factory-default IP settings	31
Login	31
Changing the WAN IP address	31
3. Connecting the SmartNode to the network	32
4. Loading the configuration (optional)	33
Bootloader.....	34
Start Bootloader	34
Start-up with factory configuration	34
Load a new application image (SmartWare) via TFTP	34
Load a new application image (SmartWare) via the serial link	36
Additional information.....	37

Introduction

This chapter leads you through the basic steps to set up a new SmartNode and to download a configuration. Setting up a new SmartNode consists of the following main steps:

Note If you haven't already installed the SmartNode, refer to chapter 3, "SmartNode installation" on page 24.

- Connecting the SmartNode to your laptop PC
- Configuring the desired IP address
- Connecting the SmartNode to the network
- Loading the configuration (optional)

Note The SmartNode CD-ROM contains a collection of third party software tools (including TFTP servers and Telnet utilities) to help you configure, operate and monitor the SmartNode device.

1. Connecting the SmartNode to your laptop PC

First the SmartNode must be connected to the mains power supply with the power cable. Wait until the *Power* LED stops blinking and stays lit constantly. Now the SmartNode is ready.



The interconnecting cables shall be acceptable for external use and shall be rated for the proper application with respect to voltage, current, anticipated temperature, flammability, and mechanical serviceability.

The SmartNode 4960 Series is equipped with Auto-MDX Ethernet ports, so you can use straight-through cables for host or hub/switch connections (see [figure 7](#)).

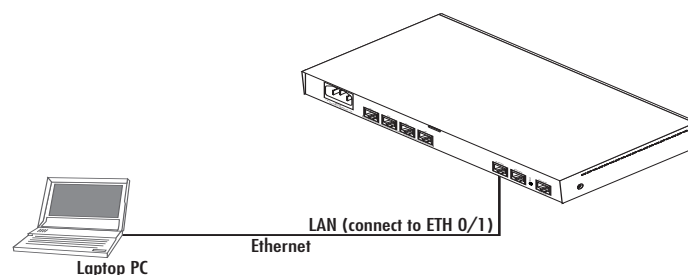

Figure 7. Connecting the SmartNode to your laptop PC

The SmartNode comes with a built-in DHCP server to simplify configuration. Therefore, to automatically configure the PC for IP connectivity to the SmartNode, the laptop PC must be configured for DHCP. The SmartNode will provide the PC with an IP address. You can check the connection to the SmartNode by executing the ping command from the PC command window as follows:

```
ping 192.168.1.1
```

2. Configuring the desired IP address

Factory-default IP settings

The factory default configuration for the Ethernet interface IP addresses and network masks are listed in [table 7](#). Both Ethernet interfaces are activated upon power-up. LAN interface *ETH 0/1 (LAN)* provides a default DHCP server, the WAN interface uses DHCP client to automatically assign the IP address and network mask.

Table 7. Factory default IP address and network mask configuration

	IP Address	Network Mask
WAN interface Ethernet 0 (ETH 0/0)	DHCP	DHCP
LAN interface Ethernet 1 (ETH 0/1)	192.168.1.1	255.255.255.0
DHCP address range	192.168.1.10–192.168.1.99	255.255.255.0

If these addresses match with those of your network, go to section “[3. Connecting the SmartNode to the network](#)” on page 32. Otherwise, refer to the following sections to change the addresses and network masks.

Note For configuring the IP address of the integrated WAN interface (G.SHDSL), please refer to Chapter 5, “[G.SHDSL Basic Configuration](#)” on page 38.

Login

To access the SmartNode, start the Telnet application. Type the default IP address for the router into the address field: 192.168.1.1. Accessing your SmartNode via a Telnet session displays the login screen. Type the factory default login: *administrator* and leave the password empty. Press the *Enter* key after the password prompt.

```
login:administrator
password: <Enter>
192.168.1.1>
```

After you have successfully logged in you are in the operator execution mode, indicated by > as command line prompt. With the commands *enable* and *configure* you enter the configuration mode.

```
192.168.1.1>enable
192.168.1.1#configure
192.168.1.1(cfg)#
```

Changing the WAN IP address

Select the context IP mode to configure an IP interface.

```
192.168.1.1(cfg)#context ip router
192.168.1.1(ctx-ip)[router]#
```

Now you can set your IP address and network mask for the interface *ETH 0/0 (WAN)*. Within this example a network 172.16.1.0/24 address is assumed. The IP address in this example is set to 172.16.1.99 (you should set this the IP address given to you by your network provider).

```
192.168.1.1(ctx-ip)[router]#interface WAN
192.168.1.1(if-ip)[WAN]#ipaddress 172.16.1.99 255.255.255.0
2002-10-29T00:09:40 : LOGINFO      : Link down on interface WAN.
2002-10-29T00:09:40 : LOGINFO      : Link up on interface WAN.
172.16.1.99(if-ip)[WAN]#
```

Copy this modified configuration to your new start-up configuration. This will store your changes in non-volatile memory. Upon the next start-up the system will initialize itself using the modified configuration.

```
172.16.1.99(if-ip)[WAN]#copy running-config startup-config
172.16.1.99(if-ip)[WAN]#
```

The SmartNode can now be connected to your network.

3. Connecting the SmartNode to the network

In general, the SmartNode will connect to the network via the *WAN (ETH 0/0)* port. This enables the SmartNode to offer routing services to the PC hosts on *LAN (ETH 0/1)* port. The SmartNode 4960 Series is equipped with Auto-MDX Ethernet ports, so you can use straight-through or crossover cables for host or hub/switch connections (see [figure 8](#)).



The interconnecting cables shall be acceptable for external use and shall be rated for the proper application with respect to voltage, current, anticipated temperature, flammability, and mechanical serviceability.

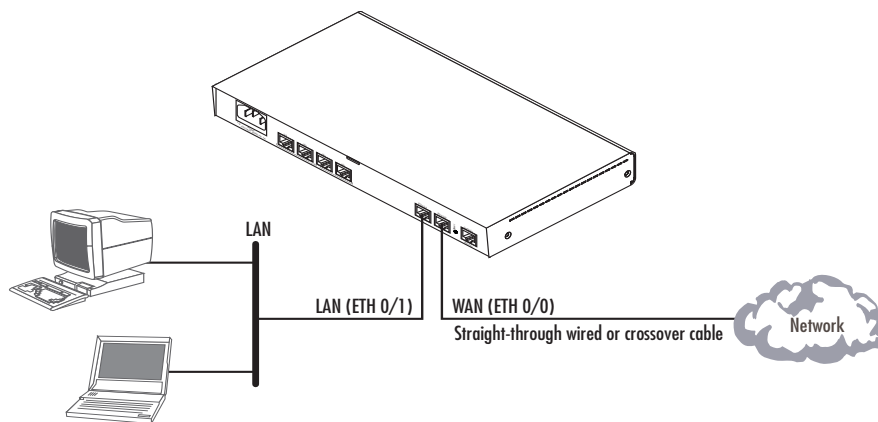

Figure 8. Connecting the SmartNode to the network

You can check the connection with the ping command from the SmartNode to another host on the network.

```
172.16.1.99(if-ip)[WAN]#ping <IP Address of the host>
```

Note If the WAN address is *not* set to DHCP, to ping a device outside your local LAN you must first configure the default gateway. (For information on configuring the default gateway, refer to section “Set IP addresses” in Appendix C, “Command Summary” of the *SmartNode Series SmartWare Software Configuration Guide*.)

4. Loading the configuration (optional)

Patton provides a collection of configuration templates on the CD-ROM that came with the SmartNode device—and also on the support page at www.patton.com/voip—one of which may be similar enough to your application that you can use it to speed up configuring the SmartNode. Simply download the configuration note that matches your application to your PC. Adapt the configuration as described in the configuration note to your network (remember to modify the IP address) and copy the modified configuration to a TFTP server. The SmartNode can now load its configuration from this server.

Note Patton regularly adds new configuration templates to the collection at www.patton.com/voip, so if you do not see your application on the CD-ROM, it may have been added to the website.

Note If your application is unique and not covered by any of Patton’s configuration templates, you can manually configure the SmartNode instead of loading a configuration file template. In that case, refer to the *SmartNode Series SmartWare Software Configuration Guide* for information on configuring the SmartNode device.

In this example we assume the TFTP server on the host with the IP address 172.16.1.11 and the configuration named *SN.cfg* in the root directory of the TFTP server.

```
172.16.1.99(if-ip)[WAN]#copy tftp://172.16.1.11/SN.cfg startup-config
Download...100%
172.16.1.99(if-ip)[WAN]#
```

After the SmartNode has been rebooted the new startup configuration will be activated.



When you issue the **reload** command, the SmartNode will ask if you want to copy the running configuration to the startup configuration. Since you just downloaded a configuration file to the startup configuration you must answer this question with **NO**. Otherwise, the downloaded configuration will be overwritten and lost!

```

172.16.1.99(if-ip)[WAN]#reload
Running configuration has been changed.
Do you want to copy the 'running-config' to the 'startup-config'?
Press 'yes' to store, 'no' to drop changes : no
Press 'yes' to restart, 'no' to cancel : yes
The system is going down

```

Bootloader

The bootloader ensures that basic operations, network access, and downloads are possible in case of interrupted or corrupted application image downloads. It offers console access to the Bootloader and the capability for downloading application images (e.g. SmartWare) via the serial link of the console.

Start Bootloader

To start the Bootloader, power on the SmartNode while pressing the reset button. Open a Telnet session to the SmartNode via one of the Ethernet interfaces, or open a CLI session via the console port (if available on the SmartNode). The login display will appear. Using the credentials admin / patton , log in to the SmartNode. The following prompt will be displayed:

```
RedBoot>
```

Type **help** to display an overview of the available commands.

Start-up with factory configuration

Step	Command	Purpose
1	RedBoot> fis load	Copies the SmartWare application image from the persistent memory (flash:) to the volatile memory (RAM) from where it will be executed.
2	RedBoot> go -s factory-config	Starts the SmartWare application telling it to use 'factory-config' as startup configuration. You can also start-up with any other configuration available in the persistent memory (nvram:) by providing its name instead of 'factory-config'.

Load a new application image (SmartWare) via TFTP

The following procedure downloads the application image (SmartWare) for the mainboard. See the note below on how to download the respective CLI description file.

Step	Command	Purpose
1 optional	RedBoot> ip_address - I <i>local_ip_address [/mask_len]</i>	Sets the IP address and subnet mask of the Ethernet interface 0/0 which shall be used to receive the new application image. <i>mask_len</i> is the length of the network address (or the number of 1's within the subnet mask). See Note below.

Step	Command	Purpose
2 optional	RedBoot> ip_address -g gateway	Sets the IP address of the default gateway.
3 optional	RedBoot> ping -h tftp-server_ip_address	Tests the connectivity to the TFTP server.
4	RedBoot> load -r -v -h host -b base_address file_name	Downloads an application image into the volatile memory (RAM) from where the SmartNode could directly execute it. <i>host</i> : IP address of the TFTP server <i>base_address</i> : memory location where to store the application image. Use the default address 0x1800100 <i>file_name</i> : path and name of the file on the TFTP server. Note: use the image file that contains the whole application, not the image parts.
5	RedBoot> fis delete -n 1	Deletes the first application image. Reply with 'y' to the confirmation request.
6	RedBoot> fis create	Stores the downloaded application image to the permanent memory (flash:). Reply with 'y' to the confirmation request.
7	RedBoot> fis list -l	Checks whether the image has been successfully stored, whether it is the desired Release and Build, and whether it is valid.
8	RedBoot> go	Starts the application image that was downloaded into the volatile memory (RAM).

Note With the Bootloader, only the Ethernet interface 0/0 is available. The Bootloader applies the IP address, subnet mask, and default gateway that were last configured by the Bootloader itself or by another application (e.g. SmartWare). If an application configured the Ethernet interface 0/0 to use DHCP, the Bootloader will also use DHCP to learn the interface configuration. It can receive and apply the IP address, subnet mask, default gateway, and default (TFTP) server (transmitted as basic DHCP information 'Next server IP address').

Note This procedure does not download the respective CLI description file. Download it after starting up SmartWare with the following command:
copy tftp://<tftp_server_address>/<server path>/bl flash:

Example: Downloading and storing a new application image (SmartWare)

```
RedBoot> ip -l 172.16.40.98/19
RedBoot> ip -g 172.16.32.1
RedBoot> ping -h 172.16.32.100
Network PING - from 172.16.40.98 to 172.16.32.100
.....PING - received 10 of 10 expected

RedBoot> load -r -v -h 172.16.32.100 -b 0x1800100 /Sn4xxx/image.bin
```

```

Using default protocol (TFTP)
-
Raw file loaded 0x01800100-0x0199ca6b, 1689964 bytes, assumed entry at 0x01800100

RedBoot> fis delete -n 1
Delete image 1 - continue (y/n)? y
... Erase from 0x60030000-0x601cc974: .....

RedBoot> fis create
Use address 0x01800100, size 1684402 ? - continue (y/n)? y
... Erase from 0x60030000-0x601cb3ba: .....
... Program from 0x00011eec-0x00011ef4 at 0x60030000: .
... Program from 0x01800100-0x0199b4b2 at 0x60030008: .....
... Program from 0x00011eec-0x00011ef4 at 0x60030000: .
Image successfully written to flash

RedBoot> fis list -l
Id Address      Length   State      Description
  Entry        Load Addr      Version
-----
1  0x60030000  1693438  valid      SmartWare R2.10 BUILD28015
   0x01800100  0x01800100      V2.10

RedBoot> go
Starting 'SmartWare R2.10 BUILD28015' at 0x01800100 via 0x01800100

```

Load a new application image (SmartWare) via the serial link

The Bootloader supports the 'X-Modem' and 'Y-Modem' protocols to download application images via the serial link of the console. Do the following to initiate the download:

Step	Command	Purpose
1	RedBoot> load -r -v -m { xmodem ymodem } -b base_address	Downloads an application image into the volatile memory (RAM) from where the SmartNode could directly execute it. 'xmodem' or 'ymodem': Specify the protocol to be used, X-Modem or Y-Modem <i>base_address</i> : memory location where to store the application image. Use the default address 0x1800100 Execute the above RedBoot command first, then start the transfer from the terminal program with the command 'Send file via X-Modem' (or similar).
5	RedBoot> fis delete -n 1	Deletes the first application image. Reply with 'y' to the confirmation request.
6	RedBoot> fis create	Stores the downloaded application image to the permanent memory (flash:). Reply with 'y' to the confirmation request.
7	RedBoot> fis list -l	Checks whether the image has been successfully stored, whether it is the desired Release and Build, and whether it is valid.

Step	Command	Purpose
8	RedBoot> go	Starts the application image that was downloaded to the volatile memory (RAM).

Note This type of download takes about **25 minutes** since it uses a serial link at only 9600 bps.

Additional information

For detailed information about configuring and operating guidance, set up procedures, and troubleshooting, refer to the *SmartNode Series SmartWare Software Configuration Guide* on the CD-ROM.

Chapter 5 **G.SHDSL Basic Configuration**

Chapter contents

Introduction	39
Line Setup	39
Configuring PPPoE.....	39
Configuration Summary.....	40
Setting up permanent virtual circuits (PVC).....	41
Using PVC channels in bridged Ethernet mode	41
Using PVC channels with PPPoE	41
Diagnostics	42
Troubleshooting DSL Connections.....	42

Introduction

The SN4960 model has an option for a built-in G.SHDSL modem. The modem appears in the configuration as "port dsl 0 0" mode.

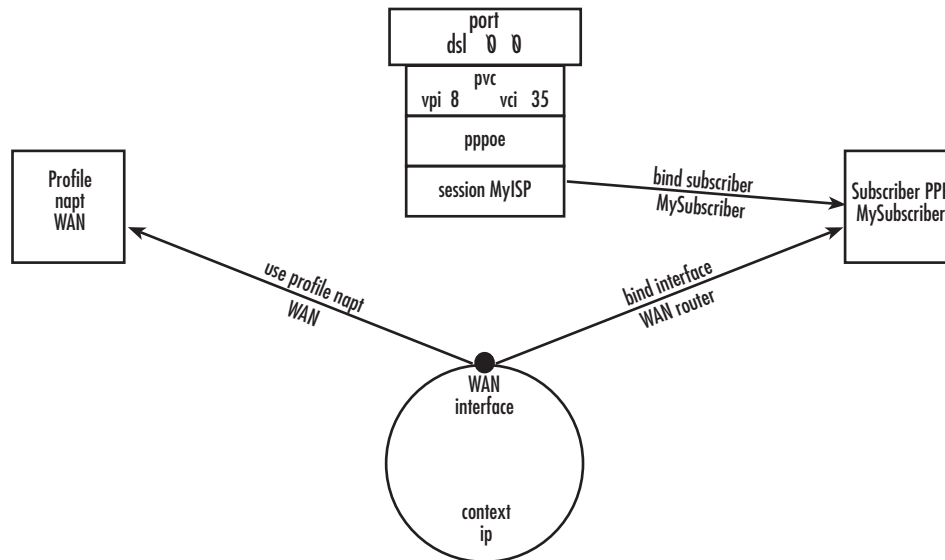

Figure 9. Configuring the G.SHDSL card for PPPoE



CAUTION

The Modem setup uses IP messages within its own subnet: 192.0.2.0/24. SmartNodes with built-in modems cannot use this subnet in any other way.

Note For information about the specifications of the G.SHDSL daughter card, see Appendix B, “Specifications” on page 49.

Line Setup

There is no line modulation setting. The modems automatically adapt to the bit rate and modulation used. The status LED on the back of the device is blinking while the modem attempts to connect and lit when the link is established. If the modem keeps blinking, check the cabling,

Configuring PPPoE

Figure 9 explains how to configure PPPoE on the SmartNode’s built-in G.SHDSL card. To configure the DSL port for PPPoE, first you need to log in to the SmartNode via the CLI and enter configuration mode.

```
login: administrator
password: <enter>
SN4xxx>enable
SN4xxx>#configure
```

Next, you will need to create a WAN profile, create a WAN interface, and create a subscriber. Then, you can configure the DSL port (port dsl 0 0) for PPPoE.

Follow this example:

```
profile napt WAN

context ip router
  interface WAN
    ipaddress unnumbered
    point-to-point
    use profile napt WAN
    tcp adjust-mss rx mtu
    tcp adjust-mss tx mtu

subscriber ppp MySubscriber
  dial out
  authentication chap
  identification outbound <username> password <password>
  bind interface WAN router

port dsl 0 0
  pvc vpi 8 vci 35
  pppoe
    session MyISP
    bind subscriber MySubscriber
    no shutdown
```

The line - use profile napt WAN - defines that the NAPT profile *<profile>* will be used on the ip interface *<name>*. For PPPoE, you will only use outbound for identification. You will want to use authentication, which is why you bind to a subscriber. You can use authentication chap or authentication pap. The line - bind subscriber MySubscriber - binds the PPPoE session to the PPP subscriber, in case authentication is required. If you do not use authentication, then you will not have a subscriber and you will bind directly to the interface.

Configuration Summary

The modems offer multiple bridged Ethernet connections through logical channels within the DSL link. A logical connection is called a Permanent Virtual Circuit (PVC) and is identified by a VPI/VCI number pair. Consult your provider's configuration instructions for connections used on your DSL link. You define those PVCs inside "port dsl 0 0":

```
port dsl 0 0
  pvc vpi 8 vci 35
```

In the mode "pvc", you define what to do with the bridged Ethernet connection it offers:

- Bind one or more IP interfaces when your providers uses fixed ip addresses or DHCP in the network
- Enter PPPoE mode and define a PPP session if the provider is using PPPoE.

Note PPPoA is not supported.

Setting up permanent virtual circuits (PVC)

The modems currently available are using ATM to multiplex traffic over the DSL framing connection. ATM allows you to have separate logical connections running in parallel. Those connections are called permanent virtual circuits (PVC). All permanent virtual circuits use AAL5 framing.

Table 8. PVC Commands

	Command	Purpose
Step 1	node(prt-dsl)[0/0]# [no] pvc vpi 8 vci 35	Creates PVC 8/35 and enters configuration mode for this PVC. The "no"-variant deletes the PVC configuration.
Step 2	node(pvc)[8/35]# encapsulation {llc vc}	Sets the encapsulation to be used. Optionally select either LLC encapsulation or VC multiplexing for this PVC. Default: llc

Using PVC channels in bridged Ethernet mode

The PVC offers a bridged Ethernet connection as specified in RFC1483, which can be used as an IP link e.g. with DHCP to assign the address, DNS server, and default gateway. To do this, you bind an IP interface to the PVC like it would be done to a normal Ethernet port.

Table 9. PVC channels in bridged Ethernet mode

	Command	Purpose
Step 1	node(pvc)[vpi/vci]# [no] bind interface <if-name>	Associates an IP interface configuration with this PVC.

Using PVC channels with PPPoE

The RFC1483 bridged Ethernet connection can also be used for PPPoE. To do this, you enter PPPoE mode within the PVC mode. All PPPoE commands apply as if the PVC was a regular Ethernet port.

Table 10. PVC channels in PPPoE mode

	Command	Purpose
Step 1	node(pvc)[vpi/vci]# pppoe	Enters PPPoE configuration mode for this PVC.
Step 2	node(pppoe)# session <name>	Defines a PPPoE session.
Step 3	node(session)[<name>]# bind subscriber <subscriber-name>	Links the session to a subscriber definition.
Step 4	node(session)[<name>]# no shutdown	Enables the PPPoE session

Note The bridged PVC connections are internally mapped to VLANs on a virtual Ethernet port 0/2. You will therefore see references to this third Ethernet port when displaying PPPoE status information or debug logs.

Diagnostics

Table 11. Diagnostics commands

	Command	Purpose
Step 1	node> show dsl type	Displays the type of modem installed.
Step 2	node> show dsl line-state	Displays information about the state of the DSL link.
Step 3	node> show dsl version	Display firmware version information for the modem.
Step 4	node# debug dsl-setup	Lists the configuration interactions between the gateway and the modem module.

Troubleshooting DSL Connections

Link State:

- Verify that the DSL link is established (status LED is continuously on)

PPPoE access:

- Check if "show pppoe detail 3" shows "State: opened". This indicates that the PVC is valid and that you reached a PPPoE server through it.
- Check if "show ppp networks detail 3" shows "State: opened" for both the "LCP" and the "CHAP" section. If LCP is not working, there is probably no compatible authentication protocol configured. Make sure "authentication chap" and "authentication pap" are included in the subscriber setup. If only CHAP failed there may be an error with the username or password.
- Run the "debug" command: **node# debug dsl-setup** (See [table 11](#) above).

Chapter 6 **Contacting Patton for assistance**

Chapter contents

Introduction	44
Contact information	44
Patton support headquarters in the USA	44
Alternate Patton support for Europe, Middle East, and Africa (EMEA)	44
Warranty Service and Returned Merchandise Authorizations (RMAs)	44
Warranty coverage	44
Out-of-warranty service	45
Returns for credit	45
Return for credit policy	45
RMA numbers	45
Shipping instructions	45

Introduction

This chapter contains the following information:

- “[Contact information](#)”—describes how to contact Patton technical support for assistance.
- “[Warranty Service and Returned Merchandise Authorizations \(RMAs\)](#)”—contains information about the warranty and obtaining a return merchandise authorization (RMA).

Contact information

Patton Electronics offers a wide array of free technical services. If you have questions about any of our other products we recommend you begin your search for answers by using our technical knowledge base. Here, we have gathered together many of the more commonly asked questions and compiled them into a searchable database to help you quickly solve your problems.

Patton support headquarters in the USA

- Online support: available at www.patton.com
- E-mail support: e-mail sent to support@patton.com will be answered within 1 business day
- Telephone support: standard telephone support is available five days a week—from 8:00 am to 5:00 pm EST (1300 to 2200 UTC/GMT)—by calling +1 (301) 975-1007
- Fax: +1 (253) 663-5693

Alternate Patton support for Europe, Middle East, and Africa (EMEA)

- Online support: available at www.patton-inalp.com
- E-mail support: e-mail sent to support@patton-inalp.com will be answered within 1 business day
- Telephone support: standard telephone support is available five days a week—from 8:00 am to 5:00 pm CET (0900 to 1800 UTC/GMT)—by calling +41 (0)31 985 25 55
- Fax: +41 (0)31 985 25 26

Warranty Service and Returned Merchandise Authorizations (RMAs)

Patton Electronics is an ISO-9001 certified manufacturer and our products are carefully tested before shipment. All of our products are backed by a comprehensive warranty program.

Note If you purchased your equipment from a Patton Electronics reseller, ask your reseller how you should proceed with warranty service. It is often more convenient for you to work with your local reseller to obtain a replacement. Patton services our products no matter how you acquired them.

Warranty coverage

Our products are under warranty to be free from defects, and we will, at our option, repair or replace the product should it fail within one year from the first date of shipment. Our warranty is limited to defects in workmanship or materials, and does not cover customer damage, lightning or power surge damage, abuse, or unauthorized modification.

Out-of-warranty service

Patton services what we sell, no matter how you acquired it, including malfunctioning products that are no longer under warranty. Our products have a flat fee for repairs. Units damaged by lightning or other catastrophes may require replacement.

Returns for credit

Customer satisfaction is important to us, therefore any product may be returned with authorization within 30 days from the shipment date for a full credit of the purchase price. If you have ordered the wrong equipment or you are dissatisfied in any way, please contact us to request an RMA number to accept your return. Patton is not responsible for equipment returned without a Return Authorization.

Return for credit policy

- Less than 30 days: No Charge. Your credit will be issued upon receipt and inspection of the equipment.
- 30 to 60 days: We will add a 20% restocking charge (crediting your account with 80% of the purchase price).
- Over 60 days: Products will be accepted for repairs only.

RMA numbers

RMA numbers are required for all product returns. You can obtain an RMA by doing one of the following:

- Completing a request on the RMA Request page in the *Support* section at **www.patton.com**
- By calling **+1 (301) 975-1007** and speaking to a Technical Support Engineer
- By sending an e-mail to **returns@patton.com**

All returned units must have the RMA number clearly visible on the outside of the shipping container. Please use the original packing material that the device came in or pack the unit securely to avoid damage during shipping.

Shipping instructions

The RMA number should be clearly visible on the address label. Our shipping address is as follows:

Patton Electronics Company

RMA#: xxxx

7622 Rickenbacker Dr.

Gaithersburg, MD 20879-4773 USA

Patton will ship the equipment back to you in the same manner you ship it to us. Patton will pay the return shipping costs.

Appendix A **Compliance information**

Chapter contents

Compliance	47
EMC	47
Safety	47
PSTN Regulatory	47
Radio and TV Interference	47
FCC Part 68 (ACTA) Statement	47
Industry Canada Notice	48
CE Declaration of Conformity	48

Compliance

EMC

- FCC Part 15, Class A
- EN55022, Class A
- EN55024

Safety

- UL 60950-1/CSA C22.2 N0. 60950-1
- IEC/EN60950-1
- AS/NZS 60950-1

PSTN Regulatory

- FCC Part 68
- CS-03
- TBR 12 & 13 (E1)
- AS/ACIF S016:2001 (E1)
- AS/ACIF S043:2003 (G.SHDSL card)

Radio and TV Interference

The SmartNode router generates and uses radio frequency energy, and if not installed and used properly—that is, in strict accordance with the manufacturer's instructions—may cause interference to radio and television reception. The SmartNode router have been tested and found to comply with the limits for a Class A computing device in accordance with specifications in Subpart B of Part 15 of FCC rules, which are designed to provide reasonable protection from such interference in a commercial installation. However, there is no guarantee that interference will not occur in a particular installation. If the SmartNode router does cause interference to radio or television reception, which can be determined by disconnecting the unit, the user is encouraged to try to correct the interference by one or more of the following measures: moving the computing equipment away from the receiver, re-orienting the receiving antenna and/or plugging the receiving equipment into a different AC outlet (such that the computing equipment and receiver are on different branches).

FCC Part 68 (ACTA) Statement

This equipment complies with Part 68 of FCC rules and the requirements adopted by ACTA. On the bottom side of this equipment is a label that contains—among other information—a product identifier in the format US: AAAEQ##TXXXX. If requested, this number must be provided to the telephone company.

The method used to connect this equipment to the premises wiring and telephone network must comply with the applicable FCC Part 68 rules and requirements adopted by the ACTA.

If this equipment causes harm to the telephone network, the telephone company will notify you in advance that temporary discontinuance of service may be required. But if advance notice isn't practical, the telephone

company will notify the customer as soon as possible. Also, you will be advised of your right to file a complaint with the FCC if you believe it is necessary.

The telephone company may make changes in its facilities, equipment, operations or procedures that could affect the operation of the equipment. If this happens the telephone company will provide advance notice in order for you to make necessary modifications to maintain uninterrupted service.

If trouble is experienced with this equipment, for repair or warranty information, please contact our company. If the equipment is causing harm to the telephone network, the telephone company may request that you disconnect the equipment until the problem is resolved.

Connection to party line service is subject to state tariffs. Contact the state public utility commission, public service commission or corporation commission for information.

Industry Canada Notice

This equipment meets the applicable Industry Canada Terminal Equipment Technical Specifications. This is confirmed by the registration number. The abbreviation, IC, before the registration number signifies that registration was performed based on a Declaration of Conformity indicating that Industry Canada technical specifications were met. It does not imply that Industry Canada approved the equipment.

This Declaration of Conformity means that the equipment meets certain telecommunications network protective, operational and safety requirements. The Department does not guarantee the equipment will operate to the user's satisfaction. Before installing this equipment, users should ensure that it is permissible to be connected to the facilities of the local telecommunications company. The equipment must also be installed using an acceptable method of connection. In some cases, the company's inside wiring associated with a single line individual service may be extended by means of a certified connector assembly (telephone extension cord). The customer should be aware that compliance with the above condition may not prevent degradation of service in some situations. Repairs to some certified equipment should be made by an authorized maintenance facility designated by the supplier. Any repairs or alterations made by the user to this equipment, or equipment malfunctions, may give the telecommunications company cause to request the user to disconnect the equipment. Users should ensure for their own protection that the ground connections of the power utility, telephone lines and internal metallic water pipe system, are connected together. This protection may be particularly important in rural areas.

CE Declaration of Conformity

This equipment conforms to the requirements of Council Directive 1999/5/EC on the approximation of the laws of the member states relating to Radio and Telecommunication Terminal Equipment and the mutual recognition of their conformity.

The safety advice in the documentation accompanying this product shall be obeyed. The conformity to the above directive is indicated by CE sign on the device.

The signed Declaration of Conformity can be downloaded at www.patton.com/certifications.

Appendix B **Specifications**

Chapter contents

DSP.....	50
Voice connectivity	50
Data connectivity	50
Voice processing (signalling dependent).....	50
Fax and modem support.....	51
Voice signalling	51
Voice routing—session router.....	51
IP services	52
Management	52
System	52
Physical	52
G.SHDSL Daughter Card (if applicable).....	53
Identification of the SmartNode devices via SNMP.....	54

Note Refer to the software feature matrix for the most up-to-date specifications.

DSP

One or two 60-channel DSPs

Voice connectivity

1 or 4 PRI T1/E1 ports on RJ48C connectors

Net/User configurable per port

Each port can be slave or master clock

Each port can be used to synchronize to an external clock master

Data connectivity

Two 10/100/1000Base-Tx Gigabit Ethernet ports

All ports full duplex, autosensing, auto-MDX

Voice processing (signalling dependent)

Four or eight full-duplex channels with Voice CODECS:

- G.711 A-Law/ μ -Law (64 kbps)
- G.726 (ADPCM 16, 24, 32, 40 kbps)
- G.723.1 (5.3 or 6.3 kbps)
- G.729ab (8 kbps)
- Transparent ISDN data

G.168 echo cancellation (128 ms)

Up to 120 simultaneous voice or T.38 fax calls

DTMF detection and generation

Carrier tone detection and generation

Silence suppression and comfort noise

Adaptive and configurable dejitter buffer

Configurable tones (dial, ringing, busy)

Configurable transmit packet length

RTP/RTCP (RFC 1889)

Fax and modem support

Automatic fax and modem detection

Codec fallback for modem-bypass

T.38 Fax-Relay (Gr. 3 Fax, 9.6 k, 14.4 k)

G.711 Fax-Bypass

Voice signalling

SIPv2

H.323v4

MGCP/IUA

SIP call transfer, redirect

Overlap or en-bloc dialing

DTMF in-band, out-of-band

Configurable progress tones

Voice routing—session router

Local switching (hairpinning)

Least cost routing

Interface huntgroups

Call-Distribution groups

Number blocking

Call Routing Criteria:

- Interface
- Calling/called party number
- Time of day, day of week, date
- ISDN bearer capability
- Various other information elements (IEs) of the ISDN setup
- Wildcard and regular expression matching

Regular expression number manipulation functions:

- Replace numbers
- Add/remove digits
- Pattern matching and replacement

IP services

IPv4 router; RIPv1, v2 (RFC 1058 and 2453)

Programmable static routes

ICMP redirect (RFC 792); Packet fragmentation

DiffServe/ToS set or queue per header bits

Packet Policing discards excess traffic

802.1p VLAN tagging

IPSEC AH & ESP Modes

Manual Key; IKE

AES/DES/3DES Encryption

Management

Web-based GUI

Industry standard CLI with local console (RJ-45, RJ-231, 9600 bps, 8, N, 1) and remote Telnet access, fully documented

HTTP web management and firmware loading

TFTP configuration & firmware loading

SNMP v1 agent (MIB II and private MIB)

Built-in diagnostic tools (trace, debug)

Secure Auto-provisioning

System

CPU Motorola MPC8360 series operating at 266/400 MHz

Memory:

- 128 Mbytes RAM (DDR, 266MHz)
- 8 Mbytes Flash

Physical

Dimensions: 11.9W x 1.71H x 7.16D inch (302W x 44H x 182mm)

Weight: <21 oz. (<600g)

Power Consumption: < 16W

Operating temperature: 32–104°F (0–40°C)

Operating humidity: up to 90%, non condensing

G.SHDSL Daughter Card (if applicable)

Note For information on configuring the G.SHDSL daughter card, see Chapter 5, “G.SHDSL Basic Configuration” on page 38.

Table 12. G.SHDSL Daughter Card Specifications

Factor	Specs
DSL	<ul style="list-style-type: none"> • ITU-T G.991.2 (and Amendment 2) • ITU-T G.991.2, Annex A, B, F, G • Upgradable to ITU-T G.shdsl.bis—Annex F and G • G.991.2 2/4 (1/2 pair) operation • G.994.1 (G.hs) (per G.991.2) • ITU-T G.991.2 Section E.9 (TPS-TC for ATM transport) • ITU-T G.991.2 Section E.11 (TPS-TC for PTM transport)
DSL Connection	RJ-11/12 (2-wire)
Management	<ul style="list-style-type: none"> • I.610 OAM F4/F5 • Management interfaces: GUI and Telnet • Software upgrade: GUI and TFTP
ATM Support	<ul style="list-style-type: none"> • Classical IPoA (RFC 1577/2225) • PPPoE Client (over ATM) (RFC 2516) • IPoA (RFC 2684/1483) • ATM AAL5 encapsulation • Max. 8 PVCs • User selectable VC MUX and LLC MUX (default) • Configurable auto-connection • ATM QoS: UBR (default), CBR, and VBR-rt, VBR-nrt, UBR: per VC queuing • Auto-configuration: TR-037 & ILMI 4.0
Interworking/Interoperability	<ul style="list-style-type: none"> • G.SHDSL Interoperability: <ul style="list-style-type: none"> - Alcatel - NEC - Lucent Anymedia - Lucent Stinger • BRAS Interoperability: <ul style="list-style-type: none"> - Cisco - Redback

Identification of the SmartNode devices via SNMP

All SmartNode devices have assigned sysObjectID (.iso.org.dod.internet.mgmt.mib-2.system.sysObjectID) numbers (see [table 13](#)).

Table 13. SmartNode Models and their Unique sysObjectID

SmartNode Model	SysObjectID
SN4960/1E15V/UI	.iso.org.dod.internet.private.enterprises.patton.products.sn49xx.1 1.3.6.1.4.1.1768.100.4.10.1
SN4960/1E24V/UI	.iso.org.dod.internet.private.enterprises.patton.products.sn49xx.2 1.3.6.1.4.1.1768.100.4.10.2
SN4960/1E30V/UI	.iso.org.dod.internet.private.enterprises.patton.products.sn49xx.3 1.3.6.1.4.1.1768.100.4.10.3
SN4960/4E15V/UI	.iso.org.dod.internet.private.enterprises.patton.products.sn49xx.4 1.3.6.1.4.1.1768.100.4.10.4
SN4960/4E24V/UI	.iso.org.dod.internet.private.enterprises.patton.products.sn49xx.5 1.3.6.1.4.1.1768.100.4.10.5
SN4960/4E30V/UI	.iso.org.dod.internet.private.enterprises.patton.products.sn49xx.6 1.3.6.1.4.1.1768.100.4.10.6
SN4960/4E48V/UI	.iso.org.dod.internet.private.enterprises.patton.products.sn49xx.7 1.3.6.1.4.1.1768.100.4.10.7
SN4960/4E60V/UI	.iso.org.dod.internet.private.enterprises.patton.products.sn49xx.8 1.3.6.1.4.1.1768.100.4.10.8
SN4960/4E96V/UI	.iso.org.dod.internet.private.enterprises.patton.products.sn49xx.9 1.3.6.1.4.1.1768.100.4.10.9
SN4960/4E120V/UI	.iso.org.dod.internet.private.enterprises.patton.products.sn49xx.10 1.3.6.1.4.1.1768.100.4.10.10

Note The SysObjectIDs for the SN4960 G.SHDSL models are the same as the corresponding non-G.SHDSL models listed above.

According to [table 13](#), an SNMP get request to *.iso.org.dod.internet.mgmt.mib-2.system.sysObjectID* of a SmartNode 4960/1E15V/UI device reads out a numeric OID of *1.3.6.1.4.1.1768.100.4.10.1*, which represents a SmartNode 4960/1E15V/UI device. The mapping of the sysObjectID to each of the SmartNode model is realized with the SmartNode product identification MIB.



The SNMP agent running in SmartWare is SNMP version 1 (SNMPv1) compliant. SNMP version 2 (SNMPv2) and SNMP version 3 (SNMPv3) are not currently supported.

Appendix C **Cabling**

Chapter contents

Introduction	56
Console	56
Ethernet	57
E1 PRI	58
T1 PRI	59

Introduction

This section provides information on the cables used to connect the SmartNode and the interface cards to the existing network infrastructure and to third party products.

Console

The SmartNode can be connected to a serial terminal over its serial console port, as depicted in [figure 10](#).



CAUTION

The interconnecting cables shall be acceptable for external use and shall be rated for the proper application with respect to voltage, current, anticipated temperature, flammability, and mechanical serviceability.

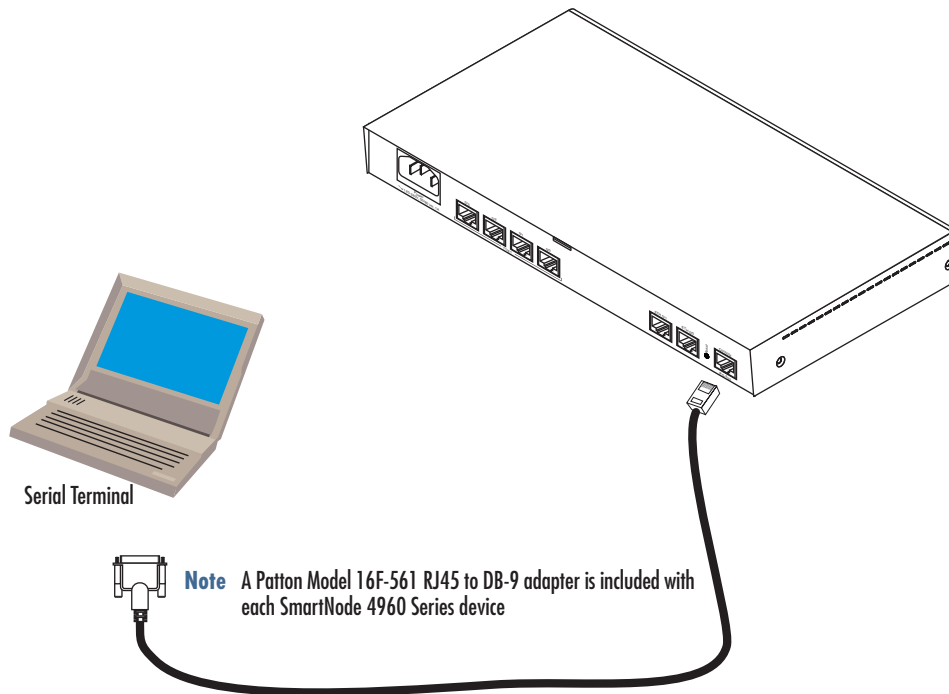

Figure 10. Connecting a serial terminal

Note See section “[Console port](#)” on page 61 for console port pin-outs.

Ethernet

Ethernet devices (10Base-T/100Base-T/1000Base-T) are connected to the SmartNode over a cable with RJ-45 plugs. All Ethernet ports on the SN4960 are Auto-MDX use any straight or crossover cable to connect to hubs, switches, PCs or other devices.



The interconnecting cables shall be acceptable for external use and shall be rated for the proper application with respect to voltage, current, anticipated temperature, flammability, and mechanical serviceability.

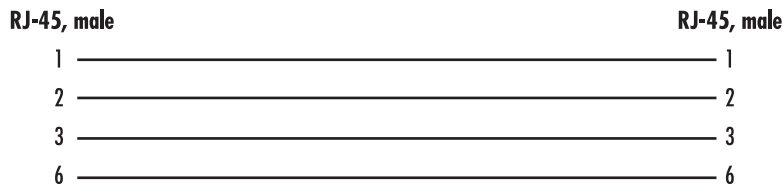
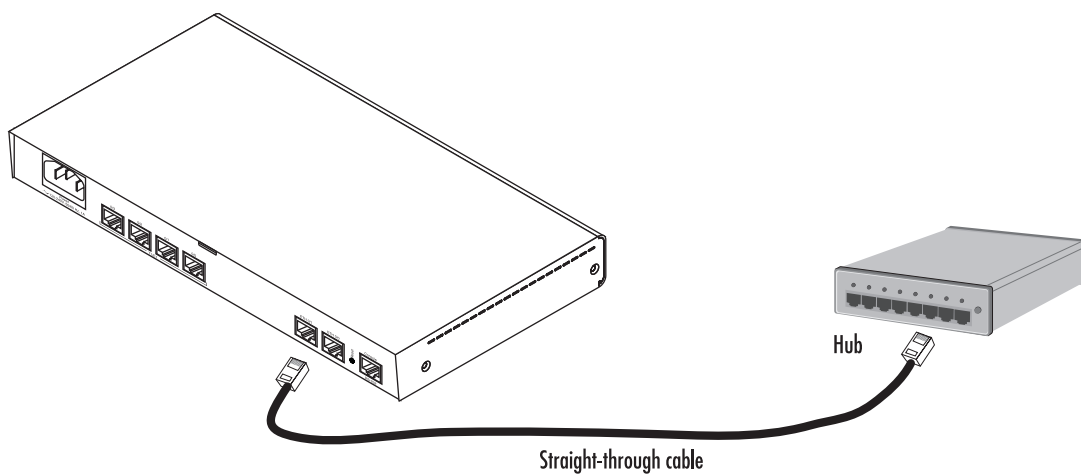

Note: Other pins are not used.

Figure 11. Typical Ethernet straight-through cable diagram for 10/100Base-T

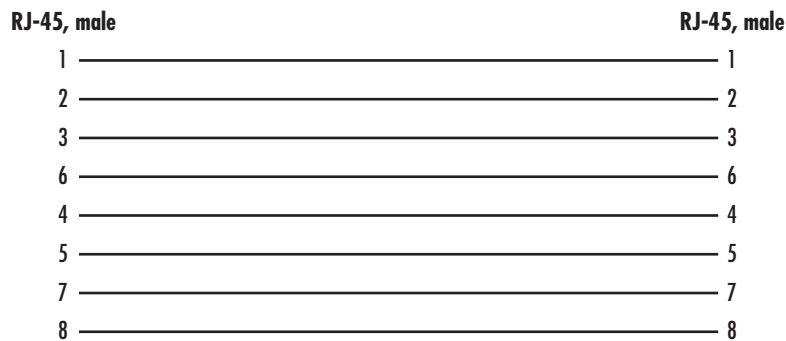

Figure 12. Typical Ethernet straight-through cable diagram for 1000Base-T

E1 PRI

The E1 PRI is usually connected to a PBX or switch—local exchange (LE). Type and pin outs of these devices vary depending on the manufacturer. In most cases, a straight-through RJ-45 to RJ-45 can be used to connect the PRI with a PBX. A cross-over cable is required to connect to an NT device, as illustrated in [figure 13](#) on page 58.



Hazardous network voltages are present in the PRI cables. If you detach the cable, detach the end away from the SmartNode or interface card first to avoid possible electric shock. Network hazardous voltages may be present on the device in the area of the PRI port, regardless of when power is turned OFF.



To prevent damage to the system, make certain you connect the PRI cable to the PRI port only and not to any other RJ-45 socket.

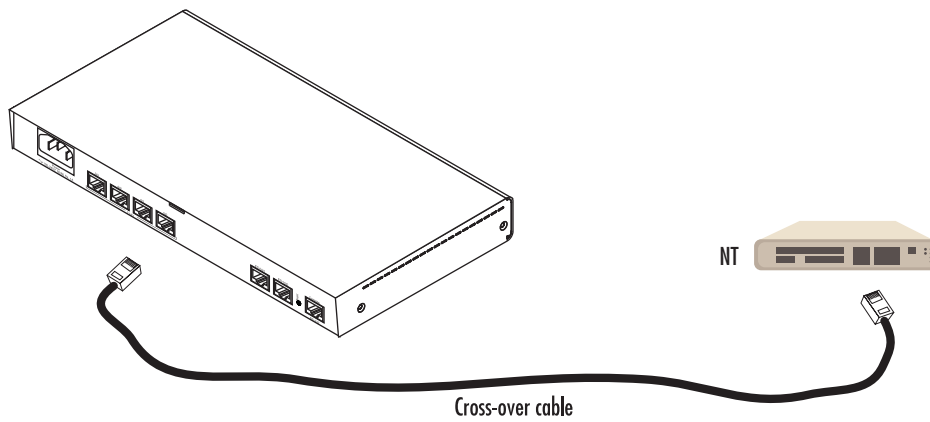

Figure 13. Connecting an E1 PRI port to an NT1

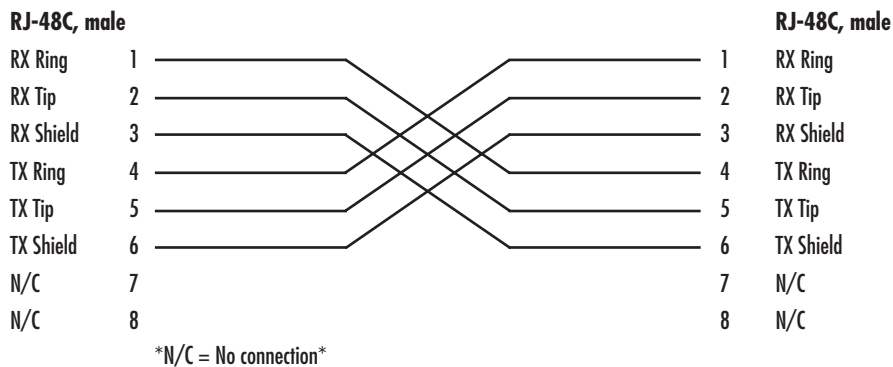

Figure 14. E1 PRI port crossover cable

T1 PRI

The T1 PRI is usually connected to a PBX or switch—local exchange (LE). Type and pin outs of these devices vary depending on the manufacturer. In most cases, a straight-through RJ-45 to RJ-45 can be used to connect the PRI with a PBX. A cross-over cable is required to connect to an NT device, as illustrated in [figure 15](#) on page 59.



Hazardous network voltages are present in the PRI cables. If you detach the cable, detach the end away from the SmartNode or interface card first to avoid possible electric shock. Network hazardous voltages may be present on the device in the area of the PRI port, regardless of when power is turned OFF.



To prevent damage to the system, make certain you connect the PRI cable to the PRI port only and not to any other RJ-45 socket.

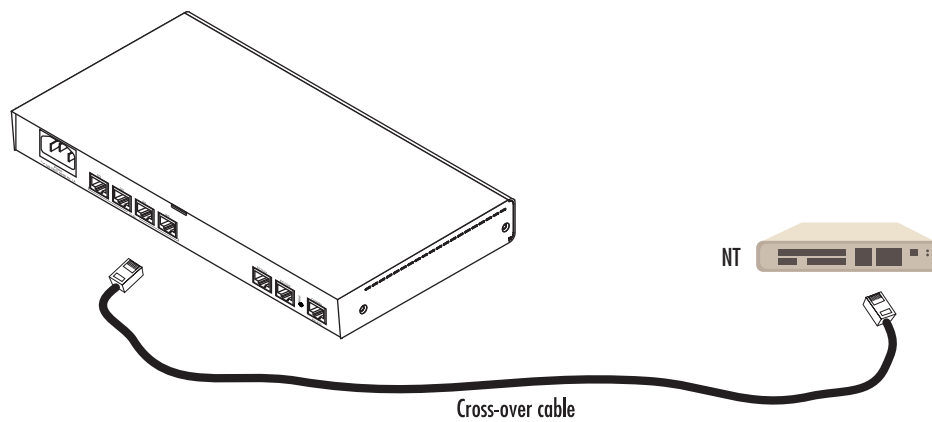

Figure 15. Connecting a T1 PRI port to an NT device

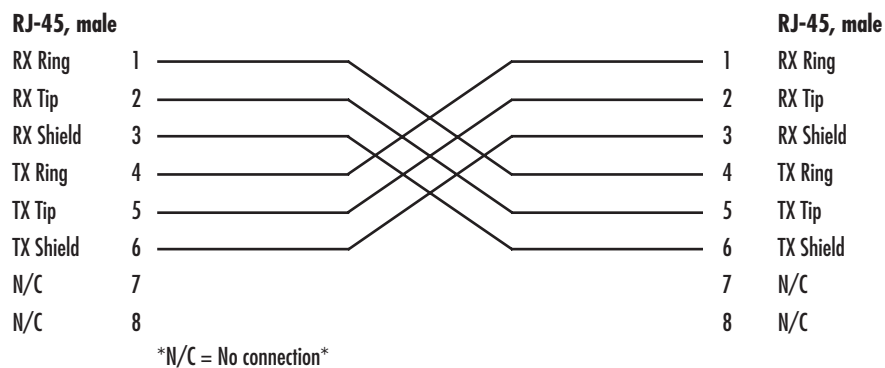

Figure 16. T1 PRI crossover cable

Appendix D **Port pin-outs**

Chapter contents

Introduction.....	61
Console port.....	61
Ethernet	61
PRI port	62
G.SHDSL port.....	62

Introduction

This section provides pin-out information for the ports of the SmartNode.

Console port

Configuration settings: 9600 bps, 8 bits, no parity, 1 stop bit, no flow control

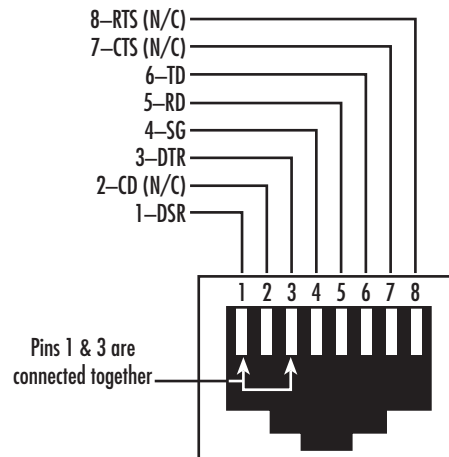

Figure 17. EIA-561 (RJ-45 8-pin) port

Note *N/C* means no internal electrical connection.

Ethernet

Table 14. RJ45 socket 10/100Base-T

Pin	Signal
1	TX+
2	TX-
3	RX+
6	RX-

Note Pins not listed are not used.

Table 15. RJ45 socket 1000Base-T

Pin	Signal
1	TRD0+
2	TRD0-
3	TRD1+
6	TRD1-
4	TRD2+
5	TRD2-
7	TRD3+
8	TRD3-

PRI port

Table 16. RJ-45 socket

Pin	USR
1	RX Ring
2	RX Tip
3	RX Shield
4	TX Ring
5	TX Tip
6	TX Shield

Note Pins not listed are not used.

G.SHDSL port

Table 17. RJ-11 connector

Pin	Signal
1	No connection
2	Tip
3	Ring
6	No connection

Note Pins not listed are not used.

Appendix E **SmartNode 4960 factory configuration**

Chapter contents

Introduction	64
--------------------	----

Introduction

The factory configuration settings for SmartNode 4960 are as follows:

```
#-----#
#
# 4960 Series
# Factory configuration file
#
#-----#

dns-relay
sntp-client
sntp-client server primary 129.132.2.21 port 123 version 4

system

ic voice 0
  low-bitrate-codec g729

profile napt NAPT_WAN

profile dhcp-server DHCPS_LAN
network 192.168.1.0 255.255.255.0
include 1 192.168.1.10 192.168.1.99
lease 2 hours
default-router 1.192.168.1.1
domain-name-server 1.192.168.1.1

context ip router

interface WAN
  ipaddress dhcp
  use profile napt NAPT_WAN
  tcp adjust-mss rx mtu
  tcp adjust-mss tx mtu

interface LAN
  ipaddress 192.168.1.1 255.255.255.0
  tcp adjust-mss rx mtu
  tcp adjust-mss tx mtu

context ip router
  dhcp-server use DHCPS_LAN

port ethernet 0 0
  medium auto
  encapsulation ip
  bind interface WAN router
  no shutdown

port ethernet 0 1
  medium auto
  encapsulation ip
  bind interface LAN router
  no shutdown
```

Appendix F **End user license agreement**

Chapter contents

End User License Agreement	66
1. Definitions	66
2. Title	66
3. Term	66
4. Grant of License	66
5. Warranty	66
6. Termination	67
7. Other licenses	67

End User License Agreement

By opening this package, operating the Designated Equipment or downloading the Program(s) electronically, the End User agrees to the following conditions:

1. Definitions

- A) *Effective Date* shall mean the earliest date of purchase or download of a product containing the Patton Electronics Company Program(s) or the Program(s) themselves.
- B) *Program(s)* shall mean all software, software documentation, source code, object code, or executable code.
- C) *End User* shall mean the person or organization which has valid title to the Designated Equipment.
- D) *Designated Equipment* shall mean the hardware on which the Program(s) have been designed and provided to operate by Patton Electronics Company.

2. Title

Title to the Program(s), all copies of the Program(s), all patent rights, copyrights, trade secrets and proprietary information in the Program(s), worldwide, remains with Patton Electronics Company or its licensors.

3. Term

The term of this Agreement is from the Effective Date until title of the Designated Equipment is transferred by End User or unless the license is terminated earlier as defined in section “6. Termination” on page 67.

4. Grant of License

- A) During the term of this Agreement, Patton Electronics Company grants a personal, non-transferable, non-assignable and non-exclusive license to the End User to use the Program(s) only with the Designated Equipment at a site owned or leased by the End User.
- B) The End User may copy licensed Program(s) as necessary for backup purposes only for use with the Designated Equipment that was first purchased or used or its temporary or permanent replacement.
- C) The End User is prohibited from disassembling; decompiling, reverse-engineering or otherwise attempting to discover or disclose the Program(s), source code, methods or concepts embodied in the Program(s) or having the same done by another party.
- D) Should End User transfer title of the Designated Equipment to a third party after entering into this license agreement, End User is obligated to inform the third party in writing that a separate End User License Agreement from Patton Electronics Company is required to operate the Designated Equipment.

5. Warranty

The Program(s) are provided *as is* without warranty of any kind. Patton Electronics Company and its licensors disclaim all warranties, either express or implied, including but not limited to the implied warranties of merchantability, fitness for a particular purpose or non-infringement. In no event shall Patton Electronics Company or its licensors be liable for any damages whatsoever (including, without limitation, damages for loss of business profits, business interruption, loss of business information, or other pecuniary loss) arising out of the use of or inability to use the Program(s), even if Patton Electronics Company has been advised of the possibility of such damages. Because some states do not allow the exclusion or limitation of liability for consequential or incidental damages, the above limitation may not apply to you.

If the Program(s) are acquired by or on behalf of a unit or agency of the United States Government, the Government agrees that such Program(s) are *commercial computer software* or *computer software documentation* and that, absent a written agreement to the contrary, the Government's rights with respect to such Program(s) are limited by the terms of this Agreement, pursuant to Federal Acquisition Regulations 12.212(a) and/or DEARS 227.7202-1(a) and/or sub-paragraphs (a) through (d) of the "Commercial Computer Software - Restricted Rights" clause at 48 C.F.R. 52.227-19 of the Federal Acquisition Regulations as applicable.

6. Termination

- A) The End User may terminate this agreement by returning the Designated Equipment and destroying all copies of the licensed Program(s).
- B) Patton Electronics Company may terminate this Agreement should End User violate any of the provisions of section "4. Grant of License" on page 66.
- C) Upon termination for A or B above or the end of the Term, End User is required to destroy all copies of the licensed Program(s)

7. Other licenses

The Program may be subject to licenses extended by third parties. Accordingly, Patton Electronics Company licenses the Programs subject to the terms and conditions dictated by third parties. Third party software identified to the Programs includes:

- A routing license is included at no charge.
- MGCP capabilities will require the purchase of an additional license.
- The LGPL (Lesser General Public License) open source license distributed to you pursuant to the LGPL license terms (<http://www.gnu.org/licenses/lgpl.html>).
- RedBoot (Red Hat Embedded Debug and Bootstrap) embedded system debug/bootstrap environment from Red Hat distributed to you pursuant to the eCos license terms (<http://ecos.sourceware.org/license-overview.html>) and GNU General Public License (GPL) terms (<http://www.gnu.org/copyleft/gpl.html>). Source code is available upon request.