

SmartNode 4630 Series **ISDN BRI SO VoIP Gateway Router**

Getting Started Guide



Sales Office: +1 (301) 975-1000
Technical Support: +1 (301) 975-1007
E-mail: support@patton.com
WWW: www.patton.com

Document Number: **13221U1-001 Rev. D**
Part Number: **07MSN4630-G5**
Revised: **July 20, 2006**



Patton Electronics Company, Inc.

7622 Rickenbacker Drive
Gaithersburg, MD 20879 USA
Tel: +1 (301) 975-1000
Fax: +1 (301) 869-9293
Support: +1 (301) 975-1007
Web: www.patton.com
E-mail: support@patton.com

Trademark Statement

The terms *SmartNode*, *SmartWare* and *SmartView* are trademarks of Patton Electronics Company. All other trademarks presented in this document are the property of their respective owners.

Copyright © 2005–2006, Patton Electronics Company. All rights reserved.

The information in this document is subject to change without notice. Patton Electronics assumes no liability for errors that may appear in this document.

Important Information

To use virtual private network (VPN) and/or AES/DES/3DES encryption capabilities with the SmartNode 4630, you may need to purchase additional licenses, hardware, software, network connection, and/or service. Contact sales@patton.com or +1 (301) 975-1000 for assistance.

Warranty Information

The software described in this document is furnished under a license and may be used or copied only in accordance with the terms of such license. For information about the license, see [Appendix F, "End user license agreement"](#) on page 57 or go to www.patton.com.

Patton Electronics warrants all SmartNode router components to be free from defects, and will—at our option—repair or replace the product should it fail within one year from the first date of the shipment.

This warranty is limited to defects in workmanship or materials, and does not cover customer damage, abuse or unauthorized modification. If the product fails to perform as warranted, your sole recourse shall be repair or replacement as described above. Under no condition shall Patton Electronics be liable for any damages incurred by the use of this product. These damages include, but are not limited to, the following: lost profits, lost savings and incidental or consequential damages arising from the use of or inability to use this product. Patton Electronics specifically disclaims all other warranties, expressed or implied, and the installation or use of this product shall be deemed an acceptance of these terms by the user.

Summary Table of Contents

- 1 General information 13
- 2 Applications overview..... 19
- 3 SmartNode installation..... 23
- 4 Initial configuration 28
- 5 Contacting Patton for assistance 37
- A Compliance information 40
- B Specifications 43
- C Cabling 48
- D Port pin-outs 52
- E SmartNode 4630 factory configuration 55
- F End user license agreement 57

Table of Contents

Summary Table of Contents	3
Table of Contents	4
List of Figures	7
List of Tables	8
About this guide	9
Audience.....	9
Structure.....	9
Precautions	10
Safety when working with electricity	10
General observations	11
Typographical conventions used in this document.....	11
General conventions	11
1 General information.....	13
SmartNode 4630 overview	14
SmartNode 4630 rear panel	15
SmartNode 4630 front panel	17
2 Applications overview.....	19
Introduction	20
Application—Edge intelligence of enterprise communication.....	20
Application—Multi-service ISDN Internet telephony IAD	21
3 SmartNode installation.....	23
Planning the installation	24
Site log	24
Network information	24
Network Diagram	24
IP related information	24
Software tools	25
Power source	25
Location and mounting requirements	25
Installing the gateway router.....	25
Placing the SmartNode	25
Installing cables	25
Connecting ISDN terminals and NT to the SmartNode’s ISDN BRI ports	26
Connecting the 10/100Base-T Ethernet LAN and WAN cables	26
Connecting the power supply	27
Internal S-Bus power supply	27
4 Initial configuration.....	28
Introduction	29
1. Connecting the SmartNode to your laptop PC.....	29

2. Configuring the desired IP address	30
Factory-default IP settings	30
Login	30
Changing the WAN IP address	30
3. Connecting the SmartNode to the network	31
4. Loading the configuration (optional)	32
Bootloader	33
Start Bootloader	33
Start-up with factory configuration	33
Load a new application image (SmartWare) via TFTP	33
Load a new application image (SmartWare) via the serial link	35
Additional information	36
5 Contacting Patton for assistance	37
Introduction	38
Contact information	38
Patton support headquarters in the USA	38
Alternate Patton support for Europe, Middle East, and Africa (EMEA)	38
Warranty Service and Returned Merchandise Authorizations (RMAs)	38
Warranty coverage	38
Out-of-warranty service	39
Returns for credit	39
Return for credit policy	39
RMA numbers	39
Shipping instructions	39
A Compliance information	40
Compliance	41
EMC	41
Safety	41
PSTN Regulatory	41
Radio and TV Interference	41
CE Declaration of Conformity	41
ISDN compliance	42
B Specifications	43
DSP	44
Voice connectivity	44
Data connectivity	44
Voice processing (signalling dependent)	44
Fax and modem support	45
Voice signalling	45
Voice routing—session router	45
IP services	46
Management	46
System	46

Physical	46
Identification of the SmartNode devices via SNMP.....	47
C Cabling	48
Introduction	49
Console	49
Ethernet	50
ISDN BRI	51
D Port pin-outs	52
Introduction	53
Console port.....	53
Ethernet	53
ISDN BRI 0/0 (NT/Net or TE/User) port.....	53
ISDN BRI 0/1 .. 0/3 (TE/Usr or NT/Net).....	54
E SmartNode 4630 factory configuration	55
Introduction	56
F End user license agreement	57
End User License Agreement	58
1. Definitions	58
2. Title	58
3. Term	58
4. Grant of License	58
5. Warranty	58
6. Termination	59
7. Other licenses	59

List of Figures

1	SmartNode 4630	14
2	SN4630 rear panel	15
3	SmartNode 4630 front panel	17
4	Edge intelligence of enterprise communication application	20
5	Internet telephony IAD application	21
6	Power LED (SmartNode 4638 shown)	27
7	Connecting the SmartNode to your laptop PC	29
8	Connecting the SmartNode to the network	31
9	Connecting a serial terminal	49
10	Typical Ethernet straight-through cable diagram	50
11	Connecting an ISDN device	51
12	EIA-561 (RJ-45 8-pin) port	53

List of Tables

1	General conventions	11
2	Rear panel ports	15
3	SmartNode 4630 LED definitions	17
4	Sample site log entries	24
5	Factory default IP address and network mask configuration	30
6	SmartNode Models and their Unique sysObjectID	47
7	RJ-45 socket	53
8	RJ-45 socket	53
9	RJ-45 socket	54

About this guide

This guide describes the SmartNode 4630 hardware, installation and basic configuration. For detailed software configuration information refer to the *SmartWare Software Configuration Guide* and the available Configuration Notes.

Audience

This guide is intended for the following users:

- Operators
- Installers
- Maintenance technicians

Structure

This guide contains the following chapters and appendices:

- [Chapter 1](#) on page 13 provides information about router features and capabilities
- [Chapter 2](#) on page 19 contains an overview describing router operation and applications
- [Chapter 3](#) on page 23 provides hardware installation procedures
- [Chapter 4](#) on page 28 provides quick-start procedures for configuring the SmartNode router
- [Chapter 5](#) on page 37 contains information on contacting Patton technical support for assistance
- [Appendix A](#) on page 40 contains compliance information for the router
- [Appendix B](#) on page 43 contains specifications for the routers
- [Appendix C](#) on page 48 provides cable recommendations
- [Appendix D](#) on page 52 describes the router's ports and pin-outs
- [Appendix E](#) on page 55 lists the factory configuration settings for SmartNode 4630
- [Appendix F](#) on page 57 provides license information that describes acceptable usage of the software provided with the SmartNode 4630

For best results, read the contents of this guide *before* you install the router.

Precautions

Notes, cautions, and warnings, which have the following meanings, are used throughout this guide to help you become aware of potential problems. **Warnings** are intended to prevent safety hazards that could result in personal injury. **Cautions** are intended to prevent situations that could result in property damage or impaired functioning.

Note A note presents additional information or interesting sidelights.



IMPORTANT

The alert symbol and IMPORTANT heading calls attention to important information.



CAUTION

The alert symbol and CAUTION heading indicate a potential hazard. Strictly follow the instructions to avoid property damage.



CAUTION

The shock hazard symbol and CAUTION heading indicate a potential electric shock hazard. Strictly follow the instructions to avoid property damage caused by electric shock.



WARNING

The alert symbol and WARNING heading indicate a potential safety hazard. Strictly follow the warning instructions to avoid personal injury.



WARNING

The shock hazard symbol and WARNING heading indicate a potential electric shock hazard. Strictly follow the warning instructions to avoid injury caused by electric shock.

Safety when working with electricity



WARNING

This device contains no user serviceable parts. The equipment shall be returned to Patton Electronics for repairs, or repaired by qualified service personnel.



WARNING

Ensure that the power cable shipped with this device meets all applicable standards for the country in which it is to be installed. If it is not, refer to chapter Chapter 5, “[Contacting Patton for assistance](#)” on page 37 for help in replacing it with a compliant cable.



Mains Voltage: Do not open the case the power cord is attached. Disconnect the power supply cord before servicing. For systems without a power switch, line voltages are present within the power supply when the power cords are connected. The wall outlet that is utilized to power the SmartNode router shall be within 10 feet (3 meters) of the device, shall be easily accessible, grounded, and protected by a circuit breaker.



Hazardous network voltages are present in WAN ports regardless of whether power to the SmartNode is ON or OFF. To avoid electric shock, use caution when near WAN ports. When detaching cables, detach the end away from the SmartNode first.



Do not work on the system or connect or disconnect cables during periods of lightning activity.



In accordance with the requirements of council directive 2002/96/EC on Waste of Electrical and Electronic Equipment (WEEE), ensure that at end-of-life you separate this product from other waste and scrap and deliver to the WEEE collection system in your country for recycling.

General observations

- Clean the case with a soft slightly moist anti-static cloth
- Place the unit on a flat surface and ensure free air circulation
- Avoid exposing the unit to direct sunlight and other heat sources
- Protect the unit from moisture, vapors, and corrosive liquids

Typographical conventions used in this document

This section describes the typographical conventions and terms used in this guide.

General conventions

The procedures described in this manual use the following text conventions:

Table 1. General conventions

Convention	Meaning
Garamond blue type	Indicates a cross-reference hyperlink that points to a figure, graphic, table, or section heading. Clicking on the hyperlink jumps you to the reference. When you have finished reviewing the reference, click on the Go to Previous View button  in the Adobe® Acrobat® Reader toolbar to return to your starting point.
Futura bold type	Commands and keywords are in boldface font.
Futura bold-italic type	Parts of commands, which are related to elements already named by the user, are in boldface italic font.

Table 1. General conventions

Convention	Meaning
<i>Italicized Futura type</i>	Variables for which you supply values are in <i>italic</i> font
Futura type	Indicates the names of fields or windows.
Garamond bold type	Indicates the names of command buttons that execute an action.
< >	Angle brackets indicate function and keyboard keys, such as <SHIFT>, <CTRL>, <C>, and so on.
[]	Elements in square brackets are optional.
{a b c}	Alternative but required keywords are grouped in braces ({ }) and are separated by vertical bars ()
screen	Terminal sessions and information the system displays are in <i>screen font</i> .
node	The leading IP address or nodename of a SmartNode is substituted with node in boldface italic font.
SN	The leading SN on a command line represents the nodename of the SmartNode
#	An hash sign at the beginning of a line indicates a comment line.

Chapter 1 **General information**

Chapter contents

SmartNode 4630 overview	14
SmartNode 4630 rear panel	15
SmartNode 4630 front panel	17

SmartNode 4630 overview

The SmartNode 4630 ISDN S0 VoIP Gateway-Router (see [figure 1](#)) combines IP routing, VPN/Security, and Quality of Service with high-quality Voice over IP (VoIP) delivered on five ISDN S0 (S/T) Basic Rate Interface (BRI). This combination allows you to leverage low-cost Internet Telephony on existing ISDN Phones and PBX equipment for complete SoHo and branch office voice and data connectivity.



Figure 1. SmartNode 4630

The SmartNode 4630 series consists of two models: the SN4634 and SN4638. Both models come equipped with two 10/100Base-T Ethernet ports.

The SmartNode 4638 Gateway-Router performs the following major functions:

- Eight channels of Voice over IP and local voice switching via 5 ISDN BRI S0 ports. Each port can be switched between NT and TE per software. One port can be used a clock source.
- For each ISDN S0 port in NT mode a Phantom power supply can be switched on. The total delivered power is 4W.
- A fallback cut-through relay between ISDN BRI ports 0/0 and 0/1 electrically connects the NT and TE port in case of power failure and enables life-line calls to the public ISDN network (PSTN-supplied ISDN line must be used).
- Standard compliant VoIP in accordance with SIP or H.323 protocols.
- Internet access and IP Routing with IP Quality of Service (QoS) support for mixed voice and data traffic.

The SN4634 is the same as the SN4638 except that it supports 3 ISDN BRI S0 ports and 4 VoIP channels.

SmartNode 4630 rear panel

The SmartNode 4630 is a compact VoIP Gateway Router that supports eight VoIP calls on five ISDN BRI ports (see [figure 2](#)). The SmartNode 4630 rear panel ports are described in [table 2](#).

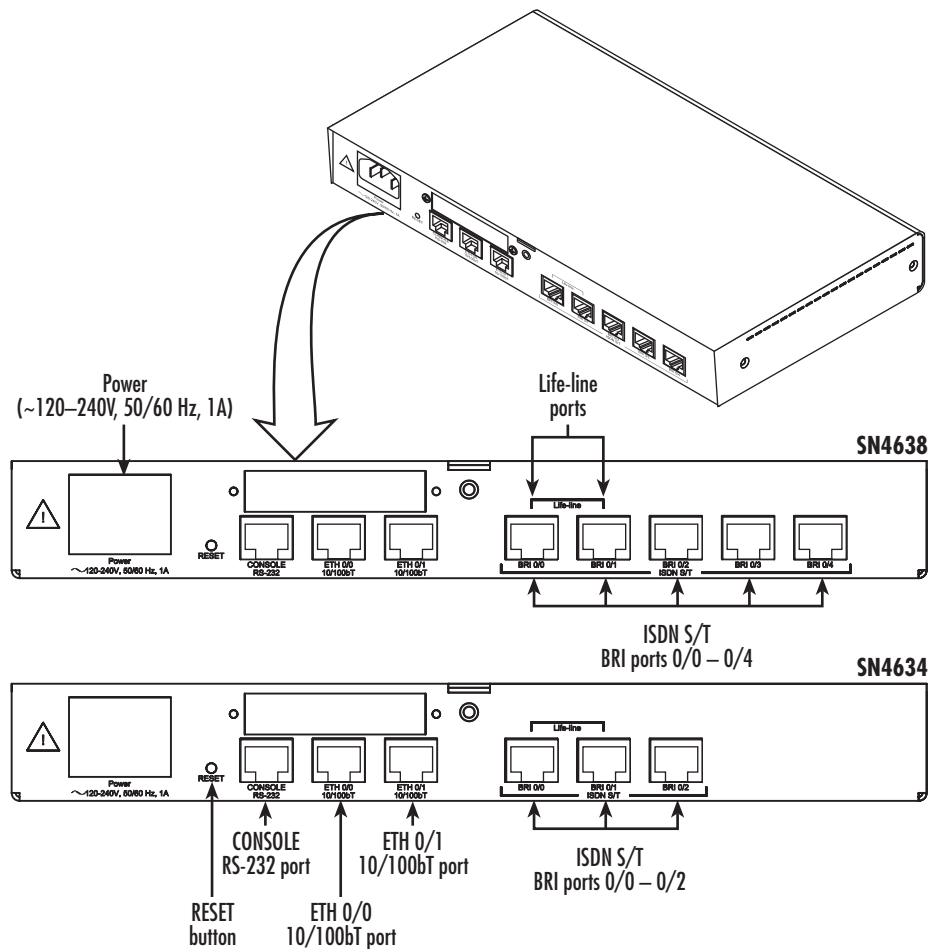

Figure 2. SN4630 rear panel

Table 2. Rear panel ports

Port	Description
WAN ETH 0/0	Auto-MDX Fast-Ethernet port, RJ-45 (see figure 2), connects the unit to an Ethernet WAN device (for example, a cable modem, DSL modem, or fiber modem).
LAN ETH 0/1	Auto-MDX Fast-Ethernet port, RJ-45 (see figure 2), connect the unit to an Ethernet LAN (for example, a PC, printer, or wireless bridge).
BRI 0/0	ISDN BRI TE/NT port, RJ-45 socket S0 (S/T) interface (see figure 2), connects the SmartNode with an ISDN device over an S/T bus, e.g. a PBX or an NT. The interface may be used as fallback if connected to an NT. The port can be switched between TE and NT mode. The interface is internally terminated with 100 Ohm. Point-to-point or point-to-multipoint configurable. If the port is in NT mode a phantom power supply can be switched on to supply connected phones with power.

Table 2. Rear panel ports (Continued)

Port	Description
BRI 0/1	ISDN BRI NT/TE port, RJ-45 socket S0 (S/T) interface (see figure 2), connects the SmartNode with an ISDN device over an S/T bus, e.g. a PBX or an NT. The interface may be used as fallback if connected to an NT. The port can be switched between TE and NT mode. The interface is internally terminated with 100 Ohm. Point-to-point or point-to-multipoint configurable. If the port is in NT mode a phantom power supply can be switched on to supply connected phones with power.
BRI 0/2	ISDN BRI NT/TE port, RJ-45 socket S0 (S/T) interface (see figure 2), connects the SmartNode with an ISDN device over an S/T bus, e.g. a PBX or an NT. The port can be switched between TE and NT mode. The interface is internally terminated with 100 Ohm. Point-to-point or point-to-multipoint configurable. If the port is in NT mode a phantom power supply can be switched on to supply connected phones with power.
BRI 0/3 (SN4638 only)	ISDN BRI NT/TE port, RJ-45 socket S0 (S/T) interface (see figure 2), connects the SmartNode with an ISDN device over an S/T bus, e.g. a PBX or an NT. The port can be switched between TE and NT mode. The interface is internally terminated with 100 Ohm. Point-to-point or point-to-multipoint configurable. If the port is in NT mode a phantom power supply can be switched on to supply connected phones with power.
BRI 0/4 (SN4638 only)	ISDN BRI NT/TE port, RJ-45 socket S0 (S/T) interface (see figure 2), connects the SmartNode with an ISDN device over an S/T bus, e.g. a PBX or an NT. The port can be switched between TE and NT mode. The interface is internally terminated with 100 Ohm. Point-to-point or point-to-multipoint configurable. If the port is in NT mode a phantom power supply can be switched on to supply connected phones with power.
Console	Used for service and maintenance, the Console port (see figure 2), an RS-232 RJ-45 connector, connects the product to a serial terminal such as a PC or ASCII terminal (also called a dumb terminal). (9600 bps, 8 bits, no parity, 1 stop bit, no flow control).
100-240 VAC 50-60 Hz	Electricity supply socket for mains power cable. (see figure 2).
Reset	The reset button (see figure 2) has three functions: <ul style="list-style-type: none"> • Restart the unit with the current startup configuration—Press (for less than 1 second) and release the <i>Reset</i> button to restart the unit with the current startup configuration. • Restart the unit with factory default configuration—Press the <i>Reset</i> button for 5 seconds until the <i>Power</i> LED (see figure 3 on page 17) starts blinking to restart the unit with factory default configuration. • Restart the unit in bootloader mode (to be used only by trained SmartNode technicians)—Starting with the unit powered off, press and hold the <i>Reset</i> button as you apply power to the unit. Release the <i>Reset</i> button when the <i>Power</i> LED starts blinking so the unit will enter bootloader mode.

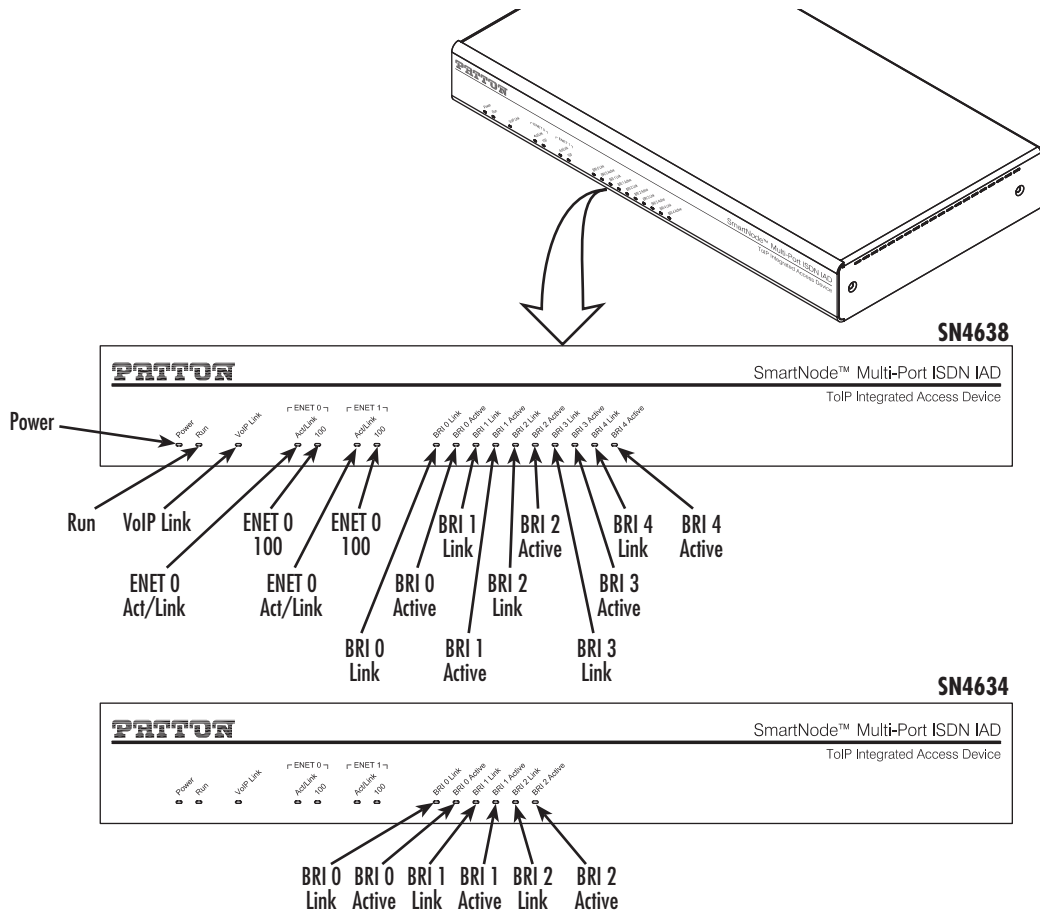

Figure 3. SmartNode 4630 front panel

SmartNode 4630 front panel

Figure 3 shows SmartNode 4630 LEDs, the LED definitions are listed in [table 3](#).

Table 3. SmartNode 4630 LED definitions

LED	Description
Note	If an error occurs, all LEDs will flash once per second.
Power	When lit, indicates power is applied.
Run	When lit, the unit is in normal operation. Flashes once per second during boot (startup).

Table 3. SmartNode 4630 LED definitions (Continued)

LED	Description
VoIP Link	<ul style="list-style-type: none"> • On indicates the gateway is registered to an H.323 gatekeeper/SIP server, or, in the case of direct routing, has at least one active VoIP connection. • Off indicates the unit is not configured or registered, or has no active direct-routed VoIP connection. • Flashing green indicates that the unit is attempting to register or has failed to register.
BRI Link/Sig	On when L1 and L2 are active. Flash to follow signaling activity on D-Channel.
BRI B1/B2	Off indicates no active calls. Blinking when one or two B-channels are connected.
Ethernet Link	<ul style="list-style-type: none"> • On when the Ethernet connection on the corresponding port has a link indication. • Flashes when data is received or transmitted at the corresponding Ethernet port.
Ethernet 100M	<ul style="list-style-type: none"> • On when the Ethernet is connected to a 100Mb network • Off when the Ethernet is connected to a 10Mb network.

Chapter 2 **Applications overview**

Chapter contents

Introduction	20
Application—Edge intelligence of enterprise communication	20
Application—Multi-service ISDN Internet telephony IAD	21

Introduction

Patton's SmartNode VoIP Media Gateway Routers deliver the features you need for advanced multiservice voice and data network applications. They combine high quality voice-over-IP with powerful *quality of service* routing functions to build professional and reliable VoIP and data networks. This chapter describes typical applications for which this SmartNode is uniquely suited.

Note Detailed configuration information for the applications can be found on the CD-ROM that was included with your SmartNode device or online from the Patton webserver at www.patton.com.

Application—Edge intelligence of enterprise communication

Enterprises are excited about voice over IP and convergence for the following reasons:

- Bypassing the PSTN. Using Internet telephony service providers (ITSPs) instead of incumbent carriers dramatically reduces telephony costs
- IP PBXs, with their full suite of features and ease of integration into existing IT environments are very appealing
- Convergence lowers technology ownership costs and enables enterprises to deploy new integrated applications

However, there are several concerns about migrating the whole telephony infrastructure to VoIP:

- Loss of voice quality
- Unknown reliability
- Lack of experience/expertise in voice over IP

Patton's SmartNode series of VoIP gateways address these concerns enabling enterprises to safely migrate to VoIP. SmartNodes enable system administrators to gradually introduce VoIP, using it as the edge communication device for all worlds, connecting PSTN, legacy PBX, ITSPs and an IP PBX.

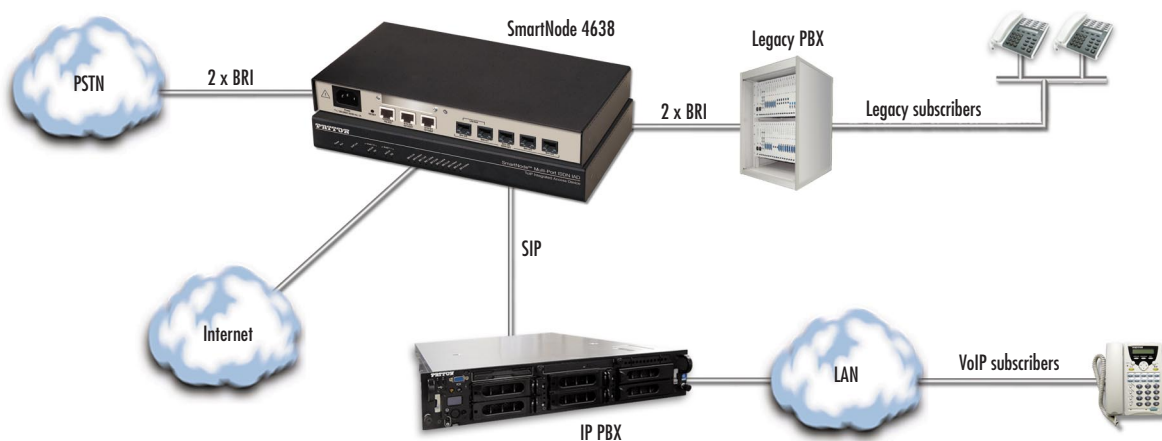

Figure 4. Edge intelligence of enterprise communication application

How it works:

1. Connect the SmartNode to the PSTN and legacy PBX, and configure the call router to pass all calls from the PBX to the PSTN and vice versa. This first step will not affect any uses in the enterprise
2. Choose your ITSPs, and configure as many on the SmartNode as you need. Use the intelligent call router in the SmartNode to decide which call is forwarded to which ITSP, and which calls should go to the PSTN. This may be based upon least-cost routing criteria, or for example, on calling party number. The latter is ideal if you want to test calls to an ITSP before enabling it for all users within the enterprise.
3. Voice over IP can be switched off instantly on one single box (the SmartNode) to revert the system back to as it was before.
4. Build up an IP PBX system that uses the SmartNode as PSTN gateway. For all calls from this IP PBX, you can direct them to the PSTN or to ITSPs. Numbering plan adaptations are handled through regular expression matching by the SmartNode. No need to change anything on the PBXs.
5. Once the IP PBX is ready, you can choose on incoming calls from the PSTN, for each extension whether this extension is to be directed to the IP PBX or on the legacy PBX.

Application—Multi-service ISDN Internet telephony IAD

The SmartNode 4630 Series can be used to make and receive calls to and from the public ISDN network and Internet Telephony services on any ISDN Terminal (Phone or PBX) (see figure 5). Using individually configurable routing tables, an outbound call can be directed to the local PSTN connection or to an Internet telephony service provider (ISTP). Inbound calls from the Internet and the PSTN can ring the same phone.

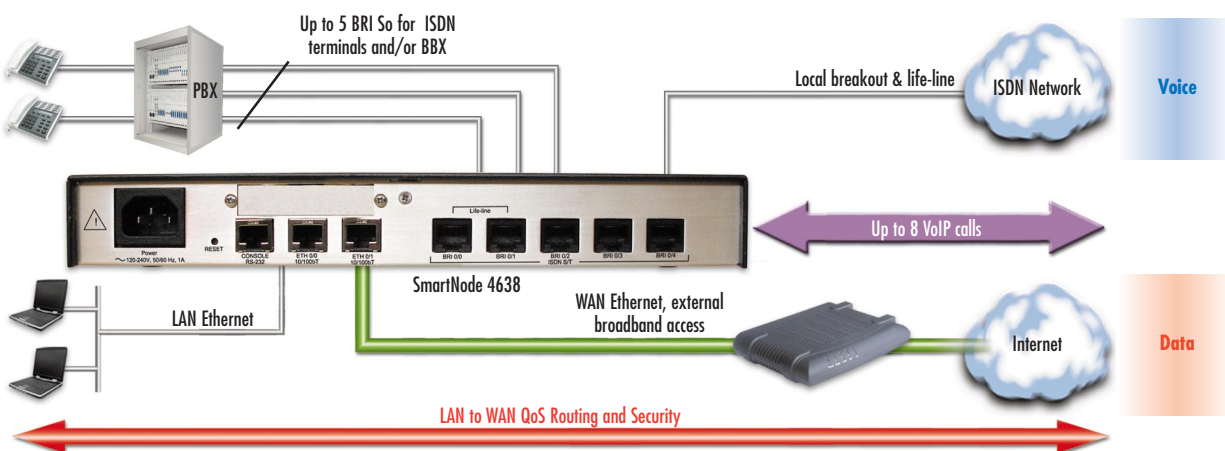

Figure 5. Internet telephony IAD application

Broadband network connectivity integrates with any fixed IP, DHCP or PPPoE service. An integrated 10/100 Ethernet LAN port, with advanced routing features such as NAT, Firewall/ACL, DynDNS as well as optional IPSec VPN, fulfills the requirements of demanding network users.

Quality of Service (QoS) features complete the offering with advanced voice prioritization and traffic management. Patton's patent-pending DownStreamQoS™ ensures voice without interruptions even over best-effort Internet connections.

Chapter 3 **SmartNode installation**

Chapter contents

Planning the installation	23
Site log	23
Network information	23
Network Diagram	23
IP related information	23
Software tools	24
Power source	24
Location and mounting requirements	24
Installing the gateway router	24
Placing the SmartNode	24
Installing cables	24
Connecting ISDN terminals and NT to the SmartNode's ISDN BRI ports	25
Connecting the 10/100Base-T Ethernet LAN and WAN cables	25
Connecting the power supply	26
Internal S-Bus power supply	26

Planning the installation

Before installing the gateway router device, the following tasks should be completed:

- **Create a network diagram** (see section “[Network information](#)” on page 24)
- **Gather IP related information** (see section “[IP related information](#)” on page 24 for more information)
- **Install the hardware and software needed to configure the SmartNode.** (See section “[Software tools](#)” on page 25)
- **Verify power source reliability** (see section “[Power source](#)” on page 25).

After you have finished preparing for gateway router installation, go to section “[Installing the gateway router](#)” on page 25 to install the device.

Site log

Patton recommends that you maintain a site log to record all actions relevant to the system, if you do not already keep such a log. Site log entries should include information such as listed in [table 4](#).

Table 4. Sample site log entries

Entry	Description
Installation	Make a copy of the installation checklist and insert it into the site log
Upgrades and maintenance	Use the site log to record ongoing maintenance and expansion history
Configuration changes	Record all changes and the reasons for them
Maintenance	Schedules, requirements, and procedures performed
Comments	Notes, and problems
Software	Changes and updates to SmartWare software

Network information

Network connection considerations that you should take into account for planning are provided for several types of network interfaces are described in the following sections.

Network Diagram

Draw a network overview diagram that displays all neighboring IP nodes, connected elements and telephony components.

IP related information

Before you can set up the basic IP connectivity for your SmartNode 4630 you should have the following information:

- IP addresses used for Ethernet LAN and WAN ports
- Subnet mask used for Ethernet LAN and WAN ports

- IP addresses of central H.323 gatekeeper (if used)
- IP addresses and/or URL of SIP servers or Internet telephony services (if used)
- Login and password for PPPoE Access
- Login and password for SIP or H.323 based telephony services
- IP addresses of central TFTP server used for configuration upload and download (optional)

Software tools

You will need a PC (or equivalent) with Windows Telnet or a program such as *Tera Term Pro Web* (included on the SmartNode CD-ROM) to configure the software on your SmartNode router.

Power source

If you suspect that your AC power is not reliable, for example if room lights flicker often or there is machinery with large motors nearby, have a qualified professional test the power. Patton recommends that you include an uninterruptible power supply (UPS) in the installation to ensure that VoIP service is not impaired if the power fails.

Location and mounting requirements

The SmartNode router is intended to be placed on a desktop or similar sturdy, flat surface that offers easy access to the cables. Allow sufficient space at the rear of the chassis for cable connections. Additionally, you should consider the need to access the unit for future upgrades and maintenance.

Installing the gateway router

SmartNode hardware installation consists of the following:

- Placing the device at the desired installation location (see section “Placing the SmartNode” on page 25)
- Connecting the interface and power cables (see section “Installing cables”)

When you finish installing the SmartNode, go to chapter 4, “Initial configuration” on page 28.

Placing the SmartNode

Place the unit on a desktop or similar sturdy, flat surface that offers easy access to the cables. The unit should be installed in a dry environment with sufficient space to allow air circulation for cooling.

Note For proper ventilation, leave at least 2 inches (5 cm) to the left, right, front, and rear of the unit.

Installing cables



Do not work on the system or connect or disconnect cables during periods of lightning activity.

Connect the cables in the following order:



The interconnecting cables shall be acceptable for external use and shall be rated for the proper application with respect to voltage, current, anticipated temperature, flammability, and mechanical serviceability.

1. Connect the ISDN terminals and NT to the BRI ports (see section “[Connecting ISDN terminals and NT to the SmartNode’s ISDN BRI ports](#)”).
2. Connect the 10/100Base-T Ethernet LAN and WAN (see section “[Connecting the 10/100Base-T Ethernet LAN and WAN cables](#)” on page 26)
3. Connect the power mains cable (see section “[Connecting the power supply](#)” on page 27)

Connecting ISDN terminals and NT to the SmartNode’s ISDN BRI ports

The SmartNode comes with five ISDN BRI ports located on the rear panel (see [figure 2](#) on page 15). All ports can be connected to the PSTN (ISDN NT) or terminals.



When this device is used in North America, it shall be connected to a Network Termination Device and not connected directly to an outside POTS line.

Note We recommend connecting the PSTN to *BRI 0/0* and a terminal to *BRI 0/1* to benefit from the lifeline function.

For details on the BRI port pinout and ISDN cables, refer to [Appendix C, “Cabling”](#) on page 48 and [Appendix D, “Port pin-outs”](#) on page 52.

Connecting the 10/100Base-T Ethernet LAN and WAN cables

The SmartNode 4630 has automatic MDX (auto-crossover) detection and configuration on all Ethernet ports. Any of the ports can be connected to a host or hub/switch with a straight-through wired cable.

1. Connect to the subscriber port of the broadband access modem (DSL, cable, WLL) to *ETH 0/0*.
2. Connect port *ETH 0/1* to your LAN.

For details on the Ethernet port pinout and cables, refer to [Appendix C, “Cabling”](#) on page 48 and [Appendix D, “Port pin-outs”](#) on page 52.

Connecting the power supply

Do the following to connect the main power to the Model 4630:

Note *Do not connect the power cord to the AC power outlet at this time.*

1. Insert the female end of the AC power to the mains port (see [figure 2](#) on page 15).



The internal power supply automatically adjusts to accept an input voltage from 100 to 240 VAC (50/60 Hz).

Verify that the proper voltage is present before plugging the power cord into the receptacle. Failure to do so could result in equipment damage.

2. Verify that the AC power cord included with your router is compatible with local standards. If it is not, refer to [“Contacting Patton for assistance”](#) on page 37 to find out how to replace it with a compatible power cord.
3. Connect the male end of the AC power cord to an appropriate AC power outlet.

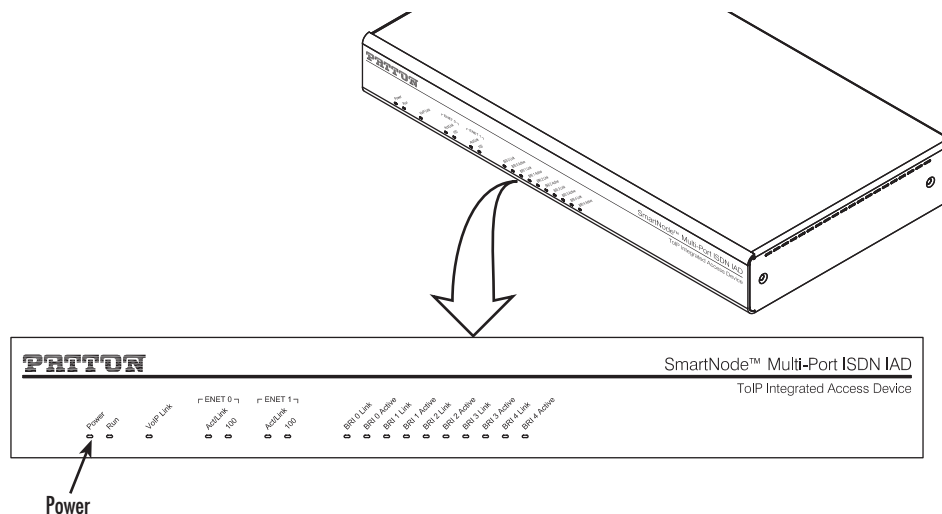

Figure 6. Power LED (SmartNode 4638 shown)

4. Verify that the green *Power* LED is lit (see [figure 6](#)).

Internal S-Bus power supply

The Model 4630 supplies S-Bus line power on the BRI ports that can be activated individually for each port. If a port is switched to TE mode, line power is switched off. A total of 4W are available.

Congratulations, you have finished installing the SmartNode Gateway Router! Now go to chapter 4, [“Initial configuration”](#) on page 28.

Chapter 4 **Initial configuration**

Chapter contents

Introduction	32
1. Connecting the SmartNode to your laptop PC.....	32
2. Configuring the desired IP address	33
Factory-default IP settings	33
Login	33
Changing the WAN IP address	33
3. Connecting the SmartNode to the network.....	34
4. Loading the configuration (optional).....	35
Bootloader.....	36
Start Bootloader	36
Start-up with factory configuration	37
Load a new application image (SmartWare) via TFTP	37
Load a new application image (SmartWare) via the serial link	39
Additional information.....	39

Introduction

This chapter leads you through the basic steps to set up a new SmartNode and to download a configuration. Setting up a new SmartNode consists of the following main steps:

Note If you haven't already installed the SmartNode, refer to chapter 3, "SmartNode installation" on page 23.

- Connecting the SmartNode to your laptop PC
- Configuring the desired IP address
- Connecting the SmartNode to the network
- Loading the configuration (optional)

Note The SmartNode CD-ROM contains a collection of third party software tools (including TFTP servers and Telnet utilities) to help you configure, operate and monitor the SmartNode device.

1. Connecting the SmartNode to your laptop PC

First the SmartNode must be connected to the mains power supply with the power cable. Wait until the *Power* LED stops blinking and stays lit constantly. Now the SmartNode is ready.



CAUTION

The interconnecting cables shall be acceptable for external use and shall be rated for the proper application with respect to voltage, current, anticipated temperature, flammability, and mechanical serviceability.



CAUTION

When this device is used in North America, it shall be connected to a Network Termination Device and not connected directly to an outside POTS line.

The SmartNode 4630 Series is equipped with Auto-MDX Ethernet ports, so you can use straight-through cables for host or hub/switch connections (see [figure 7](#)).

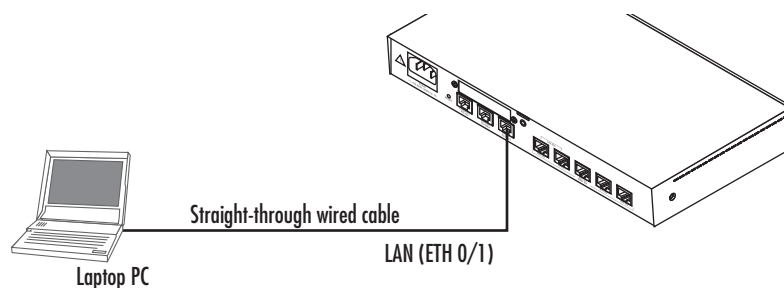

Figure 7. Connecting the SmartNode to your laptop PC

The SmartNode comes with a built-in DHCP server to simplify configuration. Therefore, to automatically configure the PC for IP connectivity to the SmartNode, the laptop PC must be configured for DHCP. The

SmartNode will provide the PC with an IP address. You can check the connection to the SmartNode by executing the ping command from the PC command window as follows:

```
ping 192.168.1.1
```

2. Configuring the desired IP address

Factory-default IP settings

The factory default configuration for the Ethernet interface IP addresses and network masks are listed in [table 5](#). Both Ethernet interfaces are activated upon power-up. LAN interface *ETH 0/1 (LAN)* provides a default DHCP server, the WAN interface uses DHCP client to automatically assign the IP address and network mask.

Table 5. Factory default IP address and network mask configuration

	IP Address	Network Mask
WAN interface Ethernet 0 (ETH 0/0)	DHCP	DHCP
LAN interface Ethernet 1 (ETH 0/1)	192.168.1.1	255.255.255.0
DHCP address range	192.168.1.10–192.168.1.19	255.255.255.0

If these addresses match with those of your network, go to section “[3. Connecting the SmartNode to the network](#)” on page 31. Otherwise, refer to the following sections to change the addresses and network masks.

Login

To access the SmartNode, start the Telnet application. Type the default IP address for the router into the address field: **192.168.1.1**. Accessing your SmartNode via a Telnet session displays the login screen. Type the factory default login: *administrator* and leave the password empty. Press the *Enter* key after the password prompt.

```
login:administrator
password: <Enter>
192.168.1.1>
```

After you have successfully logged in you are in the operator execution mode, indicated by > as command line prompt. With the commands *enable* and *configure* you enter the configuration mode.

```
192.168.1.1>enable
192.168.1.1#configure
192.168.1.1(cfg)#
```

Changing the WAN IP address

Select the context IP mode to configure an IP interface.

```
192.168.1.1(cfg)#context ip router
192.168.1.1(ctx-ip)[router]#
```

Now you can set your IP address and network mask for the interface *ETH 0/0* (*WAN*). Within this example a network 172.16.1.0/24 address is assumed. The IP address in this example is set to 172.16.1.99 (you should set this the IP address given to you by your network provider).

```
192.168.1.1(ctx-ip)[router]#interface eth0
192.168.1.1(if-ip)[eth0]#ipaddress 172.16.1.99 255.255.255.0
2002-10-29T00:09:40 : LOGINFO      : Link down on interface eth0.
2002-10-29T00:09:40 : LOGINFO      : Link up on interface eth0.
172.16.1.99(if-ip)[eth0]#
```

Copy this modified configuration to your new start-up configuration. This will store your changes in non-volatile memory. Upon the next start-up the system will initialize itself using the modified configuration.

```
172.16.1.99(if-ip)[eth0]#copy running-config startup-config
172.16.1.99(if-ip)[eth0]#
```

The SmartNode can now be connected to your network.

3. Connecting the SmartNode to the network

In general, the SmartNode will connect to the network via the *WAN* (*ETH 0/0*) port. This enables the SmartNode to offer routing services to the PC hosts on *LAN* (*ETH 0/1*) port. The SmartNode 4630 Series is equipped with Auto-MDX Ethernet ports, so you can use straight-through or crossover cables for host or hub/switch connections (see [figure 8](#)).



CAUTION

The interconnecting cables shall be acceptable for external use and shall be rated for the proper application with respect to voltage, current, anticipated temperature, flammability, and mechanical serviceability.



CAUTION

When this device is used in North America, it shall be connected to a Network Termination Device and not connected directly to an outside POTS line.

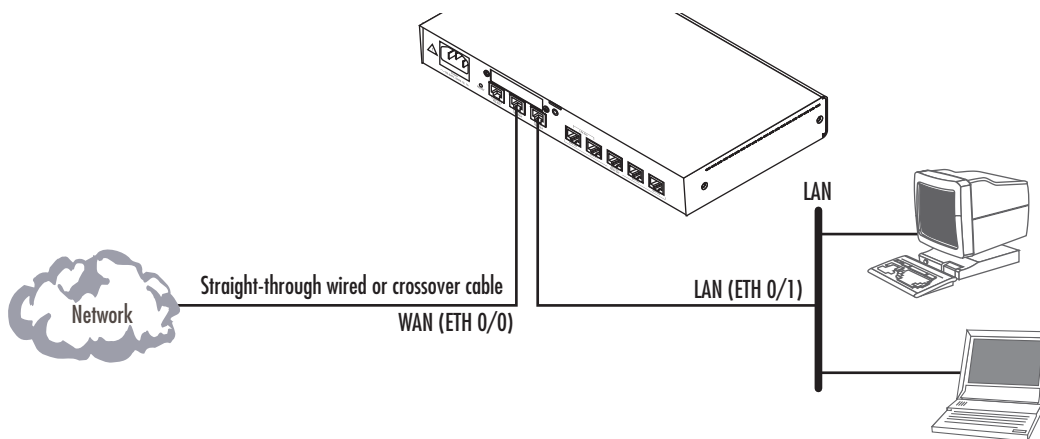

Figure 8. Connecting the SmartNode to the network

You can check the connection with the ping command from the SmartNode to another host on the network.

```
172.16.1.99(if-ip)[eth0]#ping <IP Address of the host>
```

Note If the WAN address is *not* set to DHCP, to ping a device outside your local LAN you must first configure the default gateway. (For information on configuring the default gateway, refer to section “Set IP addresses” in Appendix C, “Command Summary” of the *SmartNode Series SmartWare Software Configuration Guide*.)

4. Loading the configuration (optional)

Patton provides a collection of configuration templates on the CD-ROM that came with the SmartNode device—and also on the support page at www.patton.com/voip—one of which may be similar enough to your application that you can use it to speed up configuring the SmartNode. Simply download the configuration note that matches your application to your PC. Adapt the configuration as described in the configuration note to your network (remember to modify the IP address) and copy the modified configuration to a TFTP server. The SmartNode can now load its configuration from this server.

Note Patton regularly adds new configuration templates to the collection at www.patton.com/voip, so if you do not see your application on the CD-ROM, it may have been added to the website.

Note If your application is unique and not covered by any of Patton’s configuration templates, you can manually configure the SmartNode instead of loading a configuration file template. In that case, refer to the *SmartNode Series SmartWare Software Configuration Guide* for information on configuring the SmartNode device.

In this example we assume the TFTP server on the host with the IP address 172.16.1.11 and the configuration named *SN.cfg* in the root directory of the TFTP server.

```
172.16.1.99(if-ip)[eth0]#copy tftp://172.16.1.11/SN.cfg startup-config
Download...100%
172.16.1.99(if-ip)[eth0]#
```

After the SmartNode has been rebooted the new startup configuration will be activated.



IMPORTANT

When you issue the **reload** command, the SmartNode will ask if you want to copy the running configuration to the startup configuration. Since you just downloaded a configuration file to the startup configuration you must answer this question with **NO**. Otherwise, the downloaded configuration will be overwritten and lost!

```

172.16.1.99(if-ip)[eth0]#reload
Running configuration has been changed.
Do you want to copy the 'running-config' to the 'startup-config'?
Press 'yes' to store, 'no' to drop changes : no
Press 'yes' to restart, 'no' to cancel : yes
The system is going down

```

Bootloader

The bootloader ensures that basic operations, network access, and downloads are possible in case of interrupted or corrupted application image downloads. It offers console access to the Bootloader and the capability for downloading application images (e.g. SmartWare) via the serial link of the console.

Start Bootloader

To start the Bootloader, power on the SmartNode while pressing the reset button. Open a Telnet session to the SmartNode via one of the Ethernet interfaces, or open a CLI session via the console port (if available on the SmartNode). The login display will appear. Using the credentials admin / patton , log in to the SmartNode. The following prompt will be displayed:

```
RedBoot>
```

Type **help** to display an overview of the available commands.

Start-up with factory configuration

Step	Command	Purpose
1	RedBoot> fis load	Copies the SmartWare application image from the persistent memory (flash:) to the volatile memory (RAM) from where it will be executed.
2	RedBoot> go -s factory-config	Starts the SmartWare application telling it to use 'factory-config' as startup configuration. You can also start-up with any other configuration available in the persistent memory (nvram:) by providing its name instead of 'factory-config'.

Load a new application image (SmartWare) via TFTP

The following procedure downloads the application image (SmartWare) for the mainboard. See the note below on how to download the respective CLI description file.

Step	Command	Purpose
1 optional	RedBoot> ip_address - l <i>local_ip_address [/mask_len]</i>	Sets the IP address and subnet mask of the Ethernet interface 0/0 which shall be used to receive the new application image. <i>mask_len</i> is the length of the network address (or the number of 1's within the subnet mask). See Note below.
2 optional	RedBoot> ip_address -g gateway	Sets the IP address of the default gateway.

Step	Command	Purpose
3 optional	RedBoot> ping -h <i>tftp-server_ip_address</i>	Tests the connectivity to the TFTP server.
4	RedBoot> load -r -v -h <i>host</i> -b <i>base_address</i> <i>file_name</i>	Downloads an application image into the volatile memory (RAM) from where the SmartNode could directly execute it. <i>host</i> : IP address of the TFTP server <i>base_address</i> : memory location where to store the application image. Use the default address 0x1800100 <i>file_name</i> : path and name of the file on the TFTP server. Note: use the image file that contains the whole application, not the image parts.
5	RedBoot> fis delete -n 1	Deletes the first application image. Reply with 'y' to the confirmation request.
6	RedBoot> fis create	Stores the downloaded application image to the permanent memory (flash:). Reply with 'y' to the confirmation request.
7	RedBoot> fis list -l	Checks whether the image has been successfully stored, whether it is the desired Release and Build, and whether it is valid.
8	RedBoot> go	Starts the application image that was downloaded into the volatile memory (RAM).

Note With the Bootloader, only the Ethernet interface 0/0 is available. The Bootloader applies the IP address, subnet mask, and default gateway that were last configured by the Bootloader itself or by another application (e.g. SmartWare). If an application configured the Ethernet interface 0/0 to use DHCP, the Bootloader will also use DHCP to learn the interface configuration. It can receive and apply the IP address, subnet mask, default gateway, and default (TFTP) server (transmitted as basic DHCP information 'Next server IP address').

Note This procedure does not download the respective CLI description file. Download it after starting up SmartWare with the following command:
copy tftp://<tftp_server_address>/<server_path>/bl flash:

Example: Downloading and storing a new application image (SmartWare)

```
RedBoot> ip -l 172.16.40.98/19
RedBoot> ip -g 172.16.32.1
RedBoot> ping -h 172.16.32.100
Network PING - from 172.16.40.98 to 172.16.32.100
.....PING - received 10 of 10 expected

RedBoot> load -r -v -h 172.16.32.100 -b 0x1800100 /Sn4xxx/image.bin
Using default protocol (TFTP)
-
```

```
Raw file loaded 0x01800100-0x0199ca6b, 1689964 bytes, assumed entry at 0x01800100
```

```
RedBoot> fis delete -n 1
Delete image 1 - continue (y/n)? y
... Erase from 0x60030000-0x601cc974: .....
```

```
RedBoot> fis create
Use address 0x01800100, size 1684402 ? - continue (y/n)? y
... Erase from 0x60030000-0x601cb3ba: .....
```

```
... Program from 0x00011eec-0x00011ef4 at 0x60030000: .
... Program from 0x01800100-0x0199b4b2 at 0x60030008: .....
... Program from 0x00011eec-0x00011ef4 at 0x60030000: .
Image successfully written to flash
```

```
RedBoot> fis list -l
```

Id	Address	Length	State	Description
	Entry	Load Addr		Version
1	0x60030000 0x01800100	1693438	valid	SmartWare R2.10 BUILD28015 V2.10

```
RedBoot> go
Starting 'SmartWare R2.10 BUILD28015' at 0x01800100 via 0x01800100
```

Load a new application image (SmartWare) via the serial link

The Bootloader supports the 'X-Modem' and 'Y-Modem' protocols to download application images via the serial link of the console. Do the following to initiate the download:

Step	Command	Purpose
1	RedBoot> load -r -v -m { xmodem ymodem } -b base_address	Downloads an application image into the volatile memory (RAM) from where the SmartNode could directly execute it. 'xmodem' or 'ymodem': Specify the protocol to be used, X-Modem or Y-Modem <i>base_address</i> : memory location where to store the application image. Use the default address 0x1800100 Execute the above RedBoot command first, then start the transfer from the terminal program with the command 'Send file via X-Modem' (or similar).
5	RedBoot> fis delete -n 1	Deletes the first application image. Reply with 'y' to the confirmation request.
6	RedBoot> fis create	Stores the downloaded application image to the permanent memory (flash:). Reply with 'y' to the confirmation request.
7	RedBoot> fis list -l	Checks whether the image has been successfully stored, whether it is the desired Release and Build, and whether it is valid.
8	RedBoot> go	Starts the application image that was downloaded to the volatile memory (RAM).

Note This type of download takes about **25 minutes** since it uses a serial link at only 9600 bps.

Additional information

For detailed information about configuring and operating guidance, set up procedures, and troubleshooting, refer to the *SmartNode Series SmartWare Software Configuration Guide* on the CD-ROM.

Chapter 5 **Contacting Patton for assistance**

Chapter contents

- Introduction34
- Contact information34
 - Patton support headquarters in the USA34
 - Alternate Patton support for Europe, Middle East, and Africa (EMEA)34
- Warranty Service and Returned Merchandise Authorizations (RMAs)34
 - Warranty coverage34
 - Out-of-warranty service35
 - Returns for credit35
 - Return for credit policy35
 - RMA numbers35
 - Shipping instructions35

Introduction

This chapter contains the following information:

- “[Contact information](#)”—describes how to contact Patton technical support for assistance.
- “[Warranty Service and Returned Merchandise Authorizations \(RMAs\)](#)”—contains information about the warranty and obtaining a return merchandise authorization (RMA).

Contact information

Patton Electronics offers a wide array of free technical services. If you have questions about any of our other products we recommend you begin your search for answers by using our technical knowledge base. Here, we have gathered together many of the more commonly asked questions and compiled them into a searchable database to help you quickly solve your problems.

Patton support headquarters in the USA

- Online support: available at www.patton.com
- E-mail support: e-mail sent to support@patton.com will be answered within 1 business day
- Telephone support: standard telephone support is available five days a week—from 8:00 am to 5:00 pm EST (1300 to 2200 UTC/GMT)—by calling +1 (301) 975-1007
- Fax: +1 (253) 663-5693

Alternate Patton support for Europe, Middle East, and Africa (EMEA)

- Online support: available at www.patton-inalp.com
- E-mail support: e-mail sent to support@patton-inalp.com will be answered within 1 business day
- Telephone support: standard telephone support is available five days a week—from 8:00 am to 5:00 pm CET (0900 to 1800 UTC/GMT)—by calling +41 (0)31 985 25 55
- Fax: +41 (0)31 985 25 26

Warranty Service and Returned Merchandise Authorizations (RMAs)

Patton Electronics is an ISO-9001 certified manufacturer and our products are carefully tested before shipment. All of our products are backed by a comprehensive warranty program.

Note If you purchased your equipment from a Patton Electronics reseller, ask your reseller how you should proceed with warranty service. It is often more convenient for you to work with your local reseller to obtain a replacement. Patton services our products no matter how you acquired them.

Warranty coverage

Our products are under warranty to be free from defects, and we will, at our option, repair or replace the product should it fail within one year from the first date of shipment. Our warranty is limited to defects in workmanship or materials, and does not cover customer damage, lightning or power surge damage, abuse, or unauthorized modification.

Out-of-warranty service

Patton services what we sell, no matter how you acquired it, including malfunctioning products that are no longer under warranty. Our products have a flat fee for repairs. Units damaged by lightning or other catastrophes may require replacement.

Returns for credit

Customer satisfaction is important to us, therefore any product may be returned with authorization within 30 days from the shipment date for a full credit of the purchase price. If you have ordered the wrong equipment or you are dissatisfied in any way, please contact us to request an RMA number to accept your return. Patton is not responsible for equipment returned without a Return Authorization.

Return for credit policy

- Less than 30 days: No Charge. Your credit will be issued upon receipt and inspection of the equipment.
- 30 to 60 days: We will add a 20% restocking charge (crediting your account with 80% of the purchase price).
- Over 60 days: Products will be accepted for repairs only.

RMA numbers

RMA numbers are required for all product returns. You can obtain an RMA by doing one of the following:

- Completing a request on the RMA Request page in the *Support* section at **www.patton.com**
- By calling **+1 (301) 975-1007** and speaking to a Technical Support Engineer
- By sending an e-mail to **returns@patton.com**

All returned units must have the RMA number clearly visible on the outside of the shipping container. Please use the original packing material that the device came in or pack the unit securely to avoid damage during shipping.

Shipping instructions

The RMA number should be clearly visible on the address label. Our shipping address is as follows:

Patton Electronics Company

RMA#: xxxx

7622 Rickenbacker Dr.

Gaithersburg, MD 20879-4773 USA

Patton will ship the equipment back to you in the same manner you ship it to us. Patton will pay the return shipping costs.

Appendix A **Compliance information**

Chapter contents

Compliance	37
EMC	37
Safety	37
PSTN Regulatory	37
Radio and TV Interference	37
CE Declaration of Conformity	37
ISDN compliance.....	38

Compliance

EMC

- FCC Part 15, Class A
- EN55022, Class A
- EN55024

Safety

- UL 60950-1/CSA C22.2 N0. 60950-1
- IEC/EN60950-1
- AS/NZS 60950-1

PSTN Regulatory

- TBR3
- AS/ACIF S031

Radio and TV Interference

The SmartNode router generates and uses radio frequency energy, and if not installed and used properly—that is, in strict accordance with the manufacturer’s instructions—may cause interference to radio and television reception. The SmartNode router have been tested and found to comply with the limits for a Class A computing device in accordance with specifications in Subpart B of Part 15 of FCC rules, which are designed to provide reasonable protection from such interference in a commercial installation. However, there is no guarantee that interference will not occur in a particular installation. If the SmartNode router does cause interference to radio or television reception, which can be determined by disconnecting the unit, the user is encouraged to try to correct the interference by one or more of the following measures: moving the computing equipment away from the receiver, re-orienting the receiving antenna and/or plugging the receiving equipment into a different AC outlet (such that the computing equipment and receiver are on different branches).

CE Declaration of Conformity

This equipment conforms to the requirements of Council Directive 1999/5/EC on the approximation of the laws of the member states relating to Radio and Telecommunication Terminal Equipment and the mutual recognition of their conformity.

The safety advice in the documentation accompanying this product shall be obeyed. The conformity to the above directive is indicated by CE sign on the device.

The signed Declaration of Conformity can be downloaded at www.patton.com/certifications.

ISDN compliance

The device is approved for connection to the public ISDN telecommunication network.



When this device is used in North America, it shall be connected to a Network Termination Device and not connected directly to an outside POTS line.

Appendix B **Specifications**

Chapter contents

DSP.....	44
Voice connectivity	44
Data connectivity	44
Voice processing (signalling dependent).....	44
Fax and modem support.....	45
Voice signalling	45
Voice routing—session router.....	45
IP services	46
Management	46
System	46
Physical	46
Identification of the SmartNode devices via SNMP.....	47

Note Refer to the software feature matrix for the most up-to-date specifications.

DSP

One or two 4-channel DSP

Voice connectivity

3 or 5 ISDN BRI S0 (S/T), 4-wire RJ45 ports

NT/TE configurable per port

Point-to-point, point-to-multipoint configurable

Life-line bypass relay between *BRI 0/0* and *BRI 0/1* ports

ISDN line power can be switched on per software per port

Data connectivity

Two 10/100Base-TX Ethernet ports

All ports full duplex, autosensing, auto-MDX

Voice processing (signalling dependent)

Four or eight full-duplex channels with Voice CODECS:

- G.711 A-Law/ μ -Law (64 kbps)
- G.726 (ADPCM 16, 24, 32, 40 kbps)
- G.723.1 (5.3 or 6.3 kbps)
- G.729ab (8 kbps)
- Transparent ISDN data

G.168 echo cancellation (25 ms)

Four or eight simultaneous low-bandwidth voice or T.38 fax calls

DTMF detection and generation

Carrier tone detection and generation

Silence suppression and comfort noise

Adaptive and configurable dejitter buffer

Configurable tones (dial, ringing, busy)

Configurable transmit packet length

RTP/RTCP (RFC 1889)

Fax and modem support

Automatic fax and modem detection

Codec fallback for modem-bypass

T.38 Fax-Relay (Gr. 3 Fax, 9.6 k, 14.4 k)

G.711 Fax-Bypass

Voice signalling

SIPv2

H.323v4

MGCP/IUA

SIP call transfer, redirect

Overlap or en-bloc dialing

DTMF in-band, out-of-band

Configurable progress tones

Voice routing—session router

Local switching (hairpinning)

Least cost routing

Interface huntgroups

Call-Distribution groups

Number blocking

Call Routing Criteria:

- Interface
- Calling/called party number
- Time of day, day of week, date
- ISDN bearer capability
- Various other information elements (IEs) of the ISDN setup
- Wildcard and regular expression matching

Regular expression number manipulation functions:

- Replace numbers
- Add/remove digits
- Pattern matching and replacement

IP services

IPv4 router; RIPv1, v2 (RFC 1058 and 2453)

Programmable static routes

ICMP redirect (RFC 792); Packet fragmentation

DiffServe/ToS set or queue per header bits

Pocket Policing discards excess traffic

802.1p VLAN tagging

IPSEC AH & ESP Modes

Manual Key; IKE optional

AES/DES/3DES Encryption

Note To use the IPsec VPN capabilities including AES/DES/3DES encryption with the SmartNode 4630, you may need to purchase additional license keys.

Management

Web-based GUI

Industry standard CLI with local console (RJ-45, RJ-232, 9600 bps, 8, N, 1) and remote Telnet access, fully documented

HTTP web management and firmware loading

TFTP configuration & firmware loading

SNMP v1 agent (MIB II and private MIB)

Built-in diagnostic tools (trace, debug)

Secure Auto-provisioning

System

CPU Motorola MC875 operating at 66 MHz

Memory:

- 32 Mbytes SDRAM
- 8 Mbytes Flash

Physical

Dimensions: 11W x 1.5H x 6.2D inch (280W x 39H x 157D mm)

Weight: <21 oz. (<600g)

Power Consumption: < 10W

Operating temperature: 32–104°F (0–40°C)

Operating humidity: up to 90%, non condensing

Identification of the SmartNode devices via SNMP

All SmartNode devices have assigned sysObjectID (.iso.org.dod.internet.mgmt.mib-2.system.sysObjectID) numbers (see [table 6](#)).

Table 6. SmartNode Models and their Unique sysObjectID

SmartNode Model	SysObjectID
SN4634	.iso.org.dod.internet.private.enterprises.patton.products.sn46xx.1 1.3.6.1.4.1.1768.2.4.9.1
SN4638	.iso.org.dod.internet.private.enterprises.patton.products.sn46xx.2 1.3.6.1.4.1.1768.2.4.9.2

According to [table 6](#), an SNMP get request to *.iso.org.dod.internet.mgmt.mib-2.system.sysObjectID* of a SmartNode 4634 device reads out a numeric OID of *1.3.6.1.4.1.1768.2.4.9.1*, which represents a SmartNode 4634 device. The mapping of the sysObjectID to each of the SmartNode model is realized with the SmartNode product identification MIB.



The SNMP agent running in SmartWare is SNMP version 1 (SNMPv1) compliant. SNMP version 2 (SNMPv2) and SNMP version 3 (SNMPv3) are not currently supported.

Appendix C **Cabling**

Chapter contents

Introduction	44
Console	44
Ethernet	45
ISDN BRI	46

Introduction

This section provides information on the cables used to connect the SmartNode and the interface cards to the existing network infrastructure and to third party products.

Console

The SmartNode can be connected to a serial terminal over its serial console port, as depicted in [figure 9](#).



CAUTION

The interconnecting cables shall be acceptable for external use and shall be rated for the proper application with respect to voltage, current, anticipated temperature, flammability, and mechanical serviceability.



CAUTION

When this device is used in North America, it shall be connected to a Network Termination Device and not connected directly to an outside POTS line.

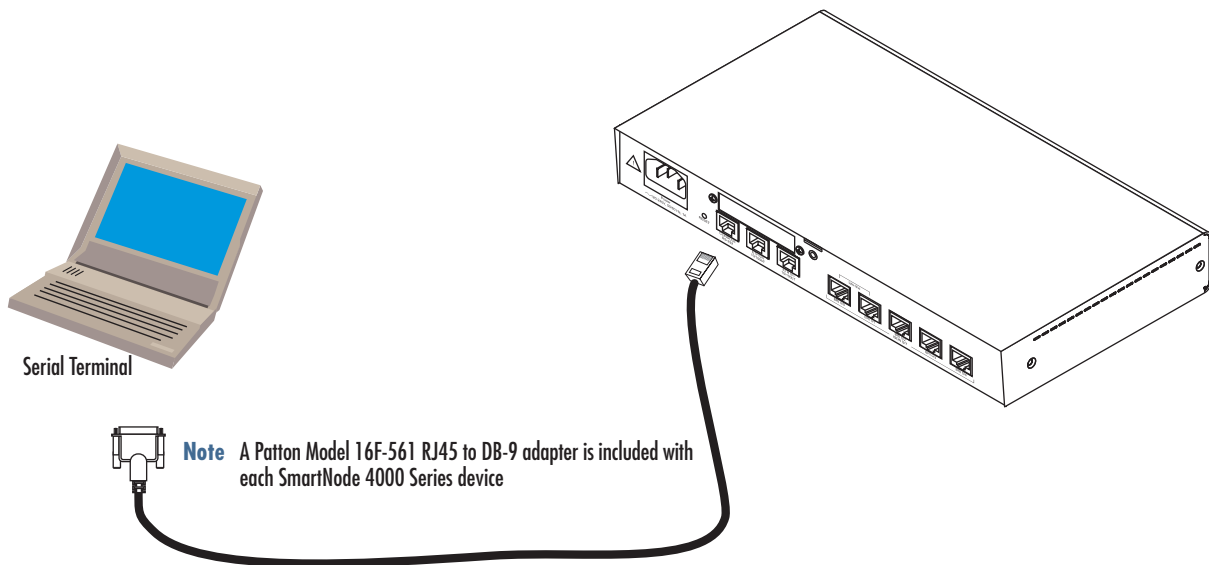

Figure 9. Connecting a serial terminal

Note See section “[Console port](#)” on page 53 for console port pin-outs.

Ethernet

Ethernet devices (10Base-T/100Base-T) are connected to the SmartNode over a cable with RJ-45 plugs. All Ethernet ports on the SN4630 are Auto-MDX use any straight or crossover cable to connect to hubs, switches, PCs or other devices.



CAUTION

The interconnecting cables shall be acceptable for external use and shall be rated for the proper application with respect to voltage, current, anticipated temperature, flammability, and mechanical serviceability.



CAUTION

When this device is used in North America, it shall be connected to a Network Termination Device and not connected directly to an outside POTS line.

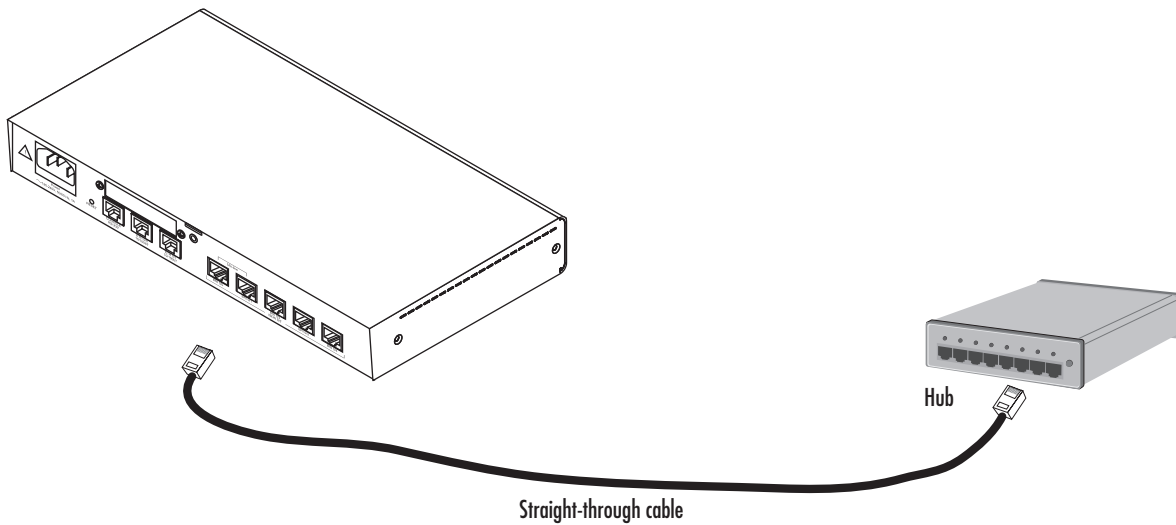

RJ-45, male

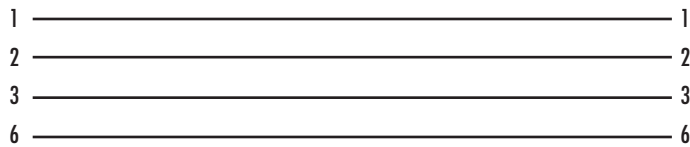

RJ-45, male

Note: Other pins are not used.

Figure 10. Typical Ethernet straight-through cable diagram

ISDN BRI

The ISDN ports are connected to ISDN terminals (Phones/PBXs) or an ISDN NT using cables terminated with RJ-45 connectors. Use straight-through cables to connect to the S/T port of your NT or phones/PBX.



CAUTION

The interconnecting cables shall be acceptable for external use and shall be rated for the proper application with respect to voltage, current, anticipated temperature, flammability, and mechanical serviceability.



CAUTION

When this device is used in North America, it shall be connected to a Network Termination Device and not connected directly to an outside POTS line.

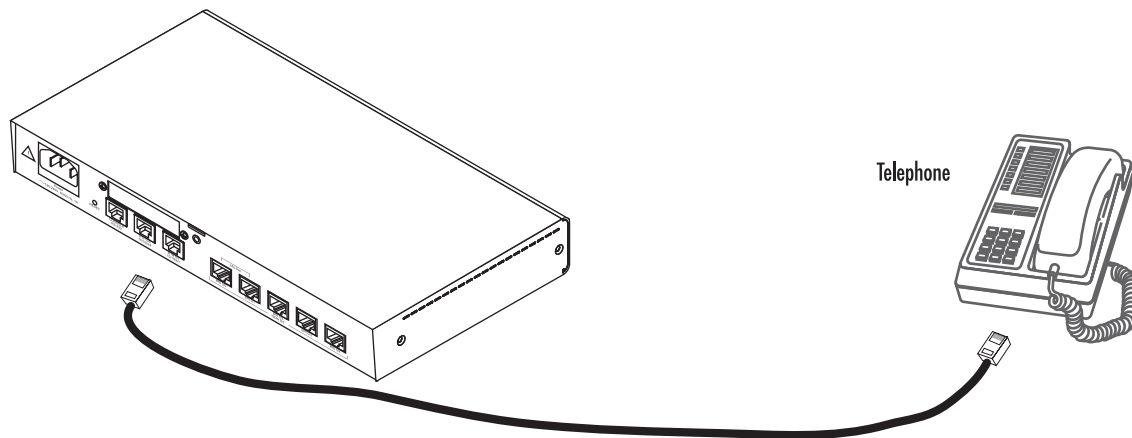

RJ-45, male

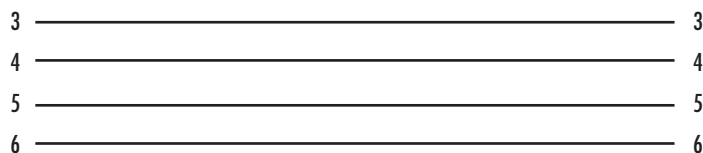

RJ-45, male

Note: Other pins are not used.

Figure 11. Connecting an ISDN device

Appendix D **Port pin-outs**

Chapter contents

Introduction	48
Console port.....	48
Ethernet	48
ISDN BRI 0/0 (NT/Net or TE/User) port.....	48
ISDN BRI 0/1 .. 0/3 (TE/Usr or NT/Net).....	49

Introduction

This section provides pin-out information for the ports of the SmartNode.

Console port

Configuration settings: 9600 bps, 8 bits, no parity, 1 stop bit, no flow control

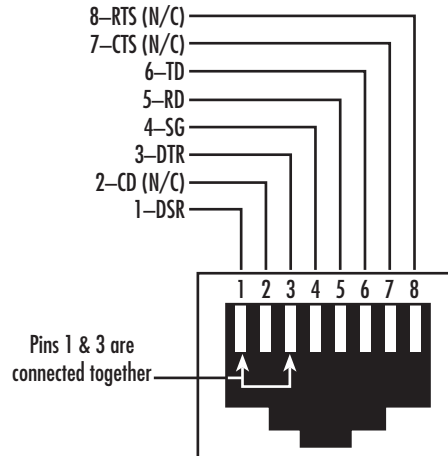

Figure 12. EIA-561 (RJ-45 8-pin) port

Note *N/C* means no internal electrical connection.

Ethernet

Table 7. RJ-45 socket

Pin	Signal
1	TX+
2	TX-
3	RX+
6	RX-

Note Pins not listed are not used.

ISDN BRI 0/0 (NT/Net or TE/User) port

The BRI phone port uses an 8-pin RJ-45 connector (the pinout is shown in [table 8](#)).

Table 8. RJ-45 socket

Pin	Signal
3	Rx+
4	Tx+

Table 8. RJ-45 socket

Pin	Signal
5	Tx-
6	Rx-

Note Pins not listed are not used.

Note All pins between the *port BRI 0/0* and *the port BRI 0/1* are connected during power failure. Fallback relay operation:

- When the unit is not powered, the fallback relay connects pins 3, 4, 5, and 6 of the net and the user ports (fallback) together. This enables you to place calls to the PSTN even if the unit is powered down.
- Line power applied to the *Line* port is fed through to the *Phone* port at all times and independent of the fallback relay's status.

Note On each ISDN BRI port in TE mode, it is possible to switch on ISDN line power per software. The total amount of power is 4W. If a ISDN BRI port is switched to NT mode, the ISDN line power is turned off.

ISDN BRI 0/1 .. 0/3 (TE/Usr or NT/Net)

The BRI *Line* port uses an 8-pin RJ-45 connector (the pinout is shown in [table 8](#)).

Table 9. RJ-45 socket

Pin	Signal
3	Rx+
4	Tx+
5	Tx-
6	Rx-

Note All pins between the *port BRI 0/0* and *port BRI 0/1* ports are connected during power failure.

Note On each ISDN BRI port in TE mode, it is possible to switch on ISDN line power per software. The total amount of power is 4W. If a ISDN BRI port is switched to NT mode, the ISDN line power is turned off.

Appendix E **SmartNode 4630 factory configuration**

Chapter contents

Introduction	51
--------------------	----

Introduction

The factory configuration settings for SmartNode 4630 are as follows:

```
#-----#
#
# 4110/4520/4630 Series
# R3.xx BUILDxxxxx
# 2005-01-18T00:00:00
# Factory configuration file
#
#-----#

profile napt NAPT

profile dhcp-server DHCP
  network 192.168.1.0 255.255.255.0
  include 192.168.1.10 192.168.1.19
  lease 2 hours
  default-router 192.168.1.1

context ip router

  interface eth0
    ipaddress 172.16.40.1 255.255.0.0
    use profile napt NAPT

  interface eth1
    ipaddress 192.168.1.1 255.255.255.0

context ip router
  dhcp-server use DHCP

port ethernet 0 0
  encapsulation ip
  bind interface eth0 router
  no shutdown

port ethernet 0 1
  encapsulation ip
  bind interface eth1 router
  no shutdown
```

Appendix F **End user license agreement**

Chapter contents

- End User License Agreement53
 - 1. Definitions53
 - 2. Title53
 - 3. Term53
 - 4. Grant of License53
 - 5. Warranty53
 - 6. Termination54
 - 7. Other licenses54

End User License Agreement

By opening this package, operating the Designated Equipment or downloading the Program(s) electronically, the End User agrees to the following conditions:

1. Definitions

- A) *Effective Date* shall mean the earliest date of purchase or download of a product containing the Patton Electronics Company Program(s) or the Program(s) themselves.
- B) *Program(s)* shall mean all software, software documentation, source code, object code, or executable code.
- C) *End User* shall mean the person or organization which has valid title to the Designated Equipment.
- D) *Designated Equipment* shall mean the hardware on which the Program(s) have been designed and provided to operate by Patton Electronics Company.

2. Title

Title to the Program(s), all copies of the Program(s), all patent rights, copyrights, trade secrets and proprietary information in the Program(s), worldwide, remains with Patton Electronics Company or its licensors.

3. Term

The term of this Agreement is from the Effective Date until title of the Designated Equipment is transferred by End User or unless the license is terminated earlier as defined in section “6. Termination” on page 59.

4. Grant of License

- A) During the term of this Agreement, Patton Electronics Company grants a personal, non-transferable, non-assignable and non-exclusive license to the End User to use the Program(s) only with the Designated Equipment at a site owned or leased by the End User.
- B) The End User may copy licensed Program(s) as necessary for backup purposes only for use with the Designated Equipment that was first purchased or used or its temporary or permanent replacement.
- C) The End User is prohibited from disassembling; decompiling, reverse-engineering or otherwise attempting to discover or disclose the Program(s), source code, methods or concepts embodied in the Program(s) or having the same done by another party.
- D) Should End User transfer title of the Designated Equipment to a third party after entering into this license agreement, End User is obligated to inform the third party in writing that a separate End User License Agreement from Patton Electronics Company is required to operate the Designated Equipment.

5. Warranty

The Program(s) are provided *as is* without warranty of any kind. Patton Electronics Company and its licensors disclaim all warranties, either express or implied, including but not limited to the implied warranties of merchantability, fitness for a particular purpose or non-infringement. In no event shall Patton Electronics Company or its licensors be liable for any damages whatsoever (including, without limitation, damages for loss of business profits, business interruption, loss of business information, or other pecuniary loss) arising out of the use of or inability to use the Program(s), even if Patton Electronics Company has been advised of the possibility of such damages. Because some states do not allow the exclusion or limitation of liability for consequential or incidental damages, the above limitation may not apply to you.

If the Program(s) are acquired by or on behalf of a unit or agency of the United States Government, the Government agrees that such Program(s) are *commercial computer software* or *computer software documentation* and that, absent a written agreement to the contrary, the Government's rights with respect to such Program(s) are limited by the terms of this Agreement, pursuant to Federal Acquisition Regulations 12.212(a) and/or DEARS 227.7202-1(a) and/or sub-paragraphs (a) through (d) of the "Commercial Computer Software - Restricted Rights" clause at 48 C.F.R. 52.227-19 of the Federal Acquisition Regulations as applicable.

6. Termination

- A) The End User may terminate this agreement by returning the Designated Equipment and destroying all copies of the licensed Program(s).
- B) Patton Electronics Company may terminate this Agreement should End User violate any of the provisions of section "4. Grant of License" on page 58.
- C) Upon termination for A or B above or the end of the Term, End User is required to destroy all copies of the licensed Program(s)

7. Other licenses

The Program may be subject to licenses extended by third parties. Accordingly, Patton Electronics Company licenses the Programs subject to the terms and conditions dictated by third parties. Third party software identified to the Programs includes:

- A routing license is included at no charge.
- MGCP and VPN capabilities will require the purchase of an additional license.
- The LGPL (Lesser General Public License) open source license distributed to you pursuant to the LGPL license terms (<http://www.gnu.org/licenses/lgpl.html>).
- RedBoot (Red Hat Embedded Debug and Bootstrap) embedded system debug/bootstrap environment from Red Hat distributed to you pursuant to the eCos license terms (<http://ecos.sourceware.org/license-overview.html>) and GNU General Public License (GPL) terms (<http://www.gnu.org/copyleft/gpl.html>). Source code is available upon request.