

Dear Valued Customer,

Thank you for purchasing Patton Electronics products! We do appreciate your business. I trust that you find this user manual helpful.

We manufacture one of the widest selections of data communications products in the world including CSU/DSU's, network termination units, powered and self-powered short range modems, fiber optic modems, interface converters, baluns, electronic data switches, data-line surge protectors, multiplexers, transceivers, hubs, print servers and much more. We produce these products at our Gaithersburg, MD, USA, facility, and can custom manufacture products for your unique needs.

We would like to hear from you. Please contact us in any of the following ways to tell us how you like this product and how we can meet your product needs today and in the future.

Web: <http://www.patton.com>
Sales E-mail: sales@patton.com
Support E-mail: support@patton.com
Phone - Sales (301) 975-1000
Phone - Support (301) 975-1007
Fax: (301) 869-9293
Mail: Patton Electronics Company
7622 Rickenbacker Drive
Gaithersburg, MD 20879 USA

We are committed to a quality product at a quality price. Patton Electronics is BABT and ISO 9001 certified. We meet and exceed the highest standards in the industry (CE, UL, etc.).

It is our business to serve you. If you are not satisfied with any aspect of this product or the service provided from Patton Electronics or its distributors, please let us know.

Thank you.

Burton A. Patton
Vice President

P.S. Please tell us where you purchased this product.

USER MANUAL

MODEL 1140RC RS-232 Fiber Optic Rack Card Modem w/ V.54 & V.52 Diagnostics



An ISO-9001
Certified Company

Part #07M1140RC-C
Doc #018031UC
Revised 6/6/97

SALES OFFICE
(301) 975-1000
TECHNICAL SUPPORT
(301) 975-1007
<http://www.patton.com>

1.0 WARRANTY INFORMATION

Patton Electronics warrants all Model 1140RC components to be free from defects, and will—at our option—repair or replace the product should it fail within one year from the first date of shipment.

This warranty is limited to defects in workmanship or materials, and does not cover customer damage, abuse or unauthorized modification. If this product fails or does not perform as warranted, your sole recourse shall be repair or replacement as described above. Under no condition shall **Patton Electronics** be liable for any damages incurred by the use of this product. These damages include, but are not limited to, the following: lost profits, lost savings and incidental or consequential damages arising from the use of or inability to use this product. **Patton Electronics** specifically disclaims all other warranties, expressed or implied, and the installation or use of this product shall be deemed an acceptance of these terms by the user.

1.1 RADIO AND TV INTERFERENCE

The Model 1140RC generates and uses radio frequency energy, and if not installed and used properly—that is, in strict accordance with the manufacturer's instructions—may cause interference to radio and television reception. The Model 1140RC has been tested and found to comply with the limits for a Class A computing device in accordance with the specifications in Subpart J of Part 15 of FCC rules, which are designed to provide reasonable protection from such interference in a commercial installation. However, there is no guarantee that interference will not occur in a particular installation. If the Model 1140RC does cause interference to radio or television reception, which can be determined by turning the power off or removing the card, the user is encouraged to try to correct the interference by one or more of the following measures: moving the computing equipment away from the receiver, re-orienting the receiving antenna and/or plugging the receiving equipment into a different AC outlet (such that the computing equipment and receiver are on different branches). In the event the user detects intermittent or continuous product malfunction due to nearby high power transmitting radio frequency equipment, the user is strongly advised to take the following steps: use only data cables with an external outer shield bonded to a metal or metalized connector; and, configure the rear card as shown in section 3.2 of this manual.

1.2 CE NOTICE

The CE symbol on your Patton Electronics equipment indicates that it is in compliance with the Electromagnetic Compatibility (EMC) directive and the Low Voltage Directive (LVD) of the Union European (EU). A Certificate of Compliance is available by contacting Technical Support.

1.3 SERVICE

All warranty and nonwarranty repairs must be returned freight prepaid and insured to Patton Electronics. All returns must have a Return Materials Authorization number on the outside of the shipping container. This number may be obtained from Patton Electronics Technical Support: **(301) 975-1007**; <http://www.patton.com>; or, support@patton.com.

NOTE: Packages received without an RMA number will not be accepted.

Patton Electronics' technical staff is also available to answer any questions that might arise concerning the installation or use of your Model 1140RC. Technical Service hours: **8AM to 5PM EST, Monday through Friday.**

2.0 GENERAL INFORMATION

Thank you for your purchase of this Patton Electronics product. This product has been thoroughly inspected and tested and is warranted for One Year parts and labor. If any questions or problems arise during installation or use of this product, please do not hesitate to contact Patton Electronics Technical Support at **(301) 975-1007**, **support@patton.com** or **www.patton.com**.

2.1 FEATURES

- Supports async or sync communication over dual optical fibers
- RS-232 Data rates to 57.6 Kbps
- Distances to 2 miles
- V.54 and V.52 Diagnostics
- Mounts in Patton's 16-Card Rack Chassis
- Compatible with the Patton Model 1140 self-powered modem
- Immune to RFI/EMI noise, ground loops and transient surges
- Easily accessible configuration jumpers & switches
- Bi-level LED status indicators
- Works with switchable 120V or 240V rack mount power supply
- SMA or ST connectors available (HD-26 female RS-232 port) on rear Interface card

2.2 DESCRIPTION

The **Patton Model 1140RC fiber optic rack card modem** is the rack mountable counterpart to Patton's Model 1140 self-powered, fiber optic modem. Communicating full or half duplex over dual optical fibers, the Model 1140RC supports data rates to 57.6 Kbps and distances to 2 miles. Both V.54 and V.52 diagnostics are built into the unit. Like all fiber optic modems, the Model 1140RC is inherently immune to RFI/EMI noise, ground loops and transient surges. The carrier may be switch selected as either "Continuously On" or "Controlled by RTS". Five pairs of bi-level LED indicators monitor TD, RD, RTS, CD, test and error. A single LED monitors power.

The Model 1140RC is designed to mount in Patton's 2U high 19" rack chassis. This 16-card chassis has a switchable 120/240 volt power supply and mounts cards in a mid-plane architecture: The front "brains" half-card can be plugged into different rear "interface" cards. The Model 1140RC is available with a choice of two interface cards: one with SMA connectors, and one with ST connectors. Both cards are equipped with an HD-26 female connector for the RS-232 interface.

3.0 CONFIGURATION

This section describes the location and orientation of the Model 1140RC's configuration switches and jumpers, and provides detailed instructions for all possible settings.

The Model 1140RC uses a combination of DIP switches and jumpers that allow configuration to an extremely wide range of applications. Designed around a mid-plane architecture, the Model 1140RC incorporates both front and rear cards. Configuration of both may be necessary. The switches/jumpers are accessible when the cards are removed from the rack chassis. Once configured, the Model 1140RC is designed to operate transparently, without need for frequent re-configuration.

3.1 FRONT CARD CONFIGURATION

The Model 1140RC front card has two sets of eight switches (S1 & S2), which are mounted on the PC board (Figure 1, below). These configuration switches allow you to configure the Model 1140RC for a wide range of applications. The ON/OFF orientation of the DIP switches is shown in figure 2 (below).

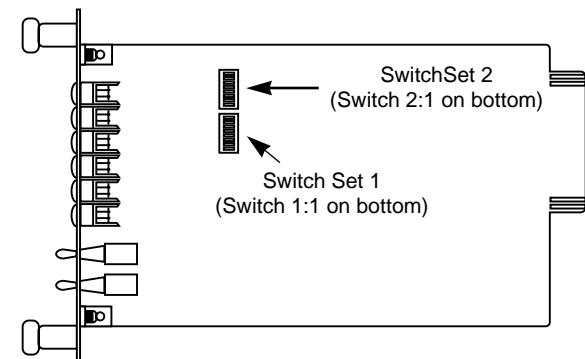

Figure 1. Model 1140RC front card jumper locations

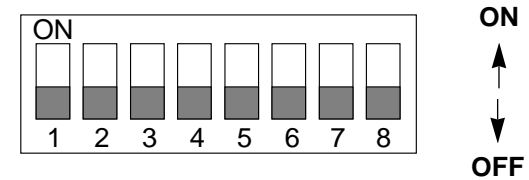

Figure 2. Close-up of DIP switches showing "ON" and "OFF" positions

3.1.1 CONFIGURATION SWITCH SET "S1"

The DIP switches on S1 set data rate, clock source, async./sync. mode and carrier control method. The default settings are summarized in the table below. Following the table is a description of all possible S-1 switch settings.

S1 SUMMARY TABLE		
Position	Function	Factory Default
S1-1	Data Rate	On
S1-2	Data Rate	Off
S1-3	Data Rate	Off
S1-4	Data Rate	On
		} 9,600 bps
S1-5	Clock Source	On
S1-6	Clock Source	On
		} Internal
S1-7	Async./Sync.	On Async.
S1-8	Carrier Control	Off Constantly On

S1-1 through S1-4: Data Rate Setting

Switches S1-1 through S1-4 are set in combination to determine the asynchronous and synchronous data rate for the Model 1140RC.

S1-1	S1-2	S1-3	S1-4	Setting
On	On	On	On	1.2 Kbps
Off	On	On	On	1.8 Kbps
On	Off	On	On	2.4 Kbps
Off	Off	On	On	3.6 Kbps
On	On	Off	On	4.8 Kbps
Off	On	Off	On	7.2 Kbps
On	Off	Off	On	9.6 Kbps
Off	Off	Off	On	14.4 Kbps
On	On	On	Off	19.2 Kbps
Off	On	On	Off	28.8 Kbps
On	On	Off	Off	38.4 Kbps
Off	On	Off	Off	57.6 Kbps

S1-5 and S1-6: Clock Source

Switches S1-5 and S1-6 are set in combination to determine the transmit clock source for the Model 1140RC.

S1-5	S1-6	Setting
On	On	Internal transmit clock
Off	On	Receive recover clock
On	Off	External transmit clock

S1-7: Asynchronous/Synchronous Mode

The setting for switch S1-7 determines whether the Model 1140RC is in asynchronous or synchronous operating mode.

S1-7	Setting
On	Asynchronous
Off	Synchronous

S1-8: Carrier Control Method

The setting for switch S1-8 determines whether the carrier is "constantly on" or "controlled by RTS". This setting allows for operation in switched carrier, multipoint and/or hardware handshaking applications.

S1-8	Setting
Off	Constantly On
On	Switched Carrier

3.1.2 CONFIGURATION SWITCH SET “S2”

The DIP switches on S2 set word length, extended signaling rate, RTS/CTS delay and V.52 and V.54 diagnostic test. The default settings are summarized in the table below. Following the table is a description of all possible S-2 switch settings.

S2 SUMMARY TABLE		
Position	Function	Factory Default
S2-1	Word Length	Off
S2-2	Word Length	Off
		} 10 bits
S2-3	Extended Signaling Rate	Off -2.5% to +2.3%
S2-4	RTS/CTS Delay	On
S2-5	RTS/CTS Delay	On
		} 7 mS
S2-6	Future Use	-
S2-7	Future Use	-
S2-8	V.52/V.54 Tests	Off Enable

S2-1 and S2-2: Word Length

Switches S2-1 and S2-2 are set in combination to determine the word length for asynchronous data.

S2-1	S2-2	Setting
Off	On	8 bits
On	On	9 bits
Off	Off	10 bits
On	Off	11 bits

S2-3: Extended Signaling Rate

The setting for switch S2-3 determines the range of variability the Model 1140RC “looks for” in asynchronous data rates (i.e., the actual variance from a given frequency level the Model 1140RC will tolerate).

S2-3	Setting	
Off	-2.5% to +1%	Basic
On	-2.5% to +2.3%	Extended

S2-4 and S2-5: RTS/CTS Delay

The combined settings for switches S2-4 and S2-5 determine the amount of delay between the time the Model 1140RC “sees” RTS and when it sends CTS. Options are no delay, 7 ms and 53 ms.

S2-4	S2-5	Setting
On	On	7 mS
Off	On	53 mS
On	Off	No delay
Off	Off	No delay

S2-8: V.54 Loopback Test Enable

To reset the V.54 circuit, set switch S2-6 to the “ON” position, then back to the “OFF” position..

S2-8	Setting
Off	V.54 Enable
On	V.54 Disable

3.2 REAR CARD CONFIGURATION

The Model 1140RC is compatible with two dual-fiber interface cards, one with dual ST connectors and one with dual SMA connectors. Both cards use an HD-26 female for the RS-232 interface. The single configuration jumper (JB1) functions identically on both cards. Figure 3 (below) shows the jumper’s location.

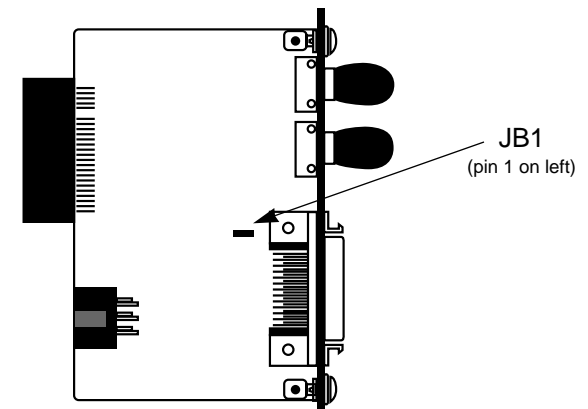

Figure 3. Model 1140RC rear card jumper location

4.0 INSTALLATION

3.2.1 HOW THE JUMPER WORKS

Figure 4 (below) shows the 3-pin jumpers used on the rear card. The strap enables or disables a particular function depending upon whether it straddles pins 1 and 2, or pins 2 and 3.

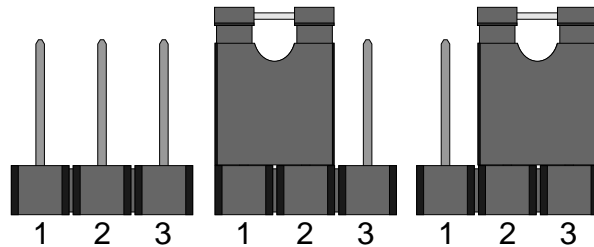

Figure 4. Orientation of interface card strap

DTE Shield (Pin 1) & FRGND (JB1)

In the connected (closed) position, this strap links DB-25 pin 1 and frame ground. In the open (disconnected) position, pin 1 is "lifted" from frame ground.

JB1

Position 1&2 = DTE Shield (Pin 1) and FRGND connected

Position 2&3 = DTE Shield (Pin 1) and FRGND not connected

This section describes the functions of the Model 1000R16 rack chassis, tells how to install front and rear Model 1140RC cards into the chassis, and provides instructions for connecting the interface cables.

4.1 THE MODEL 1000R16 RACK CHASSIS

The 1000R16 Rack Chassis (Figure 5, below) has sixteen short range modem card slots, plus its own power supply. Measuring only 3.5" high, the 1000R16 is designed to occupy only 2U in a 19" rack. Sturdy front handles allow the 1000R16 to be extracted and transported conveniently.

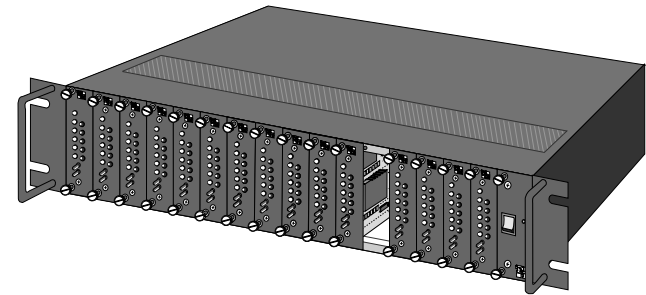

Figure 5. Model 1000R16 rack chassis with power supply

4.1.1 THE RACK POWER SUPPLY

The power supply included in the Model 1000R16 rack uses the same mid-plane architecture as the modem cards. The front card of the power supply slides in from the front, and the rear card slides in from the rear. They plug into one another in the middle of the rack. The front card is then secured by thumb screws and the rear card by conventional metal screws.

WARNING! There are no user-serviceable parts in the power supply section of the Model 1140RC. Voltage setting changes and fuse replacement should only be performed by qualified service personnel. Contact Patton Electronics Technical support at (301) 975-1007, <http://www.patton.com>, or support@patton.com for more information.

Switching the Power Supply On and Off

The power supply on/off switch is located on the front panel. When plugged in and switched on, a red front panel LED will glow. Since the Model 1000R16 is a “hot swappable” rack, *it is not necessary for any cards to be installed before switching on the power supply*. The power supply may be switched off at any time without harming the installed cards.

NOTE: Please refer to the Model 1000RP Series User Manual *AC and DC Rack Mount Power Supplies* for fuse and power card replacement information.

4.2 INSTALLING THE MODEL 1140RC INTO THE CHASSIS

The Model 1140RC is comprised of a front card and a rear card. The two cards meet inside the rack chassis and plug into each other via mating 50 pin card edge connectors. Use the following steps as a guideline for installing each Model 1140RC into the Model 1000R16 rack chassis:

1. Slide the rear card into the back of the chassis along the metal rails.
2. Secure the rear card using the metal screws provided.
3. Slide the front card into the front of the chassis. It should meet the rear card when it’s almost all the way into the chassis.
4. Push the front card *gently* into the card-edge receptacle of the rear card. It should “click” into place.
5. Secure the front card using the thumb screws.

NOTE: Since the Model 1000R16 chassis allows “hot swapping” of cards, it is *not necessary to power down* the rack when you install or remove a Model 1140RC.

4.3 WIRING UP THE MODEL 1140RC

Both of the rear interface cards compatible with the Model 1140RC have one RS-232 port and one dual-connector fiber port (see Figure 6. below). Depending upon the card you have, the fiber port will be either an ST or SMA connector. The RS-232 port is always a female HD-26 connector.

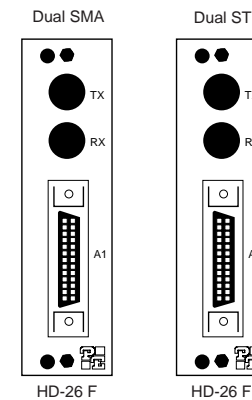

Figure 6. Model 1140RC interface card options

4.3.1 RS-232 CONNECTION

The RS-232 port on the rear card of the Model 1140RC is wired as a DCE, and uses a female HD-26 connector. The HD-26 is an alternate connector according to the EIA RS-232E specification, and the pin-out is the same as a standard DB-25. Pin 26 is not used.

You will need an interface cable to connect the Model 1140RC to your RS-232 device. Assuming your RS-232 device is a DTE (PC, host, terminal, workstation, etc.), the cable should be wired *straight through*. You may either provide your own cable, or you may purchase an HD-26 to DB-25 cable from Patton Electronics Company. Please call the Patton Sales Department at (301) 975-1000 for price and delivery information.

Notice! Any terminal cable connected to the Model 1140RC must be shielded cable, and the outer shield must be 360 degree bonded—at both ends—to a metal or metalized backshell.

4.3.2 FIBER CONNECTIONS

The Model 1140RC is designed to work with the self-powered Model 1140, or with another Model 1140RC. In either case, you will need one unit at each end of a dual fiber cable. This cable connects to the Model 1140RC using either ST or SMA connectors. Figure 7 (below) shows a close-up of each of these connector types.

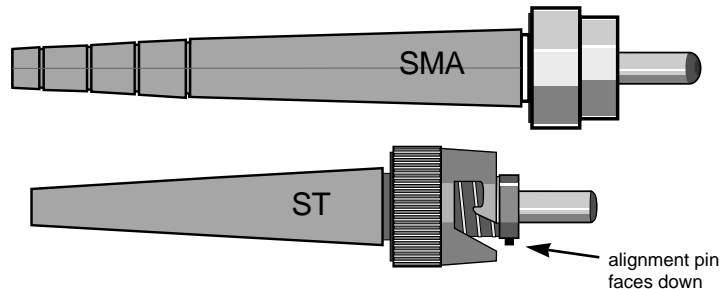

Figure 7. Close up of ST and SMA connections

Once you have configured each Model 1140RC and connected the cables, you are ready to operate the units. This section describes the LED status monitors and power-up procedure.

5.1 LED STATUS MONITORS

The Model 1140RC features ten front panel status LEDs that indicate the condition of the modem and communication link:

- The green “PWR” LED glows when power is applied to the modem card through its mid-plane chassis connection.
- The green “TD” and “RD” indicators blink to show positive state data activity. The Red “TD” and “RD” indicators blink to show negative state data activity. Solid red indicates an idle state.
- The green “RTS” and “CD” indicators glow solid to show the control signal is on. The red “RTS” and “CD” indicators glow solid to show the control signal is off. When the 1140RC is connected to a DTE, RTS will glow green for an incoming signal on RS-232 pin 4. CD will glow green for an incoming signal from the line, and an outgoing signal on RS-232 pin 8.
- The “Test” LED glows when either the Local Analog Loopback (LAL) or Remote Digital Loopback (RDL) V.54 test mode is initiated. The “Error” LED blinks when an error is detected by the V.52 diagnostics.

5.2 POWER-UP

There is no power switch on the Model 1140RC: Power is automatically applied to the 1140RC when its card-edge connector makes contact with the chassis’ mid-plane socket, or when the chassis’ power supply is turned on. *Note: The 1140RC is a “hot swappable” card—it will not be damaged by plugging it in or removing it while the rack is powered up.*

When the local and remote units are *both* powered up, and are passing data *normally*, the following LED conditions will exist:

- PWR = green
- TD & RD = flashing red and green
- RTS & CD = green
- Test = off
- Error = off

5.3 TEST MODES

The Model 1140RC offers two V.54 test modes and two V.52 test modes to evaluate the condition of the modems and the communication link. Both sets of tests can be activated physically from the front panel. The V.54 test can also be activated from the RS-232 interface. *Note: V.54 and V.52 test modes on the Model 1140RC are available for point-to-point applications only.*

5.3.1 LOCAL ANALOG LOOPBACK (LAL)

The Local Analog Loopback (LAL) test checks the operation of the local Model 1140RC, and is *performed separately on each unit*. Any data sent to the local Model 1140RC in this test mode will be echoed (returned) back to the user device. For example, characters typed on the keyboard of a terminal will appear on the terminal screen. To perform a LAL test, follow these steps:

1. Activate LAL. This may be done in one of two ways: First, by moving the upper front panel toggle switch RIGHT to "Analog". Second, by raising pin 18 on the RS-232 interface (note: be sure DIP switch S2-8 is off). Once LAL is activated, the Model 1140RC transmit output is connected to its own receiver. The "Test" LED should be lit.
2. Verify that the data terminal equipment is operating properly and can be used for a test.
3. Locate the lower of the two toggle switches on the front panel of the Model 1140RC and move it to the right. This will activate the V.52 BER test mode and inject a "511" test pattern into the local loop. If any errors are present in the loop, the red "Error" LED will blink sporadically.
4. If the BER test indicates *no errors* are present, move the V.52 toggle switch to the left, thus activating the "511/E" test with periodic errors. If the test is working properly, the red "Error" LED will light. A successful "511/E" test will confirm that the loop is in place, and that the Model 1140RC's built-in "511" generator and detector are working properly.
5. If the BER test indicates that errors *are* present, check to see that the RS-232 cable connecting the DTE to the Model 1140RC is wired straight through, and is plugged in properly. Also, ensure that the Model 1140RC is configured properly. Then re-check your DTE equipment. If you still have errors, call **Patton Technical Support at (301) 975-1007**.

5.3.2 REMOTE DIGITAL LOOPBACK (RDL)

The Remote Digital Loopback (RDL) test checks the performance of both the local and remote Model 1140RCs, *and* the communication link between them. Any characters sent to the remote 1140RC in this test mode will be returned back to the originating device. For example, characters typed on the keyboard of the local terminal will appear on the local terminal screen *after* having been passed to the remote Model 1140RC and looped back. To perform an RDL test, follow these steps:

1. Activate RDL. This may be done in two ways: First, by moving the upper front panel toggle switch LEFT to "Remote". Second, by raising pin 21 on the RS-232 interface. (Note: be sure DIP switch S2-8 is off).
2. Verify that the DTE equipment on the local end is operating properly and can be used for a test.
3. Locate the lower of the two toggle switches on the front panel of the 1140RC and move it to the right. This will activate the V.52 BER test mode and inject a "511" test pattern into the remote loop. If any errors are present in the loop, the red "Error" LED will blink sporadically.
4. If the BER test indicates *no errors* are present, move the V.52 toggle switch to the left, thus activating the "511/E" test with periodic errors. If the test is working properly, the red "Error" LED will light. A successful "511/E" test will confirm that the loop is in place, and that the Model 1140RC's built-in "511" generator and detector are working properly.
5. If the remote BER test indicates that errors *are* present, and the local analog loopback/BER tests showed that both Model 1140RCs were functioning properly, this suggests a problem with the twisted pair communication line connecting the two modems. A common problem is improper crossing of the pairs. Also, verify that the modular connections are pinned properly, and the twisted pair line has continuity. If you still have errors, call **Technical Support at (301) 975-1007**.

5.3.3 USING THE V.52 BER TEST INDEPENDENTLY

The Model 1140RC's V.52 BER test can be used independent of the V.54 loopback tests. This requires two operators: one to initiate and monitor the test at both the local and the remote Model 1140RC. To use the V.52 BER test by itself, both operators should simultaneously follow these steps:

1. Locate the lower of the two toggle switches on the front panel of the Model 1140RC and move it to the right. This will activate the V.52 BER test mode and transmit a "511" test pattern to the other unit. If any errors are present, the receiving modem's red "Error" LED will blink sporadically. Note: For this independent test to function, the "511" switch on *both* Model 1140RCs must be turned on.
2. If the test indicates no errors are present, move the V.52 toggle switch to the left, thus activating the "511/E" test with periodic errors present. If the test is working properly, the receiving modem's red "Error" LED will blink *regularly*. A successful "511/E" test will confirm that the link is in place, and that the Model 1140RC's built-in "511" generator and detector are working properly.

APPENDIX A SPECIFICATIONS

Transmission Line: Dual optical cable

Transmission Mode: Asynchronous, half or full duplex, point-to-point

Interfaces: EIA RS-232, CCITT V.24

Data Rates: 0 - 57.6 Kbps

Distance: 2 miles over continuous fiber

RTS/CTS Delay: Switch-selectable: No delay, 7.0 mS, 53 mS

Receiver Sensitivity: -45 dBm

Coupled Power Output: -30 to -36 dBm

Optic Wavelength: 850 nm

LED Indicators: Power, TD, RD, RTS, CD, Test Mode, Error

Connectors: HD-26 female on RS-232 side; ST or SMA connectors on fiber side

Power Supply: 120/240V (switchable) on rack chassis

Temperature Range: 0-60°C (32-140°F)

Altitude: 0-15,000 feet

Humidity: Up to 95% non-condensing

Weight: 2 oz.

Dimensions: 0.95"W x 3.1"H x 5.4"L

APPENDIX B
FACTORY REPLACEMENT PARTS

The Patton Model 1140RC rack system features interchangeable rear half cards, power cords/fuses for international various operating environments and other user-replaceable parts. Model numbers and descriptions for these parts are listed below:

<u>Patton Model #</u>	<u>Description</u>
1000RPEM.....	120/240V Rear Power Entry Module
1000RPSM-2.....	120/240V Front Power Supply Module
1000RPEM-DC	DC Rear Power Entry Module
1000RPSM-48A	48V Front Power Supply Module
1000RPEM-V	120/240V CE Compliant Rear Power Entry Module
1000RPSM-V	120/240V CE Compliant Front Power Supply Module
0805US	American Power Cord
0805EUR.....	European Power Cord CEE 7
0805UK	United Kingdom Power Cord
0805AUS.....	Australia/New Zealand Power Cord
0805DEN.....	Denmark Power Cord
0805FR	France/Belgium Power Cord
0805IN.....	India Power Cord
0805IS.....	Israel Power Cord
0805JAP.....	Japan Power Cord
0805SW	Switzerland Power Cord
05R16FPB1.....	Single Width Blank Front Panel
05R16FPB4.....	4-Wide Blank Front Panel
05R16RPB1	Single Width Blank Rear Panel
05R16RPB4	4-Wide Blank Rear Panel
0821R4.....	400 mA Fuse (5x20mm) Littlefuse 239.400 or equivalent
0821R2.....	200 mA Fuse (5x20mm) Littlefuse 239.200 or equivalent
056S1.....	Set of 16 #4 pan head screws/washers

APPENDIX C
PIN CONFIGURATIONS

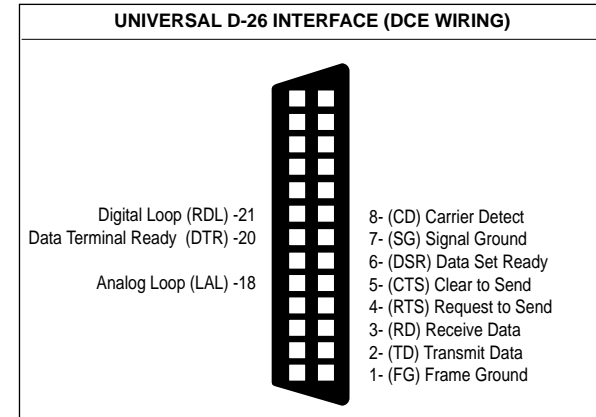

APPENDIX D
BLOCK DIAGRAM

