



Gateway Series
G100 / G200 / G400 / G800



Administrator Manual



Digium, Inc.
445 Jan Davis Drive
Huntsville, AL 35806
United States

Main Number: +1 (256)-428-6000
Tech Support: +1 (256)-428-6161
U.S. Toll Free: +1 (877)-344-4861
Sales: +1 (256)-428-6262
www.digium.com
www.asterisk.org
www.asterisknow.org

© Digium, Inc. 2013
All rights reserved.

No part of this publication may be copied, distributed, transmitted, transcribed, stored in a retrieval system, or translated into any human or computer language without the prior written permission of Digium, Inc.

Digium, Inc. has made every effort to ensure that the instructions contained in this document are adequate and error free. The manufacturer will, if necessary, explain issues which may not be covered by this documentation. The manufacturer's liability for any errors in the documents is limited to the correction of errors and the aforementioned advisory services.

This document has been prepared for use by professional and properly trained personnel, and the customer assumes full responsibility when using it.

Adobe and Acrobat are registered trademarks, and Acrobat Reader is a trademark of Adobe Systems Incorporated.

Asterisk, Digium, Switchvox, and AsteriskNOW are registered trademarks and Asterisk Business Edition, AsteriskGUI, and Asterisk Appliance are trademarks of Digium, Inc.

Any other trademarks mentioned in the document are the property of their respective owners.

Compliance Information

Compliance information for this product is available at <http://www.digium.com/compliance>.

Introduction to Gateway Series Documentation

This manual contains product information for the Gateway Series appliances. Be sure to refer to any supplementary documents or release notes that were shipped with your equipment. The manual is organized in the following manner:

Chapter/ Appendix	Title	Description
1	Overview	Identifies the features of your unit.
2	Unit Installation	Provides instructions for installing the unit.
3	Configuration	Provides instructions on how to configure the unit.
4	Troubleshooting	Explains resolutions to common problems and frequently asked questions pertaining to unit installation and usage.
A	Pin Assignments	Describes the states supported by the unit.
B	Specifications	Details unit specifications.
C	Glossary and Acronyms	Defines terms related to this product.

Symbol Definitions



Caution statements indicate a condition where damage to the unit or its configuration could occur if operational procedures are not followed. To reduce the risk of damage or injury, follow all steps or procedures as instructed.



The ESD symbol indicates electrostatic sensitive devices. Observe precautions for handling devices. Wear a properly grounded electrostatic discharge (ESD) wrist strap while handling the device.



The Electrical Hazard Symbol indicates a possibility of electrical shock when operating this unit in certain situations. To reduce the risk of damage or injury, follow all steps or procedures as instructed.

Important Safety Instructions



Servicing.

Do not attempt to service this unit. There are no user-serviceable parts inside. Refer servicing to qualified service personnel.



Batteries.

The batteries in the unit are not user-serviceable. Refer servicing to qualified service personnel.

CAUTION - Risk of explosion if battery is replaced by an incorrect type. Batteries should be disposed of according to the local laws and regulations of your region.

ATTENTION - Il y a danger d'explosion s'il y a remplacement incorrect de la batterie. Remplacer uniquement avec une batterie du même type ou d'un type équivalent recommandé par le constructeur. Mettre au rebut les batteries usagées conformément aux instructions du fabricant.



Water and Moisture.

Do not spill liquids on this unit. Do not operate this equipment in a wet environment.



Heat.

Do not operate or store this product near heat sources such as radiators, air ducts, areas subject to direct, intense sunlight, or other products that produce heat.



Caution.

To reduce the risk of fire, use only No. 26 AWG or larger telecommunication wiring for network connections.



Static Electricity.

To reduce the risk of damaging the unit or your equipment, do not attempt to open the enclosure or gain access to areas where you are not instructed to do so. Refer servicing to qualified service personnel.

Save these instructions for future reference.

TABLE OF CONTENTS

Chapter 1

Overview	11
Echo-Cancellation	15

Chapter 2

Unit Installation	16
Unpacking the Unit	17
Shipment Inspection	18
Front Panel Identification	19
Unit Identification	23
Hardware Installation	24
Connecting to the Gateway Series	33

Chapter 3

Configuration	45
Settings and Configuration	49
Logging and Reporting	65
Status and Diagnostics	66
Maintenance	72

Chapter 4

Troubleshooting	77
Frequently Asked Questions	80
Free Installation Support	84

Appendix A
Pin Assignments85

Appendix B
Specifications87

Appendix C
Glossary and Acronyms89

Figure 1:	TDM PBX to VoIP Scenario	13
Figure 2:	VoIP PBX to TDM Scenario	13
Figure 3:	TDM PBX to TDM and VoIP Scenario	14
Figure 4:	G100 Single Port Appliance	19
Figure 5:	G200 Dual Port Appliance	20
Figure 6:	G800 Octal Port Appliance	21
Figure 7:	Side-by-side Rack Mounting	29
Figure 8:	Acceptable Wall Mount Orientation	30
Figure 9:	IP Configuration Menu for G100 / G200	36
Figure 10:	IP Configuration Menu for G400 / G800	40
Figure 11:	Login Screen	46
Figure 12:	Main Menu	48

Table 1:	Gateway Series Models.	23
Table A-1:	Gigabit Ethernet Port Pinouts	85
Table A-2:	RJ45 T1/E1 Port Connector.	86

Chapter 1

Overview

Digium's Gateway Series is a converged media gateway product line designed to interface between TDM (T1/E1) and IP networks (SIP). The Gateway Series connects legacy telephone systems to IP networks and seamlessly integrates VoIP PBXs with the PSTN. Powered by innovative hardware and software solutions, Digium's Gateway Series are managed by a simple, intuitive web-based interface.

Supported Voice Modes:

- PRI CPE and PRI NET (T1 / E1)
 - National ISDN 1 / NI1
 - National ISDN 2 / NI2
 - EuroISDN
 - 4ESS (AT&T)
 - 5ESS (Lucent)
 - DMS100
 - Q.SIG

- E&M (T1 only)
 - Wink
 - Feature Group B
 - Feature Group D

- FXO and FXS (T1 only)
 - Ground Start
 - Loop Start
 - Loop Start with Disconnect Detect (Kewlstart)

- SIP

Example scenarios utilizing the Gateway Series are illustrated in Figure 1, Figure 2, and Figure 3.

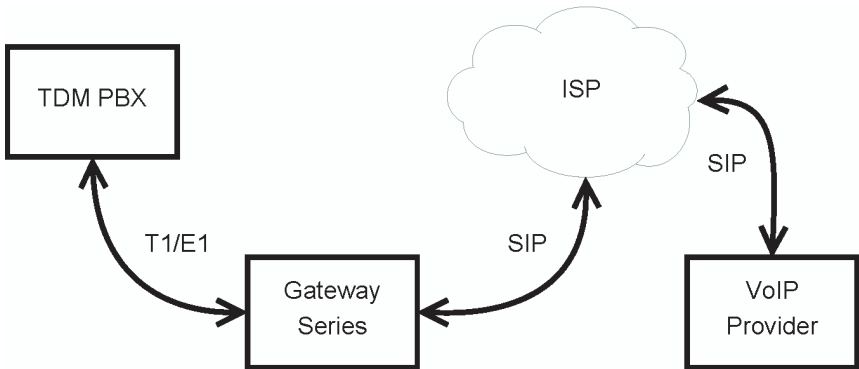

Figure 1: TDM PBX to VoIP Scenario

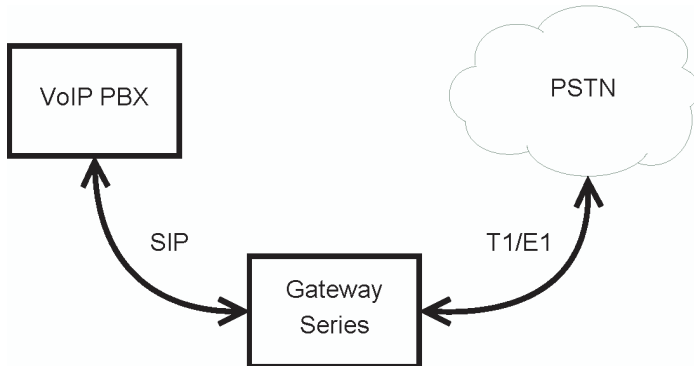

Figure 2: VoIP PBX to TDM Scenario

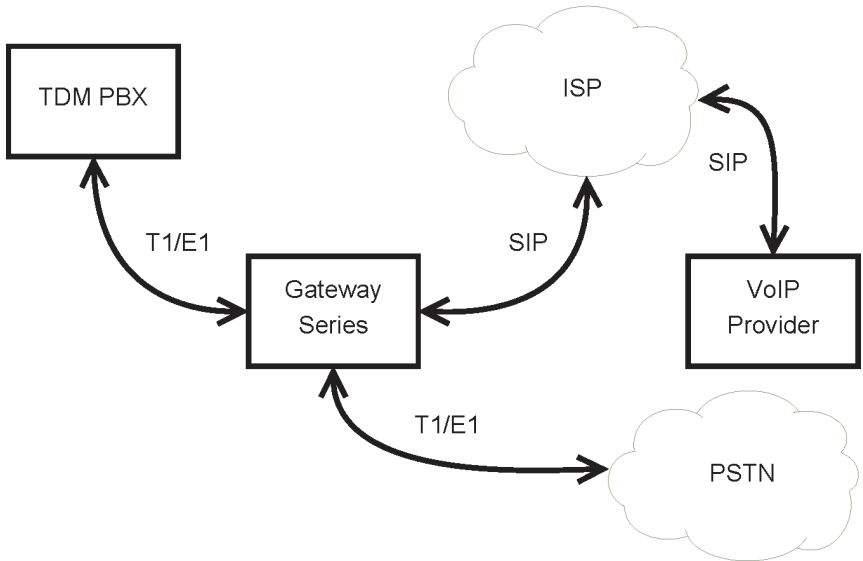

Figure 3: TDM PBX to TDM and VoIP Scenario

Echo-Cancellation

Administrators connecting their Gateway Series appliances to the PSTN or other devices are likely to be placing calls that will result, at some point, in an unbalanced 4-wire/2-wire hybrid. The result of this hybrid is the reflection of a near-end echo to the calling party. Elimination of this echo is the responsibility of echo cancellation.

The Gateway Series appliance utilizes hardware-based voice processors for echo cancellation and codec transcoding. Its hardware echo canceller is designed to handle up to 128ms of echo cancellation across all channels and provides a G.168 compliant echo cancellation solution.

If not explicitly disabled in the Gateway Series web GUI, the hardware-based echo canceller will automatically operate and cancel all network echo within its tail range (1024 taps).

Chapter 2

Unit Installation

This chapter provides the following information:

- **Unpacking the Unit** on page 17
- **Shipment Inspection** on page 18
- **Front Panel Identification** on page 19
- **Unit Identification** on page 23
- **Hardware Installation** on page 24

Note: The Gateway Series appliance installation instructions are written so that they will apply to any model in the series. Examples and model specific information are included as needed.

Unpacking the Unit

When you unpack your unit, carefully inspect it for any damage that may have occurred in shipment. If damage is suspected, file a claim with the carrier and contact the reseller from which the unit was purchased. If the unit was purchased directly from Digium, contact Digium Technical Support at +1 (256)-428-6161. Keep the original shipping container to use for future shipment or proof of damage during shipment.

Note: Only qualified service personnel should install the unit. Users should not attempt to perform this function themselves. The installer must ensure that the equipment is reliably earth grounded in accordance with the National Electrical Code.

Shipment Inspection

The following items are included in shipment of a Gateway Series appliance:

- Gateway Series appliance
- Power cord with attached T1/E1 loopback plug
- Mounting brackets (2 each)
- Bracket mounting screws, #8-32 black truss head, Phillips, 3/16" length (6 each)
- Side-by-side mounting screws, #6-32 pan head, Phillips, 3/16" length (3 each)
- Side-by-side mounting shoulder washers (3 each)
- Rubber feet (4 each)
- Ground nut
- Double-crimp ground ring terminal
- Quickstart Guide

Note: After inspecting the shipment, Digium requires that the appliance be registered for support eligibility. Unregistered appliances are not eligible for Digium support. Please refer to **Free Installation Support** on page 84 for additional information on how to obtain assistance from Digium Technical Support.

Front Panel Identification

This section describes the components on the front panel of the Gateway Series models.



Figure 4: G100 Single Port Appliance



Figure 5: G200 Dual Port Appliance

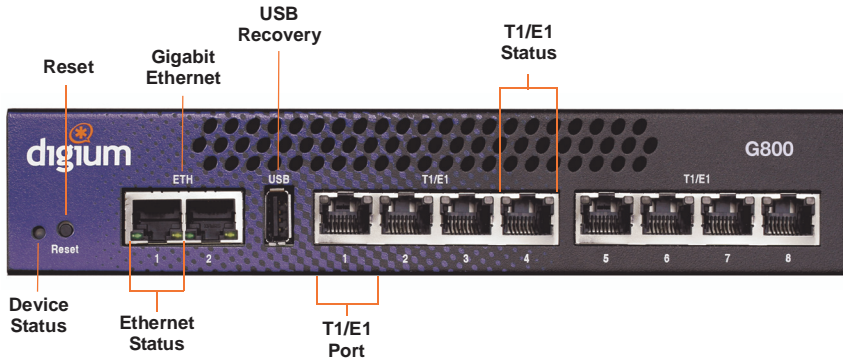

Figure 6: G800 Octal Port Appliance

- **Device Status** - This LED corresponds to the status of the Gateway Series appliance. See **Frequently Asked Questions on page 80** for more information.
- **Gigabit Ethernet** - The 10/100/1000BaseT Ethernet port(s) provides the ability to connect to an internal or external network using an RJ45 interface and supports Auto-MDIX. It is used to pass Ethernet packetized voice and web management data between the Gateway Series and the network. See **Gigabit Ethernet Port Pinouts on page 85** for more information.
- **Second Gigabit Ethernet (G400/G800 only)** - The second 10/100/1000BaseT Ethernet port(s) provides the ability to connect to an internal or external network using an RJ45 interface and supports Auto-MDIX. It is used to pass Ethernet packetized voice and web management data between the **Gateway Series** and the network. See **Gigabit Ethernet Port Pinouts on page 85** for more information.

- **Ethernet Status** - These LEDs correspond to the status of the Ethernet connection. See **Frequently Asked Questions on page 80** for more information.
- **USB Recovery** - This port can be used to perform a firmware recovery and configuration reset. See **Firmware Recovery and Configuration Reset on page 78** for more information.

Warning! The USB Recovery port provides a limited amount of current which is sufficient only to power a USB flash drive. Do not connect any other type of device to this port. The USB flash drive should be fully USB 2.0 compliant.

- **T1/E1 Port(s)** - These ports are used for connecting T1 or E1 cables. See **RJ45 T1/E1 Port Connector on page 86** for more information.
- **T1/E1 Status** - These LEDs correspond to the status of the T1/E1 ports. See **Frequently Asked Questions on page 80** for more information.
- **Reset Switch (G400/G800 only)** - This recessed switch is used to restart the Gateway Series appliance or reset its GUI password. See **Frequently Asked Questions on page 80** for more information.

Unit Identification

The defining characteristic of the Gateway Series models are the number of T1/E1 and Ethernet ports supported. See Table 1 for a list of the various models.

Table 1: Gateway Series Models

Model	Type	T1/E1 Ports	Ethernet Ports
G100	T1/E1	1	1
G200	T1/E1	2	1
G400	T1/E1	4	2
G800	T1/E1	8	2

Hardware Installation

This section describes how to properly install the hardware for a Gateway Series appliance.

**Caution**

Only qualified service personnel should continue with hardware installation and configuration of the Gateway Series appliance. Users should not attempt to perform these functions themselves.

**Caution**

This equipment is intended for use in Restricted Access Areas only where equipotential bonding has been applied.

Grounding

The Gateway Series appliance must be properly earth grounded for safety reasons. If the unit is not properly earth grounded, the unit and/or other equipment connected to the unit could be damaged. If a Gateway Series appliance is damaged while it is improperly grounded, the warranty on the Gateway Series appliance is void.

A ground lug is located on the opposite side from the front panel of a Gateway Series appliance. Attach an appropriate length and gauge of wire to the double-crimp ground ring terminal. The wire length should be as short as possible, and gauge should be 18 AWG or greater. Stranded or solid wire is acceptable. Wire is not provided with the Gateway Series

appliance. Double crimp the ground ring terminal to the wire. Next, slide the ground ring terminal over the ground lug. Then fasten the ground ring terminal to the ground lug using the ground nut. The ground nut must be turned clockwise to tighten it onto the ground lug. The opposite end of the wire that is connected to the ground ring terminal should be securely fastened to an unpainted metallic section of a properly earth grounded equipment rack. A connector for the opposite end of the wire is not provided with the Gateway Series appliance.

Note: Taking into consideration the requirements of all equipment connected to or sharing the rack, the equipment rack should be properly earth grounded. Refer to the manufacturer of the rack for instructions on how to properly earth ground the rack.



Important

Use only a grounded electrical outlet when connecting the Gateway Series appliance to a power source. If you do not know whether the outlet is grounded, consult with a qualified electrician.

Mounting

The included hardware allows the Gateway Series appliance to be wall mounted, rack mounted side-by-side with another Gateway Series appliance, or placed flat on a level surface. If a single Gateway Series appliance is to be rack mounted, the optional long mounting bracket (not supplied, part number 3244-00042) must be used. The optional long mounting bracket can be ordered by contacting a Digium reseller or Digium directly.



Important

Reliable earth grounding of rack-mount equipment should be maintained. Particular attention should be given to provide connection other than direct connections to the branch circuit (e.g., use of power strips).



Important

Mounting of the Gateway Series appliance in a rack should be such that no hazardous condition is achieved due to uneven mechanical loading. Do not place heavy objects on top of the unit, or pull down on the mounted unit. Consider the mechanical loading of external cables. The weight of the cables can pull on the unit and create uneven loading. Secure heavy cables with external cable trays.



Important

If rack mounting, install the Gateway Series appliance in a rack so that the amount of airflow required for safe operation is not compromised.



Important

If the Gateway Series appliance is installed in a system that is in turn installed in a closed or multi-unit rack assembly, the operating ambient temperature of the rack environment may be significantly greater than the room ambient. While the maximum safe operating temperature is 50°C, consideration should be given to installing the unit in an environment compatible with the maximum recommended ambient temperature of 45°C for long term reliability and maximum performance.

Single Unit Rack Mount:

In order to rack mount the Gateway Series appliance by itself, place one of the short mounting brackets on the front of one side of the Gateway Series appliance. Line up the holes from the mounting bracket to the threaded holes on the front side of the Gateway Series appliance. Two #8 black truss head screws should be inserted and turned clockwise to fasten the mounting bracket. Do not over-tighten. Repeat these steps when installing the optional long mounting bracket (not supplied, part number 3244-00042) on the other side of the Gateway Series appliance. Then use another 2 #8 black truss head screws on each mounting bracket to secure the Gateway Series appliance to a rack.

Side-by-side Rack Mount:

In order to rack mount the Gateway Series appliance side-by-side with another Gateway Series appliance, place one of the short mounting brackets on the front of the left side of the first Gateway Series appliance. Line up the holes from the mounting bracket to the threaded holes on the front of the left side of the first Gateway Series appliance. Two #8 black truss head screws should be inserted and turned clockwise to fasten the mounting bracket. Repeat these steps when installing a short mounting bracket on the front of the right side of the second Gateway Series appliance.

Each of the three #6 pan head screws should be inserted into a shoulder washer as shown in Figure 7 on page 29. Make sure the narrow side of the shoulder washer is away from the head of the screw. The three screws should then be inserted and turned clockwise to fasten to the side-by-side holes on the right side of the first Gateway Series appliance. Do not overtighten the screws or the shoulder washers could be damaged. Connect the first and second Gateway Series appliances together by putting the heads of three screws & shoulder washers into the three keyed insets. Then push down on the second Gateway Series appliance as shown in Figure 7. Make sure the units are flat against each other before pushing the second unit down. Otherwise the shoulder washers may be damaged. Use two truss head screws (not supplied) on each mounting bracket to secure both Gateway Series appliances to a rack.

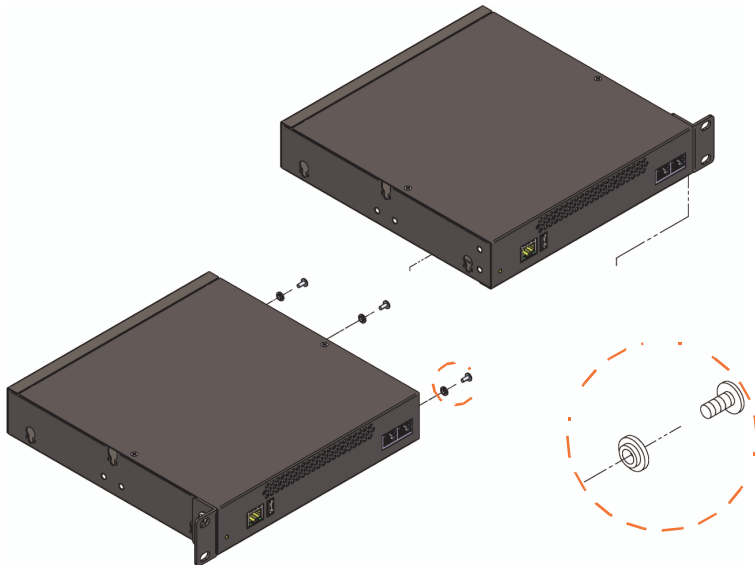

Figure 7: Side-by-side Rack Mounting

Wall Mount:

In order to wall mount the Gateway Series appliance, the short mounting brackets should be flipped and rotated, and fastened on the middle of the right and left sides of the Gateway Series appliance as shown in Figure 8 on page 30. The unit should be mounted at or below eye level to properly view the LEDs. In addition, the Gateway Series appliance should be properly oriented as shown in Figure 8. Orientations other than what is shown in Figure 8 are not acceptable.

If the Gateway Series appliance is placed in the “right side down” orientation, the 2 remaining #8 black truss head mounting screws should be fully inserted into the screw holes near the front of the right side of the Gateway Series appliance. In addition, the three #6 pan head screws should be fully inserted into the side-by-side holes on the right side of the first Gateway Series appliance.

Note: The Gateway Series appliance must be properly grounded for safety reasons. If the unit is not properly grounded, damage could arise to the unit and/or other equipment connected to the unit.

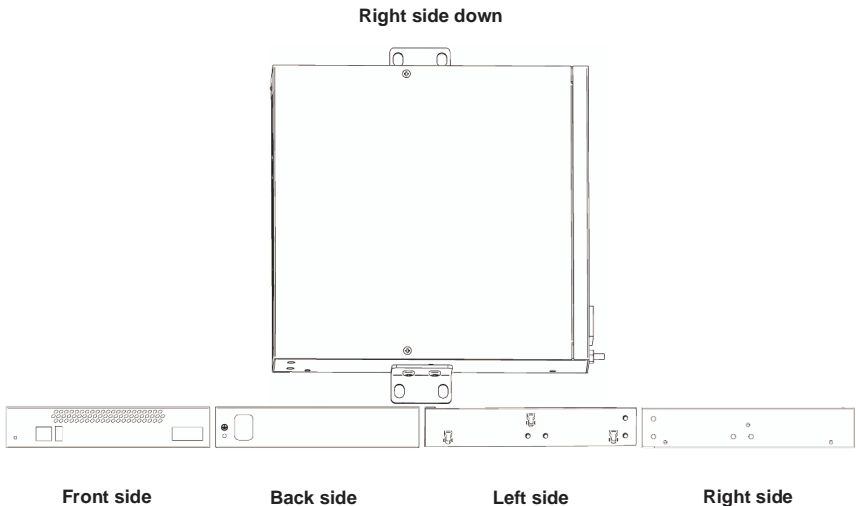

Figure 8: Acceptable Wall Mount Orientation

Level Surface:

In order to place the Gateway Series appliance flat on a level surface, the rubber feet should be adhered to the 4 corners of the bottom of the Gateway Series appliance. This will help secure the Gateway Series appliance to the surface it is placed on.

Note: The Gateway Series appliance must be properly grounded for safety reasons. If the unit is not properly grounded, damage could arise to the unit and/or other equipment connected to the unit.

Connecting Ports

A description of each of the front panel connectors on a Gateway Series appliance is available in the section titled **Front Panel Identification** on page 19. Please refer to that section to determine what should be connected to each connector.



Caution

This unit must be connected to the Telecommunications Network in your country using an approved line cord, e.g.: for Australia use only line cords complying with AS/CA S008:2010.



Caution

Connect only equipment approved for use in your specific country to the telecommunications network voltage circuit ports.

Connections to a Gateway Series appliance should be made in the following order.

1. Gigabit Ethernet Port(s)

Note: (G400/G800 only) Install a ferrite to the Ethernet cable that connects to each Ethernet port to ensure compliance with the EMC standards. An example of a suitable ferrite is part number 28A2025-0A0 from Laird-Signal Integrity Products, available worldwide at www.digikey.com.

2. T1/E1 Port(s)

Note: Use only shielded cables to ensure compliance with the International EMC standards.

3. Power Cord

Connecting to the Gateway Series

The Gateway Series web GUI may be accessed by either its DHCP or statically assigned IP address. The following browsers are supported:

- **Windows XP, Vista, 7:** Chrome 8.0+, Firefox 3.5 - 12.0, Internet Explorer 8.*, Safari 5.0+
- **Mac OS X:** Firefox 3.5 - 12.0, Safari 5.0+
- **Linux:** Firefox 3.5 - 12.0

Connecting via DHCP assigned IP address

1. If a DHCP server exists on the network that the Gateway Series appliance will be placed on, connect one end of an Ethernet cable to the Gateway Series appliance's first Ethernet port, and the other end to an Ethernet connection on a network switch or hub. This step will connect your Gateway Series appliance to your network so that the Gateway Series web GUI may be accessed from your network.
2. Using a Gateway Series supported web browser, open a browser window from a computer on your network and enter the IP address for the Gateway Series appliance using HTTPS (e.g. [https://\[IP\]](https://[IP])). If you do not connect using HTTPS, a browser error will be displayed. The IP address for the Gateway Series web GUI will be assigned by the DHCP server on the network. The DHCP server on the network will need to be accessed to determine the IP address assigned to the

Gateway Series appliance. The default username for the Gateway Series web GUI is **admin**, and the default password is **admin**.

Note: The Gateway Series appliance may also be accessed by its hostname. The hostname will be in the format of *Gx00-aa-bb-cc*, where *x* is 1 for G100, 2 for G200, 4 for G400 or 8 for G800, *aa* is the 6th to last and 5th to last alphanumeric of the unit's first MAC address, *bb* is the 4th to last and 3rd to last alphanumeric of the unit's first MAC address, and *cc* is the 2nd to last and very last alphanumeric of the unit's first MAC address. The MAC addresses of the Gateway Series appliance are printed on a label on the back of the unit. For example, if the first MAC address of a G200 Gateway Series appliance is B2432B187135, the hostname will be G200-18-71-35. HTTPS (e.g. `https://[IP]`) must be used. If you do not connect using HTTPS, a browser error will be displayed.

3. It is highly recommended that the **admin** password be changed using the **System Administrators** menu on the web GUI.
4. Next, the IP configuration options should be configured on the Gateway Series appliance. See **IP Configuration** on page 36.

Connecting via Statically assigned IP address

1. If a DHCP server does not exist on the network that the Gateway Series appliance will be placed on, connect one end of an Ethernet cable to the Gateway Series appliance's first Ethernet port, and the other end to an Ethernet connection on a computer. That computer will need to use the network configuration listed below. This step will

connect your Gateway Series appliance to your computer so that the Gateway Series web GUI may be accessed from your computer.

Network settings for computer connecting to Gateway Series

IP: 192.168.69.2

Netmask: 255.255.255.0

Broadcast: 192.168.69.255

2. Using a Gateway Series supported web browser, open a browser window and enter the IP address for the Gateway Series appliance using HTTPS (e.g. `https://[IP]`). If you do not connect using HTTPS, a browser error will be displayed. The default IP address for the Gateway Series web GUI is **192.168.69.1**. The default username for the Gateway Series web GUI is **admin**, and the default password is **admin**.
3. It is highly recommended that the **admin** password be changed using the **System Administrators** menu on the web GUI.
4. Next, the IP configuration options should be configured on the Gateway Series appliance. See **IP Configuration** on page 36.

IP Configuration

The general networking and configuration server options in the Gateway Series web GUI should be configured before others. The IP configuration menus for the G100 and G200 models differ from those of the G400 and G400 models. The IP configuration menus for each are described below.

Note: Saving changes to the IP configuration requires a restart, resulting in all active calls being dropped. We recommend against making these changes during business hours.

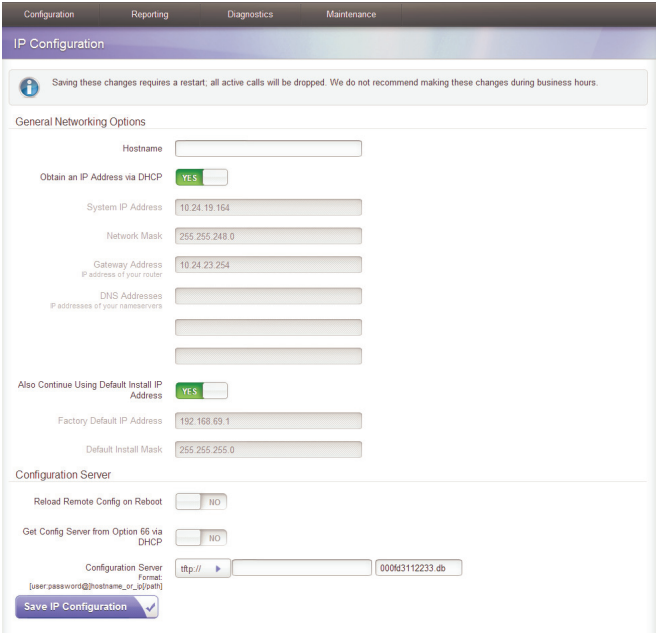

Figure 9: IP Configuration Menu for G100 / G200

The **General Networking Options** for the G100 and G200 models are described below.

- **Hostname** - Specify the hostname of the Gateway Series appliance. If a hostname is specified, the Gx00-aa-bb-cc hostname will no longer be configured.
- **Obtain an IP Address via DHCP** - If a DHCP server exists on the same network as the Gateway Series appliance, this feature may be enabled for the IP address to be dynamically assigned via DHCP.

Note: It is recommended that this feature be disabled if the DHCP server is not configured to always provide the same IP address based on MAC address. If this is the case, the Gateway Series appliance's network settings should be manually configured. The MAC addresses of the Gateway Series appliance are printed on a label on the back of the unit.

- **System IP Address** - If **Obtain an IP Address via DHCP** is disabled, specify the static IP address for the Gateway Series appliance.

Note: If a static IP address is assigned using this feature, the Gateway Series appliance will immediately be unresponsive from its old IP address. It may take up to 15 seconds for the new IP address to be assigned and functional. The new IP address of the Gateway Series appliance must be entered into the browser and HTTPS (e.g. [https://\[IP\]](https://[IP])) must be used. If you do not connect using HTTPS, a browser error will be displayed.

- **Network Mask** - If **Obtain an IP Address via DHCP** is disabled, specify the network mask for the Gateway Series appliance.
- **Gateway Address** - If **Obtain an IP Address via DHCP** is disabled, specify the gateway address for the Gateway Series appliance. The gateway address is usually the address of the router on the network.

- **DNS Addresses** - If **Obtain an IP Address via DHCP** is disabled, specify up to 3 DNS servers to be used by the Gateway Series appliance. A DNS server may also be referred to as a nameserver.
- **Also Continue Using Default Install IP Address** - Leaving this option enabled will allow the Gateway Series appliance to listen for network requests on its factory default IP address.

Note: For security purposes, it is recommended that this feature be disabled after initial IP configuration is complete. After this feature is disabled, the Gateway Series appliance will be accessible only from the IP address that is assigned by the DHCP server or statically configured.

- **Factory Default IP Address** - Displays the factory default IP address assigned to the Gateway Series appliance.
- **Default Install Mask** - Displays the factory default network mask of the Gateway Series appliance.

The Gateway Series appliance is capable of loading its configuration from a configuration server on reboot. This allows Gateway Series appliances to be quickly and easily deployed at multiple locations with minimal interaction from an administrator.

In order to generate a configuration to place on a configuration server, configure a Gateway Series appliance, generate a backup from the web GUI as described in **Backups** on page 73, and place the backup file on the configuration server at the path described below.

Note: The format of the path to the configuration server is *protocol://[user:password@]hostname_or_ip[/path]*. The *protocol* may be either

tftp, ftp, or http. The Gateway Series appliance will request a configuration database with the filename of xxxxxxxxxxxx.tgz, where xxxxxxxxxxxx is the unit's first MAC address, from the configuration server. The MAC addresses of the Gateway Series appliance are printed on a label on the back of the unit. FTP and HTTP normally do not require a username and password.

The **Configuration Server** options for the G100 and G200 models are specified below.

- **Reload Remote Config on Reboot** - Leaving this option enabled will allow the Gateway Series appliance to request that its configuration be reloaded from a configuration server on every reboot.
Note: If this feature will not be used, it is recommended that it be disabled.
- **Get Config Server from Option 66 via DHCP** - If **Obtain an IP Address via DHCP** is enabled and the DHCP server specifies the path and configuration database file on the configuration server using Option 66, this feature may be enabled for all Gateway Series configuration settings to be automatically configured using a configuration server. The **Reload Remote Config on Reboot** option must be enabled in order to activate this feature. Refer to the note on **page 38** for proper syntax when specifying the path and configuration database file.
- **Configuration Server** - If **Obtain an IP Address via DHCP** is enabled and **Get Config Server from Option 66 via DHCP** is disabled, the path to the configuration server may be statically defined using this option. The **Reload Remote Config on Reboot** option must be enabled in order to activate this feature. Refer to the note on **page 38** for proper syntax when specifying the path and configuration database file.

Configuration Reporting Diagnostics Maintenance

IP Configuration

General Networking Options Interface 1 Interface 2

General Networking Options

Hostname

Also Continue Using Default Install IP Address YES
Default IP will be on interface 1.

Factory Default IP Address 192.168.69.1
Default Install Mask 255.255.255.0

DNS Addresses
IP addresses of your nameservers

IP for SSL Certificate
Take the IP address for SSL certificate used to secure the admin interface from the following network interface.

Interface 1

Configuration Server

Reload Remote Config on Reboot NO

Get Config Server from Option 66 via DHCP NO

Configuration Server
Format: [user:password@[hostname_or_ip]]
tftp://

Save IP Configuration

Figure 10: IP Configuration Menu for G400 / G800

The **General Networking Options** for the G400 and G800 models are described below.

- **Hostname** - Specify the hostname of the Gateway Series appliance. If a hostname is specified, the Gx00-aa-bb-cc hostname will no longer be configured.

- **Also Continue Using Default Install IP Address** - Leaving this option enabled will allow the Gateway Series appliance to listen for network requests on its factory default IP address.

Note: For security purposes, it is recommended that this feature be disabled after initial IP configuration is complete. After this feature is disabled, the Gateway Series appliance will be accessible only from the IP address that is assigned by the DHCP server or statically configured.

- **Factory Default IP Address** - Displays the factory default IP address assigned to the Gateway Series appliance. This address is accessible only on the first physical interface for untagged traffic.
- **Default Install Mask** - Displays the factory default network mask of the Gateway Series appliance.
- **DNS Addresses** - Specify up to 3 DNS servers to be used by the Gateway Series appliance. A DNS server may also be referred to as a nameserver.
- **IP for SSL Certificate** - Take the IP address for SSL certificate used to secure the admin interface from a specified Interface #.

The Gateway Series appliance is capable of loading its configuration from a configuration server on reboot. This allows Gateway Series appliances to be quickly and easily deployed at multiple locations with minimal interaction from an administrator.

In order to generate a configuration to place on a configuration server, configure a Gateway Series appliance, generate a backup from the web

GUI as described in **Backups** on page 73, and place the backup file on the configuration server at the path described below.

Note: The format of the path to the configuration server is *protocol://[user:password@]hostname_or_ip[/path]*. The *protocol* may be either **tftp**, **ftp**, or **http**. The Gateway Series appliance will request a configuration database with the filename of xxxxxxxxxxxx.tgz, where xxxxxxxxxxxx is the unit's first MAC address, from the configuration server. The MAC addresses of the Gateway Series appliance are printed on a label on the back of the unit. FTP and HTTP normally do not require a username and password.

The **Configuration Server** options for the G400 and G800 models are specified below.

- **Reload Remote Config on Reboot** - Leaving this option enabled will allow the Gateway Series appliance to request that its configuration be reloaded from a configuration server on every reboot.

Note: If this feature will not be used, it is recommended that it be disabled.

- **Get Config Server from Option 66 via DHCP** - If **Obtain an IP Address via DHCP** is enabled on an Interface tab and a DHCP server specifies the path and configuration database file on the configuration server using Option 66, this feature may be enabled for all Gateway Series configuration settings to be automatically configured using a configuration server. The **Reload Remote Config on Reboot** option must be enabled in order to activate this feature. Refer to the note on **page 38** for proper syntax when specifying the path and configuration database file.

Configuration Server - If **Obtain an IP Address via DHCP** is enabled on an Interface tab and **Get Config Server from Option 66 via DHCP** is disabled, the path to the configuration server may be statically defined using this option. The **Reload Remote Config on Reboot** option must be enabled in order to activate this feature. Refer to the note on **page 38** for proper syntax when specifying the path and configuration database file.

The **Interface** options for the G400 and G800 models are specified below.

- **Enable Untagged Traffic** - If disabled, this option will prevent traffic which is not VLAN tagged from passing over this interface.
- **Obtain an IP Address via DHCP** - If a DHCP server exists on the same network as the Gateway Series appliance, this feature may be enabled for the IP address to be dynamically assigned via DHCP.

Note: It is recommended that this feature be disabled if the DHCP server is not configured to always provide the same IP address based on MAC address. If this is the case, the Gateway Series appliance's network settings should be manually configured. The MAC addresses of the Gateway Series appliance are printed on a label on the back of the unit.

- **System IP Address** - If **Obtain an IP Address via DHCP** is disabled, specify the static IP address for the Gateway Series appliance.

Note: If a static IP address is assigned using this feature, the Gateway Series appliance will immediately be unresponsive from its old IP address. It may take up to 15 seconds for the new IP address to be assigned and functional. The new IP address of the Gateway Series appliance must be entered into the browser and

HTTPS (e.g. `https://[IP]`) must be used. If you do not connect using HTTPS, a browser error will be displayed.

- **Network Mask** - If **Obtain an IP Address via DHCP** is disabled, specify the network mask for the Gateway Series appliance.
- **Gateway Address** - If **Obtain an IP Address via DHCP** is disabled, specify the gateway address for the Gateway Series appliance. The gateway address is usually the address of the router on the network.
- **Static Routes** - This option can be used to force the Gateway Series appliance to use a specific gateway interface to reach specific networks or group of networks.
- **VLAN Networks Enabled** - If enabled, this option allows you to define a VLAN interface to be associated with the physical interface. For each VLAN, you may select the VLAN ID and IP for the VLAN either statically or via DHCP. Each VLAN has all the capabilities available for untagged interfaces. There can be 2 VLANs configured for each physical interface.

Chapter 3

Configuration

The Gateway Series appliances have a variety of configuration options. This chapter provides information on how to use the Gateway Series web GUI to configure an appliance without the need of command-line tools and an overview of the available configuration sections.

Context-sensitive help buttons are provided above most sections of the Gateway Series web GUI. Clicking on a help button will open a new window which contains a detailed description of the options available for that section. The help buttons appear as .

The Gateway Series appliance should already be connected to your network or computer, as described in **Connecting to the Gateway Series** on page 33. Using a Gateway Series supported web browser, open a browser window and enter the IP address for the Gateway Series appliance using HTTPS (e.g. `https://[IP]`). If you do not connect using HTTPS, a browser error will be displayed. The login screen will be displayed. An administrator username and password must be entered to proceed. The default username for the Gateway Series web GUI is **admin**, and the default password is **admin**.



Figure 11: Login Screen

It is highly recommended that the **admin** password be changed using the **System Administrators** menu on the web GUI. In addition, it is highly recommended that the software on a Gateway Series appliance be updated to the latest version before proceeding with configuration. See **Software Updates** on page 74.

The Gateway Series web GUI is divided into the following main sections.

- **Settings and Configuration** on page 49
- **Logging and Reporting** on page 65
- **Status and Diagnostics** on page 66
- **Maintenance** on page 72

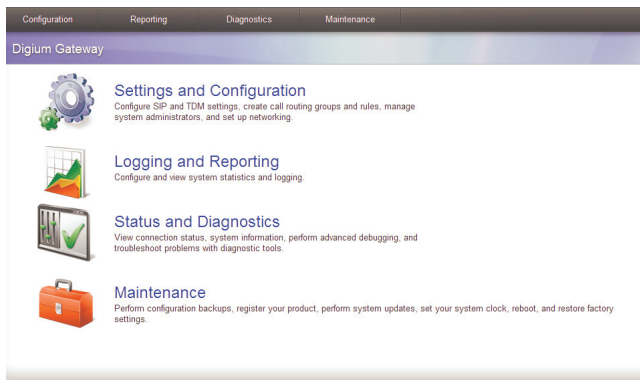

Figure 12: Main Menu

Settings and Configuration

This section provides the ability to configure SIP and TDM settings, create call routing groups and rules, manage system administrators, and set up networking. Included are the following sections.

- **SIP Endpoints** on page 50
- **Global SIP Settings** on page 53
- **T1/E1** on page 56
- **Call Routing Groups** on page 59
- **Call Routing Rules** on page 60

SIP Endpoints

This section provides the ability to add and modify SIP endpoints, and configure call, media, and fax settings. A SIP endpoint will typically be a SIP PBX or SIP provider connected to the Gateway Series appliance. Included are the following sections.

- **Main** - Primary options for SIP endpoint configuration. The following settings are available.
 - Enable Advanced Options
 - Name
 - Username
 - Password
 - Registration
 - Destination Number
 - Hostname or IP address
 - Use UDP
 - Use TCP
 - NAT Traversal
 - Authentication User
 - From User
 - From Domain
 - Remote Secret
 - Port
 - Qualify
 - Qualify Frequency
- **Call Settings (Advanced)** - DTMF, Caller ID, signaling, authentication, and advanced timer settings. The following settings are available.

- DTMF Mode
- Trust Remote-Party-ID
- Send Remote-Party-ID
- Caller ID Presentation
- Progress Inband
- Allow Overlap Dialing
- Append user=phone to URI
- Add Q.850 Reason Headers
- Honor SDP Version
- Allow Transfers
- Authenticate Incoming Calls
- Allow Promiscuous Redirects
- Max Forwards
- Send TRYING on REGISTER
- Outbound Proxy
- Default T1 Timer
- Call Setup Timer
- Session Timers
- Minimum Session Refresh Interval
- Maximum Session Refresh Interval
- Session Refresher
- **Media Settings (Advanced)** - Media types and priorities, codecs settings. The following settings are available.
 - ULAW
 - ALAW
 - G.722

- G.726
- G.729
- GSM
- Codec Priority
- ALAW Packetization Rate
- ULAW Packetization Rate
- GSM Packetization Rate
- G.722 Packetization Rate
- G.726 Packetization Rate
- G.726 Nonstandard
- G.729 Packetization Rate
- Use Preferred Codec Only
- **Fax Settings (Advanced)** - Fax related settings. The following settings are available.
 - Fax Mode
 - T.38 Error Correction
 - Enable Error Correction Mode
 - Force Local TCF Mode

Global SIP Settings

This section provides the ability to add and modify global SIP settings. These settings are for experienced administrators only. Please take care when modifying any of these settings. The default values should be sufficient for most applications. Included are the following sections.

- **Networking** - General, NAT, RTP, RTCP, and DTMF settings. The following settings are available.
 - UDP Bind Port
 - Enable TCP
 - TCP Bind Port
 - TCP Authentication Timeout
 - TCP Authentication Limit
 - Enable Hostname Lookup
 - Local Network
 - Local Network List
 - Subscribe Network Change Event
 - Match External Address Locally
 - Dynamic Exclude Static
 - Externally Mapped TCP Port
 - External Hostname
 - Hostname Refresh Interval
 - Start of RTP Port Range
 - End of RTP Port Range
- **Parsing and Compatibility** - General, SIP methods, Caller ID, timer configuration, and outbound registrations. The following settings are available.
 - Strict RFC Interpretation

- Send Compact Headers
- SDP Owner
- Disallowed SIP Methods
- Shrink Caller ID
- Maximum Registration Expiry
- Minimum Registration Expiry
- Default Registration Expiry
- Registration Timeout
- Number of Registration Attempts
- **Security** - SIP domains and authentication settings. The following settings are available.
 - Match Auth Username
 - Realm
 - Use Domain as Realm
 - Always Auth Reject
 - Authenticate Options Requests
- **Media** - ISDN media, QOS/TOS settings. The following settings are available.
 - Premature Media
 - TOS for SIP Packets
 - TOS for RTP Packets
- **Fax** - Fax related settings. The following settings are available.
 - UDPTL Start of Port Range
 - UDPTL End of Port Range
 - Enable UDPTL Checksums
 - UDPTL FEC Entries

- UDPTL FEC Span
- Use Only Even Numbered Ports

T1/E1

This section provides the ability to configure the T1/E1 hardware in the Gateway Series appliance. Included are the following sections.

- **General** - General options for T1/E1 configuration. The following settings are available.
 - Locale
 - Use Internal Timing
 - System Timing
- **Port #** - Port specific options for interface type and signaling. The following settings are available.
 - Interface Type
 - Description
 - Framing
 - Coding
 - Line Build-Out
 - CRC4
 - Echo Cancellation
 - RX Gain
 - TX Gain
 - Line Signaling
 - Channel Summary
 - Signaling Role
 - Switchtype
 - Q.SIG Channel Mapping
 - Enable Caller ID
 - PRI Dial Plan for Dialed Number

- PRI Dial Plan for Dialing Number
- International Prefix
- National Prefix
- Local Prefix
- Private Prefix
- Unknown Prefix
- Network Specific Facility (NSF) Messages
- Idle Bearer Reset
- Idle Bearer Reset Period
- Overlap Dialing
- Allow Progress When Call Released
- Out-of-Band Indications
- Facility-based ISDN Supplementary Services
- Exclusive Channel Selection
- Outbound Channel Selection
- Ignore Remote Hold Indications
- Block Outbound Caller ID Name
- Wait for Caller ID Name
- Layer 2 Outstanding Unacknowledged I-Frames - K
- Layer 2 Number of Frame Retransmissions - N200
- Layer 2 Frame Retransmission Time - T200
- Layer 2 Time Without Frame Exchange - T203
- Disconnect Acknowledge - T305
- Release Acknowledge - T308
- Enable Maintain Calls on Layer 2 Disconnection
- Maintain Calls on Layer 2 Disconnection - T309

- Connect Acknowledge - T313
- Answer on Polarity Switch
- Hangup on Polarity Switch
- Polarity on Answer Delay
- Pre-Wink Time
- Wink Time
- Start Time
- Receiver Wink Time
- Pre-Flash Time
- Flash Time
- Receiver Flash Time
- De-Bounce Timing

Call Routing Groups

This section provides the ability to add and modify SIP and T1/E1 call routing groups. A call routing group allows a group of channels to be addressed when creating a call routing rule. The following settings are available.

- Group Type
- Group Name

Call Routing Rules

This section provides the ability to add and modify call routing rules. A call routing rule determines how a call is handled based upon certain characteristics such as inbound channel and DID. It is also possible to manipulate matched numbers before connecting outbound calls. The following settings are available.

- Simple Entry Mode
- Name
- Call Comes in From
- Match All Calls
- Before connecting the call, trim X digits from the front and then prepend the digits Y to the number
- Set the Caller ID Name to
- Set the Caller ID Number to
- Send Call Through
- Failover Call Through Number #

System Administrators

This section provides the ability to add and modify system administrators for access to the Gateway Series web GUI. The following settings are available.

- Full Name
- Username
- Email Address
- Password
- Password Confirmation
- Language

IP Configuration

This section provides the ability to configure IP options for the Gateway Series appliance. See **IP Configuration** on page 36 for more information. The following settings are available.

- Hostname
- Obtain an IP Address via DHCP
- System IP Address
- Network Mask
- Gateway Address
- DNS Addresses
- Also Continue Using Default Install IP Address
- Reload Remote Config on Reboot
- Get Config Server from Option 66 via DHCP
- Configuration Server Format
- IP for SSL Certificate (G400 / G800 only)
- Enable Untagged Traffic (G400 / G800 only)
- Static Routes (G400 / G800 only)
- VLAN Networks Enabled (G400 / G800 only)

HTTPS

This section provides the ability to supply your own certificate for secure connection to the Gateway Series web GUI. A self-signed certificate is provided by default. The following settings are available.

- X.509 Certificate in PEM Format
- RSA Private Key in PEM Format
- Intermediate CA Certificate in PEM Format

Access Control

This section provides the ability to limit access to the web GUI and SIP traffic through the Gateway Series appliance. All other protocols are blocked. The following settings are available.

- Rule Name
- Network
- Allow Admin Web Interface
- Allow SIP

Logging and Reporting

This section provides the ability to configure and view system statistics and logging of the Gateway Series appliance. Included are the following sections.

- **Statistics** - Displays statistics for active calls and calls processed, and displays a summary of active calls in progress
- **Remote Log** - Settings for system logging via Syslog. The following settings are available.
 - Enable Remote Logging
 - Remote Server Hostname
 - Remote Server Port
 - Enable Advanced Settings
 - Kernel Log
 - System Log
 - Syslog Facility
 - Gateway Log Level
 - Gateway Debug Level
 - PRI Debug
 - SIP Debug
 - DTMF Debug

Status and Diagnostics

This section provides the ability to view connection status, system information, perform advanced debugging, and troubleshoot problems with diagnostic tools. Included are the following sections.

- **Connection Status** on page 67
- **System Information** on page 68
- **Diagnostic Tests** on page 69
- **Advanced Debugging** on page 70
- **Technical Support** on page 71

Connection Status

This section provides the ability to view the connection status of network interfaces, SIP endpoints, and T1/E1 interfaces. Included are the following sections.

- **Network** - Status of network interfaces
- **SIP Endpoints** - Status of SIP endpoints
- **T1/E1 Interfaces** - Status of T1/E1 interfaces per port

System Information

This section provides the ability to view system information on the Gateway Series appliance, including model number, software version, MAC addresses, uptime, system time, and system temperature.

Diagnostic Tests

This section provides the ability to test the operation of the Gateway Series appliance. For example, the loopback test will run a pattern loop test to verify the integrity of a T1/E1 port. See Chapter 4—“Troubleshooting” for more details. The following settings are available.

- Run Port Loopback Test
- Test Port #

Advanced Debugging

This section provides the ability to record and download debug logs for troubleshooting. Included are the following sections.

- **Debugging Sessions in Progress** - Displays existing logs or recording sessions in progress
- **Start a New Debugging Session** - TCP traffic, gateway logging, and system logging settings for starting a new debugging session. The following settings are available.
 - TCP Traffic
 - Capture Only SIP Packets
 - Length of TCP Packet Capture
 - Gateway Log
 - Gateway Log Length
 - Debug Level
 - SIP Debug
 - DTMF Debug
 - PRI Debug
 - PRI Debug Level
 - Capture Port #
 - System Log
 - System Log Length

Technical Support

This section provides the ability to enable remote access for Digium Support Personnel to access the Gateway Series appliance for support purposes. The following settings are available.

- Change Remote Access Status to
- Username
- Password
- Shell Access Port
- Administration Interface Port

Maintenance

This section provides the ability to perform configuration backups, perform system updates, set the system clock, reboot, and restore factory settings. Included are the following sections.

- **Backups** on page 73
- **Software Updates** on page 74
- **System Clock** on page 75
- **System Reset** on page 76

Backups

This section provides the ability to create and restore a backup. Included are the following sections.

- **Download Backup** - Download a backup in database format
Note: At least one configuration change must be made before a backup can be generated and downloaded. In order to revert to the stock configuration, the factory reset feature referenced in the section titled **System Reset** on page 76 may be used.
- **Restore a Backup** - Restore a backup in database format

Software Updates

This section provides the ability to perform a software update for the Gateway Series appliance.

If the Gateway Series appliance is connected to the Internet, you will be prompted if there is a newer version of the software available, and offered to automatically download and install it. Depending on the speed of your Internet connection, it may take a few minutes to complete downloading. The software update will take about 10 minutes to complete.

If the Gateway Series appliance is not connected to the Internet, the latest software can be obtained at

<http://downloads.digium.com/pub/telephony/gateway/firmware/>. Save the firmware file to your desktop. Then manually install it from the Software Updates section.

Note: While many software versions may be available on Digium's website, it is recommended to install only the latest version of the software.

System Clock

This section provides the ability to set the system clock on the Gateway Series appliance and to sync it against a network time server. The following settings are available.

- Timezone
- Time Set Method
- Manually Set the Date and Time
- NTP Server

System Reset

This section provides the ability to perform a system reboot, system shutdown, or factory reset of the Gateway Series appliance.

A system shutdown will drop all current calls and cause the Gateway Series appliance to become unreachable by any method except physical access.

Note: (G100 / G200 only) The system shutdown feature should be used only to temporarily shut down a Gateway Series appliance before physically removing power. Power needs to be physically removed from the Gateway Series appliance within 2 minutes. Otherwise, the Gateway Series appliance will automatically reboot.

Chapter 4

Troubleshooting

This chapter provides information regarding troubleshooting tools, frequently asked questions, and possible resolutions as identified by Digium Technical Support. Multiple resources are available to obtain more information about Asterisk and Digium products. Please visit both www.digium.com and www.asterisk.org for more information.

Firmware Recovery and Configuration Reset

If a Gateway Series appliance is behaving unexpectedly or the password is forgotten, a firmware recovery may need to be performed. The USB Recovery port can be used to perform a firmware recovery using a recovery image. The recovery image reformats the Gateway Series' root filesystem and reloads the appropriate software on it. It will also overwrite the configuration database, returning the Gateway Series appliance to its default configuration.

Note: It is highly recommended to use an image that is equal or greater in version than the firmware that is currently installed on the Gateway Series appliance.

Every Gateway Series firmware release will include a recovery image. The recovery image is located inside of a compressed zip file which can be downloaded from <http://downloads.digium.com/pub/telephony/gateway/recovery/>. After downloading the recovery image, the contents of the compressed zip file must be extracted and copied to the root (i.e. parent) directory of an **empty** USB flash drive.

Note: A USB flash drive is not provided with a Gateway Series appliance. It must be purchased separately. The USB flash drive should be at least 2GB in size and formatted with the FAT32 filesystem.

Note: Some decompression utilities will create a new directory in which to place extracted files. If your decompression utility functions in that way, be certain to copy the contents from that new directory to the root (i.e. parent) directory of an **empty** USB flash drive. Any new directory created by a decompression utility should not be copied.

Next, power off the Gateway Series appliance.

Note: For hardware revisions A3 and earlier, the Gateway Series appliance must remain powered off for 60 seconds in order to guarantee proper startup. See the label on the back of the Gateway Series appliance to determine the hardware revision.

Then insert the USB flash drive into the USB Recovery port. Power on the Gateway Series appliance. The Gateway Series appliance will boot from the USB Recovery port and process the recovery image which was placed on the USB flash drive.

Warning! Do not disconnect power during this process. The recovery process will take at least 3 minutes to complete.

During this process, the Device Status LED will turn red for a fraction of a second. Then it will turn amber for less than a minute. Next, it will run red for about 2 minutes. Lastly, the Device Status LED will remain off. At this point, it is safe to power off the Gateway Series appliance. Remove the USB flash drive and power cycle the Gateway Series appliance.

Frequently Asked Questions

What do the colors of the *Device Status* LED indicate?

- **Steady Red** - Hardware is initializing.
- **Blinking Red** - A software package is being evaluated for validity.
- **Steady Amber** - Software is initializing. Hardware is initialized.
- **Steady Green** - Hardware and software are fully initialized and running.

What do the colors of the *Ethernet Status* LEDs indicate?

- **Steady Green (left side)** - Active Link
- **Blinking Amber (right side)** - Network activity

What do the colors of the *T1/E1 Status* LEDs indicate?

- **Steady Green (right side)** - Appliance is in-sync with the far end.
- **Steady Yellow (right side)** - Appliance is synchronizing or is receiving a yellow alarm from the far end.
- **Blinking Red (right side)** - It is normal for this LED to constantly blink as long as the Gateway Series Appliance is powered on.
- **Singular Blinking Green (right side)** - Line has been placed into loopback mode.
- **Steady Blue (left side, G100 / G200 only)** - T1/E1 software driver is initialized, but configuration is invalid.
- **All Off** - T1/E1 software driver is not initialized.

What type of cable do I need for the T1/E1 ports on a Gateway Series appliance?

A straight-through RJ45 T1/E1 cable is needed for connecting to the RJ45 ports on a Gateway Series appliance when connecting to the PSTN. If connecting to a TDM PBX, a crossover RJ45 T1/E1 cable may be required. Use only shielded cables to ensure compliance with the International EMC standards. The appropriate cables may be ordered from Digium by visiting www.digium.com. Refer to Table A-2 on page 86 for pin assignments.

How can the Gateway Series software be reinitialized without modifying any configuration settings?

The Gateway Series software can be reinitialized without modifying any configuration settings by following the steps described below.

1. Press the reset switch once.
2. The status LED will flash amber for 5 seconds.
3. The status LED will flash red for 2 seconds, acknowledging the reinitialization request.
4. The Gateway Series appliance will restart itself.
5. The status LED will turn green once the reinitialization is complete.

How can the Gateway Series GUI password be reset to its default without modifying any configuration settings?

The Gateway Series GUI password can be reset to its default without modifying any configuration settings by following the steps described below.

1. Press the reset switch once.
2. The status LED will start flashing amber.
3. Press the reset switch again while the status LED flashes amber.
4. The status LED will flash green for 2 seconds, acknowledging the reset password request.
5. The password is set back to its default (i.e. “admin”).

There is a slight echo. How can I adjust the sound quality?

First, verify that the *Echo Cancellation* option under the *Port #* menu of *T1/E1 Settings* is enabled. If it is not, enable it. If echo persists, adjust the *RX Gain* and *TX Gain* options on the same menu. For the gain options, it is recommended to shift only between values of -5 and 5.

How is the loopback test useful for troubleshooting?

The loopback test verifies the integrity of the data being transmitted and received on the T1/E1 port by sending a pattern out of the T1/E1 transfer pins and expecting to see the same pattern come back on the receive pins. This test requires that the T1/E1 port be disconnected from any external device and a loopback connector be inserted to the port. A loopback connector has pin 1 looped to pin 4, and pin 2 looped to pin 5.

Where can I find answers to additional questions?

Digium Technical Support (+1 256-428-6161), or Toll Free in the U.S. (+1 877-344-4861), is available 7am-8pm Central Time (GMT -6), Monday - Friday. Please refer to **Free Installation Support** on page 84 for additional information on how to obtain assistance from Digium Technical Support.

Free Installation Support

Digium hardware products include free installation support. In order to receive this support, register your Digium product using the serial number located on the serialization label of your Digium unit.

Steps to receive installation support:

1. Record your product serial number.
2. Register your product at <http://www.digium.com/register>.
3. E-mail Digium Support via support@digium.com, or telephone via +1 (256)-428-6000 or Toll-Free +1 (877)-DIGIUM-1.

Note: Digium does not provide support for unregistered products.

Appendix A

Pin Assignments

All RJ45 (8P8C) ports labeled *ETH* on the Gateway Series appliance are 8-pin. The pin assignments are identified in Table A-1.

Note: Category 5e or Category 6 cables are required for Gigabit (1Gbps) operation up to 100 meters. Category 5 cables will work for short runs, but the link speed may be limited over long distances.

Table A-1: Gigabit Ethernet Port Pinouts

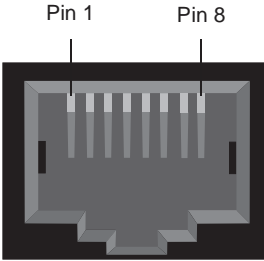
Diagram	Pin	Description
	1	Bi-directional pair A+
	2	Bi-directional pair A-
	3	Bi-directional pair B+
	4	Bi-directional pair C+
	5	Bi-directional pair C-
	6	Bi-directional pair B-
	7	Bi-directional pair D+
	8	Bi-directional pair D-

All RJ45 (8P8C) ports labeled *T1/E1* on the Gateway Series appliance are 8-pin. RJ45 jacks are also commonly referred to as RJ48 when used for telecommunication. The pin assignments are identified in Table A-2.

Table A-2: RJ45 T1/E1 Port Connector

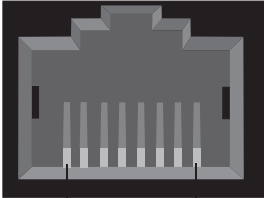
	Pin	Description
 <p data-bbox="153 783 203 807">Pin 8</p> <p data-bbox="285 783 335 807">Pin 1</p>	1	Rx Ring
	2	Rx Tip
	3	Unused
	4	Tx Ring
	5	Tx Tip
	6	Unused
	7	Unused
	8	Unused

Appendix B

Specifications

This appendix provides specifications, required environmental conditions, and maximum power consumption for the Gateway Series appliances.

Physical (All Units).

Size: 8.6" × 9.0" × 1.72" (21.84 x 22.86 x 4.37 cm)
Weight: 2 lbs 12 oz (1,247.38 gm)

Interfaces.

Local Loop Access: E1, T1, PRI; RJ45 (A.K.A RJ48)
USB: Standard Type A Receptacle
Ethernet Access: 10/100/1000base-T; RJ45
Power: Standard 3-pin IEC320-C13

Environment.

Temperature: 0 to 50° C (32 to 122° F) operation
-20 to 70° C (4 to 158° F) storage
Humidity: 0 to 90% non-condensing

Power Requirements.

Voltage: 100-240VAC, 50/60Hz
Current: For G100/G200, 0.5A maximum, 67mA@120V or 33mA@240V typical. For G400/G800, 0.5A maximum, 110mA@120V or 55mA@240V typical.

Power: For G100/G200, 10W maximum, 7.5W typical. For G400/G800, 15W maximum, 12W typical.

Appendix C

Glossary and Acronyms

8P8C *8 position 8 conductor*

Module connector commonly used to terminate twisted pair.

ANSI *American National Standards Institute*

An organization which proposes and establishes standards for international communications.

asynchronous

Not synchronized; not timed to an outside clock source. Transmission is controlled by start bits at the beginning and stop bits at the end of each character. Asynchronous communications are often found in internet access and remote office applications.

attenuation

The dissipation of a transmitted signal's power as it travels over a wire.

bandwidth

The capacity to carry traffic. Higher bandwidth indicates the ability to transfer more data in a given time period.

bit

The smallest element of information in a digital system. A bit can be either a zero or a one.

bps *bits per second*

A measurement of transmission speed across a data connection.

BRI

Basic Rate ISDN

broadband

Broadband transmission shares the bandwidth of a particular medium (copper or fiber optic) to integrate multiple signals. The channels take up different frequencies on the cable, integrating voice, data, and video over one line.

channel

A generic term for an individual data stream. Service providers can use multiplexing techniques to transmit multiple channels over a common medium.

Cat5

Twisted pair cable for carrying signals for 10/100 Ethernet, telephony, and video. Cat5 was superseded by Cat5e.

Cat5e

Twisted pair cable for carrying signals for Gigabit Ethernet, telephony, and video.

CLEC *Competitive Local Exchange Carrier*

A term for telephone companies established after the Telecommunications Act of 1996 deregulated the LECs. CLECs compete with ILECs to offer local service. See also *LEC* and *ILEC*.

CO *Central Office*

The CO houses local switching equipment. All local access lines in a particular geographic area terminate at this facility (which is usually owned and operated by an ILEC).

CPE *Customer Premises Equipment*

Terminal equipment which is connected to the telecommunications network and which resides within the home or office of the customer. This includes telephones, modems, terminals, routers, and television set-top boxes.

DAHDI *Digium Asterisk Hardware Device Interface*

A telephony project dedicated to implementing a reasonable and affordable computer telephony platform into the world marketplace. In addition, the collective name for the Digium-provided drivers for Digium telephony interface products.

DS0 *Digital Signal, Level 0*

A voice grade channel of 64 kbps. The worldwide standard speed for digitizing voice conversation using PCM (Pulse Code Modulation).

DS1 *Digital Signal, Level 1*

1.544 Mbps in North America (T1) and Japan (J1) -up to 24 voice channels (DS0s), 2.048 Mbps in Europe (E1) - up to 32 voice channels (DS0s). DS1/T1/E1 lines are part of the PSTN.

DS3 *Digital Signal, Level 3*

T3 in North America and Japan, E3 in Europe. Up to 672 voice channels (DS0s). DS3/T3/E3 lines are not part of the PSTN.

DTMF *Dual Tone Multi-Frequency*

Push-button or touch tone dialing.

E1

The European equivalent of North American T1, transmits data at 2.048 Mbps, up to 32 channels (DS0s).

E3

The European equivalent of North American T3, transmits data at 34.368 Mbps, up to 512 channels (DS0s). Equivalent to 16 E1 lines.

EMI *Electromagnetic Interference*

Unwanted electrical noise.

full duplex

Data transmission in two directions simultaneously.

FXO *Foreign Exchange Office*

Receives the ringing voltage from an FXS device. Outside lines are connected to FXO ports.

FXS *Foreign Exchange Station*

Initiates and sends ringing voltage. Phones are connected to FXS ports.

G.711

A recommendation by the Telecommunication Standardization Sector (ITU-T) for an algorithm designed to transmit and receive mulaw PCM voice and A-law at a digital bit rate of 64 kbps.

G.723.1

A recommendation by the Telecommunication Standardization Sector (ITU-T) for an algorithm designed to transmit and receive audio at 6.3 kbps or 5.3 kbps.

G.729a

A recommendation by the Telecommunication Standardization Sector (ITU-T) for an algorithm designed to transmit and receive audio at 8 kbps.

H.323

A recommendation by the Telecommunication Standardization Sector (ITU-T) for multimedia communications over packet-based networks.

HDLC *High-Level Data Link Control*

A bit-oriented synchronous data link layer protocol developed by the International Organization for Standardization (ISO).

IAX *Inter-Asterisk eXchange*

The native VoIP protocol used by Asterisk. It is an IETF standard used to enable VoIP connections between Asterisk servers, and between servers and clients that also use the IAX protocol.

iLBC *internet Low Bitrate Codec*

A free speech codec used for voice over IP. It is designed for narrow band speech with a payload bitrate of 13.33 kbps (frame length = 30ms) and 15.2 kbps (frame length = 20ms).

ILEC *Incumbent Local Exchange Carrier*

The LECs that were the original carriers in the market prior to the entry of competition and therefore have the dominant position in the market.

interface

A point of contact between two systems, networks, or devices.

ISO *International Standards Organization*

IVR *Interactive Voice Menu*

An interactive technology that allows a telephone system to detect voice and keypad input.

LED *Light-emitting Diode*

Linux

A robust, feature-packed open source operating system based on Unix that remains freely available on the internet. It boasts dependability and offers a wide range of compatibility with hardware and software. Asterisk is supported exclusively on Linux.

loopback

A state in which the transmit signal is reversed back as the receive signal, typically by a far end network element.

MGCP *Media Gateway Control Protocol*

multiplexing

Transmitting multiple signals over a single line or channel. FDM (frequency division multiplexing) and TDM (time division multiplexing) are the two most common methods. FDM separates signals by dividing the data onto different carrier frequencies, and TDM separates signals by interleaving bits one after the other.

mux *multiplexer*

A device which transmits multiple signals over a single communications line or channel. See multiplexing.

node

A terminal in a computer network.

NT *Network Termination*

A device connecting the customer's telephone or data equipment to the local ISDN exchange carrier's line. NT devices are connected to TE devices.

PBX *Private Branch Exchange*

A smaller version of a phone company's large central switching office. Example: Asterisk.

PCI *peripheral component interconnect*

A standard bus used in most computers to connect peripheral devices.

POP *Point of Presence*

The physical connection point between a network and a telephone network. A POP is usually a network node serving as the equivalent of a CO to a network service provider or an interexchange carrier.

POTS *Plain Old Telephone Service*

The public switched telephone network (PSTN) is the network of the world's public circuit-switched telephone networks. Originally a network of fixed-line analog telephone systems, the PSTN is now almost entirely digital, and now includes mobile as well as fixed telephones.

PPP *Point-to-Point Protocol*

Type of communications link that connects a single device to another single device, such as a remote terminal to a host computer.

PRI

Primary Rate ISDN

PSTN *Public Switched Telephone Network*

A communications network which uses telephones to establish connections between two points. Also referred to as the dial network.

PTMP *Point-to-Multipoint*

A connection where data is broadcast between more than two endpoints.

PTP *Point-to-Point*

A connection restricted to two endpoints.

PTT *Post, Telegraph, and Telephone*

The government agencies in many countries that traditionally operated and monopolized the public postal, telegraph, and telephone services.

QoS *Quality of Service*

A set of quality requirements for telephone service.

RBOC *Regional Bell Operating Companies*

The creation of Regional Bell Operating Companies were a result of AT&T's telephone monopoly being broken up in 1983.

REN *Ringer Equivalence Number*

An arbitrary value which denotes the electrical load a telephone ringer has on a line.

RJ11

A six-pin jack typically used for connecting telephones, modems, and fax machines in residential and business settings to PBX or the local telephone CO.

RJ45

8P8C, un-keyed modular connector type for Ethernet over twisted pair. Predominantly used in LAN and uses Unshielded Twisted Pair cable.

RJ48

8P8C modular connector type for T1 and ISDN termination over twisted pair. While RJ45 and RJ48 use the same connector, they differ in their wiring. RJ48 is commonly seen on T1 lines and uses Shielded Twisted Pair cable.

SIP *Session Initiation Protocol*

An IETF standard for setting up sessions between one or more clients. It is currently the leading signaling protocol for Voice over IP, gradually replacing H.323.

T1

A dedicated digital carrier facility which transmits up to 24 voice channels (DS0s) and transmits data at 1.544 Mbps. Commonly used to carry traffic to and from private business networks and ISPs.

T3

A dedicated digital carrier facility which consists of 28 T1 lines and transmits data at 44.736 Mbps. Equivalent to 672 voice channels (DS0s).

TDM *Time Division Multiplexer*

A device that supports simultaneous transmission of multiple data streams into a single high-speed data stream. TDM combines signals by interleaving bits one after the other.

TE *Terminal Equipment*

A device that is established as a point of termination of a communications circuit or channel. Terminal equipment comprises all customer premises equipment (CPE). TE devices are connected to NT devices.

telco

A generic name which refers to the telephone companies throughout the world, including RBOCs, LECs, and PTTs.

tip and ring

The standard termination on the two conductors of a telephone circuit; named after the physical appearance of the contact areas on the jack plug.

twisted pair

Two copper wires commonly used for telephony and data communications. The wires are wrapped loosely around each other to minimize radio frequency interference or interference from other pairs in the same bundle.

USB *Universal Serial Bus*

Industry standard defining communication protocols, cables, and connectors used in a bus for connection, communication, and power between electronic devices and computers.

V *Volts*

VoIP *Voice over Internet Protocol*

Technology used for transmitting voice traffic over a data network using the Internet Protocol.