

**EPSON®**

WIRELESS PRINT SERVER

**EpsonNet 802.11b**

# **User's Guide**

## Copyright Notice

All rights reserved. No part of this publication may be reproduced, stored in a retrieval system, or transmitted in any form or by any means, electronic, mechanical, photocopying, recording, or otherwise, without the prior written permission of SEIKO EPSON CORPORATION. The information contained herein is designed only for use with this EPSON product. EPSON is not responsible for any use of this information as applied to other products.

Neither SEIKO EPSON CORPORATION nor its affiliates shall be liable to the purchaser of this product or third parties for damages, losses, costs, or expenses incurred by purchaser or third parties as a result of: accident, misuse, or abuse of this product or unauthorized modifications, repairs, or alterations to this product, or (excluding the U.S.) failure to strictly comply with SEIKO EPSON CORPORATION's operating and maintenance instructions.

SEIKO EPSON CORPORATION shall not be liable for any damages or problems arising from the use of any options or any consumable products other than those designated as Original EPSON Products or EPSON Approved Products by SEIKO EPSON CORPORATION.

## Trademarks

EPSON and EPSON Stylus are registered trademarks of SEIKO EPSON CORPORATION.

EPSON Connection and EPSON Store are service marks of Epson America, Inc.

General Notice: Other product names used herein are for identification purposes only and may be trademarks of their respective owners. EPSON disclaims any and all rights in those marks.

The ENERGY STAR emblem does not represent EPA endorsement of any product or service.



Printed on recycled paper

# Contents

<b>INTRODUCTION</b> .....	<b>1</b>
Wireless Networking .....	<b>2</b>
Windows System Requirements .....	<b>4</b>
Macintosh System Requirements .....	<b>5</b>
Where To Get Information .....	<b>6</b>
<b>SETTING UP YOUR PRINT SERVER</b> .....	<b>7</b>
Unpacking the Print Server .....	<b>8</b>
Checking the Printer .....	<b>8</b>
Connecting the Print Server .....	<b>9</b>
<b>CONFIGURING WIRELESS PRINTING FOR WINDOWS</b> .....	<b>11</b>
Preparing to Install .....	<b>12</b>
Checking Your Network .....	<b>13</b>
Installing the EpsonNet Wireless Utilities .....	<b>14</b>
Configuring the Print Server .....	<b>16</b>
Completing the Installation .....	<b>19</b>
Setting Up Additional Computers .....	<b>21</b>
Setting Up a Network Port on Windows XP or 2000 .....	<b>22</b>
Setting Up a Network Port on Windows Me, 98, or 95 .....	<b>24</b>
Setting Up a Network Port on Windows NT 4.0 .....	<b>27</b>

<b>CONFIGURING WIRELESS PRINTING FOR MACINTOSH</b> .....	<b>29</b>
Preparing to Install .....	<b>30</b>
If Your Macintosh Has an AirPort Wireless Adapter .....	<b>31</b>
If Your Macintosh Has a Non-AirPort Wireless Adapter .....	<b>32</b>
Installing the EpsonNet Wireless Print Server .....	<b>33</b>
Configuring the Print Server .....	<b>34</b>
Setting Up Additional Macintosh Computers .....	<b>37</b>
If Your Macintosh Has an AirPort Wireless Adapter .....	<b>37</b>
If Your Macintosh Has a Non-AirPort Wireless Adapter .....	<b>38</b>
 <b>SOLVING WIRELESS PRINTING PROBLEMS</b> .....	 <b>39</b>
Problems and Solutions .....	<b>40</b>
Uninstalling the Software .....	<b>46</b>
Windows .....	<b>46</b>
Macintosh .....	<b>46</b>
Where To Get Help .....	<b>47</b>
 <b>APPENDIX A: CONFIGURATION SETTINGS</b> .....	 <b>49</b>
 <b>APPENDIX B: SPECIFICATIONS AND NOTICES</b> .....	 <b>55</b>
Print Server Specifications .....	<b>55</b>
Epson America, Inc. Limited Warranty .....	<b>57</b>
FCC Compliance Statement .....	<b>59</b>
Declaration of Conformity .....	<b>60</b>
 <b>INDEX</b> .....	 <b>61</b>

# Introduction

The EpsonNet 802.11b Wireless Print Server lets you print from any computer in your existing network without additional wiring.

Even without a network, you can print from a wireless-equipped Windows® PC or laptop, Macintosh®, Apple® iBook™ or PowerBook®, from distances up to 120 feet.

The print server is compatible with most wireless adapters and access points that comply with the WiFi™ (Wireless Fidelity) standard. The following EPSON® printers are supported:

- EPSON Stylus® C80
- EPSON Stylus Color 980
- EPSON Stylus Color 900
- EPSON Stylus Color 880
- EPSON Stylus Photo 1280
- EPSON Stylus Photo 1270
- EPSON Stylus Photo 870
- EPSON Stylus Photo 2000P

This book provides all the instructions you'll need for setting up the print server, installing the software, and configuring your system for wireless printing.

---

# Wireless Networking

The EpsonNet 802.11b Wireless Print Server is designed for use in a small office, home, or school network. On a wired network like the one illustrated below, the computers and other equipment share information and Internet access through a series of cables.

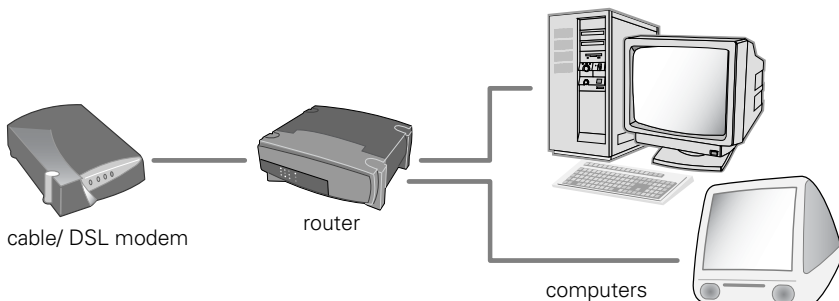

**Wired Network**

With a wireless network, you share information between computers and printers using radio waves, similar to the technology used in cordless phones. You can place your printer in a convenient location and use it without having to connect it to your computer or network.

You can add the EpsonNet 802.11b Wireless Print Server to your network either with or without a wireless access point (or AirPort™ Base Station).

If you have an access point/base station, both wired and wireless-equipped computers can use the printer. An access point might also allow computers to share other resources, such as Internet access.

The illustration below shows a wireless network that uses an access point.

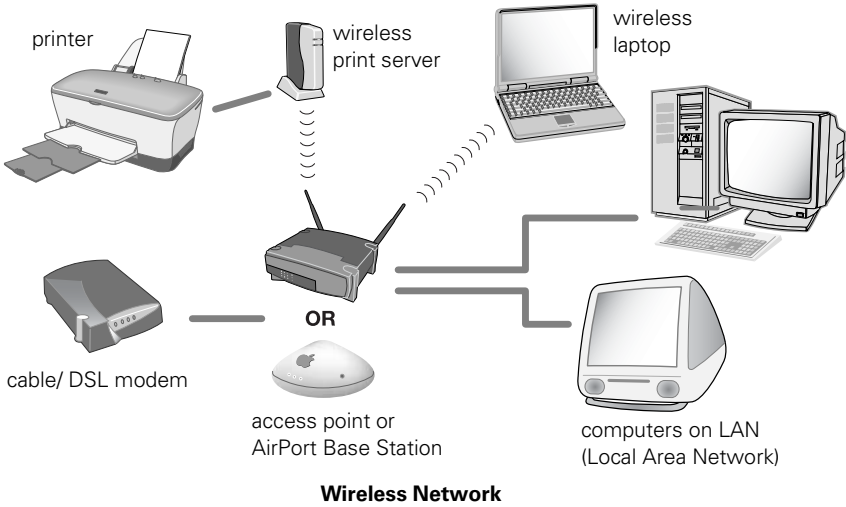

If you don't have an access point, you can still print from any desktop computer or laptop that has a wireless adapter. In the illustration below, both wireless-equipped computers communicate directly with the print server.

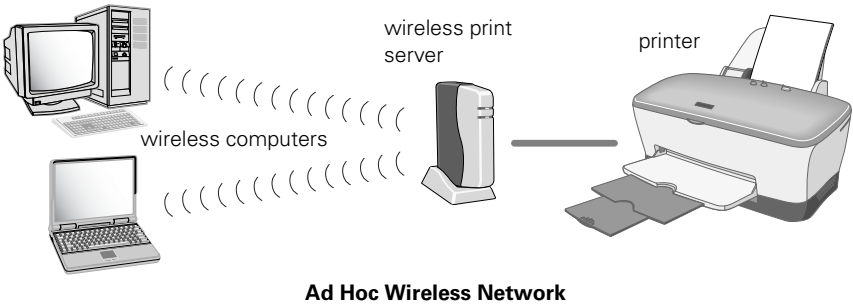

Before you can set up your EpsonNet 802.11b Wireless Print Server, you need to decide how you will use it: either with an access point (in *infrastructure mode*), or without an access point (in *ad hoc mode*, also called ad hoc 802.11b, computer-to-computer, and peer-to-peer).

---

# Windows System Requirements

For printing with the EpsonNet 802.11b Wireless Print Server, make sure each computer meets the following requirements:

- A Microsoft® Windows compatible PC or laptop with a Pentium® processor or later, 200 MHz or faster recommended
- Windows 95, Windows 98, Windows Me, Windows NT® 4.0, Windows 2000, or Windows XP
- 32MB of RAM (64MB recommended)
- 100MB of free hard disk space (200MB or more recommended)
- VGA or better display adapter and monitor
- CD-ROM or DVD drive for installing the printer software

In addition, each computer needs to be connected to an existing wired network that has a wireless access point, or needs to have a wireless adapter installed.

- An access point may be combined with a hub or router or may be a separate unit. For a current list of supported access points, see EPSON's web site at: <http://support.epson.com>.
- Wireless adapters can be installed in a PCMCIA slot on a laptop, a PCI slot in a desktop computer, or connected through a USB port.

Make sure your wireless adapters(s) work in ad hoc mode if you want to print without an access point. For a list of supported adapters, see EPSON's web site at: <http://support.epson.com>.

To connect the print server to your printer, you also need a high-speed, bidirectional, IEEE-1284 compliant parallel cable (6 to 10 feet long) with a D-SUB, 21-pin, male connector for the print server and a 36-pin Centronics® compatible connector for your printer.



---

# Macintosh System Requirements

For printing with the EpsonNet 802.11b Wireless Print Server, make sure each Macintosh meets the following requirements:

- An Apple iBook, iMac,<sup>™</sup> PowerBook G3 or G4, Power Mac G4 Cube, or Power Mac G3 or G4
- Mac<sup>®</sup> OS 8.6 through 9.2 (Mac OS 9.2 recommended)



If you are using Mac OS X, check the EPSON web site for driver updates and support information. Connect to the Internet, then go to <http://support.epson.com>.

- 32MB of available RAM (64MB recommended)
- 100MB of free hard disk space (200MB recommended)
- VGA display or better
- CD-ROM or DVD drive for installing the printer software

In addition, each computer either needs to have a wireless adapter installed, or needs to be connected to an existing wired network that has a wireless access point or AirPort Base Station.



If you are using AirPort, EPSON recommends that you use the print server with an access point or AirPort Base Station. With AirPort, your print server works more reliably in infrastructure mode.

- Make sure the access point supports AppleTalk.<sup>®</sup> For a list of supported access points, see EPSON's web site at: <http://support.epson.com>.
- For computers not connected to a wired network, you need an AirPort card or Macintosh-compatible wireless adapter. Make sure your card or adapter works in ad hoc mode if you want to print without an access point. For a list of supported adapters, see EPSON's web site at: <http://support.epson.com>.
- If you are using an AirPort card or the AirPort Base Station, use AirPort software version 1.3 or later.

To connect the print server to your printer, you also need a high-speed, bidirectional, IEEE-1284 compliant parallel cable (6 to 10 feet long) with standard connectors.

---

# Where To Get Information

Use this booklet to set up and configure your EPSON printer and EpsonNet 802.11b Wireless Print Server. Please follow these guidelines:



Cautions must be observed to avoid damage to your equipment.



Notes contain important information about your print server.

For additional information, check the following:

■ **On-screen software help**

If you need assistance as you use the EpsonNet utilities, click the **Help** button.

■ **<http://support.epson.com>**

You can receive technical advice through e-mail and access troubleshooting information, software updates, and new print server firmware. Information about configuring the print server for NetWare<sup>®</sup> environments and other network protocols is also available.

If you still need help after checking these sources, you can speak to a technical support representative as described on page 47.

# Setting Up Your Print Server

This chapter describes how to unpack and set up your print server.

You can locate the printer and print server anywhere in your home or office. However, keep in mind that walls and ceilings will weaken the signal between your print server, computer(s), and access point, and that the print server must be within 120 feet of your other equipment.

Make sure you choose a location away from high temperatures, direct sunlight, humidity, and dust. Do not place the print server on a metal surface or near other devices that might cause interference, such as cordless phones operating at 2.4 GHz, microwave ovens, or Bluetooth™ devices.

Before you set up the print server, make sure your printer is set up and has ink and paper. Follow the instructions on the *Start Here* sheet included with the printer to set it up.

Then follow the instructions in these sections:

- Unpacking the print server
- Running a printer check
- Connecting the print server

---

# Unpacking the Print Server

Take everything out of the box and make sure you have the items shown below.



You will also need a parallel cable to connect the print server to your printer. Make sure your cable follows the specifications listed on page 4.

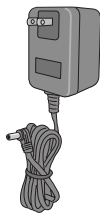

power supply



print server



base









print server  
CD-ROM

---

## Checking the Printer

Before you connect the print server, print a test page to make sure the printer is working properly. Make sure letter-size or larger paper is loaded.

1. Press the  power button to turn off the printer.
2. Hold down the  paper button as you press and release the  power button.

On some printers, you need to hold down the   load/eject button or  maintenance button. Check the *Printer Basics* book that came with your printer.

3. Continue holding down the button until the  power light starts flashing, then release it.

The printer prints a sheet showing its ROM version number and a nozzle check pattern. If the test page prints, continue with the instructions below for connecting the print server.

If the test page doesn't print, check the control panel lights. See the "Problem Solving" chapter in your *Printer Basics* book for control panel guidelines. If none of the solutions work, contact EPSON as described on page 47.

---

# Connecting the Print Server

After you have verified that the printer is working correctly, you're ready to connect the print server.

1. Press the  power button to turn off your printer.
2. Slide the print server into the base and press firmly to attach it.

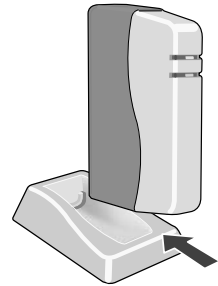

3. Make sure you have a parallel cable (not included with the print server).

Connect the larger end of the cable to the printer's parallel port.

Then secure it with the wire clips.

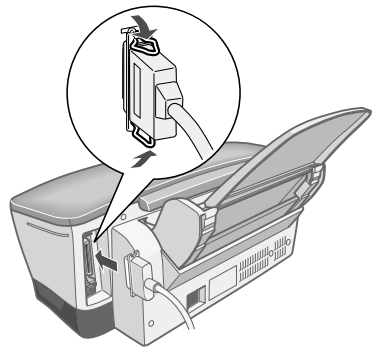

4. Connect the other end of the cable to the parallel port on the print server and secure it as necessary.

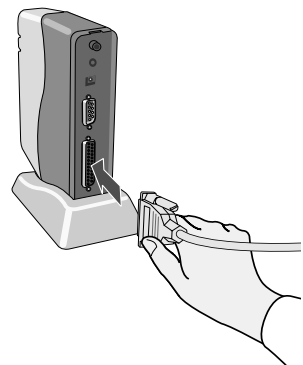

5. Connect the power supply to the print server.
6. Plug the AC adapter into an electrical outlet. Both the green and yellow lights come on for a moment and then go out.

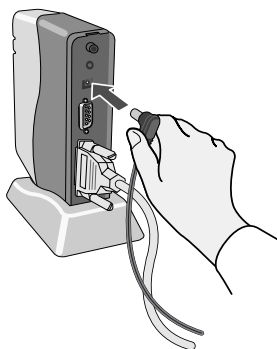

If the green light blinks continuously in a regular pattern, try unplugging the print server. If you still see the light blinking after you plug it in again, contact EPSON as described on page 47.

7. Press the  power button on the printer to turn it on.
8. To test the connection between the print server and printer, press the test button for one second and release it. The status page prints.

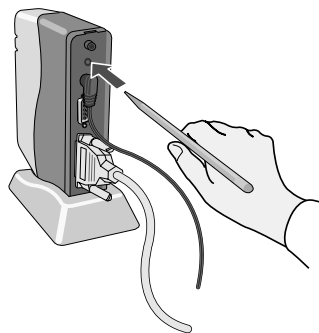

If you hold the test button down for more than 5 seconds, you may reset the print server. If you do this, wait for the print server's lights to go out, then press the button again and release it immediately to print the status page.

- If the print server status page prints, you're ready to install the software and configure your system for wireless printing. See the next section for instructions.
- If the status page doesn't print, make sure the printer is ready and is not out of ink or paper. (See page 8 for instructions on testing the printer.) Then turn off the printer, unplug the print server, and check the cable connections at both ends. Plug the server back in, turn on the printer, and press the test button again. If the test page still doesn't print, contact EPSON as described on page 47.

# Configuring Wireless Printing for Windows

This chapter explains how to install the software and set up the EpsonNet 802.11b Wireless Print Server for printing with Windows.

Once the print server is configured, you can set up the network port for wireless printing on other computers in your network.

Before you start, make sure your printer is connected to the print server, as described on pages 9 to 10. If you have a new printer, follow the instructions on the *Start Here* sheet that came in the box to set up the printer, load ink, and install the driver and other software.

Then follow the instructions in these sections:

- Preparing to install
- Installing the EpsonNet wireless utilities
- Configuring the print server
- Setting up additional computers
- Setting up a network port

---

# Preparing to Install

Configuring the print server is the process of setting it up to work with your network. This process begins immediately after you install the software, so it's important to make sure your print server and printer are set up before you start installing. You also need to check that your wireless network adapter(s) and/or access point are installed and ready.

Your EpsonNet 802.11b Wireless Print Server CD-ROM includes the following software:

- **WP-Admin**

This utility lets you configure the print server for most network protocols. For most networks, it is the only configuration utility you need to install.

- **EpsonNet Direct Print**

This software, which sets up a network printer port, must be installed on every Windows Me, 98, or 95 computer that uses the printer.

- **XAdmin32**

This utility lets you configure the print server for a Novell® NetWare network and perform more advanced configuration for other protocols.

Your print server also comes with a built-in web-based configuration utility, which enables you to change configuration settings from any computer on the wireless network that supports a standard web browser. You must configure the print server using WP-Admin or XAdmin32 before you can use this utility.



To use the print server's web-based configuration utility, start your web browser and enter the print server's IP address. For more information about the web-based utility and XAdmin32, visit EPSON's web site at [support.epson.com](http://support.epson.com). XAdmin32 also provides on-screen help.



# Checking Your Network

Before you begin the installation process, do the following:

- Follow the instructions starting on page 9 to set up the print server, connect it to your printer, and test the connection.
- Make sure the wireless mode for your computer is set to **Infrastructure** if you are connecting to the printer through an access point, or **802.11b Ad Hoc** if you are connecting without an access point. For instructions, see the documentation or online help for your wireless adapter.

You need to do this on each computer that you want to use for wireless printing.



Do *not* select a pseudo ad hoc or proprietary ad hoc mode.

- If you're using infrastructure mode, make sure there is a link with good signal strength (greater than 50 percent) between each computer and the access point.
- Note the IP address for each computer in your network. (For instructions, see page 50.)
- If you're using WEP (Wired Equivalent Privacy) encryption on your wireless network, you need to temporarily disable WEP on your computer. Follow the instructions in your wireless adapter's documentation.

Be sure to write down the WEP key used on your network. You'll need it when you configure the print server.





If your access point only allows WEP-enabled clients to connect to it, you may have to set your computer's wireless mode to 802.11b Ad Hoc before you configure the print server.

# Installing the EpsonNet Wireless Utilities

Before you install the utilities, make sure you check your network settings, as described on page 13.

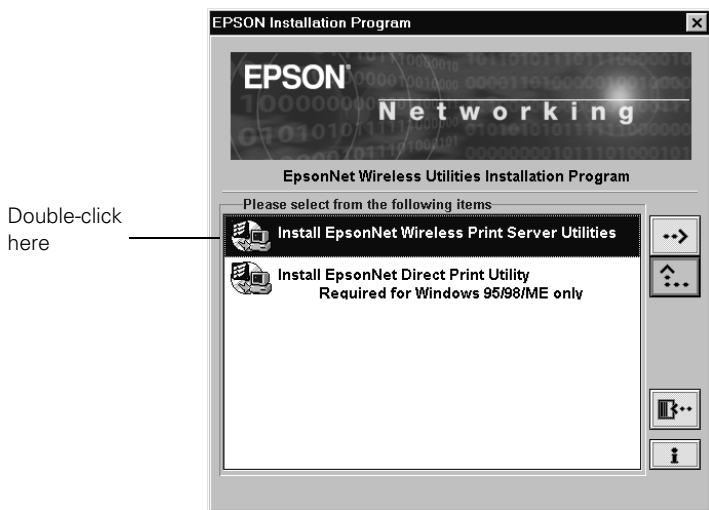
1. Insert the print server CD-ROM in your drive. You see the EpsonNet Installation Program:



- If the Installation Program doesn't open automatically, go to **My Computer** and double-click the  **Epson CD-ROM** icon.
2. Double-click **Install EpsonNet Wireless Print Server Utilities**.
3. If you see a message about the Java Runtime Environment, as shown below, click **Continue**.



You must install the Java Runtime Environment if it's not already installed on your computer.

4. Click **Next**. You see the license agreement.
5. Read the license agreement, and click **Yes**.
6. Follow the instructions on the screen and click **Next**. You see this window:

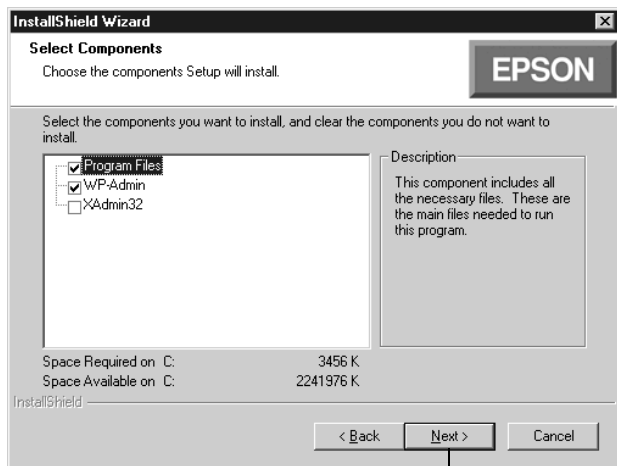

Click Next

7. Check XAdmin32 if you want to install it. Then see the XAdmin32 on-screen help for configuration instructions.
8. Click **Next** to install the program files and WP Admin. After the files are installed, you see the Wireless Server Search window:



Continue with the instructions in the next section to configure the print server.

# Configuring the Print Server

After the software is installed, you're ready to establish a connection to the print server and configure it for your wireless network.

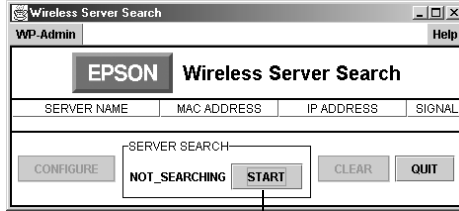

Click START

1. When you see the Wireless Server Search window, click **START**.

WP-Admin picks up the signal from the print server and displays server information like the following:

This information appears when the server is found



This number indicates the signal strength



If WP-Admin fails to pick up a signal from the print server, try holding down the print server's test button for at least five seconds to reset it. The lights go out, then both the green and yellow lights come on briefly. The yellow light remains on when your network has a connection to the print server.

If it still fails to pick up a signal, check the solutions beginning on page 40.

2. If WP-Admin picks up a signal from more than one server, select the connection that matches the MAC address on the back of your print server.
3. Check the signal strength to make sure you have a good link to the print server. If you have a link, click **STOP**. Then click **CONFIGURE**.

You see the following:

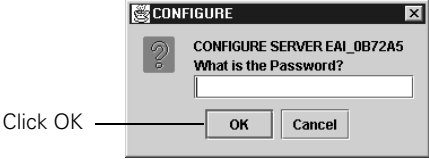

If you see the message Wireless Communication Failed, click OK, then click CONFIGURE again. If you continue to see this message, move the print server closer to your computer and access point, if you have one. Also, move it away from large metal objects and devices such as cordless phones or microwave ovens.

4. Click OK on the Password window. (The default password is null, or blank.)

The print server automatically detects the settings for your wireless network, and you see the Wireless Server Configuration screen:

Enter or modify the IP address

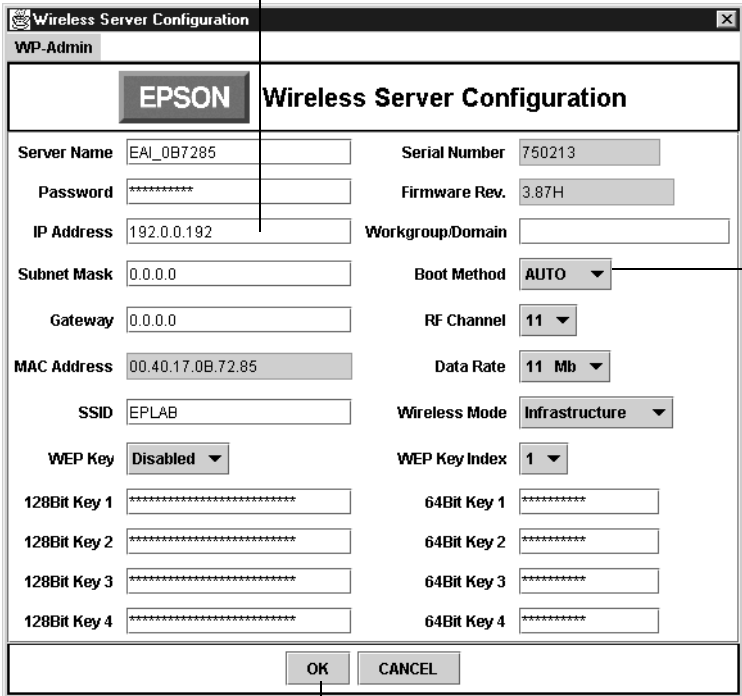

Click OK



For descriptions of all the settings on the Wireless Server Configuration screen, see Appendix A.

5. For Boot Method, select **STATIC**.
6. Do one of the following:
  - If your network does not support DHCP (192.0.0.192 appears in the IP Address box), enter an IP address that conforms to the IP addressing scheme for your network.

For example, if you have two computers on your network whose IP addresses are 192.189.207.3 and 192.189.207.4, the print server's IP address should begin with 192.189.207. The last part of the address can be any number between 2 and 254 except 3 or 4.
  - If your network supports DHCP, change only the last segment of the IP address, and make sure it is out of the range of DHCP assignments.

For example, if the last segment of assigned addresses is between 100 and 200, choose a number below 100 or above 200. Make sure you don't use the same IP address as another node on your network.
7. If you want to enable WEP encryption, do the following:
  - Select either **64BIT** or **128BIT** in the WEP Key box, depending on which version of WEP your network supports.
  - Enter your WEP key in either the 128Bit Key 1 box or the 64Bit Key 1 box.



You can enter up to four WEP keys on the screen. Every node on the network must use the same WEP key. For more information, check the documentation for your wireless adapter or access point, or see page 53.

- If you're using an access point, set the Wireless Mode to **Infrastructure**. (Remember to enable WEP and reset the wireless mode on your computer when you're done configuring the print server.)
- Make sure the SSID matches your wireless network's SSID.

8. Make any other changes you want and click OK.

For example, you might want to change the Server Name to something that is easy to remember, or enter a password to limit access to the Configuration screen.

9. Continue with the instructions in the next section to complete the configuration and installation.

---

## Completing the Installation

After you finish configuring the print server and click OK, you see the Wireless Server Search window again:

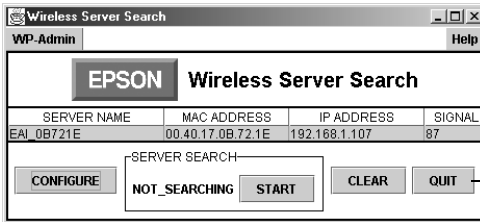

1. Click QUIT. You see the following:

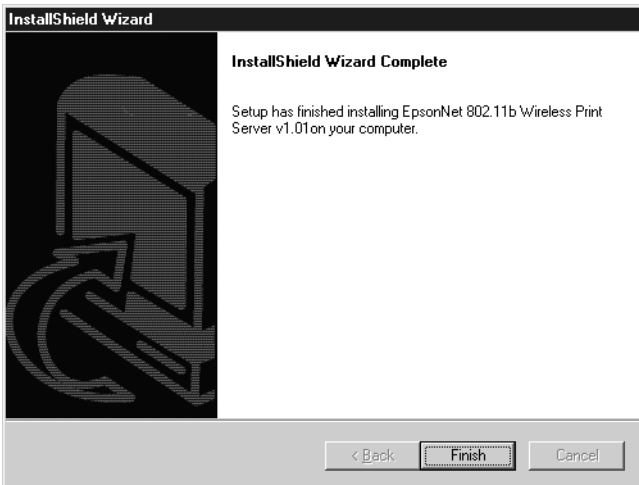

2. Click Finish.

You see the EpsonNet Installation Program again:



3. Do one of the following:

- If you're running Windows Me, 98, or 95, double-click **Install EpsonNet Direct Print Utility** and follow the instructions on the screen to install the software and restart your computer.
- If you're using a different version of Windows, click the  button to exit the installation program.



Once you've installed WP-Admin, you can change the print server's configuration at any time. To start WP-Admin from the Windows Start menu, click Programs or All Programs > Epson Printers > EpsonNet Wireless > WP-Admin.

Now you're ready to set up a network port so that your computer can use the printer over the wireless network. Go to one of the following sections:

- "Setting Up a Network Port on Windows XP or 2000" on page 22.
- "Setting Up a Network Port on Windows Me, 98, or 95" on page 24.
- "Setting Up a Network Port on Windows NT 4.0" on page 27.

To set up your other computers for network printing, see page 21.



---

# Setting Up Additional Computers

After you configure the print server, you need to set up a network port on all the computers that will print over the wireless network. First, do the following:

1. Make sure you have installed the printer driver and utility software. See the *Start Here* sheet that came with your printer for instructions.
2. Make sure your computer's wireless mode is set to either **Infrastructure**, if you are connecting to the printer through an access point, or **802.11b Ad Hoc** if you are connecting without an access point.

If your wireless adapter doesn't include an **802.11b Ad Hoc** option, select **Ad Hoc**, **Computer-to-Computer**, or whatever mode your adapter uses to communicate without an access point. *Do not* select a pseudo ad hoc or proprietary ad hoc mode. See the documentation for your wireless adapter for instructions.

3. If you're using infrastructure mode, make sure there is a link with good signal strength between the computer and the access point.
4. Go to one of the following sections for instructions on setting up a network port:
  - "Setting Up a Network Port on Windows XP or 2000" on page 22.
  - "Setting Up a Network Port on Windows Me, 98, or 95" on page 24.
  - "Setting Up a Network Port on Windows NT 4.0" on page 27.

---

# Setting Up a Network Port on Windows XP or 2000

The process of setting up a network port is similar on Windows XP and Windows 2000. Although this section shows Windows XP, you'll see similar screens in Windows 2000. Make sure you are logged in to the computer as an administrator.

Before you begin, run WP-Admin and note the IP address of your print server. Make sure the printer driver is installed, and the wireless adapter (or network adapter) is configured and working correctly.

1. Do one of the following:
  - In Windows XP, click **Start > Control Panel > Printers and Other Hardware > Printers and Faxes**.
  - In Windows 2000, click **Start > Settings > Printers**.
2. Right-click your printer icon, then click **Properties**.
3. On the Ports tab, select your printer (if necessary), and click **Add Port**. You see a window like the following:

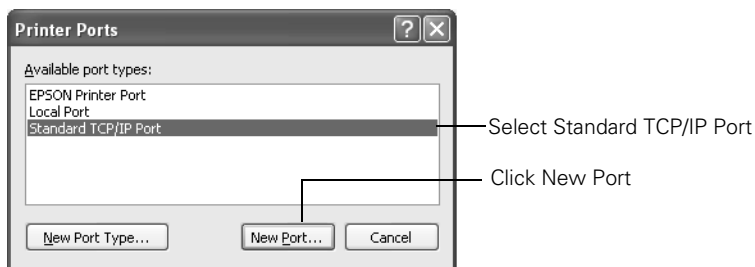

4. Select **Standard TCP/IP Port** and click **New Port**. You see the Add Standard TCP/IP Printer Port wizard.

5. Click **Next**. You see a window like the following:

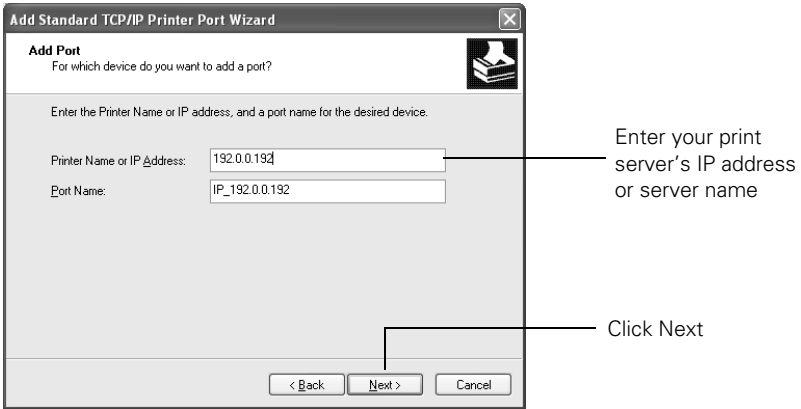

6. In the **Printer Name or IP Address** box, enter the print server's name or IP address and click **Next**.

7. Follow the instructions on the screen to complete the wizard.

8. Click **Close** to close the Printer Ports window, then click **Apply** on the Properties window.

9. To test the connection, select the **General** tab and click **Print Test Page**. If the test page prints, click **OK** to close the Properties window.

If it fails to print, try the following:

- Make sure the printer and print server are connected, plugged in, and turned on.
- Check WP-Admin to make sure you have a signal (see page 16).
- Make sure you've entered the correct IP address in step 6.
- Make sure you clicked **Apply** in step 8.

Now you're ready for wireless printing. For instructions, see the *Printer Basics* book that came with your printer.

# Setting Up a Network Port on Windows Me, 98, or 95

Before you begin, run WP-Admin and note the IP address of your print server. Make sure the printer driver is installed, and the wireless adapter (or network adapter) is configured and working correctly.

You need to install the EpsonNet Direct Print Utility for wireless printing on any computer running Windows Me, 98, or 95. If you have already installed the utility, you can skip to step 3.

1. Insert your printer CD-ROM in the drive. You see the EPSON Installation Program window:

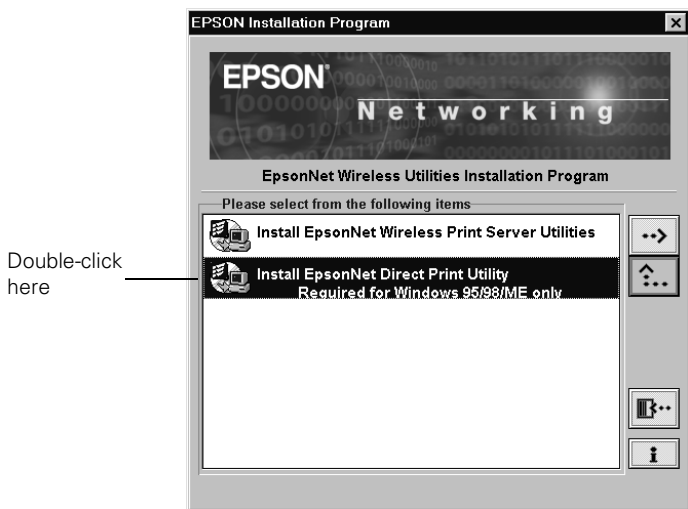

If the Installation Program doesn't open automatically, go to **My Computer** and double-click the  **Epson CD-ROM** icon.

2. Double-click **Install EpsonNet Direct Print Utility** and follow the instructions on the screen to install the software and restart your computer.
3. From the Start menu, click **Settings > Printers**.

4. Right-click your printer icon, and then click **Properties**. You see the Properties window. Click the Details tab to display a window like the following:

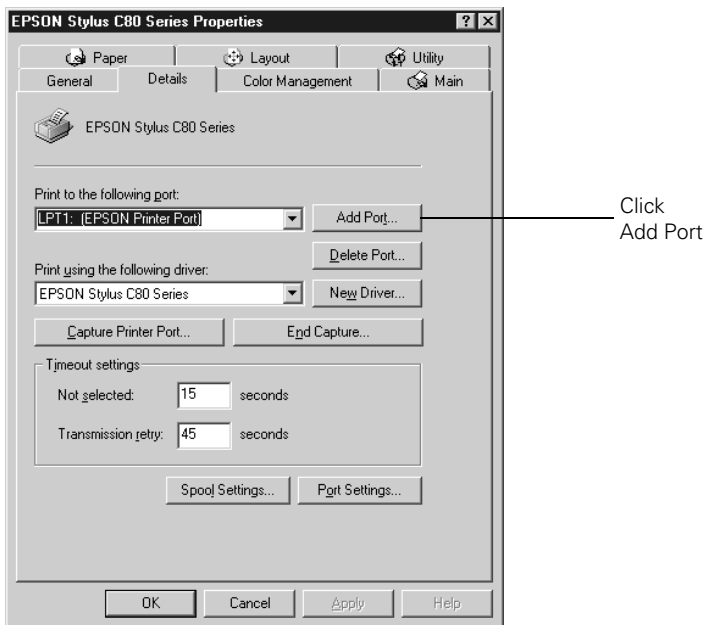

5. Click **Add Port** on the Details tab. You see the Add Port window:

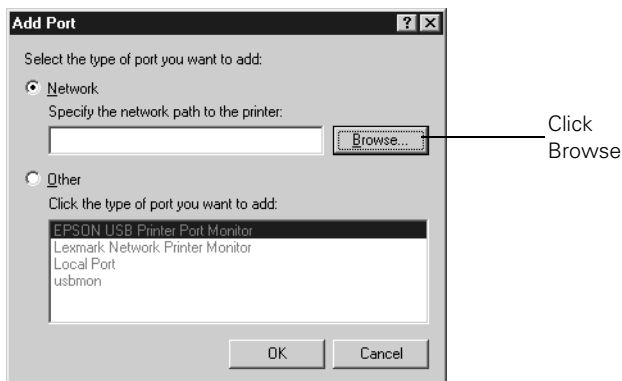

6. Make sure **Network** is selected, then click **Browse**.

You see the Browse for Printer window:

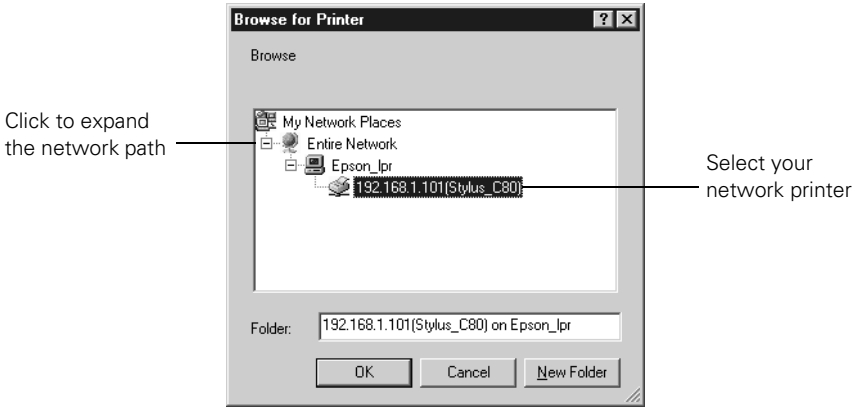

7. Click the + next to **Entire Network**, then click the + next to **Epson\_lpr** and select your printer. (Make sure the IP address matches your print server's IP address.)
8. Click **OK**, then click **OK** again. Click **Apply** on the Details tab.
9. To test the connection, click the **General** tab and click **Print Test Page**. Wait for the page to print.

If the test page prints, click **Yes**, then click **OK** to close the Properties window.

If it fails to print, try the following:

- Make sure that the printer and print server are connected and that both are turned on.
- Check WP-Admin to make sure you have a signal (see page 16).
- Make sure you clicked **Apply** in step 8.

Now you're ready for wireless printing. For instructions, see the *Printer Basics* book that came with your printer.

# Setting Up a Network Port on Windows NT 4.0

Make sure you have Microsoft TCP/IP Printing installed on the computer before you begin. Run WP-Admin and note the IP address and server name of your print server. Make sure the printer driver is installed, and the wireless adapter (or network adapter) in the computer is configured and working correctly.

1. From the Start menu, click **Settings > Printers**.
2. Right-click your printer icon and then click **Properties**.
3. On the Port tab, click **Add Port**. You see the Printer Ports window:

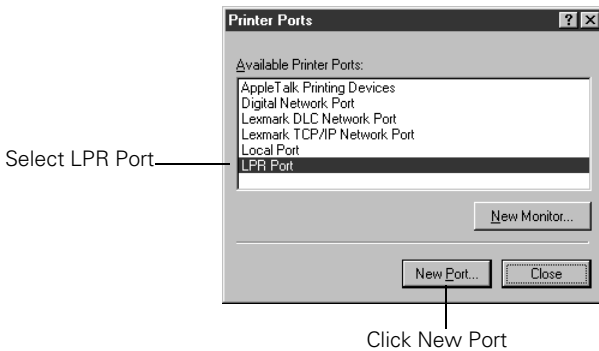

4. Select **LPR Port** and click **New Port**. You see a window like the following:

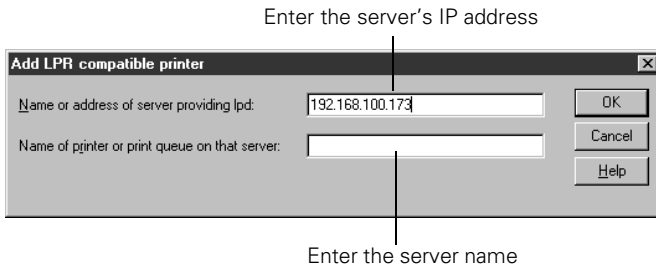

5. Enter the server's IP address in the **Name or address of server providing lpd** box, and the server name in the **Name of printer or print queue on that server** box. Then click **OK**.

6. Click **Close** to close the Printer Ports window.
7. Click **OK** to close the Properties window.
8. Right-click your printer icon in the Printers window and click **Properties**.
9. To test the connection, select the **General** tab and click **Print Test Page**.  
If the test page prints, click **OK** to close the Properties window.  
If it fails to print, try the following:
  - Make sure that the printer and print server are connected and that both are on.
  - Check WP-Admin to make sure you have a signal (see page 16).
  - Make sure you entered the correct IP address and server name in step 5.

Now you're ready for wireless printing. For instructions, see the *Printer Basics* book that came with your printer.



# Configuring Wireless Printing for Macintosh

This chapter explains how to install the software and set up the EpsonNet 802.11b Wireless Print Server for printing on a Macintosh.

Once the print server is configured, you select and use your EPSON printer from any Macintosh in your network.

Before you start, make sure your printer is connected to the print server, as described on pages 9 to 10. If you have a new printer, follow the instructions on the *Start Here* sheet that came in the box to set up the printer, load ink, and install the driver and other software.

Then follow the instructions in these sections:

- Preparing to install
- Installing the EpsonNet wireless utilities
- Configuring the print server
- Setting up additional Macintosh computers

---

# Preparing to Install

Configuring the print server is the process of setting it up to work with your network. This process begins immediately after you install the software, so it's important to make sure your print server and printer are set up before you start installing. You also need to check that your AirPort or other wireless network adapter(s) and/or access point are installed and ready.

Your EpsonNet 802.11b Wireless Print Server CD-ROM includes WP-Admin, which lets you configure the print server for AppleTalk and most other network protocols.

The print server also comes with a built-in web-based configuration utility. This lets you change configuration settings from any computer on the wireless network that supports a standard web browser. You must configure the print server using WP-Admin before you can use the utility.



To use the print server's web-based configuration utility, start your web browser and enter the print server's IP address. For more information about the web-based utility, visit EPSON's web site at [support.epson.com](http://support.epson.com).

## ***If Your Macintosh Has an AirPort Wireless Adapter***

- *Make sure* AirPort is enabled in the AppleTalk Control Panel. If your Macintosh and AirPort Base Station or access point are connected over an existing Ethernet network, select **Ethernet** in the AppleTalk Control Panel.
- *Make sure* that both AppleTalk and TCP/IP are enabled in your AirPort utility.
- To use the printer in infrastructure mode, select a working connection to a base station or access point from the AirPort Networks list.



Note the name of the AirPort Network. If you have a Windows computer on your wireless network, use this name as your computer's SSID (Service Set Identifier). For instructions on setting the SSID, see the documentation for the wireless adapter in your Windows computer.

- To use the printer in computer-to-computer (ad hoc) mode, create or join a computer-to-computer network. See your AirPort documentation for details.



EPSON recommends that you use the print server with an AirPort Base Station or access point. With AirPort, your print server works more reliably in infrastructure mode than computer-to-computer (ad hoc) mode.

- If you want your AirPort network to be password protected, you need to change your password to a hexadecimal value. Follow the instructions beginning on page 44 to install and configure your software.

## ***If Your Macintosh Has a Non-AirPort Wireless Adapter***

- Make sure your Macintosh computer's wireless mode is set correctly. Set it to **Infrastructure** if you are connecting through an access point, or **802.11b Ad Hoc** if you are connecting without an access point.

If your adapter does not include an **802.11b Ad Hoc** option, set the wireless mode to **Ad Hoc**, **Computer-to-Computer**, or the mode your adapter uses to communicate without an access point. *Do not* select a pseudo ad hoc or proprietary ad hoc mode. See the documentation for your wireless adapter for details.

- If you're using infrastructure mode, make sure there is a link with good signal strength (greater than 50 percent) between the Macintosh and base station or access point. See your wireless adapter's documentation for details.
- If you're configuring the print server from a Macintosh with a non-AirPort wireless adapter, make sure WEP (Wired Equivalent Privacy) is disabled before you begin. See the documentation for your wireless adapter for instructions.

# Installing the EpsonNet Wireless Print Server

1. Insert the printer CD-ROM in your drive.
2. Double-click the  Utility Installer icon.



You may see a message that you have an older version of the Java Runtime Environment on your Macintosh. Click OK to install the newer version. When you're done installing the Java Runtime Environment, click Quit. Then double-click the  Utility Installer icon to restart the utility installation program.

3. Click **Next** on the Introduction screen. You see the license agreement.
4. Click **Next** to accept the agreement and continue.
5. Follow the instructions on the screen to install the Print Server. At the last screen, click **Done**. You see the Wireless Server Search window:



Continue with the instructions in the next section to configure the print server.

# Configuring the Print Server

After the software is installed, you're ready to establish a connection to the print server and configure it for your wireless network.



Click START

1. When you see the Wireless Server Search window, click **START**.

Wait until you see server information like the following (you should not have to wait more than 60 seconds):



This information appears when the server is found

This number indicates the signal strength



If WP-Admin fails to pick up a signal from the print server, try holding down the print server's test button for five seconds to reset it. The lights go out, then both the green and yellow lights come on briefly. The yellow light remains on when your network has a connection to the print server.

If it still fails to pick up a signal, check the solutions beginning on page 40.

2. If WP-Admin picks up a signal from more than one print server, select the connection that matches the MAC address on the back of your print server.
3. Check the signal strength to make sure you have a good link to the print server. If you have a link, click **STOP**. Then click **CONFIGURE**.

You see a password window.



If you see the message Wireless Communication Failed, click OK, then click CONFIGURE again. If you continue to see this message, move the print server closer to your computer and access point, if you have one. Also, move it away from large metal objects and devices such as cordless phones or microwave ovens.

4. Click OK on the Password window. (The default password is null, or blank.)

The print server automatically detects the settings for your wireless network, and you see the Wireless Server Configuration screen:

Server Name	EAI_0B7285	Serial Number	750213
Password	*****	Firmware Rev.	3.87H
IP Address	192.0.0.192	Workgroup/Domain	
Subnet Mask	0.0.0.0	Boot Method	AUTO
Gateway	0.0.0.0	RF Channel	11
MAC Address	00.40.17.0B.72.85	Data Rate	11 Mb
SSID	EPLAB	Wireless Mode	Infrastructure
WEP Key	Disabled	WEP Key Index	1
128Bit Key 1	*****	64Bit Key 1	*****
128Bit Key 2	*****	64Bit Key 2	*****
128Bit Key 3	*****	64Bit Key 3	*****
128Bit Key 4	*****	64Bit Key 4	*****

Must be the name of your Airport network



For descriptions of all the settings on the Wireless Server Configuration screen, see Appendix A.

5. If you want, change the Server Name to something that is easy to remember, or enter a password to limit access to the Wireless Server Configuration screen.



This password does not affect access to your AirPort network. To enable password protection on your network, see page 44.

6. Make any other changes you want and click OK. You see the Wireless Server Search window again:

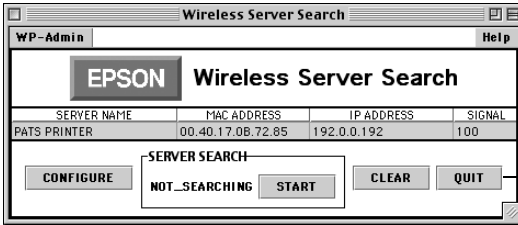

Click QUIT

7. Click QUIT.
8. Open the Chooser from the Apple menu.
9. Click your printer icon, then click the EPSON printer port icon. Turn on background printing if you want, and close the Chooser.

Now you're ready for wireless printing. For instructions, see the *Printer Basics* book that came with your printer.



Once you've installed WP-Admin, you can change the print server's configuration at any time. Double-click the WP-Admin alias on your desktop, if you've created one, or double-click the EpsonNet folder on your hard drive and then double-click the  WP-Admin icon.



---

# Setting Up Additional Macintosh Computers

Once the print server is configured on your wireless network, you can install the driver and select the printer on each Macintosh. Then make sure all your computers are set up for your wireless network.

1. Make sure you have installed the printer driver and utility software. See the *Start Here* sheet that came with your printer for instructions.
2. Select your printer and network printer port in the Chooser.
3. Make sure your Macintosh is set up to use your wireless network, following the instructions in one of the sections below.

## ***If Your Macintosh Has an AirPort Wireless Adapter***

- *Make sure* AirPort is enabled in the AppleTalk Control Panel. If your Macintosh and AirPort Base Station or access point are connected over an existing Ethernet network, select **Ethernet** in the AppleTalk Control Panel.
- *Make sure* that both AppleTalk and TCP/IP are enabled in your AirPort utility.
- To use the printer in infrastructure mode, select a working connection to a base station or access point from the AirPort Networks list.
- To use the printer in computer-to-computer (ad hoc) mode, create or join a computer-to-computer network. See your AirPort documentation for details.



EPSON recommends that you use the print server with an AirPort Base Station or access point. With AirPort, your print server works more reliably in infrastructure mode than computer-to-computer (ad hoc) mode.

## ***If Your Macintosh Has a Non-AirPort Wireless Adapter***

- Make sure your Macintosh computer's wireless mode is set correctly. Set it to **Infrastructure** if you are connecting through an access point, or **802.11b Ad Hoc** if you are connecting without an access point.

If your adapter does not include an **802.11b Ad Hoc** option, set the wireless mode to **Ad Hoc**, **Computer-to-Computer**, or the mode your adapter uses to communicate without an access point. *Do not* select a pseudo ad hoc or proprietary ad hoc mode. See the documentation for your wireless adapter for details.

- If you're using infrastructure mode, make sure there is a link with good signal strength (greater than 50 percent) between the Macintosh and base station or access point. See your wireless adapter's documentation for details.



# Solving Wireless Printing Problems

This chapter gives you information on solving problems with print server setup and wireless printing.



If you need to clean or align the print head, follow the instructions in *Printer Basics* to run the appropriate utilities. These programs work on your wireless network the same as they do when the printer is connected directly to a computer.

If you can't print, follow these steps to diagnose the problem:

- First, check the lights on the printer. They let you know if an ink cartridge runs out or your paper is jammed. You may also see a message on your computer screen. See *Printer Basics* for more information.
- If the printer lights do not indicate a problem, try running a printer check. Turn off the printer and disconnect the print server. Hold down the  paper button, then press and release the  power button. After the printer test page prints, turn off the printer. See *Printer Basics* for more information.

If the printer test page doesn't print, contact EPSON as described on page 47.

- If the test page prints, test the connection between the printer and print server. Connect the print server as described on page 9. Turn on the printer, then press the test button on the print server and release it immediately, as described on page 10. The print server status sheet prints.
- If the status sheet doesn't print, try resetting the print server. Press the test button and hold it down until the green and yellow lights come on briefly (about five seconds). Then press the button again to print the status sheet. If it still doesn't print, contact EPSON as described on page 47.

If the print server status sheet prints, but you still can't print through your wireless network, follow the suggestions in this chapter to solve the problem.

---

## Problems and Solutions

Here are some troubleshooting tips if you are having trouble setting up your print server or printing over your wireless network.

### **When you start WP-Admin, you see a message that Javaw.exe was not found.**

You must have the Java Runtime Environment installed on your computer to run WP-Admin. Uninstall the print server software, as described on page 46, then reinstall it as described in the instructions starting on page 14.

### **You're having trouble connecting to the print server.**

- Check the lights on your print server. The yellow light remains on when your network has a connection to the print server, and the green light flashes when data is transmitted to the print server. If the yellow light is on, make sure you have a connection between your computer and access point or base station (if you have one).
- Make sure your computer's wireless adapter is installed and configured correctly. See the instructions that came with the adapter.
- If you have an access point, make sure it is turned on and configured correctly. You need to confirm the connection between your computer and access point before you can connect to the print server. Try resetting the access point if you're having a problem establishing a connection. See the instructions that came with your access point for more information.
- If you're using AirPort, make sure that AirPort is enabled in the AppleTalk Control Panel. Also, make sure that AppleTalk and TCP/IP are enabled in your AirPort utility. Finally, make sure that you are using AirPort version 1.3 or later. (If you have an earlier version of AirPort, you can download an upgrade to version 1.3 from Apple's web site.)
- If you're using an AirPort Base Station, make sure you have selected a working connection to your base station from the AirPort Networks list. If you're using AirPort in computer-to-computer (ad hoc) mode, create or join a computer-to-computer network.

- Hold down the test button on the back of the print server for at least five seconds to reset the print server to its factory defaults. The print server's green and yellow lights come on briefly when it resets.



If you've already configured the print server, you need to run WP-Admin again to reconfigure it.

- Try restarting your computer.
- Make sure your computer, print server, and access point (if you have one) are within range (up to 120 feet without obstructions). If you are on a different floor or several rooms away from the print server, try moving your equipment closer together.
- Move the print server away from large metal objects and other devices that interfere with radio signals, such as cordless phones and microwave ovens.
- Make sure the wireless mode for your computer is set to Infrastructure if you are connecting through an access point, or 802.11b Ad Hoc if you are connecting without an access point. (Your wireless adapter may use different terms. Check the documentation for your adapter.) Never select a pseudo ad hoc or proprietary ad hoc mode.
- Make sure your print server's IP address is on the same network segment as your computer's IP address. (See "IP Address" on page 50 for instructions on accessing your computer's IP address.)

For example, if you have two computers on your network whose IP addresses are 192.189.207.3 and 192.189.207.4, the print server's IP address should begin with 192.189.207. The last part of the address can be any number between 1 and 254 except 3 or 4. To check the print server's IP address, press the test button on the back of the print server for one second to print a status sheet.



It's best to change your print server's IP address rather than the computer's. IP addresses are used to configure computers for a many functions, from Internet access to file sharing.

- If you've set the Boot Method in WP-Admin to **AUTO** or **DHCP** and unplugged the print server, DHCP may have assigned another IP address to the print server.

To check the IP address, press the test button on the print server for one second to print a status sheet. Then make sure the IP address for your computer is on the same network segment. See "IP Address" on page 50 for instructions on accessing the computer's IP address. (You can avoid this problem by leaving the print server plugged in, or by setting the Boot Method to **STATIC**. See page 18 for details.)

- If you are using WEP encryption on your wireless network, disable it on your computer before you configure the print server. Then enable WEP on the print server (see page 18). When you're done configuring the print server, enable WEP on your computer again.



If your access point only allows WEP-enabled clients to connect to it, you may have to set your computer's wireless mode to 802.11b Ad Hoc (or your adapter's wireless ad hoc mode) before you configure the print server. If your computer's wireless mode was originally set to Infrastructure, you can set it back to Infrastructure when you're done.

### **You see the message "Wireless Communication Failed" when you click CONFIGURE on the Wireless Server Search window.**

- Click OK to close the message, then click **CONFIGURE** again on the Wireless Server Search window. (If WP-Admin is picking up a signal from more than one print server, select the correct print server first.)
- If you continue to see this message, move the print server closer to your computer and access point (if you have one). Also, move the print server away from large metal objects and other devices that interfere with radio signals, such as cordless phones and microwave ovens.

### **You are getting a wireless signal, but you are not able to print.**

- If you're running Windows, make sure you set up your network port correctly. See the instructions beginning on page 22.
- Make sure your wireless link has adequate signal strength—at least 50 percent. If the signal is weak, try moving the print server and printer to a different location, away from large metal objects and other devices that interfere with radio signals, such as cordless phones and microwave ovens.

- Make sure you're connecting to the correct print server. Check the MAC address on the back of the print server against the MAC address that appears in the WP-Admin Wireless Server Search window.
- Check the printer's lights to see if there is a problem with the printer. See *Printer Basics* for details.

**You are using AirPort in computer-to-computer (ad hoc) mode, and you are unable to see the printer port in the Chooser.**

If this problem happens frequently, EPSON recommends that you use the print server with an access point or AirPort Base Station. With AirPort, your print server works more reliably in infrastructure mode.

**Printing is too slow.**

- Try moving the print server away from large metal objects and other devices that interfere with radio signals, such as cordless phones, microwave ovens, or Bluetooth devices.
- Move your computer, print server, and access point (if you have one) closer to each other.
- Change the RF Channel on your computer (if you're using ad hoc mode) or your access point (if you're using infrastructure mode).

To avoid interference from other wireless networks in the vicinity, choose a setting that is at least three channels higher or lower than any other wireless network. (For example, if another network is set to channel 7, choose channel 10 or higher, or channel 4 or lower.) Make sure you use the same channel for your access point and computers.

- Network traffic can affect print performance. Adding another access point or router may improve performance.

For other solutions, see *Printer Basics*.

**You see a communication error message when you try to print.**

You may see an error message if another computer on your network is trying to print at the same time. The green light on the print server flashes when data is transmitted to the print server. Wait until the first print job is printed. Your job will print when it reaches the top of the print queue.

## **You want to use a password on your AirPort network.**

Because AirPort uses passwords that do not follow the standard for WEP encryption, you need to change your network password to a hexadecimal value. Follow these steps:

1. Create a computer-to-computer network without password protection on the Macintosh that you use to configure the print server.
2. Follow the steps beginning on page 14 to install WP-Admin and establish a connection to the print server.
3. Make the following selections on the Wireless Server Configuration screen:
  - Select **64BIT** in the WEP key box.
  - In the 64Bit Key 1 box, enter a hexadecimal value consisting of 10 digits, or a combination of digits and letters. Digits can be from 0 to 9, and letters must be between A and F. For example: **62B91F2A98**.
  - If you have an AirPort Base Station, enter a name for your network in the SSID box. Then change the Wireless Mode to **Infrastructure**.
4. Make any other changes you want to the Wireless Server Configuration screen and click **OK**. When you see the Wireless Server Search window, click **QUIT**.
5. If you want to use the printer in computer-to-computer (ad hoc) mode, go to step 6.

If you have an AirPort Base Station, do the following:

- For Network Name, configure the base station to use the name that you entered in the SSID box on the Wireless Server Configuration screen.
- For Network Password, select the hexadecimal value that you entered in the 64Bit Key 1 box, preceded by the number zero (0) and lowercase letter x. For example: **0x62B91F2A98**. Then go to step 7.



6. To use the printer in computer-to-computer mode, do the following:
  - Create a computer-to-computer network.
  - When prompted, enter as your password the hexadecimal value you entered in the 64Bit Key 1 box on the Wireless Server Configuration screen. This value must be preceded by the number zero (0) and lowercase letter *x*. For example: **0x62B91F2A98**.
7. Open the Chooser from the Apple menu. Select your printer icon, then click the **EPSON printer port** icon. Turn on background printing if you want, and close the Chooser.
8. For each Macintosh on your network, either select a connection to your base station from the AirPort Networks list, or join the computer-to-computer network that your print server is on.
9. When prompted, enter the network password that you created in step 5 (if you're using a base station) or step 6 (if you're using the printer in computer-to-computer mode).
10. Follow the instructions beginning on page 37 to set up printing on your other Macintosh computers.

---

# Uninstalling the Software

You may need to uninstall and then reinstall the software for your printer. For example, this might be necessary if you upgrade your computer operating system.

## ***Windows***

1. Click **Start > Settings > Control Panel** (for Windows XP, click **Start > Control Panel**).
2. Double-click **Add/Remove Programs** (or **Add or Remove Programs**).
3. Select **EpsonNet 802.11b Wireless Print Server** and click **Add/Remove** (or **Change/Remove**). You see the InstallShield Wizard Setup Maintenance program.
4. Select **Remove** and click **Next**. Then follow the on-screen instructions.
5. When you see the **Maintenance Complete** message, click **Finish**.
6. If you've installed **EpsonNet Direct Print**, select it on the **Add/Remove programs** windows and click **Add/Remove**. Then follow the on-screen instructions.
7. When **uninstall** is complete, click **OK**. Then click **OK** again when you see the confirmation message.

## ***Macintosh***

1. Drag the **EpsonNet** folder on your hard drive to the trash.
2. If you've created a desktop alias for **WP-Admin**, drag it to the trash.
3. Restart your Macintosh.

---

## Where To Get Help

If you need help with your print server, see the contact information below.

EPSON provides technical assistance 24 hours a day through the Internet:

- You can reach EPSON Support at <http://support.epson.com>. At this site, you can download drivers and other files, look at product documentation, access troubleshooting information, and receive technical advice through e-mail.

To speak to a technical support representative, dial:

- U.S.: (562) 276-7500, 6 AM to 8 PM, Pacific Time, Monday through Friday and 7 AM to 4 PM, Saturday.
- Canada: (905) 709-2567, 6 AM to 6 PM, Pacific Time, Monday through Friday.

Toll or long distance charges may apply. Before you call, please have the following information ready:

- Product name (EpsonNet 802.11b Wireless Print Server)
- Print server serial number (located on the back of the print server)
- Proof of purchase (such as a store receipt) and date of purchase
- Computer configuration
- Description of the problem

You can purchase ink cartridges, paper, manuals, and accessories from EPSON at (800) 873-7766, or visit the EPSON Store<sup>SM</sup> at [www.epsonstore.com](http://www.epsonstore.com) (U.S. sales only). In Canada, please call (800) 463-7766 for dealer referral.



# Appendix A: Configuration Settings

The Wireless Server Configuration screen includes both fields that display information and fields that allow you to modify print server settings. Since most of the settings are configured automatically based on your existing network, you don't need to change these settings for the typical wireless network. Some settings, such as the Server Name or Password, you may want to change for convenience or security.

If you contact EPSON for technical support, you need to provide configuration information such as the serial number and firmware revision.

Following are definitions of the configuration settings:

## ***Server Name***

Name that identifies the print server (and its printer) on your wireless network. The default is EAI\_XXXXXX (where XXXXXX are the last six digits of the MAC/Ethernet address). Choose any name that makes it easier for users to identify the printer (for example, **Admissions Printer**). You can enter from one to 32 characters in this field. Make sure you follow the naming practices for your organization.

## ***Serial Number***

Unique number that identifies each EpsonNet 802.11b Wireless Print Server that is produced. This number is set during manufacture and cannot be changed.

## ***Password***

Used to restrict access to the Wireless Server Configuration screen. The default password is null (blank). The maximum number of characters you can use in this field is 16.

## ***Firmware Revision***

Indicates the version of the software embedded in the print server. This field cannot be changed.

## ***IP Address***

Address used to identify a node on a network supporting the TCP/IP protocol. The format for IP (Internet Protocol) addresses is a set of four bytes or segments, separated by periods. Each byte can have any value from zero (0) to 254.

If you need to enter an address, make sure it conforms to the addressing scheme for your network and it does not conflict with the IP address for any other node on your network. The print server's default IP address is 192.0.0.192.

To view your computer's IP address, do the following:

### **Windows XP/2000/NT:**

1. From the Windows Start menu, click **Run**.
2. Enter `cmd` in the text box and click **OK**. You see a DOS window.
3. At the prompt, type `ipconfig` and press **Enter**. You see your computer's IP configuration file, which includes the IP address.
4. At the prompt, type `exit` to exit the DOS window.

### **Windows Me/98/95:**

1. From the Windows Start menu, click **Run**.
2. Enter `winipcfg` in the text box and click **OK**. You see the IP Configuration window.
3. Select your wireless adapter from the drop-down list. You see IP configuration information, including the IP address.
4. Click **OK** to close the IP Configuration window.

## ***WorkGroup/Domain***

Used on networks that support NetBIOS or NetBEUI. WP-Admin detects this setting automatically, so you should not have to change it. The print server must be on the same workgroup or domain as all computers using the printer.

### ***Subnet Mask***

Set the subnet mask of your print server to the correct setting for your network. This setting will be 255.255.255.0 for most networks in the home or small office.

### ***Boot Method***

Method the print server uses to obtain an IP address. For most networks, change this setting to **STATIC**, which prevents the IP address from changing when you unplug the print server and plug it in again later.

**AUTO** attempts to detect your IP address through DHCP, BOOTP, and RARP. If unable to detect an IP address automatically, it uses the default IP address: 192.0.0.192. If you leave this setting on **AUTO**, you may have to repeat the steps to set your computer up to use the printer each time the IP address for your print server changes.

### ***Gateway (or Router)***

Use this setting only if you are using the print server in a large organization that has subnets for different departments.

### ***RF Channel***

Defines the radio frequency channel that the print server uses to communicate. In most cases, the print server automatically configures the RF channel. This value must match for all nodes on a network.

If you find that printing is too slow, you may be able to improve performance by changing the RF channel on your computer(s) and access point, if you have one. To avoid interference from other networks, choose a setting at least three channels higher or lower than that for any nearby wireless network (for example, if another network is set to channel 7, choose channel 10 or higher, or channel 4 or lower).

### ***MAC Address***

Defines the Ethernet address of the print server. The MAC (Medium Access Control) address is set during manufacture and cannot be changed. You can find it on the sticker on the back of the print server.

## **Data Rate**

Indicates the throughput speed in Mbps of the wireless Ethernet connection (1, 2, 5.5, or 11). The print server will automatically negotiate to the highest possible rate.

## **SSID**

Name that identifies your wireless network. When you configure the print server in WP-Admin, it automatically detects the SSID (Service Set Identifier) for the wireless network. The SSID must match for all nodes on the network. The maximum number of characters that you can use in this field is 32.

## **Wireless Mode**

Mode used by computers on a wireless network to communicate with the print server. WP-Admin detects this setting automatically, based on the mode set in your wireless adapter software. To communicate, all computers must be set to the same wireless mode as the print server (or an equivalent mode).

- **Infrastructure**—Used when computers on the wireless network communicate with the print server through an access point or base station.
- **Ad Hoc (802.11b)**—Used when computers on the wireless network communicate with the print server directly, without using an access point or base station.
- **Pseudo Ad-Hoc**—Used for testing. Don't select this mode in your wireless adapter software or on the Wireless Server Configuration screen.
- **Auto**—Default factory setting. Auto mode attempts connection with each of the other methods in turn. This mode enables the print server to detect all your other wireless network settings (for example, IP address, SSID, workgroup, etc.). If you move your print server to a different wireless network, you must press the test button on the back of the print server for at least five seconds to reset it to its factory defaults (including Auto mode). This enables the print server to detect the settings for the new network.



## ***WEP Key***

Disables or enables WEP (Wired Equivalent Privacy), which provides a level of security for your network. To communicate, all nodes on your network must be WEP-enabled and must use the same WEP key. See the documentation for your wireless adapter or access point for more information about WEP. If you have an AirPort network, see page 44.

## ***WEP Key Index***

Lets you choose between four WEP keys for either 64-bit or 128-bit WEP. Changing your WEP key periodically adds to network security. For details about WEP, see the documentation for your wireless adapter or access point.

## ***128 Bit / 64 Bit WEP Key***

Fields for entering the WEP key(s) used on your network. To communicate, all nodes on the network must be set to the same WEP key. See the documentation for your wireless adapter or access point for more information about WEP.



# Appendix B: Specifications and Notices

---

## Print Server Specifications

### Printer Connection

Parallel (IEEE-1284)

Serial (9 pin; factory diagnostics only)

### Operating Systems

Windows 95/98/Me/NT 4/2000/XP

NetWare (2 through 5 with NDS)

Mac OS 7 through 9.x

### Dimensions

**Width:** 6 inches (15.2 cm)

**Depth:** 1.25 inches (3.2 cm)

**Height:** 4.25 inches (10.8 cm )

### Electrical

**Input Power:** 1 A @ 5 VDC

**External Power Supply:** 115 VAC

### Wireless Communication

**Variable Data Rates:** 11, 5.5, 2, 1 Mbps

**Frequency Band:** 2.4 GHz ISM Band

**Range:** up to 120 ft (36.6 m) indoors or 300 ft (91.4 m) outdoors

**Wired Equivalent Privacy:** 128-bit, 64-bit (compatible with 40-bit), none

### Sensitivity (typ, AWGN, 8E-2 PER):

- 91 dBm at 1 Mbps
- 88 dBm at 2 Mbps
- 87 dBm at 5.5 Mbps
- 84dBm at 11 Mbps

## Protocols

- TCP/IP (lpd or raw TCP port)
- IPP (Internet Printing Protocol)
- IPX/SPX
- Direct Mode IPX/IP
- NetBEUI
- NetBIOS/IP
- AppleTalk

## Management

- **WP-Admin:** utility for easy configuration from Windows or Macintosh
- **WebXAdmin:** web-browser utility
- **XAdmin32:** utility for NetWare and advanced configuration
- Print server console accessible via serial port, TELNET or NetWare
- NetWare PCONSOLE, PRINTCON, PRINTDEF, NWADMIN
- Simple Network Management Protocol (SNMP) MIB I and II; IP or IPX
- Firmware downloads via NetWare or TCP/IP (master mode tftp, slave mode TFTP, or BOOTP); multiple print servers may be downloaded simultaneously
- Test page and factory reset switch

---

# Epson America, Inc. Limited Warranty

*What Is Covered:* Epson America, Inc. (“Epson”) warrants to the first retail purchaser that the print server (the “Product”) covered by this limited warranty statement, if purchased and used in the United States or Canada, conforms to the manufacturer’s specifications and will be free from defects in workmanship and materials for a period of one (1) year from the date of original purchase. For warranty service, you must provide proof of the date of original purchase.

*What Epson Will Do To Correct Problems:* Should your Epson product prove defective during the warranty period, please call the Epson Connection<sup>SM</sup> at (562) 276-7525 (U.S.) or (905) 709-2567 (Canada) for warranty instructions and return authorization. An Epson service technician will provide telephone diagnostic service to determine whether the product requires service. If service is needed during the warranty period, Epson will, at its option, exchange or repair the unit without charge for parts or labor. If Epson authorizes an exchange for the defective product, Epson will ship a replacement product to you, freight prepaid. You are responsible for securely packaging the defective product and returning it to Epson within five (5) working days of receipt of the replacement unit. Epson requires a debit or a credit card number to secure the cost of the replacement product in the event that you fail to return the defective one. If your product is being repaired, Epson will direct you to send your product to Epson or its authorized service center. The product will be fixed and sent back to you. You are responsible for packing the product and for shipping costs to and from the Epson authorized service center. When warranty service involves the exchange of the product or of a part, the item replaced becomes Epson property. The exchanged product or part may be new or refurbished to the Epson standard of quality. Epson’s liability for replacement of the covered product will not exceed the original retail selling price of the covered product. Exchange products and parts assume the remaining warranty period of your original product covered by this limited warranty.

*What This Warranty Does Not Cover:* This warranty covers only normal use in the United States and Canada. This warranty is not transferable and will not apply to products purchased from an end user. This warranty does not cover damage to the Epson product caused by parts or supplies not manufactured, distributed or certified by Epson. This warranty does not cover ribbons, ink cartridges or third party parts, components, or peripheral devices added to the Epson product after its shipment from Epson, e.g., dealer or user-added boards or components. Epson is not responsible for warranty service should the Epson label or logo or the rating label or serial number be removed or should the product fail to be properly maintained or fail to function properly as a result of misuse, abuse, improper installation, neglect, improper shipping, damage caused by disasters such as fire, flood, and lightning, improper electrical current, software problems, interaction with non-Epson

products, or service other than by an Epson Authorized Servicer. If a claimed defect cannot be identified or reproduced, you will be held responsible for the costs incurred.

THE WARRANTY AND REMEDY PROVIDED ABOVE ARE EXCLUSIVE AND IN LIEU OF ALL OTHER EXPRESS OR IMPLIED WARRANTIES INCLUDING, BUT NOT LIMITED TO, THE IMPLIED WARRANTIES OF MERCHANTABILITY OR FITNESS FOR A PARTICULAR PURPOSE. SOME LAWS DO NOT ALLOW THE EXCLUSION OF IMPLIED WARRANTIES. IF THESE LAWS APPLY, THEN ALL EXPRESS AND IMPLIED WARRANTIES ARE LIMITED TO THE WARRANTY PERIOD IDENTIFIED ABOVE. UNLESS STATED HEREIN, ANY STATEMENT OR REPRESENTATIONS MADE BY ANY OTHER PERSON OR FIRM ARE VOID. EXCEPT AS PROVIDED IN THIS WRITTEN WARRANTY, NEITHER EPSON AMERICA, INC. NOR ITS AFFILIATES SHALL BE LIABLE FOR ANY LOSS, INCONVENIENCE, OR DAMAGE, INCLUDING DIRECT, SPECIAL, INCIDENTAL OR CONSEQUENTIAL DAMAGES, RESULTING FROM THE USE OR INABILITY TO USE THE EPSON PRODUCT, WHETHER RESULTING FROM BREACH OF WARRANTY OR ANY OTHER LEGAL THEORY.

In Canada, warranties include both warranties and conditions.

Some jurisdictions do not allow limitations on how long an implied warranty lasts, and some jurisdictions do not allow the exclusion or limitation of incidental or consequential damages, so the above limitations and exclusions may not apply to you. This warranty gives you specific legal rights and you may have other rights which vary from jurisdiction to jurisdiction.

Epson America, Inc. ● P.O. Box 93012 ● Long Beach, CA 90809-3012

---

# FCC Compliance Statement

## For United States Users

This equipment has been tested and found to comply with the limits for a Class B digital device, pursuant to Part 15 of the FCC Rules. These limits are designed to provide reasonable protection against harmful interference in a residential installation. This equipment generates, uses, and can radiate radio frequency energy and, if not installed and used in accordance with the instructions, may cause harmful interference to radio or television reception. However, there is no guarantee that interference will not occur in a particular installation. If this equipment does cause interference to radio and television reception, which can be determined by turning the equipment off and on, the user is encouraged to try to correct the interference by one or more of the following measures:

- Reorient or relocate the receiving antenna.
- Increase the separation between the equipment and receiver.
- Connect the equipment into an outlet on a circuit different from that to which the receiver is connected.
- Consult the dealer or an experienced radio/TV technician for help.

The radiated output power of the print server is far below the FCC radio frequency exposure limits. Nevertheless, the print server shall be used in such a manner that the potential for human contact during normal operation is minimized.

## WARNING

The connection of a non-shielded equipment interface cable to this equipment will invalidate the FCC Certification of this device and may cause interference levels which exceed the limits established by the FCC for this equipment. It is the responsibility of the user to obtain and use a shielded equipment interface cable with this device. If this equipment has more than one interface connector, do not leave cables connected to unused interfaces. Changes or modifications not expressly approved by the manufacturer could void the user's authority to operate the equipment.

## For Canadian Users

This Class B digital apparatus complies with Canadian ICES-003.

*Cet appareil numérique de la classe B est conforme à la norme NMB-003 du Canada.*

---

# Declaration of Conformity

According to 47CFR, Part 2 and 15 for Class B Personal Computers and Peripherals; and/or CPU Boards and Power Supplies used with Class B Personal Computers:

We: EPSON AMERICA, INC.

Located at: MS: 3-13  
3840 Kilroy Airport Way  
Long Beach, CA 90806  
Telephone: (562) 290-5254

Declare under sole responsibility that the product identified herein, complies with 47CFR Part 2 and 15 of the FCC rules as a Class B digital device. Each product marketed is identical to the representative unit tested and found to be compliant with the standards. Records maintained continue to reflect the equipment being produced can be expected to be within the variation accepted, due to quantity production and testing on a statistical basis as required by 47CFR §2.909 Operation is subject to the following two conditions: (1) this device may not cause harmful interference, and (2) this device must accept any interference received, including interference that may cause undesired operation.

Trade Name: EPSON

Type of Product: Print Server

Model: Wireless Print Server



# Index

## Numerics

- 128 Bit/ 64 Bit WEP Key setting, 53
- 802.11b Ad Hoc mode, 21, 32, 38, 52

## A

- Access point
  - problems connecting, 40 to 42
  - signal strength, 13, 32, 38
  - supported, 4, 5
- Accessories, ordering, 47
- Ad hoc mode
  - definition, 3
  - using in Windows, 13
  - using on Macintosh, 31, 37
- Adapters, supported, 4, 5
- AirPort
  - base station signal strength, 32, 38
  - requirements, 5, 31, 37
  - using passwords, 31, 44 to 45
- AppleTalk, 5, 31, 37
- Auto wireless mode, 52

## B

- Bluetooth, 7
- Boot Method setting, 18, 42, 51

## C

- Computer-to-computer mode, 31, 37
- Configuring print server, 16 to 19,  
34 to 36
- Connecting print server, 9 to 10

## D

- Data Rate setting, 52
- DHCP, 18, 42, 51
- Direct Print
  - description, 12
  - installing, 20, 24
  - uninstalling, 46
- Documentation, 6
- Domain setting, 50

## E

- EPSON
  - accessories, 47
  - Store, 47
  - technical support, 6, 47
  - warranty, 57 to 58
- EpsonNet Direct Print
  - description, 12
  - installing, 20, 24
  - uninstalling, 46

## F

- Firmware downloads, 56
- Firmware Revision setting, 50

## G

- Gateway setting, 51

## H

- Help, EPSON, 47

## I

- Infrastructure mode
  - definition, 3, 52
  - using in Windows, 13, 21
  - using on Macintosh, 31, 32, 37
- Ink cartridges, ordering, 47
- Installing
  - Macintosh software, 33 to 38
  - Windows software, 14 to 20, 24
  - WP-Admin, 14 to 15, 33
- IP Address setting
  - default print server IP address, 50
  - finding computer's IP address, 50
  - network requirements, 18, 41

## J

- Java Runtime Environment, 14, 33, 40

## L

- Lights, print server, 10, 40, 43

## M

- MAC Address setting, 51
- Macintosh
  - computer-to-computer mode, 31, 37
  - installing software and configuring, 33 to 38
  - OS X, 5
  - starting WP-Admin, 36
  - system requirements, 5
  - uninstalling software, 46
  - using a network password, 44 to 45

## N

- NetWare, 6, 12, 56
- Network port
  - Windows Me, 98, or 95, 24 to 26
  - Windows NT, 27 to 28
  - Windows XP or 2000, 22 to 23

## P

- Paper, ordering, 47
- Password
  - using on AirPort network, 31, 44 to 45
  - WP-Admin, 17, 35, 49
- Print server
  - attaching to printer, 9 to 10
  - configuring, 16 to 19, 34 to 36
  - dimensions, 55
  - establishing connection, 16 to 17, 33 to 35
  - location, 7, 41, 43
  - management tools, 56
  - name, 19, 35, 49
  - printing test page, 10
  - protocols supported, 56
  - serial number, 49
  - signal strength, 16, 34

- specifications, 55 to 56
- status lights, 10, 40
- test button, 10, 39

## Printer

- connecting to print server, 9 to 10
- lights, 8, 39
- location, 7, 41, 43
- maintenance, 39
- ROM version, 8
- supported models, 1
- test page, 8, 39

## Problems

- communication error, 43
- connecting to print server, 40 to 42
- Java Runtime Environment, 40
- no signal, 16, 40 to 42
- setting up network port, 23, 26, 28
- setting up password on AirPort, 44 to 45
- setting up WEP on Windows, 42
- signal strength, 16, 34
- slow printing, 43
- unable to print, 39, 42 to 43
- wrong IP address, 42

Protocols supported, 56

Pseudo Ad Hoc mode, 52

## R

Requirements, system, 4 to 5

RF Channel setting, 43, 51

ROM version, printer, 8

## S

Security, 13, 31, 42, 44 to 45

Serial connector, 55

Serial number, 47, 49

Server Name setting, 19, 35, 49

Service, 47

Signal strength, 13, 16

Slow printing, 43

## Software

installing, 14 to 20, 24, 33

uninstalling, 46

Specifications, 55 to 56

SSID setting, 18, 31, 52

Status lights, 10, 40, 43

Status sheet, printing, 10, 39

Subnet Mask setting, 51

Supplies, ordering, 47

Support, 6, 47

System requirements, 4 to 5

## T

Technical support, 47

Test button, 10, 16, 39

Test page, printing

print server, 10, 39

printer, 8, 39

Windows, 23, 26, 28

## U

Uninstalling software, 46

Unpacking, 8

USB, 4

## W

Warranty, 57 to 58

WEP

setting up on AirPort, 31, 44 to 45

setting up on Windows, 13

WEP Key settings, 53

Windows

installing software and configuring,

14 to 20

security, 13

system requirements, 4

uninstalling software, 46

Wireless adapters, supported, 4, 5

Wireless Mode setting, 52

Workgroup setting, 50

WP-Admin

configuration settings, 49 to 53

configuring, 17 to 19, 34 to 36

connecting with print server,

16 to 17, 33 to 34

installing, 14 to 15, 33

password, 17, 35, 49

starting, 20, 36

uninstalling, 46

## X

XAdmin32, 12, 56