



DSL-564T
ADSL Router
User's Guide

(April ,2004)

FCC Warning

This device complies with part 15 of the FCC Rules. Operation is subject to the following two conditions: (1) This device may not cause harmful interference, and (2) this device must accept any interference received, including interference that may cause undesired operation.

This equipment has been tested and found to comply with the limits for a Class B digital device, pursuant to part 15 of the FCC Rules. These limits are designed to provide reasonable protection against harmful interference in a residential installation. This equipment generates, uses and can radiate radio frequency energy and, if not installed and used in accordance with the instructions, may cause harmful interference to radio communications. However, there is no guarantee that interference will not occur in a particular installation. If this equipment does cause harmful interference to radio or television reception, which can be determined by turning the equipment off and on, the user is encouraged to try to correct the interference by one or more of the following measures:

- Reorient or relocate the receiving antenna.
- Increase the separation between the equipment and receiver.
- Connect the equipment into an outlet on a circuit different from that to which the receiver is connected.
- Consult the dealer or an experienced radio/TV technician for help.

CE Mark Warning

This is a Class B product. In a domestic environment, this product may cause radio interference in which case the user may be required to take adequate measures.

Warranty and Registration for all Countries and Regions Except USA

Wichtige Sicherheitshinweise

1. Bitte lesen Sie sich diese Hinweise sorgfältig durch.
2. Heben Sie diese Anleitung für den spätern Gebrauch auf.
3. Vor jedem Reinigen ist das Gerät vom Stromnetz zu trennen. Verwenden Sie keine Flüssig- oder Aerosolreiniger. Am besten dient ein angefeuchtetes Tuch zur Reinigung.
4. Um eine Beschädigung des Gerätes zu vermeiden sollten Sie nur Zubehörteile verwenden, die vom Hersteller zugelassen sind.
5. Das Gerät ist vor Feuchtigkeit zu schützen.
6. Bei der Aufstellung des Gerätes ist auf sichern Stand zu achten. Ein Kippen oder Fallen könnte Verletzungen hervorrufen. Verwenden Sie nur sichere Standorte und beachten Sie die Aufstellhinweise des Herstellers.
7. Die Belüftungsöffnungen dienen zur Luftzirkulation die das Gerät vor Überhitzung schützt. Sorgen Sie dafür, daß diese Öffnungen nicht abgedeckt werden.
8. Beachten Sie beim Anschluß an das Stromnetz die Anschlußwerte.
9. Die Netzanschlußsteckdose muß aus Gründen der elektrischen Sicherheit einen Schutzleiterkontakt haben.
10. Verlegen Sie die Netzanschlußleitung so, daß niemand darüber fallen kann. Es sollte auch nichts auf der Leitung abgestellt werden.
11. Alle Hinweise und Warnungen die sich am Geräten befinden sind zu beachten.
12. Wird das Gerät über einen längeren Zeitraum nicht benutzt, sollten Sie es vom Stromnetz trennen. Somit wird im Falle einer Überspannung eine Beschädigung vermieden.
13. Durch die Lüftungsöffnungen dürfen niemals Gegenstände oder Flüssigkeiten in das Gerät gelangen. Dies könnte einen Brand bzw. Elektrischen Schlag auslösen.
14. Öffnen Sie niemals das Gerät. Das Gerät darf aus Gründen der elektrischen Sicherheit nur von autorisiertem Servicepersonal geöffnet werden.
15. Wenn folgende Situationen auftreten ist das Gerät vom Stromnetz zu trennen und von einer qualifizierten Servicestelle zu überprüfen:
 - a. Netzkabel oder Netzstecker sind beschädigt.
 - b. Flüssigkeit ist in das Gerät eingedrungen.
 - c. Das Gerät war Feuchtigkeit ausgesetzt.
 - d. Wenn das Gerät nicht der Bedienungsanleitung entsprechend funktioniert oder Sie mit Hilfe dieser Anleitung keine Verbesserung erzielen.
 - e. Das Gerät ist gefallen und/oder das Gehäuse ist beschädigt.
 - f. Wenn das Gerät deutliche Anzeichen eines Defektes aufweist.
16. Bei Reparaturen dürfen nur Originalersatzteile bzw. den Originalteilen entsprechende Teile verwendet werden. Der Einsatz von ungeeigneten Ersatzteilen kann eine weitere Beschädigung hervorrufen.
17. Wenden Sie sich mit allen Fragen die Service und Repartur betreffen an Ihren Servicepartner. Somit stellen Sie die Betriebssicherheit des Gerätes sicher.
18. Zum Netzanschluß dieses Gerätes ist eine geprüfte Leitung zu verwenden, Für einen Nennstrom bis 6A und einem Gerätegewicht größer 3kg ist eine Leitung nicht leichter als H05VV-F, 3G, 0.75mm² einzusetzen.

WARRANTIES EXCLUSIVE

IF THE D-LINK PRODUCT DOES NOT OPERATE AS WARRANTED ABOVE, THE CUSTOMER'S SOLE REMEDY SHALL BE, AT D-LINK'S OPTION, REPAIR OR REPLACEMENT. THE FOREGOING WARRANTIES AND REMEDIES ARE EXCLUSIVE AND ARE IN LIEU OF ALL OTHER WARRANTIES, EXPRESSED OR IMPLIED, EITHER IN FACT OR BY OPERATION OF LAW, STATUTORY OR OTHERWISE, INCLUDING WARRANTIES OF MERCHANTABILITY AND FITNESS FOR A PARTICULAR PURPOSE. D-LINK NEITHER ASSUMES NOR AUTHORIZES ANY OTHER PERSON TO ASSUME FOR IT ANY OTHER LIABILITY IN CONNECTION WITH THE SALE, INSTALLATION MAINTENANCE OR USE OF D-LINK'S PRODUCTS.

D-LINK SHALL NOT BE LIABLE UNDER THIS WARRANTY IF ITS TESTING AND EXAMINATION DISCLOSE THAT THE ALLEGED DEFECT IN THE PRODUCT DOES NOT EXIST OR WAS CAUSED BY THE CUSTOMER'S OR ANY THIRD PERSON'S MISUSE, NEGLIGENCE, IMPROPER INSTALLATION OR TESTING, UNAUTHORIZED ATTEMPTS TO REPAIR, OR ANY OTHER CAUSE BEYOND THE RANGE OF THE INTENDED USE, OR BY ACCIDENT, FIRE, LIGHTNING OR OTHER HAZARD.

LIMITATION OF LIABILITY

IN NO EVENT WILL D-LINK BE LIABLE FOR ANY DAMAGES, INCLUDING LOSS OF DATA, LOSS OF PROFITS, COST OF COVER OR OTHER INCIDENTAL, CONSEQUENTIAL OR INDIRECT DAMAGES ARISING OUT THE INSTALLATION, MAINTENANCE, USE, PERFORMANCE, FAILURE OR INTERRUPTION OF A D- LINK PRODUCT, HOWEVER CAUSED AND ON ANY THEORY OF LIABILITY. THIS LIMITATION WILL APPLY EVEN IF D-LINK HAS BEEN ADVISED OF THE POSSIBILITY OF SUCH DAMAGE.

IF YOU PURCHASED A D-LINK PRODUCT IN THE UNITED STATES, SOME STATES DO NOT ALLOW THE LIMITATION OR EXCLUSION OF LIABILITY FOR INCIDENTAL OR CONSEQUENTIAL DAMAGES, SO THE ABOVE LIMITATION MAY NOT APPLY TO YOU.

Limited Warranty

Hardware:

D-Link warrants each of its hardware products to be free from defects in workmanship and materials under normal use and service for a period commencing on the date of purchase from D-Link or its Authorized Reseller and extending for the length of time stipulated by the Authorized Reseller or D-Link Branch Office nearest to the place of purchase.

This Warranty applies on the condition that the product Registration Card is filled out and returned to a D-Link office within ninety (90) days of purchase. A list of D-Link offices is provided at the back of this manual, together with a copy of the Registration Card.

If the product proves defective within the applicable warranty period, D-Link will provide repair or replacement of the product. D-Link shall have the sole discretion whether to repair or replace, and replacement product may be new or reconditioned. Replacement product shall be of equivalent or better specifications, relative to the defective product, but need not be identical. Any product or part repaired by D-Link pursuant to this warranty shall have a warranty period of not less than 90 days, from date of such repair, irrespective of any earlier expiration of original warranty period. When D-Link provides replacement, then the defective product becomes the property of D-Link.

Warranty service may be obtained by contacting a D-Link office within the applicable warranty period, and requesting a Return Material Authorization (RMA) number. If a Registration Card for the product in question has not been returned to D-Link, then a proof of purchase (such as a copy of the dated purchase invoice) must be provided. If Purchaser's circumstances require special handling of warranty correction, then at the time of requesting RMA number, Purchaser may also propose special procedure as may be suitable to the case.

After an RMA number is issued, the defective product must be packaged securely in the original or other suitable shipping package to ensure that it will not be damaged in transit, and the RMA number must be prominently marked on the outside of the package. The package must be mailed or otherwise shipped to D-Link with all costs of mailing/shipping/insurance prepaid. D-Link shall never be responsible for any software, firmware, information, or memory data of Purchaser contained in, stored on, or integrated with any product returned to D-Link pursuant to this warranty.

Any package returned to D-Link without an RMA number will be rejected and shipped back to Purchaser at Purchaser's expense, and D-Link reserves the right in such a case to levy a reasonable handling charge in addition mailing or shipping costs.

Software:

Warranty service for software products may be obtained by contacting a D-Link office within the applicable warranty period. A list of D-Link offices is provided at the back of this manual, together with a copy of the Registration Card. If a Registration Card for the product in question has not been returned to a D-Link office, then a proof of purchase (such as a copy of the dated purchase invoice) must be provided when requesting warranty service. The term "purchase" in this software warranty refers to the purchase transaction and resulting license to use such software.

D-Link warrants that its software products will perform in substantial conformance with the applicable product documentation provided by D-Link with such software product, for a period of ninety (90) days from the date of purchase from D-Link or its Authorized Reseller. D-Link warrants the magnetic media, on which D-Link provides its software product, against failure during the same warranty period. This warranty applies to purchased software, and to replacement software provided by D-Link pursuant to this warranty, but shall not apply to any update or replacement which may be provided for download via the Internet, or to any update which may otherwise be provided free of charge.

D-Link's sole obligation under this software warranty shall be to replace any defective software product with product which substantially conforms to D-Link's applicable product documentation. Purchaser assumes responsibility for the selection of appropriate application and system/platform software and associated reference materials. D-Link makes no warranty that its software products will work in combination with any hardware, or any application or system/platform software product provided by any third party, excepting only such products as are expressly represented, in D-Link's applicable product documentation as being compatible. D-Link's obligation under this warranty shall be a reasonable effort to provide compatibility, but D-Link shall have no obligation to provide compatibility when there is fault in the third-party hardware or software. D-Link makes no warranty that operation of its software products will be uninterrupted or absolutely error-free, and no warranty that all defects in the software product, within or without the scope of D-Link's applicable product documentation, will be corrected.

Warranty and Registration Information for USA Only

Subject to the terms and conditions set forth herein, D-Link Systems, Inc. ("D-Link") provides this Limited warranty for its product only to the person or entity that originally purchased the product from:

- | D-Link or its authorized reseller or distributor and
- | Products purchased and delivered within the fifty states of the United States, the District of Columbia, U.S. Possessions or Protectorates, and U.S. Military Installations, addresses with an APO or FPO.

Limited Warranty: D-Link warrants that the hardware portion of the D-Link products described below will be free from material defects in workmanship and materials from the date of original retail purchase of the product, for the period set forth below applicable to the product type ("Warranty Period"), except as otherwise stated herein.

5-Year Limited Warranty for the Product(s) is defined as follows:

- | Hardware (excluding power supplies and fans) Five (5) Years
- | Power Supplies and Fans Three (3) Year
- | Spare parts and spare kits Ninety (90) days

D-Link's sole obligation shall be to repair or replace the defective Hardware during the Warranty Period at no charge to the original owner or to refund at D-Link's sole discretion. Such repair or replacement will be rendered by D-Link at an Authorized D-Link Service Office. The replacement Hardware need not be new or have an identical make, model or part. D-Link may in its sole discretion replace the defective Hardware (or any part thereof) with any reconditioned product that D-Link reasonably determines is substantially equivalent (or superior) in all material respects to the defective Hardware. Repaired or replacement Hardware will be warranted for the remainder of the original Warranty Period from the date of original retail purchase. If a material defect is incapable of correction, or if D-Link determines in its sole discretion that it is not practical to repair or replace the defective Hardware, the price paid by the original purchaser for the defective Hardware will be refunded by D-Link upon return to D-Link of the defective Hardware. All Hardware (or part thereof) that is replaced by D-Link, or for which the purchase price is refunded, shall become the property of D-Link upon replacement or refund.

Limited Software Warranty: D-Link warrants that the software portion of the product ("Software") will substantially conform to D-Link's then current functional specifications for the Software, as set forth in the applicable documentation, from the date of original retail purchase of the Software for a period of ninety (90) days ("Warranty Period"), provided that the Software is properly installed on approved hardware and operated as contemplated in its documentation. D-Link further warrants that, during the Warranty Period, the magnetic media on which D-Link delivers the Software will be free of physical defects. D-Link's sole obligation shall be to replace the non-conforming Software (or defective media) with software that substantially conforms to D-Link's functional specifications for the Software or to refund at D-Link's sole discretion. Except as otherwise agreed by D-Link in writing, the replacement Software is provided only to the original licensee, and is subject to the terms and conditions of the license granted by D-Link for the Software. Software will be warranted for the remainder of the original Warranty Period from the date or original retail purchase. If a material non-conformance is incapable of correction, or if D-Link determines in its sole discretion that it is not practical to replace the non-conforming Software, the price paid by the original licensee for the non-conforming Software will be refunded by D-Link; provided that the non-conforming Software (and all copies thereof) is first returned to D-Link. The license granted respecting any Software for which a refund is given automatically terminates.

Non-Applicability of Warranty: The Limited Warranty provided hereunder for hardware and software of D-Link's products, will not be applied to and does not cover any product purchased through the inventory clearance or liquidation sale or other sales in which D-Link, the sellers, or the liquidators expressly disclaim their warranty obligation pertaining to the product and in that case, the product is being sold "As-Is" without any warranty whatsoever including, without limitation, the Limited Warranty as described herein, notwithstanding anything stated herein to the contrary.

Submitting A Claim: Any claim under this limited warranty must be submitted in writing before the end of the Warranty Period to an Authorized D-Link Service Office.

- | The customer must submit as part of the claim a written description of the Hardware defect or Software nonconformance in sufficient detail to allow D-Link to confirm the same.
- | The original product owner must obtain a Return Material Authorization ("RMA") number from the Authorized D-Link Service Office and, if requested, provide written proof of purchase of the product (such as a copy of the dated purchase invoice for the product) before the warranty service is provided.
- | After an RMA number is issued, the defective product must be packaged securely in the original or other suitable shipping package to ensure that it will not be damaged in transit, and the RMA number must be prominently marked on the outside of the package. Do not include any manuals or accessories in the shipping package. D-Link will only replace the defective portion of the Product and will not ship back any accessories.
- | The customer is responsible for all shipping charges to D-Link. No Charge on Delivery ("COD") is allowed. Products sent COD will either be rejected by D-Link or become the property of D-Link. Products should be fully insured by the customer and shipped to D-Link Systems, Inc., 17575 Mt. Herrmann, Fountain Valley, CA 92708. D-Link will not be held responsible for any packages that are lost in transit to D-Link. The repaired or replaced packages will be shipped via UPS Ground or any common carrier selected by D-Link, with shipping charges prepaid. Expedited shipping is available if shipping charges are prepaid by the customer.

D-Link may reject or return any product that is not packaged and shipped in strict compliance with the foregoing requirements, or for which an RMA number is not visible from the outside of the package. The product owner agrees to pay D-Link's reasonable handling and return shipping charges for any product that is not packaged and shipped in accordance with the foregoing requirements, or that is determined by D-Link not to be defective or non-conforming.

What Is Not Covered: This limited warranty provided by D-Link does not cover: Products, if in D-Link's judgment, have been subjected to abuse, accident, alteration, modification, tampering, negligence, misuse, faulty installation, lack of reasonable care,

DSL-564T DSL Router User's Guide

repair or service in any way that is not contemplated in the documentation for the product, or if the model or serial number has been altered, tampered with, defaced or removed; Initial installation, installation and removal of the product for repair, and shipping costs; Operational adjustments covered in the operating manual for the product, and normal maintenance; Damage that occurs in shipment, due to act of God, failures due to power surge, and cosmetic damage; Any hardware, software, firmware or other products or services provided by anyone other than D-Link; Products that have been purchased from inventory clearance or liquidation sales or other sales in which D-Link, the sellers, or the liquidators expressly disclaim their warranty obligation pertaining to the product. Repair by anyone other than D-Link or an Authorized D-Link Service Office will void this Warranty.

Disclaimer of Other Warranties: EXCEPT FOR THE LIMITED WARRANTY SPECIFIED HEREIN, THE PRODUCT IS PROVIDED "AS-IS" WITHOUT ANY WARRANTY OF ANY KIND WHATSOEVER INCLUDING, WITHOUT LIMITATION, ANY WARRANTY OF MERCHANTABILITY, FITNESS FOR A PARTICULAR PURPOSE AND NON-INFRINGEMENT. IF ANY IMPLIED WARRANTY CANNOT BE DISCLAIMED IN ANY TERRITORY WHERE A PRODUCT IS SOLD, THE DURATION OF SUCH IMPLIED WARRANTY SHALL BE LIMITED TO NINETY (90) DAYS. EXCEPT AS EXPRESSLY COVERED UNDER THE LIMITED WARRANTY PROVIDED HEREIN, THE ENTIRE RISK AS TO THE QUALITY, SELECTION AND PERFORMANCE OF THE PRODUCT IS WITH THE PURCHASER OF THE PRODUCT.

Limitation of Liability: TO THE MAXIMUM EXTENT PERMITTED BY LAW, D-LINK IS NOT LIABLE UNDER ANY CONTRACT, NEGLIGENCE, STRICT LIABILITY OR OTHER LEGAL OR EQUITABLE THEORY FOR ANY LOSS OF USE OF THE PRODUCT, INCONVENIENCE OR DAMAGES OF ANY CHARACTER, WHETHER DIRECT, SPECIAL, INCIDENTAL OR CONSEQUENTIAL (INCLUDING, BUT NOT LIMITED TO, DAMAGES FOR LOSS OF GOODWILL, LOSS OF REVENUE OR PROFIT, WORK STOPPAGE, COMPUTER FAILURE OR MALFUNCTION, FAILURE OF OTHER EQUIPMENT OR COMPUTER PROGRAMS TO WHICH D-LINK'S PRODUCT IS CONNECTED WITH, LOSS OF INFORMATION OR DATA CONTAINED IN, STORED ON, OR INTEGRATED WITH ANY PRODUCT RETURNED TO D-LINK FOR WARRANTY SERVICE) RESULTING FROM THE USE OF THE PRODUCT, RELATING TO WARRANTY SERVICE, OR ARISING OUT OF ANY BREACH OF THIS LIMITED WARRANTY, EVEN IF D-LINK HAS BEEN ADVISED OF THE POSSIBILITY OF SUCH DAMAGES. THE SOLE REMEDY FOR A BREACH OF THE FOREGOING LIMITED WARRANTY IS REPAIR, REPLACEMENT OR REFUND OF THE DEFECTIVE OR NON-CONFORMING PRODUCT. THE MAXIMUM LIABILITY OF D-LINK UNDER THIS WARRANTY IS LIMITED TO THE PURCHASE PRICE OF THE PRODUCT COVERED BY THE WARRANTY. THE FOREGOING EXPRESS WRITTEN WARRANTIES AND REMEDIES ARE EXCLUSIVE AND ARE IN LIEU OF ANY OTHER WARRANTIES OR REMEDIES, EXPRESS, IMPLIED OR STATUTORY.

Governing Law: This Limited Warranty shall be governed by the laws of the state of California. Some states do not allow exclusion or limitation of incidental or consequential damages, or limitations on how long an implied warranty lasts, so the foregoing limitations and exclusions may not apply. This limited warranty provides specific legal rights and the product owner may also have other rights which vary from state to state.

TABLE OF CONTENTS

About This User's Guide.....	ix
Before You Start	ix
Installation Requirements.....	ix
INTRODUCTION	1
Router Description and Operation.....	1
Standards Compatibility and Compliance	3
Front Panel Display.....	4
Rear Panel Connections	5
HARDWARE INSTALLATION	6
Power on Router.....	6
Factory Reset Button.....	6
Network Connections.....	7
Power On Router.....	8
Factory Reset Button.....	8
BASIC ROUTER CONFIGURATION	9
Configuring IP Settings on Your Computer.....	9
Access the Configuration Manager.....	15
Login to Home Page.....	15
Configure the Router	16
Setup Menu	17
Configure Connection 1 for PPPoA.....	18
Change the Connection Type	20
Configure Connection 1 for PPPoE.....	20
Configure Connection 1 for Bridge.....	22
Configure Connection 1 for Static IP for WAN.....	23
Configure Connection 1 for DHCP for WAN.....	25
Configure Connection 1 for CLIP.....	26
Create a New Connection.....	27
DHCP Configuration for LAN	30
Enable DHCP Relay.....	31
Management IP.....	32
Save Configuration Changes.....	33
ADVANCED ROUTER MANAGEMENT	35
UPnP	36
LAN Clients	37
Port Forwarding	38
Access Control	42
Advanced Security	44
Bridge Filters.....	45
Multicast Pass-through.....	46
Static Routing.....	47
Dynamic Routing	48
Multiple Virtual Connections	49
Tools and Utility Menus.....	50
User Management	51

System Commands.....	52
Remote Log.....	53
Update Gateway.....	54
Ping Test.....	55
Modem Test.....	56
Status Menus.....	57
Network Statistics.....	58
Connection Status.....	59
DHCP Clients.....	59
Modem Status.....	60
Product Information.....	60
System Log.....	61
Help Menu.....	61
TECHNICAL SPECIFICATIONS.....	62
IP ADDRESS SETUP.....	64
IP CONCEPTS.....	66
MICROFILTERS AND SPLITTERS.....	69

About This User's Guide

This user's guide provides instructions on how to install the DSL-564T ADSL Router and use it to connect a computer or Ethernet LAN to the Internet.

If you are using a computer with a functioning Ethernet port, the quickest and easiest way to set up the DSL-564T is to insert the Installation CD into the CD-ROM drive of your computer and follow the instructions provided in the **Quick Installation Guide**.

Before You Start

Please read and make sure you understand all the prerequisites for proper installation of your new Router. Have all the necessary information and equipment on hand before beginning the installation.

Installation Overview

The procedure to install the Router can be described in general terms in the following steps:

1. Gather information and equipment needed to install the device. Before you begin the actual installation make sure you have all the necessary information and equipment.
2. Install the hardware, that is, connect the cables (Ethernet and telephone) to the device and connect the power adapter.
3. Check the IP settings on your computer and change them if necessary so the computer can access the web-based software built into the Router.
4. Use the web-based management software to configure the device to suit the requirements of your ADSL account.

Installation Requirements

In order to establish a connection to the Internet it will be necessary to provide information to the Router that will be stored in its memory. For some users, only their account information (Username and Password) is required. For others, various parameters that control and define the Internet connection will be required. You can print out the two pages below and use the tables to list this information. This way you have a hard copy of all the information needed to setup the Router. If it is necessary to reconfigure the device, all the necessary information can be easily accessed. Be sure to keep this information safe and private.

Low Pass Filters

Since ADSL and telephone services share the same copper wiring to carry their respective signals, a filtering mechanism may be necessary to avoid mutual interference. A low pass filter device can be installed for each telephone that shares the line with the ADSL line. These filters are easy to install passive devices that connect to the ADSL device and/or telephone using standard telephone cable. Ask your service provider for more information about the use of low pass filters with your installation.

Operating Systems

The DSL-564T uses an HTML-based web interface for setup and management. The web configuration manager may be accessed using any operating system capable of running web browser software, including Windows 98 SE, Windows ME, Windows 2000, and Windows XP.

Web Browser

Any common web browser can be used to configure the Router using the web configuration management software. The program is designed to work best with more recently released browsers such as Opera, Microsoft Internet Explorer® version 5.0, Netscape Navigator® version 4.7, or later versions. The web browser must have JavaScript enabled. JavaScript is enabled by default on many browsers. Make sure JavaScript has not been

disabled by other software (such as virus protection or web user security packages) that may be running on your computer.

Ethernet Port (NIC Adapter)

Any computer that uses the Router must be able to connect to it through the Ethernet port on the Router. This connection is an Ethernet connection and therefore requires that your computer be equipped with an Ethernet port as well. Most notebook computers are now sold with an Ethernet port already installed. Likewise, most fully assembled desktop computers come with an Ethernet NIC adapter as standard equipment. If your computer does not have an Ethernet port, you must install an Ethernet NIC adapter before you can use the Router. If you must install an adapter, follow the installation instructions that come with the Ethernet NIC adapter.

Additional Software

It may be necessary to install software on your computer that enables the computer to access the Internet. Additional software must be installed if you are using the device a simple bridge. For a bridged connection, the information needed to make and maintain the Internet connection is stored on another computer or gateway device, not in the Router itself.

If your ADSL service is delivered through a PPPoE, PPPoA or CLIP (IPoA) connection, the information needed to establish and maintain the Internet connection can be stored in the Router. In this case, it is not necessary to install software on your computer. It may however be necessary to change some settings in the device, including account information used to identify and verify the connection.

All connections to the Internet require a unique global IP address. For bridged connections, the global IP settings must reside in a TCP/IP enabled device on the LAN side of the bridge, such as a PC, a server, a gateway device such as a router or similar firewall hardware. The IP address can be assigned in a number of ways. Your network service provider will give you instructions about any additional connection software or NIC configuration that may be required.

About CLIP Connections (RFC 1577)

Classical IP over ATM (CLIP) connections may require global IP settings for the device. Your service provider will give you IP settings information if needed. Some CLIP connections function like peer-to-peer connections and therefore do not require IP settings on the WAN interface.

Information you will need from your ADSL service provider:

Username	This is the Username used to log on to your ADSL service provider's network. It is commonly in the form – <u>user@isp.com</u> . Your ADSL service provider uses this to identify your account.	Record info here
Password	This is the Password used, in conjunction with the Username above, to log on to your ADSL service provider's network. This is used to verify the identity of your account.	
Connection Protocol	This is the method your ADSL service provider uses to send and receive data between the Internet and your computer. Your Modem supports the following connection protocols: PPPoE, PPPoA, PPPoA with DHCP, Bridge, and CLIP (IPoA).	
Modulation Type	ADSL uses various standardized modulation techniques to transmit data over the allotted signal frequencies. Some users may need to change the type of modulation used for their service. The default DSL modulation (MMODE) used for the Router automatically detects all types of ADSL modulation. However, if you are instructed to specify the modulation type used for the Router, you have three alternatives: G.LITE, G.DMT and T1.413	
Security Protocol	This is the method your ADSL service provider will use to verify your Username and Password when you log on to their network. Your Modem supports the PAP and CHAP protocols.	
VPI	This is the Virtual Path Identifier (VPI). It is used in conjunction with the Virtual Channel Identifier (VCI) below, to identify the data path between your ADSL service provider's network and your computer.	
VCI	This is the Virtual Channel Identifier (VCI). It is used in conjunction with the VPI above to identify the data path between your ADSL service provider's network and your computer.	

Information you will need about your DSL-564T ADSL Router:

Username	This is the Username needed access the Modem's management interface. When you attempt to connect to the device through a web browser you will be prompted to enter this Username. The default Username for the Modem is admin . This may be changed by the user.	Record info here
Password	This is the Password you will be prompted to enter when you access the Modem's management interface. The default Password is admin . This may be changed by the user.	
LAN IP addresses for the DSL-564T	This is the IP address you will enter into the Address field of your web browser to access the Modem's configuration graphical user interface (GUI) using a web browser. The default IP address is 192.168.1.1 and it is referred to as the "Management IP" address in this User's Manual. This may be changed to suit any IP address scheme the user desires. This address will be the base IP address used for DHCP service on the LAN when DHCP is enabled.	
LAN Subnet Mask for the DSL-564T	This is the subnet mask used by the DSL-564T, and will be used throughout your LAN. The default subnet mask is 255.0.0.0 . This can be changed later.	

Information you will need about your LAN or computer:

Ethernet NIC	If your computer has an Ethernet NIC, you can connect the DSL-564T to this Ethernet port using an Ethernet cable. You can also use the Ethernet port on the DSL-564T to connect to other Ethernet devices, such as a Wireless Access Point.	Record info here
DHCP Client status	Your DSL-564T ADSL Modem is configured, by default, to be a DHCP server. This means that it can assign an IP address, subnet mask, and a default gateway address to computers on your LAN. The default range of IP addresses the DSL-564T will assign are from 192.168.1.2 to 192.168.1.254 . Your computer (or computers) needs to be configured to Obtain an IP address automatically (that is, they need to be configured as DHCP clients.)	

It is recommended that you collect and record this information here, or in some other secure place, in case you have to re-configure your ADSL connection in the future.

Once you have the above information, you are ready to setup and configure your DSL-564T ADSL Router.



The Modem may be reset to its factory default settings by performing a Restore settings operation within the management interface (see System Commands). If you cannot gain access to the management interface, you may opt to use the Reset button on the rear panel of the device).

Introduction

This section provides a brief description of the Router, its associated technologies and a list of Router features.

Router Description and Operation

The DSL-564T ADSL Router is designed to provide a simple and cost-effective ADSL Internet connection for individual computers through the Ethernet ports, or use it to bridge your Ethernet LAN to the Internet. The DSL-564T combines the benefits of high-speed ADSL technology and LAN IP management in one compact and convenient package. ADSL technology enables many interactive multi-media applications such as video conferencing and collaborative computing.

The Router is easy to install and use. The DSL-564T connects to computers or an Ethernet LAN via a standard Ethernet interface. The ADSL connection is made using ordinary twisted-pair telephone line with standard connectors. Multiple PCs can be networked and connected to the Internet using a single Wide Area Network (WAN) interface and single global IP address.

The Router supports transparent bridging and can be used for IP packet routing over the Internet. Cost saving features of the Router such as NAT (Network Address Translator) and DHCP (Dynamic Host Configuration Protocol) improve administration efficiency and improve security for your private network. The advanced security enhancements, packet filtering and port redirection, can help protect your network from potentially devastating intrusions by malicious agents from outside your network.

What is ADSL?

Asymmetric Digital Subscriber Line (ADSL) is an access technology that utilizes ordinary copper telephone lines to enable broadband high-speed digital data transmission and interactive multimedia applications for business and residential customers.

ADSL greatly increases the signal carrying capacity of copper telephone lines without interfering with regular telephone services. For the ADSL user, this means faster downloads and more reliable connectivity. ADSL devices make it possible to enjoy benefits such as high-speed Internet access without experiencing any loss of quality or disruption of voice/fax telephone capabilities.

ADSL provides a dedicated service over a single telephone line operating at speeds of up to 8 Mbps downstream and up to 640 Kbps upstream, depending on local telephone line conditions. A secure point-to-point connection is established between the user and the central office of the service provider.

D-Link ADSL devices incorporate the recommendations of the ADSL Forum regarding framing, data format, and upper layer protocols.

Router Features

The DSL-564T ADSL Router utilizes the latest ADSL enhancements to provide a reliable Internet portal suitable for most small to medium sized offices. DSL-564T advantages include:

- **PPP (Point-to-Point Protocol) Security** – The DSL-564T ADSL Router supports PAP (Password Authentication Protocol) and CHAP (Challenge Handshake Authentication Protocol) for PPP connections.
- **DHCP Support** – Dynamic Host Configuration Protocol automatically and dynamically assigns a LAN IP settings to each host on your network. This eliminates the need to reconfigure every host whenever changes in network topology occur.
- **Network Address Translation (NAT)** – For small office environments, the DSL-564T allows multiple users on the LAN to access the Internet concurrently through a single Internet account. This provides Internet access to everyone in the office for the price of a single user.

NAT improves network security in effect by hiding the private network behind one global and visible IP address. NAT address mapping can also be used to link two IP domains via a LAN-to-LAN connection.

- **TCP/IP (Transfer Control Protocol/Internet Protocol)** – The DSL-564T supports TCP/IP protocol, the language used for the Internet. It is compatible with access servers manufactured by major vendors.
- **RIP-1/RIP-2** – The DSL-564T supports both RIP-1 and RIP-2 exchanges with other routers. Using both versions lets the Router to communicate with all RIP enabled devices.
- **Static Routing** – This allows you to select a data path to a particular network destination that will remain in the routing table and never “age out”. If you wish to define a specific route that will always be used for data traffic from your LAN to a specific destination within your LAN (for example to another router or a server) or outside your network (to a ISP defined default gateway for instance).
- **Default Routing** – This allows you to choose a default path for incoming data packets for which the destination address is unknown. This is particularly useful when if the Router functions as the sole connection to the Internet.
- **ATM (Asynchronous Transfer Mode)** – The DSL-564T supports Bridged Ethernet over ATM (RFC1483), IP over ATM (RFC1577) and PPP over ATM (RFC 2364).
- **Precise ATM Traffic Shaping** – Traffic shaping is a method of controlling the flow rate of ATM data cells. This function helps to establish the Quality of Service for ATM data transfer.
- **G.hs (Auto-handshake)** – This allows the Router to automatically choose either the G.lite or G.dmt ADSL connection standards.
- **High Performance** – Very high rates of data transfer are possible with the Router. Up to eight Mbps downstream bit rate using the G.dmt.
- **Full Network Management** – The DSL-564T incorporates SNMP (Simple Network Management Protocol) support for web-based management and text-based network management via an RS-232 or Telnet connection.
- **Telnet Connection** – The Telnet enables a network manager to access the Router’s management software remotely.
- **Easy Installation** – The DSL-564T uses a web-based graphical user interface program for convenient management access and easy set up. Any common web browser software can be used to manage the Router.

Standards Compatibility and Compliance

The DSL-564T complies with or is compatible with the following standards as recognized by their respective agencies.

- ITU G.992.2 (G.lite “Splitterless ADSL”) compliant
- ITU-T Rec. I.361 compliant
- RFC 791 Internet Protocol compliant
- RFC 792 UDP compliant
- RFC 826 Address Resolution Protocol compliant (ARP) compliant
- RFC 1058 Routing Information Protocol (RIP) compliant
- RFC 1213 MIB II for IP compliant
- RFC 1334 PPP Authentication Protocol compliant
- RFC 1389 Routing Information Protocol 2 (RIP2) compliant
- RFC 1483 IP over AAL5/ Bridged Ethernet over AAL5 compliant
- RFC 1557 Classical IP over ATM (IPoA) compliant
- RFC 1661 Point to Point Protocol (PPP) compliant
- RFC 1877 Automatic IP assignment compliant
- RFC 1994 Challenge Handshake Authentication Protocol compliant
- Supports RFC 2131 and RFC 2132 DHCP functions including: automatic assignment of IP address, use of subnet mask and default gateway and provision of DNS server address for all hosts
- RFC 2364 PPP over ATM compliant (PPPoA) compliant
- RFC 2516 PPP over Ethernet compliant (PPPoE) compliant
- RFC 2684 Bridged/Routed Ethernet over ATM compliant
- IEEE 802.3 compliant
- IEEE 802.3u compliant
- IEEE 802.1d compliant
- IEEE 802.3x compliant
- Embedded web server support
- Supports Dynamic Learning
- Supports Static Routing
- Supports NAT for up to 4096 connections
- Supports DHCP for up to 253 hot connections
- Supports IGMP
- Supports ATM Forum UNI 3.1/4.0
- Supports ATM VCC (Virtual Channel Circuit) for up to eight sessions
- Supports TELNET and TFTP
- Supports back pressure for half-duplex

Packing List

Open the shipping carton and carefully remove all items. In addition to this User's Guide, ascertain that you have:

- One DSL-564T ADSL Router
- One twisted-pair telephone cable used for ADSL connection
- One straight-through Ethernet cable
- One AC power adapter suitable for your electric service
- An Installation CD-ROM containing this User's Guide

Front Panel Display

Place the Router in a location that permits an easy view of the LED indicators on the front panel.

The LED indicators on the front panel include the **Power**, **Status**, **ADSL Link/Act** and **LAN (1-4) Link/Act** indicators. The ADSL and Ethernet indicators monitor link status and activity (Link/Act).

Power	Steady green light indicates the unit is powered on. When the device is powered off this remains dark.
Status	Lights steady green during power on self-test (POST). Once the connection status has been settled, the light will blink green. If the indicator lights steady green after the POST, the system has failed and the device should be rebooted.
ADSL: Link/Act	Steady green light indicates a valid ADSL connection. This will light after the ADSL negotiation process has been settled. A blinking green light indicates activity on the WAN (ADSL) interface.
LAN 1 - 4: Link/Act	A solid green light indicates a valid link on startup. These lights blink when there is activity currently passing through the Ethernet port.



Rear Panel Connections

All cable connections to the Router are made at the rear panel. Connect the power adapter here to power on the Router. Use the Reset button to restore the settings to the factory default values.

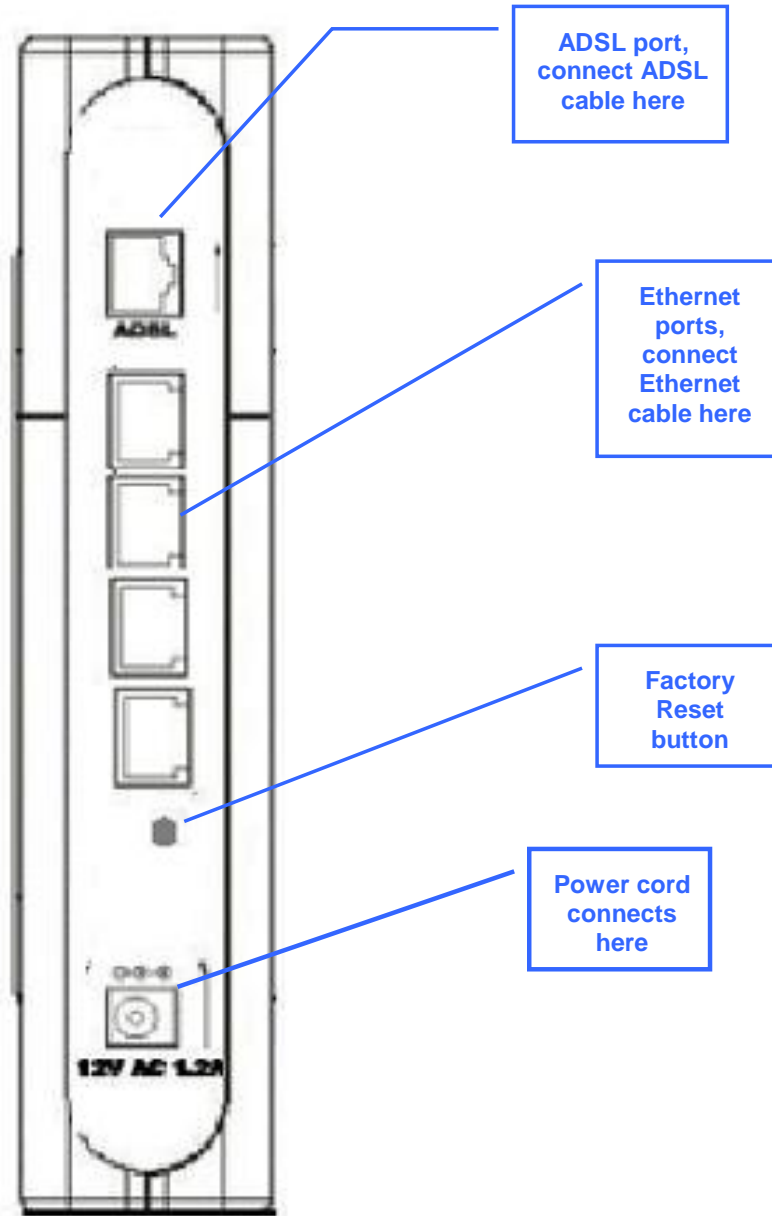

Note

The Router may be rebooted by disconnecting and then reconnecting the power.

Hardware Installation

The DSL-564T maintains five separate interfaces, four Ethernet and one ADSL interface. Place the Router in a location where it can be safely connected to the various devices as well as to a power source. The Router should not be located where it will be exposed to moisture or excessive heat. Make sure the cables and power cord are placed safely out of the way so they do not create a tripping hazard. As with any electrical appliance, observe common sense safety precautions.

The Router can be placed on a shelf or desktop, ideally you should be able to see the LED indicators on the front if you need to view them for troubleshooting.

Power on Router



CAUTION: The Router must be used with the power adapter included with the device.

To power on the Router:

1. Insert the AC Power Adapter cord into the power receptacle located on the rear panel of the Router and plug the adapter into a suitable nearby power source.
2. You should see the Power LED indicator light up and remain lit. The Status LED should light solid green and begin to blink after a few seconds.
3. If the Ethernet port is connected to a working device, check the Ethernet Link/Act LED indicators to make sure the connection is valid. The Router will attempt to establish the ADSL connection, if the ADSL line is connected and the Router is properly configured this should light up after several seconds. If this is the first time installing the device, some settings may need to be changed before the Router can establish a connection.

Factory Reset Button

The Router may be reset to the original factory default settings by depressing the reset button for a few seconds while the device is powered on. Use a ballpoint or paperclip to gently push down the reset button. Remember that this will wipe out any settings stored in flash memory including user account information and LAN IP settings. The factory default IP address of the Router is 192.168.1.1 and the subnet mask is 255.255.255.0, the default management Username is **admin** and the default Password is **admin**.

Network Connections

Network connections are provided through the ADSL port and the four Ethernet ports on the back of the Router. See the Rear Panel diagram above and the illustrations below for examples.

Connect ADSL Line

Use the ADSL cable included with the Router to connect it to a telephone wall socket or receptacle. Plug one end of the cable into the ADSL port (RJ-11 receptacle) on the rear panel of the Router and insert the other end into the RJ-11 wall socket. If you are using a low pass filter device, follow the instructions included with the device or given to you by your service provider. The ADSL connection represents the WAN interface, the connection to the Internet. It is the physical link to the service provider's network backbone and ultimately to the Internet.

Connect Router to Ethernet

The Router may be connected to a single computer or Ethernet device through the 10BASE-TX Ethernet port on the rear panel. Any connection to an Ethernet concentrating device such as a switch or hub must operate at a speed of 10/100 Mbps only. When connecting the Router to any Ethernet device that is capable of operating at speeds higher than 10Mbps, be sure that the device has auto-negotiation (NWay) enabled for the connecting port.

Use standard twisted-pair cable with RJ-45 connectors. The RJ-45 port on the Router is a crossed port (MDI-X). Follow standard Ethernet guidelines when deciding what type of cable to use to make this connection. When connecting the Router directly to a PC or server use a normal straight-through cable. You should use a crossed cable when connecting the Router to a normal (MDI-X) port on a switch or hub. Use a normal straight-through cable when connecting it to an uplink (MDI-II) port on a hub or switch.

The rules governing Ethernet cable lengths apply to the LAN to Router connection. Be sure that the cable connecting the LAN to the Router does not exceed 100 meters.

Hub or Switch to Router Connection

Connect the Router to an uplink port on an Ethernet hub or switch with a straight-through cable as shown in the diagram below:

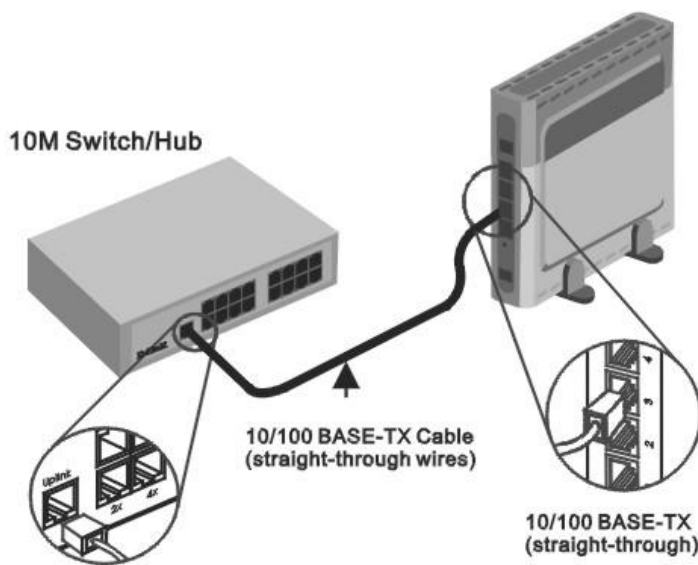

If you wish to reserve the uplink port on the switch or hub for another device, connect to any on the other MDI-X ports (1x, 2x, etc.) with a crossed cable.

Computer to Router Connection

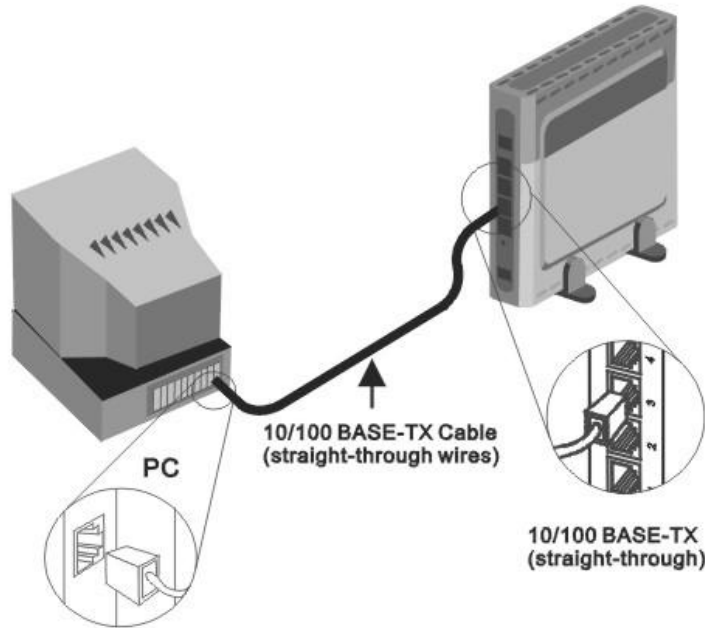

You can connect the Router directly to a 10/100BASE-TX Ethernet adapter card (NIC) installed on a PC using the Ethernet cable provided as shown in this diagram.

Power On Router

To power on the Router:

1. Insert the AC Power Adapter cord into the power receptacle located on the rear panel of the Router and plug the adapter into a suitable nearby power source.
2. You should see the Power LED indicator light up and remain lit. The Status LED should light solid green and begin to blink after a few seconds.
3. If you have the Router connected to your network you can look at the Ethernet Link/Act LED indicators to make sure they have valid connections. The Router will attempt to establish the ADSL connection, if the ADSL line is connected and the connection is properly configured this should light up after several seconds.

Factory Reset Button

The Router may be reset to the original factory default settings by depressing the reset button for a few seconds while the device is powered on. Use a ballpoint or paperclip to push down the reset button. Remember that this will wipe out any settings stored in flash memory including IP settings. The factory default IP address of the Router is 192.168.1.1 and the subnet mask is 255.255.255.0.

Basic Router Configuration

The first time you setup the Router it is recommended that you configure the WAN connection using a single computer making sure that both the computer and the Router are not connected to the LAN. Once the WAN connection is functioning properly, you may continue to make changes to Router configuration including IP settings and DHCP setup. This chapter is concerned with using your computer to configure the WAN connection. The following chapter describes the various menus used to configure and monitor the Router including how to change IP settings and DHCP server setup.

Wan Configuration Summary

1. **Connect to the Router** To configure the WAN connection used by the Router it is first necessary to communicate with the Router through its management interface, which is HTML-based and can be accessed using a web browser. To access the management software your computer must be able to “see” the Router. Your computer can see the Router if it is in the same “neighborhood” or subnet as the Router. This is accomplished by making sure your computer has IP settings that place it in the same subnet as the Router. The easiest way to make sure your computer has the correct IP settings is to configure it to use the DHCP server in the Router. The next section describes how to change the IP configuration for a computer running a Windows operating system to be a DHCP client.
2. **Configure the WAN Connection** Once you are able to access the configuration software you can proceed to change the settings required to establish the ADSL connection and connect to the service provider’s network. There are different methods used to establish the connection to the service provider’s network and ultimately to the Internet. You should know what Encapsulation and connection type you are required to use for your ADSL service. It is also possible that you must change the PVC settings used for the ADSL connection. Your service provider should provide all the information you need to configure the WAN connection.

Configuring IP Settings on Your Computer

In order to configure your system to receive IP settings from the Router it must first have the TCP/IP protocol installed. If you have an Ethernet port on your computer, it probably already has TCP/IP protocol installed. If you are using Windows XP the TCP/IP is enabled by default for standard installations. Below is an illustrated example of how to configure a Windows XP system to automatically obtain IP settings from the Router. Following this example is a step-by-step description of the procedures used on the other Windows operating systems to first check if the TCP/IP protocol has been installed; if it is not, instructions are provided for installing it. Once the protocol has been installed you can configure the system to receive IP settings from the Router.

For computers running non-Windows operating systems, follow the instructions for your OS that configure the system to receive an IP address from the Router, that is, configure the system to be a DHCP client.



If you are using this Router to provide Internet access for more than one computer, you can use these instructions later to change the IP settings for the other computers. However, you cannot use the same IP address since every computer must have its own IP address that is unique on the local network.

Configure Windows XP for DHCP

Use the following steps to configure a computer running Windows XP to be a DHCP client.

1. From the **Start** menu on your desktop, go to **Settings**, then click on **Network Connections**.



2. In the **Network Connections** window, right-click on **LAN (Local Area Connection)**, then click **Properties**.

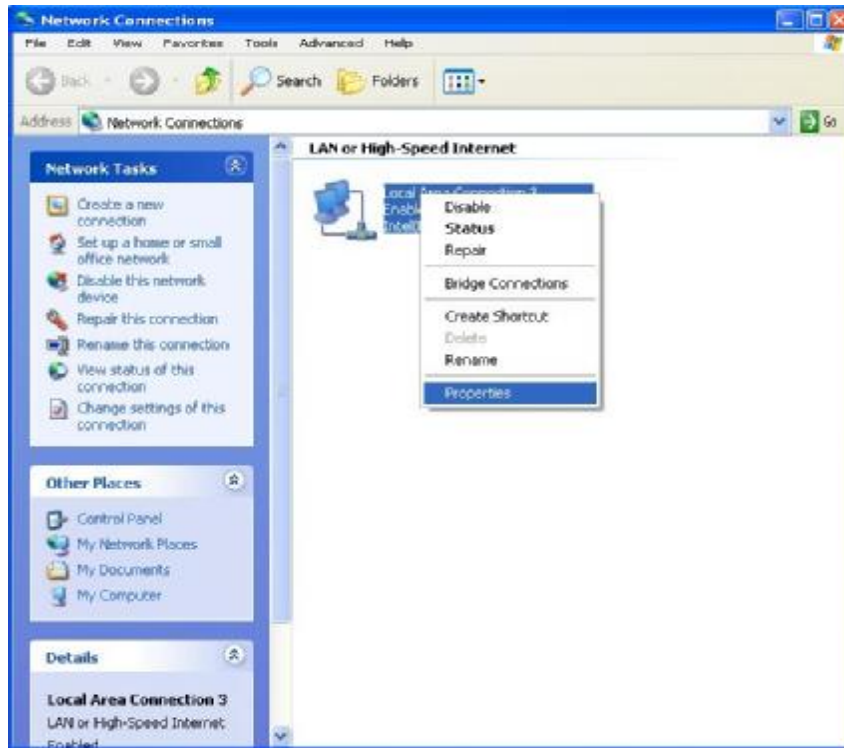

3. In the **General** tab of the **Local Area Connection Properties** menu, highlight **Internet Protocol (TCP/IP)** under “This connection uses the following items:” by clicking on it once. Click on the **Properties** button.

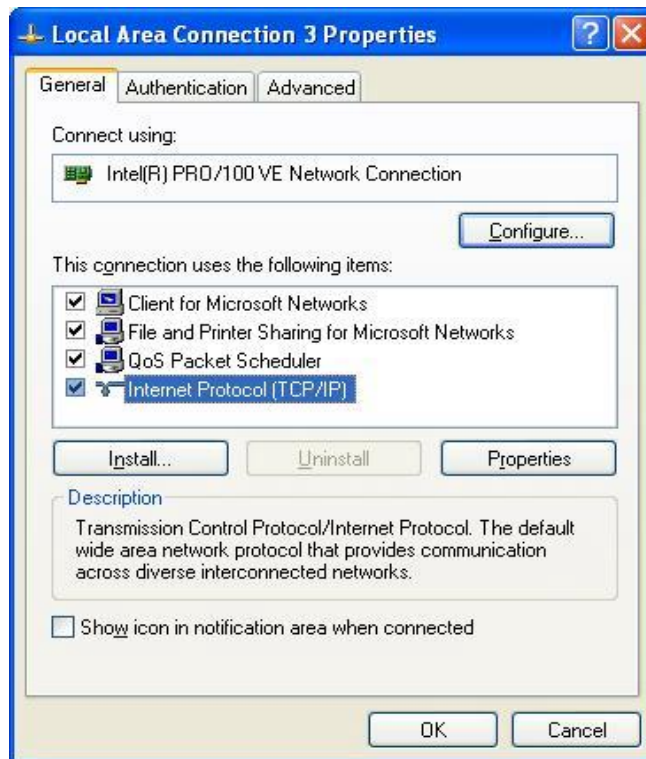

4. Select "Obtain an IP address automatically" by clicking once in the circle. Click the **OK** button.

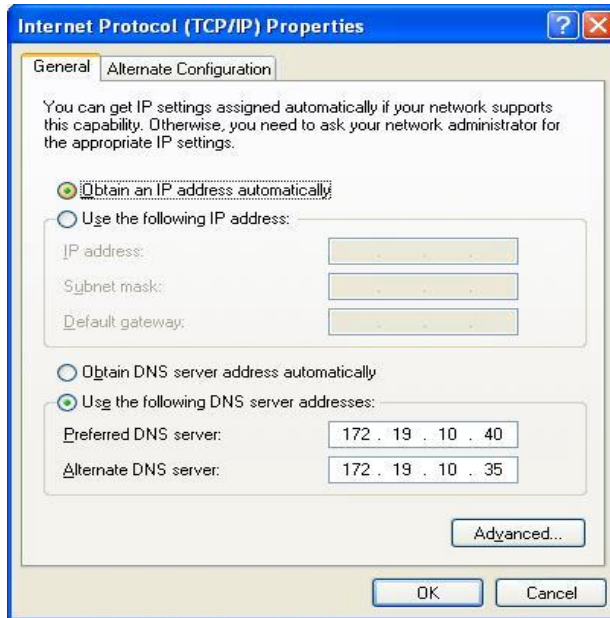

Your computer is now ready to use the Router's DHCP server.

Windows 2000

First, check for the IP protocol and, if necessary, install it:

1. In the **Windows** task bar, click the **Start** button, point to **Settings**, and then click **Control Panel**.
2. Double-click the **Network and Dial-up Connections** icon.
3. In the **Network and Dial-up Connections** window, right-click the **Local Area Connection** icon, and then select **Properties**.
4. The **Local Area Connection Properties** dialog box displays with a list of currently installed network components. If the list includes Internet Protocol (TCP/IP), then the protocol has already been enabled, skip ahead to *Configure Windows 2000 for DHCP*.
5. If Internet Protocol (TCP/IP) does not display as an installed component, click **Install**.
6. In the **Select Network Component Type** dialog box, select **Protocol**, and then click **Add**.
7. Select **Internet Protocol (TCP/IP)** in the Network Protocols list, and then click **OK**.
8. You may be prompted to install files from your Windows 2000 installation CD or other media. Follow the instructions to install the files.
9. If prompted, click **OK** to restart your computer with the new settings.

Configure Windows 2000 for DHCP

1. In the Control Panel, double-click the **Network and Dial-up Connections** icon.
2. In **Network and Dial-up Connections** window, right-click the **Local Area Connection** icon, and then select **Properties**.
3. In the **Local Area Connection Properties** dialog box, select **Internet Protocol (TCP/IP)**, and then click **Properties**.
4. In the **Internet Protocol (TCP/IP) Properties** dialog box, click the button labeled **Obtain an IP address automatically**.
5. Double-click **OK** to confirm and save your changes, and then close the Control Panel.

Your computer is now ready to use the Router's DHCP server.

Windows ME

First, check for the IP protocol and, if necessary, install it:

1. In the **Windows** task bar, click the **Start** button, point to **Settings**, and then click **Control Panel**.
2. Double-click the **Network and Dial-up Connections** icon.
3. In the **Network and Dial-up Connections** window, right-click the **Network** icon, and then select **Properties**.
4. The **Network Properties** dialog box displays with a list of currently installed network components. If the list includes Internet Protocol (TCP/IP), then the protocol has already been enabled. Skip ahead to *Configure Windows ME for DHCP*.
5. If Internet Protocol (TCP/IP) does not display as an installed component, click **Add**.
6. In the **Select Network Component Type** dialog box, select **Protocol**, and then click **Add**.
7. Select **Microsoft** in the Manufacturers box.
8. Select **Internet Protocol (TCP/IP)** in the Network Protocols list, and then click **OK**.
9. You may be prompted to install files from your Windows Me installation CD or other media. Follow the instructions to install the files.
10. If prompted, click **OK** to restart your computer with the new settings.

Configure Windows ME for DHCP

1. In the **Control Panel**, double-click the **Network and Dial-up Connections** icon.
2. In the **Network and Dial-up Connections** window, right-click the **Network** icon, and then select **Properties**.
3. In the **Network Properties** dialog box, select **TCP/IP**, and then click **Properties**.
4. In the **TCP/IP Settings** dialog box, click the **Obtain an IP address automatically** option.
5. Double-click **OK** twice to confirm and save your changes, and then close the Control Panel.

Your computer is now ready to use the Router's DHCP server.

Windows 95 and Windows 98

First, check for the IP protocol and, if necessary, install it:

1. In the **Windows** task bar, click the **Start** button, point to **Settings**, and then click **Control Panel**. Double-click the **Network** icon.
2. The **Network** dialog box displays with a list of currently installed network components. If the list includes TCP/IP, and then the protocol has already been enabled, skip to *Configure IP Information Windows 95, 98*.
3. If TCP/IP does not display as an installed component, click **Add**. The **Select Network Component Type** dialog box displays.
4. Select **Protocol**, and then click **Add**. The **Select Network Protocol** dialog box displays.
5. Click on **Microsoft** in the Manufacturers list box, and then click **TCP/IP** in the Network Protocols list box.
6. Click **OK** to return to the Network dialog box, and then click **OK** again. You may be prompted to install files from your Windows 95/98 installation CD. Follow the instructions to install the files.
7. Click **OK** to restart the PC and complete the TCP/IP installation.

Configure Windows 95 and Windows 98 for DHCP

1. Open the **Control Panel** window, and then click the **Network** icon.
2. Select the network component labeled TCP/IP, and then click **Properties**.
3. If you have multiple TCP/IP listings, select the listing associated with your network card or adapter.
4. In the **TCP/IP Properties** dialog box, click the **IP Address** tab.
5. Click the **Obtain an IP address automatically** option.
6. Double-click **OK** to confirm and save your changes. You will be prompted to restart Windows.
7. Click **Yes**.

When it has restarted your computer is ready to use the Router's DHCP server.

Windows NT 4.0 Workstations

First, check for the IP protocol and, if necessary, install it:

1. In the **Windows NT** task bar, click the **Start** button, point to **Settings**, and then click **Control Panel**.
2. In the **Control Panel** window, double-click the **Network** icon.
3. In the **Network** dialog box, click the **Protocols** tab.
4. The **Protocols** tab displays a list of currently installed network protocols. If the list includes TCP/IP, then the protocol has already been enabled. Skip to "Configure IP Information"
5. If TCP/IP does not display as an installed component, click **Add**.
6. In the **Select Network Protocol** dialog box, select **TCP/IP**, and then click **OK**. You may be prompted to install files from your Windows NT installation CD or other media. Follow the instructions to install the files.
7. After all files are installed, a window displays to inform you that a TCP/IP service called DHCP can be set up to dynamically assign IP information.
8. Click **Yes** to continue, and then click **OK** if prompted to restart your computer.

Configure Windows NT 4.0 for DHCP

1. Open the **Control Panel** window, and then double-click the **Network** icon.
2. In the **Network** dialog box, click the **Protocols** tab.
3. In the **Protocols** tab, select **TCP/IP**, and then click **Properties**.
4. In the **Microsoft TCP/IP Properties** dialog box, click the **Obtain an IP address automatically** option.
5. Click **OK** twice to confirm and save your changes, and then close the Control Panel.

Access the Configuration Manager

Now that your computer's IP settings allow it to communicate with the Router, you can access the configuration software.



Be sure that the web browser on your computer is not configured to use a proxy server in the Internet settings. In Windows Internet Explorer, you can check if a proxy server is enabled using the following procedure:

1. In Windows, click on the **Start** button, go to **Settings** and choose **Control Panel**.
2. In the **Control Panel** window, double-click on the **Internet Options** icon.
3. Click the **Connections** tab and click on the **LAN Settings** button.
4. Verify that the "Use proxy server" option is **NOT** checked. If it is checked, click in the checked box to deselect the option and click **OK**.

*Alternatively, you can access this **Internet Options** menu using the **Tools** pull-down menu in Internet Explorer.*

To use the web-based management software, launch a suitable web browser and direct it to the IP address of the Router. Type in **http://** followed by the default IP address, **192.168.1.1** in the address bar of the browser. The URL in the address bar should read: **http://192.168.1.1**.

Login to Home Page

A new window will appear and you will be prompted for a user name and password to access the web-based manager.



Figure 3-1. Home - Login window

Use the default user name **admin** and password **admin** for first time setup. You should change the web-based manager access user name and password once you have verified that a connection can be established. The user name and password allows any PC within the same subnet as the Modem to access the web-based manger.



Note

Do not confuse the user name and password used to access the web-based manager with the ADSL account user name and password needed for PPP connections to access the service provider's network.

Configure the Router

The first page that appears after you successfully login displays information about the Router and its connection status. Tabs across the top of the screen show other available menus: **Setup**, **Advanced**, **Tools**, **Status**, and **Help**.

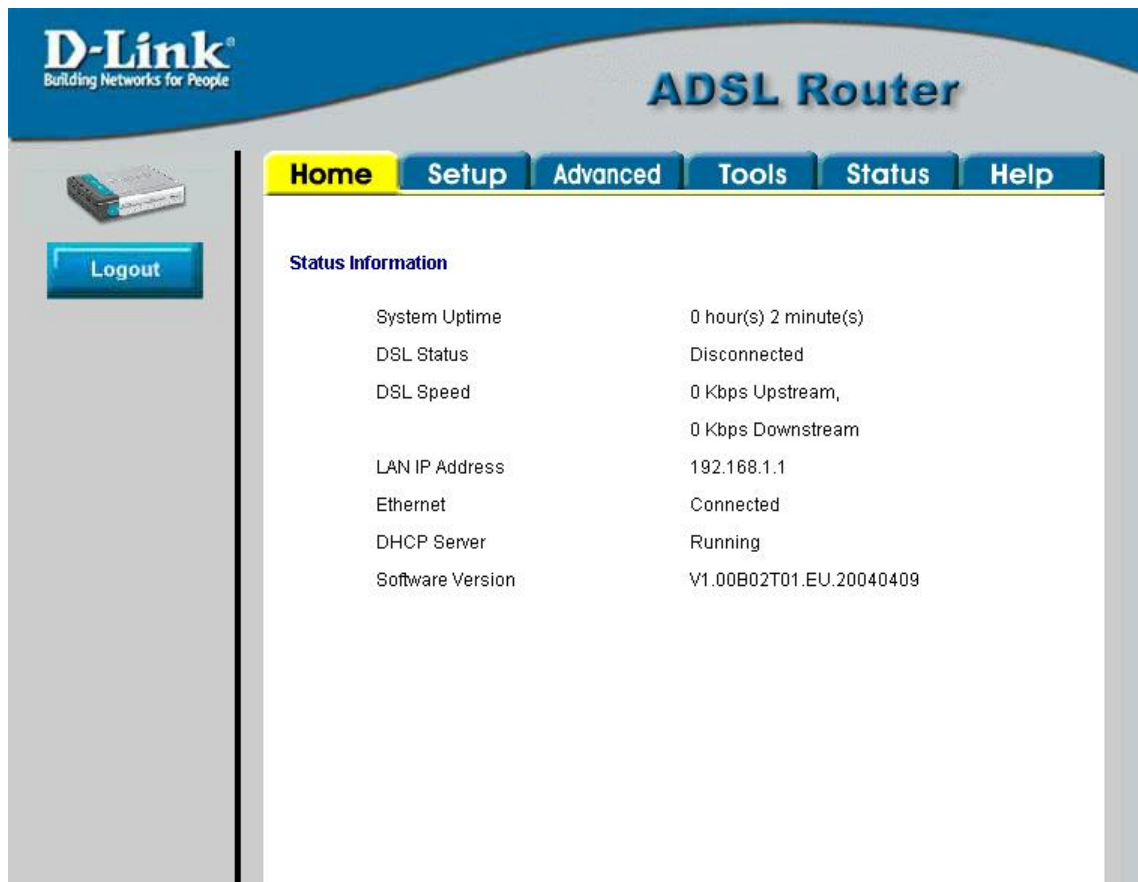

Figure 3-2. Home – Status Information window

When the Router is used to provide Internet access it actually must first access your service provider's network, that is, it must communicate with computers and other routers owned by your service provider. These computers and routers then provide access to the Internet. The Router must be configured to communicate with the systems that give it access to the larger network. Click either the **Setup** tab (or the **Go to setup wizard** hyperlink); the Setup window will appear.

Setup Menu

The **Setup** window offers links to menus to configure settings for the LAN (Local Area Network) and for the WAN (Wide Area Network) setup. The first menu you see when clicking the **Setup** tab or the **Go to setup wizard** hyperlink is the Setup menu.

Now you are ready to configure the settings needed for the WAN connection. All the information you need to make the changes needed for a functioning WAN connection should have been provided to you by your ISP or network service provider.

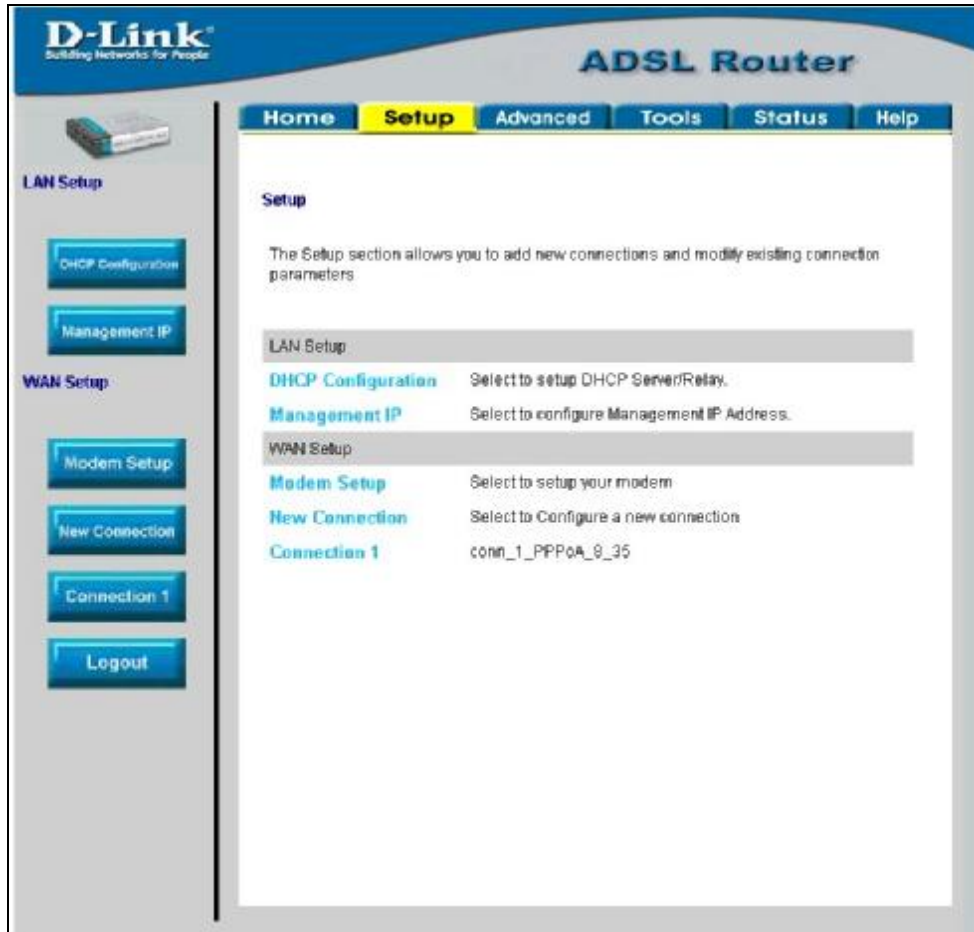

Figure 3-3. Opening Setup window

If you are not instructed to change the modulation type, click the **Connection 1** button or hyperlink to configure the other WAN settings. Skip ahead to Configure Connection 1 for PPPoA below to configure a PPPoA connection type. For other connection types such as PPPoE, CLIP (IPoA) or Bridge type connections, read Change the Connection Type to first change the connection type used by the Router.

If you are instructed to change the method of modulation used for ADSL, click the **Modem Setup** button or Modem Setup hyperlink and select the Modulation Type used for the connection. Skip ahead to the next page for an example of the Modem Setup menu. Then proceed to Configure Connection to configure a PPPoA connection or Change the Connection Type for other connection types.

DSL (Modulation) Settings

The DSL Setup menu is used to change the Modulation Type used for the ADSL connection. This setting should only be changed if your service provider has given explicit instructions to change it.



Do not change the (ADSL) Modulation type used unless you have been instructed to do so. If this setting is not configured properly, the Router will not work.

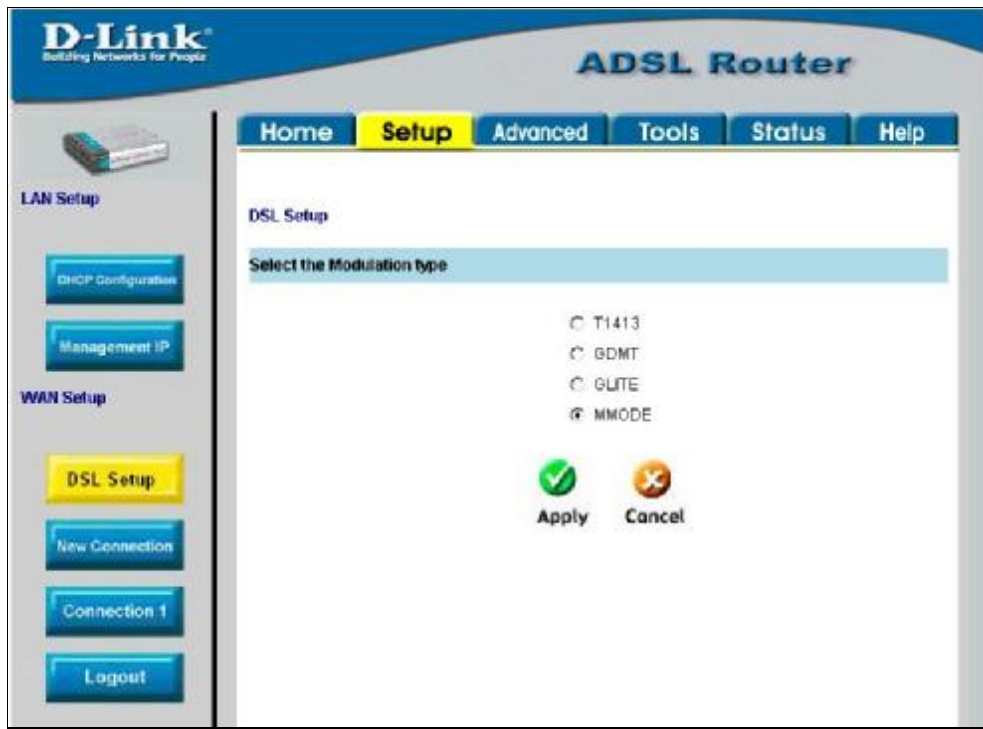

Figure 3-4. DSL Setup menu (change modulation type)

If you are instructed by your ISP to change the Modulation type is used for your service, select the desired modulation type and then click **Apply**. The modulation types available are **T1413**, **G.DMT**, **GLITE** and **MMODE**. By default, the Router will automatically detect the modulation used; this setting is listed as MMODE (Multi-mode).

Configure Connection 1 for PPPoA

PPP or Point-to-Point protocol is a standard method of establishing a network connection/session between networked devices. Different forms of PPP include PPPoA and PPPoE (discussed below) involve an authentication process that requires a username and password to gain access to the network. PPPoA (PPP over ATM) as described in RFC 2364, is a method of using PPP on an ATM network. ATM is used for many types of telecommunications services including ADSL.

To configure the WAN connection for PPPoA, perform the steps listed below. Some of the settings do not need to be changed the first time the device is set up, but can be changed later if you choose.

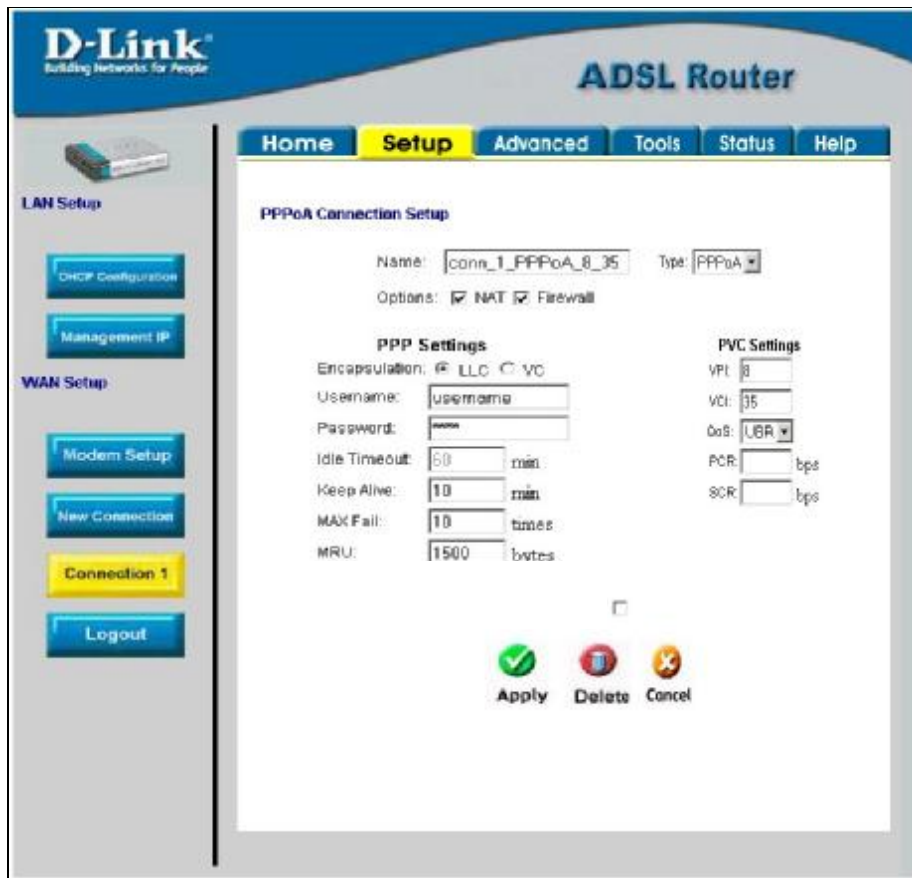

Figure 3- 5. PPPoA Connection 1 Setup menu

To configure the default connection type (PPPoA) for Connection 1, follow the steps listed below. To change the connection type of Connection 1 to an alternative type follow the instructions according to the desired type as described below in Change the Connection Type.

1. Click the **Connection 1** button under **WAN Setup** to view the **PPPoA Connection Setup** menu pictured in the example above.
2. Type in a **Name** for the connection or use the default name *conn_1_PPPoA_8_35* in the space provided.
3. Under **Options**, enable **NAT** and/or **Firewall** by selecting the corresponding selection box.
4. If you are told to change the **VPI** or **VCI** values, type in the values given to you by your service provider. Many users will be able to use the default settings.
5. Leave the default **QoS** values if you are unsure or the ISP did not provide this information.
6. Do not change the **PCR** or **SCR** values unless you are required to do so. If you are told to change these, type in the values given to you by your service provider.
7. Type the **Username** and **Password** used to verify the identity of your account. Typically, the Username is an account number assigned by your ISP and appears in the form *account#@serviceprovider.com*, while the Password may have been chosen by the account holder. For most users, the remaining settings will not need to be changed. See your ISP for further information.

8. Click the **Apply** button when you have entered all the information. The web browser will briefly go blank. You are now finished changing setting for the primary WAN connection known as Connection 1. It is now necessary to save the changes you just made and restart the Router.
9. To save the changes made to Connection 1, click the **Tools** tab and then click on the **System Commands** button. Click on the **Save All** button to store the configuration settings. Click on **Back** button to return to the System Commands menu.
10. Check the WAN connection status. Click the **Status** tab and then the **Connection Status** button. Look under **WAN** to view the **State** of Connection 1, it should read *Connected*. If the WAN connection state does not appear to *Connected* after a few minutes, go back to the Connection 1 Setup menu, check the settings and make sure they are correct.

Change the Connection Type

The default connection protocol used for the Router is Point-to-Point Protocol over ATM (PPPoA). The menu used to configure a PPPoA connection is the first menu to appear when you click on the **Connection 1** button in the Setup menu. The alternative connection types supported by the Router are the **PPPoE** (PPP over Ethernet), **CLIP** (Classical IP over ATM or IPoA), **DHCP** (for WAN), **Static** (IP for WAN), and **Bridge** connection types. There are two ways you may configure the WAN connection to use these alternative types. You can create a **New Connection** using the alternative connection type or you may configure the Connection 1 settings to use the connection type of choice. This section describes how to change the Connection 1 settings to use a different connection type. To change the Connection 1 settings to use a different connection type, follow the instructions below according to the type of connection you want to use. To create and configure a New Connection, skip ahead to Create a New Connection.

Configure Connection 1 for PPPoE

PPP or Point-to-Point protocol is a standard method of establishing a network connection/session between networked devices. PPPoE configuration requires the same basic information as the previously discussed PPPoA and both menus are nearly identical. It may be worthwhile for the user to change the default name of Connection 1 to something that states what connection type is being used, for example, *conn_1_pppoe_8_35*, the name used in the example below. Notice the VPI and VCI values are included in the name. It is not functionally necessary to change the name of the connection, this is done merely to provide descriptive reference.

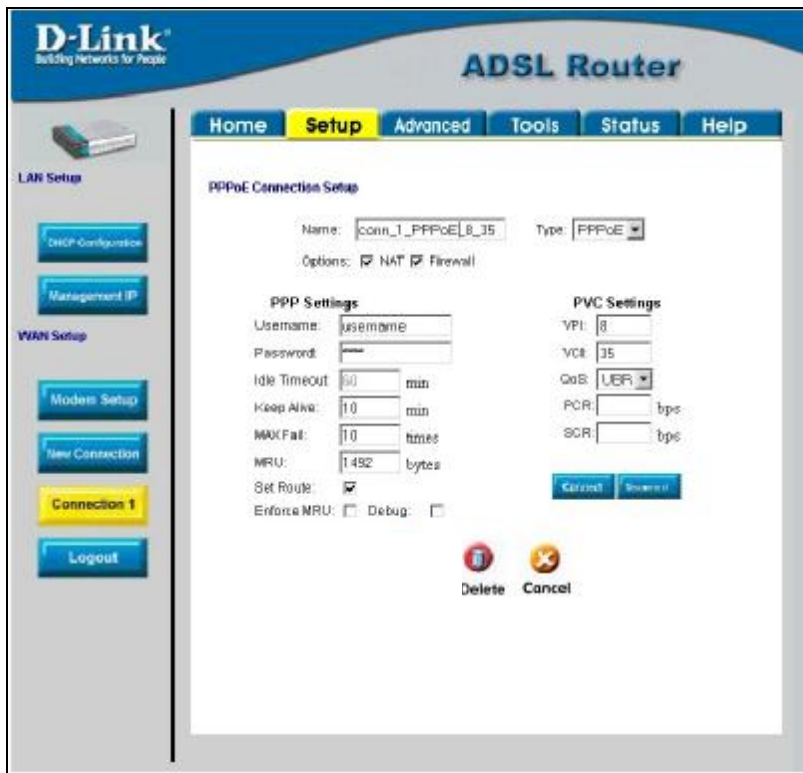

Figure 3-6. Setup – Configure Connection 1 for PPPoE

To configure Connection 1 for PPPoE, follow the steps listed below. Some of the settings do not need to be changed the first time the device is set up, but can be changed later if you choose.

1. Click the **Connection 1** button under **WAN Setup** to view the default **PPPoA Connection Setup** configuration menu.
2. Select *PPPoE* from the **Type:** pull-down menu. The menu will blink momentarily.
3. Type in a **Name:** for the connection or use the default name in the space provided (*conn_1_PPPoE_8_35* used in the above example).
4. Under **Options**, enable **NAT** and/or **Firewall** by selecting the corresponding selection box.
5. If you are told to change the **VPI** or **VCI** values, type in the values given to you by your service provider. Many users will be able to use the default settings.
6. Leave the default **QoS** values if you are unsure or the ISP did not provide this information.
7. Do not change the **PCR** or **SCR** values unless you are required to do so. If you are told to change these, type in the values given to you by your service provider.
8. Type the **Username** and **Password** used to verify the identity of your account. Typically, the Username is an account number assigned by your ISP and appears in the form *account#@serviceprovider.com*, while the Password may have been chosen by the account holder. For most users, the remaining settings will not need to be changed. See your ISP for further information.
9. Click the **Apply** button when you have entered all the information. The web browser will briefly go blank. You are now finished changing setting for the primary WAN connection known as Connection 1. It is now necessary to save the changes you just made and restart the Router.
10. To save the changes made to Connection 1, click the **Tools** tab and then click on the **System Commands** button. Click on the **Save All** button to store the configuration settings. Click on **Back** button to return to the System Commands menu.

11. Check the WAN connection status. Click the **Status** tab and then the **Connection Status** button. Look under **WAN** to view the **State** of Connection 1, it should read *Connected*. If the WAN connection state does not appear to *Connected* after a few minutes, go back to the Connection 1 Setup menu, check the settings and make sure they are correct.

Configure Connection 1 for Bridge

“Bridge” means a pure bridged connection with no IP address assigned to the Router. This connection method makes the Router act as a bridge, and just passes packets across the DSL port. When the device is used in this manner, it is necessary to install additional connection software on any computer or server used to access the Internet.

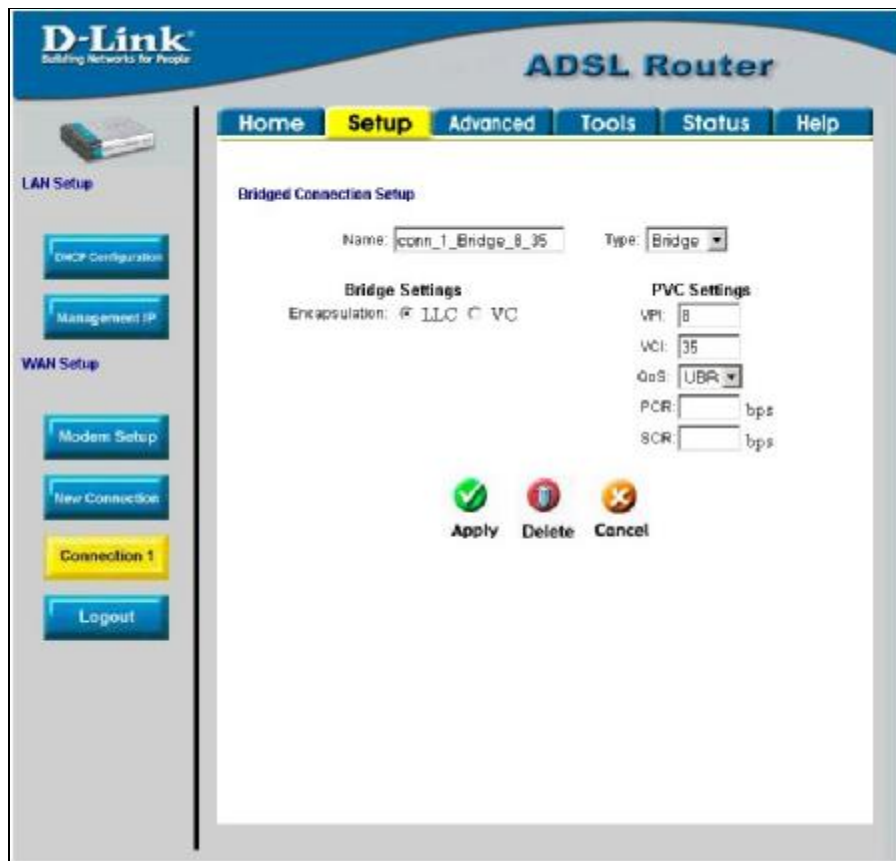

Figure 3-7. Setup – Configure Connection 1 for Bridge

To configure the WAN connection for Bridge, perform the steps listed below. Some of the settings do not need to be changed the first time the device is set up, but can be changed later if you choose.

1. Click the **Connection 1** button under **WAN Setup** to view the default **PPPoA Connection Setup** configuration menu.
2. Select *Bridge* from the **Type:** pull-down menu. This action will change the menu so it offers fewer settings for configuration.
3. Type in a **Name:** in the space provided (*conn_1_Bridge_8_35* is used in the above example).
4. If you are told to change the **VPI** or **VCI** values, type in the values given to you by your service provider. Many users will be able to use the default settings.
5. Leave the default **QoS** values if you are unsure or the ISP did not provide this information.

6. Do not change the **PCR** or **SCR** values unless you are required to do so. If you are told to change these, type in the values given to you by your service provider.
7. The **Encapsulation** values LLC (SNAP) and VC (MUX) are two different methods of encapsulating the PPP packet. Contact your ISP to make sure which encapsulation is being supported.
8. Click the **Apply** button when you have entered all the information. The web browser will briefly go blank. You are now finished changing setting for the primary WAN connection known as Connection 1. It is now necessary to save the changes you just made and restart the Router.
9. To save the changes made to Connection 1, click the **Tools** tab and then click on the **System Commands** button. Click on the **Save All** button to store the configuration settings. Click on **Back** button to return to the System Commands menu.
10. Check the WAN connection status. Click the **Status** tab and then the **Connection Status** button. Look under **WAN** to view the **State** of Connection 1, it should read *Connected*. If the WAN connection state does not appear to *Connected* after a few minutes, go back to the Connection 1 Setup menu, check the settings and make sure they are correct.

Configure Connection 1 for Static IP for WAN

Static is used whenever a known static IP is assigned. The accompanying information such as the Subnet mask and the gateway should also be specified in order to be able to connect. Up to three Domain Name Server (DNS) addresses can also be specified. These are the servers would enable you to have access to other web servers. Valid IP addresses range from 1.0.0.1 to 223.255.255.254.

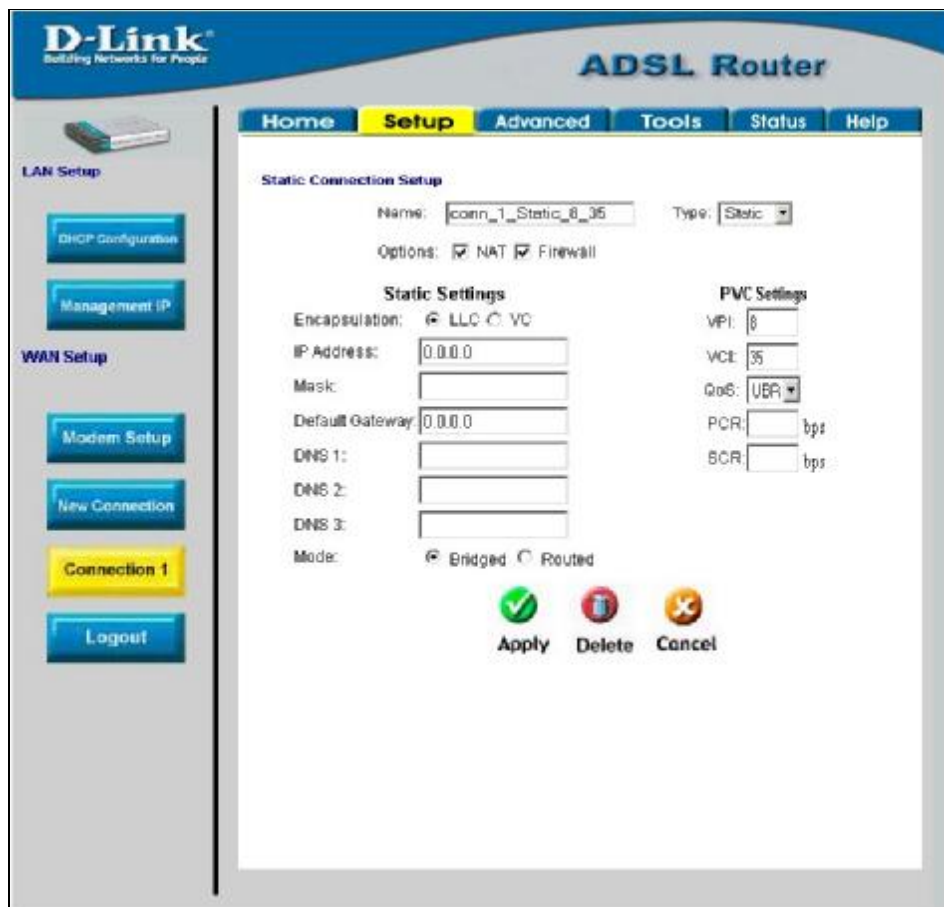

Figure 3-8. Setup – Configure Connection 1 for Static IP for the WAN

To configure the WAN connection for Static, perform the steps listed below. Some of the settings do not need to be changed the first time the device is set up, but can be changed later if you choose.

1. Click the **Connection 1** button under **WAN Setup** to view the default **PPPoA Connection Setup** configuration menu.
2. Select *Static* from the **Type:** pull-down menu. This action will change the menu so it offers different settings for configuration.
3. Type in a **Name:** in the space provided (*conn_1_Static_8_35* is used in the above example).
4. If you are told to change the **VPI** or **VCI** values, type in the values given to you by your service provider. Many users will be able to use the default settings.
5. Leave the default **QoS** values if you are unsure or the ISP did not provide this information.
6. Do not change the **PCR** or **SCR** values unless you are required to do so. If you are told to change these, type in the values given to you by your service provider.
7. The **Encapsulation** values LLC (SNAP) and VC (MUX) are two different methods of encapsulating the PPP packet. Contact your ISP to make sure which encapsulation is being supported.
8. Based on the information provided by your ISP, enter the **IP Address**, **Subnet Mask**, **Default Gateway** (if provided), and Domain Name Services (**DNS**) values (if provided).
9. Select the desired **Mode**, **Bridged** or **Routed**.
10. Click the **Apply** button when you have entered all the information. The web browser will briefly go blank. You are now finished changing setting for the primary WAN connection known as Connection 1. It is now necessary to save the changes you just made and restart the Router.
11. To save the changes made to Connection 1, click the **Tools** tab and then click on the **System Commands** button. Click on the **Save All** button to store the configuration settings. Click on **Back** button to return to the System Commands menu.
12. Check the WAN connection status. Click the **Status** tab and then the **Connection Status** button. Look under **WAN** to view the **State** of Connection 1, it should read *Connected*. If the WAN connection state does not appear to *Connected* after a few minutes, go back to the Connection 1 Setup menu, check the settings and make sure they are correct.

Configure Connection 1 for DHCP for WAN

Dynamic Host Configuration Protocol (DHCP) allows the gateway to automatically obtain the IP address from a DHCP server on the service provider's network. The service provider assigns a global IP address from a pool of addresses available to the service provider. Typically the IP address assigned has a long lease time, so it will likely be the same address each time the Router requests an IP address.

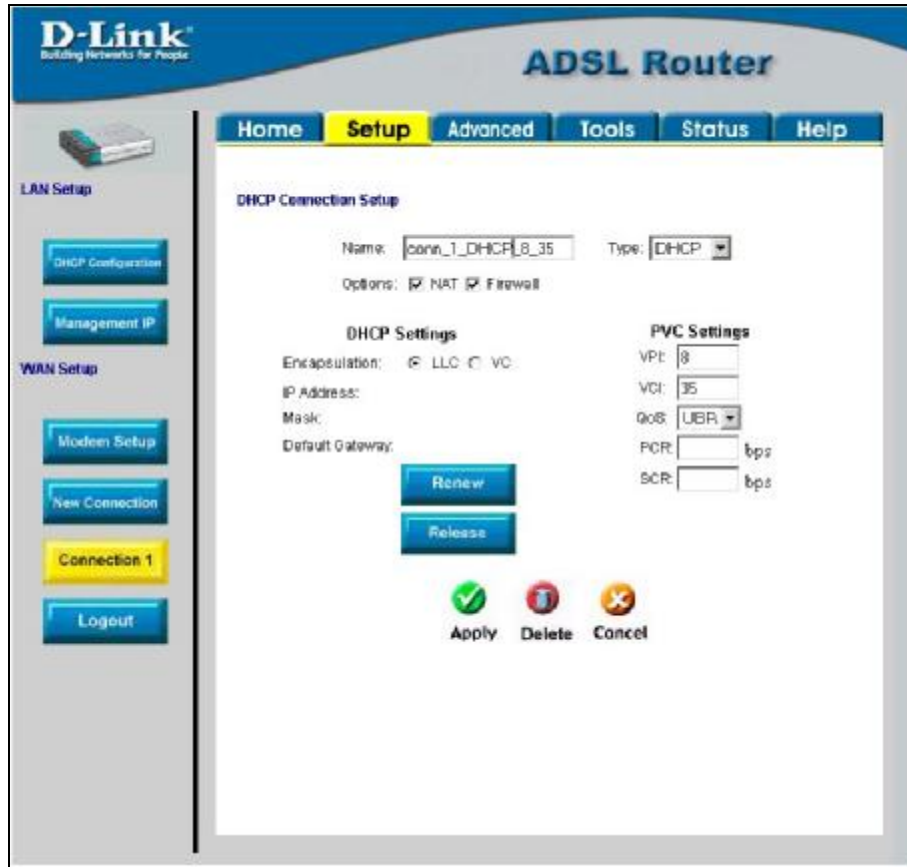

Figure 3-9. Setup – Configure Connection 1 for DHCP service for the WAN

To configure the WAN connection for DHCP, perform the steps listed below. Some of the settings do not need to be changed the first time the device is set up, but can be changed later if you choose.

1. Click the **Connection 1** button under **WAN Setup** to view the default **PPPoA Connection Setup** configuration menu.
2. Select **DHCP** from the **Type:** pull-down menu. This action will change the menu so it offers different settings for configuration.
3. Type in a **Name:** in the space provided (*conn_1_DHCP_8_35* is used in the above example).
4. If you are told to change the **VPI** or **VCI** values, type in the values given to you by your service provider. Many users will be able to use the default settings.
5. Leave the default **QoS** values if you are unsure or the ISP did not provide this information.
6. Do not change the **PCR** or **SCR** values unless you are required to do so. If you are told to change these, type in the values given to you by your service provider.
7. The **Encapsulation** values LLC (SNAP) and VC (MUX) are two different methods of encapsulating the PPP packet. Contact your ISP to make sure which encapsulation is being supported.

8. Click the **Apply** button when you have entered all the information. The web browser will briefly go blank. You are now finished changing setting for the primary WAN connection known as Connection 1. It is now necessary to save the changes you just made and restart the Router.
9. To save the changes made to Connection 1, click the **Tools** tab and then click on the **System Commands** button. Click on the **Save All** button to store the configuration settings. Click on **Back** button to return to the System Commands menu.
10. Check the WAN connection status. Click the **Status** tab and then the **Connection Status** button. Look under **WAN** to view the **State** of Connection 1, it should read *Connected*. If the WAN connection state does not appear to *Connected* after a few minutes, go back to the Connection 1 Setup menu, check the settings and make sure they are correct.

Configure Connection 1 for CLIP

CLIP or IPoA connections function in a similar way to DHCP or Static IP connections. Certain CLIP connections function like P2P networks. The router must obtain IP settings from a server owned by an ISP, or use a static IP address assigned by the ISP.

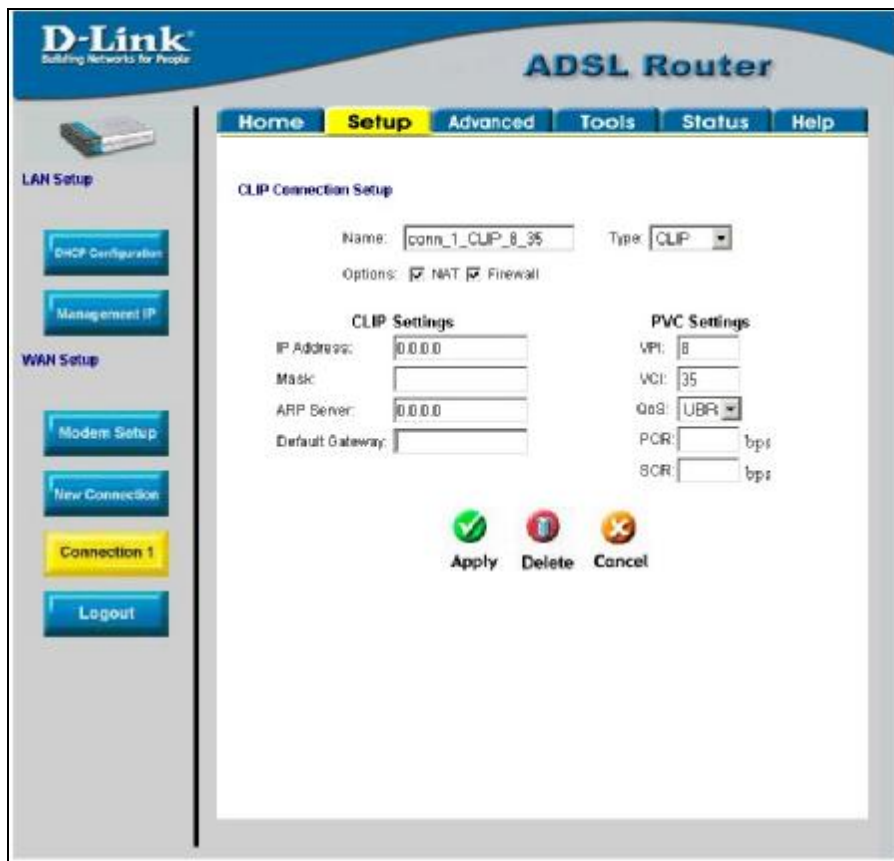

Figure 3-10. Setup – Configure Connection 1 for CLIP (IPoA)

To configure the WAN connection for CLIP, perform the steps listed below. Some of the settings do not need to be changed when you first set up the device but can be changed later if you choose.

1. Click the **Connection 1** button under **WAN Setup** to view the default **PPPoA Connection Setup** configuration menu.
2. Select **CLIP** from the **Type:** pull-down menu. This action will change the menu so it offers different settings for configuration.

3. Type in a **Name:** in the space provided (*conn_1_CLIP_8_35* is used in the above example).
4. Under **Options**, enable **NAT** and/or **Firewall** by selecting the appropriate checkbox. This option is not available for a Bridge connection.
5. Based upon the information your ISP provided, enter the **IP Address** (e.g. 168.128.1.1), the Subnet **Mask** (e.g. 255.255.255.0), **ARP Server** (e.g. 168.128.1.2) and the **Default Gateway** (e.g. 168.128.1.254).
6. If you are told to change the **VPI** or **VCI** values, type in the values given to you by your service provider. Many users will be able to use the default settings.
7. Leave the default **QoS** values if you are unsure or the ISP did not provide this information.
8. Do not change the **PCR** or **SCR** values unless you are required to do so. If you are told to change these, type in the values given to you by your service provider.
9. Click the **Apply** button when you have entered all the information. The web browser will briefly go blank. You are now finished changing setting for the primary WAN connection known as Connection 1. It is now necessary to save the changes you just made and restart the Router.
10. To save the changes made to Connection 1, click the **Tools** tab and then click on the **System Commands** button. Click on the **Save All** button to store the configuration settings. Click on **Back** button to return to the System Commands menu.
11. Check the WAN connection status. Click the **Status** tab and then the **Connection Status** button. Look under **WAN** to view the **State** of Connection 1, it should read *Connected*. If the WAN connection state does not appear to *Connected* after a few minutes, go back to the Connection 1 Setup menu, check the settings and make sure they are correct.

Create a New Connection

An alternative method of changing the connection type used by the Router is to create a new connection. Creating a new connection will not change the Connection 1 settings, it will make a new set of connection configuration settings. The new set created will be labeled **Connection 2**, additional connections created will be likewise labeled Connection 3, Connection 4 and so on. Use the method described here to create up to 8 different connection configuration sets. At any time you may reconfigure the settings for any previously created connection by clicking on the menu button for the connection displayed under the **WAN Setup** heading.



Note

Use the New Connection procedure to create new connection used for accounts that supports multiple virtual connections. For more information on creating and maintaining virtual connection, see [Multiple Virtual Connections](#) in the following chapter on [Advanced Router Management](#).

New Connection Example 1 - Create a New PPPoE Connection

The example below describes how to set up a new connection that uses a PPPoE type WAN connection. To create a new connection:

1. Click on the **New Connection** button.
2. Configure the Router for the **Type**: of connection used and all the remaining settings as discussed in the preceding section. In this example, the type of connection used for **Connection 2** is *PPPoE*. Notice also the the VPI and VCI values have been changed.
3. Click the **Apply** button to create the new connection. Notice that a new menu button is created (Connection 2), this links to the configuration menu for Connection 2 (see example below). If at any time you want to change, delete, disconnect or connect this WAN connection, click on the Connection 2 button.
4. Remember to save any newly created connections using the **Save All** procedure in the **Tools/System Commands** menu.
5. To delete the connection, click the **Delete** button.

The screenshot shows the D-Link ADSL Router web interface. The top navigation bar includes Home, Setup (highlighted), Advanced, Tools, Status, and Help. The left sidebar contains LAN Setup (DHCP Configuration, Management IP) and WAN Setup (DSL Setup, New Connection, Connection 1, Logout). The main content area is titled "PPPoE Connection Setup".

PPPoE Connection Setup

Name: Type:

Options: NAT Firewall

PPP Settings

Username:

Passw:

Idle Tim:

Keep Alive: min

MAX Fail: times

MRU: bytes

Set Route: On Demand:

PVC Settings

VPI:

VCI:

QoS:

PCR: bps

SCR: bps

Buttons:

Figure 3- 11. Setup a New Connection – Connection 2

New Connection Example 2 - Create a New Bridge Connection

You may create new connections to suit different purposes. For example, let's create a new Bridge connection used to connect directly to a server acting as a firewall and proxy.

1. Click the **New Connection** button.
2. Select *Bridge* from the **Type:** menu.
3. Configure the remaining settings (including **VPI:** and **VCI:**) as necessary.
4. Click the **Apply** button. Notice that a new menu button, Connection 3, appears under WAN Setup.
5. Remember to save any newly created connections using the **Save All** procedure in the **Tools/System Commands** menu.
6. To delete the connection, click the **Delete** button.

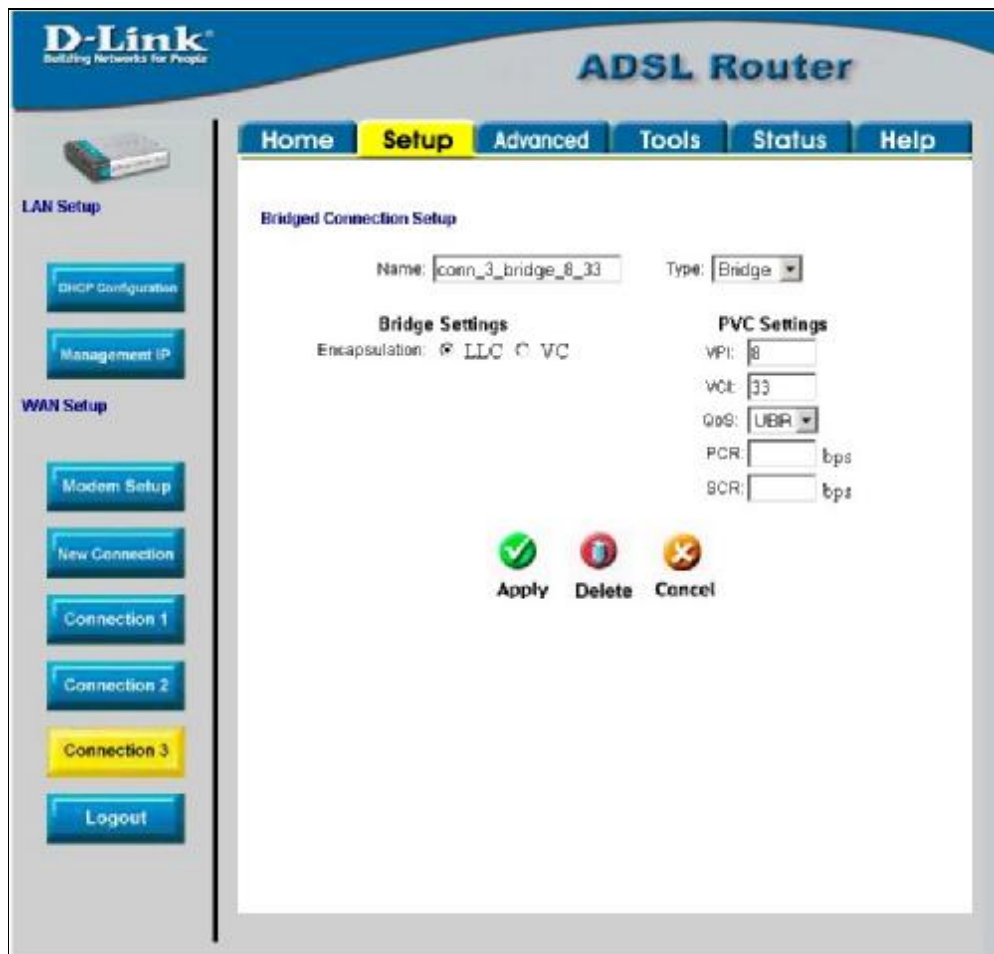

Figure 3- 12. Setup a New Connection – Connection 3

DHCP Configuration for LAN

The Router supports three DHCP modes for the LAN. By default, DHCP service is provided using an IP pool of 192.168.1.2 – 192.168.1.254 for a total of 253 IP addresses available. The Router can also relay DHCP service from another server through the WAN port. You may prefer to disable DHCP service and DHCP relay and use a different preferred method for IP addressing on your LAN.

To disable the embedded DHCP server, select the **Server and Relay Off** option and click the **Apply** button.

Figure 3- 13. Configure DHCP service for the LAN

For DHCP service on the LAN, select the **Server On** option to enable DHCP service from the Router (enabled by default) and configure DHCP server parameters as follows:

DHCP Parameter	Description
Start IP	Type in the base address for the IP pool of unassigned IP addresses. This IP address must be consistent with the Management IP address of the Router. Normally the Start IP address is one greater than the Management IP address.
End IP	Type in the last address of the contiguous IP address range to be used by the Router for DHCP function. Up to 253 consecutive IP addresses may be used for the pool.
Lease Time	This specifies the amount of time (in seconds) a client can lease an IP address, from the dynamically allocated IP pool.

Click the **Apply** button to make the changes to the DHCP settings. Remember to **Save All** in the **Tools/System Commands** menu.

Enable DHCP Relay

Some service providers provide DHCP service for private networks from their own servers. To enable DHCP service from outside your LAN select the **DHCP Relay** option and type in the server IP address in the **Relay IP** field.

D-Link
Building Networks for People

ADSL Router

Home **Setup** Advanced Tools Status Help

LAN Setup

DHCP Configuration

Management IP

WAN Setup

DSL Setup

New Connection

Connection 1

Logout

DHCP Configuration

The device can be setup as a DHCP Server to distribute IP addresses to the LAN network.

Enable DHCP Server

Start IP:

End IP:

DNS 1:

DNS 2:

DNS 3:

Lease Time: Seconds

Disable DHCP Server

Apply Cancel

Figure 3- 14. Configure DHCP Relay Service

Click the **Apply** button to change the DHCP Relay settings. Remember to **Save All** in the **Tools/System Commands** menu.

Management IP

The IP address of the Router can be changed to suit the requirements of your LAN. Remember, if you are using DHCP from the Router, the IP address must be consistent with the DHCP IP settings.

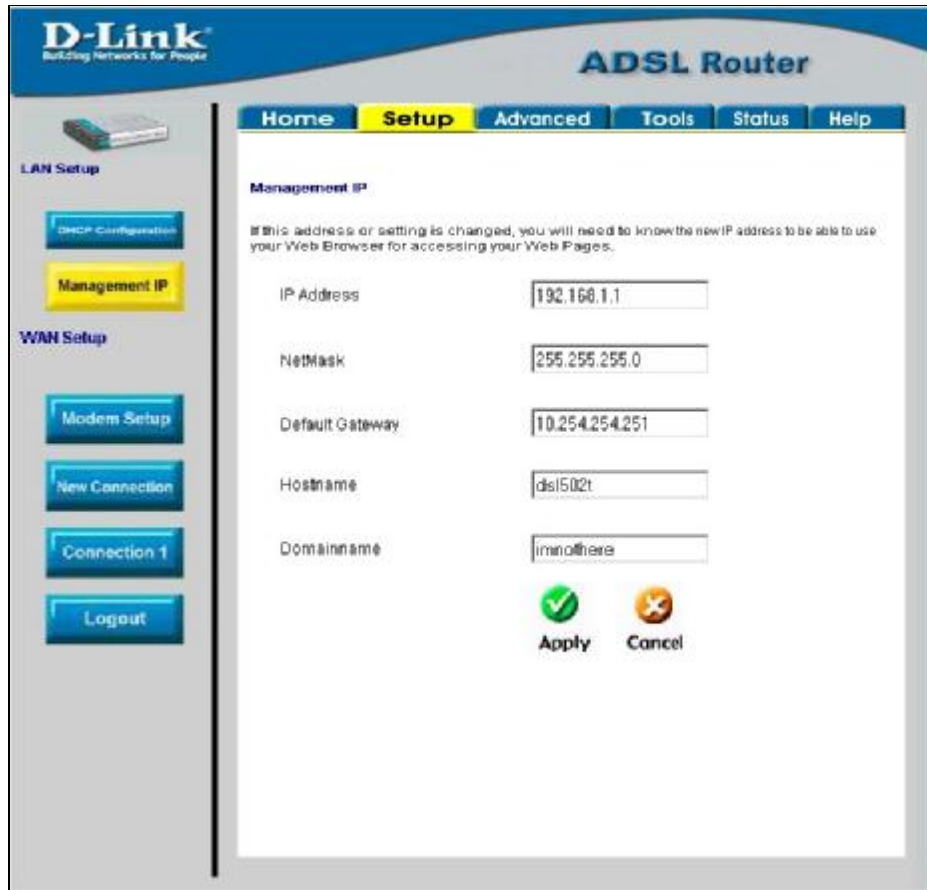

Figure 3- 15. Configure Management IP

Change IP settings as desired and click the **Apply** button to change the DHCP Relay settings. You may also provide a Host name and Domain name if necessary for your LAN. Remember to **Save All** in the **Tools/System Commands** menu.

Save Configuration Changes

Any changes made to the Router's configuration must be saved to non-volatile memory or they will be lost if the Router is restarted or powered off. When you are finished making changes to the Router settings, follow the instructions here to save the new settings.



Figure 3- 16. Router Tools Menus

Click on the **Tools** tab to access the **System Commands** menu link - then click the System Commands link to see the menu pictured below.



Figure 3- 17. Available System Commands

To save the new settings, click on the **Save All** button. It will take a second or two to perform the save. After the save is completed, a message appears in a new menu (see below).



Figure 3- 18. Changes permanently saved message

To return to the System Commands menu you can click the **Back** button in the new menu or use the back function of the web browser.

Advanced Router Management

Click the **Advanced** tab to access menus used to configure **UPnP**, **Port Forwarding**, **Access Control**, **Advanced Security** (including NAT, Firewall and DMZ setup), **LAN Clients**, **Bridge Filters**, **Multicast** pass-through, **Static Routing** and **Dynamic Routing** (RIP setup).

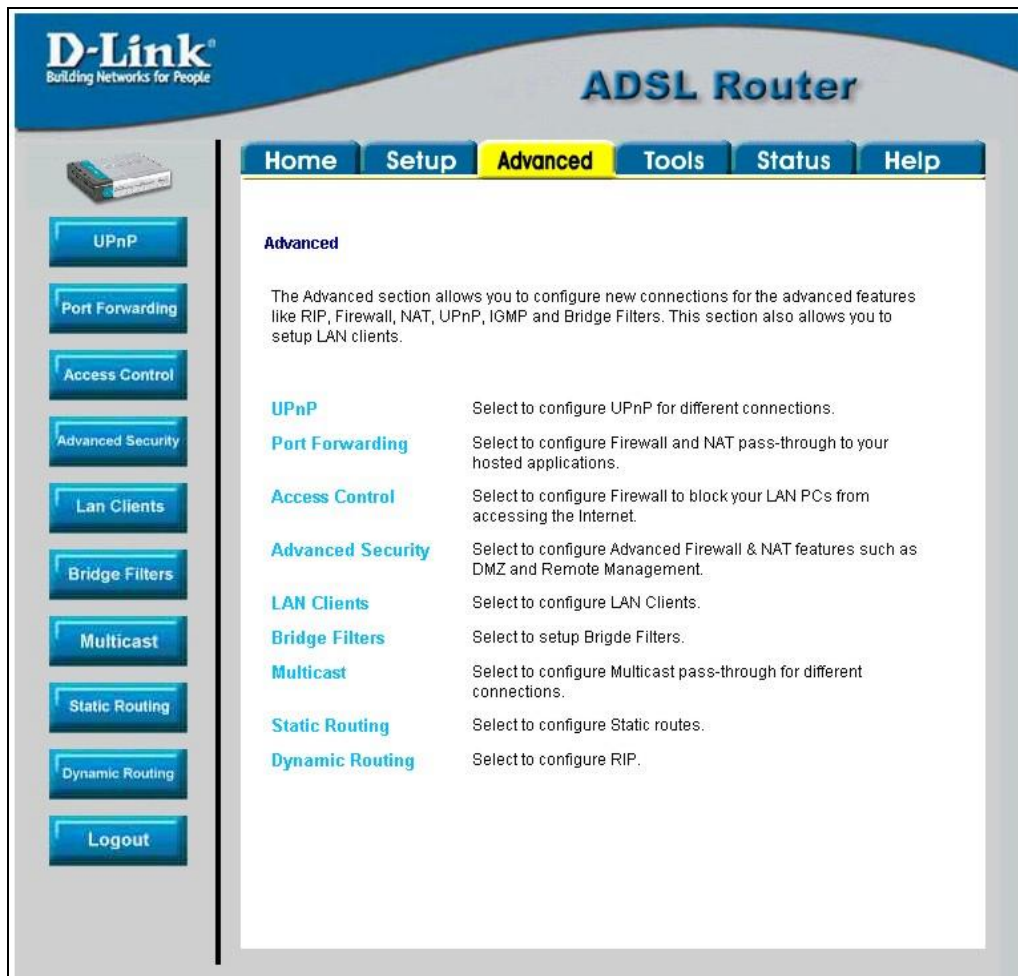

Figure 4-1. Advanced setup main menu

UPnP

UPnP supports zero-configuration networking and automatic discovery for many types of networked devices. When enabled, it allows other devices that support UPnP to dynamically join a network, obtain an IP address, convey its capabilities, and learn about the presence and capabilities of other devices. DHCP and DNS service can also be used if available on the network. UPnP also allows supported devices to leave a network automatically without adverse effects to the device or other devices on the network.

UPnP can be supported by diverse networking media including Ethernet, Firewall, phoneline and powerline networking.

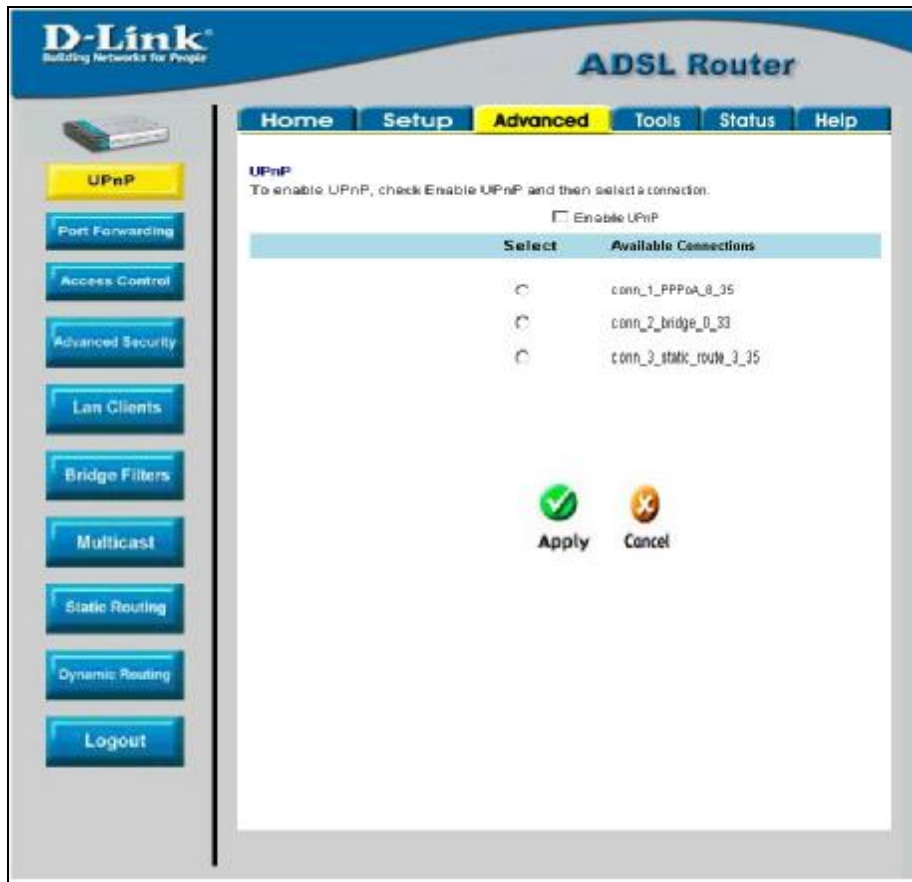

Figure 4-2. Advanced – UPnP window

To enable UPnP for any available connection, click to check the **Enable UPnP** selection box, select the connection or connections on which you will enable UPnP listed under **Available Connections** and click the **Apply** button.

LAN Clients

The LAN Clients menu is used when establishing Port Forwarding, Access Control and Advanced Security rules for IP addresses on the LAN. This menu can be accessed directly by clicking on the **LAN Clients** button or hyperlink in the **Advanced** setup menu. You can also click on the New IP button located in the Port Forwarding, Access Control and Advanced Security menus to access this menu. In order to use these advanced features it is necessary to have IP addresses available for configuration. If there are no IP addresses listed in the LAN Clients menu, it will not be possible to configure Port Forwarding, Access Control and Advanced Security.

Use the LAN Clients menus to add or delete static IP addresses for the advanced functions mentioned above, or to Reserve a Dynamically assigned IP address for an advanced function. Dynamically assigned IP addresses will only be listed if DHCP is enabled on the Router.



Figure 4-3. LAN Clients Setup

To add a static IP address to the list of available IP addresses, type an IP address that falls within the range of available IP addresses and click on the **Add** button. In the example above, available addresses range from 10.0.0.1 to 10.255.255.254. Any addresses added will appear in the list of **Static Addresses** available for advanced configuration. These addresses can then be used in the other Port Forwarding, Access Control and Advanced Security menus.

To delete an IP address from the list of Static Addresses, click the **Delete** box for the address or addresses you want to eliminate and click on the **Apply** button.

Dynamically assigned IP addresses may be reserved so that the LAN IP address for the device does not expire. This will create a permanent entry for the device in the ARP table and in effect, it becomes a static IP address. Click to check the **Reserve** box for the address or addresses you want to reserve and click the **Apply** button. These reserved addresses will no longer be available for DHCP assignment and will be listed in the Static IP Addresses table.

Port Forwarding

Port Forwarding allows specific functions to bypass NAT protection that would otherwise not allow them to function. To use Port Forwarding, you must have specific client IP addresses available for configuration. Use the LAN Clients menu to establish client IP addresses available for port forwarding.



Note

In order to use Port Forwarding, Firewall support must be enabled. See Enable/Disable NAT and Firewall in the Advanced Security menu.

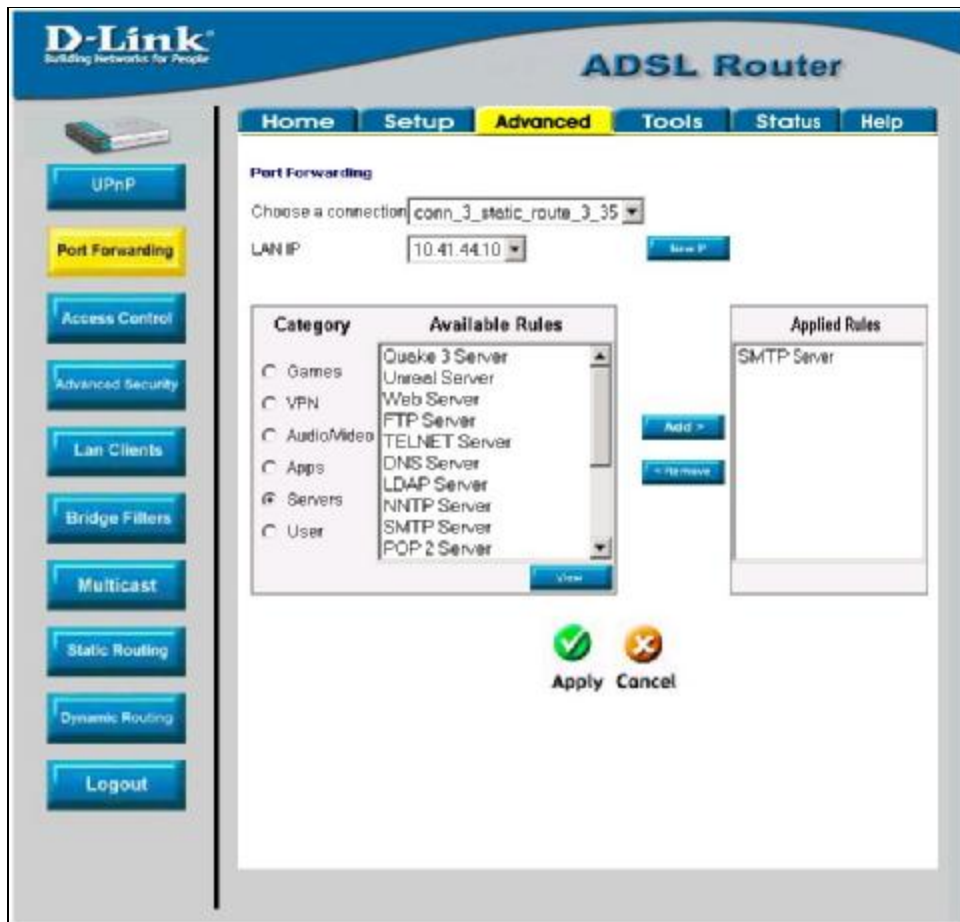

Figure 4-4. Advanced – Port Forwarding window

There are many different pre-configured rules available for specific functions such as Internet gaming, VPN, streaming and interactive multi-media, standard TCP/IP protocols, reserved ports, p2p, network management applications, and so on.

You may also create customized rules to manage TCP/UDP ports. The pre-configured rules include those listed in the table here:

Category	Available Rules
Games:	Alien vs. Predator, Asheron's Call, Dark Rein, Delta Force, Doom, Dune, DirectX Games, EliteForce, EverQuest, Fighter Ace II, Half Life, Heretic II, Hexen II, Kali, Motorhead, MSN Gaming Zone, Myth: The Fallen Lords, Need for Speed Porsche, Need for Speed 3, Outlaws, Rainbow 6, Starcraft, Tiberian Sun, Ultima, Unreal Tournament.
VPN	IPSec, PPTP, L2PT
Audio/Video	Net2Phone, Netmeeting, QuickTime
Applications	VNC, Win2k Terminal, PC Anywhere, Netbios, RemoteAnything, Radmin, LapLink, CorbonCopy, Gnutella.
Servers	Quake 2, Quake 3, Unreal, Web, FTP, Telnet, DNS, LDAP, NNTP, SMTP, POP 2, POP3, IMAP, IRC, Lotus, Remote.
User	Use this to set up custom TCP/UDP port rules.

To configure a new port-forwarding rule for any of the pre-configured rules, follow these steps:

1. Select the WAN connection you want to use for the new rule from the **Choose a connection** pull-down menu.
2. Select a **LAN IP** from the available client IP addresses listed in the pull-down menu; or, create a **New IP** by clicking the button. This brings up the LAN Client menu (see above).
3. Select the **Category** of the rule you are creating. The **Available Rules** for the category appear listed.
4. Highlight to select the Available Rule you want to apply.
5. Click on the **Add>** button to place the rule in the **Applied Rules** list of port forwarding that are actively applied to the client

The Available Rules can be applied to a single client IP address. That is, it is not possible to use an applied rule for multiple IP addresses on the LAN.

The **User** category for port forwarding is used to set up customized port forwarding rules.

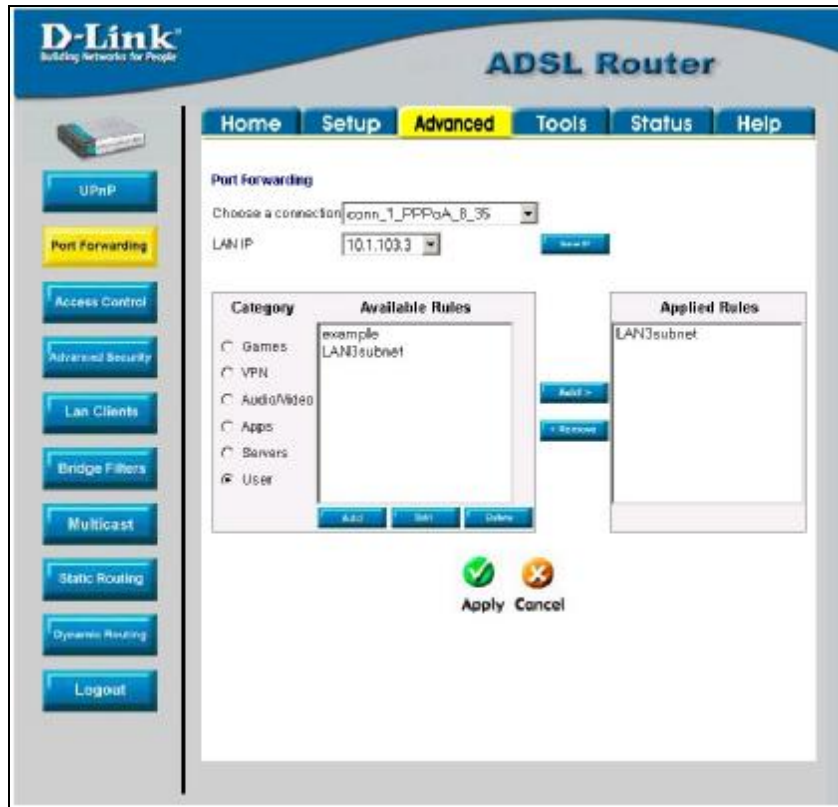

Figure 4- 5. Set up Custom Port Forwarding Rules

To set up custom TCP or UDP port forwarding rules, follow these steps:

1. Select the **User** category and click the **Add** button located below the Available Rules list. This will change the menu to look like the example below.

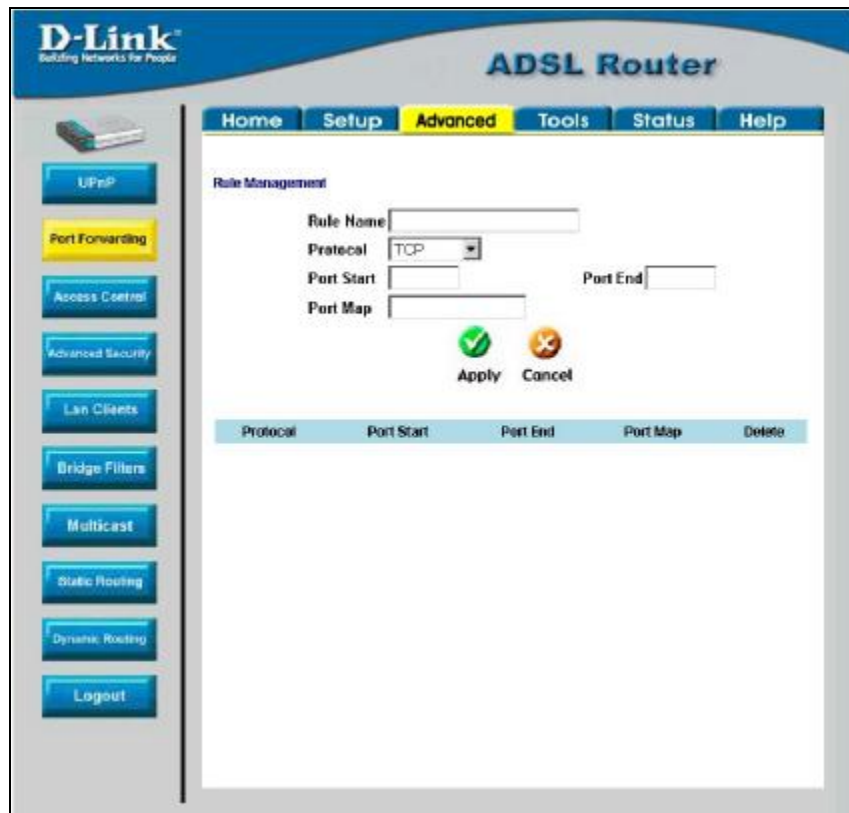

Figure 4- 6. Port Forwarding User Rules Management

2. Type a **Rule Name** in the space provided.
3. Select the port **Protocol** from the pull-down menu - you may select *TCP*, *UDP* or both (*TCP/UDP*).
4. Configure a range of ports for forwarding. Type the lowest numbered port in the range in the Port Start space. Type the highest numbered port in the Port End space. For a single port, just enter the same number in both spaces.
5. Type a number for the **Port Map** in the space provided. This is the local port being forwarded to.
6. Click the **Apply** button to create the new rule. The new rule will appear listed in the table of custom port forwarding rules.

Access Control

Access Control settings are used to block various services and protocols for specific client IP addresses. The configuration process is similar setting up port forwarding, except access control will deny specific functions to client IP addresses. There are pre-configured rules for specific functions that may be blocked or you can block specific UDP or TCP ports. Access control operates for specific IP addresses across all WAN connections. If you are using more than one WAN connection, a single set of access rules is maintained for each controlled IP address that operates on all WAN connections.



Note

In order to use Port Access Control, Firewall support must be enabled. See Enable/Disable NAT and Firewall in the Advanced Security menu.

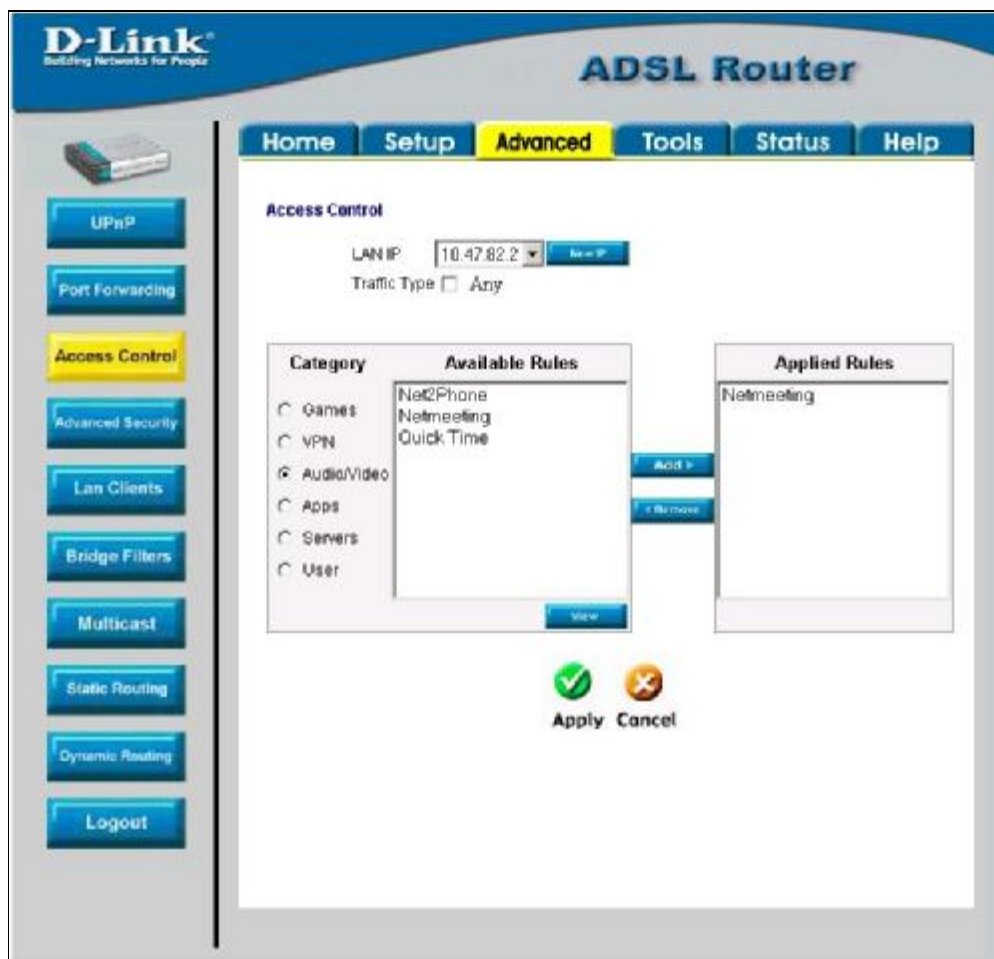

Figure 4-7. Access Control menu

Remember, if the client IP address you want does not appear listed in the LAN IP pull-down menu, click on the New IP button to go to the LAN Clients menu.

To block all traffic from the WAN port to a specific IP address, select the **LAN IP** address to block and click to check the **Traffic Type** **Any** selection box, then click the **Apply** button. This will block all traffic from the WAN port to the specified client.

Remember to save the configuration changes.

Access Control pre-configured rules are the same as for port forwarding:

Category	Available Rules
Games:	Alien vs. Predator, Asheron's Call, Dark Rein, Delta Force, Doom, Dune, DirectX Games, EliteForce, EverQuest, Fighter Ace II, Half Life, Heretic II, Hexen II, Kali, Motorhead, MSN Gaming Zone, Myth: The Fallen Lords, Need for Speed Porsche, Need for Speed 3, Outlaws, Rainbow 6, Starcraft, Tiberian Sun, Ultima, Unreal Tournament.
VPN	IPSec, PPTP, L2PT
Audio/Video	Net2Phone, Netmeeting, QuickTime
Applications	VNC, Win2k Terminal, PC Anywhere, Netbios, RemoteAnything, Radmin, LapLink, CorbonCopy, Gnutella.
Servers	Quake 2, Quake 3, Unreal, Web, FTP, Telnet, DNS, LDAP, NNTP, SMTP, POP 2, POP3, IMAP, IRC, Lotus, Remote.
User	Use this to set up custom TCP/UDP port rules.

To configure a new Access Control rule for any of the pre-configured rules, follow these steps:

1. Select a **LAN IP** from the available client IP addresses listed in the pull-down menu; or, create a **New IP** by clicking the button. This brings up the LAN Client menu (see above).
2. Select the **Category** of the rule you are creating. The **Available Rules** for the category appear listed.
3. Highlight to select the Available Rule you want to apply.
4. Click on the **Add>** button to place the rule in the **Applied Rules** list of port forwarding that are actively applied to the client

The Available Rules can be applied to a single client IP address. That is, it is not possible to use an applied rule for multiple IP addresses on the LAN.

To set up custom TCP or UDP access control rules, follow these steps:

1. Select the User category and click the **Add** button located below the Available Rules list.
2. In the new menu that appears, type a **Rule Name** in the space provided.
3. Select the port **Protocol** from the pull-down menu - you may select *TCP*, *UDP* or both (*TCP/UDP*).
4. Configure a range of ports for forwarding. Type the lowest numbered port in the range in the Port Start space. Type the highest numbered port in the Port End space. For a single port, just enter the same number in both spaces.
5. Type a number for the **Port Map** in the space provided. This is the local port being forwarded to.
6. Click the **Apply** button to create the new rule. The new rule will appear listed in the table of custom port control rules.

Advanced Security

Use the Advanced Security features of the Router to globally enable or disable NAT and Firewall protection for any WAN connection, enable or disable DMZ IP addresses, enable or disable remote Telnet or web management from specified IP addresses, and enable/disable ICMP ping packets from the WAN.

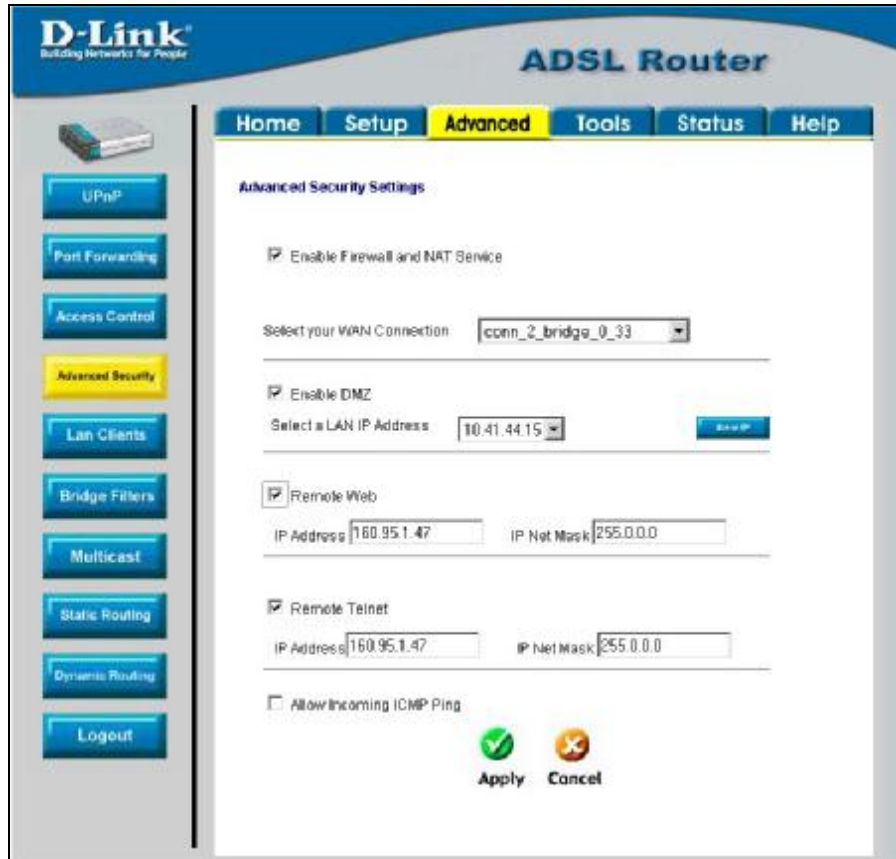

Figure 4-8. Advanced Security menu

Follow the instructions below to set up the Advanced Security features. To enable ICMP Ping packets from the WAN, click to check the **Allow Incoming ICMP Ping** selection box and click the **Apply** button. The ICMP (Internet Control Message Protocol) Ping packet is used to test connectivity of IP devices. Keep in mind that when this is enabled, the Router may be vulnerable to denial of service type attacks.

Enable/Disable NAT and Firewall

NAT and basic Firewall protection can be enabled or disabled for any WAN connection. These may also be enabled or disabled when configuring the WAN connection for any connection type except Bridge connections. By default, they are enabled for WAN connections (except Bridge connections) when they are first set up. Firewall protection includes the previously discussed Port Forwarding and Access Control. Therefore, this must be enabled to use these features.

To enable NAT and Firewall protection for any WAN connection including Bridge type connections, check the **Enable NAT and Firewall Services** selection box and click the **Apply** button. Be sure to save the changes in the System Commands menu or the settings will be lost.

To disable NAT and Firewall Services, deselect it and click the **Apply** button. Be aware that this remove basic security and expose your LAN to potentially malicious agents form the WAN.

Remember to save the configuration changes.

DMZ IP Address

A DMZ address is used for a device that is not given basic protection of NAT and Firewall services. You may select an IP address from the pull-down menu or create a **New IP** by pressing the button. This brings up the LAN Clients menu in which you may create a static client IP or reserve a dynamically assigned IP address for DMZ designation.

Setup Remote Management

Telnet and web management through the WAN port can be enabled for specified IP addresses. To enable remote management, click to check the selection box for **Remote Telnet** or **Remote Web** and type in an IP address and net mask of a trusted host.

Bridge Filters

Bridge filters are used to block or allow various types of packets through the WAN interface. This may be done for security or to improve network efficiency. The rules are configured for individual devices based on MAC address. Filter rules can be set up for source, destination or both. You can set up filter rules and disable the entire set of rules without losing the rules that have been configured.

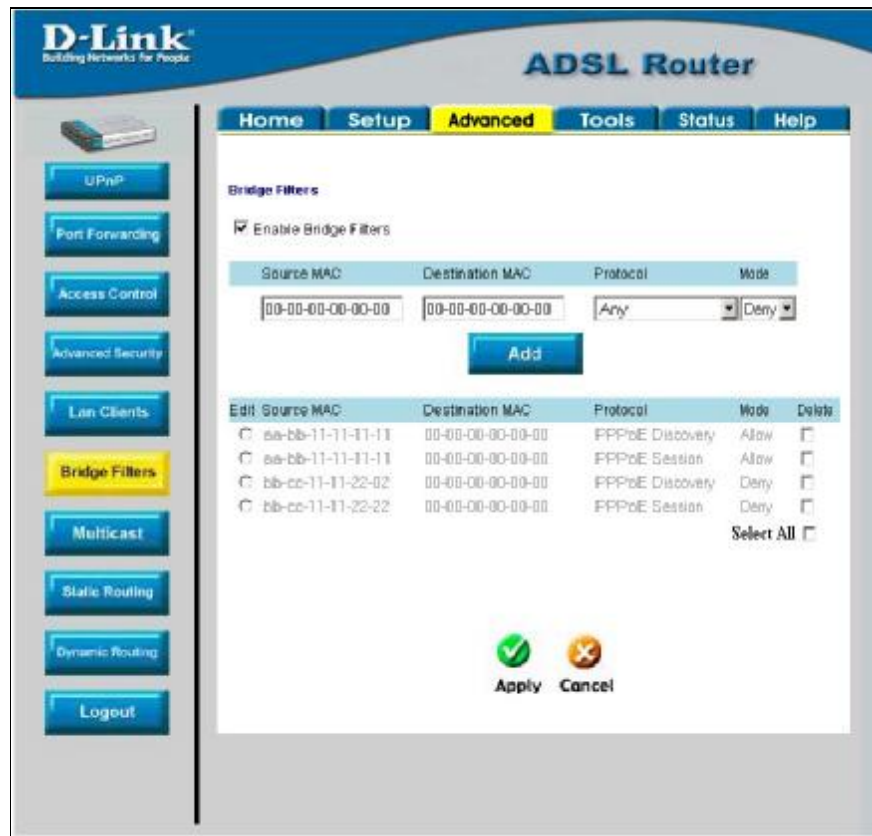

Figure 4-9. Bridge Filters menu

To add a bridge filter rule, check **Enable Bridge Filters**, type in a Source MAC, a Destination MAC or both in the entry fields, and click the **Add** button. To edit an existing rule, select the rule by clicking the **Edit** radio button. The rule will appear in the entry fields above as it is currently configured. Make the desired changes and click the **Add** button. To remove a bridge filter from the table in the bottom half of the window, click to select the corresponding **Delete** box, and then click **Apply**. Remember to save the configuration changes.

The protocols that may be specifically allowed or denied to pass through the WAN interface are the following: *IPv4*, *RARP*, *PPPoE Discovery* and *PPPoE Session*.

Multicast Pass-through

Multicast pass-through can be enabled or disabled for any WAN connection. When enabled it allows IGMP packets to pass through the WAN interface. IGMP packets are used to control multicasts and discontinue multicasts to individual IP addresses when they are no longer needed.

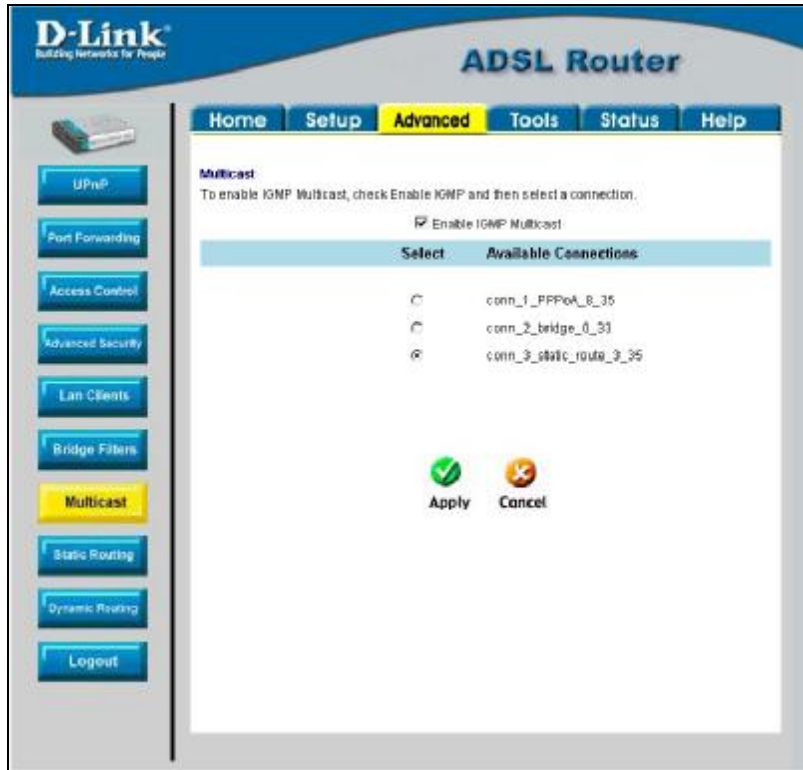

Figure 4-10. Multicast pass-through menu

To enable Multicast pass through for any WAN connection, select the connection and click the **Enable IGMP Multicast** box to select the option, then click the **Apply** button. Remember to save the configuration changes.

Static Routing

Use Static Routing to specify a route used for data traffic within your Ethernet LAN or to route data on the WAN. This is used to specify that all packets destined for a particular network or subnet use a predetermined gateway.

The screenshot shows the D-Link ADSL Router web interface. The main navigation bar includes Home, Setup, Advanced (selected), Tools, Status, and Help. The left sidebar contains buttons for UPnP, Port Forwarding, Access Control, Advanced Security, Lan Clients, Bridge Filters, Multicast, Static Routing (highlighted), Dynamic Routing, and Logout. The main content area is titled 'Static Routing' and contains the following configuration fields:

- Choose a connection:
- New Destination IP:
- Mask:
- Gateway:
- Metric:

Below the input fields is a table of existing static routes:

Connection	Destination	Mask	Gateway	Metric	Delete
LAN	10.1.103.3	255.0.0.0		1	<input type="checkbox"/>
conn_2_bridge_0_33	10.41.46.2	255.255.255.0	10.1.1.264	1	<input type="checkbox"/>

At the bottom of the configuration area are two buttons: **Apply** (with a green checkmark icon) and **Cancel** (with an orange 'X' icon).

Figure 4-11. Static Routing menu

To add a static route, choose a connection from the pull-down menu and then enter a **New Destination IP** address, subnet **Mask**, **Gateway** IP address and **Metric** value. Click **Apply** to enter the new static route in the table below. The route becomes active immediately upon creation.

To remove a static route from the table in the bottom half of the window, choose to **Delete** it from the table and click the **Apply** button. Remember to save the configuration changes.

Dynamic Routing

The Router supports RIP v1 and RIP v2 used to share routing tables with other Layer 3 routing devices. It also supports use of password protection which requires password verification for RIP requests. Use the Dynamic Routing menu to enable RIP and if desired to configure password protection.

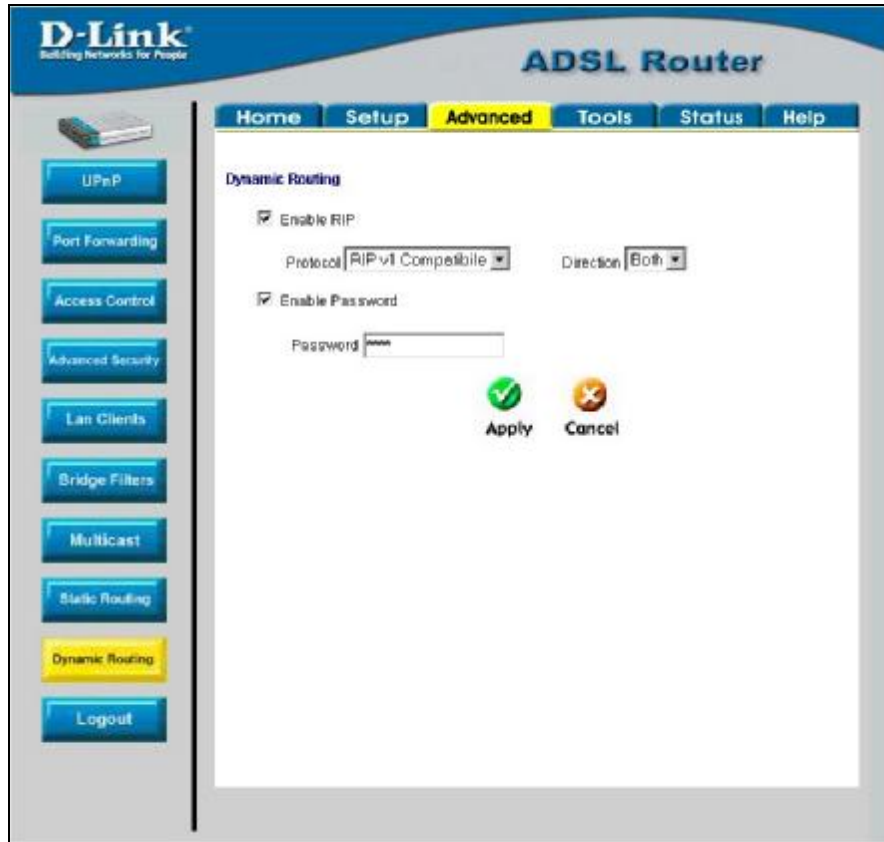

Figure 4-12. Dynamic Routing (RIP) menu

To enable RIP v1, check **Enable RIP**, select **RIP v1 Protocol**, select the **Direction** (*In*, *Out*, or *Both*), and click **Apply**. To enable **RIP v2** or **RIP v1 Compatible**, select the appropriate **Protocol** and **Direction** and click **Apply**. To use password protection for RIP v2 or RIP v1 Compatible protocols, check **Enable Password**, enter a **Password**, and click **Apply**.

Multiple Virtual Connections

The Router can use up to eight simultaneous PVC connections. These additional connections occupy the same bandwidth used for ADSL service. Additional PVC connections can be added to establish a private connection to remote offices or maintain a server accessible through the WAN port. Provision for additional PVC profiles must be done through the telephone company or telecommunications services company. The remote user must have suitable ADSL equipment for a successful connection.

The New Connection menu is used to configure additional WAN connection that can operate simultaneously with the other connections. PPPoE type WAN connections can be disconnected or connected as needed. Non-PPPoE type connections must be deleted from the configuration settings if you want to disable them.

To set up additional virtual connections, follow the procedure described in Create a New Connection. Keep in mind that each new connection must have a VPI/VCI value set that is unique to the Router. The numbers for these values will be provided by your service provider.

PPPoE and PPPoA connections may be connected and disconnected with the **Connect** and **Disconnect** menu buttons located in the connection settings menu.

The remaining connection types (Bridge, Static, DHCP and CLIP) connect upon saving the settings and restarting the Router. These connections can be disconnected only if the connection set is deleted. To delete any WAN connection set, click on the **Delete** button in the menu for the connection.

Tools and Utility Menus

The menus listed under the Tools tab are used for **System Commands** to save settings, restart and reset the Router; to set up **Remote Log** information; for **User Management**; to update firmware and load saved configuration files (in the **Update Gateway** menu); to perform a **Ping** test; and to test the DSL network connectivity in the **Modem Test** menu.

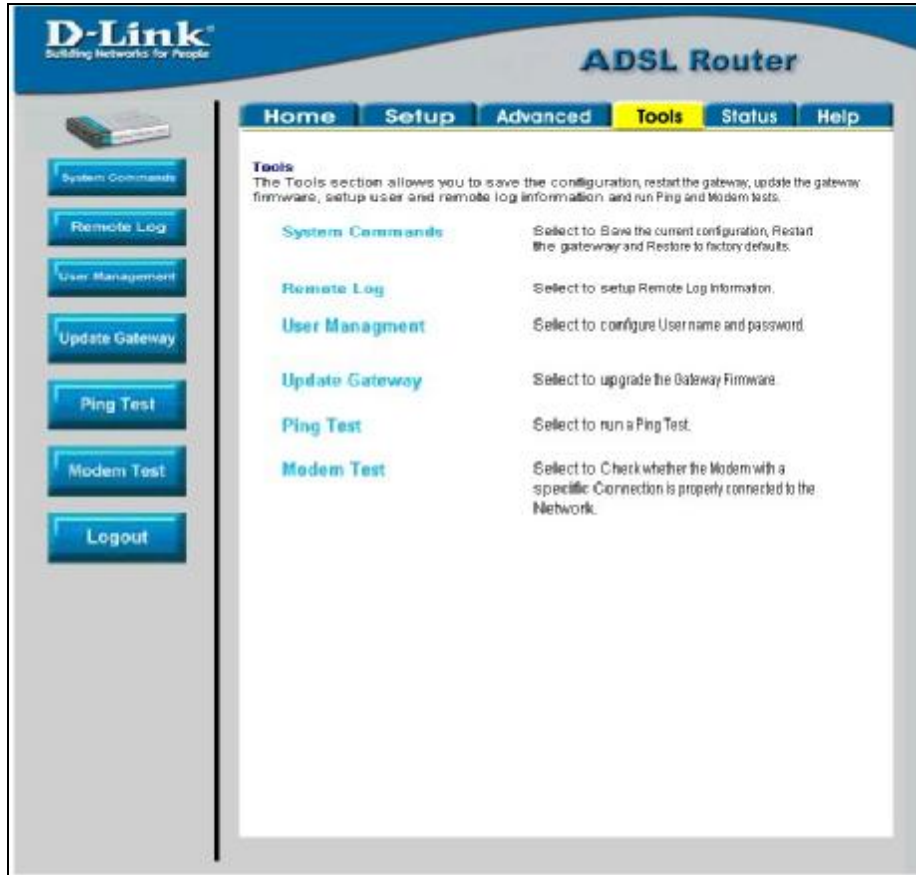

Figure 4-13. Tools and utility menu links

Click the hyperlink or menu button to view the desired menu.

User Management

It is a good idea to change the management user information used for the Router before or immediately after establishing a link to the WAN.



Figure 4-14. User Management menu

To change the user name and password used for management access to the Router:

1. Type the current **User Name** in the entry field provided.
2. Type in the new **Password** in the entry field provided.
3. Type in the new password again in the **Confirm Password** field.
4. If desired, change the **Idle Timeout** value.
5. Click **Apply**.

System Commands

The System Commands are used to save settings to non-volatile memory, to reboot the Router and to restore factory default settings to the Router.

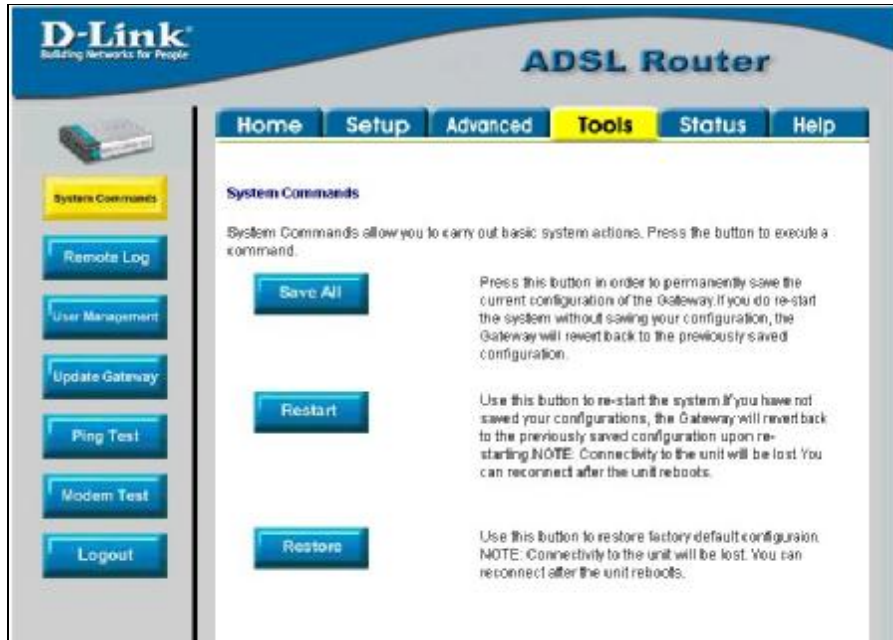

Figure 4-15. Tools – System Commands menu

Click on the appropriate menu button to perform the following system tasks:

System Function	Description
Save All	In order to save the configuration changes you have just made they must be saved to the Router's non-volatile RAM by clicking on the Save All button.
Restart	Click the Restart button to restart the Router. If you have not saved your changes, the Router will revert to the previously saved configuration upon rebooting the Router.
Restore	The DSL-564T can be reset to the default configuration for all settings using the Restore option. This will also change the both the LAN and WAN IP address of the device, so these will need to be reconfigured accordingly. To perform a factory reset, click the Restore button. Since the IP settings will return to their default, you will lose access to the Web Manager. To use the Web Manager interface, the LAN IP address will need to be reconfigured.

Remote Log

Use the Remote Log menu to set up logging to servers or computers that are located outside the LAN or subnet of the Router.

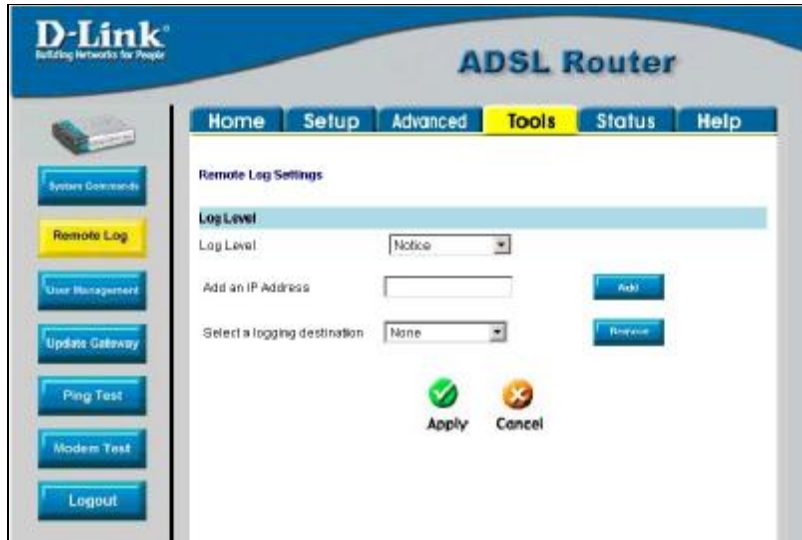

Figure 4-16. Remote Log menu

Select the **Log Level** from the pull-down menu. The levels available are: *Alert*, *Critical*, *Debug*, *Error*, *Info*, *Notice*, *Panic* and *Warning*. Type in the IP address of a receiver for the log message in the **Add an IP Address** field and click on the **Add** button. Log message receivers that are added appear listed in the **Select a logging destination** pull-down menu. These may be used at any time for other types of log messages. To remove a log message receiver from the list, select it and click on the **Remove** button. Click the **Apply** button when you have configured the log message receivers. Remember to save the settings to non-volatile memory.

Update Gateway

Use the Update Gateway feature to load the latest firmware for the device. You can obtain the latest version of the DSL-564T firmware by logging onto the D-Link web site at www.dlink.com. Save the latest firmware version to a file on your computer or an accessible TFTP server.

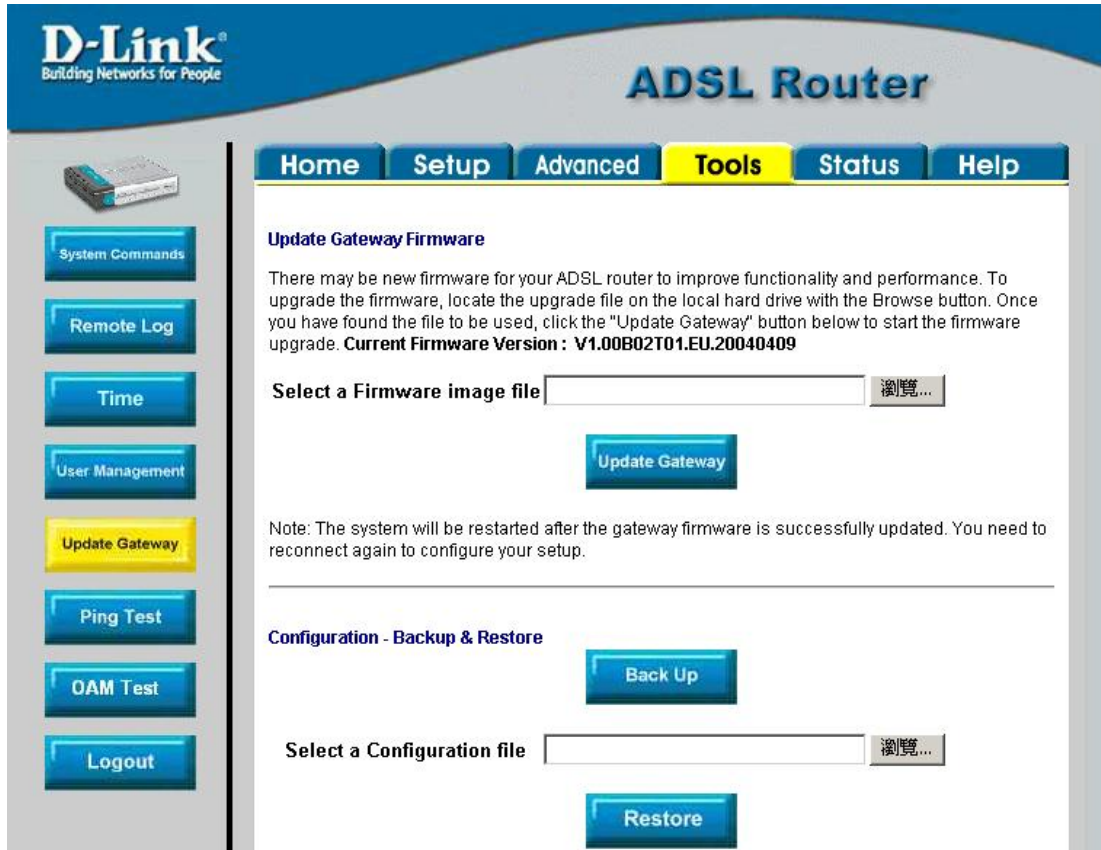

Figure 4-17. Tools – Update Gateway window

To upgrade firmware, type in the name and path of the file in the Select a Firmware image file space or click on the **Browse** button to search for the file. Click the **Update Gateway** button to begin copying the file. The file will load and restart automatically.

Use the Configuration – Backup & Restore features to store current settings to a file on your computer or to load previously saved configuration files on the device.

To save the current settings to a configuration file on your computer, type in the full name and path in the Select a Configuration file space or click on the **Browse** button to search for the file. Click the **Back Up** button to initiate this action.

To load a saved configuration file from the computer, type in the full name and path in the Select a Configuration file space or click on the **Browse** button to search for the file. Click the **Restore** button to initiate this action.

Ping Test

The Ping Test menu allows you to ping any IP address from the Router to test connectivity to the address.



Figure 4-18. Tools – Ping Test window

To Ping a device, first enter the IP address of the device that you wish to Ping into the first field, the Packet Size (in bytes) in the second field, and finally, enter the number of times you wish the Ping function to attempt a connection to the desired device into the third field. Click **Test** to start the Ping mechanism. The results of the Ping will be shown in the result box in the bottom half of the window.

Modem Test

The Modem Test menu is used for trouble shooting connection problems on the WAN interface. You can test for connectivity on the service provider's network for any WAN connection. Test for F5 or F4 connection on the near segment or end-to-end.

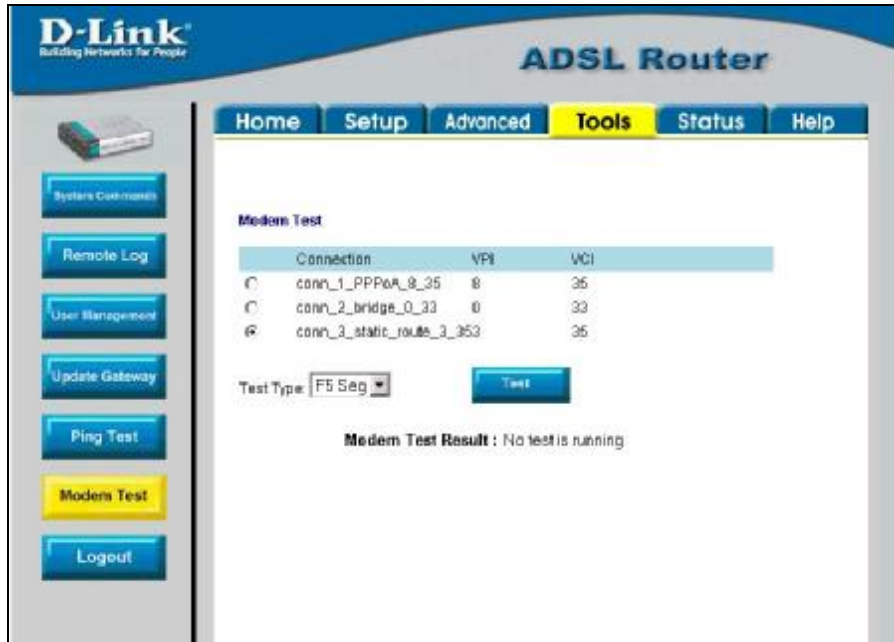

Figure 4-19. Tools – Modem Test window

To test your modem, select a **Connection**, choose a **Test Type**, and click **Test**.

Status Menus

Use the Status windows to display various performance data about the Router

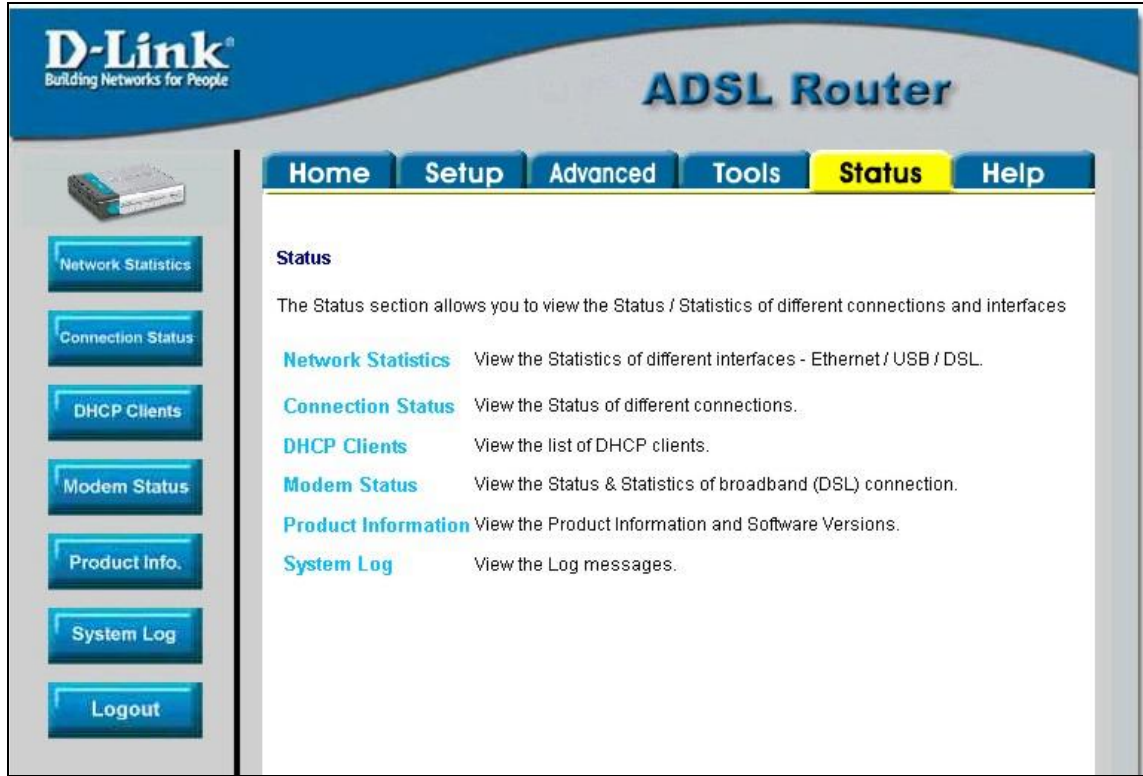
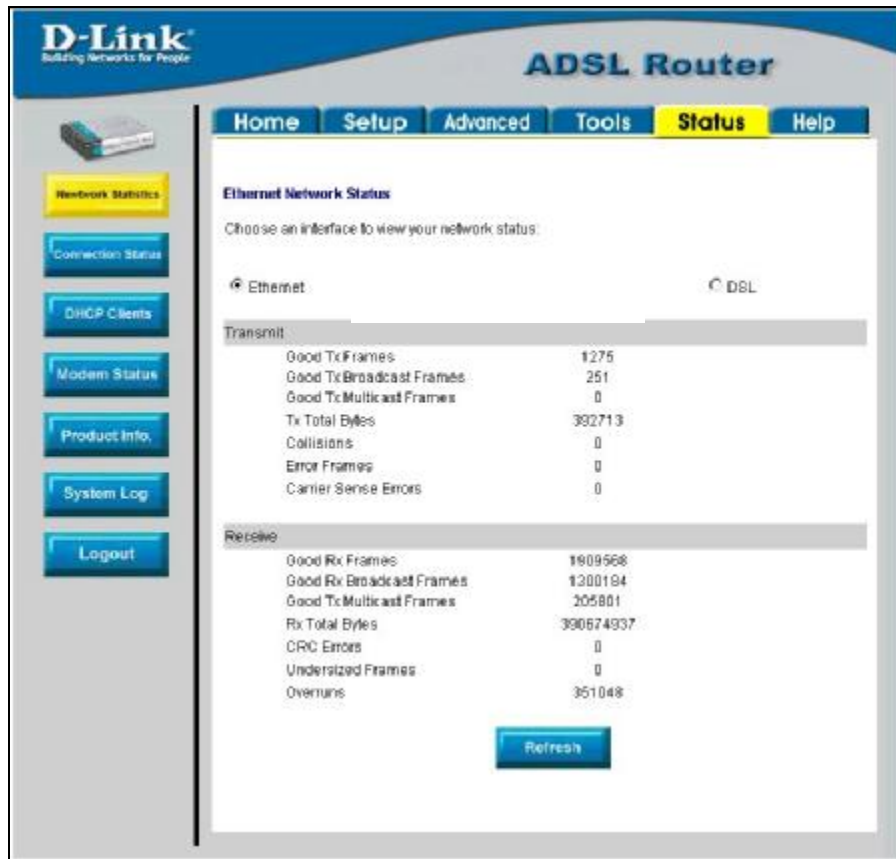

Figure 4-20. Status display links

Click the hyperlink or menu button for the desired Status window.

Network Statistics



D-Link
Building Networks for People

ADSL Router

Home Setup Advanced Tools **Status** Help

Network Statistics
Connection Status
DHCP Clients
Modem Status
Product Info.
System Log
Logout

Ethernet Network Status

Choose an interface to view your network status:

Ethernet DSL

Transmit

Good Tx Frames	1275
Good Tx Broadcast Frames	251
Good Tx Multicast Frames	0
Tx Total Bytes	392713
Collisions	0
Error Frames	0
Carrier Sense Errors	0

Receive

Good Rx Frames	1609568
Good Rx Broadcast Frames	1200184
Good Rx Multicast Frames	205801
Rx Total Bytes	390674937
CRC Errors	0
Undersized Frames	0
Overruns	351048

Refresh

Figure 4-21. Network Statistics window

Choose the desired interface at the top of the window and then click **Refresh** to view Ethernet network statistics.

Connection Status



Figure 4-22. Connection Status window

Click **Refresh** to view connection status information.

DHCP Clients

This window displays the status of all current DHCP clients.



Figure 4-23. DHCP Clients window

Modem Status

This window displays DSL statistics and various modem status data.

The screenshot shows the 'Modem Status' window of the ADSL Router. The navigation menu on the left includes: Network Statistics, Connection Status, DHCP Clients, **Modem Status**, Product Info, System Log, and Logout. The main content area is titled 'ADSL Router' and has a navigation bar with 'Home', 'Setup', 'Advanced', 'Tools', 'Status', and 'Help'. The 'Status' tab is active.

Modem Status

Connection Status	Disconnected
Upstream Rate (Kbps)	0
Downstream Rate (Kbps)	0
US Margin	0
DS Margin	0
Modulation	MMQCE
LOS Errors	0
DS Line Attenuation	0
US Line Attenuation	0
Path Mode	Interleaved

DSL Statistics

Near End F4 Loop Back Count	0
Near End F5 Loop Back Count	0

Figure 4-24. Modem Status window

Product Information

This window displays product information including hardware and firmware versions.

The screenshot shows the 'Product Information' window of the ADSL Router. The navigation menu on the left includes: Network Statistics, Connection Status, DHCP Clients, DSL Status, **Product Info.**, System Log, and Logout. The main content area is titled 'ADSL Router' and has a navigation bar with 'Home', 'Setup', 'Advanced', 'Tools', 'Status', and 'Help'. The 'Status' tab is active.

Product Information

Product Information	
Model Number	DSL-564T
Ethernet MAC	00:0F:3D:C1:29:AC
Software Versions	
Gateway	V1.00902T01.EU.20040409
ATM Driver	4.02.01.50
DSL HAL	3.00.03.00
DSL Datapumps	1.01.03.00 Annex B
SAR HAL	01.06.06.s
PDSP Firmware	0.49
Boot Loader	0.22.02

Figure 4-25. Product Information window

System Log

The system log displays chronological event log data.



Figure 4-26. System Log window

Click **Refresh** to get the most current system log information.

Help Menu

Help menu links provide more information for configuring various Router functions.



Figure 4-27. Opening Help window



Technical Specifications

GENERAL		
Standards:	ITU G.992.1 (G.dmt) Annex B ITU G.992.2 (G.lite) AnnexB ITU G.994.1 (G.Hs) ITU-T Rec. I.361 ITU-T Rec. I.610 IEEE 802.3 IEEE 802.3u IEEE 802.1d RFC 791 (IP Routing) RFC 792 (UDP) RFC 826 (ARP) RFC 1058 (RIP 1) RFC 1389 (RIP 2) RFC 1213 compliant RFC 1483 (Bridged Ethernet)	RFC 1577 (IP over ATM) RFC 1661 (PPP) RFC 1994 (CHAP) RFC 1334 (PAP) RFC 2364 (PPP over ATM) RFC 1631 (NAT) RFC 1877 (Automatic IP assignment) RFC 2516 (PPP over Ethernet) Supports RFC 2131 and RFC 2132 (DHCP) Compatible with all T1.413 issue 2 (full rate DMT over analog POTS), and CO DSLAM equipment Supports ATM Forum UNI V3.1 PVC
Protocols:	TCP/IP UDP RIP-1 RIP-2 IGMP	DHCP BOOTP ARP AAL5
Data Transfer Rate:	G.dmt full rate: Downstream up to 8 Mbps Upstream up to 640 Kbps G.lite: Downstream up to 1.5 Mbps Upstream up to 512 Kbps	
Media Interface:	RJ-11 port ADSL telephone line connection RJ-45 port for 10/100BASET Ethernet connection	

Physical and Environmental	
DC Inputs:	Input: 100V ~ 240V AC 50 ~ 60Hz
Power Adapter:	Output: 12V AC, 1.2A
Power Consumption:	12 Watts (max)
Operating Temperature:	0° to 40° C (32° - 104° F)
Humidity:	5 to 95% (non-condensing)
Dimensions:	180 x 141 x 30 mm
Weight:	332 g
EMI:	CE Class B, FCC Class B (Part 15)
Safety:	CSA International
Reliability:	Mean Time Between Failure (MTBF) min. 4 years



IP Address Setup

The DSL-564T is designed to provide network administrators maximum flexibility for IP addressing on the Ethernet LAN. The easiest IP setup choice in most cases is to let the Router do it using DHCP, which is enabled by default. This appendix briefly describes various options including DHCP, used for IP setup on a LAN. If you are new to IP networking, the next appendix provides some background information on basic IP concepts.

Assigning Network IP Addresses

The IP address settings, which include the IP address, subnet mask and gateway IP address are the first and most important internal network settings that need to be configured. The Router is assigned a default LAN IP address and subnet mask. If you do not have a preexisting IP network and are setting one up now, using the factory default IP address settings can greatly ease the setup process. If you already have a preexisting IP network, you can adjust the IP settings for the Router to fit within your existing scheme.

Using the Default IP Address

The Router is shipped with a preset default IP address setting of 192.168.1.1 for the LAN port. There are two ways to use this default IP address, you can manually assign an IP address and subnet mask for each PC on the LAN or you can instruct the Router to automatically assign them using DHCP. The simplest method is to use DHCP. The DHCP function is active by default.

Manual IP Address Assignment

Manually configuring IP settings for the LAN means you must manually set an IP address, subnet mask and IP address of the default gateway (the Router's IP address) on each networked computer. The example listed below describes IP configuration for computers running Windows 95 or Windows 98. Regardless of what operating system is used on each workstation, the three network IP settings must be defined so the network interface used by each workstation can be identified by the Router, and vice versa. For detailed information about configuring your workstations IP settings, consult the user's guide included with the operating system or the network interface card (NIC).

1. In Windows 95/98, click on the **Start** button, go to **Settings** and choose **Control Panel**.
2. In the window that opens, double-click on the **Network** icon.
3. Under the Configuration tab, select the **TCP/IP** component and click *Properties*.
4. Choose the *Specify an IP address* option and edit the address settings accordingly. Consult the table below for IP settings on a Class C network.

Using Default IP without DHCP			
Host	IP Address	Subnet Mask	Gateway IP
Router	192.168.1.1	255.255.255.0	
Computer #1	192.168.1.2	255.255.255.0	192.168.1.1
Computer #2	192.168.1.3	255.255.255.0	192.168.1.1
Computer #3	192.168.1.4	255.255.255.0	192.168.1.1

IP Setup - Example #1

Please note that when using the default IP address as in the above example, the first three numbers in the IP address must always be the same with only the fourth number changing. The first three numbers define the network IP address (all machines must belong to the same IP network), while the last number denotes the host IP

address (each computer must have a unique address to distinguish it on the network). The IP address scheme used in Example #1 can be used for any LAN that requires up to 253 separate IP addresses (excluding the Router). Notice that the subnet mask is the same for all machines and the default gateway address is the LAN IP address of the Router.

It is a good idea to make a note of each device's IP address for reference during troubleshooting or when adding new stations or devices.

Using DHCP

The second way to use the default settings is to allow the Router to automatically assign IP settings for workstation using DHCP. To do this, simply make sure your computers' IP addresses are set to 0.0.0.0 (under Windows, choose the option Obtain an IP address automatically in the TCP/IP network component described above). When the computers are restarted, their IP settings will automatically be assigned by the Router. The Router is set by default to use DHCP. See the discussion in Chapter 5 for information on how to use configure the Router for DHCP.

Changing the IP Address of the Router

When planning your LAN IP address setup, you may use any scheme allowed by rules that govern IP assignment. It may be more convenient or easier to remember an IP scheme that use a different address for the Router. Or you may be installing the Router on a network that has already established the IP settings. Changing the IP address is a simple matter and can be done using the web manager (see *LAN IP Address* in Chapter 5). If you are incorporating the Router into a LAN with an existing IP structure, be sure to disable the DHCP function. Also, consider the effects of the NAT function which is enable by default.

An IP addressing scheme commonly used for Ethernet LANs establishes 10.0.0.1 as the base address for the network. Using Example #2 below, the Router is assigned the base address 10.0.0.1 and the remaining addresses are assigned manually or using DHCP.

Alternative IP Assignment			
Host	IP Address	Subnet Mask	Gateway IP
Router	10.0.0.1	255.255.255.0	10.0.0.254
Computer #1	10.0.0.2	255.255.255.0	10.0.0.254
Computer #2	10.0.0.3	255.255.255.0	10.0.0.254
Computer #3	10.0.0.4	255.255.255.0	10.0.0.254

IP Setup - Example #2

These two examples are only examples you can use to help you get started. If you are interested in more advanced information on how to use IP addressing on a LAN there are numerous resources freely available on the Internet. There are also many books and chapters of books on the subject of IP address assignment, IP networking and the TCP/IP protocol suite.



IP Concepts

This appendix describes some basic IP concepts, the TCP/IP addressing scheme and show how to assign IP Addresses.

When setting up the Router, you must make sure it has a valid IP address. Even if you will not use the WAN port (ADSL port), you should, at the very least, make sure the Ethernet LAN port is assigned a valid IP address. This is required for telnet, in-band SNMP management, and related functions such as “trap” handling and TFTP firmware download.

IP Addresses

The Internet Protocol (IP) was designed for routing data between network sites all over the world, and was later adapted for routing data between networks within any site (often referred to as “subnetworks” or “subnets”). IP includes a system by which a unique number can be assigned to each of the millions of networks and each of the computers on those networks. Such a number is called an IP address.

To make IP addresses easy to understand, the originators of IP adopted a system of representation called “dotted decimal” or “dotted quad” notation. Below are examples of IP addresses written in this format:

201.202.203.204 189.21.241.56 125.87.0.1

Each of the four values in an IP address is the ordinary decimal (base 10) representation of a value that a computer can handle using eight “bits” (binary digits — 1s and 0s). The dots are simply convenient visual separators.

Zeros are often used as placeholders in dotted decimal notation; 189.21.241.56 can therefore also appear as 189.021.241.056.

IP networks are divided into three classes on the basis of size. A full IP address contains a network portion and a “host” (device) portion. The network and host portions of the address are different lengths for different classes of networks, as shown in the table below.

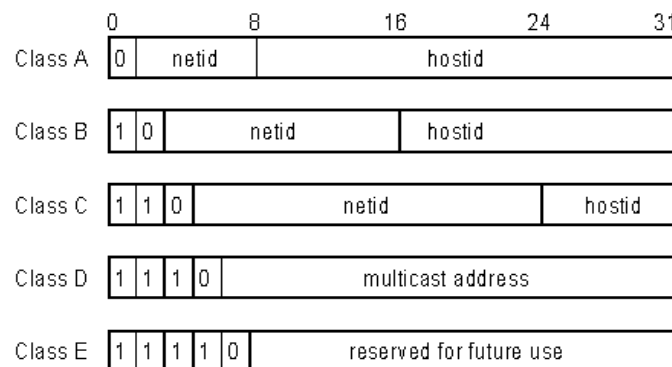

Networks attached to the Internet are assigned class types that determine the maximum number of possible hosts per network. The previous figure illustrates how the net and host portions of the IP address differ among the three classes. Class A is assigned to networks that have more than 65,535 hosts; Class B is for networks that have 256 to 65534 hosts; Class C is for networks with less than 256 hosts.

IP Network Classes			
Class	Maximum Number of Networks in Class	Network Addresses (Host Portion in Parenthesis)	Maximum Number of Hosts per Network
A	126	1(.0.0.0) to 126(.0.0.0)	16,777,214
B	16,382	128.1(.0.0) to 191.254(.0.0)	65,534
C	2,097,150	192.0.1(.0) to 223.255.254(.0)	254

Note: All network addresses outside of these ranges (Class D and E) are either reserved or set aside for experimental networks or multicasting.

When an IP address's host portion contains only zero(s), the address identifies a network and not a host. No physical device may be given such an address.

The network portion must start with a value from 1 to 126 or from 128 to 223. Any other value(s) in the network portion may be from 0 to 255, except that in class B the network addresses 128.0.0.0 and 191.255.0.0 are reserved, and in class C the network addresses 192.0.0.0 and 223.255.255.0 are reserved.

The value(s) in the host portion of a physical device's IP address can be in the range of 0 through 255 as long as this portion is not all-0 or all-255. Values outside the range of 0 to 255 can never appear in an IP address (0 to 255 is the full range of integer values that can be expressed with eight bits).

The network portion must be the same for all the IP devices on a discrete physical network (a single Ethernet LAN, for example, or a WAN link). The host portion must be different for each IP device — or, to be more precise, each IP-capable port or interface — connected directly to that network.

The network portion of an IP address will be referred to in this manual as a **network number**; the host portion will be referred to as a **host number**.

To connect to the Internet or to any private IP network that uses an Internet-assigned network number, you must obtain a registered IP network number from an Internet-authorized network information center. In many countries you must apply through a government agency, however they can usually be obtained from your Internet Service Provider (ISP).

If your organization's networks are, and will always remain, a closed system with no connection to the Internet or to any other IP network, you can choose your own network numbers as long as they conform to the above rules.

If your networks are isolated from the Internet, e.g. only between your two branch offices, you can assign any IP Addresses to hosts without problems. However, the Internet Assigned Numbers Authority (IANA) has reserved the following three blocks of IP Addresses specifically for private (stub) networks:

Class	Beginning Address	Ending Address
A	10.0.0.0	10.255.255.255
B	172.16.0.0	172.31.255.255
C	192.168.0.0	192.168.255.255

It is recommended that you choose private network IP Addresses from the above list. For more information on address assignment, refer to RFC 1597, *Address Allocation for Private Internets* and RFC 1466, *Guidelines for Management of IP Address Space*.

Subnet Mask

In the absence of subnetworks, standard TCP/IP addressing may be used by specifying subnet masks as shown below.

IP Class	Subnet Mask
Class A	255.0.0.0
Class B	255.255.0.0
Class C	255.255.255.0

Subnet mask settings other than those listed above add significance to the interpretation of bits in the IP address. The bits of the subnet mask correspond directly to the bits of the IP address. Any bit in a subnet mask that is to correspond to a net ID bit in the IP address must be set to 1.



Microfilters and Splitters

Most ADSL clients will be required to install a simple device that prevents the ADSL line from interfering with regular telephone services. These devices are commonly referred to as microfilters or sometimes called (inaccurately) line splitters. They are easy to install and use standard telephone connectors and cable.

Some ADSL service providers will send a telecommunications technician to modify the telephone line, usually at the point where the telephone line enters the building. If a technician has divided or split your telephone line into two separate lines - one for regular telephone service and the other for ADSL – then you do not need to use any type of filter device. Follow the instructions given to you by your ADSL service provider about where and how you should connect the Modem to the ADSL line.

Microfilters

Unless you are instructed to use a “line splitter” (see below), it will be necessary to install a microfilter (low pass filter) device for each telephone or telephone device (answering machines, Faxes etc.) that share the line with the ADSL service. Microfilters are easy-to-install, in-line devices, which attach to the telephone cable between the telephone and wall jack. Microfilters that install behind the wall plate are also available. A typical in-line microfilter installation is shown in the diagram below.

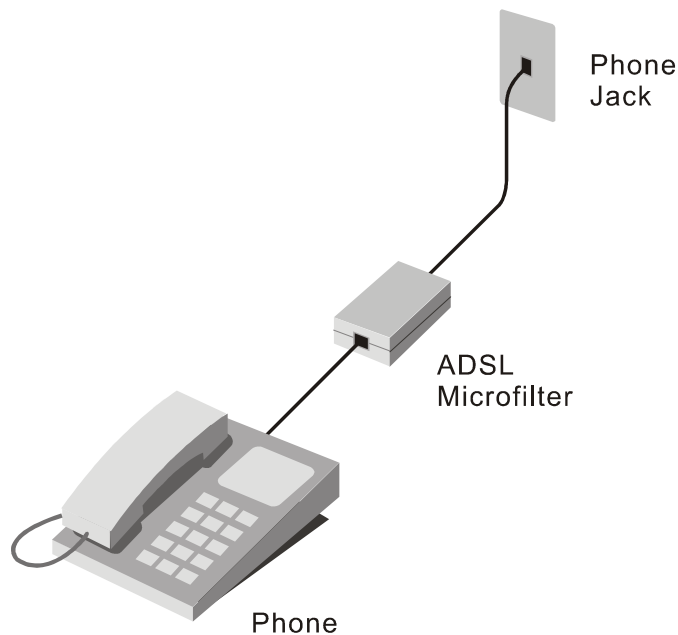

Microfilter Installation

Important: Do not install the microfilter between the Modem and the telephone jack. Microfilters are only intended for use with regular telephones, Fax machines and other regular telephone devices.

Line Splitter

If you are instructed to use a “line splitter”, you must install the device between the Modem and the phone jack. Use standard telephone cable with standard RJ-11 connectors. The splitter has three RJ-11 ports used to connect to the wall jack, the Modem and if desired, a telephone or telephone device. The connection ports are typically labeled as follows:

Line - This port connects to the wall jack.

ADSL – This port connects to the Modem.

Phone – This port connects to a telephone or other telephone device.

The diagram below illustrates the proper use of the splitter.

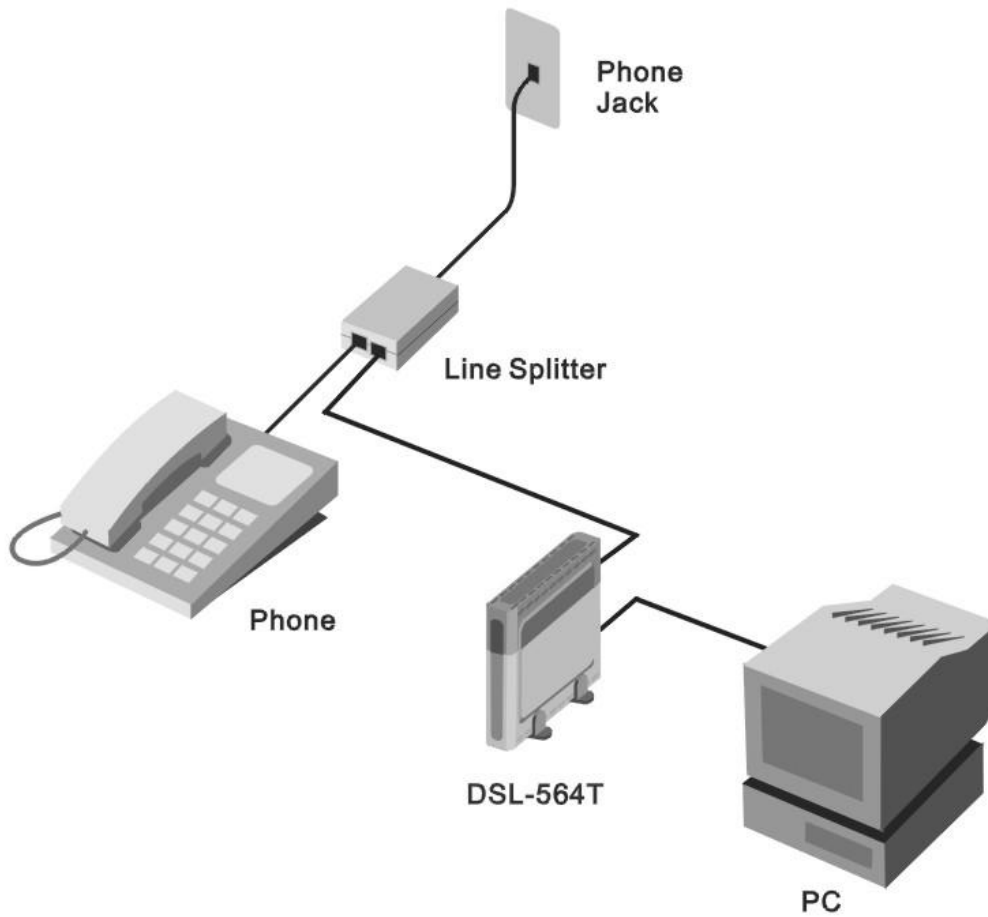

Line Splitter Installation

Australia	D-Link Australasia 1 Giffnock Avenue, North Ryde, NSW 2113, Sydney, Australia TEL: 61-2-8899-1800 FAX: 61-2-8899-1868 URL: www.dlink.com.au
Belgium	D-Link Belgium Rue des Colonies 11, B-1000 Brussels, Belgium TEL: 32 (0)2 517 7111 FAX: 32 (0)2 517 6500 URL: www.dlink-benelux.com
Brazil	D-Link Brasil Ltda. Av das Nações Unidas, 11857, cj 132 – Brooklin Novo São Paulo, Brasil 04578-000 TEL: (55 11) 5503-9320 FAX: (55 11) 5503-9321 URL: www.dlink.com.br
Canada	D-Link Canada 2180 Winston Park Drive, Oakville, Ontario, L6H 5W1 Canada TEL: 1-905-829-5033 FAX: 1-905-829-5223 URL: www.dlink.ca
Chile	D-Link South America (Sudamérica) Isidora Goyenechea 2934 Oficina 702 Las Condes Fono 2323185, Santiago, Chile TEL: 56-2-232-3185 FAX: 56-2-232-0923 URL: www.dlink.cl
China	D-Link China Room 507/508, Tower W1, The Towers, Oriental Plaza No. 1 East Chang An Ave., Dong Cheng District Beijing, 100738, China TEL: (86-010) 85182533 FAX: (86-010) 85182250 URL: www.dlink.com.cn
Denmark	D-Link Denmark Naverland 2, DK-2600 Glostrup, Denmark TEL: 45-43-96-90-40 FAX: 45-43-42-43-47 URL: www.dlink.dk
Egypt	D-Link Egypt 19 El-Shahed Helmy, El Masry, Al-Maza, Heliopolis, Cairo, Egypt TEL: 202-41-44-295 FAX: 202-41-56-704 URL: www.dlink-me.com
Finland	D-Link Finland Pakkalankuja 7A, 3 rd floor, 01510 Vantaa, Finland TEL: 358-9-2707-5080 FAX: 358-9-2707-5081 URL: www.dlink.fi
France	D-Link France Le Florilege, No. 2, Allée de la Fresnerie, 78330 Fontenay le Fleury, France TEL: 33-1-3023-8688 FAX: 33-1-3023-8689 URL: www.dlink-france.fr
Germany	D-Link Central Europe (D-Link Deutschland GmbH)

Schwalbacher Strasse 74, D-65760 Eschborn, Germany
TEL: 49-6196-77990 FAX: 49-6196-7799300
URL: www.dlink.de

- India** **D-Link India**
D-Link House, Kurla-Bandra Complex Rd., Off Cst Rd.,
Santacruz (East), Mumbai, 400 098 India
TEL: 91-022-652-6696/6578/6623
FAX: 91-022-652-8914/8476
URL: www.dlink.co.in & www.dlink-india.com
- Israel** **D-Link Israel**
11 Hamanofim Street, Ackerstein Towers, Regus Business Center
P.O.B. 2148, Hertzelia-Pituach 46120, Israel
TEL: 972-9-9715700 FAX: 972-9-9715601
URL: www.dlink.co.il
- Italy** **D-Link Mediterraneo Srl/D-Link Italia**
Via Nino Bonnet n. 6/B, 20154, Milano, Italy
TEL: 39-02-2900-0676 FAX: 39-02-2900-1723
URL: www.dlink.it
- Netherlands** **D-Link Netherlands**
Weena 290, 3012 NJ Rotterdam, The Netherlands
TEL: 31 (0)10 282 1445 FAX: 31 (0)10 282 1331
URL: www.dlink-benelux.com
- Norway** **D-Link Norway**
Karihaugveien 89, N-1086 Oslo
TEL: 47-23-89-71-89 FAX: 47-22-30-90-85
URL: www.dlink.no
- Russia** **D-Link Russia**
Grafsky per., 14, floor 6, Moscow 129626 Russia
TEL: 7 (095) 744-0099 FAX: 7 (095) 744-0099 #350
URL: www.dlink.ru
- Singapore** **D-Link International**
1 International Business Park, #03-12 The Synergy,
Singapore 609917
TEL: 65-6774-6233 FAX: 65-6774-6322
URL: www.dlink-intl.com
- South Africa** **D-Link South Africa**
Einstein Park II, Block B
102-106 Witch-Hazel Avenue
Highveld Technopark, Centurion, Gauteng, Republic of South Africa
TEL: 27-12-665-2165 FAX: 27-12-665-2186
URL: www.d-link.co.za
- Spain** **D-Link Iberia**
C/Sabino de Arana, 56 Bajos, 08028 Barcelona, Spain
TEL: 34 93 409 0770 FAX: 34 93 491 0795
URL: www.dlink.es
- Sweden** **D-Link Sweden**
P. O. Box 15036, S-167 15 Bromma, Sweden
TEL: 46-(0)8564-61900 FAX: 46-(0)8564-61901
URL: www.dlink.se
- Taiwan** **D-Link Taiwan**

2F, No. 119, Pao-chung Road, Hsin-tien, Taipei, Taiwan
TEL: 886-2-2910-2626 FAX: 886-2-2910-1515
URL: www.dlinktw.com.tw

- Turkey D-Link Turkey
Regus Offices Beybi Giz Plaza, Ayazaga Mah. Meydan Sok. No. 28
Maslak 34396, Istanbul-Turkiye
TEL: 90-212-335-2553 FAX: 90-212-335-2500
URL: www.dlink.com.tr
- U.A.E. D-Link Middle East
P.O. Box 500376, Office No. 103, Building 3
Dubai Internet City, Dubai, United Arab Emirates
TEL: 971-4-3916480 FAX: 971-4-3908881
URL: www.dlink-me.com
- U.K. D-Link Europe (United Kingdom)
4th Floor, Merit House, Edgware Road, Colindale, London
NW9 5AB United Kingdom
TEL: 44-020-8731-5555 FAX: 44-020-8731-5511
URL: www.dlink.co.uk
- U.S.A. D-Link Systems, Inc.
17595 Mt. Herrmann, Fountain Valley, CA 92708, USA
TEL: 1-714-885-6000 FAX: 1-866-743-4905
URL: www.dlink.com

Registration Card

Print, type or use block letters.

Your name: Mr./Ms _____
 Organization: _____ Dept. _____
 Your title at organization: _____
 Telephone: _____ Fax: _____
 Organization's full address: _____

 Country: _____
 Date of purchase (Month/Day/Year): _____

Product Model	Product Serial No.	* Product installed in type of computer (e.g., Compaq 486)	* Product installed in computer serial No.

(* Applies to adapters only)

Product was purchased from:

Reseller's name: _____
 Telephone: _____ Fax: _____
 Reseller's full address: _____

Answers to the following questions help us to support your product:

- 1. Where and how will the product primarily be used?**
 Home Office Travel Company Business Home Business Personal Use
- 2. How many employees work at installation site?**
 1 employee 2-9 10-49 50-99 100-499 500-999 1000 or more
- 3. What network protocol(s) does your organization use ?**
 XNS/IPX TCP/IP DECnet Others _____
- 4. What network operating system(s) does your organization use ?**
 D-Link LANsmart Novell NetWare NetWare Lite SCO Unix/Xenix PC NFS 3Com 3+Open
 Banyan Vines DECnet Pathwork Windows NT Windows NTAS Windows '95
 Others _____
- 5. What network management program does your organization use ?**
 D-View HHP OpenView/Windows HHP OpenView/Unix SunNet Manager Novell NMS
 NetView 6000 Others _____
- 6. What network medium/media does your organization use ?**
 Fiber-optics Thick coax Ethernet Thin coax Ethernet 10BASE-T UTP/STP
 100BASE-TX 100BASE-T4 100VGAnyLAN Others _____
- 7. What applications are used on your network?**
 Desktop publishing Spreadsheet Word processing CAD/CAM
 Database management Accounting Others _____
- 8. What category best describes your company?**
 Aerospace Engineering Education Finance Hospital Legal Insurance/Real Estate Manufacturing
 Retail/Chainstore/Wholesale Government Transportation/Utilities/Communication VAR
 System house/company Other _____
- 9. Would you recommend your D-Link product to a friend?**
 Yes No Don't know yet
- 10. Your comments on this product?** _____

PLEASE
PLACE STAMP
HERE

TO:

D-Link®