

User Manual

125 High Speed Mode* Wireless Cable/DSL Router WHR3-G54

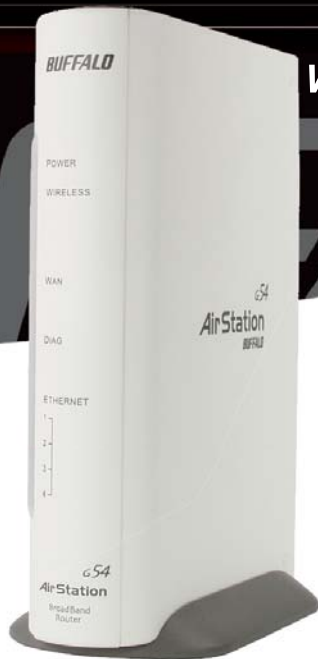

AOSS™

Rev B

Introduction	05
Installation / Setup	11
Antenna Installation.	13
Standard Settings	14
AOSS Setup	23
Advanced Setup	26
LAN Settings	26
Wireless Settings	26
Wireless LAN Security	28
LAN Port	32
DHCP Server	33
Wireless MAC Filtering	36
Wireless Bridge (WDS)	38
WAN Settings	40
WAN Port	40
WAN Network	43

Network Settings	45
Routing Setup	45
Address Translation	47
Packet Filter	50
Intrusion Detector	55
UPnP	57
Management	58
System Information	58
Change Password	59
Time Setup	60
Traffic Information	61
Client Monitor	62
Ping Tool	63
Log Information	64
Syslog Transfer	65
Save/Restore Settings	66
Reboot/Reload Settings	67
Firmware Updates	68
AOSS	69

Specifications	71
Troubleshooting	76
Glossary	84
FCC Information	90
Warranty Information.	93
Contact Information	94

AirStation 125 High Speed Mode Wireless Cable/DSL Router (WHR3-G54)

This manual introduces you to the AirStation Cable/DSL Router, and will help you connect to your network quickly.

The WHR3-G54 router, is a wireless 4-port router network device that complies with the 2.4GHz IEEE 802.11g standard specification on wireless LANs. It also supports 125 High Speed Mode technology. The WHR3-G54 supports enhanced built-in NAT/SPI firewall functions and is used as a multi-functional router/link between wired and wireless LAN computers.

Summary of the AirStation WHR3-G54 features:

- Wi-Fi™ (Wireless Fidelity) certified by the Wi-Fi Alliance as an 802.11b/g device. AirStation will communicate with other IEEE 802.11b/g/Wi-Fi compliant wireless LAN products.
- Supports 125 High Speed Mode
- Support for Wi-Fi Protected Access™ (WPA), 802.1x, TKIP, AES, and WEP.
- Supports Frame Bursting for enhanced performance.
- DHCP client/server function.
- Auto roaming, supports seamless roaming over multiple channels.
- VPN pass-through, for secure communications.
- Packet Filtering for eliminating unwanted communications.
- SOHO/SMB routing and firewall functions provide a safer private networking environment, including support for MS NetMeeting and MSN-Messenger.

- Additional SPI Firewall Functions - DMZ, intrusion detection and notification
- Syslog transmits some or all system activities to a central Syslog server.
- Extended range, with optional add-on antennas or WDS (Wireless Distribution System).
- Auto Media Dependent Interface/Crossover (MDI/X) port, allows connection by standard and crossover CAT5 cables.
- Supports Universal Plug and Play (UPnP).
- Buffalo's AOSS System for easy, secure wireless client configuration.
- Enhanced security features:
 - SPI Firewall and DMZ zone functions to prevent unknown intruders.
 - Intrusion Detector Firewall (NAT) with a pop-up or email alert warning unwanted attacks.
 - Dynamic packet filtering.
 - WPA, 802.1x, TKIP, AES, and WEP.
 - VPN (IPSec, PPTP and L2TP) pass-through
 - Packet monitoring and filtering by MAC address, IP address and port.
 - PPPoE support
 - WDS support
- Buffalo's easy web interface configuration
- Broadband router static and dynamic routing methods between WAN and LAN based on updated routing tables. An economical way to bridge multiple networks.

- Optional external antennas for boosting range and signal quality.
- Buffalo's AOSS System for easy, secure wireless client configuration.

Home Networking

Buffalo AirStation wireless access points enable sharing broadband by simply connecting the AirStation to a DSL or Cable modem to:

- Share files and printers
- Access and share the Internet
- Share media files

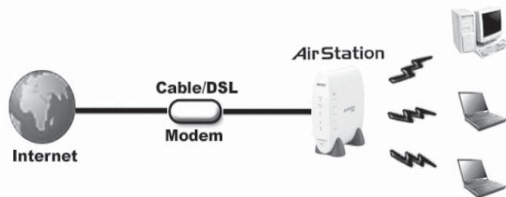

SOHO/SMB Networking

With high-speed DSL or Cable connections readily available, many users can work effectively from a home office, connected securely to a corporate network. Buffalo's solutions are ideal for home networks that require secure, high-speed access to the corporate LAN. Tools that play an integral part in Buffalo's solutions include VPN connectivity for secure access to corporate resources, which enable the remote employee to handle information from clients or coworkers as if they were in the office. Connect the Buffalo AirStation Broadband router AP to a Cable or DSL modem in order to:

- Share broadband access
- Share files and printers
- Bridge between multiple networks and multiple computer platforms
- Provide easy and secure access to home or company networks from remote locations

System Requirements

- Broadband (High-Speed) Internet connection or existing Local area connection
- Any Wi-Fi (wireless) compatible computer with a Web Browser Internet Explorer or Netscape 4.5 or later. (Safari 1.0 is supported with Macintosh OS X.2)

AirStation WHR3-G54 Package Contents

The AirStation WHR3-G54 package consists of the following items.

1. WHR3-G54 Base Station
2. AC adapter and power cable
3. CAT5 LAN cable
4. Utility CD with Manual
5. Quick Setup Guides
6. Warranty Statement

Product Views

Power - Lit when the device is powered on.

Wireless - Lit when the wireless radio is on.
Flashes when wireless traffic is present.

WAN - Lit when connection to Cable/DSL modem is present. Flashes when internet traffic is present.

Diag - Flashes red when performing diagnostic functions.

AOSS - Flashes when in AOSS mode, solid when AOSS encryption has been set.

Ethernet - 1, 2, 3, or 4 lit when ethernet clients are connected. Flashes when ethernet traffic is present.

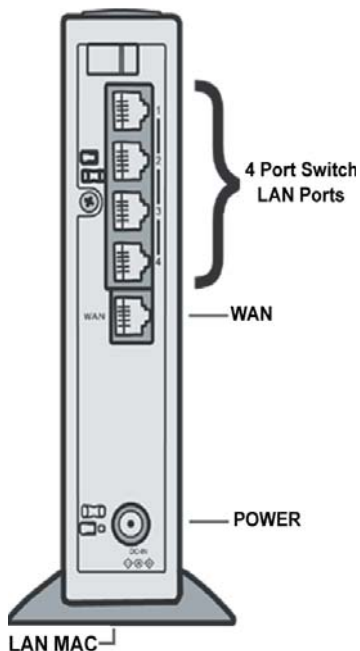

About the AirStation CD

The AirStation does not require any software to be installed on your computer for configuration. The AirStation CD contains client drivers for Buffalo Wireless Adapters (i.e. Notebook Adapter and Desktop PCI Adapter) and the AirStation documentation.

Prior to copying or installing any software, please read the Software License Agreement “license.txt”, located in the root folder of the CD. By installing, copying or using the AirStation software, you are consenting to the terms of this agreement. If you do not agree to all of the terms of the Software License Agreement, do not download, copy or install the AirStation software.

It is the policy of Buffalo Technology to improve products as new technology, components, software and firmware become available.

Please consult the AirStation wireless website (<http://www.buffalotech.com/wireless>) to download and install the latest firmware for your product.

Follow these simple steps to connect the AirStation to your Broadband Internet connection allowing you to combine and share wired and wireless computers and printers with the high-speed internet connection.

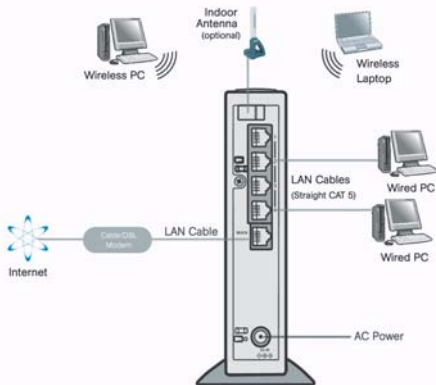

1. Power down the Cable or DSL modem and the computer which will be used to configure the AirStation router.
2. Plug the Cable or DSL's LAN Ethernet cable into the AirStation's WAN port. Initially, you may need to unplug this cable from your computer, hub or other router.
3. Plug the provided Ethernet cable into a LAN port on the AirStation and plug the other end into your computer Ethernet adapter's (NIC) port. If you plan to initially configure the AirStation via a wireless connection, (not recommended), you may skip this step.
4. Power on your cable or DSL modem, wait one full minute, Power on the AirStation router, wait another full minute and then power on the computer which will be used to configure the AirStation. If the red DIAG light on the AirStation is lit or flashing after several minutes of being powered on, please consult Buffalo Technical Support.

Introduction

Configuring the AirStation using a standard web browser requires basic wireless configuration knowledge. Setup includes manual wireless configuration and basic administrative management.

Setup Preparation

Make note of the AirStation's wired MAC address (found on the underside of the WHR3-G54). It is also recommended you record any other broadband ISP information such as global IP address, subnet mask address, default gateway address, DNS server address and PPPoE parameters.

Setup Overview

Buffalo recommends using a wired connection, meaning your computer is physically connected to the AirStation with a CAT5 straight cable plugged into one of the four LAN ports. This type of setup will eliminate possible setup problems due to any issues with the wireless adapter on the computer being used to configure the AirStation.

A Web browser version 4.5 or later can be used to configure the AirStation.

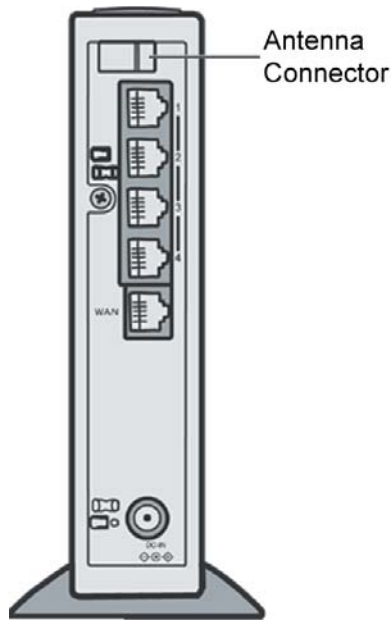

The WHR3-G54 has two internal antennas. One has a vertical orientation while the other has a horizontal orientation. This setup is ideal because it allows for proper antenna polarization with both desktop and notebook style wireless adapter antennas.

However, it may be necessary to increase your range further by installing an external, higher-gain antenna. External antennas come in all shapes and sizes. Antennas also come with different connectors. The WHR2-G54 has an **'MC Connector'** on it. Thus, the antenna must also have an MC connector.

To install the antenna, slide the antenna connector door on the back of the WHR3-G54 to the right. This will expose the MC Connector. Attaching the antenna is simple, just insert the antenna's MC Connector into the WHR3-G54's MC Connector and firmly push it in until it snaps into place. Once snapped, the antenna's connector will swivel with ease. It is important not to push the antenna connector in at an angle.

To remove the antenna, pull the antenna connector out. It is important not to pull the antenna connector out at an angle.

Advanced settings for security, filtering and other features will be explained in later sections.

Open the Setup Screen

- Connect the WHR3-G54 according to the wiring instructions in Section 2.
- The WHR3-G54 has a default LAN IP address of 192.168.11.1 and Subnet Mask of 255.255.255.0.

Initial
Settings
Login



■ Note: The computer used to configure the AirStation should be set to obtain an IP address automatically using a DHCP server. The Quick Setup Guide enclosed with the product contains detailed instructions on how to configure your computer for initial configuration.

On the computer used to configure the AirStation, launch a Web Browser 4.5 or later.

- Enter **192.168.11.1** into the URL field.

- A window will open prompting you to enter a User ID and Password.
Enter “**root**” as the User ID and leave the password field **blank**.

■ Note: These are the factory default settings

Initial
Settings
Screen



Enter ISP information

- Click the appropriate button to select the type of broadband access. (Users more experienced in networking may choose to select the Advanced button and skip to Section 4.)
- For supplementary tools, use the tabs along the top of the screen.

Initial DSL
button
Screen



DSL Button

Select the appropriate connection method.

Automatic IP Assignment by ISP

- The DHCP server of the ISP assigns an IP address automatically.

Manual DSL
IP Settings
Screen

Input a static IP Address manually

Static IP Address and Subnet Mask (IPv4)

DNS Servers (IPv4)

AirStation WAN side MAC Address

Default Gateway

Back Next

Enter IP Address Manually

- Enter the IP Address given by the ISP.
- Use 'Enter IP Address Manually' if the ISP requires use of a static IP address.

DSL PPPoE
Settings
Screen

DSL PPPoE Connection Information is required

User Name

Password

Service Name

DSL (wan) server address

Primary Secondary

Back Next

PPPoE Connection

- Enter the PPPoE information provided by the ISP.

Initial CATV
Settings
Screen



CATV (Cable) Button

Select the appropriate connection method.

Automatic IP Assignment by ISP

- Select 'Automatic IP Assignment by ISP' if your ISP's DHCP server assigns an IP address automatically.

Manual IP
Address
Settings

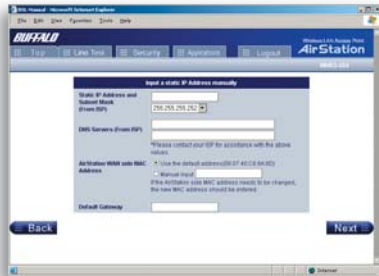

Enter IP Address Manually

- Select 'Enter IP Address Manually' if the ISP requires use of a static IP address.

Auto IP/
Manual DNS
Settings

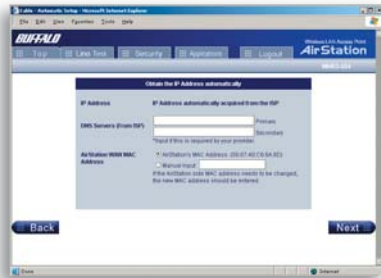

The IP Address is Acquired Automatically but DNS Server Address is Entered Manually

- Select 'IP address is acquired automatically but DNS server address is entered manually' if the ISP's DHCP server supplies an IP address but not DNS server addresses.

Line
Test Tab



Line Test

Tests the connection to the Internet.

Security Tab



Security

The Security Tab offers three Simple Security Settings. Follow the instructions in each screen to enter Encryption Keys, MAC Address Filtering and the degree of firewall security for the AirStation.



Encryption Setup.

- Select the desired encryption scheme from the choices. After it has been selected, press the **'Next'** button. You will then be prompted to enter the appropriate key(s) for that method of encryption.



Simple MAC Address Filter.

- Select **'Enable'** to use MAC filtering. See **'Page 36'** for more information on MAC Address Filtering.

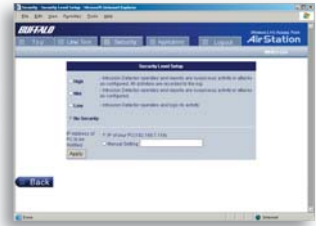

Simple Security Setup.

- See **'Page 55'** for more information on Intrusion Detector.

Application
Tab



Applications

The Application Tab offers setup for special applications such as games, MS NetMeeting and MSN Messenger. Then follow the on-screen menus to configure the AirStation for the application.



Internet Gaming Setup

-Enter the **ports**(refer to Game documentation) the game runs on, and enter the Local IP Address of the PC that plays the game.



NetMeeting Setup

-Enter the **IP Address** of the PC that will use Netmeeting.



MSN Messenger Setup

-Refer to the **on-screen help** for information about Messenger.

Although your AirStation will function fine using only the **Standard Settings**, you may wish to explore more advanced options. The **Advanced Settings** section explains each function in the Advanced settings area.

Click the Top tab and click the Advanced button to enter the Advanced settings area.

AOSS (AirStation One-Touch Secure System) is a simple, one-touch setup for connecting wireless clients to an access point while setting up the most secure possible connection. Users no longer need to worry about choosing the proper security protocols, IP addresses, or SSID's. The intelligence of AOSS determines the most optimal connection and configures itself in seconds.

■ **NOTE:** AOSS automatically creates a secure connection between your AOSS Access Point and client. You must have a Buffalo AOSS enabled wireless client device to use the AOSS features of your AOSS Access Point/Router.

- ▶ Configure your WHR3-G54' internet connection by referring to the instructions in the WHR3-G54' Quick Setup Guide.
- ▶ Once the WHR3-G54 has been configured, follow the directions to install your wireless client device and its drivers if necessary. Certain wireless client adapters require client software to configure them. If your device has a Client Manager, then install it as well.

■ **NOTE:** If the wireless client adapter is installed on a PC, then the AOSS client manager will need to be installed as well. If your wireless client adapter is a standalone device that does not require a PC, then just power up the device.

Standalone Devices: Ethernet Converters and Access Point Bridges

Client Manager Devices: CardBus, USB, and PCI Adapters.

		
Standalone AOSS Device	Client Manager Device	Client Manager Software



- ▶ Now that the WHR3-G54 and wireless client adapter are installed, you can use AOSS to configure them.
- ▶ To begin the configuration, press the AOSS button on the side of the WHR3-G54 for 3-5 seconds. The AOSS light will begin to flash when the AOSS mode has been enabled. You can stop pressing the button at this point.
- NOTE: AOSS mode will stay active for a period of two minutes. This is the time-slot required to initiate the wireless client adapter. The AOSS LED will stop flashing when AOSS mode has stopped or timed out.
- ▶ Refer to your wireless client adapter's AOSS supplement to initiate the wireless client adapter's AOSS mode.
- ▶ It typically takes 10-15 seconds for the AOSS light to stop flashing after the AOSS button has been pressed on the wireless client adapter. Once configuration is complete, the AOSS light will remain steady. Please refer to your wireless client adapter's supplement for the remainder of the setup.

Additional AOSS Information:

- ▶ Only one AOSS wireless client adapter can be configured to the AOSS router at a time. Thus, the button will need to be repressed for each additional AOSS wireless client adapter that will be connected.
- ▶ It is not necessary to AOSS client devices that have already been configured via AOSS, unless significant changes have been made to the wireless network.
- ▶ Do not attempt to configure two separate AOSS networks at the same time, as it may cause undesired configurations.
- ▶ If an undesired client has connected via AOSS, it can be disconnected from within the WHR3-G54' advanced configuration menus.

LAN Settings

Wireless Settings

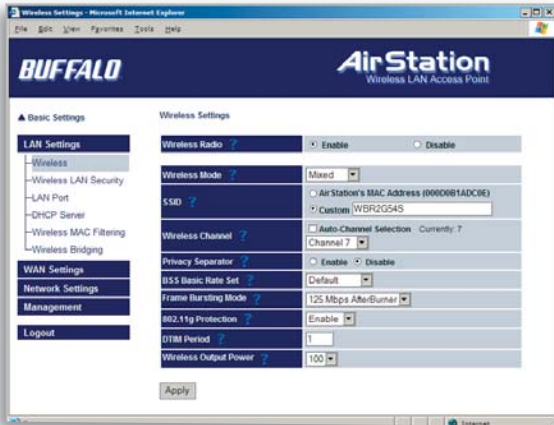

Set up LAN connections.

Wireless Settings

Wireless Function - Enable or disable wireless LAN computer communication.

SSID - Allows administrator to alter the SSID of the AirStation. To communicate with a specific AP only, the AP's SSID must be entered in the client computer. The client computer looks for the specific AP (or SSID) for wireless communication. Use up to 32 alphanumeric characters

for the SSID (case sensitive). By default the SSID is the LAN Mac address of the AirStation.

■ **Note:** Roaming - When multiple AirStations have an identical SSID, WEP key (if WEP is used), (and channel in WDS mode), client computers may Roam between the AirStations.

Wireless Channel - Select the channel used for wireless communication. There are 11 overlapping channels. Channels 1, 6 and 11 are non-overlapping. The 'Auto-Channel' option is recommended, as it constantly assesses the best available channel for the AirStation to operate on.

If there are multiple APs in close proximity using the same channel, there may be interference. In this case, change to a non-overlapping channel.

Privacy Separator - Enable or disable communication between wireless clients. If you choose to use this feature, every wireless client that is associated to the AirStation will not be able to communicate with any other wireless clients.

■ **Note:** If this function is used, wired clients can still communicate with wireless clients.

BSS (Basic Service Set) Basic Rate Set - The transmission data rates offered by the AirStation. It is recommended to use the 'Default' selection to accommodate 802.11 and 802.11b rate sets. It is NOT recommended to use the 'All' selection, as some devices may not understand all of the rate sets offered by the AirStation.

Frame Bursting - This function increases 802.11g communication throughput by transferring packets more efficiently. The following conditions affect this function:

- The wireless LAN client adapter must support Frame Bursting (and it must be enabled). If the wireless LAN client adapter does not support Frame Bursting, or Frame Bursting is not enabled, then it will operate at non-Frame Bursting speeds.

125 High Speed Mode - This function further increases 802.11g communication. Rate sets up to 125 Mbps are offered to clients. The following conditions affect this function:

- The wireless LAN client adapter must support 125 High Speed Mode (and it must be enabled). If the wireless LAN client adapter does not support 125 High Speed Mode, or it is not enabled, then it will operate at regular 802.11g speeds.

It is recommended to leave 125 High Speed Mode enabled as it can only help throughput, not hurt it.

802.11g Protection - This enables protection mechanisms for when 802.11b clients join the network. It enables CTS (Clear-to-Send)

DTIM Period - An access point transmits beacon signals to nearby clients at a preset interval. This parameter sets the beacon transmission interval time (1-255 seconds). Selection of a larger number may conserve energy for the client computer (when client power management is enabled), but may delay wireless communication. The default value of 1 is recommended.

Wireless Output Power - Configure output power of the AirStation. Decrease wireless output power to shrink the wireless communication range. The default setting of 100% is recommended unless decreased range is desired

Wireless
Security
Settings

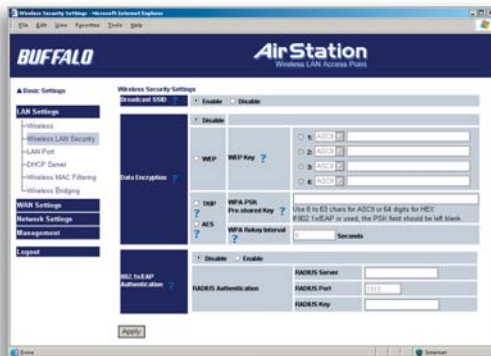

Wireless LAN Security

Broadcast SSID - Enable or Disable the SSID (SSID) from being broadcasted. If denied, the AirStation will not be found unless the specific AirStation's SSID is entered in the client computer manually.

Data Encryption - Disable to have no encryption of the wireless data. This will make accessing the AirStation and the network very easy. It is im-

important to note, that without encryption it is easy for strangers to connect to your network, especially if the AirStation is broadcasting its SSID.

Select the type of data encryption:

- Disabled - Disable data encryption.
 - WEP - Uses WEP encryption. Encryption key should be entered.
 - TKIP - Uses TKIP (Temporal Key Integrity Protocol) for data encryption.

The encryption key is renewed every “Re-key interval” when “TKIP” is selected.

WEP - When the WEP (Wired Equivalent Protection) encryption standard is implemented into a wireless network, a WEP key is used between the client and access point to successfully encrypt, transmit and decrypt data. For this reason, the same WEP key must be used for communication between the client and the AirStation.

An access point and client may both carry multiple WEP keys. It is necessary for not only the WEP keys to match, but also the WEP key's order. If a wireless client cannot support multiple WEP keys, the AirStations must be configured to transmit key number 1 for a connection to take place.

Examples of WEP key:

64-bit ASCII: 5 digits of alphanumeric characters, “ab34Y”

128-bit ASCII: 13 digits of alphanumeric characters, “123456abcdef7”

■ **Note:** ASCII WEP keys are case sensitive.

64-bit HEX: 10 digits, using characters 0-9 and a-f, “00234ABCDE”

128-bit HEX: 26 digits, using characters 0-9 and a-f, “20123456789abcdeabcdeabcde”

TKIP - TKIP (Temporal Key Integrity Protocol) is a WEP expanded encryption technique. TKIP has greatly improved WEP's weaknesses by rotating secret keys between every packet. TKIP uses WPA-PSK (pre-Shared Key).

Characteristics:

- The Initialization Vector is expanded from 24-bits to 48-bits.
- The Initialization Vector is randomized.
- Uses a different RC4 key for every packet.

AES - AES further improves TKIP by using AES (Advanced Encryption Standard) encryption method. Due to its hardware co-processor, AES uses the toughest encryption without sacrificing throughput like WEP and TKIP.

TKIP & AES require an 8 to 63 character passphrase in ASCII or 64 digits hexadecimal key.

Example 1: [airstation -WPA-PSK]

Example 2: [0123456789abcdef0123456789abcdef0123456789abcdef0123456789abcdef]

WPA Group Rekey Interval - When TKIP is selected, the encryption key is renewed at this interval. This interval is in seconds; the range of acceptable values is 0-3600.

If 0 is entered, the key is never renewed.

■ **Note:** The lower the rekey interval, the more often a rekey occurs. Setting a low rekey interval may affect performance negatively.

IEEE802.1x/EAP authentication (WPA) - Configure Authentication and WPA Settings.

Disable - Do not use any RADIUS Server based authentication.

Enable - Authorized clients access this AirStation via a RADIUS Server.

Use 802.1x/EAP to authorize every wireless client who wants to access the AirStation by using 802.1x/EAP and a RADIUS Server. The RADIUS server provides login information for every user establishing a more secure system than TKIP or other fixed encryption key methods. This also reduces the amount of necessary key maintenance.

A RADIUS server is necessary for IEEE802.1x/EAP authentication. Enter [RADIUS Server], {RADIUS Port] and [RADIUS Key] information.

RADIUS authentication

RADIUS Server - Enter RADIUS server IP address.

RADIUS Port - Enter port number for authentication.

RADIUS Key - Encryption key between RADIUS Sever and the AirStation. Enter the same key as registered in the server. Use a 1 to 256 character alphanumeric code.

LAN Port Settings

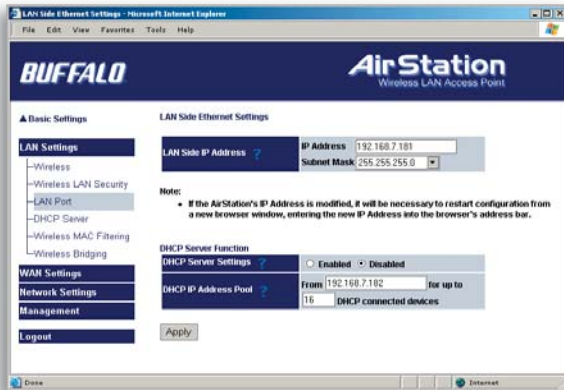

LAN Port

Set the LAN side Ethernet settings.

LAN Side IP Address - Allows administrator to specify a static IP and Subnet Mask for the LAN side of the AirStation.

■ Note: If the AirStation's IP address is changed, the configuring computer's IP must be changed to the same range to continue configuration. If the LAN IP is changed, restart the AirStation. (Section 4.4.10). If

the IP address is changed, then the DHCP scope must be changed to match.

DHCP Server Function - Allows administrator to enable/disable the DHCP server function for the AirStation LAN side. Select **Use** to enable and **Do not use** to disable the function. Once **Use** is selected, the assigned IP address range can be specified. Enter the starting LAN IP address and total number of computers the DHCP server can accommodate.

■ Note: If there is another DHCP server on the network, one either must be disabled or the IP range must be changed to avoid conflicts derived from overlapping DHCP scopes.

DHCP Server Settings

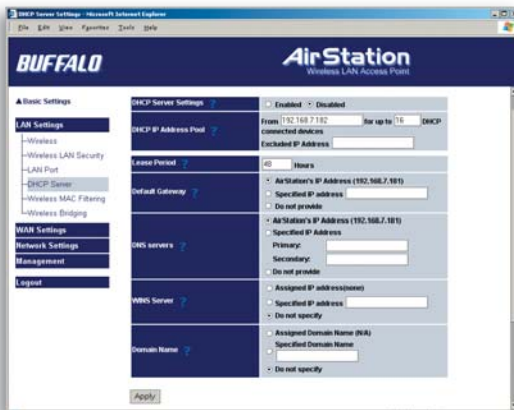

DHCP Server

Allows a more advanced configuration of the DHCP server functions.

DHCP Server Function - Allows administrator to enable/disable the DHCP server function for the AirStation LAN side. Select Use to enable or Do not use to disable this function. If the DHCP service is enabled, wireless and wired clients may receive IP addresses and other network information from the AirStation. If the DHCP

server is turned off, all client PC's must have unique, static IP addresses and valid network settings manually entered. Check with your LAN administrator for static IP information.

Assigned IP address (Range Assignment) - Sets the beginning address and range of addresses to be assigned by the AirStation's DHCP server function. Select up to 253 consecutive addresses (nodes). The IPs to be excluded from the range specification should be entered in the specified field.

Lease duration - Specifies the time in hours (1-999) an assigned IP address is valid. If the client computer does not request a renewal of IP address before the lease period expires, the AirStation can issue the IP to another client computer.

Default Gateway - Allows administrator to use the Default Gateway address (the AirStation's IP address), assign a specific Gateway address, or block clients from Gateway notification.

DNS server - Allows administrator to use the default DNS address (the AirStation's IP address), assign specific DNS addresses, or block clients from DNS address notification.

WINS server - Allows administrator to use a WINS address. Select auto assignment of the IP address, enter a specific WINS IP address, or block clients from the WINS address notification.

Domain name - Allows administrator to use an assigned domain name, assign a specific domain name, or block clients from domain name notification. Domain names will be sent to LAN computers when an IP address is assigned. Enter a maximum of 64 alphanumeric characters.

Manual IP and MAC Address Assignment Settings

The screenshot shows the Buffalo AirStation DHCP Server Settings page in a Microsoft Internet Explorer browser. The page title is "DHCP Server Settings - Manual Assignment of IP Addresses". The left sidebar contains a navigation menu with categories: Basic Settings, LAN Settings, WAN Settings, Network Settings, and Management. Under LAN Settings, the following options are listed: Wireless, Wireless LAN Security, LAN Port, DHCP Server (selected), Wireless MAC Filtering, and Wireless Bridging. Under WAN Settings, Network Settings and Management are listed. Under Management, Logout is listed. The main content area has "Apply" and "Cancel" buttons at the top. Below them is a note: "Note: Click Apply after editing settings. If Apply is not clicked, settings will not be saved when moving to another page." The "Manual Assignment" section has a question mark icon and two input fields: "IP Address" and "MAC Address", with an "Add" button below them. The "Current DHCP Client Information" section has a question mark icon and a table with columns: IP Address, MAC Address, Lease Period, Status, and Customize. The table contains one entry: IP Address: 192.168.11.1, MAC Address: 00:0B:CD:C7:1E:C2, Lease Period: 1 day, 23:59:52, Status: AUTO, and a "Manual Assignment" button. At the bottom of the table are "Set" and "Refresh" buttons.

Manual IP and MAC Address Assignment - Allows administrator to add additional leased IP addresses tied to a specific MAC address. When a specific MAC address connects to the AP, the IP address specified will be given to that client.

Display/Delete lease information - List of IP addresses, MAC addresses, lease periods and status is displayed.

Wireless MAC Filter

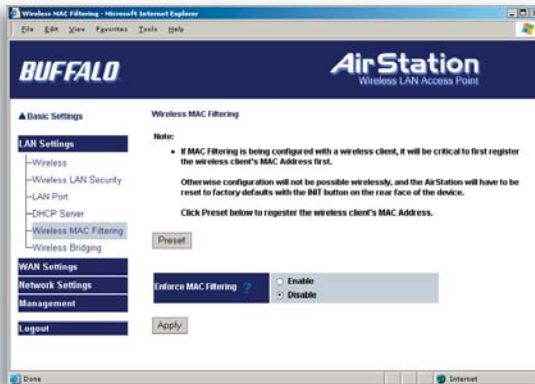

Wireless MAC Filter

Wireless PC's Connection

- Select **Enable** to restrict wireless connections to the registered adapters in the list. Select **Disable** to disable MAC address filtering.

Press the **Preset** button to enter the MAC Address registration menus. This is where MAC Addresses can be assigned and deleted.

Register for
Allowable PC's
MAC Address

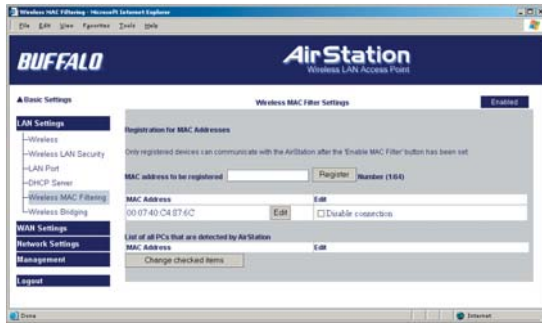

Registration for MAC Addresses - MAC access restriction set up in LAN. Input the MAC addresses that are allowed to communicate with the AirStation.

MAC address list - Displays a table list of all MAC addresses allowed to communicate with the AirStation.

Wireless Bridge (WDS) Settings

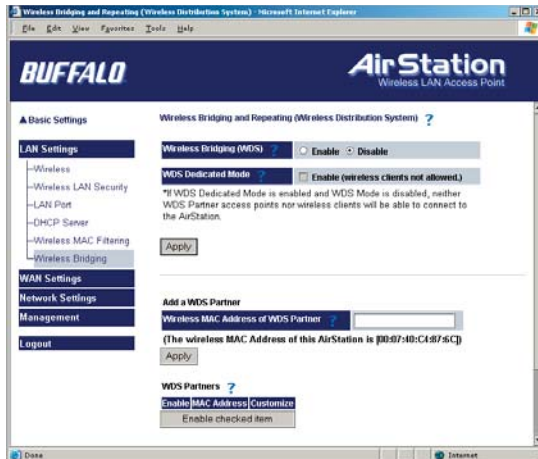

Wireless Bridge (WDS)

The Wireless Distribution System supports peer-to-peer AP communication.

Wireless Bridge (WDS) Function

Select **Enable** to allow Bridge (WDS) mode between AirStations or **Disable** to block communication between AirStations.

Wireless Bridge (WDS) dedicated mode

Select **Enable** to restrict wireless computer communication with the AirStation. In dedicated mode wireless clients CANNOT connect to WDS AirStations.

■ Note: All AirStations must support WDS and be on the same channel. Do not use 'Auto-Channel' when using WDS. For roaming support, use the same SSID on all devices.

Add a WDS Partner: Allows administrator to input the wireless MAC address of AirStations for Bridge (WDS) communication. The wireless MAC address is found in the Management section => System Information, labeled Wireless MAC Address.

Wireless Bridge (WDS) Settings

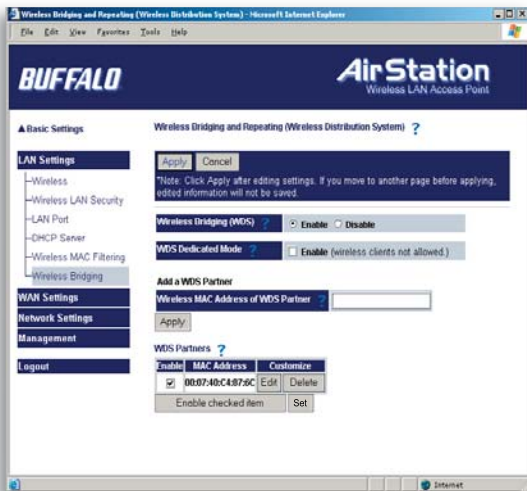

To enable WDS, set the Wireless Bridge (WDS) function to **Enable**.

Enter the Wireless MAC address of the AirStation to communicate with in the form of two characters separated by a colon and click **Add**.

MAC Address Ex:
00:00:00:00:00:00

Up to six AirStation MAC addresses may be registered.

Click **Apply** under Wireless Bridge (WDS) settings when the wireless Mac addresses AirStation are entered.

Repeat this process on every other AirStation used in Bridge (WDS) mode.

WAN port Setup

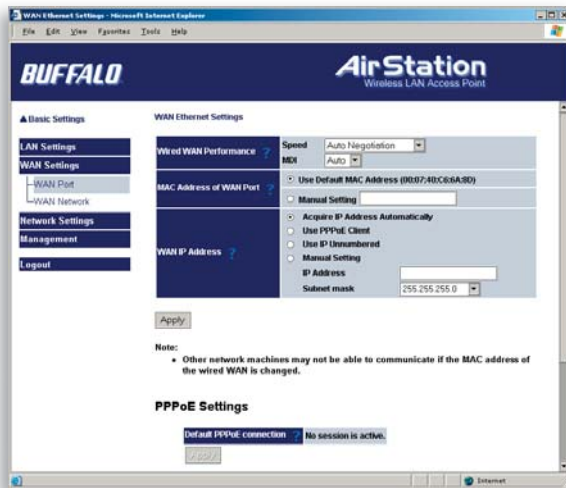

WAN Settings

WAN Port

Wired WAN Performance

- Select port speed and type of duplex connecting to the WAN port. If unknown, select Auto negotiation.

MAC Address of WAN - Set the AirStation MAC address to be used for WAN communication. Some ISP's may require you to set the MAC Address of WAN to be the same MAC address of your cable or DSL modem.

WAN IP Address - Allows administrator to select DHCP server, PPPoE, or manual setting for the WAN port of the AirStation.

Auto IP assignment from DHCP server - acquire the IP address automatically from the DHCP server.

Use PPPoE client - If selected, the information listed below must be entered.

Manual setting - Enter the appropriate IP address and subnet mask.

PPPoE Setting (for enabling PPPoE Client function) - Allows administrator to use PPPoE as specified by the ISP.

The following parameters should be entered for PPPoE Settings:

Name of Connection - Enter the name of your connection.

User Name - Enter the user name (up to 64 alphanumeric characters) for PPPoE authorization.

Password - Enter the password provided by your ISP (up to 64 alphanumeric characters). Reenter the password in the Confirmation box.

Service Name - Enter the PPPoE service name (up to 64 alphanumeric characters). If your ISP doesn't require a service name, then leave it blank.

Connection Type - Select from:

- Continuous Connection - connects immediately after setting and never disconnects.
- Connect on Demand - Reconnects when the disconnect time elapses.
- Manual - Disables Automatic Connection. Connects to the Internet using the connect button on the initial settings page.

The **Enter New Connection** button will not appear until Use **PPPoE Client** is set.

Disconnection Time - Specify the number of minutes (0-1440) before automatic disconnect is performed. If "0" is entered, the disconnect function is disabled. If **Continuous Connection** is selected, the timer is disabled.

PPPoE Settings Screen

Name of connection ?	No.1: <input type="text"/>
User name ?	<input type="text"/>
Password ?	<input type="password"/> <input type="password"/> (Confirmation)
Service name ?	<input type="text"/>
Connection type ?	Connection on demand ▾
Disconnection time ?	20 minutes <small>* If disconnection time is set to 0, the AirStation will maintain the connection indefinitely.</small>
Authorization ?	Auto authorization ▾
MTU Size ?	1454 bytes
MRU Size ?	1454 bytes
Keep Alive ?	<input type="radio"/> Enable <input type="radio"/> Disable
Activation ?	<input type="radio"/> Enable <input type="radio"/> Disable

Apply

Authorization - Authorization method for accessing the ISP's PPPoE server. If unknown, select Auto authorization.

MTU (Maximum Transmit Unit) Size - Maximum Transmit Unit (578-1492) when using PPPoE.

MRU (Maximum Receive Unit) Size - Maximum Receive Unit (578-1492) when using PPPoE.

Keep Alive - Enables the PPPoE client to send a Link Control Protocol (LCP) echo request to the PPPoE server

once per minute. If there is no reply within six minutes, the client disconnects. Set to **Disable** if frequent disconnection occurs.

Activation - Enable/disable registered connection settings. If disabled, the connection is not permitted.

Network of
WAN

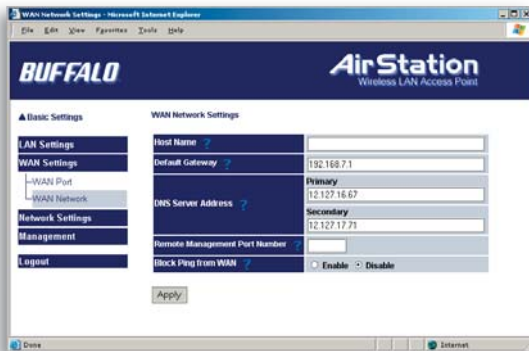

WAN Network

WAN side (Internet) parameters. These settings are generally not required if your ISP is providing DHCP services. In this case these fields can be left blank if desired.

Host Name - Enter the host name as desired.

Default Gateway - A default gateway IP should be assigned to the AirStation. If unknown, leave blank. If **Auto IP**

assignment from DHCP Server is selected in the **WAN Port** section, a gateway IP is assigned automatically, provided the DHCP server is set to provide one.

DNS Server Address - Enter the primary and secondary DNS address(es) of the server to be used by the AirStation for DNS resolution.

If DNS was set to **Do not use**, leave blank. If **Auto IP assignment from DHCP Server** was selected, DNS addresses are assigned automatically, provided the DHCP server is set to provide them.

Remote Management Port Number - Set a specific port number when remote setup of the AirStation is planned. Using port 80 allows the AirStation to be accessed from the internet by connecting to <http://xxx.xxx.xxx.xxx> (where xxx.xxx.xxx.xxx is your WAN IP address). You will need to configure the NAT (**Address Translation Settings**) to forward PORT 80 back to the AirStation.

Block Ping from WAN - Allows a PING test from the WAN/Internet. Select **Disable** or **Enable**.

Routing Setup

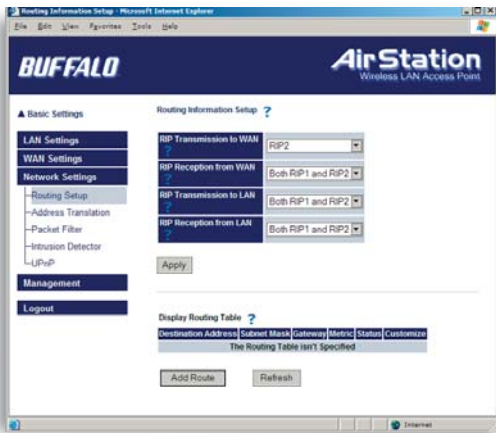

Network Settings Routing Setup

RIP transmission to WAN - Allows RIP transmission or None (no RIP) to WAN

RIP reception from WAN - Allows RIP reception or None (no RIP) from WAN

RIP transmission to LAN - Allows RIP transmission or None (no RIP) to LAN

RIP reception from LAN - Allows RIP reception or None (no RIP) from LAN

RIP transmission to WAN - Allows RIP transmission or None (no RIP) to WAN

Display current information - Allows administrator to view and delete routing information.

Click **Add Route** to Add a Routing Table Entry

- **Destination address** - Network IP address and subnet mask.
- **Gateway** - Address through which the packet passes before it reaches the destination address.

Add Routing
Table Entry

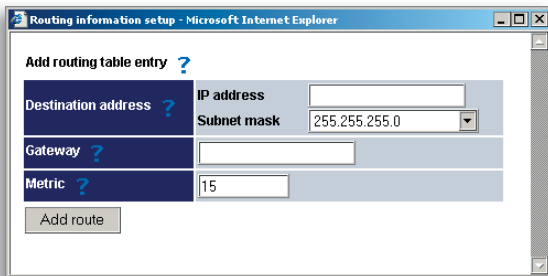

The screenshot shows a web browser window titled "Routing information setup - Microsoft Internet Explorer". The main content area is titled "Add routing table entry ?" and contains a form with the following fields:

Destination address ?	IP address	<input type="text"/>
	Subnet mask	255.255.255.0
Gateway ?	<input type="text"/>	
Metric ?	15	

At the bottom of the form is a button labeled "Add route".

- **Metric** - Number of routers (1-15) to be passed before the packet reaches its destination.

Address Translation Setup

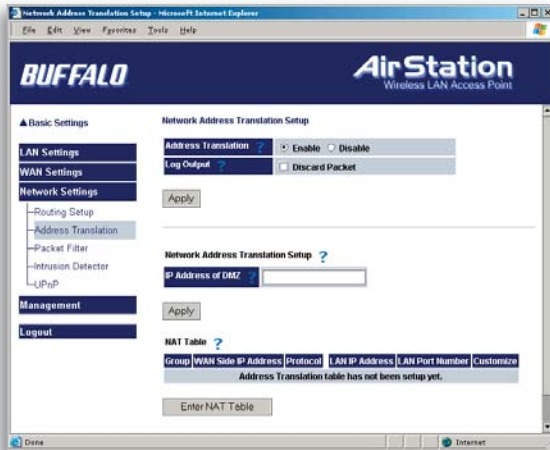

Address Translation

Address Translation - Select **Enable** or **Disable**. Address Translation must be enabled for client computers to connect to the Internet. Selecting **Enable** enables the following functions:

- **IP Masquerade** - When the LAN computer connects to the WAN side, the IP address of LAN computer is dynamically translated to become the WAN IP address of the AirStation. Multiple LAN computers can share one WAN IP address to access the Internet.

- **Static IP address translation** - When the WAN requests connection to the LAN, the WAN IP address of the AirStation is translated into the IP address of the LAN computer.

Log Output - Set 'Log Output' to log discarded packets. Otherwise, a dropped packet is not logged.

IPSec Pass-Through - Enables the AirStation's ability to pass IPSec VPN data.

IP Address of DMZ - Allows administrator to set the DMZ (De-Militarized Zone) address. Incoming packets containing no recognizable destination port information will be redirected to the DMZ's IP address.

Display/Delete NAT Table - Allows administrator to delete NAT tables.

Add NAT Table

Address
Translation
Setup

The screenshot shows a web-based configuration window titled "Network Address Translation Setup - Add NAT Table". The window contains several sections for configuring a NAT rule:

- Group:** A dropdown menu with "New Group" selected and a "Name:" input field.
- WAN Side IP Address:** A dropdown menu with "AirStation's WAN IP Address" selected and a "Manual IP Address:" input field.
- Protocol (WAN):** Radio buttons for "All", "ICMP", "Manual", and "TCP/UDP". "Manual" is selected.
- Protocol Number:** An input field.
- Port:** An input field.
- TCP Port Manual Setup:** A dropdown menu and a "Port Number:" input field.
- LAN IP Address:** A dropdown menu with "Manual IP Address" selected and a "Manual IP Address:" input field.
- Protocol (LAN):** A dropdown menu.
- TCP/UDP Port Forwarding:** An input field.

At the bottom of the window, there is an "Add to NAT Table" button and a "Close" button.

Group - Specify a group (up to 16 characters) that the NAT rule belongs to. Groups are simply used to visually organize the NAT table for the administrator. It is recommended to name the group after the protocol that is being setup (e.g. Group Name FTP when setting up address translation for FTP)

Click **New Group** to create new group or select an existing group to add a NAT rule to it.

WAN Side IP Address - Select **AirStation's WAN Side IP Address** or **Manual IP Address**. For Manual setting, enter the IP address

used by the WAN computer to connect to the local computer.

AirStation's IP Address of WAN should be used unless you have multiple WAN side IP addresses.

Some network applications (online games or streaming software) require adding Address Translation tables; consult the software's documentation for port information).

Protocol (WAN):

- **All** - Selects all IP protocols.
- **ICMP** - Network Diagnostic Protocol (1).
- **Manual** - Specify the protocol number (0-65535).
- **TCP/UDP** - Enter port number for TCP or UDP protocols. If both TCP and UDP are required, then separate entries are required.

LAN IP Address - Select **Manual IP Address** and enter the destination IP address of the LAN computer; or select **AirStation's LAN IP Address**.

Protocol (LAN) - Enter the destination port number. If left blank, the packets are transferred to the same port number as the source port number. Typically the destination port should be left the same as the source port.

- Click **Add to NAT table**. This will add the information to the NAT table. Once you have gone through this process for every desired translation, you will need to press the **Apply** button on the top of the screen to start the translating.

Packet Filter Setup

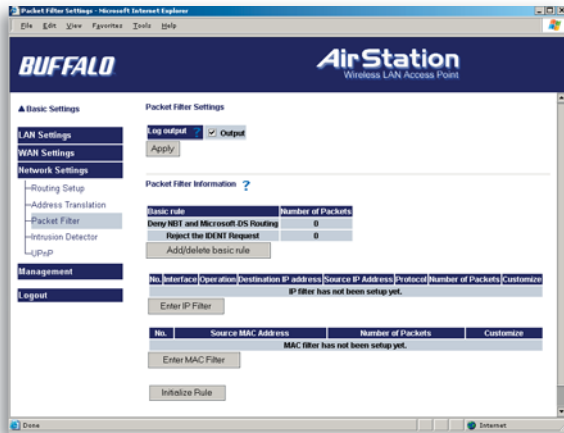

Packet Filter

Log Output - Select **Output** to activate the packet filter log.

Packet Filter Information

Basic Rule - Click add/delete basic rules. Place a check mark next to the basic rule to enable:

- **Prohibit setup from wireless LAN** - Prohibits administration from a wireless computer.
- **Prohibit setup from wired LAN** - Prohibits administration from a wired computer.

- **Prohibit setup via wireless bridge access point** - Prohibits a personal computer connected to another AirStation in a wireless bridge.
- **Prohibit NBT and Microsoft-DS routing** - Prevent unexpected external access via Microsoft network sharing. This prohibits computers on the internet from accessing shared resources on Windows machines. It is recommended to leave this filter activated.
- **Reject the IDENT request** - The AirStation sends reject packets if it receives an IDENT request.

Basic Filter Setting

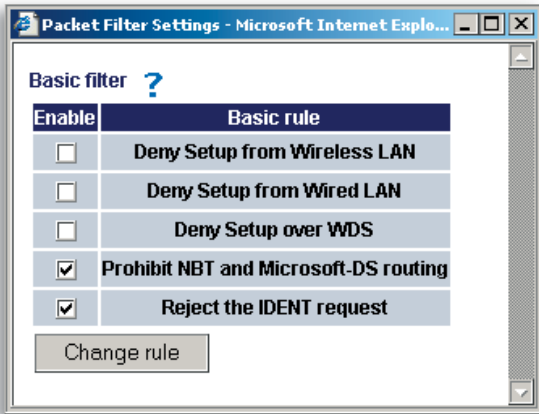

Use this filter when the communication speed goes down using a network application like E-mail, FTP and WEB.

* If IDENT requests are forwarded to a LAN side client by address translation setting (DMZ or TCP port :113), this basic rule is ignored.

IP Filter setting

Packet Filter Settings - Microsoft Internet Explorer

IP address filtering ?

Operation ? WAN (Internet) are Ignored

Destination IP address ?

Source IP Address ?

Protocol ?

All

ICMP

Manual Protocol number

TCP/UDP Destination port ?

TCP Port Manual Setting

Port Number:

Priority ? Insert at the bottom.

Add rule

IP Filter Settings - Limits the type of packets allowed to pass between the WAN and LAN. The maximum number of rules is 32.

• **Operation** - Packets from WAN (or LAN), select **ignored**, **rejected**, or **accepted**. Select the operation to be performed on the packets. Packets from:

- WAN side - packets coming from the WAN side will be filtered.
- LAN side - packets from the LAN side will be filtered.

Are :

- Ignored - Stop the packet and do not route it.
- Rejected - Return the rejected packet to the point of origin.
- Accepted - Pass the packet through.
- **Destination IP Address** - The IP address to be filtered.
- **Source IP Address** - The IP address designated for filtering. If all IP addresses must be filtered, leave this box blank.

Warning: If administrator selects packet from LAN is **Ignored** or **Rejected**, the administrator will

no longer have access to the AirStation configuration screens. This function prohibits setup from a wireless or wired computer. The AirStation can be returned to the factory default settings by holding down the INIT button on the back of the unit for five seconds or until the red DIAG light becomes solid.

Protocol - Mark and select a specific protocol. Select from **all** protocols, **ICMP**, arbitrary **protocol number** and **TCP/UDP** protocol number.

- **All** - Selects all IP protocols.
- **ICMP** - Network Diagnostic Protocol (1).
- **Manual** - Enter protocol number (0-65535).
- **TCP/UDP Destination Port** - Select TCP or UDP, then enter port number.

Priority - Specify the priority an item. The smaller the number, the higher the priority.

Add MAC
Filter
setting

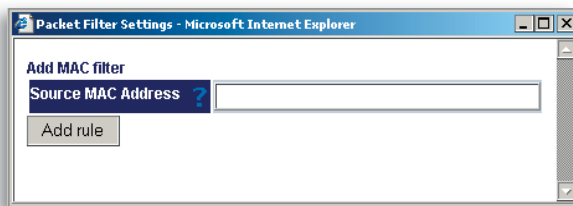

MAC Filter - Click Enter MAC filter to enter MAC address.

Source MAC address -The MAC address of the source of the packets that will be filtered may be set. Click Add rule when complete.

■ Note: If configuring from a wireless computer, add your MAC address to the list of authorized wireless LAN PCs. The MAC address must be in two-digit groups separated by colons.

Example: 00:40:26:00:11:22

Click **Apply** when settings are complete.

Intrusion Detector Setup

Intrusion Detector

The Intrusion Detector watch guards and prevents unauthorized access from the WAN (Internet)

This function also records information on unauthorized access attempts

Intrusion Detector - Select **Do not use**, **Use** or **Use (Apply Packet filter setting for Intrusion Detector setting)**.

IP Spoofing - Check **Block** to prevent IP spoofing.

Threshold Value - Enter the number (1-999) of suspect packets before the notification occurs.

Notify by email

- **Notification email address** - Enter destination email address
- **Sender email address** - Enter the email address that will send the email. This is the name that will appear as the sender when the email is read. This email can be made up (e.g. DETECTOR@AIRSTATION)

- **Sender email server address** - Enter the SMTP Server address.
 - **Receiving email server authorization** - Enter the POP3 Server address, User name and Password. This is only required if your SMTP server requires POP verification before it allows email to be sent. Consult your ISP or mail server support for more information.
 - **Send test** - Click **Send** to test notification; this will also save and commit the entries.
- Pop-up notification** - Pop-up window alert of unwanted activity. Client Manager must be installed and running on a client machine to use this feature.
- **Destination IP address** - Enter the IP address to be notified. The LAN computer with this IP address must have Buffalo's Client Manager software installed and running for the verification to occur. If the machine is off the verification will not be received, and the AirStation will NOT resend information.
- Intrusion Detector information** - displays log activity detected by the Intrusion Detector service.

UPnP
Setting

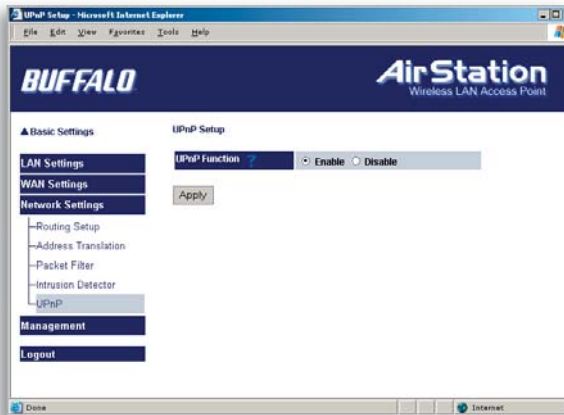

UPnP

Select **Enable** to enable UPnP (Universal Plug and Play). When a computer with UPnP support connects to the AirStation, that computer automatically receives configuration information from the AirStation.

System Information

The screenshot shows the Buffalo AirStation Web Management System interface. The main content area is titled "System Information" and displays the following details:

Model	WHRC-G54 Ver.2.45
Air Station Name	AP000008279C80
DHCP Server	Disabled
MAC Address	00:07:40:F183:52
Wireless Driver	WLANPCI-G54 Ver.3.80.9.0
Wireless Mode	Mixed
SSID	00000279C80
Wireless Channel	7 (Auto-Channel Selection)
Frame Bursting	Enabled (AfterBurner)
Encryption Mode	AES
Privacy Separator	Disabled
SSID Broadcast	Disabled
MAC Filtering	Disabled
WDS Bridge	Disabled
Output Power	100%
LAN Settings	MAC Address: 00:0D:0B:27:9C:80 IP Address: 192.168.7.81 Subnet Mask: 255.255.255.0
WAN Settings	DHCP Client: (off)
Default Gateway	MAC Address: 00:0D:0B:27:9C:81

At the bottom of the System Information section, there are buttons for "Release" and "Renew" next to the "WAN Side IP Address Automatic Assignment" label, and a "Refresh" button below.

125 Mbps AfterBurner is running. When it is grey, 125 Mbps AfterBurner is enabled but not running due to a client being connected at 54 Mbps or another access point is running on the same channel.

- **LAN** - Displays the AirStation LAN settings
- **WAN** - Displays the AirStation WAN settings
- **Default Gateway** - Displays the default gateway settings

Management - System Information

System information of the AirStation is obtained here.

- **Model name** - Displays model and firmware version
- **AirStation Name** - Displays AirStation host name
- **DHCP Server function** - Displays On or Off
- **Wireless** - Displays the wireless LAN settings such as wireless MAC address and wireless firmware. The wireless MAC address is required for setting up WDS with other access points. This is the best place to determine the wireless MAC address. If 125 Mbps AfterBurner mode is enabled, then the [AfterBurner] color will be read or grey. When it is red,

- **WAN side IP address auto acquisition** - This is the method to acquire the IP address from the WAN (Internet) side DHCP server. Press Release to release current DHCP WAN information. Press Renew to obtain WAN information from the DHCP server. **NOTE:** If a manual IP is assigned to the WAN port, this feature is not displayed.

Name and
Password
Setup

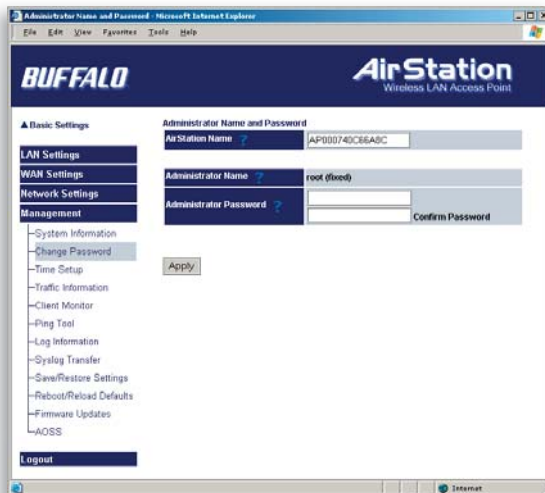

Admin Name and Password

AirStation name - When using multiple AirStations, select a unique name to make it easier to identify each AirStation through the AirStation Manager utility. This utility is seldomly used, thus, the AirStation name value has little value.

Administrator name - "root", cannot be changed

Administrator password - Allows the administrator to enter an administrator password to restrict access to the setting screens.

- **New Password** - Enter new password. Enter up to eight alphanumeric characters (case sensitive)
- **Confirm Password** - Reenter the new password for confirmation

Time Setup
Screen

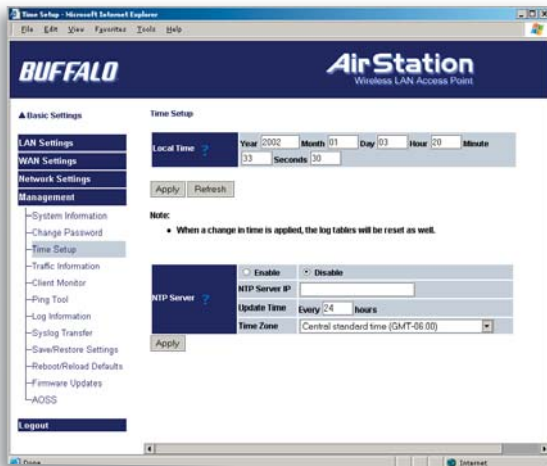

Time setup

Time setup - Enter the current date and time, and click **Set**.

NTP - Network Time Protocol. Select **Use** or **Do not use**.

■ **Note:** If NTP is used, time is set automatically.

NTP server name - Enter the NTP server name

Update Time - Enter the time interval (in hours) for the time check frequency

Time Zone - Select local time zone

Click **Apply**.

Packet Traffic Information

The screenshot shows the Buffalo AirStation configuration interface in a Microsoft Internet Explorer browser. The page title is "Packet Traffic Information - Microsoft Internet Explorer". The interface includes a navigation menu on the left with options like "Basic Settings", "LAN Settings", "WAN Settings", "Network Settings", and "Management". The "Management" section is expanded, showing "Traffic Information" as the selected option. The main content area displays "Packet Traffic Information" with a table showing statistics for three interfaces: Wired WAN, Wired LAN, and Wireless LAN. Each interface has rows for "Sent" and "Received" traffic, with sub-rows for "Packets" and "Error Packets". A "Refresh" button is located below the table.

Interface	Direction	Metric	Value
Wired WAN	Sent	Packets	32
		Error Packets	0
	Received	Packets	0
		Error Packets	0
Wired LAN	Sent	Packets	5126
		Error Packets	0
	Received	Packets	0
		Error Packets	0
Wireless LAN	Sent	Packets	0
		Error Packets	0
	Received	Packets	152
		Error Packets	0

Packet Traffic Information

Displays number of packets sent and received for:

Wired WAN

Wired LAN

Wireless LAN

Click **Refresh** to start update the transfer packet log.

Client Monitor Screen

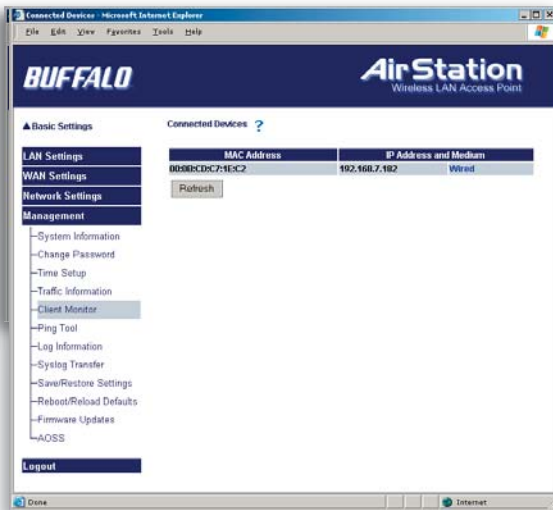

Client Monitor

Displays the wired and wireless clients (computers) that are accessing the AirStation.

- **MAC address** - Shows the client's MAC address.
- **IP Address and Medium** - Shows the IP address that is assigned to the client from the DHCP server.

The network medium is indicated as wireless or wired depending on how the client is accessing the AirStation.

■ **Note:** The Client Monitor only shows clients that have received an IP address from the AirStation's DHCP server. Clients that have static IP addresses will not appear in the Client Monitor.

PING Test

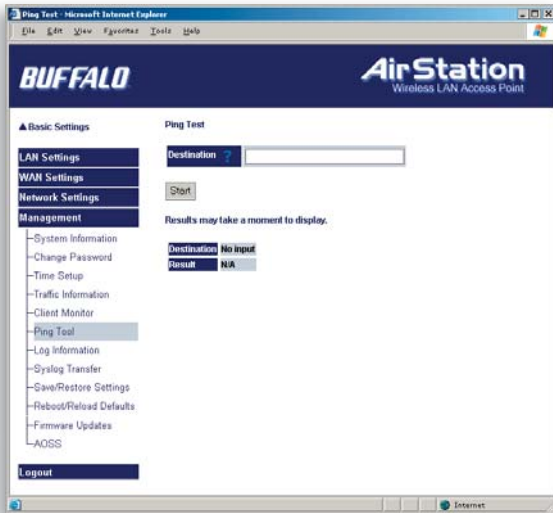

PING Test

Performs a PING test from the AirStation to a LAN or WAN address.

Enter the target IP address and click **OK** (e.g. **192.168.11.2** - OR- **www.buffalotech.com**)

If the test results in an error, then verify you correctly inputted the address and check your connections.

Log
Information
Screen

Log Information

Display log info level Error Notice

Address Translation Packet Filter

Firewall PPPoE Client

DHCP Client DHCP server

Wireless client Setting change

System boot NTP client

Wired link Intrusion Detector

Others

Log information ? Save in local log file. OLD <<< < > >>> NEW Delete

Time	Type	Log information
2002/01/03 20:35:51	DHCP	Received SIGTERM
2002/01/03 20:35:49	CONFIGURE	DHCP Server
2002/01/03 20:35:27	DHCP	sending ACK to 192.168.7.182
2002/01/03 20:35:27	DHCP	sending OFFER of 192.168.7.182
2002/01/03 20:35:24	DHCP	sending OFFER of 192.168.7.182
2002/01/03 20:34:55	DHCP	Moreton Bay DHCP Server (v0.9.5) started
2002/01/03 20:34:47	CONFIGURE	DHCP Server
2002/01/03 20:32:36	CONFIGURE	WIRELESS (RADIO OFF)
2002/01/03 20:24:32	CONFIGURE	WAN Ether

Log Information

Display log info level - Select **Error** and/or **Notify** to specify the types of reports to be logged by the AirStation.

Display log info - Select the specific reports to be logged.

Log information - Displays recorded logs.

Syslog
Transmitting
Screen



Syslog Transfer

Select **Use** or **Do not use** to enable or disable the AirStation's ability to transmit information to a Syslog server.

- **Syslog Server** - Enter the IP address of the Syslog server.
- **Log Information Level** - Select **Error** and/or **Notice** to specify the types of reports to be sent to the Syslog server.
- **Log Information** - Select the specific reports to be sent to the Syslog server.

■ **Note:** A server on the network running a Syslog service is required for this.

Save/
Restore
Settings
Screen

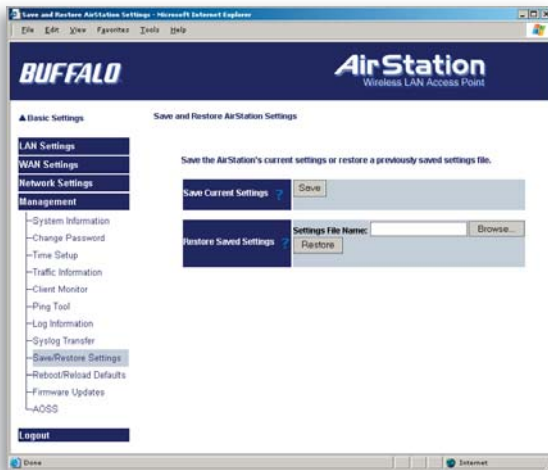

Save/Restore Settings

Save current settings - Click **Save** to open the file saving dialog and save the current AirStation settings to a file.

Restored saved settings - Restores settings from a file that has been saved. Click **Choose file** to select the saved file and click **Restore**.

■ **Note:** If the setting file is saved by a newer firmware than the current one, the AirStation can't restore the settings.

Initialization/
Reboot

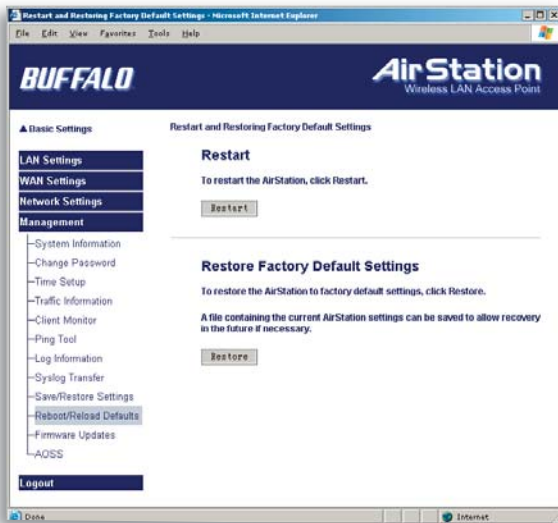

Reboot/Reload Defaults

Click Restart to reboot
AirStation

Click Restore to reset the
AirStation to default factory
settings.

■ Note: Resetting to default
factory settings will erase
all settings and passwords
previously entered. The
AirStation will return to the
condition it was in when first
purchased.

Firmware Update

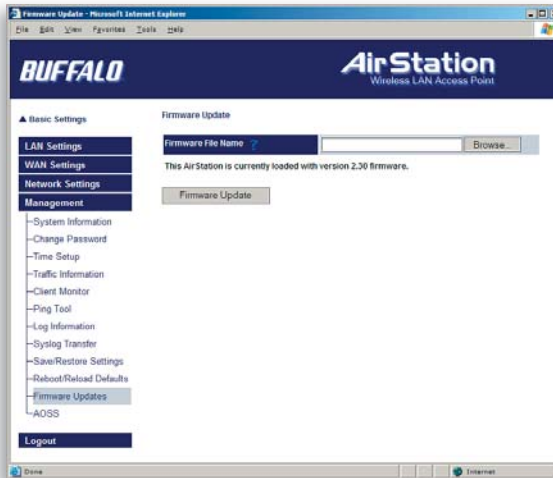

Firmware Update

Firmware file name

- Click Browse to browse to the path and filename for the new firmware. Click Firmware Update to load firmware to the AirStation.

■ Note: Firmware update does not erase current user settings.

Please visit the Buffalo Technology Web Page to download the latest firmwares free of charge.

<http://www.buffalotech.com/wireless>

AOSS

Connected Hardware

Connected Hardware Type	MAC Address	Encryption Types Available	Status	Disconnect/Re-Enable Adapter
WLI-CB-G54	00:07:42:78:58:55	WEP/AWEP128TKIP		Disconnect

Ethernet Converters connected via AOSS

Connected Hardware Type	MAC Address	Encryption Types Available
BUFFALO WLI-T10-G54 (Ethernet Converter)	00:07:40:A2:1B:96	WEP/AWEP128

Current Encryption Information

Current encryption type and security information is as follows:

Encryption Type	WEP128
SSID - (SSID)	7902941B79E2072102A0A542FA1B0A0
Encryption Key	70C7068600B4E25C0E7636A45D 1807220BCC096299C0C60F FC8 809E0E1E8644C0C83E3C429C41F FE415340A777319F309E60ND1

AOSS

Client Table - Displays the clients connected via AOSS. The 'Disconnect' button disconnects the client from the AOSS router by using MAC Address filtering. Once disconnected, the client will still appear in the client list but will appear as disconnected. The client can then be re-enabled by pressing the 'Re-Enable' button. A separate table exists for connected Ethernet Converters. The 'Refresh' button updates the tables.

AOSS



Manually specify the encryption type - This forces AOSS to use a specified type of encryption. It is recommended to not change this setting. If the setting is changed then every client that connects must have support for that encryption type.

AOSS Function - Click Enable to allow the AirStation to use AOSS function. Click Disable to shut off the AOSS system. Clicking Disable will disable the AOSS button on the AirStation.

Start AOSS Process- Click AOSS icon to begin the AOSS sequence. This starts the AOSS process just like pressing the AOSS button.

Stop AOSS Process- Click AOSS icon to stop AOSS operation. Stopping the AOSS function will turn off AOSS and return the router to non-AOSS function.

Additional Information

For more information, please consult:

- The AirStation website at:

<http://www.buffalotech.com> - for frequently asked questions (FAQ's) and Software Updates.

WHR3-G54 BASE STATION SPECIFICATIONS

Physical Specifications

Dimensions W3 x H6.75 x D6.1in. (76 x 171 x 155mm)

Weight 1 lb. (620g)

Temperature & Humidity

Operation 0° to 40° C

Maximum humidity 80%

Transit/Storage 0° to 40° C maximum humidity 80% (no condensation)

Power Characteristics

Transmit Mode 1.1A (Nominal),

Power Supply 3.3 V

Regulatory Information

Wireless communication is often subject to local radio regulations. Although AirStation wireless networking products have been designed for operation in the license-free 2.4 GHz band, local radio regulations may impose limitations on the use of wireless communication equipment.

Networking Characteristics

Compatibility

- IEEE802.11g/b Standard for Wireless LANs (125 High Speed Mode also Available)
- Wi-Fi (Wireless Fidelity) certified by the Wi-Fi Alliance.

Host Operating System

Microsoft Windows® 98SE/ME/NT4.0/2000/XP, Unix, Linux and MacOS

Media Access Protocol

Wired - CSMD/CD (Collision Detection)

Wireless - CSMD/CA (Collision Avoidance) with Acknowledgment (ACK)

Radio Characteristics

RF Frequency Band 2.4 GHz (2400-2483 MHz)

11 selectable channels (3 non-overlapping)

Modulation Technique Direct Sequence Spread Spectrum

- OFDM for High Transmit Rate
- DQPSK for Standard Transmit Rate
- DBPSK for Low Transmit Rate

Spreading 11-chip Barker Sequence

Nominal Output Power 13.5 dBm

Transmit Rate / Range

High Speed 54 Mbps (125 Mbps in 125 High Speed Mode)

Medium Speed 36 Mbps (96 Mbps in 125 High Speed Mode)

Standard Speed 2 Mbps

Low Speed 1 Mbps

Open Office Environment

160 m (525 ft.)

270 m (885 ft.)

400 m (1300 ft.)

550 m (1750 ft.)

Semi-Open Office Environment

50 m (165 ft.)

70 m (230 ft.)

90 m (300 ft.)

115 m (375 ft.)

Closed Office

25 m (80 ft.)

35 m (115 ft.)

40 m (130 ft.)

50 m (165 ft.)

Receiver Sensitivity -83 dBm -87 dBm -91 dBm -94 dBm (depends on data rate)

Delay Spread (at FER of <1%) 65 ns 225 ns 400 ns 500 ns (depends on data rate)

- The range of wireless devices can be affected by metal surfaces, solid high-density materials and obstacles in the signal path.

Table “Radio Characteristics” lists the typical ranges when used indoors:

- In Open Office environments, clients can “see” each other, i.e. there are no physical obstructions between them.
- In Semi-open Office environments, work space is separated by room dividers; client cards are at desktop level.
- In Closed Office environments, workspace is separated by floor-to-ceiling brick walls.

■ **Note:** The range values listed in Table “Radio Characteristics” are typical distances as measured at Buffalo Technology AirStation laboratories. These values are provided for your guidance but may vary according to the actual radio conditions at the location where the AirStation product is installed.

AirStation IEEE 802.11 Channel Sets

The range of the wireless signal is related to the Transmit Rate of the wireless communication. Communications at a lower Transmit range may travel longer distances.

Center Channel ID FCC

1 2412 2 2417 3 2422 4 2427 5 2432 6 2437 7 2442 8 2447 9 2452 10 2457 11 2462
11 default channel

Common Problems:

- Out of range, client cannot connect to the AirStation.
- Configuration mismatch, client cannot connect to the AirStation.
- Absence or conflict with the Client Driver.
- Conflict of another device with the AirStation hardware.

B.1.1 LED Activity B

Monitoring LED activity helps identify problems.

- Power LED should be GREEN,
- Wireless LED should be GREEN if the line is active. If it is blinking GREEN, wireless communication is active.
- Ethernet LED should be GREEN (100Mbps) or AMBER (10Mbps) while the communication is active.

DIAG LED Activity

Unplug the power for three seconds. Plug the power back in to monitor the DIAG LEDs during start-up.

If any symptoms match section B.1.1, call the Buffalo Tech Support line 24 hours a day, 7 days a week at **866-752-6210** or email **info@buffalotech.com**.

Table B.1.1 DIAG LED Activity Table

DIAG LED Display	Time	Description/Action
Continuous Red	Starting	RAM Error Red flash, 2 times Starting Flash ROM Error
Red flash, 3 times	Starting	A problem on the wired LAN side
Red flash, 4 times	Starting	A problem on the wireless LAN side

B. 1.2 LEDs Work But Client PC Cannot Connect to Network

If the LEDs indicate that the network is working properly (Power LED is on, Transmit/Receive LED blinks), check the TCP/IP settings of the network.

Changing Client TCP/IP Settings in Windows

Consult the LAN Administrator for TCP/IP settings.

To add or change the TCP/IP Settings:

1. On the Windows task bar click Start.
2. Select Settings, then Control Panel.
3. Double-click on the Network icon to view the Network Properties.
4. From the list of installed components, verify the TCP/IP => wireless LAN adapter protocol is installed.

- If the wireless adapter protocol is not yet installed, click the Add button and select the TCP/IP protocol from the list. Refer to Windows Help for more information.
 - If the wireless adapter protocol is installed, select the protocol and click the Properties button. Verify the parameters match the settings provided by your LAN Administrator. Make changes if necessary, and click OK.
5. When or if prompted, restart your computer.

B. 1.3 Other Problems

Please refer to www.buffalotech.com for further reference materials.

Troubleshooting WDS (Step-by-Step Instructions)

The most common issue with WDS installations is using the wrong MAC address. The proper MAC Address for the access points is the 'Wireless MAC Address'. The best place to document this is under the 'System Information' section of the configuration web page. For proper setup, please continue reading this document.

Problem:

Communication problems with WDS (wireless bridging/repeating).

Cause:

WDS is a very complex bridging system, and it is not part of the 802.11b or 802.11g standard.

Restrictions:

Please verify that the following conditions are met (if just one condition is not satisfied, then WDS cannot be used on the wireless network):

1. All wireless access points in the wireless bridge need to be from the same vendor (e.g. all Buffalo access points).

(At time of publication, the Apple Airport Extreme WILL work in WDS with Buffalo G54 access points.)

2. No single access point can communicate with more than six other access points in the wireless bridge. Good Practices: proper location.

The following is a list of good practices with WDS:

1. Start the wireless bridge system with only two access points and then add more access points.
2. Setup all access points in the wireless bridge in close proximity before they are deployed to their proper location.
3. Only one access point in the wireless bridge should be serving DHCP and routing services unless a routed wired network exists.

Proper Setup:

Please follow the following steps to properly setup WDS.

1. It is recommended that all access points in the bridge are reset to their factory default settings. This is done by holding the INIT button on the rear of the access point down for 5-10 seconds.
2. Login to the first access point in the wireless bridge (this should be the DHCP server enabled access point if there is not already a routed wired network).
3. Click on the 'Advanced' button.
4. The wireless settings page will appear. Select the proper settings for the wireless network. Record all settings on a piece of paper. All settings except for the SSID need to be identical amongst all access points in the bridge.

(If roaming is desired, then make sure the SSID settings need to be identical as well). Press the 'Set' button if any changes are made.

(If the IP address was changed, then reconnecting to the access point for configuration will require accessing it via its new IP address in a web browser (e.g. http://NEW_IP_ADDRESS).

5. Click on the 'LAN port' link on the left.
6. Check that the 'LAN side IP address' values are correct for your network, or leave them as default. Record the 'LAN side IP address'. Press the 'Set' button if any settings on this page have been set.
7. Click on the 'Management' link on the left.
8. The System Information page will appear. In the Wireless section of the table record the MAC address (including the :'s). Please make sure the MAC address is recorded from the Wireless section and not the other sections.
9. Logout of the access point by clicking on the 'Logout' link on the left. Close the browser window.
10. Login to the second access point in the wireless bridge.
11. Click on the 'Advanced' button.
12. The wireless settings page will appear. Select the proper settings for the wireless network. Refer to the settings recorded from the first access point. All settings except for the SSID need to be identical amongst all access points in the bridge.
(If roaming is desired, then make sure the SSID settings need to be identical as well).
13. Click on the 'LAN port' link on the left.
14. Make sure that the 'LAN side IP address' 'IP address' setting is different then the first access point. The IP addresses cannot be the same, but they should be on the same network. It is recommended that the IP address of the second access point is one higher then that of the first access point. Thus, if access point one's address is 1.1.1.1, then access point two's address should be 1.1.1.2. If there is a 'DHCP server function' setting on this page, then make sure to set it to 'Do not use' or to 'Disabled'. Press the 'Set' button when finished.

15. Click on the 'Wireless bridge (WDS)' link on the left.
16. Enable the WDS function and press the 'Set' button.
17. Enter the Wireless MAC Address of the first access point (which was recorded on Step 8) into the field that say 'MAC Address of AirStation(Wireless)' (include the :'s). Press the 'Add' button.
18. The Wireless MAC address inputted on the step above will appear in the 'Connected AirStation' table. Please check that the checkbox under enable is checked, and then press the 'Enable marked item' button.
19. At the top of the page, press the 'Apply' button.
20. Once the router has rebooted, click on the 'Management' tab on the left.
21. The System Information page will appear. In the Wireless section of the table record the MAC address (including the :'s). Please make sure the MAC address is recorded from the Wireless section and not the other sections.
22. Logout of the access point by clicking on the 'Logout' link on the left. Close the browser window.
23. Login to access point one again.
24. Click on the 'Advanced' button.
25. Click on the 'Wireless bridge (WDS)' link on the left.
26. Enable the WDS function and press the 'Set' button.
27. Enter the Wireless MAC Address of the first access point (which was recorded on Step 21) into the field that say 'MAC Address of AirStation(Wireless)' (include the :'s). Press the 'Add' button.

29. At the top of the page, press the 'Apply' button.
30. Once the router has rebooted, click on the 'Management' tab on the left.
31. Click on the 'PING test' link on the left.
32. In the 'Destination' field enter the IP address of the second access point and press the 'OK' button.
 - a. If the 'Result' section of the table reports information like, "1st: 64 bytes from IP_ADDRESS" then the WDS bridge is effectively working.
 - b. If the 'Result' section of the table reports "Destination Host Unreachable", then an error has occurred during the setup.

WDS is a complicated bridging system with a lot of variables. If there are still problems with WDS configuration on the network, then please call our 24/7 technical support line at **1-866-752-6210**.

10BaseT or 100BaseTx: 802.3 based Ethernet network that uses UTP (Unshielded twisted pair) cable and a star topology. 10 is 10 Mbps and 100 is 100 Mbps.

802.1x: The standard for wireless LAN authentication used between an AP and a client. 802.1x with EAP will initiate key handling.

Ad-Hoc Network: The wireless network based on a peer-to-peer communications session. Also referred to as AdHoc.

Bandwidth: The transmission capacity of a computer or a communication channel, stated in Megabits per second (Mbps).

BSS (Basic Service Set): An 802.11 networking framework that includes an Access Point.

Bus Mastering: A system in which the specified Input/Output device (e.g. NIC Card) can perform tasks without the intervention of the CPU.

Client: A PC or workstation on a network.

Cross-Over Wiring: A UTP cable that has its transmit and receive pair crossed to allow communications between two devices.

DCE (Data Communications Equipment): Hardware used for communication with a Data Terminal Equipment (DTE) device.

Default Gateway: The IP Address of either the nearest router or server for the LAN.

Default Parameter: Parameter set by the manufacturer.

Destination Address: The address portion of a packet that identifies the intended recipient station.

DHCP (Dynamic Host Configuration Protocol): Based on BOOTP, it uses a pool of IP addresses, which it assigns to each device connected to it, and retrieves the address when the device becomes dormant for a period of time.

DNS (Domain Name System): System used to map readable machine names into IP addresses

Driver: Software that interfaces a computer with a specific hardware device.

DSSS (Direct Sequence Spread Spectrum): Method of spreading a wireless signal into wide frequency bandwidth.

DTE (Data Terminal Equipment): Device that con10BaseT or 100BaseTx: 802.3 based Ethernet network that uses UTP (Unshielded twisted pair) cable and a star topology. 10 is 10 Mbps and 100 is 100 Mbps.

Dynamic IP Address: An IP address that is automatically assigned to a client station in a TCP/IP network, typically by a DHCP server.

ESS (Extended Service Set): A set of two or more BSSs that form a single sub-network. SSID is user identification used in the ESS LAN configuration.

Ethernet: The most widely used architecture for Local Area Networks (LANs). It is a shared-media network architecture. The IEEE 802.3 standard details its functionality.

Ethernet cable: A wire similar to telephone cable that carries signals between Ethernet devices.

File and Print Sharing: A Microsoft application that allows computers on a network to share files and printers.

Firmware: Programming inserted into programmable read-only memory, thus becoming a permanent part of a computing device.

Frame: A fixed block of data, transmitted as a single entity. Also referred to as packet.

Full-Duplex: To transmit on the same channel in both directions simultaneously.

Half-duplex: To transmit on the same channel in both directions, one direction at a time.

Hub: A device which allows connection of computers and other devices to form a LAN.

IEEE (Institute of Electrical and Electronics Engineers): The professional organization which promotes development of electronics technology.

IP (Internet Protocol) Address: A unique 32-bit binary-digit number that identifies each sender or receiver of information sent in packets.

Infrastructure: A wireless network or other small network in which the wireless network devices are made a part of the network through the Access Point.

ISP (Internet Service Provider): A company that provides access to the Internet and other related services.

IV (Initialization Vector): The header section of an encrypted message packet.

LAN (Local Area Network): A group of computers and peripheral devices connected to share resources.

LED (Light Emitting Diode): The lights on a hardware device representing the activity through the ports.

MAC (Medium Access Control) Address: A unique number that distinguishes network cards.

Mbps (Mega Bits Per Second): A measurement of millions of bits per second.

MDI/X (Media Dependent Interface/Crossover): Port on a network hub or switch that crosses the incoming transmit lines with the outgoing receive lines.

MHz (MegaHertz): One million cycles per second.

NAT (Network Address Translation): An internet standard that enables a LAN to use one set of IP addresses for internal traffic and a second set for external traffic.

NIC (Network Interface Card): An expansion card connected to a computer so the computer can be connected to a network.

Packet: A block of data that is transferred as a single unit, also called a frame or a block.

Packet Filtering: Discarding unwanted network traffic based on its originating address or its type.

PCI (Peripheral Component Interconnect): A bus that is connected directly to the CPU.

PCMCIA (Personal Computer Memory Card International Association) Card: Removable module that adds features to a portable computer.

Ping (Packet Internet Groper): An Internet utility used to determine whether a particular IP address is online.

Plug and Play: Hardware that, once installed (“plugged in”), can immediately be used (“played”), as opposed to hardware that requires manual configuration.

PoE (Power over Ethernet): A mechanism to send DC power to a device using a CAT5 Ethernet cable.

PPPoE (Point-to-Point Protocol over Ethernet): A specification for connecting users on an Ethernet line to the Internet through a common broadband medium.

Protocol: A standard way of exchanging infor-

mation between computers.

RADIUS (Remote Authentication Dial In User Service): A server that issues authentication key to clients.

RAM (Random Access Memory): Non-permanent memory.

Repeater Hub: A device that collects, strengthens and transmits information to all connected devices, allowing the network to be extended to accommodate additional workstations.

RC4: The encryption algorithm that is used in WEP.

RJ-45 connector: An 8-pin connector used between a twisted pair cable and a data transmission device.

ROM (Read Only Memory): Permanent memory.

Router: Device that can connect individual LANs and remote sites to a server.

Roaming: The ability to use a wireless device while moving from one access point to another without losing the connection.

Script: A macro or batch file containing instructions and used by a computer to perform a task.

Server: Any computer that makes files or peripheral devices available to users of the network and has a resident Network OS.

SMTP (Simple Mail Transfer Protocol): The protocol used to define and deliver electronic mail (E-mail) from one location to another.

SNMP (Simple Network Management Protocol): An application layer protocol that outlines the formal structure for communication among network devices.

Static IP Address: A permanent IP address is assigned to a node in a TCP/IP network. Also known as global IP.

STP (Shielded Twisted Pair): Twisted Pair cable wrapped in a metal sheath to provide extra protection from external interfering signals.

Subnet Mask: An eight-byte address divided into 4 parts separated by periods.

TCP/IP (Transmission Control Protocol/Internet Protocol): Protocol used by computers when communicating across the Internet or Intranet.

TKIP (Temporal Key Integrity Protocol): An encryption method replacing WEP. TKIP uses random IV and frequent key exchanges.

Topology: The shape of a LAN (Local Area Network) or other communications system.

Twisted Pair: Cable that comprises 2 or more pair of insulated wires twisted together.

UDP (User Datagram Protocol): A communication method (protocol) that offers a limited amount of service when messages are exchanged between computers in a network. UDP is used as an alternative to TCP/IP.

Uplink: Link to the next level up in a communication hierarchy.

UTP (Unshielded Twisted Pair) cable: Two or more unshielded wires twisted together to form a cable.

WAN (Wide Area Network): A networking system covering a wide geographical area.

WEP (Wired Equivalent Privacy): An encryption method based on 64 or 128-bit algorithm.

Web Browser: A software program that allows viewing of web pages.

Wi-Fi (Wireless Fidelity): An organization that tests and assures interoperability among WLAN devices.

Wire Speed: The maximum speed at which a given packet can be transferred using Ethernet and Fast Ethernet standard specifications.

WLAN (Wireless LAN): A LAN topology using wireless devices.

VPN (Virtual Private Network): A security method to connect remote LAN users to a corporate LAN system.

Federal Communication Commission Interference Statement

This equipment has been tested and found to comply with the limits for a Class B digital device, pursuant to Part 15 of the FCC Rules. These limits are designed to provide reasonable protection against harmful interference in a residential installation. This equipment generates, uses and can radiate radio frequency energy and, if not installed and used in accordance with the instructions, may cause harmful interference to radio communications. However, there is no guarantee that interference will not occur in a particular installation. If this equipment does cause harmful interference to radio or television reception, which can be determined by turning the equipment off and on, the user is encouraged to try to correct the interference by one of the following measures:

- Reorient or relocate the receiving antenna.
- Increase the separation between the equipment and receiver.
- Connect the equipment into an outlet on a circuit different from that to which the receiver is connected.
- Consult the dealer or an experienced radio/TV technician for help.

FCC Caution: To assure continued compliance, (example - use only shielded interface cables when connecting to computer or peripheral devices). Any changes or modifications not expressly approved by the party responsible for compliance could void the user's authority to operate this equipment.

This device complies with Part 15 of the FCC Rules. Operation is subject to the following two conditions: (1) This device may not cause harmful interference, and (2) this device must accept any interference received, including interference that may cause undesired operation.

IMPORTANT NOTE:**Federal Communication Commission Interference Statement**

This equipment has been tested and found to comply with the limits for a Class B digital device, pursuant to Part 15 of the FCC Rules. These limits are designed to provide reasonable protection against harmful interference in a residential installation. This equipment generates, uses and can radiate radio frequency energy and, if not installed and used in accordance with the instructions, may cause harmful interference to radio communications. However, there is no guarantee that interference will not occur in a particular installation. If this equipment does cause harmful interference to radio or television reception, which can be determined by turning the equipment off and on, the user is encouraged to try to correct the interference by one of the following measures:

- Reorient or relocate the receiving antenna.
- Increase the separation between the equipment and receiver.
- Connect the equipment into an outlet on a circuit different from that to which the receiver is connected.
- Consult the dealer or an experienced radio/TV technician for help.

This device complies with Part 15 of the FCC Rules. Operation is subject to the following two conditions: (1) This device may not cause harmful interference, and (2) this device must accept any interference received, including interference that may cause undesired operation.

FCC Caution: Any changes or modifications not expressly approved by the party responsible for compliance could void the user's authority to operate this equipment.

FCC RF Radiation Exposure Statement:

This equipment complies with FCC radiation exposure limits set forth for an uncontrolled environment. This equipment should be installed and operated with minimum distance 20cm between the radiator & your body. This transmitter must not be co-located or operating in conjunction with any other antenna or transmitter.

BUFFALO declared that WHR3-G54 is limited in CH1~11 by specified firmware controlled in USA.

Safety

This equipment is designed with the utmost care for the safety of those who install and use it. However, special attention must be paid to the dangers of electric shock and static electricity when working with electrical equipment. All guidelines of this manual and of the computer manufacturer must therefore be allowed at all times to ensure the safe use of the equipment.

EU Countries intended for use

The ETSI version of this device is intended for home and office use in Austria, Belgium, Denmark, Finland, France (with Frequency channel restrictions), Germany, Greece, Iceland, Ireland, Italy, Luxembourg, Norway, The Netherlands, Portugal, Spain, Sweden, Switzerland and United Kingdom.

The ETSI version of this device is also authorized for use in EFTA member states Iceland, Liechtenstein, Norway and Switzerland.

EU Countries Not intended for use

None.

Potential restrictive use

France: Only channels 10,11,12, and 13.

Buffalo Technology (Melco Inc.) products comes with a two-year limited warranty from the date of purchase. Buffalo Technology (Melco Inc.) warrants to the original purchaser the product; good operating condition for the warranty period. This warranty does not include non-Buffalo Technology (Melco Inc.) installed components. If the Buffalo product malfunctions during the warranty period, Buffalo Technology/(Melco Inc.) will, replace the unit, provided the unit has not been subjected to misuse, abuse, or non-Buffalo Technology/(Melco Inc.) authorized alteration, modifications or repair.

All expressed and implied warranties for the Buffalo Technology (Melco Inc) product line including, but not limited to, the warranties of merchantability and fitness of a particular purpose are limited in duration to the above period.

Under no circumstances shall Buffalo Technology/(Melco Inc.) be liable in any way to the user for damages, including any lost profits, lost savings or other incidental or consequential damages arising out of the use of, or inability to use the Buffalo products.

In no event shall Buffalo Technology/(Melco Inc.) liability exceed the price paid for the product from direct, indirect, special, incidental, or consequential damages resulting from the use of the product, its accompanying software, or its documentation. Buffalo Technology/(Melco Inc.) does not offer refunds for any product.

@ 2003 Buffalo Technology (Melco, Inc.)

ADDRESS

Buffalo Technology (USA), Inc.
4030 West Braker Lane, Suite 120
Austin, TX 78759-5319

GENERAL INQUIRIES

Monday through Friday
8:30am-5:30pm CST

Direct: 512-794-8533 | **Toll-free:** 800-456-9799 | **Fax:** 512-794-8520 | **Email:** sales@buffalotech.com

TECHNICAL SUPPORT

North American Technical Support by phone is available 24 hours a day, 7 days a week. (USA and Canada).

Toll-free: (866) 752-6210 | **Email:** info@buffalotech.com

* When operating in High-Speed Mode, this Wi-Fi device achieves an actual throughput of up to 34.1 Mbps, which is the equivalent throughput of a system following 802.11g protocol and operating at a signaling rate of 125 Mbps.

BUFFALO

4030 W. Braker Ln. Suite 120
Austin, Texas 78759
Tel: 800-456-9799
Fax: 512-794-8606

Technical Support is available 24 hours a day, 7 days a week

(USA / Canada)

Toll-Free: 866-752-6210

email: info@buffalotech.com

©2004, Buffalo Technology (USA), Inc.