

3D HDMI Extender

Boost your video/audio transmission distance up to 200 feet (60 m) in HDTV 1080i, 130 feet (40 m) in HDTV 1080p, or 65 feet (20 m) in HDTV 1080p with 36-bit color depth.



**Customer
Support
Information**

Order toll-free in the U.S.: Call 877-877-BBOX (outside U.S. call 724-746-5500) • FREE technical support 24 hours a day, 7 days a week: Call 724-746-5500 or fax 724-746-0746 • Mailing address: Black Box Corporation, 1000 Park Drive, Lawrence, PA 15055-1018
Web site: www.blackbox.com • E-mail: info@blackbox.com

Trademarks Used in this Manual

Trademarks Used in this Manual

Black Box and the Double Diamond logo are registered trademarks of BB Technologies, Inc.

Any other trademarks mentioned in this manual are acknowledged to be the property of the trademark owners.

FEDERAL COMMUNICATIONS COMMISSION AND INDUSTRY CANADA RADIO FREQUENCY INTERFERENCE STATEMENTS

This equipment generates, uses, and can radiate radio-frequency energy, and if not installed and used properly, that is, in strict accordance with the manufacturer's instructions, may cause interference to radio communication. It has been tested and found to comply with the limits for a Class A computing device in accordance with the specifications in Subpart B of Part 15 of FCC rules, which are designed to provide reasonable protection against such interference when the equipment is operated in a commercial environment. Operation of this equipment in a residential area is likely to cause interference, in which case the user at his own expense will be required to take whatever measures may be necessary to correct the interference.

Changes or modifications not expressly approved by the party responsible for compliance could void the user's authority to operate the equipment.

This digital apparatus does not exceed the Class A limits for radio noise emission from digital apparatus set out in the Radio Interference Regulation of Industry Canada.

Le présent appareil numérique n'émet pas de bruits radioélectriques dépassant les limites applicables aux appareils numériques de classe A prescrites dans le Règlement sur le brouillage radioélectrique publié par Industrie Canada.

Normas Oficiales Mexicanas (NOM) Electrical Safety Statement INSTRUCCIONES DE SEGURIDAD

1. Todas las instrucciones de seguridad y operación deberán ser leídas antes de que el aparato eléctrico sea operado.
2. Las instrucciones de seguridad y operación deberán ser guardadas para referencia futura.
3. Todas las advertencias en el aparato eléctrico y en sus instrucciones de operación deben ser respetadas.
4. Todas las instrucciones de operación y uso deben ser seguidas.

NOM Statement

5. El aparato eléctrico no deberá ser usado cerca del agua—por ejemplo, cerca de la tina de baño, lavabo, sótano mojado o cerca de una alberca, etc.
6. El aparato eléctrico debe ser usado únicamente con carritos o pedestales que sean recomendados por el fabricante.
7. El aparato eléctrico debe ser montado a la pared o al techo sólo como sea recomendado por el fabricante.
8. Servicio—El usuario no debe intentar dar servicio al equipo eléctrico más allá a lo descrito en las instrucciones de operación. Todo otro servicio deberá ser referido a personal de servicio calificado.
9. El aparato eléctrico debe ser situado de tal manera que su posición no interfiera su uso. La colocación del aparato eléctrico sobre una cama, sofá, alfombra o superficie similar puede bloquea la ventilación, no se debe colocar en libreros o gabinetes que impidan el flujo de aire por los orificios de ventilación.
10. El equipo eléctrico deber ser situado fuera del alcance de fuentes de calor como radiadores, registros de calor, estufas u otros aparatos (incluyendo amplificadores) que producen calor.
11. El aparato eléctrico deberá ser conectado a una fuente de poder sólo del tipo descrito en el instructivo de operación, o como se indique en el aparato.
12. Precaución debe ser tomada de tal manera que la tierra física y la polarización del equipo no sea eliminada.
13. Los cables de la fuente de poder deben ser guiados de tal manera que no sean pisados ni pellizcados por objetos colocados sobre o contra ellos, poniendo particular atención a los contactos y receptáculos donde salen del aparato.
14. El equipo eléctrico debe ser limpiado únicamente de acuerdo a las recomendaciones del fabricante.
15. En caso de existir, una antena externa deberá ser localizada lejos de las líneas de energía.
16. El cable de corriente deberá ser desconectado del cuando el equipo no sea usado por un largo periodo de tiempo.
17. Cuidado debe ser tomado de tal manera que objetos líquidos no sean derramados sobre la cubierta u orificios de ventilación.

18. Servicio por personal calificado deberá ser provisto cuando:

A: El cable de poder o el contacto ha sido dañado; u

B: Objetos han caído o líquido ha sido derramado dentro del aparato; o

C: El aparato ha sido expuesto a la lluvia; o

D: El aparato parece no operar normalmente o muestra un cambio en su desempeño; o

E: El aparato ha sido tirado o su cubierta ha sido dañada.

Safety Instructions

Safety Instructions

The 3D HDMI Extender has been tested for conformance to safety regulations and requirements, and has been certified for international use. However, like all electronic equipment, the extender should be used with care. Please read and follow the safety instructions to protect yourself from possible injury and to minimize the risk of damage to the unit.

- Follow all instructions and warnings marked on this unit.
- Do not attempt to service this unit yourself, except where explained in this manual.
- Provide proper ventilation and air circulation and do not use near water.
- Keep objects that might damage the device away from it and be sure to place this unit on a stable surface.
- Use only the power adapter and power cords and connection cables designed for this unit.
- Do not use liquid or aerosol cleaners to clean this unit. Always unplug the power to the device before cleaning.

Table of Contents

1. Specifications	8
2. Overview	9
2.1 Introduction	9
2.2 Features	9
2.3 What's Included.....	10
2.4 Hardware Description.....	10
2.4.1 Transmitter	10
2.4.2 Receiver	13
2.5 Typical Configuration.....	15
3. Hardware Installation	16
4. EDID Learning.....	17
5. Performance Notes.....	18
Appendix. Pin Definitions.....	20
A.1 HDMI.....	20
A.2 CAT5 (RJ-45)	21

Chapter 1: Specifications

1. Specifications

Audio Support — Surround sound (up to 7.1 ch) or stereo digital audio

Compliance — HDMI Deep Color and full 3D, HDCP, HDMI 1.3a

Equalization — 8-level digital control at RX

ESD Protection — (1) human body model: ± 19 kV (air-gap discharge) and ± 12 kV (contact discharge); (2) core chipset: ± 8 kV

HDMI over Coax Transmission Range — Full HD (1080p): 130 ft. (40 m) using CAT5e cable, 165 ft. (50 m) using CAT6 cable; HD (720p/1080i): 165 ft. (50 m) using CAT5e cable, 200 ft. (60 m) using CAT6 cable

Housing — Metal enclosure

Input DDC Signal — 5 volts (peak-to-peak, TTL)

Input TMD5 Signal — 1.2 volts (peak-to-peak)

PCB Stack-up — 4-layer board (impedance control: differential 100 ohms, single 50 ohms)

Video Bandwidth — Single-link 225 MHz (6.75 Gbps)

Video Support — 480i, 480p, 720p, 1080i, 1080p (up to 36-bit color)

User Controls — Transmitter: (1) mode rotary switch; Receiver: (1) signal-level rotary switch

Connectors — Transmitter: Input: (1) HDMI Type A (19-pin female), Output: (1) RJ-45 (WE/SS 8P8C with [2] LED indicators), (1) HDMI Type A connector (19-pin female); Receiver: Input: (1) RJ-45 (WE/SS 8P8C with [2] LED indicators), Output: (1) HDMI Type A (19-pin female)

Indicators — Each unit: (2) LEDs

Temperature Tolerance — Operating: +32 to +104° F (0 to +40° C); Storage: -4 to +140° F (-20 to +60° C)

Relative Humidity — 20 to 90%, noncondensing

Power — Power supply: (1) 5 VDC, 2-A; Consumption: Transmitter: 4 watts (maximum); Receiver: 1.5 watts (maximum)

Size — Each unit: 1"H x 2.4"W x 3.6"D (2.6 x 6 x 9.1 cm)

Weight — Transmitter: 0.43 lb. (0.2 kg); Receiver: 0.37 lb. (0.19 kg)

2. Overview

2.1 Introduction

The 3D HDMI Extender boosts your video/audio transmission distance up to 200 feet (60 meters) in HDTV 1080i format, 130 feet (40 m) in HDTV 1080p format, and 65 feet (20 m) in HDTV 1080p with 36-bit color depth.

The extender also supports the most advanced 3D video format compliant with the HDMI 1.3a specification and therefore guarantees the highest 3D video compatibility on the market. With only one CAT5/5e/6 cable, users can readily extend HDTV sources from DVD players, Blu-ray Disc players, PS3s, PCs, and any other kinds of sources compliant with TMDS to distant display monitors including HDMI/DVI enabled TV sets or LCD PC monitors. This flexibility enables HDCP compliant DVD players or PS3s to transmit the utmost high-quality video and audio with a greater distance at minimal cost, when integrating several components.

The extender includes two units: a transmitter and a receiver. The transmitter captures the input HDMI/DVI signals and carries the signals via one CAT5/5e/6 cable. The receiver equalizes the transmitted HDMI signal. The transmission distance between the sending and receiving units can be up to 200 feet (60 m) at HD 720p or 1080i; or 130 feet (40 m) at Full HD 1080p. With an 8-level equalization rotary control on the receiving unit, users can adjust the equalization strength to the received HDMI signals accordingly, and optimize the transmission distance between source and destination.

2.2 Features

- Supports HDMI Deep Color and full 3D.
- Extends the transmission up to 200 feet (60 m) from the HDMI source at HD 1080i or 720p, 24-bit color.
- Extends the transmission up to 130 feet (40 m) from the HDMI source at Full HD 1080p, 24-bit color.
- Extends the transmission length up to 65 feet (20 m) from the HDMI source under Full HD resolution (1080p at 36-bit color depth).
- HDCP 1.1 compliant.
- Minimizes the cable skew by an adjustable 8-level equalization control.
- Transmits pure unaltered, uncompressed 7.1 ch digital HDMI over CAT5/5e/6 cable transmission.
- Supports DTS-HD and Dolby TrueHD high bit rate audio.
- Enables cascading.
- Wallmount housing is easy to install.
- Compatible with other HDMI over CAT5/5e/6 series products.

Chapter 2: Overview

NOTES:

1. The claimed transmission distance here depends on the installed cable grade, source device, and display.
2. For CAT5/coax transmission, you must use a solid cable, not stranded cable. Any keystone jack along the transmission path will decrease the transmission performance significantly.

2.3 What's Included

Your package should contain the following items. If anything is missing or damaged, contact Black Box Technical Support at 724-746-5500 or info@blackbox.com.

- (1) Transmitter
- (1) Receiver
- (2) 5-VDC, 2-A wallmount power supplies
- This user's manual

2.4 Hardware Description

2.4.1 Transmitter

Figures 2-1 and 2-2 show the transmitter's front and back panels. Table 2-1 describes its components.

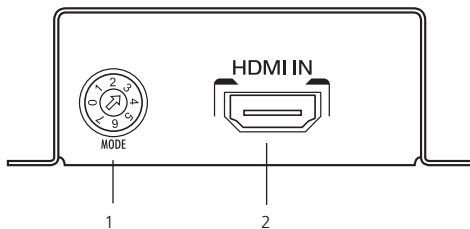

Figure 2-1. Transmitter front panel.

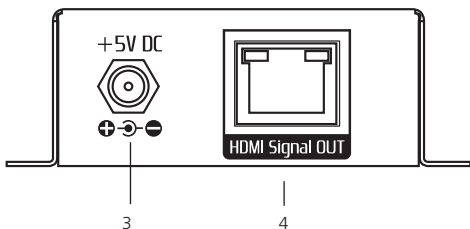

Figure 2-2. Transmitter back panel.

Table 2-1. Transmitter components.

Number	Component	Description
1	EDID mode switch	See Table 2-2.
2	HDMI in connector	Connects to an HDMI source with an HDMI male-male cable.
3	+5 VDC power connector	Connects to a 5-VDC power supply.
4	RJ-45 connector: HDMI signal out	Plug in a CAT5/5e/6 cable that will link to the receiver.

Chapter 2: Overview

Table 2-2. EDID mode switch options.

Number	Video	Audio
0	[Video]—2D/Full-HD 24-bit 1080p@60	[Audio]—up to 7.1 ch surround sound
1	[Video]— 2D/Full-HD 24-bit 1080p@60	[Audio]—up to 2.0 ch surround sound
2	[Video]—2D/Full-HD 36-bit 1080p@60	[Audio]—up to 7.1 ch surround sound
3	[Video]—2D/Full-HD 36-bit 1080p@60	[Audio]—up to 2.0 ch surround sound
4	[Video]—2D/HD 24-bit (1080p@30)(1080i@60) (720p@60)	[Audio]—up to 7.1 ch surround sound
5	[Video]—2D/HD 24-bit (1080p@30)(1080i@60) (720p@60)	[Audio]—up to 2.0 ch surround sound
6	[Video]—3D/Full-HD 36-bit (1080p@60)	[Audio]—up to 2.0 ch surround sound
7	[EDID Learning Mode]—learns EDID from the display	Plug in a CAT5/5e/6 cable that will link to the receiver.

2.4.2 Receiver

Figures 2-3 and 2-4 show the receiver's front and back panels. Table 2-2 describes its components.

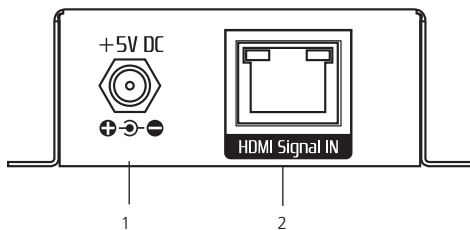

Figure 2-3. Receiver front panel.

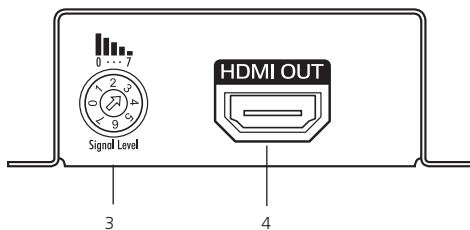

Figure 2-4. Receiver back panel.

Chapter 2: Overview

Table 2-2. Receiver components.

Number	Component	Description
1	+5-VDC power connector	Connects to a 5-VDC power supply unit.
2	RJ-45 connector: HDMI signal in	Plug in a CAT5/5e/6 cable that will link to the transmitter.
3	Signal level	Adjusts the 8-level signal equalization control to the received HDMI signals. The HDMI signal level varies from 0 (strongest) to 7 (weakest) for respective transmission length from the longest possible range to a short distance. Dial the Signal Level from 7 to 0 and stop turning the rotary switch when the audio/video is playing normally. Inappropriately setting the signal level might damage the extender.
4	HDMI signal out	Connect to an HDMI display with an HDMI male-male cable.

2.5 Typical Configuration

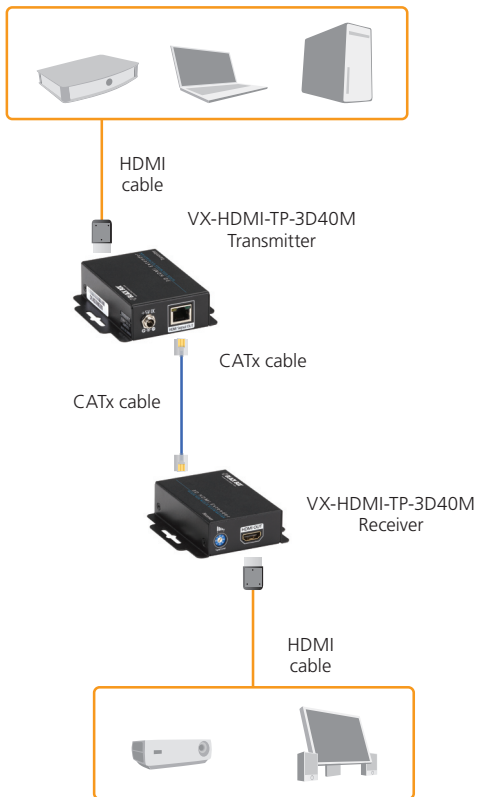

Figure 2-3. Connection diagram.

Chapter 3: Hardware Installation

3. Hardware Installation

1. Connect an HDMI or DVI source (such as a Blu-ray disc player) to the transmitter.
2. Connect an HDMI or DVI display (such as an LCD TV) to the receiver.
3. Connect a CAT5/5e/6 cable between the transmitter and the receiver.
4. Make sure the CAT5/5e/6 cable is tightly connected (not loose).
5. Plug in the 5-VDC power supply to the receiver's power jack.
6. Plug in the 5-VDC power supply to the transmitter's power jack.
7. If you see a flickering or blinking image on the display, adjust the rotary control switch to improve the cable skew. 0 stands for the strongest HDMI signal level for the longest possible transmission distance. 7 stands for the weakest HDMI signal for short transmission distance. Adjust the signal level from 7 to 0 and stop turning the rotary switch when the audio/video is playing normally. Inappropriately setting the signal level might damage the extender.

4. EDID Learning

1. Power off the transmitter and disconnect the CAT5/5e/6 cable between the transmitter and the receiver.
2. Using an HDMI cable, connect the HDMI display to the "HDMI IN" connector on the transmitter.
3. Set "MODE" on the transmitter.
4. Power on the transmitter.
5. The LED next to the RJ-45 connector on the transmitter will dim and light again, which indicates that the EDID learning procedure is complete.
6. Unplug the HDMI cable from the display and follow the instructions in Chapter 3 to set up the extender.

Chapter 5: Performance Notes

5. Performance Notes

1. When you adjust the signal level on the receiver, dial the rotary control switch from 7 to 0 and stop turning the rotary switch whenever the audio/video is playing normally. Inappropriately setting the signal level might damage the extender.
2. If the DVI or HDMI device requires the EDID information, use the EDID reader/writer to retrieve and provide DVI or HDMI display EDID information.
3. The transmission length is largely affected by the type of CAT5/5e/6 cables, the type of HDMI sources, and the type of HDMI display. The testing result shows solid UTP cables (usually in the form of 1000 ft. [300 m] bulk cables) can transmit much longer signals than stranded UTP cables (usually in the form of fixed length patch cords). Shielded STP cables are better suited than unshielded UTP cables. A solid UTP CAT5e cable transmits farther than stranded STP CAT6 cable. For long extension applications, use solid UTP/STP cables.
4. We recommend using EIA/TIA-568-B termination (T568B) for CAT5/5e/6 cable.
5. To reduce the interference among the unshielded twisted pairs of wires in CAT5/5e/6 cable, use shielded STP cables to improve EMI problems.

NOTE: EMI problems are more common in long transmission.

6. Because the quality of the CAT5/5e/6 cables has a major effect on how long the transmission limit can be and how good the received picture quality is, the actual transmission range depends on which CAT5/5e/6 cables you choose. For desired resolutions greater than 1080i or 1280 x 1024, we recommend using CAT6 cable.
7. If your HDMI display has multiple HDMI inputs, the first HDMI input [HDMI input #1] generally can produce better transmission performance among all HDMI inputs.

Table 5-1 on the next page describes HDMI performance over CAT5/CAT5e/CAT6 cable.

Chapter 5: Performance Notes

Table 5-1. HDMI performance guide.

Performance rating		Type of category cable		
Wiring	Shielding	CAT5	CAT5e	CAT6
Solid	Unshielded (UTP)	***	****	*****
	Shielded (STP)	***	***	****
Stranded	Unshielded (UTP)	*	**	**
	Shielded (STP)	*	*	**
Termination	Always use EIA/TIA-568B termination.			

NOTE: The number of asterisks in Table 5-1 indicates the performance quality (more asterisks = better performance).

Appendix A: Pin Definitions

Appendix. Pin Definitions

A.1 HDMI

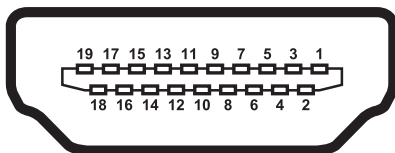

Figure A-1. Type A HDMI receptacle.

Table A-1. HDMI female connector pinning.

Pin Number	Signal	Pin Number	Signal
Pin 1	TMDS Data2+	Pin 11	TMDS Clock Shield
Pin 2	TMDS Data2 Shield	Pin 12	TMDS Clock-
Pin 3	TMDS Data2-	Pin 13	Not connected
Pin 4	TMDS Data1+	Pin 14	Reserved (Not connected on device)
Pin 5	TMDS Data1 Shield	Pin 15	SCL
Pin 6	TMDS Data-	Pin 16	SDA
Pin 7	TMDS Data0+	Pin 17	DDC/CEC Ground
Pin 8	TMDS Data0 Shield	Pin 18	+5V power
Pin 9	TMD Data0-	Pin 19	Hot Plug Detect
Pin 10	TMDS Clock+	—	—

A.2 CAT5 (RJ-45)

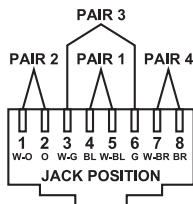

Figure A-2. RJ-45 jack.

Table A-2. Data link TIA/EIA-568-B.

Pin Number	Color	Function
Pin 1	White-Orange	TX0-
Pin 2	Orange	TX0+
Pin 3	White-Green	TX1-
Pin 4	Blue	TX2-
Pin 5	White-Blue	TX2+
Pin 6	Green	TX1+
Pin 7	White-Brown	TXC-
Pin 8	Brown	TXC+

Black Box Tech Support: FREE! Live. 24/7.

Tech support the
way it should be.



Great tech support is just 30 seconds away
at 724-746-5500 or blackbox.com.



About Black Box

Black Box provides an extensive range of networking and infrastructure products. You'll find everything from cabinets and racks and power and surge protection products to media converters and Ethernet switches all supported by free, live 24/7 Tech support available in 30 seconds or less.

© Copyright 2011. Black Box Corporation. All rights reserved.

VX-HDMI-TP-3D40M, version 1

724-746-5500 | blackbox.com