

**HOTWIRE<sup>®</sup> M/SDSL and HDSL2  
TERMINATION UNITS  
MODELS 8747, 8777, AND 8779  
USER'S GUIDE**

**Document No. 8700-A2-GB20-00**

April 2000

---

**Copyright © 2000 Paradyne Corporation.**  
**All rights reserved.**  
**Printed in U.S.A.**

## Notice

This publication is protected by federal copyright law. No part of this publication may be copied or distributed, transmitted, transcribed, stored in a retrieval system, or translated into any human or computer language in any form or by any means, electronic, mechanical, magnetic, manual or otherwise, or disclosed to third parties without the express written permission of Paradyne Corporation, 8545 126th Ave. N., Largo, FL 33773.

Paradyne Corporation makes no representation or warranties with respect to the contents hereof and specifically disclaims any implied warranties of merchantability or fitness for a particular purpose. Further, Paradyne Corporation reserves the right to revise this publication and to make changes from time to time in the contents hereof without obligation of Paradyne Corporation to notify any person of such revision or changes.

Changes and enhancements to the product and to the information herein will be documented and issued as a new release to this manual.

## Warranty, Sales, Service, and Training Information

Contact your local sales representative, service representative, or distributor directly for any help needed. For additional information concerning warranty, sales, service, repair, installation, documentation, training, distributor locations, or Paradyne worldwide office locations, use one of the following methods:

- **Internet:** Visit the Paradyne World Wide Web site at [www.paradyne.com](http://www.paradyne.com). (Be sure to register your warranty at [www.paradyne.com/warranty](http://www.paradyne.com/warranty).)
- **Telephone:** Call our automated system to receive current information by fax or to speak with a company representative.
  - Within the U.S.A., call 1-800-870-2221
  - Outside the U.S.A., call 1-727-530-2340

## Document Feedback

We welcome your comments and suggestions about this document. Please mail them to Technical Publications, Paradyne Corporation, 8545 126th Ave. N., Largo, FL 33773, or send e-mail to [userdoc@paradyne.com](mailto:userdoc@paradyne.com). Include the number and title of this document in your correspondence. Please include your name and phone number if you are willing to provide additional clarification.

## Trademarks

ACCULINK, COMSPHERE, FrameSaver, Hotwire, and NextEDGE are registered trademarks of Paradyne Corporation. MVL, OpenLane, Performance Wizard, and TruePut are trademarks of Paradyne Corporation. All other products and services mentioned herein are the trademarks, service marks, registered trademarks, or registered service marks of their respective owners.

## Regulatory and Safety Information

Refer to the appropriate Digital Subscriber Line Access Multiplexer (DSLAM) manual for all regulatory notices and safety information.



Printed on recycled paper

---

# Contents

---

## About This Guide

- Document Purpose and Intended Audience ..... vii
- Document Summary ..... vii
- Product-Related Documents ..... viii

## 1 About the Hotwire 8747, 8777, and 8779 Termination Units

- M/SDSL and HDSL2 Overview ..... 1-1
- Hotwire 87xx Termination Unit Features ..... 1-2
- Network Configuration ..... 1-3
- SNMP Management Capabilities ..... 1-4
  - Management Information Base (MIB) Support ..... 1-4
  - SNMP Trap Support ..... 1-4

## 2 Using the Asynchronous Terminal Interface

- User Interface Access ..... 2-1
- Management Serial Port Settings ..... 2-1
- Logging In to the Hotwire DSLAM ..... 2-2
- Initiating an ATI Session ..... 2-2
- Screen Work Areas ..... 2-5
- Navigating the Screens ..... 2-6
  - Keyboard Keys ..... 2-6
  - Screen Function Keys ..... 2-7
  - Switching Between Screen Work Areas ..... 2-8
- Ending an ATI Session ..... 2-9
- Exiting From the DSLAM Session ..... 2-9

### 3 Initial Startup and Configuration

- Overview ..... 3-1
- Entering Identity Information ..... 3-2
- Configuring the Unit ..... 3-3
  - Configuration Options ..... 3-3
- Accessing and Displaying Configuration Options ..... 3-4
- Configuration Edit/Display ..... 3-5
- Saving Configuration Options ..... 3-6
- Restoring Access to the User Interface ..... 3-7
- Resetting the Device ..... 3-7
- Disabling AutoRate ..... 3-8
- Resetting AutoRate ..... 3-8

### 4 Cross-Connecting Ports

- Overview ..... 4-1
- Determining the Configuration ..... 4-2
- Setting the Cross-Connect Modes ..... 4-3
- Assigning Time Slots ..... 4-4

### 5 IP Addressing

- Selecting an IP Addressing Scheme ..... 5-1
  - Configurations Not Running IP Conservative Software ..... 5-1
  - All Configurations ..... 5-1
- IP Addressing Example ..... 5-2

### 6 Security

- Overview ..... 6-1
- ATI Access Levels ..... 6-2
- Creating a Login ..... 6-3
- Deleting a Login ..... 6-4
- Controlling SNMP Access ..... 6-5
  - Assigning SNMP Community Names and Access Types ..... 6-5
  - Limiting SNMP Access through the IP Addresses of the Managers . 6-5

## 7 Monitoring and Troubleshooting

- What to Monitor ..... 7-1
- Viewing System and Test Status ..... 7-2
  - Health and Status Messages ..... 7-3
  - Self-Test Results Messages ..... 7-6
  - Test Status Messages ..... 7-7
- Device Messages ..... 7-8
- Viewing Network Error Statistics ..... 7-10
- Viewing Network Performance Statistics ..... 7-11
- Viewing DSX-1 Performance Statistics ..... 7-13
- Viewing G.703 Performance Statistics ..... 7-15
- Viewing LED Status ..... 7-17
- Front Panel LEDs ..... 7-19
- Changing the Meaning of the PORTS LEDs ..... 7-20
- Troubleshooting ..... 7-21

## 8 Testing

- Accessing the Test Menu ..... 8-1
- Running Network Tests ..... 8-2
  - Network Line Loopback ..... 8-4
  - Repeater Loopback ..... 8-5
  - DTE Loopback ..... 8-6
  - Remote Send Line Loopback ..... 8-7
  - Send and Monitor 511 ..... 8-8
- Device Tests ..... 8-9
  - Lamp Test ..... 8-9
- Ending an Active Test ..... 8-10
- Telco-Initiated Tests ..... 8-11
  - Telco-Initiated Line Loopback ..... 8-11
  - Telco-Initiated Payload Loopback ..... 8-12
  - Telco-Initiated Remote Line Loopback ..... 8-12

## 9 Transferring Code and Configurations Using TFTP

- Download Code ..... 9-1
  - Applying the Download ..... 9-2
- Configuration Loader ..... 9-3

## A Configuration Options

■ Overview .....	A-1
■ Network Interface Options Menu .....	A-2
■ DSX-1 Interface Options .....	A-6
■ G.703 Interface Options .....	A-8
■ Copy Ports Options .....	A-10
■ System Options .....	A-11
■ System Clock .....	A-13
■ Cross-Connect .....	A-17
Set Cross-Connect Mode .....	A-18
Assign Time Slots .....	A-20
■ Management and Communication Options Menu .....	A-23
Telnet Session Options .....	A-23
General SNMP Management Options .....	A-25
SNMP NMS Security Options .....	A-27
SNMP Traps Options .....	A-29

## B Standards Compliance for SNMP Traps

■ SNMP Traps .....	B-1
■ ifIndex .....	B-1
■ warmStart .....	B-2
■ authenticationFailure .....	B-2
■ linkUp and linkDown .....	B-3
■ Enterprise-Specific Traps .....	B-5

## C Connector Pin Assignments

■ Hotwire Termination Unit Front Panel 50-pin DTE Connector Pinouts ..	C-1
■ Model 8610, 8810, and 8820 DSLAM Telco 50-pin Connector Pinouts ..	C-3

## **D Technical Specifications**

## **E Cross-Connection Worksheets**

- Using the Worksheets ..... E-1
- Port Connection Diagram ..... E-2
- DSX-1 Time Slot Assignments ..... E-3
- G.703 Time Slot Assignments ..... E-11

## **Glossary**

## **Index**





---

# About This Guide

---

## Document Purpose and Intended Audience

This guide contains information needed to set up, configure, and operate Hotwire Models 8747, 8777, and 8779 Multirate Symmetric Digital Subscriber Line (M/SDSL) and High-bit-rate DSL second generation (HDSL2) Termination Units, and is intended for installers and operators.

## Document Summary

<b>Section</b>	<b>Description</b>
<b>Chapter 1</b>	<i>About the Hotwire 8747, 8777, and 8779 Termination Units.</i> Describes the Hotwire Termination Units' features and capabilities.
<b>Chapter 2</b>	<i>Using the Asynchronous Terminal Interface.</i> Provides instructions for accessing the user interface and navigating the screens.
<b>Chapter 3</b>	<i>Initial Startup and Configuration.</i> Provides instructions for configuring the unit.
<b>Chapter 4</b>	<i>Cross-Connecting Ports.</i> Provides instructions for cross-connecting the time slots of the DSL and DTE ports.
<b>Chapter 5</b>	<i>IP Addressing.</i> Provides IP addressing requirements and examples.
<b>Chapter 6</b>	<i>Security.</i> Presents procedures for creating a login, setting the effective access levels, and controlling SNMP access.
<b>Chapter 7</b>	<i>Monitoring and Troubleshooting.</i> Describes using the LEDs, status messages, and network statistics to monitor the unit and diagnose problems.
<b>Chapter 8</b>	<i>Testing.</i> Provides instructions for running network, DSX-1, and G.703 tests.

<b>Section</b>	<b>Description</b>
Chapter 9	<i>Transferring Code and Configurations Using TFTP.</i> Shows how to upload and download firmware and configuration files.
Appendix A	<i>Configuration Options.</i> Contains all configuration options, default settings, and possible settings.
Appendix B	<i>Standards Compliance for SNMP Traps.</i> Contains SNMP trap compliance information.
Appendix C	<i>Connector Pin Assignments.</i> Lists the pin assignments for the front panel DTE connector.
Appendix D	<i>Technical Specifications.</i> Contains physical and regulatory specifications, network and port interfaces, power consumption values, and accessory part numbers.
Appendix E	<i>Cross-Connection Worksheets.</i> Contains worksheets to help plan and configure the cross-connection of DTE and DSL ports.
Glossary	Defines acronyms and terms used in this document.
Index	Lists key terms, acronyms, concepts, and sections in alphabetical order.

## Product-Related Documents

<b>Document Number</b>	<b>Document Title</b>
7970-A2-GB20	<i>Hotwire M/SDSL, M/HDSL, and HDSL2 Standalone Termination Units, Models 7944, 7945, 7974, 7975, 7976, 7984, 7985, and 7986, User's Guide</i>
8000-A2-GB22	<i>Hotwire Management Communications Controller (MCC) Card, IP Conservative, User's Guide</i>
8000-A2-GB29	<i>Hotwire Management Communications Controller (MCC) Card User's Guide</i>
8610-A2-GN10	<i>Hotwire 8610 DSLAM Installation Instructions</i>
8810-A2-GN11	<i>Hotwire 8810 DSLAM Installation Instructions</i>
8820-A2-GN20	<i>Hotwire 8820 GrandSLAM Installation Guide</i>

Contact your sales or service representative to order additional product documentation.

Paradyne documents are also available on the World Wide Web at [www.paradyne.com](http://www.paradyne.com). Select *Library* → *Technical Manuals*.

---

# About the Hotwire 8747, 8777, and 8779 Termination Units

# 1

---

## M/SDSL and HDSL2 Overview

Hotwire® Multirate Symmetric Digital Subscriber Line (M/SDSL) products maximize customer service areas by varying the DSL line rate. This ensures symmetric DSL connectivity over a wide range of telephone line distances and transmission line qualities. Hotwire M/SDSL products transmit data over 14,000 feet (4.6 km) at rates up to 2.048 Mbps.

Hotwire High-bit-rate DSL second generation (HDSL2) products transmit data up to 12,000 feet (3.9 km) at up to 1.544 Mbps.

Hotwire products support autorate. Units first synchronize to the highest line rate that the 2-wire loop supports, and then automatically configure to the highest multiple of 64 kbps supported by that line rate. Eight line rates are available. At all rates, a 16 kbps management channel is available, which enables functions such as firmware downloads to remote units. Units can also be configured manually to full or fractional T1 or E1 rates.

## Hotwire 87xx Termination Unit Features

The Hotwire 87xx Termination Unit is a circuit board mounted in a Hotwire 8610 or 8810 Digital Subscriber Line Access Multiplexer (DSLAM), or 8820 GrandSLAM, and used to transport signals at high speeds over a twisted-pair connection.

Model . . .	Has eight . . .	And eight . . .
8747	HDSL2 ports	DSX-1 ports
8777	M/SDSL ports	DSX-1 ports
8779	M/SDSL ports	G.703 ports

Hotwire 8747, 8777, and 8779 Termination Units have these standard features:

- **Cross-Connection Capability.** Any DSL port and time slot can be connected to any DTE port and time slot.
- **Embedded Operations Channel (EOC).** Provides remote management via SNMP or Telnet session capability over the DSL network.
- **Asynchronous Terminal Interface (ATI).** Provides a menu-driven VT100-compatible terminal interface for configuring and managing the unit locally or remotely by Telnet session.
- **Local Management.** Provides local management using the DSLAM management card with a:
  - Terminal or PC via the Management Serial port of the DSLAM
  - NMS connection through the 10BaseT port
- **Remote Management.** Provides remote management:
  - Out-of-band, using an external modem through the Management Serial port of the DSLAM
  - Via Telnet over the EOC
- **Alarm Indication.** Activates front panel LEDs.
- **Diagnostics.** Provides the capability to diagnose device and network problems and perform tests, including digital loopbacks, pattern tests, and self-test.
- **Device and Test Monitoring.** Provides the capability of tracking and evaluating the unit's operation, including health and status, and error-rate monitoring.

## Network Configuration

Figure 1-1 shows a T1 network application using a Hotwire 87xx Termination Unit for access concentration in a central office (CO). A frame relay switch and a router are connected, through the termination unit, to partner units on the customer premises (CP) supporting a T1 host or router, and frame relay encapsulated or unframed data.

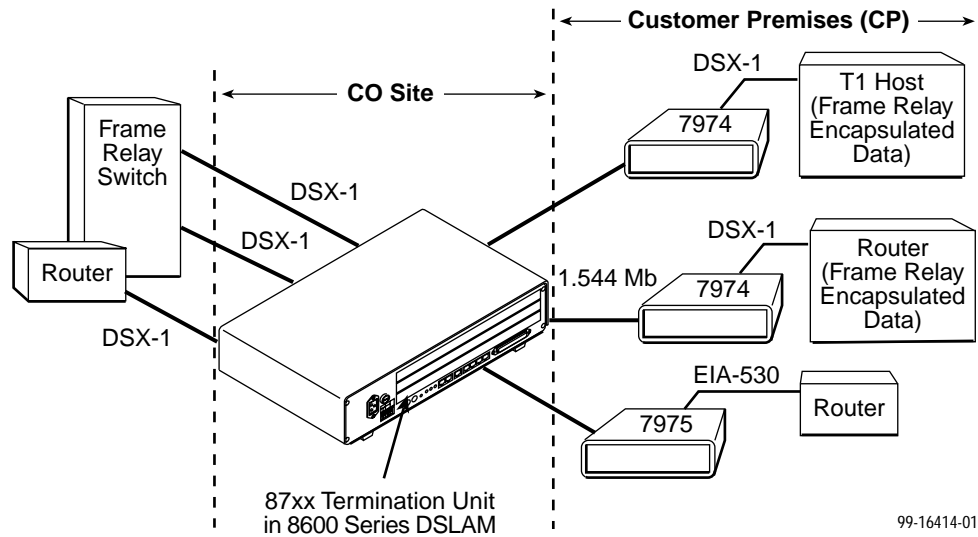

Figure 1-1. Sample CO-to-CP Configuration

## SNMP Management Capabilities

Hotwire 87xx Termination Units support SNMP Version 1, and can be managed by any industry-standard SNMP manager and accessed using SNMP by external SNMP managers.

### Management Information Base (MIB) Support

For a detailed description of supported MIBs, visit Paradyne's Web site at [www.paradyne.com](http://www.paradyne.com). The following MIBs are supported:

- **MIB II (RFC 1213 and RFC 1573)** – Defines the general objects for use with a network management protocol in TCP/IP internets and provides general information about the unit. MIB II is backward-compatible with MIB I.
- **DS1/E1 MIB (RFC 1406)** – Reports the performance status of the DSX-1 or G.703 interface and supports the features found on the DSX-1 or G.703 Performance Statistics screen.
- **Paradyne Enterprise MIB** – Supports configuration, status, statistics, and tests.

### SNMP Trap Support

The Hotwire 87xx Termination Unit supports SNMP traps as shown in Appendix B, *Standards Compliance for SNMP Traps*.

---

# Using the Asynchronous Terminal Interface

# 2

---

## User Interface Access

You can communicate with the asynchronous terminal interface (ATI) using one of the following methods:

- Direct connection through the Management Serial port of the DSLAM (locally or via an external modem).
- Telnet session using a Network Management System (NMS) connected to a LAN/WAN port on the DSLAM.
- Telnet session through the Embedded Operations Channel (EOC).

### NOTE:

Only one asynchronous terminal interface session can be active at a time, and another user's session cannot be forced to end. To automatically log out a user due to inactivity, enable the Inactivity Timeout option (see Table A-11, [Telnet Session Options](#), in Appendix A, *Configuration Options*).

Security can limit ATI access several ways. To set up security or a login ID, refer to Chapter 6, [Security](#).

## Management Serial Port Settings

Ensure that the device you connect communicates using these settings:

- Data rate set to 9.6 kbps.
- Character length set to 8.
- Parity set to None.
- Stop Bits set to 1.

Refer to the installation document for your DSLAM.

## Logging In to the Hotwire DSLAM

You can log in to the Hotwire DSLAM system using either a local VT100-compatible terminal or a remote Telnet connection.

After you enter your user ID and password, the system displays the Hotwire Chassis Main Menu. See your management card documentation for information about selecting the unit from the card selection screen.

## Initiating an ATI Session

The Main Menu screen is displayed on the screen unless a login ID and password is required or the ATI is already in use.

If security is enabled on the Hotwire Termination Unit and you used Telnet to access it directly (you did not log in through the management card), the system prompts you for a login ID and password.

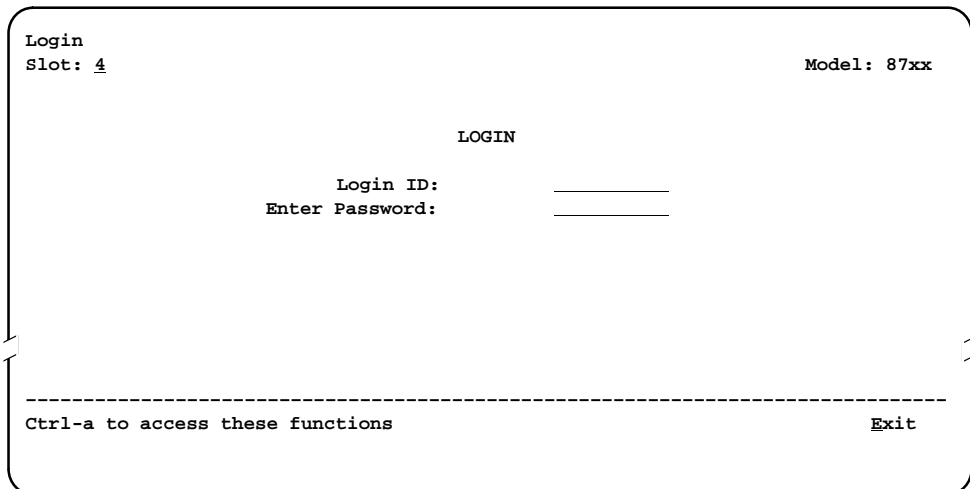

```
Login
Slot: 4                                     Model: 87xx

                               LOGIN

          Login ID:      _____
          Enter Password: _____

-----
Ctrl-a to access these functions                                Exit
```

If you enter an invalid login ID and password after three attempts, the Telnet session closes or the terminal connection returns to an idle state. Refer to Chapter 6, *Security*.

If the ATI is already in use, the message `connection refused` is sent to a terminal attempting Telnet access.



After you enter a valid login ID and password, the Main Menu appears.

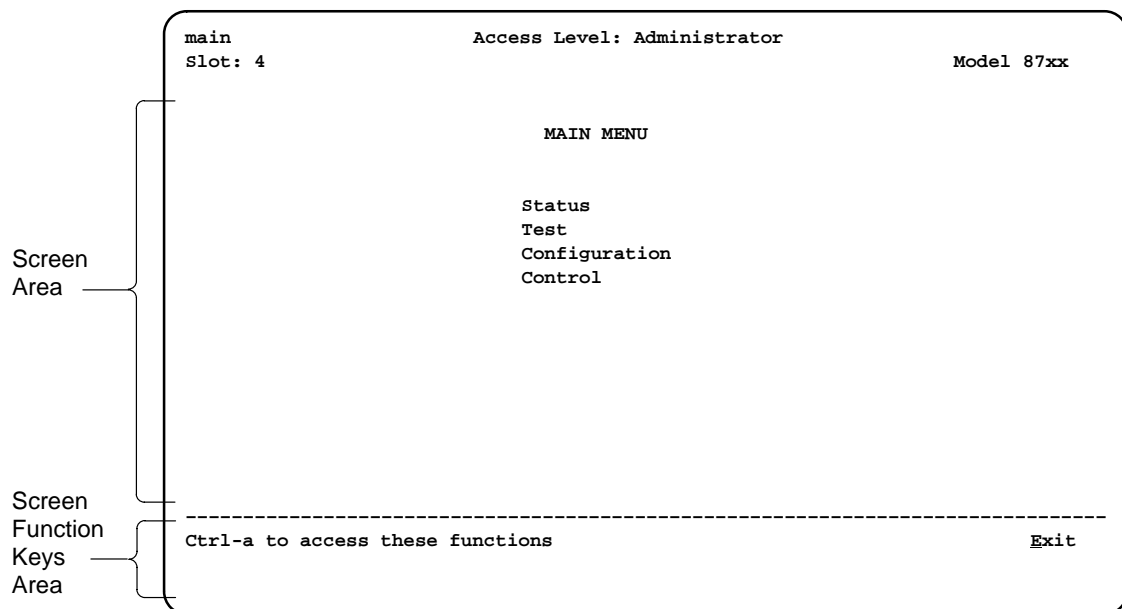

Entry to all of the termination unit's tasks begins at the Main Menu screen.

Select ...	To ...
Status	View system status, diagnostic test results, statistics, LEDs, and device identity information.
Test	Select, start, stop and cancel tests for the unit's interfaces.
Configuration	Display and edit the configuration options.
Control	Change the device identity, administer logins, download new firmware, or initiate a power-up reset of the unit.

What appears on the screens depends on your:

- **Current configuration** – How your unit is currently configured.
- **Effective security access level** – An access level that is typically set by the system administrator for each interface and each user.
- **Data selection criteria** – What you entered in previous screens.

The following illustration shows the paths to the different ATI screens.

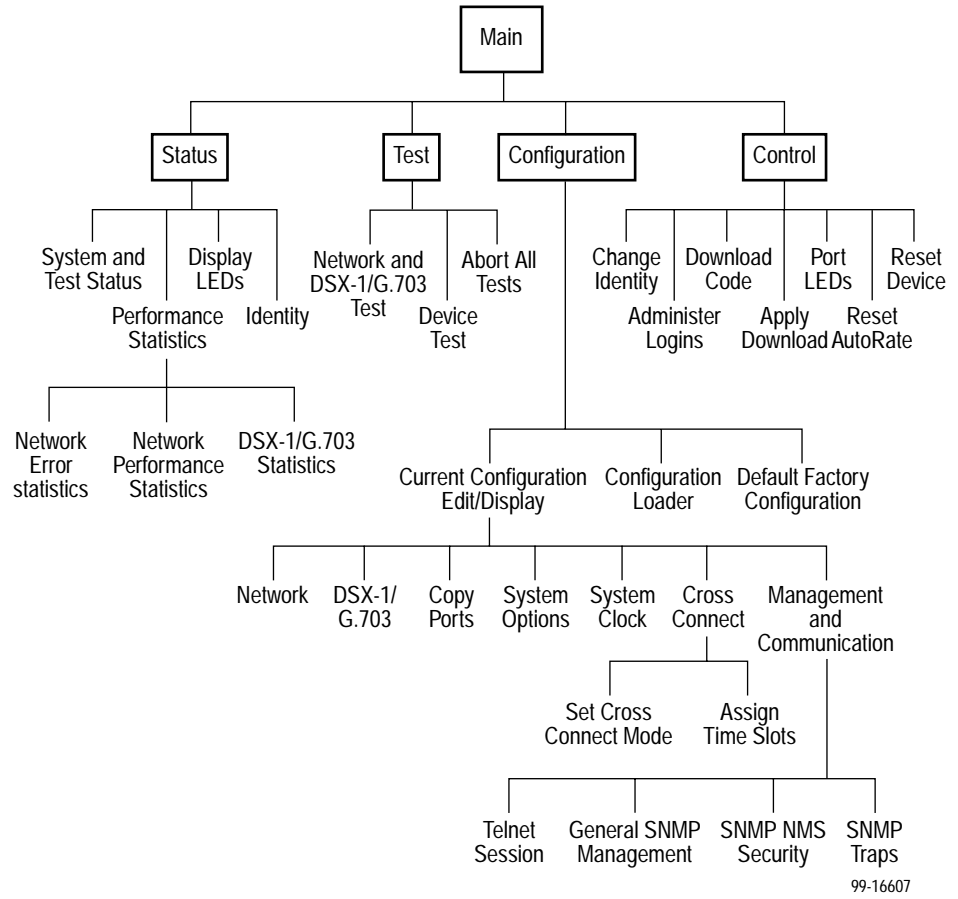

## Screen Work Areas

There are two user work areas:

- **Screen area** – This is the area above the dotted line that provides the menu path, menus, and input fields.

The menu path appears as the first line on the screen. In this manual, the menu path is presented as a menu selection sequence with the names of the screens:

*Main Menu → Configuration → Load Configuration From → Network Interface Options*

- **Screen function key area** – This is the area below the dotted line that lists function keys specific to the screen, field value choices, and system messages.

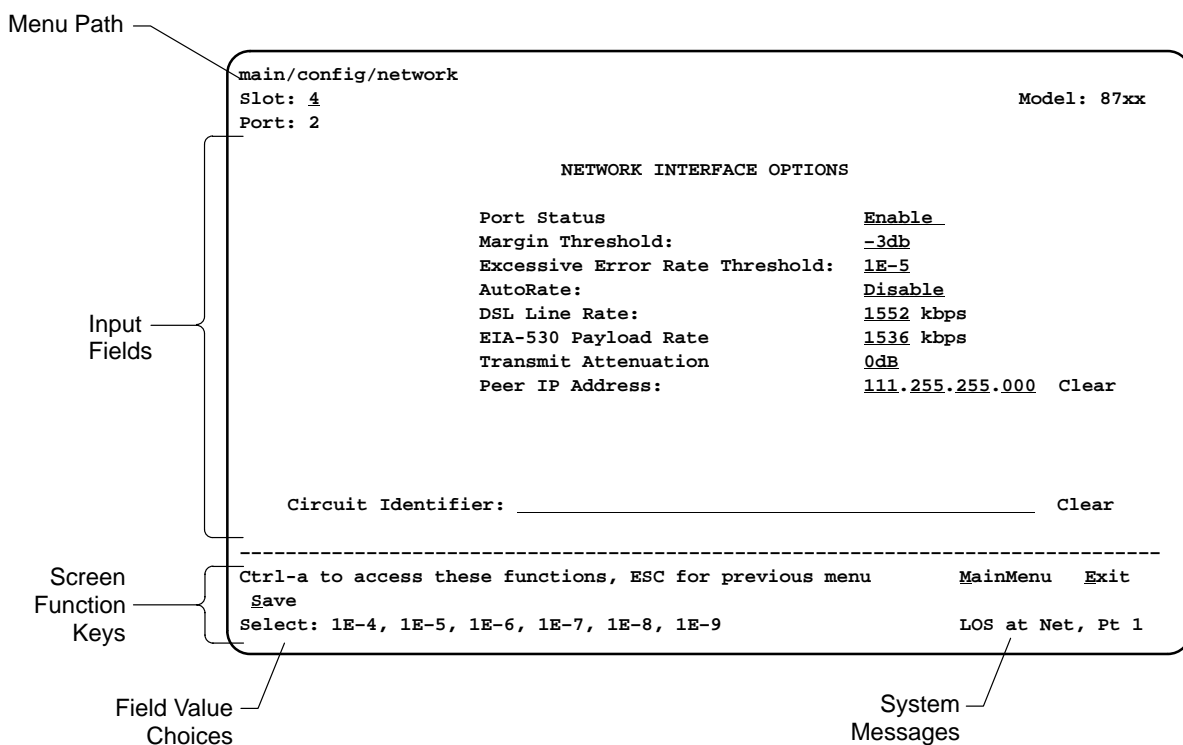

## Navigating the Screens

You can navigate the screens by:

- Using keyboard keys
- Using screen function keys
- Switching between the two screen work areas

### Keyboard Keys

Use the following keyboard keys to navigate within the screen.

Press . . .	To . . .
Ctrl-a	Move cursor between the screen area and the screen function keys area below the dotted line at the bottom of the screen.
Esc	Return to the previous screen.
Tab	Move cursor to the next field on the screen.
Backspace	Move cursor to the previous field on the screen.
Enter	Accept entry or display valid options on the last row of the screen when pressed before entering data or after entering invalid data.
Ctrl-k	Tab backwards (move cursor one field to the left).
Spacebar	Select the next valid value for the field.
Delete (Del)	Delete character that the cursor is on.
Up Arrow or Ctrl-u	Move cursor up one field within a column on the same screen.
Down Arrow or Ctrl-d	Move cursor down one field within a column on the same screen.
Right Arrow or Ctrl-f	Move cursor one character to the right if in edit mode.
Left Arrow or Ctrl-b	Move cursor one character to the left if in edit mode.
Ctrl-l	Redraw the screen display, clearing information typed in but not yet entered.

#### ► Procedure

To make a menu or field selection:

1. Press the Tab key or the right arrow key to position the cursor on a menu or field selection. Each selection is highlighted as you press the key to move the cursor from position to position.
2. Press Enter. The selected menu or screen appears.
3. Continue Steps 1 and 2 until you reach the screen you want.

The current setting or value appears to the right of the field name. You can enter information into a selected field by:

- Typing in the first letter(s) of a field value or command.
- Switching from the screen area to the screen function area below the dotted line and selecting or entering the designated screen function key.

If a field is blank and the Field Values screen area displays valid selections, press the spacebar and the first valid value for the field will appear. Continue pressing the spacebar to scroll through other valid values.

## Screen Function Keys

All screen function keys located below the dotted line operate the same way (upper- or lowercase) throughout the screens.

<b>For the screen function . . .</b>	<b>Select . . .</b>	<b>And press Enter to . . .</b>
Clr <u>F</u> ar	F or f	Clear far-end network statistics and refresh the screen.
Clr <u>N</u> ear	N or n	Clear near-end network statistics and refresh the screen.
Clr <u>S</u> tats	S or s	Clear DSX-1 statistics and refresh the screen.
De <u>l</u> ete	L or l	Delete data.
<u>E</u> xit	E or e	Terminate the asynchronous terminal session.
<u>M</u> ainMenu	M or m	Return to the Main Menu screen.
<u>N</u> ew	N or n	Enter new data.
Pg <u>D</u> n	D or d	Display the next page, or group of entries.
Pg <u>U</u> p	U or u	Display the previous page, or group of entries.
<u>R</u> esetMon	R or r	Reset an active Monitor 511 test counter to zero.
<u>S</u> ave	S or s	Save information.

## Switching Between Screen Work Areas

Select Ctrl-a to switch between the two screen work areas to perform all screen functions.

### ► Procedure

To access the screen function area below the dotted line:

1. Press Ctrl-a to switch from the screen area to the screen function key area below the dotted line.
2. Select either the function's designated (underlined) character or press the Tab key until you reach the desired function key.

*Example:*

To save the current options, type **s** or **S** (Save).

3. Press Enter. The function is performed.
4. To return to the screen area above the dotted line, press Ctrl-a again.

```
main/config/network
Slot: 4
Port: 2
Model: 87xx

NETWORK INTERFACE OPTIONS

Margin Threshold:      -3db
Excessive Error Rate Threshold: 1E-5
AutoRate:              Disable
DSL Line Rate:         1552

Circuit Identifier: _____ Clear
-----
Ctrl-a to access these functions, ESC for previous menu      MainMenu  Exit
```

## Ending an ATI Session

Use the Exit function key from any screen to terminate the session.

### ► Procedure

To end a session with the asynchronous terminal interface:

1. Press Ctrl-a to go to the screen function key area below the dotted line.
2. Save changes if required. A confirmation message appears if you have made but not saved changes to your configuration.
3. Tab to Exit (or type **e** or **E**) and press Enter. If you have accessed the unit through the management card, the Hotwire Chassis Card Selection menu appears.

## Exiting From the DSLAM Session

You can manually log out of the system or, after five minutes of inactivity, the system will automatically log you out.

### ► Procedure

To manually exit from the Hotwire DSLAM system:

1. Return to the Hotwire Chassis Main Menu by selecting Exit from either the Hotwire – MCC menu or the Hotwire – DSL menu.  
The Hotwire Card Selection menu appears.
2. Press Ctrl-z.  
The Hotwire Chassis Main Menu appears.
3. From the Hotwire Chassis Main Menu, select Logout.  
The system exits from the current login session on the Hotwire DSLAM.





---

# Initial Startup and Configuration

# 3

---

## Overview

This chapter provides instructions on how to access the system for the first time and perform initial setup procedures. These procedures include:

- Providing initial **unit identity** information or changing existing identity information.
- Accessing and displaying the current or factory default **configuration options**.
- Modifying current configuration options using the **Configuration Edit/Display** menu.
- **Saving** your configuration option changes.
- **Restoring access** to the user interface in the event it is lost.
- **Resetting** the device.

This chapter also explains how to **disable** and **reset** AutoRate.

## Entering Identity Information

After accessing your unit for the first time, use the Change Identity screen to determine SNMP administrative system information that will be displayed on the Identity screen of the Status branch. To access the Card Identity screen, follow this menu selection sequence:

*Main Menu → Control → Change Identity*

```

main/control/change_identity
Slot: 4                                     Model: 87xx

                                IDENTITY

System Name:   Prez 111QJ98-001_____      Clear
System Location: Bldg. A412, 2nd Floor, Left cabinet_____ Clear
System Contact: L. Young 800-727-2396 pager 888-555-1212      Clear

-----
Ctrl-a to access these functions, ESC for previous menu      MainMenu  Exit
Save

```

The three System entry fields are alphanumeric and provide 128 characters for each field. The System entries appear on the Identity display as shown above. The SNMP System entry fields are:

- **System Name:** The general SNMP system name.
- **System Location:** The physical location of the SNMP-managed device.
- **System Contact:** Identification information, such as contact name, phone number, or mailing address.

Valid entry values are any printable ASCII character. ASCII printable characters include:

- Numeric 0–9
- Upper- or lowercase A–Z
- Space
- All ASCII symbols except the caret (^)

### ► Procedure

To enter Change Identity screen information:

1. Position the cursor in the System Name field. Enter a name unique in your network to identify the SNMP managed node (or unit)  
The maximum length of System Name is 128 characters.
2. Position the cursor in the System Location field. Enter the physical location of the unit.  
The maximum length of System Location is 128 characters.
3. Position the cursor in the System Contact field. Enter the name and contact information for the person responsible for the unit.  
The maximum length of System Contact is 128 characters.
4. Press Ctrl-a to switch to the screen function key area below the dotted line.
5. Select Save and press Enter.

## Configuring the Unit

Configuration option settings determine how the unit operates. Use the Configuration branch of the asynchronous terminal interface menu to display or change configuration option settings.

### Configuration Options

The unit is shipped with factory settings in the Default Factory Configuration area. You can find default information by:

- Referring to Appendix A, *Configuration Options*.
- Accessing the Configuration menu branch.

The unit has two sets of configuration option settings. The Current Configuration matches the Default Factory Configuration until modified and saved by the user.

Configuration Option Area	Description
Current Configuration	The unit's active set of configuration options.
Default Factory Configuration	A read-only configuration area containing the factory default configuration options.

If the factory default settings do not support your network's configuration, customize the configuration options for your application.

## Accessing and Displaying Configuration Options

To display the configuration options, you must first load a configuration option set into the edit area.

To load a configuration option set into the configuration edit area, follow this menu selection sequence:

*Main Menu → Configuration (Load Configuration From)*

```

main/configuration
Slot: 4                                     Model: 87xx

                                LOAD CONFIGURATION FROM:

                                Current Configuration
                                Configuration Loader
                                Default Factory Configuration

-----
Ctrl-a to access these functions, ESC for previous menu      MainMenu  Exit

```

Make a selection by placing the cursor at your choice and pressing Enter.

If you select ...	Then ...
Current Configuration	The selected configuration option set is loaded and the Configuration Edit/Display menu screen appears.
Configuration Loader	The Configuration Loader screen is displayed allowing you to upload or download configurations from a TFTP server.
Default Factory Configuration	The default factory configuration is loaded and the Configuration Edit/Display menu screen appears.

## Configuration Edit/Display

The Configuration Edit/Display screen appears when the current, customer, or default configuration is loaded and allows groups of configuration options to be displayed. To access the Configuration Edit/Display screen, follow this menu selection sequence:

*Main Menu* → *Configuration* → *Current Configuration*

– or –

*Main Menu* → *Configuration* → *Default Factory Configuration*

```

main/config/edit
Slot: 4
Model: 87xx

CONFIGURATION EDIT/DISPLAY

Network
DSX-1 | G.703
Copy Ports
System Options
System Clock
Cross-Connect
Management and Communication

-----
Ctrl-a to access these functions, ESC for previous menu      MainMenu  Exit
Save

```

Select ...	To Access the ...	To Configure the ...
Network	<a href="#">Network Interface Options</a> , Table A-1	DSL interface ports.
DSX-1	<a href="#">DSX-1 Interface Options</a> , Table A-4	DSX-1 interface ports (Models 8747 and 8777).
G.703	<a href="#">G.703 Interface Options</a> , Table A-5	G.703 interface ports (Model 8779).
Copy Ports	<a href="#">Copy Ports Options</a> , Table A-6	DSL network and DTE interface ports by copying options from port to port.
System Options	<a href="#">System Options</a> , Table A-7	General system options of the unit.
System Clock	<a href="#">System Clock Options</a> , Table A-8	LTU system clock options.
Cross-Connect	<a href="#">Cross-Connect Mode Options</a> , Table A-9 <a href="#">Assign Time Slots Options</a> , Table A-10	DS1 and DS0 cross-connect ports.
Management and Communication	<a href="#">Telnet Session Options</a> , Table A-11 <a href="#">General SNMP Management Options</a> , Table A-12 <a href="#">SNMP NMS Security Options</a> , Table A-13 <a href="#">SNMP Traps Options</a> , Table A-14	Management support of the unit through SNMP and Telnet.

## Saving Configuration Options

When changes are made to the configuration options through the Configuration Edit/Display branch, the changes must be saved to take effect. Use the Save key or Save Configuration screen.

### ► Procedure

To save configuration options changes:

1. Press Ctrl-a to switch to the screen function key area below the dotted line.
2. Select Save and press Enter.

### NOTE:

When Exit is selected before Save, or Save has been selected from any menu in the Configuration/Edit branch, a Save Configuration screen appears requiring a Yes or No response.

```

main/config/saveprompt
Slot: 4                                     Model: 87xx

                SAVE CONFIGURATION

                Save Changes? No_

                WARNING:

                An answer of "yes" will cause the system
                to reset as if it had been powered off and on!

-----
Ctrl-a to access these functions, ESC for previous menu      MainMenu  Exit

Command Complete

```

If the Telnet Session configuration option is changed, a message displays on the Save Configuration screen warning that an answer of Yes will cause the Telnet session to disconnect. Do not answer Yes unless you are prepared to disconnect.

If the HDSL Mode configuration option is changed, the Save Configuration screen bears the warning that an answer of Yes will cause the system to reset. Do not answer Yes unless you are prepared to reset.

If you select ...	Then ...
Yes	The configuration is saved.
No	The Main Menu appears and changes are not saved.

## Restoring Access to the User Interface

Improper configuration of the unit could render the user interface inaccessible. If this occurs, access can be restored using the management card of the DSLAM.

### ► Procedure

To reset the DSL Card using the management card of the DSLAM:

1. Select *Configuration* → *DSL Cards* → *Reset Slot*.
2. Enter **DSLnn**, where *nn* is the slot number for the DSL card you wish to reset.
3. Enter **Reset**.
4. Enter **Y** if you want to clear NVRAM also, otherwise enter **N**.
5. Enter **Y** at the prompt to confirm.

### **NOTE:**

When you enter **Y**, all data connectivity is interrupted.

## Resetting the Device

If the user interface is functional, and you would like to reset the card without removing the card from the DSLAM, follow this procedure.

### ► Procedure

To reset the card using the Control branch:

1. From the Main Menu, select *Control* → *Reset Device*.
2. The message **Are you sure?** appears.
3. Enter **Yes**.

## Disabling AutoRate

The AutoRate function is controlled from the Network Interface Options screen and allows you to enable or disable AutoRate. The AutoRate option is only available if the unit is configured as an LTU. To access the Network Interface screen, follow this menu selection sequence:

*Main Menu → Configuration → Network*

```
main/config/network
Slot: 4
Port: 1
Model: 87xx

NETWORK INTERFACE OPTIONS

Margin Threshold:      -3db
Excessive Error Rate Threshold: 1E-5
AutoRate              Enable
Max DSL AutoRate      144

-----
Ctrl-a to access these functions, ESC for previous menu
Save                  MainMenu Exit
```

### ► Procedure

The AutoRate option defaults to Enable. To disable AutoRate:

1. Position the cursor in the AutoRate field and press the spacebar.  
The AutoRate field toggles to Disable and the DSL Line Rate field appears.
2. Enter a DSL Line Rate and press Enter.

## Resetting AutoRate

The Reset AutoRate function of the Control branch causes the unit to repeat the AutoRate sequence. The unit attempts to establish the DSL link at the highest rate (or the value of DSL Line Rate, which represents the AutoRate ceiling when AutoRate is enabled). If the link fails, the next lower rate is tried until the link is established.

To access the Reset AutoRate screen, follow this menu selection sequence:

*Main Menu → Control → Reset AutoRate*



---

# Cross-Connecting Ports

# 4

---

## Overview

Configuration of the cross-connections consists of the following steps:

- Determine how the ports will be connected and configured.
- On the Network Interface Options screen, enable if necessary the DSL ports that will be in the cross-connection. The ports are enabled by default.
- On the DSX-1 or G.703 Interface Options screen, enable the DSX-1 or G.703 ports that will be in the cross-connection. For G.703, specify whether Time Slot 16 is used for signaling (voice mode).
- On the System Clock screen, configure the system clock.
- On the Cross-Connect Mode screen:
  - Define all DS1 Bypass ports
  - Define all DS1 Cross-Connect ports
  - Define all DS0 Cross-Connect ports
- On the Assign Time Slots screen, configure the DS0 cross-connections.

This chapter describes the use of the Cross-Connect Mode and Assign Time Slots screens. See Appendix A, *Configuration Options*, for information about configuration options presented on the other screens.

Examples in this chapter show screens for DSX-1 models. The principles of cross-connection are the same for G.703.

### **IMPORTANT:**

**All DSL time slots are available for cross-connect regardless of DSL line rate, but all time slots are available for data transport only if the DSL line rate is the full rate (1552 for DSX-1 or 2064 for G.703). Configure only the time slots intended for use.**

## Determining the Configuration

The Hotwire cross-connect system allows you to connect the DSX-1 or G.703 ports to the DSL ports in a variety of ways:

- **DS1 Bypass mode** – The entire DSX-1 or G.703 interface is connected to the DSL interface.
- **DS1 Cross-Connect mode** – The entire DSX-1 or G.703 interface is connected to the DSL interface through cross-connect circuitry. Ports can be switched through software.
- **DS0 Cross-Connect mode** – Any time slot of any DSX-1 or G.703 interface can be connected to any time slot of any DSL interface. Time slots can be individually allocated for voice or data.

The example in this chapter shows a DS0 cross-connection between DSX-1 Ports 1 and 2. DSX-1 Port 1 is dedicated to voice and Port 2 to data.

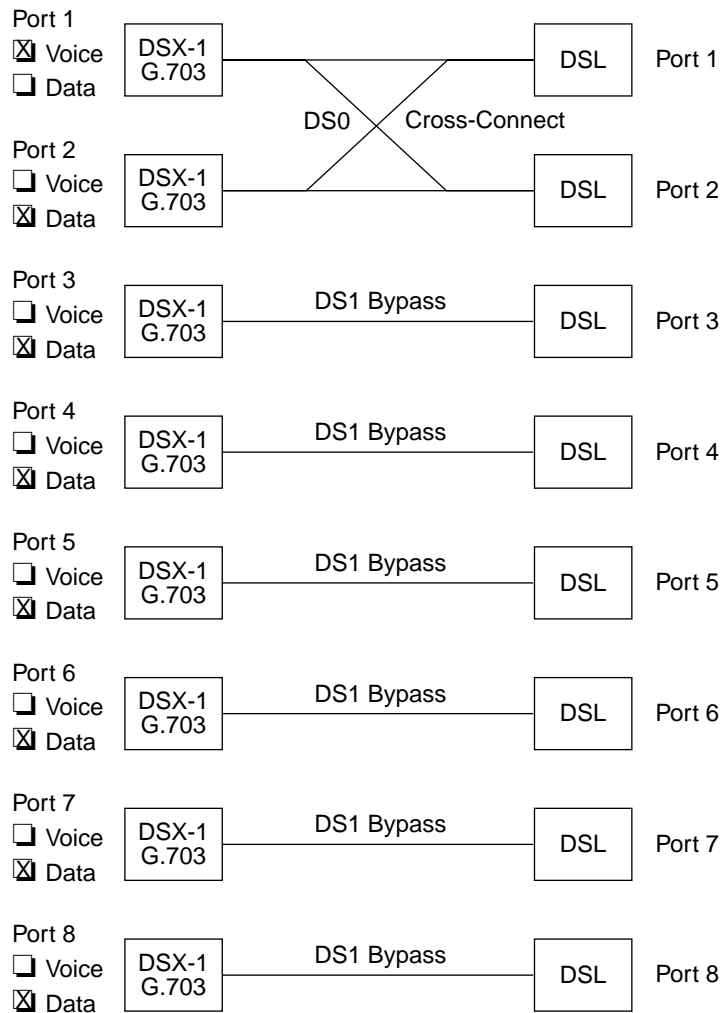

99-16603

**NOTES:**

Although the example in this chapter shows ports dedicated to voice or data, a port can be configured for both voice and data.

In DS0 Cross Connect mode, for G.703 ports using Common Channel Signaling (CCS), you must explicitly configure the cross-connections for Time Slot 16 and related time slots.

You may find it useful to diagram your configuration. Appendix E, *Cross-Connection Worksheets*, contains a skeleton diagram for this purpose. It also contains worksheets for documenting your time slot cross-connections before you begin to configure them.

## Setting the Cross-Connect Modes

To access the Set Cross-Connect Mode screen, follow this menu selection sequence:

*Main Menu* → *Configuration* → *Load Configuration From* → *Cross-Connect* → *Set Cross-Connect Mode*

When the screen is first displayed, all ports are set to DS1 Bypass mode. In this example, Ports 1 and 2 have been changed to **DS0 Cross-connect**, and Ports 3–8 have been changed to **DS1 Bypass**. **Unassigned** appears next to Ports 1 and 2 because time slots associated with the cross-connection have not yet been assigned.

```

main/config/xconnect_mode
Slot: 18                                     Model: 87xx

                                CROSS-CONNECT MODE

                                DSX-1 Port      MODE                DSL Port
                                1      DS0 Cross-connect  Unassigned
                                2      DS0 Cross-connect  Unassigned
                                3      DS1 Bypass         3
                                4      DS1 Bypass         4
                                5      DS1 Bypass         5
                                6      DS1 Bypass         6
                                7      DS1 Bypass         7
                                8      DS1 Bypass         8

                                Assign_DS0s

-----
Ctrl-a to access these functions, ESC for previous menu      MainMenu  Exit
Save                                                         Clear_All

```

## Assigning Time Slots

You may find it helpful to map your cross-connection assignments on a worksheet before configuring them in the unit. In the following example, the worksheet for DSX-1 Port 1, odd-numbered time slots from DSL Ports 1 and 2 are assigned to the time slots of DSX-1 Port 1 and configured for voice.

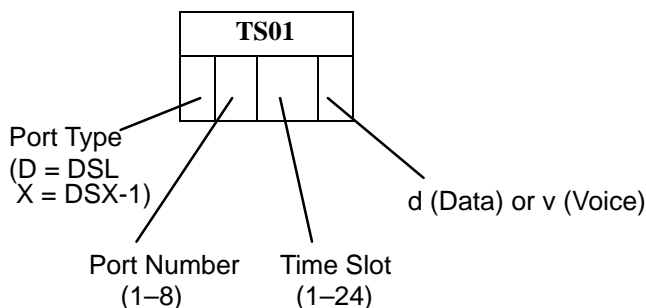

<b>TS01</b>			<b>TS02</b>			<b>TS03</b>			<b>TS04</b>			<b>TS05</b>			<b>TS06</b>			<b>TS07</b>									
D	1	1	v	D	2	1	v	D	1	3	v	D	2	3	v	D	1	5	v	D	2	5	v	D	1	7	v
<b>TS08</b>			<b>TS09</b>			<b>TS10</b>			<b>TS11</b>			<b>TS12</b>			<b>TS13</b>			<b>TS14</b>									
D	2	7	v	D	1	9	v	D	2	9	v	D	1	11	v	D	2	11	v	D	1	13	v	D	2	13	v
<b>TS15</b>			<b>TS16</b>			<b>TS17</b>			<b>TS18</b>			<b>TS19</b>			<b>TS20</b>			<b>TS21</b>									
D	1	15	v	D	2	15	v	D	1	17	v	D	2	17	v	D	1	19	v	D	2	19	v	D	1	21	v
<b>TS22</b>			<b>TS23</b>			<b>TS24</b>																					
D	2	21	v	D	1	23	v	D	2	23	v																

DSX-1 Port 2 is configured for data and is connected to the even-numbered time slots of DSL Ports 1 and 2:

<b>TS01</b>			<b>TS02</b>			<b>TS03</b>			<b>TS04</b>			<b>TS05</b>			<b>TS06</b>			<b>TS07</b>									
D	1	2	d	D	2	2	d	D	1	4	d	D	2	4	d	D	1	6	d	D	2	6	d	D	1	8	d
<b>TS08</b>			<b>TS09</b>			<b>TS10</b>			<b>TS11</b>			<b>TS12</b>			<b>TS13</b>			<b>TS14</b>									
D	2	8	d	D	1	10	d	D	2	10	d	D	1	12	d	D	2	12	d	D	1	14	d	D	2	14	d
<b>TS15</b>			<b>TS16</b>			<b>TS17</b>			<b>TS18</b>			<b>TS19</b>			<b>TS20</b>			<b>TS21</b>									
D	1	16	d	D	2	16	d	D	1	18	d	D	2	18	d	D	1	20	d	D	2	20	d	D	1	22	d
<b>TS22</b>			<b>TS23</b>			<b>TS24</b>																					
D	2	22	d	D	1	24	d	D	2	24	d																

To access the Assign Time Slots screen, follow this menu selection sequence:

*Main Menu* → *Configuration* → *Load Configuration From* →  
*Cross-Connect* → *Assign Time Slots*

When the screen is first displayed, port and time slot assignments are blank. The following example shows the configuration for DSX-1 Port 1, transferred from the worksheet.

```

main/config/cross_connect/timeslot
Slot: 18
Model: 87xx

                                ASSIGN TIME SLOTS
DSX-1 Port: 1

    TS01      TS02      TS03      TS04      TS05      TS06      TS07
D 1 01 v   D 2 01 v   D 1 03 v   D 2 03 v   D 1 05 v   D 2 05 v   D 1 07 v

    TS08      TS09      TS10      TS11      TS12      TS13      TS14
D 2 07 v   D 1 09 v   D 2 09 v   D 1 11 v   D 2 11 v   D 1 13 v   D 2 13 v

    TS15      TS16      TS17      TS18      TS19      TS20      TS21
D 1 15 v   D 2 15 v   D 1 17 v   D 2 17 v   D 1 19 v   D 2 19 v   D 1 21 v

    TS22      TS23      TS24
D 2 21 v   D 1 23 v   D 2 23 v

Key: D = DSL, X = DSX-1
     d = data, v = voice

-----
Ctrl-a to access these functions, ESC for previous menu      MainMenu  Exit
Save                                                         Clear_All

```

The following example shows the configuration for DSX-1 Port 2.

```

main/config/cross_connect/timeslot
Slot: 18
Model: 87xx

                                ASSIGN TIME SLOTS
DSX-1 Port: 2

    TS01      TS02      TS03      TS04      TS05      TS06      TS07
D 1 02 d   D 2 02 d   D 1 04 d   D 2 04 d   D 1 06 d   D 2 06 d   D 1 08 d

    TS08      TS09      TS10      TS11      TS12      TS13      TS14
D 2 08 d   D 1 10 d   D 2 10 d   D 1 12 d   D 2 12 d   D 1 14 d   D 2 14 d

    TS15      TS16      TS17      TS18      TS19      TS20      TS21
D 1 16 d   D 2 16 d   D 1 18 d   D 2 18 d   D 1 20 d   D 2 20 d   D 1 22 d

    TS22      TS23      TS24
D 2 22 d   D 1 24 d   D 2 24 d

Key: D = DSL, X = DSX-1
     d = data, v = voice

-----
Ctrl-a to access these functions, ESC for previous menu      MainMenu  Exit
Save                                                         Clear_All

```

When the Cross-Connect Mode screen is displayed now, 1, 2 appears next to DSX-1 Ports 1 and 2 because time slots associated with the cross-connection have been assigned.

```
main/config/xconnect_mode
slot: 18                                     Model: 87xx

                                CROSS-CONNECT MODE

DSX-1 Port      MODE                DSL Port
  1      DS0 Cross-connect        1,2
  2      DS0 Cross-connect        1,2
  3      DS1 Bypass                3
  4      DS1 Bypass                4
  5      DS1 Bypass                5
  6      DS1 Bypass                6
  7      DS1 Bypass                7
  8      DS1 Bypass                8

                                Assign_DS0s

-----
Ctrl-a to access these functions, ESC for previous menu      MainMenu  Exit
  Save                                                         Clear_All
```

## Selecting an IP Addressing Scheme

Your IP addressing scheme depends in part whether the management card controlling the chassis is running IP Conservative software.

### Configurations Not Running IP Conservative Software

In a configuration not running IP Conservative software, the NTU's network interface IP address is assigned through the peer IP address of the LTU's Network Interface menu.

The termination unit is assigned an IP address and subnet through the DSLAM's *Configuration* → *DSL Cards* → *Set IP Address* menu. Once the address is assigned, you can use the ATI to assign:

- Peer IP addresses to the DSL ports. These addresses are used as the IP addresses of the remote units, and must be in the same subnet as the DSLAM management card. See Table A-1, [Network Interface Options](#), in Appendix A, *Configuration Options*.
- An IP address for each NMS to act as a trap manager. See Table A-14, [SNMP Traps Options](#), in Appendix A, *Configuration Options*.

### All Configurations

The NTU obtains its IP address when the PPP link is established over the EOC.

Use the ATI to assign:

- An IP address for each NMS. See Table A-13, [SNMP NMS Security Options](#), in Appendix A, *Configuration Options*.
- An IP address for the TFTP server you wish to use to upload and download configurations. See [Configuration Loader](#) in Chapter 9, *Transferring Code and Configurations Using TFTP*, and the documentation for your TFTP server.

Review the following information in preparation for selecting an IP addressing scheme.

- Any legal host address is allowed for a given subnet. The address choice within the subnet is arbitrary.
- A single route to a subnet is all that is needed to reach every device on a subnet. The unit's routing table supports a maximum of 20 routes.

## IP Addressing Example

The following diagram shows IP addressing in a typical network. Note that:

- The Peer IP Address refers to the IP address of the unit configured as an NTU.
- The Peer IP Address is assigned by the LTU.

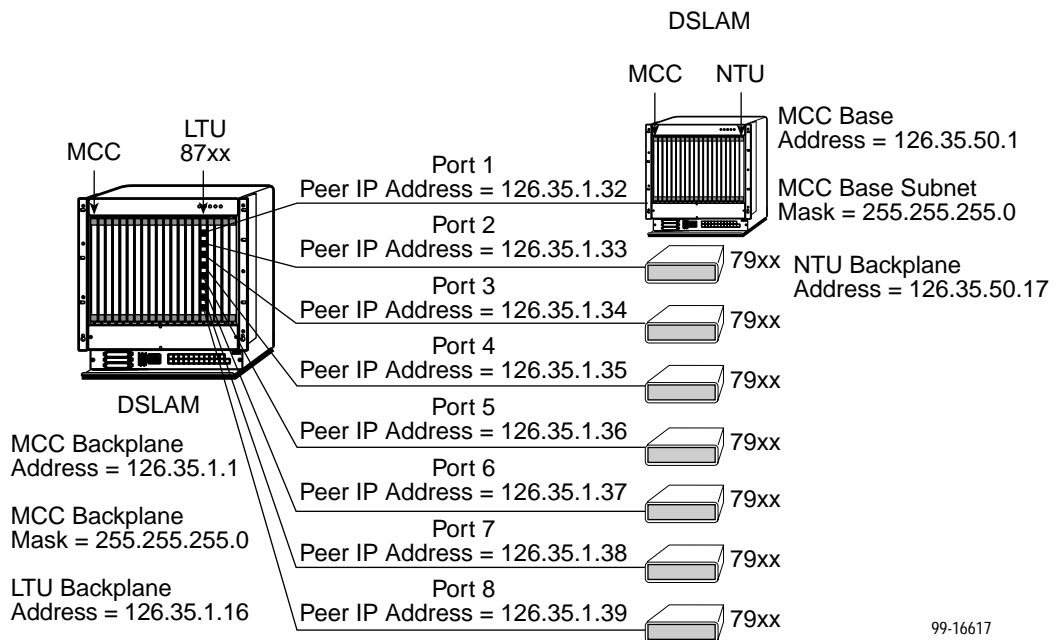

99-16617

### Peer IP Address Assignments



---

# Security

# 6

---

## Overview

The Hotwire 87xx Termination Unit provides several methods of limiting user access to the ATI through option settings. You can:

- Enable the Telnet Login Required option.
- Limit the access by setting a Session Access Level option of Operator for the Telnet Session.
- Disable the access with the Telnet Session option.

See Table A-11, [Telnet Session Options](#), in Appendix A, *Configuration Options*.

## ATI Access Levels

The Hotwire Termination Unit has two access levels: Administrator and Operator. The access level determines what functions are accessible, as shown in Table 6-1.

**Table 6-1. Access Levels**

ATI Access to Menu Functions	Administrator	Operator
Status	Read-Only	Read-Only
Test	Full Access	No Access
Configuration	Full Access	Read-Only
Control	Full Access	No Access

Access levels can be applied to Login IDs and Telnet sessions. When access is through Telnet and a login is required for Telnet, the effective access level is the more restrictive of the Telnet session access level or the login access level. (See Table A-11, [Telnet Session Options](#).)

**When an access level of Operator is applied to Telnet sessions, a Login ID with Administrator authority is effectively reduced to Operator.** It is no longer possible to change configuration options, and full access can be restored only by reloading factory defaults. (See [Restoring Access to the User Interface](#) in Chapter 3, *Initial Startup and Configuration*.)

## Creating a Login

Logins apply to Telnet access directly to the ATI of the Hotwire Termination Unit. The Administer Logins menu option is not presented when you access the unit through the management card of the DSLAM.

Six login ID/password combinations are available. Each Login ID and Password must be unique and include an access level.

### ► Procedure

- To create a login record, follow this menu selection sequence:

*Main Menu → Control → Administer Logins*

```

main/control/admin_logins
Slot: 4
Model: 87xx

ADMINISTER LOGINS
Page 1 of 1

Login ID:      newuser
Access Level:  Administrator

Are You Sure? Yes

-----
Save  PgUp  PgDn          ESC for previous menu      MainMenu  Exit
                          New          Delete

```

- Select New and press Enter. The Login Entry screen is displayed.

```

main/control/admin_logins
Slot: 4
Model: 87xx

LOGIN ENTRY

Login ID:      newuser
Password:      e34t136
Re-enter Password: e34t136
Access Level:  Administrator

WARNING
New logins will not become permanent until saved
through the "ADMINISTER LOGINS" screen!

-----
Ctrl-a to access these functions  ESC for previous menu      MainMenu  Exit
Save  PgUp  PgDn                          New          Delete

```

3. Create the login by entering the following fields. Login IDs and passwords are case-sensitive.

On the Login Entry screen, for the . . .	Enter . . .
Login ID	1 to 10 ASCII printable characters (hex21 through 7E). Blanks are not allowed.
Password	1 to 10 ASCII printable characters that can consist of 0–9, a–z, A–Z, # (pound), . (period), – (dash), and / (slash).
Re-enter Password	1 to 10 ASCII printable characters that can consist of 0–9, a–z, A–Z, # (pound), . (period), – (dash), and / (slash).
Access Level	Administrator, Operator

**NOTE:**

Assign at least one Administrator-level Login ID. Full access is necessary to make configuration option changes and administer logins.

4. Press Ctrl-a to switch to the screen function key area below the dotted line. Select Save and press Enter.
5. When Save is complete, **Command Complete** appears at the bottom of the screen.
6. If additional logins are required, repeat Steps 3 through 5.
7. When all logins are entered, press Esc to return to the Administer Logins screen.
8. Select Save and press Enter.

## Deleting a Login

► **Procedure**

1. To delete a login record, follow this menu selection sequence:  
*Main Menu → Control → Administer Logins*
2. Select PgUp or PgDn and press Enter to page through login pages/records until you find the one to be deleted.
3. Once the correct record is displayed, select De~~l~~ete and press Enter.
4. To complete the delete action, select Save and press Enter.

When the deletion is complete, **Command Complete** appears at the bottom of the screen. The number of login pages/records reflects one less record, and the record following the deleted record appears.

## Controlling SNMP Access

There are three methods for limiting SNMP access.

- Disable the SNMP management option. Refer to Table A-12, [General SNMP Management Options](#), in Appendix A, *Configuration Options*.
- Assign SNMP community names and access types.
- Limit SNMP access through validation of the IP address of each allowed SNMP manager.

### Assigning SNMP Community Names and Access Types

The unit can be managed by an SNMP manager supporting SNMP. The community name must be supplied by an external SNMP manager accessing an object in the MIB.

To define SNMP community names, follow this menu selection sequence:

*Main Menu → Configuration → Load Configuration From → Edit → SNMP → General SNMP Management*

Refer to Table A-12, [General SNMP Management Options](#), to:

- Enable SNMP Management.
- Assign the SNMP community names of the SNMP Managers that are allowed to access the units Management Information Base (MIB).
- Specify Read or Read/Write access for each SNMP community name.

### Limiting SNMP Access through the IP Addresses of the Managers

The unit provides an additional level of security through validation of the IP addresses.

The SNMP Management option must be enabled. To control SNMP access with IP addresses, follow this menu selection sequence:

*Main Menu → Configuration → Management → Security Menu*

Refer to Table A-13, [SNMP NMS Security Options](#). The SNMP access can be limited by:

- Enabling NMS IP address checking.
- Add each IP address and access level.

#### **NOTE:**

Do not change or delete the IP address or access level of the NMS performing the sets or enable IP address checking prior to adding the NMS to the table.



---

# Monitoring and Troubleshooting

# 7

---

## What to Monitor

This chapter presents information on how to diagnose problems, monitor unit status, and assess performance by using the:

- **System and Test Status** screen
  - Highest priority **Health and Status** message on the last line of all screens
  - **Self-test results** messages
  - **Test status** messages
- **Device Messages** displayed at the bottom of any ATI screen
- **Network Error Statistics** screen
- **Network Performance Statistics** screen
- **DSX-1 or G.703 Statistics** screen
- **Display LEDs** screen or **LEDs on the unit's front panel**
- **Troubleshooting** table

## Viewing System and Test Status

To view System and Test Status information, follow this menu selection sequence:

*Main Menu* → *Status* → *System and Test Status*

```

main/status/system
Slot: 2
Model: 87xx

SYSTEM AND TEST STATUS
Page 1 of 1

HEALTH AND STATUS          SELF-TEST RESULTS          TEST STATUS
-----
LOS at Net, Pt n           CPU Failed                 No Test Active
OOF at Net, Pt n           Device Failed              LLB Test Active, Pt n
EER at Net, Pt n           Net DSL Failed, Pt n      RLB Test Active, Pt n
LOS at DSX-1 Pt n         DSX-1 Pt Failed, Pt n    Lamp Test Active
Net Margin Threshold, Pt n Memory Failed              DLB Test Active, Pt n
Device Failed yyyyyyy     Passed
Download Failed

-----
ESC for previous menu      MainMenu  Exit

```

The System and Test Status screen has three sections:

- **Health and Status** – Displays messages in priority order (highest to lowest). Refer to Table 7-1, [Health and Status Messages](#).
- **Self-Test Results** – Results of the Diagnostic test run on the device itself. Refer to Table 7-2, [Self-Test Results Messages](#).
- **Test Status** – Currently active tests. Refer to Table 7-3, [Test Status Messages](#).



## Health and Status Messages

The following messages appear in the first column of the System and Test Status screen. The highest priority Health and Status message also appears on all ATI screens on the bottom right.

**Table 7-1. Health and Status Messages (1 of 3)**

Message	What Message Indicates	What To Do
AIS at DSX-1, Pt <i>n</i>	An AIS (Alarm Indication Signal) is being received by the DSX-1 interface.	<ol style="list-style-type: none"> <li>1. Verify that the unit's line framing and line coding are compatible.</li> <li>2. Contact network provider.</li> </ol>
AIS at G.703, Pt <i>n</i>	An AIS is being received by the G.703 interface.	<ol style="list-style-type: none"> <li>1. Verify that the unit's line framing and line coding are compatible.</li> <li>2. Contact network provider.</li> </ol>
Device Failed <i>yyyyyyyy</i>	An internal error has been detected by the operating software. <i>yyyyyyyy</i> indicates the 8-digit hexadecimal failure code.	<ol style="list-style-type: none"> <li>1. Provide the 8-digit failure code shown (<i>yyyyyyyy</i>) to your service representative.</li> <li>2. Reset the unit to clear the condition and message.</li> </ol>
Download Failed	A firmware download was interrupted.	Repeat the download.
EER at DSX-1, Pt <i>n</i>	An EER condition has been detected on the DSX-1 interface.	<ol style="list-style-type: none"> <li>1. Verify the attached equipment coding is compatible.</li> <li>2. Contact network provider.</li> </ol>
EER at G.703, Pt <i>n</i>	An EER condition has been detected on the G.703 interface.	<ol style="list-style-type: none"> <li>1. Verify that the network cable is securely attached at both ends.</li> <li>2. Verify proper NTU and LTU configuration.</li> <li>3. Contact network provider.</li> </ol>
EER at Net, Pt <i>n</i>	An EER (Excessive Error Rate) condition has been detected on the network interface at Port <i>n</i> . The condition is cleared when the error rate falls below the threshold value currently configured.	<ol style="list-style-type: none"> <li>1. Check the Network Performance Statistics screen for possible line impairments.</li> <li>2. Set the unit to run at a lower DSL line rate.</li> </ol>
Fallback Rate, Pt <i>n</i>	The LTU, set to AutoRate enable, synchronized at a lower rate when the line was restored after an LOS.	Reset AutoRate, or run at a fixed rate.
IP Mismatch, Pt <i>n</i>	The NTU and the LTU are operating in different NMS management modes: one is in IP Conservative mode and one is not.	In a DSLAM-to-DSLAM configuration, use the same software in the management cards of both DSLAMs.

**Table 7-1. Health and Status Messages (2 of 3)**

Message	What Message Indicates	What To Do
LOF at DSX-1, Pt <i>n</i>	An LOF (Loss Of Frame) condition has been detected on the DSX-1 interface. LOF is declared when an OOF state exists longer than 2.5 seconds.	<ol style="list-style-type: none"> <li>1. Verify that the network cable is securely attached at both ends.</li> <li>2. Contact network provider.</li> </ol>
LOF at G.703, Pt <i>n</i>	An LOF condition has been detected on the G.703 interface. LOF is declared when any three consecutive frame synchronization bits are incorrect, frames not containing the frame alignment signal are received with an error three times consecutively, or, for CRC-4 framing, CRC multiframe bit alignment fails.	<ol style="list-style-type: none"> <li>1. Verify that the network cable is securely attached at both ends.</li> <li>2. Verify that the units line framing and line coding are compatible.</li> <li>3. Contact network provider.</li> </ol>
LOS at DSX-1, Pt <i>n</i>	An LOS (Loss Of Signal) condition has been detected on the DSX-1 interface. No signal is being received on Port <i>n</i> . LOS is declared when 175 consecutive zeros are received.	<ol style="list-style-type: none"> <li>1. Verify that the network cable is securely attached at both ends.</li> <li>2. Contact network provider.</li> </ol>
LOS at G.703, Pt <i>n</i>	An LOS condition has been detected on the G.703 interface. No signal is being received on Port <i>n</i> . LOS is declared when 175 consecutive pulse transmissions are received with no pulse transitions.	<ol style="list-style-type: none"> <li>1. Verify that the network cable is securely attached at both ends.</li> <li>2. Contact network provider.</li> </ol>
LOS at Net, Pt <i>n</i>	An LOS (Loss Of Signal) condition has been detected on the network interface. No signal is being received on Port <i>n</i> , possibly due to a local network problem.	<ol style="list-style-type: none"> <li>1. Verify that the network cable is securely attached at both ends.</li> <li>2. Contact network provider.</li> </ol>
Mismatch Rate, Pt <i>n</i>	The LTU, set to a fixed DSL rate, is attempting to operate at a rate the NTU is not capable of.	Set the LTU to a compatible rate or replace the NTU.
Net Margin Threshold, Pt <i>n</i>	The signal-to-noise margin has exceeded the configured threshold.	<ol style="list-style-type: none"> <li>1. Check the Network Performance Statistics screen for possible line impairments.</li> <li>2. Set the unit to run at a lower DSL line rate.</li> <li>3. Contact network provider.</li> </ol>

**Table 7-1. Health and Status Messages (3 of 3)**

Message	What Message Indicates	What To Do
NTU TS16 Not Supported	The LTU is configured for TS16 signaling and the NTU is not configured to support TS16 signaling.	<ol style="list-style-type: none"> <li>1. Verify endpoint is a G.703 product. EIA-530-A products do not support signaling.</li> <li>2. Replace endpoint or reconfigure TS16 to data.</li> </ol>
NTU/LTU Mismatch, Pt <i>n</i>	The NTU is not configured compatibly with the LTU.	Configure units to match.
OOF at Net, Pt <i>n</i>	An Out Of Frame (OOF) condition has been detected. An OOF condition is declared when 2 out of 4 frame synchronization bits are in error.	<ol style="list-style-type: none"> <li>1. Check the Transmit Clock Source configuration options. Do not set both the local and remote unit to Internal, External, or Loop timing.</li> <li>2. Set the unit to run at a lower DSL line rate.</li> <li>3. Contact network provider.</li> </ol>
Primary Clock Failed, Pt <i>n</i>	A failure has occurred in the primary clock source for the DSX-1 or G.703 port.	<ol style="list-style-type: none"> <li>1. Verify that the network cable is securely attached at both ends.</li> <li>2. Contact network provider.</li> </ol>
Primary System Clock Failed	A failure has occurred in the clock common to all cross-connect circuitry.	Contact your service representative.
RAI at G.703, Pt <i>n</i>	An RAI (Remote Alarm Indication) signal is being received by the G.703 interface.	<ol style="list-style-type: none"> <li>1. Check the status of the upstream device.</li> <li>2. Verify proper NTU and LTU configuration.</li> </ol>
Secondary System Clock Failed	A failure has occurred in the fallback clock for the system clock.	Contact your service representative.
System Operational	There are no problems detected.	
Yellow Alarm at DSX-1, Pt <i>n</i>	A Yellow Alarm Indication signal is being received by the DSX-1 interface.	<ol style="list-style-type: none"> <li>1. Verify that the unit's line framing and line coding are compatible.</li> <li>2. Contact network provider.</li> </ol>

## Self-Test Results Messages

The results of the last power-on or reset self-test appear in the middle column of the System and Test Status screen.

**Table 7-2. Self-Test Results Messages (1 of 2)**

Message	What Message Indicates	What To Do
CPU Fail	The Central Processing Unit failed internal testing.	<ol style="list-style-type: none"> <li>1. Reset the unit and try again.</li> <li>2. Call your service representative for assistance.</li> </ol>
CPU CPLD Fail	The Complex Programmable Logic Device serving the Central Processing Unit failed.	
Data Path Fail, Pt <i>n</i>	The port shown failed to loop data on the full data path test.	
DeviceFailed	One or more of the unit's integrated circuits has failed device-level testing.	
DSL Framer <i>x</i> Fail	The DSL framer for Ports 1–4 (Framer A) or 5–8 (Framer B) failed.	
DSL xcvr Fail, Pt <i>n</i>	The DSL transceiver failed on Port <i>n</i> .	
DSX-1 Failed, Pt <i>n</i>	The unit failed to internally loop data on the DSX-1 Port <i>n</i> .	
DTE Framer <i>x</i> Fail	The DTE framer for Ports 1–4 (Framer A) or 5–8 (Framer B) failed.	
DTE LIU <i>x</i> Fail	The DTE Line Interface Unit for Ports 1–2 (LIU A), 3–4 (LIU B), 5–6 (LIU C), or 7–8 (LIU D) failed.	
EEPROM Fail	The unit failed Electrically Erasable Programmable Read-Only Memory verification.	
Failure xxxxxxx	An internal failure occurred. (xxxxxxx represents an 8-digit hexadecimal failure code for use by service personnel.)	Record the failure code and contact your service representative.
FPGA Failed	The Field Programmable Gate Array serving all ports failed.	<ol style="list-style-type: none"> <li>1. Reset the unit and try again.</li> <li>2. Call your service representative for assistance.</li> </ol>
G.703 Failed, Pt 1	The unit failed to loop data on the G.703 on Port <i>n</i> .	
Memory Test <i>n</i> Fail	The unit failed memory data verification (Test 1) or memory address verification (Test 2).	
Passed	No errors were detected.	N/A

**Table 7-2. Self-Test Results Messages (2 of 2)**

Message	What Message Indicates	What To Do
PLD Failure	An error was detected in a Programmable Logic Device.	1. Reset the unit and try again. 2. Call your service representative for assistance.
TSI CPLD Fail	The Complex Programmable Logic Device serving the Timeslot Interchanger failed.	1. Reset the unit and try again. 2. Call your service representative for assistance.
TSI Fail	The Timeslot Interchanger failed.	

## Test Status Messages

The **Test Status messages** in the following table appear in the right column of the System and Test Status screen.

**Table 7-3. Test Status Messages**

Test Status Message	Meaning
511 Test Active, Pt <i>n</i>	A 511 Test and Monitor is active on the DSL Port <i>n</i> network interface.
DLB Test Active, Pt <i>n</i>	A Data Terminal Loopback test is active on Port <i>n</i> .
Lamp Test Active	The Lamp Test is active, causing the LEDs on the front panel to light.
LLB Test Active, Pt <i>n</i>	A network Line Loopback test is active on Port <i>n</i> .
No Test Active	No tests are currently running.
Remote LLB Dn Active, Pt <i>n</i>	A Remote Line Loopback Down command is being sent.
Remote LLB Up Active, Pt <i>n</i>	A Remote Line Loopback Up command is being sent.
RLB Test Active, Pt <i>n</i>	A network Repeater Loopback test is active on Port <i>n</i> .
Telco LLB Active, Pt <i>n</i>	A Telco-initiated Line Loopback is active on the specified DSX-1 port.
Telco PLB Active, Pt <i>n</i>	A Telco-initiated Payload Loopback is active on the specified DSX-1 port.

## Device Messages

The Device Messages in Table 7-4, listed in alphabetical order, may appear in the messages area at the bottom of the ATI screens.

**Table 7-4. Device Messages (1 of 2)**

Device Message	What Message Indicates	What To Do
0.0.0.0 is an invalid IP address	An IP address of all zeros was entered.	Enter a valid, non-zero IP address.
Access level is Operator. Configuration is read-only.	The operator requested that configuration options be loaded, but does not have authority to edit them.	If configuration options are to be edited, use a Login ID that has Administrator authority.
Cannot Save – no Login IDs with Access Administrator	All of the login IDs being saved have an access level below Administrator.	Change the access level of at least one Login ID to Administrator so that configuration changes can be made. (Operator-level users cannot make configuration changes.) Save the Login IDs.
Command Complete	Action requested has successfully completed.	No action needed.
Invalid Character (x)	A nonprintable ASCII character (x) has been entered.	Re-enter information using valid characters.
Invalid Password	Login is required and an incorrect password was entered; access is denied.	<ul style="list-style-type: none"> <li>■ Try again.</li> <li>■ Contact your system administrator to verify your password.</li> </ul>
Invalid – Send Pattern Already Active	A pattern test was already in progress when the Start field was selected.	<ul style="list-style-type: none"> <li>■ Allow test to continue.</li> <li>■ Select another test.</li> <li>■ Stop the test.</li> </ul>
Invalid – [Test] Already Active	The described test was already in progress when another selection was made.	<ul style="list-style-type: none"> <li>■ Allow test to continue.</li> <li>■ Select another test.</li> <li>■ Stop the test.</li> </ul>
Invalid Test Combination	A loopback or pattern test was in progress when Start was selected to start another test, or was active on the same or another interface when Start was selected.	<ul style="list-style-type: none"> <li>■ Wait until other test ends and message clears.</li> <li>■ Abort all tests from the Test menu screen.</li> <li>■ Stop the test from the same screen the test was started from.</li> </ul>
IP address not in MCC subnet <i>nnn.nnn.nnn.nnn</i>	The Peer IP address specified is not in the same subnet as the MCC.	Enter an IP address that is in the same subnet as the MCC.

**Table 7-4. Device Messages (2 of 2)**

<b>Device Message</b>	<b>What Message Indicates</b>	<b>What To Do</b>
Limit of six Login IDs reached	An attempt to enter a new login ID was made, and the limit of six login/password combinations has been reached.	<ol style="list-style-type: none"> <li>1. Delete another login/password combination.</li> <li>2. Re-enter the new login ID.</li> </ol>
No Security Records to Delete	Delete was selected from the Administer Login screen, and no security records had been defined.	<ul style="list-style-type: none"> <li>■ No action needed.</li> <li>■ Enter a security record.</li> </ul>
Password Matching Error – Re-enter Password	Password entered in the Re-enter Password field of the Administer Logins screen does not match what was entered in the Password field.	<ul style="list-style-type: none"> <li>■ Try again.</li> <li>■ Contact your system administrator to verify your password.</li> </ul>
Please Wait	Command takes longer than 5 seconds.	Wait until message clears.
Test Active	A test is running and no higher priority health and status messages exist.	<ul style="list-style-type: none"> <li>■ Contact service provider if test initiated by the network.</li> <li>■ Wait until the other test ends and message clears.</li> <li>■ Cancel all tests from the Test screen.</li> <li>■ Stop the test from the same screen the test was started from.</li> </ul>

## Viewing Network Error Statistics

The unit maintains error statistics on the network DSL interface for each port. Port 1 is the default screen selection.

Statistics are maintained for up to 96 15-minute intervals (24 hours).

To view the Network Error Statistics, follow this menu selection sequence:

*Main Menu* → *Status* → *Performance* → *Network Error Statistics*

```

main/status/performance/net_error
Slot: 4:                                     Model: 87xx
Port: 2                                     NETWORK ERROR STATISTICS

Current Interval Timer: 002                 Error Events Counter: 0034
-----
      ---ES---      ---SES---      --FEBE--      -Complete-
      Near Far      Near Far      Near Far      Near Far
Current Int: 000 000      000 000      000 000      Yes No
Interval 01 000 000      000 000      000 000      Yes Yes
Interval 02 000 000      000 000      000 000      Yes Yes
Interval 03 000 000      000 000      000 000      Yes Yes
Interval 04 000 000      000 000      000 000      Yes Yes
Interval 05 000 000      000 000      000 000      Yes Yes
Interval 06 000 000      000 000      000 000      Yes Yes
Interval 07 000 000      000 000      000 000      Yes Yes

Worst Interval: 24 09      14 08      18 18
Near Tot(valid): 00010      00000      00000
Far Tot (valid): 00010      00000      00000
-----
Ctrl-a to access these functions, ESC for previous menu      MainMenu  Exit
PgUp      PgDn      ClrNear      ClrFar

```

Select a port 1–2 to view error statistics for the port. The default port is 1. Use the virtual function keys to page through the intervals and clear statistics.

Network Error Statistics are collected for all ports for:

- **ES (Errored Seconds):** Seconds during which one or more ESF error events occurred.
- **SES (Severely Errored Seconds):** Seconds during which more than 320 cyclic redundancy check (CRC) error events or at least one Out of Frame (OOF) event occurred.
- **FEBE (Far-End Block Errors):** Errors reported by the remote equipment.
- **Complete:** Whether the interval register contains data for all 900 seconds of the interval.

Use the virtual function keys to page through the intervals and clear statistics.



This Field . . .	Contains . . .
Current Interval Timer	The number of seconds which have elapsed in the current 15-minute interval. Maximum value is 900 seconds (15 minutes). This counter is reset every 15 minutes.
Error Events Counter	A running total of CRC errors. Range 0–65535. This counter is reset when the near-end data is cleared.
Current Int	Performance data for the current 15-minute interval.
Interval xx	Historical performance data for up to 96 15-minute intervals (24 hours).
Worst Interval	The number of the interval with the worst (highest) performance data for both the near-end and far-end statistics. If two or more intervals are equal, the oldest interval is displayed.
Near and Far TOT	A running total of the near-end and far-end performance statistics.

## Viewing Network Performance Statistics

Network performance statistics allow you to monitor the current status of the network DSL operations. Performance statistics can assist you in determining the duration of specific conditions and provide a historical context for problem detection and analysis.

Statistics are maintained for up to 96 15-minute intervals (24 hours).

To view the Network Performance Statistics, follow this menu selection sequence:

*Main Menu → Status → Performance → Network Performance Statistics*

```

main/status/performance/net_perf
Slot: 4:
Port: 2
Model: 87xx
NETWORK PERFORMANCE STATISTICS
Current Interval Timer: 002
Payload Rate: 1536 kbps
DSL Line Rate: 1552 kbps
-----
--Mrgn--      --XmtPw-      --RxGn--      -Complete-
Near Far      Near Far      Near Far      Near Far
Current Int: +02 +01      +03 +03      +02 +02      Yes Yes
Interval 01 +02 +02      +03 +03      +02 +02      Yes No
Interval 02 +02 +01      +03 +03      +02 +02      Yes Yes
Interval 03 +02 +01      +03 +03      +02 +02      Yes Yes
Interval 04 +02 +01      +03 +03      +02 +02      Yes Yes
Interval 05 +02 +01      +03 +03      +02 +02      Yes Yes
Interval 06 +02 +01      +03 +03      +02 +02      Yes Yes
Interval 07 +02 +01      +03 +03      +02 +02      Yes Yes
-----
Ctrl-a to access these functions, ESC for previous menu      MainMenu  Exit
PgUp      PgDn

```

Select a port (1–2) to view performance statistics for the port. The default port is 1. Use the virtual function keys to scroll through the intervals

Use the virtual function keys to scroll through the intervals and clear statistics.

Network Performance Statistics are collected for all ports for:

- **Mrgn:** Signal to Noise Ratio (SNR) Margin, the amount (in dB) that the Receive signal has exceeded the value needed to maintain a Bit Error Rate (BER) of  $10^{-7}$  or better.
- **XmtPw:** The transmit power level.
- **RxGn:** The receiver gain level.
- **Complete:** Whether the interval register contains data for all 900 seconds of the interval.

This Field . . .	Contains . . .
Current Interval Timer	The number of seconds which have elapsed in the current 15-minute interval. Maximum value is 900 seconds (15 minutes). This counter is reset every 15 minutes.
DSL Line Rate	The rate of the DSL line.
Payload Rate	The rate of data transfer.
Current Int	Performance data for the current 15-minute interval.
Interval xx	Historical performance data for up to 96 15-minute intervals (24 hours).

## Viewing DSX-1 Performance Statistics

DSX-1 performance statistics allow you to monitor the current status of the DSX-1 interface operations when ESF framing is selected. Performance statistics can assist you in determining the duration of specific conditions and provide a historical context for problem detection and analysis. Statistics are maintained for up to 96 15-minute intervals (24 hours).

To view the Network Performance Statistics, follow this menu selection sequence:

*Main Menu → Status → Performance → DSX-1 Performance Statistics*

```

main/status/performance/DSX-1
Slot: 4                                     Model: 87xx
Port: 2                                     DSX-1 PERFORMANCE STATISTICS

Current Interval Timer: 2                   Error Events Counter: 0000
-----
--ES--  --UAS--  --SES--  --BES--  --CSS--  --LOFC-  -Status-
Current Int:    000    000    000    000    000    000    Y
Interval 01    000    000    000    000    000    000    none
Interval 02    000    000    000    000    000    000    none
Interval 03    000    000    000    000    000    000    none
Interval 04    000    000    000    000    000    000    none
Interval 05    000    000    000    000    000    000    none
Interval 06    000    000    000    000    000    000    none
Interval 07    000    000    000    000    000    000    none

Worst Interval:  24      14      14      09      18      12
Tot (valid 96): 00010   00000   00000   00000   0020   0000
-----
Ctrl-a to access these functions, ESC for previous menu      MainMenu  Exit
PgUp      PgDn      ClrStats

```

Select PgUp or PgDn to view the next or previous seven intervals, select ClrStats to clear all statistics to zero.

DSX-1 Performance Statistics are collected for:

- **ES (Errored Seconds):** Seconds during which one or more error events occurred.
- **UAS (Unavailable Seconds):** Seconds during which service is unavailable. UAS is received at the start of 10 consecutive SES and cleared at the start of 10 seconds with no SES.
- **SES (Severely Errored Seconds):** Seconds during which 320 or more cyclic redundancy check (CRC) error events or at least one Out of Frame (OOF) event occurred.
- **BES (Bursty Errored Seconds):** Contains the number of bursty errored seconds for the current interval. A bursty errored second is any second with more than one but less than 320 CRC errors.
- **CSS (Controlled Slip Seconds):** Seconds during which one or more controlled slips (as defined in TR 54016) occurred.

- **LOFC (Loss of Frame Count):** Contains the number of times that an LOF is declared.
- **Status:** Contains the contents of the status events register. The status events register maintains a history of specific events that have occurred during an interval. Values include:
  - **Y:** Remote alarm indication signal (yellow alarm) received at the DSX-1 interface
  - **L:** Loss of signal detected at the DSX-1 interface
  - **E:** Excessive error rate threshold exceeded
  - **F:** Frame synchronization bit error detected
  - **V:** Line code violation detected
  - **None:** No significant events have occurred

This Field . . .	Contains . . .
Current Interval Timer	The number of seconds which have elapsed in the current 15-minute interval. Maximum value is 900 seconds (15 minutes). This counter is reset every 15 minutes.
Error Events Counter	A running total of CRC and OOF events. Total range = 0–65535. This counter is reset when the statistics are cleared.
Current Int	Performance data for the current 15-minute interval.
Interval xx	Historical performance data for up to 96 15-minute intervals (24 hours) where the value of xx is from 01 to 96.
Worst Interval	Identifies the interval during which the most error events were detected.

## Viewing G.703 Performance Statistics

G.703 performance statistics allow you to monitor the current status of the network DSL operations. Performance statistics can assist you in determining the duration of specific conditions and provide a historical context for problem detection and analysis.

Statistics are maintained for up to 96 15-minute intervals (24 hours).

To view the G.703 Performance Statistics, follow this menu selection sequence:

*Main Menu* → *Status* → *Performance* → *G.703 Statistics*

```

main/status/performance/G.703
Slot: 4
Port: 2
Model: 87xx

G.703 PERFORMANCE STATISTICS

Current Interval Timer: 004
Error Events Counter: 012

-----
--ES-- --UAS-- --SES-- --BES-- --CSS-- -LOF- -Status-
Current Int: 000 000 000 000 000 000 Y
Interval 01 000 000 000 000 000 000 none
Interval 02 000 000 000 000 000 000 none
Interval 03 000 000 000 000 000 000 none
Interval 04 000 000 000 000 000 000 none
Interval 05 000 000 000 000 000 000 none
Interval 06 000 000 000 000 000 000 none
Interval 07 000 000 000 000 000 000 none

Worst Interval: 24 14 14 09 18 12
Tot (valid 96): 00010 00000 00000 00000 0020 0000

-----
Ctrl-a to access these functions, ESC for previous menu
PgUp PgDn ClrStats MainMenu Exit

```

Select a port to view the performance statistics. The default port is 1.

G.703 Performance Statistics are collected for all ports for:

- **ES (Errored Seconds):** Seconds during which one or more error events occurred.
- **UAS (Unavailable Seconds):** Seconds during which service is unavailable. UAS is received at the start of 10 consecutive SES and cleared at the start of 10 seconds with no SES.
- **SES (Severely Errored Seconds):** Seconds during which 805 or more cyclic redundancy check (CRC) error events, 16 or more FAS errors, or at least one Out of Frame (OOF) event occurred.

- **BES (Bursty Errored Seconds):** Contains the number of bursty errored seconds for the current interval. A bursty errored second is any second with more than one but less than 805 CRC errors (CRC Mode) or more than one but less than 16 FAS errors (non-CRC mode).
- **CSS (Controlled Slip Seconds):** Seconds during which one or more controlled slips (as defined in TR 54016) occurred.
- **LOF (Loss of Frame Seconds):** Contains the number of seconds that contain one or more LOF events.
- **Status:** Contains the contents of the status events register. The status events register maintains a history of specific events that have occurred during an interval. Values include:
  - **Y:** Remote alarm indication signal received at the G.703 interface
  - **L:** Loss of signal detected at the G.703 interface
  - **E:** Excessive error rate threshold exceeded
  - **F:** Frame synchronization bit error detected
  - **V:** Line code violation detected
  - **None:** No significant events have occurred

Use the virtual function keys to page through the intervals and clear statistics.

This Field . . .	Contains . . .
Current Interval Timer	The number of seconds which have elapsed in the current 15-minute interval. Maximum value is 900 seconds (15 minutes). This counter is reset every 15 minutes.
Error Events Counter	A running total of CRC errors. Range 0–65535. This counter is reset when the statistics are cleared.
Current Int	Performance data for the current 15-minute interval.
Interval xx	Historical performance data for up to 96 15-minute intervals (24 hours).
Worst Interval	The number of the interval with the worst (highest) performance data statistics. If two or more intervals are equal, the oldest interval is displayed.
Tot	A running total of the performance statistics.

## Viewing LED Status

The unit LEDs can be viewed on the Display LEDs Status screen, available locally and remotely.

The LEDs are organized into three groups:

- **System** LEDs display the status of the unit
- **DSX-1 or G.703** LEDs provide the status of the DTE interface
- **DSL Loop** LEDs display the activity on the DSL network

To view the Display LEDs status screen, follow this menu selection sequence:

*Main Menu → Status → Display LEDs*

```

main/status/leds
Slot: 18                                     Model: 87xx

                                DISPLAY LEDs

                                SYSTEM          DSX-1|G.703 Port    DSL LOOP
-----
Alarm Off                       P1:Link Up          P1:Link Up
Test Off                         P2:Link Up          P2:Link Up
                                P3:Link Up          P3:Disabledp
                                P4:Link Up          P4:Link Up
                                P5:Link Up          P5:Link Up
                                P6:Link Up          P6:Link Up
                                P7:Link Up          P7:Link Up
                                P8:Link Up          P8:Link Up

-----
                                ESC for previous menu    MainMenu  Exit

```

The LED status display screen is updated every 5 seconds.

**Table 7-5** shows the meaning of the possible values for each LED represented.

**Table 7-5. Display LEDs Screen**

Type	Label	Value is . . .	Indicating . . .
SYSTEM	Alarm	On	Device failure, Power-On Self-Test (POST) failure, ports inoperable or unable to train.
		Off	No alarms.
	Test	On	Loopback test or 511 test pattern in progress.
		Off	No tests.
DSX-1 PORT	P1 through P8	Link Up	Recoverable signal present on the DSX-1 network.
		Link Down	No signal on the port.
		LOF	The port has a Loss of Frame alignment.
		EER	The port has an Excessive Error Rate condition.
		Yellow	The port received a Yellow Alarm.
		AIS	The port received an Alarm Indication Signal.
		Disabled	The port has been administratively disabled.
G.703 PORT	P1 through P8	Link Up	Recoverable signal present on the G.703 network.
		Link Down	No signal on the port.
		LOF	The port has a Loss of Frame alignment.
		EER	The port has an Excessive Error Rate condition.
		RAI	The port received a Remote Alarm Indication.
		AIS	The port received an Alarm Indication Signal.
		Disabled	The port has been administratively disabled.
DSL LOOP	P1 through P8	Link Up	DSL link is up.
		Link Down	DSL link is down.
		Startup	DSL training in progress.
		OOF	Out Of Frame condition.
		Disabled	The port has been administratively disabled.



## Front Panel LEDs

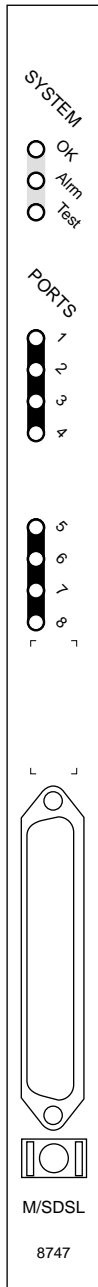

The following table describes the meaning and states of the LEDs on the faceplate. PORTS LEDs represent the DTE or DSL ports depending on the Port LEDs selection on the Control screen.

Type	LED	LED is . . .*	Indicating . . .
SYSTEM	OK (Green)	On	Normal operation; card functioning normally.
		Off	No power to card, or card failure.
		Slow cycling	Unit is in minimum mode and a download is required.
	Alarm (Amber)	On	Device failure, Power-On Self-Test (POST) is not complete, or an alarm was reported on a DSL, DSX-1, or G.703 port.
		Off	No alarms.
		Test (Amber)	On
SYSTEM	Test (Amber)	Slow cycling	POST in progress.
		Off	No tests.
		Off	No tests.
PORTS (when DSX-1 or G.703 selected)	1, 2, 3, 4, 5, 6, 7, 8 (Green)	On	Recoverable signal present on the DSX-1 or G.703 network.
		Slow cycling	Yellow Alarm Indication (DSX-1) or Remote Alarm Indication (G.703) present.
		Fast cycling	An OOF, LOF, EER, or AIS condition exists.
		Off	No signal on the port.
PORTS (when DSL selected)	1, 2, 3, 4, 5, 6, 7, 8 (Green)	On	DSL link is up.
		Slow cycling	DSL training in progress.
		Fast cycling	OOF condition.
		Off	DSL link is down.
* Slow Cycling: LED turns off and on in equal duration once per second.			
Fast Cycling: LED turns off and on in equal duration 5 times per second.			
Pulsing: LED turns off momentarily once per second.			

99-16606

## Changing the Meaning of the PORTS LEDs

The PORTS LEDs on the front panel represent the status of the DSL network or DTE ports depending on the Port LEDs configuration option. The LED display can also be selected at any time through the Control branch.

### ► Procedure

To change the meaning of the PORTS LEDs using the Control branch:

1. From the Main Menu, select Control.
2. Move the cursor to the Port LEDs entry.
3. Toggle the selection using the spacebar.
4. Press Enter.

## Troubleshooting

The Hotwire Termination Unit is designed to provide you with many years of trouble-free service. If a problem occurs, however, refer to Table 7-6 for possible solutions. If an error message is displayed under Health and Status on the System and Test Status screen, refer to Table 7-1, [Health and Status Messages](#), for recommended action.

**Table 7-6. Troubleshooting (1 of 2)**

Symptom	Possible Cause	Solutions
Alarm LED is on.	A system failure has occurred.	Refer to Table 7-1, <a href="#">Health and Status Messages</a> , for recommended action.
Cannot access the unit via the ATI.	The terminal is not set up for the correct rate or data format, or the unit is configured so it prevents access.	<ul style="list-style-type: none"> <li>■ Check the cable and connections.</li> <li>■ Ensure that the unit is configured properly in the DSLAM. Verify its IP address.</li> <li>■ Reset the unit.</li> </ul>
Device Fail appears on the System and Test Status screen under Self-Test results.	The unit detects an internal hardware failure.	<ul style="list-style-type: none"> <li>■ Reset the unit.</li> <li>■ Contact your service representative.</li> </ul>
Power-On Self-Test fails. Only Alarm LED is on after power-on.	The unit has detected an internal hardware failure.	
No power, or the LEDs are not lit.	The unit is not properly seated in the DSLAM.	Verify that the unit is properly inserted.
	There is no power to the DSLAM.	Verify that the DSLAM has power.
An LED is not lit.	LED is out.	Run the Lamp Test. If the LED in question does not flash with the other LEDs, then contact your service representative.
Not receiving data.	<ul style="list-style-type: none"> <li>■ The network or DTE port cables are not connected (check front panel LEDs for more information).</li> <li>■ A test is being executed on the unit (check the TEST LED on the front panel).</li> <li>■ The far-end device is offline.</li> </ul>	<ul style="list-style-type: none"> <li>■ Check network and DTE port cables.</li> <li>■ Check Health and Status menu.</li> <li>■ Run Loopback tests. Refer to Chapter 8, <a href="#">Testing</a>.</li> <li>■ Stop the test or wait for the test to end.</li> <li>■ Make sure the far-end device is on.</li> </ul>

**Table 7-6. Troubleshooting (2 of 2)**

<b>Symptom</b>	<b>Possible Cause</b>	<b>Solutions</b>
Not receiving data on one or more time slots.	The DSL line rate does not support the number of DSL time slots defined.	Match the number of DSL time slots to the DSL line rate. See <a href="#">Tables A-2</a> and <a href="#">A-3</a> in Appendix A, <i>Configuration Options</i> , for information about maximum payload rates for different DSL line rates.
	The associated port is administratively disabled.	Check the Display LEDs screen to determine if the port is disabled. Enable the port if necessary using the Network, DSX-1, or G.703 Interface Options screen.

---

# Testing

# 8

---

## Accessing the Test Menu

From the Test menu, you can run network tests, data port tests, and a front panel lamp test.

To access the Test menu, follow this menu selection sequence:

*Main Menu → Test*

```
main/test                                     Model: 87xx
slot: 18

                                TEST

Network & DSX-1 | G.703 Tests
Device Tests
Abort All Tests

-----
Ctrl-a to access these functions, ESC for previous menu      MainMenu  Exit
```

Select ...	To ...
Network & DSX-1 Tests Network & G.703 Tests	Start and stop tests on the DSX-1, G.703, or network interface.
Device Tests	Start and stop the Lamp Test.
Abort All Tests	To abort current tests excluding network-initiated loopback tests. An aborted test may continue to run for a few seconds as the abort command is sent to the remote end and processed.

## Running Network Tests

Network tests require the participation of your network service provider. To access the Network Tests screen, follow this menu selection sequence:

*Main Menu → Test → Network & DSX-1 Tests*

– or –

*Main Menu → Test → Network & G.703 Tests*

```

main/test/network_DSX1
Slot: 18
Port: 1
Model: 87xx

                                NETWORK & DSX-1 TESTS

Test                               Command  Status   Results
-----
Local Loopbacks
  Network Line Loopback:           Start   Inactive  00:00:00
  DSX-1 Repeater Loopback:         Start   Inactive  00:00:00
  DSX-1 DTE Loopback:              Start   Inactive  00:00:00

Remote Loopbacks
  Send Line Loopback: Down       Send    Inactive  00:00:00

Pattern Tests
  Send and Monitor 511             Stop    Active    10:12:42 - Errors 99999+

-----
Ctrl-a to access these functions, ESC for previous menu   MainMenu  Exit
ResetMon

```

```

main/test/network_G703
Slot: 4
Port: 2
Model: 87xx

                                NETWORK & G.703 TESTS

Test                               Command  Status   Results
-----
Local Loopbacks
  Network Line Loopback:           Start   Inactive  00:00:00
  G.703 Repeater Loopback:         Start   Inactive  00:00:00
  G.703 DTE Loopback:              Start   Inactive  00:00:00

Network Remote Loopbacks
  Send Line Loopback: Down       Send    Inactive  00:00:00

Network Pattern Tests
  Send and Monitor 511             Stop    Active    11:37:52 - Errors 99999+

-----
Ctrl-a to access these functions, ESC for previous menu   MainMenu  Exit
ResetMon

```

Use the **Command** column to start or stop a test. When the **Status** column shows that a test is Inactive, **s**ta**r**t is displayed; when a test is Active, **s**to**p** is displayed. Position the cursor at the desired Start or Stop command and press Enter.

Selecting Abort All Tests from the Test menu will not disrupt a send and monitor 511 test.

The **Results** column displays the test duration.

When the Send and Monitor 511 test is active, ResetMon is available to reset the error counter to zero.

## Network Line Loopback

Network Line Loopback (LLB) loops the received signal on the network interface back to the network without change. Also, for DSX-1 models:

- If the DSL port is in a DS0 cross-connection, corresponding DSX-1 time slots are sent all ones.
- If the DSL port is in Bypass mode or a DS1 cross-connection, an AIS is sent to the corresponding DSX-1 port.

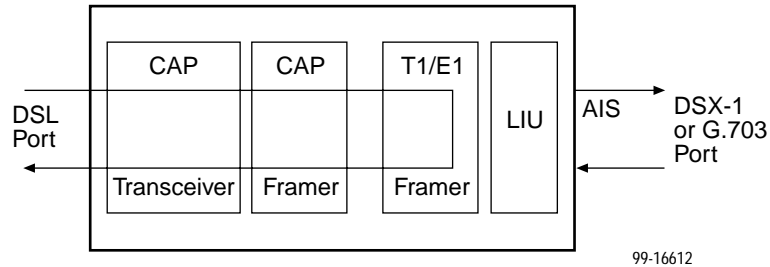

### ► Procedure

To run a Line Loopback:

1. Position the cursor at the Start command next to Network Line Loopback on the Network & DSX-1 or Network & G.703 Tests screen.
2. Press Enter.  
The Start command is changed to Stop.
3. To manually stop the test, verify that the cursor is positioned at the Stop command.
4. Press Enter.

Network Line Loopback cannot be started when another loopback or pattern test is in progress.



## Repeater Loopback

Repeater Loopback (RLB) loops the signal being sent from the DTE port back to the DTE port. Also, for DSX-1 models, if the DSX-1 port is in Bypass mode or a DS1 cross-connection, the corresponding DSL port is sent all ones and data received on the DSL link is ignored.

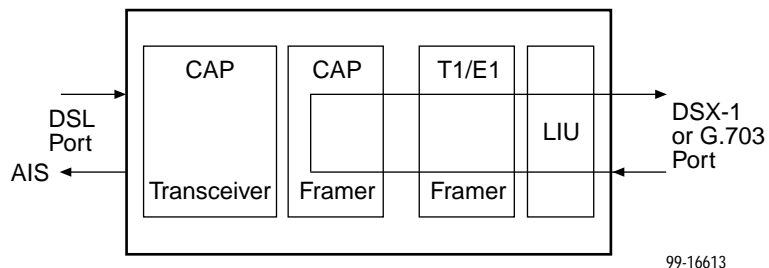

### ► Procedure

To run a Repeater Loopback:

1. Position the cursor at the Start command next to Repeater Loopback on the Network & DSX-1 or Network & G.703 Tests screen.
2. Press Enter.  
The Start command is changed to Stop.
3. To manually stop the test, verify that the cursor is positioned at the Stop command.
4. Press Enter.

A Repeater Loopback cannot be started when any other loopback test is in progress.

### NOTE:

Activating the Repeater Loopback test causes the Embedded Operations Channel (EOC), used for management, to be lost to the remote unit.

## DTE Loopback

DTE Loopback loops the DSX-1 or G.703 signal back to itself before the signal is sent to the Framer. Also, for DSX-1 models:

- If the DSX-1 port is in a DS0 cross-connection, corresponding DSL time slots are sent all ones.
- If the DSX-1 port is in Bypass mode or a DS1 cross-connection, all ones are sent to the corresponding DSL port and data received on the DSL link is ignored.

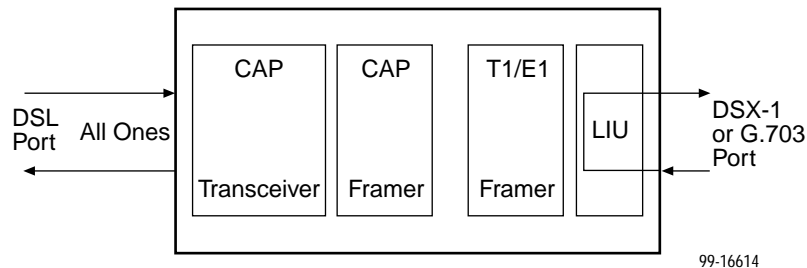

### ► Procedure

To run a DTE Loopback:

1. Position the cursor at the Start command next to DTE Loopback on the Network & DSX-1 or Network & G.703 Tests screen.
2. Press Enter.  
The Start command is changed to Stop.
3. To manually stop the test, verify that the cursor is positioned at the Stop command.
4. Press Enter.

A DTE Loopback cannot be started when any other loopback test is in progress.

## Remote Send Line Loopback

The local unit initiates this test by sending a line loopback Up or Down command to the remote unit for 10 seconds. When the remote unit detects the loopback Up command, it puts itself in line loopback and lights the front panel Test LED. The remote unit remains in loopback until it receives a loopback Down command or the remote unit's test timeout value is exceeded. The Send Line Loopback tests both units. External equipment can be used to verify the link.

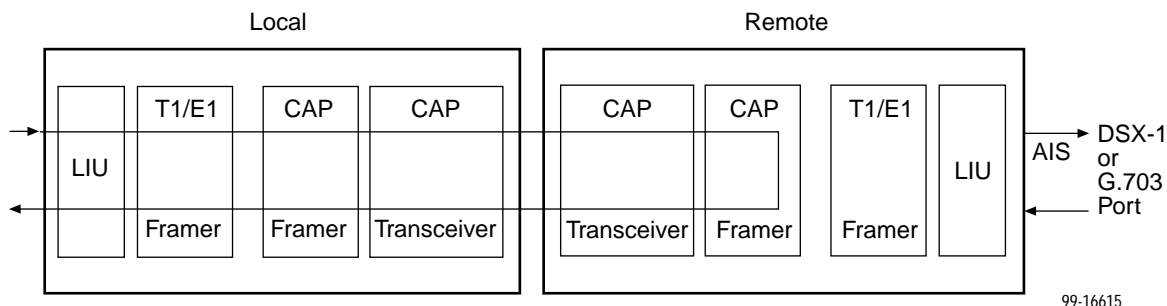

### ► Procedure

To run a Remote Send Line Loopback:

1. Position the cursor at the Up or Down selection next to Send Line Loopback on the Network & DSX-1 or Network & G.703 Tests screen.
2. Press the spacebar to select either Up or Down.
3. Position the cursor at the Send command next to Up or Down selection.
4. Press Enter.

The local unit stops sending the loopback command automatically after 10 seconds. You cannot stop the Remote Send Line Loopback test manually.

The Remote Send Line Loopback cannot be started when any other loopback or a Send and Monitor 511 test is active on the network interface.

Remote Send Line Loopback cannot be used in cross-connect mode.

## Send and Monitor 511

The Send and Monitor 511 test causes the local and remote units to send a 511 test pattern to each other. Also, for DSX-1 models, all ones are sent to DSX-1 time slots connected to the DSL port being tested.

The front panel Test LEDs of both units light up during the test. The duration and results of the test are displayed on the Network Test screen to the unit that initiated the test.

### NOTE:

The Send and Monitor 511 test is not a loopback test. Each unit independently sends and monitors a 511 pattern.

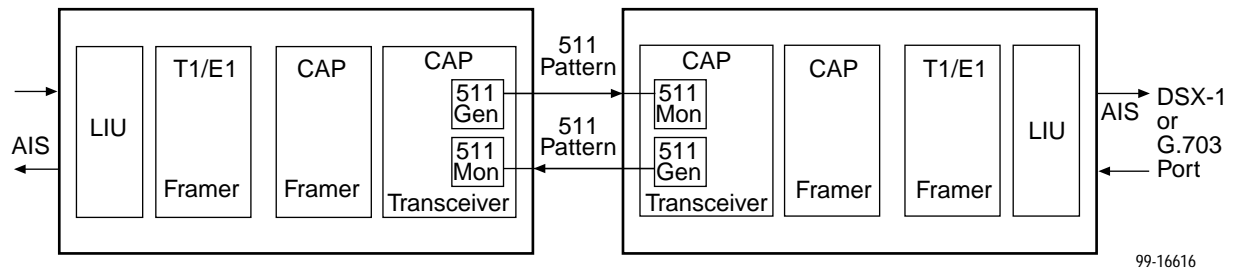

### ► Procedure

To run a Send and Monitor 511 test:

1. Position the cursor at the Start command next to Send and Monitor 511 on the Network & DSX-1 or Network & G.703 Tests screen.
2. Press Enter.  
The Start command is changed to Stop.
3. To manually stop the test, verify that the cursor is positioned at the Stop command.
4. Press Enter.

When a Send and Monitor 511 test is active, a count of bit errors is displayed next to the test duration, and the ResetMon virtual function key is available for use. Type r or R or select the ResetMon virtual function key to reset the error count.

## Device Tests

The Device Tests branch is used to access the only card-level test, the Lamp Test. To access the Device Tests screen, follow this menu selection sequence:

*Main Menu → Test → Device Tests*

```

main/test/card                                     Model: 87xx

                                DEVICE TESTS

                                Test      Command  Status
-----
                                Lamp Test: Start   Inactive

-----
Ctrl-a to access these functions, ESC for previous menu      MainMenu  Exit

```

## Lamp Test

The Lamp Test determines whether all LEDs are lighting and functioning properly.

### ► Procedure

To test the LEDs:

1. Position the cursor at the Start command next to Lamp Test on the Device Tests screen.
2. Press Enter.  
The Start command is changed to Stop. During the Lamp Test, all LEDs blink simultaneously every second. When you stop the Lamp Test, the LEDs are restored to their normal condition.
3. To stop the Lamp Test, position the cursor at the Stop command.
4. Press Enter.

## Ending an Active Test

Except for the Remote Send Line Loopback and Remote DCLB, a test initiated by the user can be ended by the user. Tests can also be terminated automatically by enabling the Test Timeout option from the System Options Menu.

- A Test Timeout option is available to automatically terminate a user-initiated Loopback or Pattern test (as opposed to manually terminating a test) after it has been running a specified period of time. The default is 10 minutes. Refer to Table A-7, *System Options*, in Appendix A, *Configuration Options*.
- On each test screen is a Command column. To manually stop the test, press Enter when the cursor is on the Stop command.
- Use the Abort All Tests selection from the Test menu to stop all tests running on all interfaces, with the exception of network-initiated loopbacks. **Command Complete** appears when all tests on all interfaces have been terminated.

An aborted test may continue to run for a few seconds as the abort command is sent to the remote end and processed.

## Telco-Initiated Tests

Hotwire 8747 and 8777 Termination Units support Telco-initiated tests as shown in the following table.

Activation and Deactivation	Line Loopback	Payload Loopback	Remote Line Loopback
In-Band Signal	Supported	Not Applicable	Not Supported
Bit-Oriented	Supported	Supported	Supported
Message-Oriented	Not Applicable	Not Supported	Not Applicable

### Telco-Initiated Line Loopback

Hotwire 8747 and 8777 Termination Units support line loopback as specified in AT&T TR 54016, AT&T TR 62411, and ANSI T1.403. A Telco-Initiated Line Loopback loops the received signal on the DSX-1 interface back to the DSX-1 interface without modification. Framing, CRC, and FDL bits are returned unaltered, and no BPVs or other line coding errors are removed. DSL time slots mapped to the DSX-1 port are sent all ones.

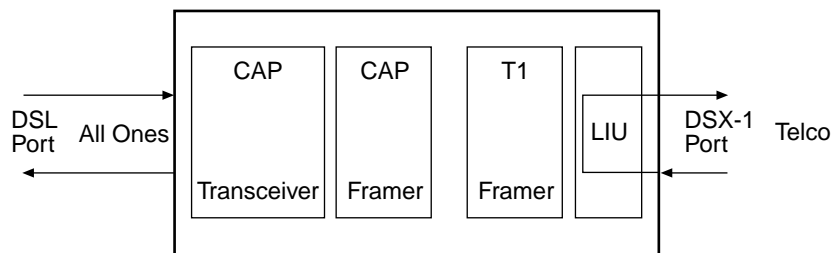

### Telco-Initiated Payload Loopback

The Hotwire 8747 and 8777 Termination Units support payload loopback as specified in AT&T TR 54016 and ANSI T1.403. A Telco-initiated line loopback loops the received signal on the DSX-1 interface back to the DSX-1 interface. Framing, CRC, and FDL bits are regenerated at the point of the loopback, and BPVs are removed. DSL time slots mapped to the DSX-1 port are sent all ones.

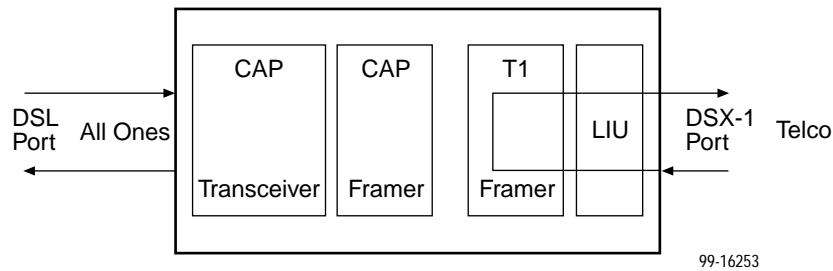

### Telco-Initiated Remote Line Loopback

If Remote Telco Loopback is enabled, a Telco-Initiated Line Loopback loops received data at the remote unit and passes it back to the Telco through the local unit.

The following figure shows the data flow for a remote Telco-initiated payload loopback.

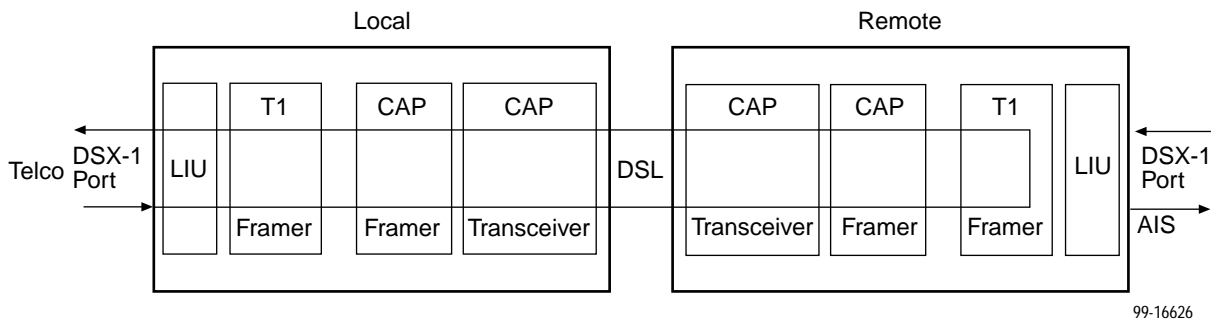

Telco-Initiated Remote Line Loopback cannot be used in cross-connect mode.



---

# Transferring Code and Configurations Using TFTP

# 9

---

## Download Code

The Download Code screen allows you to download firmware from a TFTP server. To access the Download Code screen, follow this menu selection sequence:

*Main Menu → Control → Download Code*

```
main/control/download_code
Slot: 4                                     Model: 87xx

                                DOWNLOAD CODE

Image File Name: _____ Clear
TFTP Server IP Address: 000.000.000.000 Clear
Destination: DSL1
Immediately Apply Download: No
Start Transfer: Yes

Packets Sent: 0000000
Packets Received: 0000000
Bytes Sent: 0000000
Bytes Received: 0000000
Transfer Status: Transfer Pending

-----
Ctrl-a to access these functions, ESC for previous menu      MainMenu  Exit
```

► **Procedure**

To download firmware:

1. Position the cursor in the Image File Name field. Type the name of the file to be downloaded.

The file name may be a regular path name expression of directory names separated by a forward slash (/) ending with the file name. The total path name length can be up to 128 characters.

2. Position the cursor in the TFTP Server IP Address field. Enter the TFTP server IP address.

The first three digits of the IP address cannot be 000 or greater than 223.

3. Position the cursor in the Immediately Apply Download field. If you would like the download to be effective immediately, select **Yes**.

4. Position the cursor at the Start Transfer field. Use the spacebar to select Yes. Press Enter.

When the data transfer is complete, the Transfer Status field changes to **Completed successfully**.

## Applying the Download

If you specified **No** (the default) in the Immediately Apply Download field in Step 3 above, you must now apply the download.

► **Procedure**

To apply the downloaded firmware:

1. Press the Escape key to return to the Control menu. Select Apply Download.
2. On the Apply Download screen, type **Yes** to reset the card and activate the code.

## Configuration Loader

The Configuration Loader screen allows you to upload configurations to and download configurations from a TFTP server. To access the Configuration Loader screen, follow this menu selection sequence:

*Main Menu → Configuration → Configuration Loader*

```

main/config/config_loader
Slot: 4                                     Model: 87xx

                                CONFIGURATION LOADER

Image File Name: _____                Clear
TFTP Server IP Address: 000.000.000.000    Clear
TFTP Transfer Direction: Download from Server
Destination: DSL1

Start Transfer: Yes

Packets Sent: 0000000
Packets Received: 0000000
Bytes Sent: 0000000
Bytes Received: 0000000
Transfer Status: Transfer Pending

Activate new configuration? No

-----
Ctrl-a to access these functions, ESC for previous menu    MainMenu Exit

```

### ► Procedure

To upload or download a configuration:

1. Position the cursor in the Image File Name field. Type the name of the file to be downloaded, or the name to be used for the file to be uploaded.

The file name may be a regular path name expression of directory names separated by a forward slash (/) ending with the file name. The total path name length can be up to 128 characters.

- **DOS machine:** If the TFTP server is hosted by a DOS machine, then directory and filenames must consist of eight or less characters with an optional suffix of up to three characters. The system will automatically upload the configuration file and create directories and filenames as needed.
- **UNIX machine:** If your server is hosted by a UNIX machine, the configuration file you name must already exist. It will not be created on the UNIX system by the TFTP server. It is critical that you work with your system administrator to plan the naming conventions for directories, filenames, and permissions so that anyone using the system has read and write permissions.

2. Position the cursor in the TFTP Server IP Address field. Enter the TFTP server IP address.  
The first three digits of the IP address cannot be 000 or greater than 223.
3. Position the cursor in the TFTP Transfer Direction field. Use the spacebar to select Download from Server or Upload to Server.
4. Position the cursor in the Destination field. Use the spacebar to select a network destination for the TFTP server. Select DSL if the TFTP server destination is the DSL link port or IMC (in-band management channel) if the TFTP destination is the Management port of the management card.
5. Position the cursor at the Start Transfer field. Use the spacebar to select Yes. Press Enter.  
When the data transfer is complete, the Transfer Status field changes to **Completed successfully**.
6. Position the cursor at the **Activate new configuration?** prompt and select **Yes** to activate a new downloaded configuration. Press Enter.

**NOTE:**

The following options are not changed:

- DSL Mode and Telnet Session configuration options
- Peer IP address

You must change these settings with the appropriate configuration menus after the new configuration is activated. See Table A-1, [Network Interface Options](#), Table A-7, [System Options](#), and Table A-11, [Telnet Session Options](#), in Appendix A, *Configuration Options*.

---

# Configuration Options



---

## Overview

The tables in this appendix summarize the configuration options accessed when you select Configuration on the Main Menu. The configuration options are arranged into groups based upon functionality.

Select . . .	To Access the . . .	To Configure the . . .
Network	<a href="#">Network Interface Options</a> , Table A-1	DSL interface ports.
DSX-1	<a href="#">DSX-1 Interface Options</a> , Table A-4	DSX-1 interface ports (Models 8747 and 8777).
G.703	<a href="#">G.703 Interface Options</a> , Table A-5	G.703 interface ports (Model 8779).
Copy Ports	<a href="#">Copy Ports Options</a> , Table A-6	DSL network and DTE interface ports by copying options from port to port.
System Options	<a href="#">System Options</a> , Table A-7	General system options of the unit.
System Clock	<a href="#">System Clock Options</a> , Table A-8	LTU system clock options.
Cross-Connect	<a href="#">Cross-Connect Mode Options</a> , Table A-9 <a href="#">Assign Time Slots Options</a> , Table A-10	DS1 and DS0 cross-connect ports.
Management and Communication	<ul style="list-style-type: none"><li>■ <a href="#">Telnet Session Options</a>, Table A-11</li><li>■ <a href="#">General SNMP Management Options</a>, Table A-12</li><li>■ <a href="#">SNMP NMS Security Options</a>, Table A-13</li><li>■ <a href="#">SNMP Traps Options</a>, Table A-14</li></ul>	Management support of the unit through SNMP and Telnet.

### NOTE:

All changes to configuration options must be saved. Refer to [Saving Configuration Options](#) in Chapter 3, *Initial Startup and Configuration*.

## Network Interface Options Menu

For Network Interface Options, refer to Table A-1. To access the Network Interface Options screen, follow this menu selection sequence:

*Main Menu* → *Configuration* → *Current Configuration* → *Network*

```

main/config/network
Slot: 18
Port 2
Model: 87xx

NETWORK INTERFACE OPTIONS

Port Status          Enable_
Margin Threshold:   0db
Excessive Error Rate Threshold: 1E-6
AutoRate:           Disable
DSL Line Rate:      1552 kbps
EIA-530 Payload Rate 1536 kbps
Transmit Attenuation 0dB
Peer IP Address:    111.255.255.000 Clear
DSO Cross Connect Line Framing: ESF

Circuit Identifier: _____ Clear

-----
Ctrl-a to access these functions, ESC for previous menu   MainMenu Exit
Save
    
```

**Table A-1. Network Interface Options (1 of 3)**

<b>Port Status</b>
Possible Settings: <b>Enable, Disable</b> Default Setting: <b>Enable</b>
Determines whether the port can be configured and used. <b>Enable</b> – The port can be configured and used. <b>Disable</b> – The port cannot be configured or used.
<b>Margin Threshold</b>
Possible Settings: <b>-5db, -4db, -3db, -2db, -1db, 0db, 1db, 2db, 3db, 4db, 5db, 6db, 7db, 8db, 9db, 10db</b> Default Setting: <b>0db</b>
Determines the level, expressed in decibels, at which a signal-to-noise margin condition is recognized. <b>-5db to 10db</b> – Sets the margin threshold to this value.

**Table A-1. Network Interface Options (2 of 3)**

<b>Excessive Error Rate Threshold</b>
Possible Settings: <b>1E-4, 1E-5, 1E-6, 1E-7, 1E-8, 1E-9</b> Default Setting: <b>1E-6</b>
Determines the error rate at which an excessive error rate (EER) condition is recognized. The rate is the ratio of the number of CRC errors to the number of bits received in a certain period.
<b>AutoRate</b>
Possible Settings: <b>Enable, Disable</b> Default Setting: <b>Disable</b>
Determines whether the unit automatically adjusts to the best line rate for conditions, or is fixed at the rate in the DSL Line Rate field. The automatically set rate cannot exceed Max DSL AutoRate. <ul style="list-style-type: none"> <li>■ AutoRate is only available when the unit is configured as an LTU.</li> </ul> <b>Enable</b> – The LTU adjusts to the best line rate. <b>Disable</b> – The LTU's line rate is the DSL Line Rate selected.
<b>DSL Line Rate</b>
Possible Settings (Models 8747, 8777): <b>144, 272, 400, 528, 784, 1040, 1552</b> Default Setting: <b>1552</b>  Possible Settings (Model 8779): <b>144, 272, 400, 528, 784, 1040, 1552, 2064</b> Default Setting: <b>2064</b>
Determines the fixed line rate of the LTU when AutoRate is disabled. See Tables A-2 and A-3 for information about maximum payload rates for different DSL line rates. <ul style="list-style-type: none"> <li>■ DSL Line Rate is only available when the unit is configured as an LTU and AutoRate is disabled.</li> </ul> <b>144 to 2064</b> – The fixed DSL Line Rate, in kbps.
<b>Max DSL AutoRate</b>
Possible Settings (Models 8747, 8777): <b>144, 272, 400, 528, 784, 1040, 1552</b> Default Setting: <b>1552</b>  Possible Settings (Model 8779): <b>144, 272, 400, 528, 784, 1040, 1552, 2064</b> Default Setting: <b>2064</b>
Determines the maximum rate the unit can AutoRate to. See Tables A-2 and A-3 for information about maximum payload rates for different DSL line rates. <ul style="list-style-type: none"> <li>■ Max DSL AutoRate is only available when the unit is configured as an LTU and AutoRate is enabled.</li> </ul> <b>144 to 2064</b> – The AutoRate ceiling, in kbps.
<b>EIA-530 Payload Rate</b>
Possible Settings: <b>64, 128</b> Default Setting: <b>128</b>
Specifies the synchronous port speed of the remote NTU if the NTU is an EIA-530 model and the DSL line rate is 144 kbps. At higher line rates the EIA-530 NTU runs at the highest payload rate possible. <ul style="list-style-type: none"> <li>■ EIA-530 Payload Rate is only available when the unit is configured as an LTU.</li> </ul> <b>64 or 128</b> – The synchronous port speed of the remote NTU, in kbps.

**Table A-1. Network Interface Options (3 of 3)**

<b>Transmit Attenuation</b>
Possible Settings: <b>0dB, 3dB, 6dB</b> Default Setting: <b>0dB</b>
Determines the amount the transmit power of the unit is reduced to accommodate a short line length. 0dB denotes no attenuation.  <b>0dB</b> – The full transmit power is used.  <b>3dB or 6dB</b> – The transmit power is reduced the specified amount.
<b>Peer IP Address (LTU Only)</b>
Possible Settings: <b>001.000.000.000 – 223.255.255.255, Clear</b> Default Setting: <b>000.000.000.000</b>
Specifies the peer IP address providing the remote management link on the DSL loop. <ul style="list-style-type: none"> <li>▪ Peer IP Address is only available when the unit is configured as an LTU and the unit is in not running in IP Conservative mode.</li> </ul> <b>Address Field – (001.000.000.000 – 223.255.255.255)</b> – Enter an address for the peer unit. The range for the first byte is 001 to 223, with the exception of 127. The range for the remaining three bytes is 000 to 255. The IP address must be in the same subnet as the MCC backplane address.  <b>Clear</b> – Clears the IP address and sets to all zeros.
<b>DS0 Cross Connect Line Framing (Model 8777, LTU only)</b>
Possible Settings: <b>ESF, D4</b> Default Setting: <b>ESF</b>
Specifies the framing format to be used at the DSL interface for DS0 cross connects, regardless of the framing format specified for the DSX-1 ports. <ul style="list-style-type: none"> <li>▪ DS0 Cross Connect Line Framing is only available on the Model 8777, only when the unit is configured as an LTU, and only when the port is in a DS0 cross connect.</li> </ul> <b>ESF</b> – ESF framing formatting is used for transmitted and received data over the DSL Interface.  <b>D4</b> – D4 framing format is used for transmitted and received data over the DSL Interface.
<b>Circuit Identifier</b>
Possible Settings: <b>[ASCII Text]</b> Default Setting: [blank]
Uniquely identifies the circuit number of the transmission vendor's DSL line for troubleshooting purposes.  <b>[ASCII Text]</b> – Enter a maximum of 128 characters. All printable ASCII characters except ^ (caret) are allowed.  <b>Clear</b> – Clears the field.



Tables A-2 and A-3 provides the maximum payload rates achievable for each DSL line rate and the number of time slots required to achieve that payload rate. For G.703, the payload rate depends on whether you are using signaling (time slots 0 and 16) or data only (time slot 0).

**Table A-2. Payload Rates and DSL Line Rates for Models 8747 and 8777**

DSL Line Rate (kbps)	DSX-1-to-DSX-1 (To 7974-A2, 8747, 8777)		DSX-1-to-DSX-1 (To 7974-A1, 8774)		DSX-1- to-EIA-530-A	
	Maximum Payload Rate (kbps)	Time Slots	Maximum Payload Rate (kbps)	Time Slots	Maximum Payload Rate (kbps)	Time Slots
1552	1536	24	1536	24	1536	24
1040	1024	16	960	15	1024	16
784	768	12	704	11	768	12
528	512	8	448	7	512	8
400	384	6	320	5	384	6
272	256	4	–	–	256	4
144	128	2	–	–	128	2

**Table A-3. Payload Rates and DSL Line Rates for Model 8779**

DSL Line Rate (kbps)	Voice Mode G.703-to-G.703		Data Mode G.703-to-G.703		Data Mode G.703-to-EIA-530-A	
	Maximum Payload Rate (kbps)	Time Slots	Maximum Payload Rate (kbps)	Time Slots	Maximum Payload Rate (kbps)	Time slots
2064	1920	30	1984	31	1984	31
1552	1408	22	1472	23	1536	24
1040	896	14	960	15	1024	16
784	640	10	704	11	768	12
528	384	6	448	7	512	8
400	256	4	320	5	384	6
272	128	2	192	3	256	4
144	–	–	64	1	128	2

## DSX-1 Interface Options

For DSX-1 Interface Options (Models 8747 and 8777), refer to Table A-4. To access the DSX-1 Interface Options screen, follow this menu selection sequence:

*Main Menu → Configuration → Load Configuration From → DSX-1*

```

main/config/DSX-1
Slot: 18
Port 2
Model: 87xxx

DSX-1 INTERFACE OPTIONS

Port Status:          Enable
Line Coding:          B8BS
Line Framing:         ESF
Line Equalization:    0 -133
Excessive Error Rate Threshold: 1E-4

Primary Clock Source: DSX-1

-----
Ctrl-a to access these functions, ESC for previous menu   MainMenu   Exit
Save
    
```

**Table A-4. DSX-1 Interface Options (1 of 2)**

<b>Port Status</b>
Possible Settings: <b>Enable, Disable</b> Default Setting: <b>Enable</b>
Determines whether the port can be configured and used. <b>Enable</b> – The port can be configured and used. <b>Disable</b> – The port cannot be configured or used. Configuration fields for the port are inaccessible, no alarms or traps associated with the port are generated, and the LED associated with the port is OFF. Cross-connections are not cleared when a port is disabled.
<b>Line Coding Format</b>
Possible Settings: <b>AMI, B8ZS</b> Default Setting: <b>B8ZS</b>
Specifies the line coding format to be used by the DSX-1 interface. <b>AMI</b> – Indicates the line coding format used by the DSX-1 interface is Alternate Mark Inversion (AMI). <b>B8ZS</b> – Indicates the line coding format used by the DSX-1 interface is B8ZS.

Table A-4. DSX-1 Interface Options (2 of 2)

<b>Line Framing</b>
<b>xx</b>
Possible Settings: <b>ESF, D4</b> Default Setting: <b>ESF</b>
Specifies the framing format to be used by the DSX-1 interface. <ul style="list-style-type: none"> <li>■ Line Framing is only available when the unit is configured as an LTU. The NTU is automatically configured to match the framing format used by the LTU.</li> </ul> <b>ESF</b> – ESF framing formatting is used for transmitted and received data over the DSX-1 Interface. <b>D4</b> – D4 framing format is used for transmitted and received data over the DSX-1 Interface.
<b>Line Equalization</b>
Possible Settings: <b>0-133, 133-266, 266-399, 399-533, 533-655</b> Default Setting: <b>0-133</b>
Compensates for signal distortion for a DSX-1 signal over a given distance. <b>0–133 feet</b> – Provides equalization for a cable length up to 133 feet. <b>133–266 feet</b> – Provides equalization for a cable length up to 266 feet. <b>266–399 feet</b> – Provides equalization for a cable length up to 399 feet. <b>399–533 feet</b> – Provides equalization for a cable length up to 533 feet. <b>533–655 feet</b> – Provides equalization for a cable length up to 655 feet.
<b>Excessive Error Rate Threshold</b>
Possible Settings: <b>1E–4, 1E–5, 1E–6, 1E–7, 1E–8, 1E–9</b> Default Setting: <b>1E–4</b>
Determines the error rate at which an excessive error rate (EER) condition is recognized. The rate is the ratio of the number of CRC errors to the number of bits received in a certain period. <b>1E–4 – 1E–9</b> – The rate at which EER is recognized.
<b>Primary Clock Source</b>
Possible Settings: <b>Internal, DSX-1</b> Default Setting: <b>DSX-1</b>
Specifies where the unit will derive its timing from. <ul style="list-style-type: none"> <li>■ Primary Clock Source is available only when the unit is configured as an LTU and the port is not cross-connected. If DSL Line Rate is set lower than 1552 kbps, Primary Clock Source is forced to DSX-1 and cannot be changed.</li> </ul> <b>Internal</b> – Timing is derived from the internal oscillator. <b>DSX-1</b> – Timing is derived from the DSX-1 interface.

## G.703 Interface Options

For G.703 Interface Options (Model 8779), refer to Table A-5. To access the G.703 Interface Options screen, follow this menu selection sequence:

*Main Menu → Configuration → Load Configuration From → G.703*

```

main/config/G.703
Slot: 4
Port: 2
Model: 87xx

G.703 INTERFACE OPTIONS

Port Status:          Enable
Framing:              Framed
Line Coding:          HDB3
Line Framing:         noCRC4
Time Slot 16:         Data
Primary Clock Source: G703

-----
Ctrl-a to access these functions, ESC for previous menu   MainMenu  Exit
Save
    
```

**Table A-5. G.703 Interface Options (1 of 2)**

<b>Port Status</b>
Possible Settings: <b>Enable, Disable</b> Default Setting: <b>Enable</b>
Determines whether the port can be configured and used. <b>Enable</b> – The port can be configured and used. <b>Disable</b> – The port cannot be configured or used. Configuration fields for the port are inaccessible, no alarms or traps associated with the port are generated, and the LED associated with the port is OFF. Cross-connections are not cleared when a port is disabled.
<b>Framing</b>
Possible Settings: <b>Framed, Unframed</b> Default Setting: <b>Framed</b>
Specifies whether G.704 framing is used for the G.703 interface. <b>Framed</b> – The unit conforms to G.704 framing, using time slot 0. <b>Unframed</b> – G.704 framing is disabled, and the port is forced to DS1 Bypass mode.

**Table A-5. G.703 Interface Options (2 of 2)**

<b>Line Coding</b>
Possible Settings: <b>AMI, HDB3</b> Default Setting: <b>HDB3</b>
Specifies the line coding format to be used by the G.703 interface. <b>AMI</b> – Indicates the line coding format used by the G.703 interface is Alternate Mark Inversion (AMI). <b>HDB3</b> – Indicates the line coding format used by the G.703 interface is HDB3.
<b>Line Framing</b>
Possible Settings: <b>CRC4, noCRC4</b> Default Setting: <b>noCRC4</b>
Specifies the framing format to be used by the G.703 interface. <ul style="list-style-type: none"> <li>■ Line Framing is only available when the unit is configured as an LTU, AutoRate is disabled, and the DSL Line rate is 2064 kbps. Otherwise the noCRC4 framing format is used. The NTU is automatically configured to match the framing format used by the LTU.</li> </ul> <b>CRC4</b> – CRC4 framing formatting is used for transmitted and received data over the G.703 Interface. <b>noCRC4</b> – Non-CRC4 framing format is used for transmitted and received data over the G.703 Interface.
<b>Time Slot 16</b>
Possible Settings: <b>Signaling-CAS, Signaling-CCS, Data</b> Default Setting: <b>Signaling-CCS</b>
Specifies whether the G.703 interface is used for voice or data. <b>Signaling-CAS</b> – Time slot 16 contains Channel Associated Signaling (CAS) information (the unit is in voice mode). <b>Signaling-CCS</b> – Time slot 16 contains Common Channel Signaling (CCS) information (the unit is in voice mode). <b>Data</b> – Time slot 16 contains data (the unit is in data mode).
<b>Primary Clock Source</b>
Possible Settings: <b>Internal, G.703</b> Default Setting: <b>Internal</b>
Determines the primary clock source for the unit. <ul style="list-style-type: none"> <li>■ Primary Clock Source is available only when the unit is configured as an LTU.</li> </ul> <b>Internal</b> – Timing is derived from the internal oscillator. <b>G.703</b> – Timing is derived from the G.703 interface.

## Copy Ports Options

You can copy the configuration options of one DSX-1 interface and DSL loop to another using the Copy Ports screen. For Copy Ports options, refer to Table A-6. To access the Copy Ports screen, follow this menu selection sequence:

*Main Menu → Configuration → Load Configuration From → Copy Ports*

```

main/config/copy
slot: 18                                     Model: 87xx

                                COPY PORTS

                                From: Port 1
                                To:   Port 2

                                Perform Copy

                                Perform Copy Then Increment

-----
Save                                     ESC for previous menu      MainMenuExit
    
```

**Table A-6. Copy Ports Options**

<b>From: Port <i>n</i></b>
Possible Settings: <b>1, 2, 3, 4, 5, 6, 7, 8</b> Default Setting: <b>1</b>
Controls the source of the configuration options. <b>1 to 8</b> – The configuration of the selected port is copied.
<b>To: Port <i>y</i></b>
Possible Settings: <b>1, 2, 3, 4, 5, 6, 7, 8, All</b> Default Setting: <b>1</b>
Controls the target of the configuration options. <b>1 to 8</b> – The configuration of the selected port is replaced. If Perform Copy Then Increment is selected, the port number is incremented by 1 after the copy. <b>All</b> – The configurations of all ports are replaced by the configuration of the selected From: Port.  NOTE: Peer IP Address and Circuit Identifier are <i>not</i> copied.

## System Options

For System Options, refer to Table A-7. To access the System Options screen, follow this menu selection sequence:

*Main Menu → Configuration → Load Configuration From → System*

```

main/config/system
slot: 18
Model: 87xx

SYSTEM OPTIONS

DSL Mode:           LTU
Test Timeout:       Enable
Test Duration (min): 10
Telco Initiated Loopbacks: Enable (Models 8747, 8777)
Remote Telco Line Loopback: Disabled (Models 8747, 8777)
G.703 Line Termination 120 Ohm (Model 8779)

-----
Ctrl-a to access these functions, ESC for previous menu   MainMenu   Exit
Save
    
```

**Table A-7. System Options (1 of 2)**

<b>DSL Mode</b>
Possible Settings: <b>LTU, NTU</b> Default Setting: <b>LTU</b>
Controls whether the unit is configured as a control unit or tributary unit. <b>LTU</b> – The unit is configured as a control unit (Line Termination Unit). <b>NTU</b> – The unit is configured as a tributary unit (Network Termination Unit). This unit will request its IP address from the LTU during establishment of the PPP link. NOTE: Changing this option will reset the card.
<b>Test Timeout</b>
Possible Settings: <b>Enable, Disable</b> Default Setting: <b>Enable</b>
Allows tests to end automatically. The feature should be enabled when the unit is remotely managed, so that control can be regained after a test is accidentally executed. <b>Enable</b> – Loopback and pattern tests end when test duration is reached. <b>Disable</b> – Tests run until manually terminated from the Network Tests screen or remotely (network initiated tests). Refer to <i>Running Network Tests</i> in Chapter 8, <i>Testing</i> .
<b>Test Duration (min)</b>
Possible Settings: <b>1–120</b> Default Setting: <b>10</b>
Number of minutes for a test to be active before automatically ending. <ul style="list-style-type: none"> <li>■ Test Duration (min) option appears when Test Timeout is enabled.</li> </ul> <b>1 to 120</b> – Amount of time in minutes for a test to run before terminating.

**Table A-7. System Options (2 of 2)**

<b>Telco Initiated Loopback</b>
Possible Settings (Models 8747, 8777): <b>Enable, Disable</b> Default Setting: <b>Enable</b>
Determines if the unit will respond to Telco loopback commands on the DSX-1 interface. See <i>Telco-Initiated Tests</i> in Chapter 8, <i>Testing</i> . <b>Enable</b> – The unit will respond to Telco loopback commands. <b>Disable</b> – The unit will not respond to Telco loopback commands.
<b>Remote Telco Line Loopback</b>
Possible Settings (Models 8747, 8777): <b>Enable, Disable</b> Default Setting: <b>Disable</b>
Determines if the unit will perform a Telco initiated loopback on just the local unit or if the loopback will be performed on the remote DSL unit. See <i>Telco-Initiated Tests</i> in Chapter 8, <i>Testing</i> . <b>Enable</b> – The loopback will be in the remote unit. <b>Disable</b> – The loopback will be local.
<b>G.703 Line Termination</b>
Possible Settings (Model 8779): <b>75 ohms, 120 ohms</b> Default Setting: <b>120 ohms</b>
Specifies the impedance of the G.703 interface <b>75 ohms</b> – The G.703 interface impedance is 75 ohms unbalanced. <b>120 ohms</b> – The G.703 interface impedance is 120 ohms balanced.



## System Clock

The Primary and Secondary System Clock References determine the clock used by ports in a cross-connect configuration. For System Clock configuration options, refer to [Table A-8](#). To access the System Clock screen, follow this menu selection sequence:

*Main Menu → Configuration → Load Configuration From → System Clock*

```

main/config/system_clock
Slot: 18                                     Model: 87xx

                SYSTEM CLOCK

Primary System Clock Reference      Internal
Secondary System Clock Reference    Internal

-----
Ctrl-a to access these functions, ESC for previous menu      MainMenu  Exit
Save
    
```

All ports configured as system clock sources must be traceable to the same clock reference. Ports in a cross-connect configuration that are not providing timing themselves receive their timing from the system clock reference. All ports in a cross-connect configuration are therefore synchronized to the system clock reference.

The following table shows the system clock reference combinations permitted for LTUs and NTUs. **Choose the most accurate clock available for the Primary System Clock Reference.**

Device	If the Primary System Clock Reference is . . .	The Secondary System Clock Reference must be . . .
LTU	DSX-1 or G.703 port in cross-connect mode	<ul style="list-style-type: none"> <li>■ DSX-1 or G.703 port in DS1 Bypass mode, or</li> <li>■ Internal</li> </ul>
	DSX-1 or G.703 port in DS1 Bypass mode	<ul style="list-style-type: none"> <li>■ DSX-1 or G.703 port in DS1 Bypass mode, or</li> <li>■ Internal</li> </ul>
	Internal	Internal
NTU	DSL port in cross-connect mode	DSL port in cross-connect mode
	Internal	Internal

When a system clock source fails or is misconfigured, an alarm is reported. Secondary clock failures are not reported unless the primary clock has also failed. When the primary clock fails, clocking is switched to the secondary clock source, if available. If a secondary clock is not available, the clock switches to secondary holdover mode. In holdover mode, the system attempts to generate timing which is consistent with the last clock reference. A switch is made back to the primary clock when it becomes available.

Figure A-1 shows clocking in an LTU.

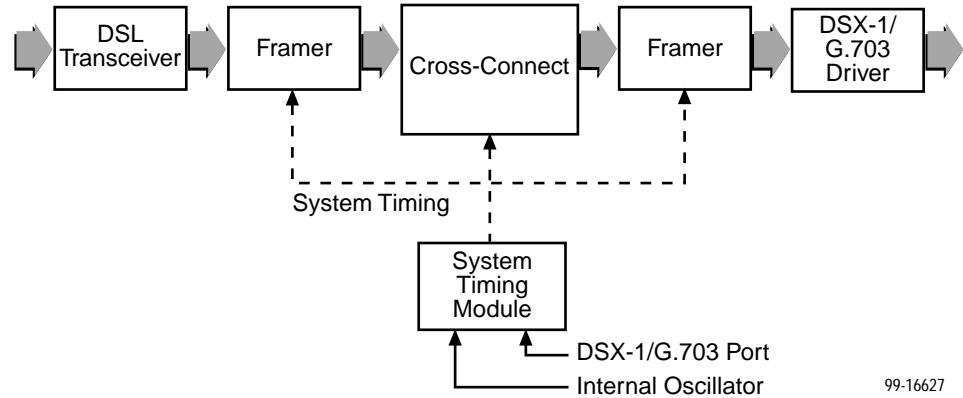

99-16627

**Figure A-1. System Timing**

Figure A-2 shows sample system clock configurations.

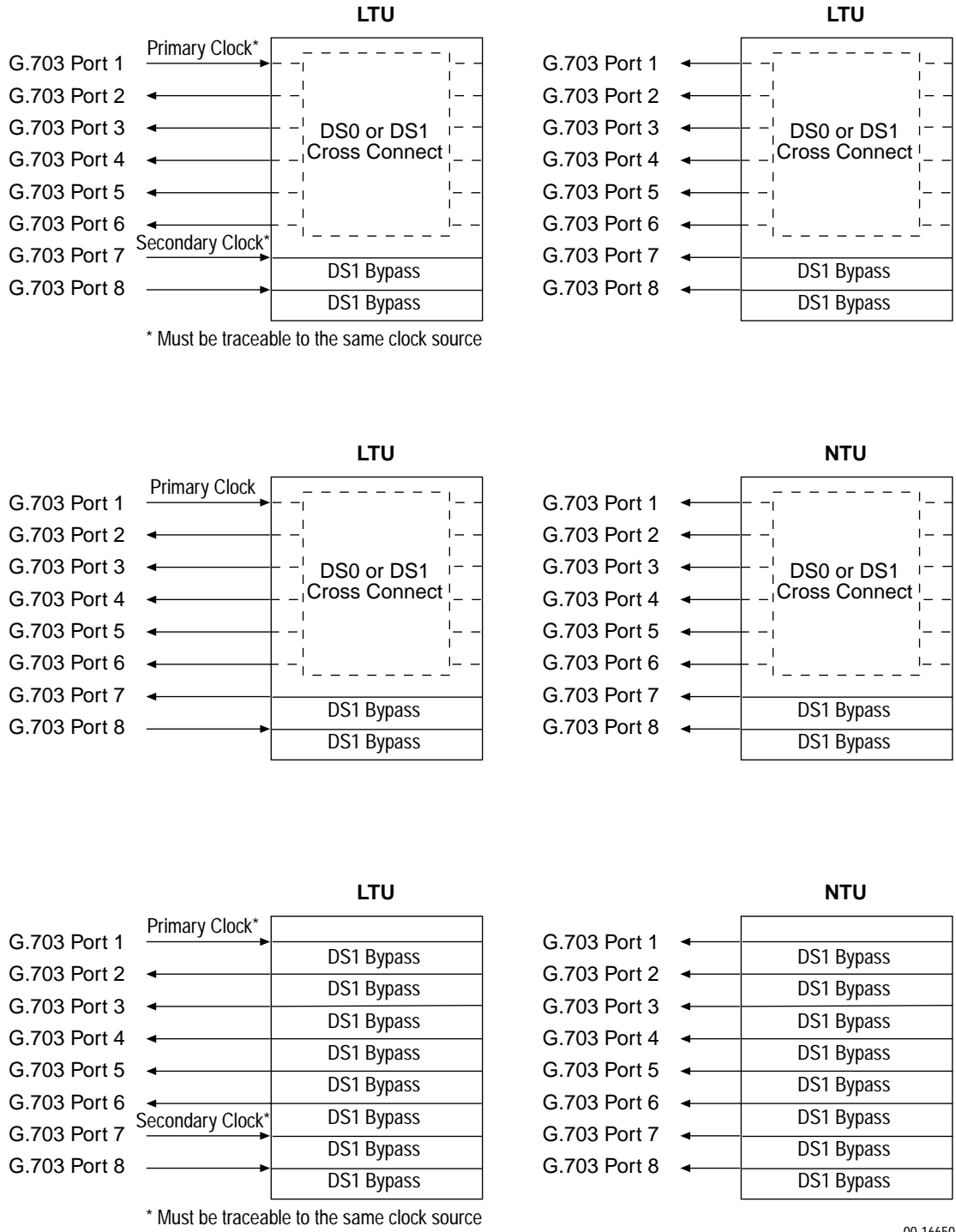

00-16650

Figure A-2. System Clock Configuration Examples

**Table A-8. System Clock Options**

<b>Primary System Clock Reference</b>
<p>Possible Settings (LTU, Models 8747, 8777): <b>DSX-1 Port 1, DSX-1 Port 2, DSX-1 Port 3, DSX-1 Port 4, DSX-1 Port 5, DSX-1 Port 6, DSX-1 Port 7, DSX-1 Port 8, Internal</b>                      Default Setting: <b>Internal</b></p> <p>Possible Settings (LTU, Model 8779): <b>G.703 Port 1, G.703 Port 2, G.703 Port 3, G.703 Port 4, G.703 Port 5, G.703 Port 6, G.703 Port 7, G.703 Port 8, Internal</b>                      Default Setting: <b>Internal</b></p> <p>Possible Settings (NTU): <b>DSL Port 1, DSL Port 2, DSL Port 3, DSL Port 4, DSL Port 5, DSL Port 6, DSL Port 7, DSL Port 8, Internal</b>                      Default Setting: <b>Internal</b></p>
<p>Determines the source of system timing. Select the most accurate clock available.</p> <p><b>DSX-1 or G.703 Port <i>n</i></b> – Timing is derived from the specified port. To be a valid clock source, the port must be enabled and must derive its timing from the DSX-1 or G.703 network.</p> <p><b>DSL Port <i>n</i></b> – Timing is derived from the specified port. The port must be enabled and in a cross-connection.</p> <p><b>Internal</b> – Timing is derived from the internal oscillator, which provides a Stratum 4 reference.</p>
<b>Secondary System Clock Reference</b>
<p>Possible Settings (LTU, Models 8747, 8777): <b>DSX-1 Port 1, DSX-1 Port 2, DSX-1 Port 3, DSX-1 Port 4, DSX-1 Port 5, DSX-1 Port 6, DSX-1 Port 7, DSX-1 Port 8, Internal</b>                      Default Setting: <b>Internal</b></p> <p>Possible Settings (LTU, Model 8779): <b>G.703 Port 1, G.703 Port 2, G.703 Port 3, G.703 Port 4, G.703 Port 5, G.703 Port 6, G.703 Port 7, G.703 Port 8, Internal</b>                      Default Setting: <b>Internal</b></p> <p>Possible Settings (NTU): <b>DSL Port 1, DSL Port 2, DSL Port 3, DSL Port 4, DSL Port 5, DSL Port 6, DSL Port 7, DSL Port 8, Internal</b>                      Default Setting: <b>Internal</b></p>
<p>Determines the source of system timing if the primary system clock source fails. If the secondary clock source fails, the unit switches to secondary holdover mode.</p> <p><b>DSX-1 or G.703 Port <i>n</i></b> – Timing is derived from the specified port. To be a valid clock source, the port must be enabled and must derive its timing from the DSX-1 or G.703 network.</p> <p><b>DSL Port <i>n</i></b> – Timing is derived from the specified port. The port must be enabled and in a cross-connection.</p> <p><b>Internal</b> – Timing is derived from the internal oscillator, which provides a Stratum 4 reference.</p>

## Cross-Connect

For Cross-Connect configuration options, refer to [Table A-9](#). To access the Cross-Connect screen, follow this menu selection sequence:

*Main Menu → Configuration → Load Configuration From → Cross-Connect*

```
main/config/cross_connect
slot: 18                                     Model: 87xx

                                CROSS-CONNECT CONFIGURATION

                                Set Cross-Connect Mode
                                Assign Time Slots

-----
Ctrl-a to access these functions, ESC for previous menu   MainMenu   Exit
Save
```

Select:

- **Set Cross-Connect Mode** to configure or disable the ports.
- **Assign Time Slots** to assign time slots for each cross-connected port.

## Set Cross-Connect Mode

For Cross-Connect Mode configuration options, refer to [Table A-9](#). To access the Set Cross-Connect Mode screen, follow this menu selection sequence:

*Main Menu* → *Configuration* → *Load Configuration*  
*From* → *Cross-Connect* → *Set Cross-Connect Mode*

```

main/config/xconnect_mode
Slot: 18
Model: 87xx

                                CROSS-CONNECT MODE

DSX-1 | G.703 Port      MODE      DSL Port
      1  DSL Bypass      1
      2  DSL Bypass      2
      3  DSL Bypass      3
      4  DSL Bypass      4
      5  DSL Bypass      5
      6  DSL Bypass      6
      7  DSL Bypass      7
      8  DSL Bypass      8

                                Assign_DS0s

-----
Ctrl-a to access these functions, ESC for previous menu      MainMenu  Exit
Save                                                         Clear_All
    
```

If any port Mode is DS0 Cross-connect, selecting **Assign\_DS0s** causes the Assign Time Slots screen to be displayed.

The **Clear\_All** command changes the Mode of all enabled ports to DS0 Cross-Connect. All DSL port numbers and time slot assignments are cleared.

For information about the cross-connection system, see Chapter 4, [Cross-Connecting Ports](#).

**Table A-9. Cross-Connect Mode Options**

<b>(Cross-Connect Mode)</b>
Possible Settings: <b>DS1 Bypass, DS1 Cross-connect, DS0 Cross-connect, Not Assigned, Disabled, Unframed</b> Default Setting: <b>DS1 Bypass</b>
<p>Determines the cross-connect mode for the port.</p> <p><b>DS1 Bypass</b> – The entire DSX-1 or G.703 interface is connected directly to the DSL interface.</p> <p><b>DS1 Cross-connect</b> – The entire DSX-1 or G.703 interface is connected through cross-connect circuitry to the DSL port.</p> <p><b>DS0 Cross-connect</b> – Individual time slots of the DSX-1 or G.703 interface may be connected to any time slot of any of the DSL interfaces.</p> <p><b>Unassigned</b> – None of the time slots associated with the port are assigned.</p> <p><b>Unframed</b> – (Model 8779 only.) Framing is disabled on the port. Since there are no time slots, the port is set to DS1 Bypass mode. This value is displayed but cannot be entered.</p> <p><b>Disabled</b> – The DSX-1 or G.703 port is disabled. No time slot assignments can be made to the port. To enable the port use the DSX-1 Interface or G.703 Interface screen. This value is displayed but cannot be entered.</p>

## Assign Time Slots

For Assign Time Slots configuration options, refer to [Table A-10](#). To access the Assign Time Slots screen, select **Assign\_DS0s** on the Cross-Connect Mode screen, or follow this menu selection sequence:

*Main Menu → Configuration → Load Configuration  
From → Cross-Connect → Assign Time Slots*

The following screen is displayed for a DSX-1 port:

```

main/config/cross_connect/timeslot
Slot: 18
Model: 87xx

                                ASSIGN TIME SLOTS

DSX-1 Port: 1

  TS01      TS02      TS03      TS04      TS05      TS06      TS07
D ___ d    D ___ d    D ___ d    D ___ d    D ___ d    D ___ d    D ___ d

  TS08      TS09      TS10      TS11      TS12      TS13      TS14
D ___ d    D ___ d    D ___ d    D ___ d    D ___ d    D ___ d    D ___ d

  TS15      TS16      TS17      TS18      TS19      TS20      TS21
D ___ d    D ___ d    D ___ d    D ___ d    D ___ d    D ___ d    D ___ d

  TS22      TS23      TS24
D ___ d    D ___ d    D ___ d

Key: D = DSL, X = DSX-1
     d = data, v = voice

-----
Ctrl-a to access these functions, ESC for previous menu   MainMenu Exit
Save                                                       Clear_All
    
```

The following screen is displayed for a G.703 port:

```

main/config/cross_connect/timeslot
Slot: 18
Model: 87xx

                                ASSIGN TIME SLOTS

G.703 Port: 1

  TS01      TS02      TS03      TS04      TS05      TS06      TS07
D ___ d    D ___ d    D ___ d    D ___ d    D ___ d    D ___ d    D ___ d

  TS08      TS09      TS10      TS11      TS12      TS13      TS14
D ___ d    D ___ d    D ___ d    D ___ d    D ___ d    D ___ d    D ___ d

  TS15      TS16      TS17      TS18      TS19      TS20      TS21
D ___ d    D ___ d    D ___ d    D ___ d    D ___ d    D ___ d    D ___ d

  TS22      TS23      TS24      TS25      TS26      TS27      TS28
D ___ d    D ___ d    D ___ d    D ___ d    D ___ d    D ___ d    D ___ d

  TS29      TS30      TS31
D ___ d    D ___ d    D ___ d

Key: D = DSL, G = G.703
     d = data, v = voice

-----
Ctrl-a to access these functions, ESC for previous menu   MainMenu Exit
Save                                                       Clear_All
    
```



The following screen is displayed for a DSL port on a DSX-1 unit:

```

main/config/cross_connect/timeslot
Slot: 18
Model: 87xx
ASSIGN TIME SLOTS
DSL Port: 1

  TS01      TS02      TS03      TS04      TS05      TS06      TS07
X _ _ _ d  X _ _ _ d  X _ _ _ d  X _ _ _ d  X _ _ _ d  X _ _ _ d  X _ _ _ d

  TS08      TS09      TS10      TS11      TS12      TS13      TS14
X _ _ _ d  X _ _ _ d  X _ _ _ d  X _ _ _ d  X _ _ _ d  X _ _ _ d  X _ _ _ d

  TS15      TS16      TS17      TS18      TS19      TS20      TS21
X _ _ _ d  X _ _ _ d  X _ _ _ d  X _ _ _ d  X _ _ _ d  X _ _ _ d  X _ _ _ d

  TS22      TS23      TS24
X _ _ _ d  X _ _ _ d  X _ _ _ d

Key: D = DSL, X = DSX-1
     d = data, v = voice

-----
Ctrl-a to access these functions, ESC for previous menu   MainMenu  Exit
Save                                                         Clear_All
    
```

The **Clear\_All** command clears all the time slot assignments for the port.

For an example showing how to configure the cross-connection system, see Chapter 4, *Cross-Connecting Ports*.

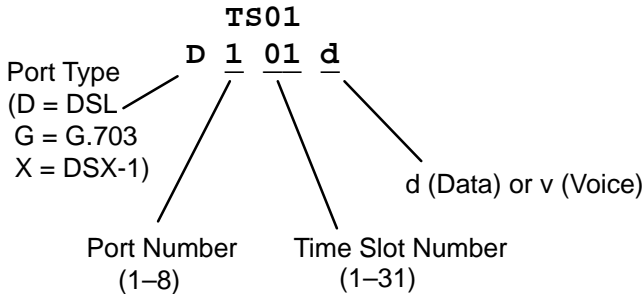

**Table A-10. Assign Time Slots Options (1 of 1)**

<b>(DSX-1/DSL or G.703/DSL Selection)</b>
Possible Settings (Models 8747, 8777): <b>DSX-1, DSL</b> Default Setting: <b>DSX-1</b>
Possible Settings (Model 8779): <b>G.703, DSL</b> Default Setting: <b>G.703</b>
Determines the port whose time slots are displayed. The unit can be configured using the viewpoint of the DSX-1 or G.703 interface, or the DSL network interface. <b>DSX-1 or G.703</b> – Time slots for the specified DTE port are displayed. <b>DSL</b> – Time slots for the specified DSL port are displayed.
<b>(Port Type )</b>
Possible Settings (Models 8747, 8777): <b>D, X</b> Default Setting: <b>D</b>
Possible Settings (Model 8779): <b>D, G</b> (see note) Default Setting: <b>D</b>
Shows the type of port to which this time slot is connected. <b>D</b> – The time slot is connected to a DSL port. <b>G</b> – The time slot is connected to a G.703 port (Model 8779). <b>X</b> – The time slot is connected to a DSX-1 port (Models 8747, 8777).
<b>(Port Number)</b>
Possible Settings: <b>1–8</b> Default Setting: [Blank]
Determines the port to which this time slot is connected.
<b>(Time Slot Number)</b>
Possible Settings (Models 8747, 8777): <b>1–24</b> Default Setting: [Blank]
Possible Settings (Model 8779): <b>1–31</b> Default Setting: [Blank]
Determines the time slot to which this time slot is connected.
<b>(Data/Voice Selection)</b>
Possible Settings: <b>d, v</b> Default Setting: <b>d</b>
Determines whether the time slot is dedicated to the transmission of voice or data. <b>d</b> – The time slot is used for data. <b>v</b> – The time slot is used for voice.

**NOTES:**

If a G.703 port is configured for voice, time slot 16 is used for signaling and is not available for cross-connection.

Ensure that the number of DSL time slots defined is supported by the DSL line rate. The maximum number of useful DSL time slots is the DSL line rate divided by 64, rounded down to a whole number.

## Management and Communication Options Menu

The Management and Communication Menu allows you to access the following:

- [Telnet Session Options](#), Table A-11
- [General SNMP Management Options](#), Table A-12
- [SNMP NMS Security Options](#), Table A-13
- [SNMP Traps Options](#), Table A-14

### Telnet Session Options

The Telnet Session configuration options control whether a Telnet session is allowed through an interconnected IP Network. If allowed, these options determine what level of security to apply to the session to control access. Only one Telnet session is allowed at a time. Initial values are determined by the configuration you currently have loaded. To access the Telnet Sessions Options screen, follow this menu selection sequence:

*Main Menu → Configuration → Load Configuration From →  
Management and Communication → Telnet Session*

```

main/config/management/telnet
Slot: 18                                     Model: 87xx

                                TELNET SESSION OPTIONS

Telnet Session:                          Enable
Telnet Login Required:                    Enable
Session Access Level:                     Administrator
Inactivity Timeout:                       Enable
Disconnect Time (Minutes)                 5

-----
Ctrl-a to access these functions, ESC for previous menu      MainMenu  Exit
Save
    
```

**Table A-11. Telnet Session Options**

<b>Telnet Session</b>
Possible Settings: <b>Enable, Disable</b> Default Setting: <b>Enable</b>
Specifies if the unit will respond to a Telnet session request from a Telnet client on an interconnected IP network. <b>Enable</b> – Allows Telnet sessions between the unit and a Telnet client. <b>Disable</b> – No Telnet sessions allowed.
<b>Telnet Login Required</b>
Possible Settings: <b>Enable, Disable</b> Default Setting: <b>Disable</b>
Specifies whether a user ID and password are required to access to the ATI through a Telnet session. Login IDs are created with a password and access level. Refer to <i>Creating a Login</i> in Chapter 6, <i>Security</i> . <b>Enable</b> – Security is enabled. When access is attempted via Telnet, the user is prompted for a Login ID and password. <b>Disable</b> – No Login required for a Telnet session.
<b>Session Access Level</b>
Possible Settings: <b>Administrator, Operator</b> Default Setting: <b>Administrator</b>
The Telnet session access level is interrelated with the access level of the Login ID. Refer to <i>ATI Access Levels</i> in Chapter 6, <i>Security</i> , for more information. <b>Administrator</b> – This is the higher access level, permitting full control of the 87xx Termination Unit. Access level is determined by the Login ID. If Telnet Login Required is disabled, the session access level is Administrator. <b>Operator</b> – This is the lower access level, permitting read-only access to status and configuration screens.
<b>Inactivity Timeout</b>
Possible Settings: <b>Enable, Disable</b> Default Setting: <b>Disable</b>
Provides automatic logoff of a Telnet session. <ul style="list-style-type: none"> <li>■ Inactivity Timeout is forced to Enable if the unit is in a DSLAM running in IP conservative mode.</li> </ul> <b>Enable</b> – The Telnet session terminates automatically after the Disconnect Time. <b>Disable</b> – A Telnet session will not be closed due to inactivity.
<b>Disconnect Time (Minutes)</b>
Possible Settings: <b>1–60</b> Default Setting: <b>5</b>
Number of minutes of inactivity before a Telnet session terminates automatically. Timeout is based on no keyboard activity. <ul style="list-style-type: none"> <li>■ Disconnect Time (minutes) option appears when Inactivity Timeout is enabled.</li> </ul> <b>1 to 60</b> – The Telnet session is closed after the selected number of minutes.

## General SNMP Management Options

To access the General SNMP Management Options screen, follow this menu selection sequence:

*Main Menu → Configuration → Load Configuration From → Edit → Management and Communication → SNMP*

```
main/config/management/SNMP
Slot: 4                                     Model: 87xx

                                GENERAL SNMP MANAGEMENT OPTIONS

SNMP Management:      Enable

Community Name 1:    Public                Clear
Name 1 Access:      Read/Write
Community Name 2:    Public                Clear
Name 2 Access:      Read/Write

-----
Ctrl-a to access these functions, ESC for previous menu      MainMenu  Exit
Save
```

The Community Name and Name Access configuration options are not available if the unit is an LTU in a DSLAM running in IP Conservative mode.

**Table A-12. General SNMP Management Options**

<b>SNMP Management</b>
Possible Settings: <b>Enable, Disable</b> Default Setting: <b>Enable</b>
Enable or disables the SNMP management features. <b>Enable</b> – Enables SNMP management capabilities. <b>Disable</b> – Disables SNMP management capabilities.
<b>Community Name 1</b>
Possible Settings: <b>[ASCII text field]</b> Default Text: <b>Public</b>
Identifies the name of the community allowed to access the unit's MIB. The community name must be supplied by an external SNMP manager when that manager attempts to access an object in the MIB. <ul style="list-style-type: none"> <li>■ This field does not appear if the unit is an LTU in a DSLAM running in IP conservative mode.</li> </ul> <b>Text Field</b> – Enter or edit a community name. <b>Clear</b> – Clears the community name field.
<b>Name 1 Access</b>
Possible Settings: <b>Read, Read/Write</b> Default Setting: <b>Read/Write</b>
Determines the access level for Community Name 1. <ul style="list-style-type: none"> <li>■ This field does not appear if the unit is an LTU in a DSLAM running in IP conservative mode.</li> </ul> <b>Read</b> – Allows read-only access (get) for Community Name 1. <b>Read/Write</b> – Allows read/write access (get) for Community Name 1.
<b>Community Name 2</b>
Possible Settings: <b>[ASCII text field]</b> Default Text: [null string]
Identifies the name of the second community allowed to access the unit's MIB. The community name must be supplied by an external SNMP manager when that manager attempts to access an object in the MIB. <ul style="list-style-type: none"> <li>■ This field does not appear if the unit is an LTU in a DSLAM running in IP conservative mode.</li> </ul> <b>Text Field</b> – Enter or edit a community name. <b>Clear</b> – Clears the community name field.
<b>Name 2 Access</b>
Possible Settings: <b>Read, Read/Write</b> Default Setting: <b>Read</b>
Determines the access level for Community Name 2. <ul style="list-style-type: none"> <li>■ This field does not appear if the unit is an LTU in a DSLAM running in IP conservative mode.</li> </ul> <b>Read</b> – Allows read-only access (get) for Community Name 2. <b>Read/Write</b> – Allows read/write access (get/set) for Community Name 2.

## SNMP NMS Security Options

To access the SNMP NMS Security Options screen, follow this menu selection sequence:

*Main Menu → Configuration → Load Configuration From → Edit →  
Management and Communication → Security*

```
main/config/management/security
Slot: 4                                     Model: 87xx

                                SNMP NMS SECURITY OPTIONS

                                NMS IP Validation: Enable
                                Number of Managers: 5

NMS 1 IP Address: 135.014.040.001 Clear      Access Type: Read/Write
NMS 2 IP Address: 135.014.003.027 Clear      Access Type: Read/Write
NMS 3 IP Address: 135.014.001.008 Clear      Access Type: Read
NMS 4 IP Address: 135.014.002.024 Clear      Access Type: Read
NMS 5 IP Address: 204.128.146.035 Clear      Access Type: Read

-----
Ctrl-a to access these functions, ESC for previous menu      MainMenu Exit
Save
```

The SNMP NMS Security configuration options screen is not available in IP Conservative mode.



**Table A-13. SNMP NMS Security Options**

<b>NMS IP Validation</b>
Possible Settings: <b>Enable, Disable</b> Default Setting: <b>Disable</b>
Specifies whether security checking is performed on the IP address of SNMP management systems attempting to access the node.  <b>Enable</b> – Security checking is performed on the IP address of SNMP management systems attempting to access the node.  <b>Disable</b> – No security checking is performed.
<b>Number of Managers</b>
Possible Settings: <b>1, 2, 3, 4, 5, 6, 7, 8, 9, 10</b> Default Setting: <b>1</b>
Specifies the number of SNMP management systems that can send SNMP messages.  <b>1 to 5</b> – Number of trap managers. An NMS IP address is required for each manager.
<b>NMS <i>n</i> IP Address</b>
Possible Settings: <b>001.000.000.000 – 223.255.255.255, Clear</b> Default Setting: <b>000.000.000.000</b>
Specifies the Internet Protocol address used to identify each SNMP manager.  <b>001.000.000.000 – 223.255.255.255</b> – Enter an address for each SNMP manager. The range for the first byte is 001 to 223, with the exception of 127. The range for the remaining three bytes is 000 to 255.  <b>Clear</b> – Clears the IP address and sets to all zeros.
<b>Access Type</b>
Possible Settings: <b>Read, Read/Write</b> Default Setting: <b>Read</b>
Determines the access level allowed for an authorized NMS when IP address validation is being performed.  <b>Read</b> – Allows read-only access (get) to the accessible objects in the MIB for this device.  <b>Read/Write</b> – Allows read/write access (get/set) to the accessible objects in the MIB for this device.

## SNMP Traps Options

An SNMP trap can be automatically sent out through the EOC or the Management port to the SNMP manager when the unit detects conditions set by the user. These traps enable the SNMP manager to gauge the state of the network. Refer to Appendix B, *Standards Compliance for SNMP Traps*, for details of SNMP traps supported by the Hotwire Termination Unit.

To configure the unit for SNMP traps, use the SNMP Traps Options screen to:

- Enable SNMP traps.
- Set the number of SNMP managers that receive SNMP traps from the unit.
- Enter an IP address and network destination for each SNMP manager specified.
- Select the type of SNMP traps to be sent from the unit.

To access the SNMP Traps Options screen, follow this menu selection sequence:

*Main Menu → Configuration → Load Configuration From → Edit → Management and Communication → SNMP Traps*

```

main/config/management/trap
Slot: 4
Model: 87xx

SNMP TRAPS OPTIONS

SNMP Traps:      Enable      Number of Trap Managers: 9

NMS 1 IP Address: 135.014.040.001 Clear
NMS 2 IP Address: 135.014.003.027 Clear
NMS 3 IP Address: 135.014.001.008 Clear
NMS 4 IP Address: 135.014.002.024 Clear
NMS 5 IP Address: 204.128.146.035 Clear
NMS 6 IP Address: 135.014.003.028 Clear
NMS 7 IP Address: 135.014.001.009 Clear
NMS 8 IP Address: 135.014.002.025 Clear
NMS 9 IP Address: 204.128.146.036 Clear

General Traps:   Both      Enterprise Specific Traps: Disable
Link Traps:      Both      Link Traps Interfaces:   All

-----
Ctrl-a to access these functions, ESC for previous menu   MainMenu   Exit
Save
    
```

**Table A-14. SNMP Traps Options (1 of 2)**

<b>SNMP Traps</b>
Possible Settings: <b>Enable, Disable</b> Default Setting: <b>Disable</b>
Controls the generation of SNMP trap messages. <b>Enable</b> – SNMP trap messages are sent out to SNMP managers. <b>Disable</b> – No SNMP trap messages are sent out.
<b>Number of Trap Managers</b>
Possible Settings: <b>1, 2, 3, 4, 5, 6, 7, 8, 9</b> Default Setting: <b>1</b>
Sets the number of SNMP management systems that will receive SNMP traps. <ul style="list-style-type: none"> <li>■ This field is not available when the unit is running in IP Conservative mode.</li> </ul> <b>1 to 9</b> – Number of trap managers. An NMS IP address is required for each manager.
<b>NMS <i>n</i> IP Address</b>
Possible Settings: <b>001.000.000.000 – 223.255.255.255, Clear</b> Default Setting: <b>000.000.000.000</b>
Specifies the Internet Protocol address used to identify each SNMP trap manager. <ul style="list-style-type: none"> <li>■ This field is not available when the unit is running in IP Conservative mode.</li> </ul> <b>001.000.000.000 – 223.255.255.255</b> – Enter an address for each SNMP trap manager. The range for the first byte is 001 to 223, with the exception of 127. The range for the remaining three bytes is 000 to 255. <b>Clear</b> – Clears the IP address and sets to all zeros.
<b>NMS <i>n</i> Destination</b>
Possible Settings: <b>IMC, DSL1, DSL2, DSL3, DSL4, DSL5, DSL6, DSL7, DSL8</b> Default Setting: <b>IMC</b>
Provides the network destination path of each trap manager. <ul style="list-style-type: none"> <li>■ NMS <i>n</i> Destination is available only when the unit is configured as an NTU and not running in IP Conservative mode. Disabled ports cannot be specified.</li> </ul> <b>IMC</b> – The Internal Management Channel (IMC) is the default network destination. This is the management interface to the MCC card in the DSLAM. <b>DSL1 to DSL8</b> – The specified port is the network destination.
<b>General Traps</b>
Possible Settings: <b>Disable, Warm, AuthFail, Both</b> Default Setting: <b>Both</b>
Determines which SNMP traps are sent to each trap manager. <b>Disable</b> – No general trap messages are sent. <b>Warm</b> – Sends trap message for <i>warmStart</i> events. <b>AuthFail</b> – Sends trap message for <i>authenticationFailure</i> events. <b>Both</b> – Sends both trap messages. NOTE: Refer to Appendix B, <i>Standards Compliance for SNMP Traps</i> .

**Table A-14. SNMP Traps Options (2 of 2)**

<b>Enterprise Specific Traps</b>
Possible Settings: <b>Enable, Disable</b> Default Setting: <b>Disable</b>
Determines if SNMP traps are generated for enterprise-specific events. <b>Enable</b> – SNMP traps are generated for <i>enterpriseSpecific</i> events. NOTE: Refer to <i>Enterprise Specific Traps</i> in Appendix B, <i>Standards Compliance for SNMP Traps</i> . <b>Disable</b> – No enterprise-specific event traps are sent.
<b>Link Traps</b>
Possible Settings: <b>Disable, Up, Down, Both</b> Default Setting: <b>Both</b>
Determines if SNMP traps are generated for link up and link down for one of the communication interfaces. <b>Disable</b> – No <i>linkUp</i> or <i>linkDown</i> SNMP traps are generated. <b>Up</b> – A <i>linkUp</i> trap is generated when the unit recognizes that one of the communication interfaces is operational. <b>Down</b> – A <i>linkDown</i> trap is generated when the unit recognizes a failure in one of the communication interfaces. <b>Both</b> – Sends trap messages for detection of both <i>linkUp</i> and <i>linkDown</i> . NOTE: Refer to <i>linkUp and linkDown</i> in Appendix B, <i>Standards Compliance for SNMP Traps</i> .
<b>Link Traps Interfaces</b>
Possible Settings: <b>Network, DSX-1, All</b> Default Setting: <b>All</b>
Determines if the SNMP <i>linkUp</i> , SNMP <i>linkDown</i> , and interface-related <i>enterpriseSpecific</i> traps are generated for the network DSL interface and/or DSX-1 interface (DTE). <b>Network</b> – SNMP trap messages are generated for the DSL network interface. <b>DSX-1</b> – SNMP trap messages are generated for the DSX-1 interface. <b>All</b> – SNMP trap messages are generated for the DSL network interface, COM port, and DSX-1 interface.

---

# Standards Compliance for SNMP Traps

# B

---

## SNMP Traps

This section describes the unit's compliance with SNMP standards and any special operational features for the SNMP traps supported. The unit supports the following traps:

- warmStart
- authenticationFailure
- linkUp
- linkDown
- Enterprise-specific traps

## ifIndex

The object ifIndex is a variable binding for several traps. The following ifIndex values are supported for Hotwire 87xx Termination Units:

ifIndex	Description
3–10	DSL Interface Ports 1–8
15–22	DSX-1 or G.703 Interface Ports 1–8
39–46	EOC Management Link Ports 1–8

For a unit defined as an LTU running IP Conservative software or a unit not running IP conservative software, all traps have at a minimum a variable binding of the Overloaded ifIndex (OI). The formula for the OI is:

$((\text{LTU Slot Number}) * 1,000)$   
+ ifIndex.

For a unit defined as an NTU running IP Conservative software, all traps have at a minimum a variable binding of the Super Overloaded ifIndex (SOI). The formula for the SOI is:

((LTU Slot Number) \* 1,000,000)  
+ ((LTU DSL Port Number) \* 1,000)  
+ the NTU's ifIndex.

## warmStart

SNMP Trap	Description	Possible Cause
warmStart	The unit has reinitialized itself.  The trap is sent after the unit resets and stabilizes.  No variable bindings.	<ul style="list-style-type: none"><li>■ Reset command.</li><li>■ Power disruption.</li></ul>

## authenticationFailure

SNMP Trap	Description	Possible Cause
authenticationFailure	Failed attempts to access the unit.  Variable bindings: <ul style="list-style-type: none"><li>■ devAuthenticationFailureIPAddress (Health &amp; Status MIB)</li></ul> Returns zero if the IP address is unknown or the failure came from the terminal port.	Three unsuccessful attempts were made to enter a correct login/password combination.

## linkUp and linkDown

The link SNMP traps are:

- **linkUp** – The unit recognizes that one of the communication interfaces is operational.
- **linkDown** – The unit recognizes that one of the communication interfaces is not operational.

The network and synchronous port interfaces (physical sublayer) are represented by an entry in the MIB-II interfaces table and supported by the DS1 MIB.

The following list describes the conditions that define linkUp and linkDown:

<b>linkUp/Down variable bindings</b>
<ul style="list-style-type: none"> <li>■ <b>ifIndex (RFC 1573)</b> This object provides the index into the ifTable and potentially into tables in other MIBs. The ifIndexes supported are:               <ul style="list-style-type: none"> <li>– 3–10 DSL Network Interface</li> <li>– 15–22 DSX-1 or G.703 Port</li> <li>– 39–46 EOC Management Link</li> </ul> </li> <li>■ <b>ifAdminStatus (RFC 1573)</b> This object specifies the operational state of the interface:               <ul style="list-style-type: none"> <li>– up(1) The interface is enabled.</li> <li>– down(2) The interface is disabled.</li> </ul> </li> <li>■ <b>ifOperStatus (RFC 1573)</b> This object specifies the operational state of the interface:               <ul style="list-style-type: none"> <li>– up(1) DSL Port: DSL link is established and no alarms exist. DSX-1 or G.703 Port: No alarm conditions exist. EOC: Based on the state of the link layer protocol.</li> <li>– down(2) DSL Port: DSL link is not established or alarms exist. DSX-1 or G.703 Port: Alarm condition exists. EOC: Based on the state of the link layer protocol.</li> <li>– testing(3) DSL, DSX-1 or G.703 Port: A test is active on the port.</li> <li>– dormant(5) DSL Port: DSL link is negotiating.</li> </ul> </li> </ul>

**linkUp/Down variable bindings, continued**

■ ifType (RFC 1573)

This object is the type of interface:

- other(1)  
Used for the backplane HDLC interface.
- ds1 (18)  
Used for DSX-1 interface
- e1 (19)  
Used for G.703 interface
- propPointToPointSerial(22)  
Used for EOC.
- v35(45)  
Used for the EIA-530-A port.
- sdsl(96)  
Used for the DSL network interface.



## Enterprise-Specific Traps

The enterpriseSpecific trap indicates that an enterprise-specific event has occurred. The Specific-trap field identifies the particular trap that occurred. The following table lists the enterprise-specific traps supported by the unit:

SNMP Trap	Description	Possible Cause
enterprisePrimaryClockFail(1)	The unit has lost its primary clock source. No variable bindings.	Hardware failure in the unit or the clock source.
enterpriseSelfTestFail(2)	A hardware failure of the unit is detected during the unit's self-test. The trap is generated after the unit completes initialization. Variable bindings: <ul style="list-style-type: none"> <li>■ devSelfTestResults</li> </ul>	Failure of one or more of the unit's hardware components.
enterpriseDeviceFail(3)	An internal device failure. No variable bindings.	Operating software has detected an internal device failure.
enterpriseSecondaryClockFail(4)	The unit has lost its secondary clock source. No variable bindings.	Hardware failure in the unit or the clock source.
enterpriseTestStart(5)	A test is running. Variable bindings: <ul style="list-style-type: none"> <li>■ devSelfTestResults</li> <li>■ ifIndex (RFC 1573)</li> <li>■ ifAdminStatus (RFC 1573)</li> <li>■ ifOperStatus (RFC 1573)</li> <li>■ ifType (RFC 1573)</li> <li>■ ifTestType (RFC 1573)</li> </ul>	At least one test has been started on an interface.
enterpriseConfigChange(6)	The configuration changed via the user interface. The trap is sent after 60 seconds have elapsed without another change. This suppresses the sending of numerous traps when multiple changes are made in a short period of time, as is typically the case when changing configuration options. No variable bindings.	Configuration has been changed via the ATI.

SNMP Trap	Description	Possible Cause
enterpriseFallbackAutoRate(13)	<p>After a loss of signal, the unit resynchronized to a lower rate than the last known rate.</p> <p>Variable bindings:</p> <ul style="list-style-type: none"> <li>■ ifIndex (RFC 1573)</li> <li>■ ifAdminStatus (RFC 1573)</li> <li>■ ifOperStatus (RFC 1573)</li> <li>■ ifType (RFC 1573)</li> </ul>	Variable line conditions.
enterprisePrimaryClockFailClear(101)	<p>The LTU has recovered and is using its primary clock source.</p> <p>No variable bindings.</p>	
enterpriseSecondaryClockFailClear(104)	<p>The LTU has recovered and is using its secondary clock source.</p> <p>No variable bindings.</p>	
enterpriseTestStop(105)	<p>All tests have been halted.</p> <p>Variable bindings:</p> <ul style="list-style-type: none"> <li>■ ifIndex (RFC 1573)</li> <li>■ ifAdminStatus (RFC 1573)</li> <li>■ ifOperStatus (RFC 1573)</li> <li>■ ifType (RFC 1573)</li> <li>■ ifTestType (RFC 1573)</li> </ul>	All tests on an interface have been stopped by timeout or an Abort All Tests command.
enterpriseFallbackAutoRateClear(113)	<p>After an AutoRate fallback condition, the unit resynchronized to the last known rate.</p> <p>Variable bindings:</p> <ul style="list-style-type: none"> <li>■ ifIndex (RFC 1573)</li> <li>■ ifAdminStatus (RFC 1573)</li> <li>■ ifOperStatus (RFC 1573)</li> <li>■ ifType (RFC 1573)</li> </ul>	

The tests that affect the enterpriseTestStart and enterpriseTestStop traps and the variable bindings depend on the interface. The specific tests and variable bindings are described in the following table:

<b>Interface</b>	<b>enterpriseTestStart/Stop variable bindings</b>	<b>Possible Cause</b>
DSL Network	<ul style="list-style-type: none"> <li>■ ifIndex (RFC 1573)</li> <li>■ ifAdminStatus (RFC 1573)</li> <li>■ ifOperStatus (RFC 1573)</li> <li>■ ifType (RFC 1573)</li> <li>■ ifTestType (RFC 1573)</li> </ul> <p>The following objects control tests in SNMP-managed devices:</p> <ul style="list-style-type: none"> <li>– noTest(0) – Stops the test in progress.</li> <li>– testLoopLLB(4) – Initiates a Local Loopback.</li> <li>– testSendMon511(6) – Initiates a Send and Monitor 511 test.</li> <li>– testSendLLBUp(7) – Initiates an LLB Up message to the remote unit.</li> <li>– testSendLLBDown(8) – Initiates an LLB Down message to the remote unit.</li> </ul>	<ul style="list-style-type: none"> <li>■ enterpriseTest Start – Any one of the following tests is active on the interface: <ul style="list-style-type: none"> <li>– Line Loopback</li> <li>– Remote Line Loopback</li> <li>– Send and Monitor 511</li> </ul> </li> <li>■ enterpriseTest Stop – No tests currently running on the interface.</li> </ul>
DSX-1 or G.703	<ul style="list-style-type: none"> <li>■ ifIndex (RFC 1573)</li> <li>■ ifAdminStatus (RFC 1573)</li> <li>■ ifOperStatus (RFC 1573)</li> <li>■ ifType (RFC 1573)</li> <li>■ ifTestType (RFC 1573)</li> </ul> <p>The following objects control tests in SNMP-managed devices:</p> <ul style="list-style-type: none"> <li>– noTest(0) – Stops the test in progress.</li> <li>– testLoopDTLB(3) – Initiates a DTE Loopback.</li> <li>– testLoopPLB(1) – A Telco-initiated Payload Loopback is active on the interface (DSX-1 only).</li> <li>– testLoopRLB(5) – Initiates a Remote Loopback.</li> </ul>	<ul style="list-style-type: none"> <li>■ enterpriseTest Start – Any one of the following tests is active on the interface: <ul style="list-style-type: none"> <li>– DTE Loopback</li> <li>– Repeater Loopback</li> <li>– Telco Payload Loopback (DSX-1 only)</li> </ul> </li> <li>■ enterpriseTest Stop – No tests currently running on the interface.</li> </ul>



# Connector Pin Assignments

# C

## Hotwire Termination Unit Front Panel 50-pin DTE Connector Pinouts

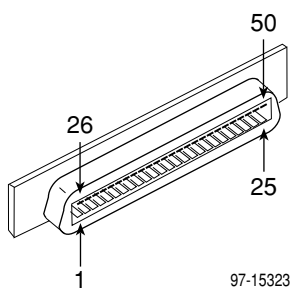

The DTE connectors on the Hotwire Termination Unit provide the 4-wire DSX-1 or G.703 interface from each DSL port to the DTE. The following table lists the pin assignments for each of these interfaces.

**Table C-1. Front Panel DTE Connector Pinouts (1 of 2)**

DSX-1 or G.703 Port	50-Pin Connector Pinout	Function
Port 1	27	Data Out (Ring)
	2	Data Out (Tip)
	26	Data In (Tip)
	1	Data In (Ring)
Port 2	30	Data Out (Ring)
	5	Data Out (Tip)
	29	Data In (Tip)
	4	Data In (Ring)
Port 3	33	Data Out (Ring)
	8	Data Out (Tip)
	32	Data In (Tip)
	7	Data In (Ring)

**Table C-1. Front Panel DTE Connector Pinouts (2 of 2)**

<b>DSX-1 or G.703 Port</b>	<b>50-Pin Connector Pinout</b>	<b>Function</b>
Port 4	36	Data Out (Ring)
	11	Data Out (Tip)
	35	Data In (Tip)
	10	Data In (Ring)
Port 5	39	Data Out (Ring)
	14	Data Out (Tip)
	38	Data In (Tip)
	13	Data In (Ring)
Port 6	42	Data Out (Ring)
	17	Data Out (Tip)
	41	Data In (Tip)
	16	Data In (Ring)
Port 7	45	Data Out (Ring)
	20	Data Out (Tip)
	44	Data In (Tip)
	19	Data In (Ring)
Port 8	48	Data Out (Ring)
	23	Data Out (Tip)
	47	Data In (Tip)
	22	Data In (Ring)

## Model 8610, 8810, and 8820 DSLAM Telco 50-pin Connector Pinouts

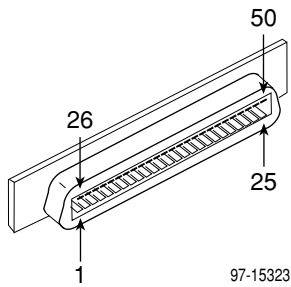

The Telco 50-pin connectors on the rear of the DSLAM chassis (numbered 1–3 in 8600 Series DSLAMs and 1–18 in 8800 Series DSLAMs) provide the 2-wire loop interface from each DSL port to either the POTS splitter shelf or, if the loop is not being shared with POTS, then to the Main Distribution Frame (MDF). The following table lists the pin assignments for each of these interfaces.

**Table C-2. Rear Connector Pinouts**

Port	Connector Pins (Tip, Ring)
Port 1	1, 26
Port 2	2, 27
Port 3	3, 28
Port 4	4, 29
Port 5	5, 30
Port 6	6, 31
Port 7	7, 32
Port 8	8, 33





---

# Technical Specifications

# D

---

Specifications	Criteria*
<b>Size</b>	Length 10 inches (25.4 cm) Height 12.3 inches (31.1 cm) Width 0.8 inch (2.0 cm)
<b>Weight</b>	Approximately 1.24 lbs. (0.56 kg)
<b>Approvals</b> Safety Certifications	Refer to the equipment's label for approvals on product.
<b>Power</b>	The Hotwire Termination Unit contains a dc-to-dc converter that requires -48V power input. The -48V power is distributed through the Hotwire DSLAM backplane. Maximum Power Dissipation = 27 watts
<b>Physical Environment</b> Operating temperature Storage temperature Relative humidity Shock and vibration	32° to 122° F (0° to 50° C) -4° F (-20° C) to 158° F (70° C) 5% to 85% (noncondensing) Withstands normal shipping and handling.
* Technical specifications are subject to change without notice.	



---

# Cross-Connection Worksheets



---

## Using the Worksheets

The following worksheets are designed to help plan, visualize, and configure a cross-connection. Time slot assignment worksheets are supplied to represent a connection from the viewpoint of the DSX-1 or G.703 ports, or the associated DSL ports. The unit can be configured using either viewpoint, so it may not be necessary or useful to fill in all the worksheets.

Use the completed port connection diagram and time slot assignment worksheets to configure the cross-connection using the Cross-Connect Mode and Assign Time Slots screens. See Chapter 4, *Cross-Connecting Ports*, for an example of cross-connection.

## Port Connection Diagram

Select Voice and/or Data for each port. Draw lines to show the connection of DSX-1 or G.703 ports to DSL ports and mark each connections as one of:

- DS1 Bypass
- DS0 Cross-Connect
- DS1 Cross-Connect

See *Determining the Configuration* in Chapter 4, *Cross-Connecting Ports*, for a sample completed port connection diagram.

Port 1 <input type="checkbox"/> Voice <input type="checkbox"/> Data	DSX-1 G.703	DSL	Port 1
Port 2 <input type="checkbox"/> Voice <input type="checkbox"/> Data	DSX-1 G.703	DSL	Port 2
Port 3 <input type="checkbox"/> Voice <input type="checkbox"/> Data	DSX-1 G.703	DSL	Port 3
Port 4 <input type="checkbox"/> Voice <input type="checkbox"/> Data	DSX-1 G.703	DSL	Port 4
Port 5 <input type="checkbox"/> Voice <input type="checkbox"/> Data	DSX-1 G.703	DSL	Port 5
Port 6 <input type="checkbox"/> Voice <input type="checkbox"/> Data	DSX-1 G.703	DSL	Port 6
Port 7 <input type="checkbox"/> Voice <input type="checkbox"/> Data	DSX-1 G.703	DSL	Port 7
Port 8 <input type="checkbox"/> Voice <input type="checkbox"/> Data	DSX-1 G.703	DSL	Port 8

99-16602

## DSX-1 Time Slot Assignments

Fill in the port number and time slot cross-connection and data/voice mode for each time slot. Then transfer the entries to the Assign Time Slots screen.

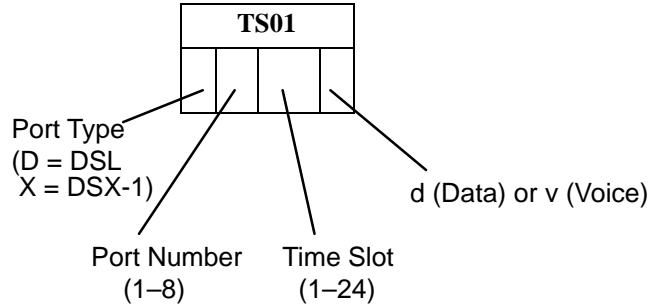

### Time Slot Assignments – DSX-1 Port 1

TS01		TS02		TS03		TS04		TS05		TS06		TS07	
D		D		D		D		D		D		D	
TS08		TS09		TS10		TS11		TS12		TS13		TS14	
D		D		D		D		D		D		D	
TS15		TS16		TS17		TS18		TS19		TS20		TS21	
D		D		D		D		D		D		D	
TS22		TS23		TS24									
D		D		D									

### Time Slot Assignments – DSX-1 Port 2

TS01		TS02		TS03		TS04		TS05		TS06		TS07	
D		D		D		D		D		D		D	
TS08		TS09		TS10		TS11		TS12		TS13		TS14	
D		D		D		D		D		D		D	
TS15		TS16		TS17		TS18		TS19		TS20		TS21	
D		D		D		D		D		D		D	
TS22		TS23		TS24									
D		D		D									

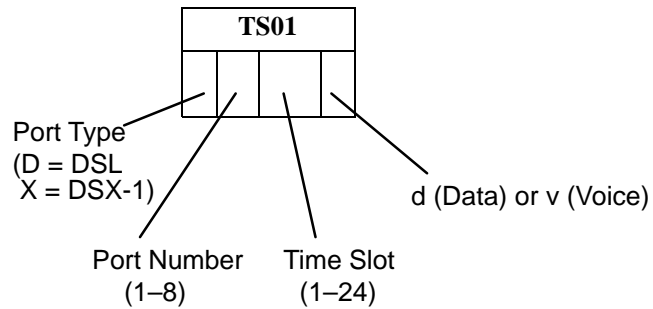

**Time Slot Assignments – DSX-1 Port 3**

TS01	TS02	TS03	TS04	TS05	TS06	TS07
D				D		
D				D		
D				D		
D				D		
D				D		
D				D		
D				D		
D				D		
D				D		
D				D		
D				D		
D				D		

**Time Slot Assignments – DSX-1 Port 4**

TS01	TS02	TS03	TS04	TS05	TS06	TS07
D				D		
D				D		
D				D		
D				D		
D				D		
D				D		
D				D		
D				D		
D				D		
D				D		
D				D		
D				D		

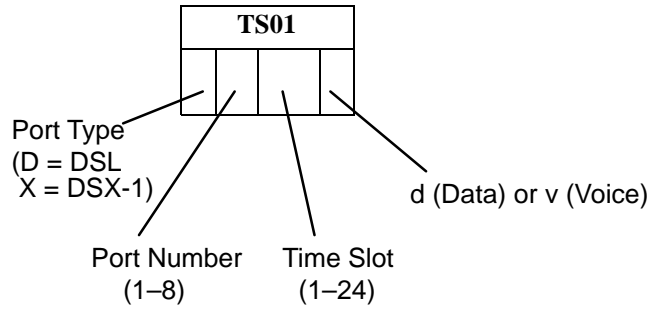

**Time Slot Assignments – DSX-1 Port 5**

TS01				TS02				TS03				TS04				TS05				TS06				TS07							
D				D				D				D				D				D				D				D			
TS08				TS09				TS10				TS11				TS12				TS13				TS14							
D				D				D				D				D				D				D				D			
TS15				TS16				TS17				TS18				TS19				TS20				TS21							
D				D				D				D				D				D				D				D			
TS22				TS23				TS24																							
D				D				D																							

**Time Slot Assignments – DSX-1 Port 6**

TS01				TS02				TS03				TS04				TS05				TS06				TS07							
D				D				D				D				D				D				D				D			
TS08				TS09				TS10				TS11				TS12				TS13				TS14							
D				D				D				D				D				D				D				D			
TS15				TS16				TS17				TS18				TS19				TS20				TS21							
D				D				D				D				D				D				D				D			
TS22				TS23				TS24																							
D				D				D																							

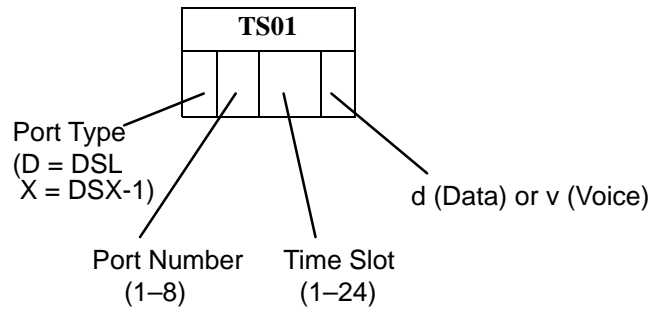

**Time Slot Assignments – DSX-1 Port 7**

<b>TS01</b>	<b>TS02</b>	<b>TS03</b>	<b>TS04</b>	<b>TS05</b>	<b>TS06</b>	<b>TS07</b>
D	D	D	D	D	D	D
<b>TS08</b>	<b>TS09</b>	<b>TS10</b>	<b>TS11</b>	<b>TS12</b>	<b>TS13</b>	<b>TS14</b>
D	D	D	D	D	D	D
<b>TS15</b>	<b>TS16</b>	<b>TS17</b>	<b>TS18</b>	<b>TS19</b>	<b>TS20</b>	<b>TS21</b>
D	D	D	D	D	D	D
<b>TS22</b>	<b>TS23</b>	<b>TS24</b>				
D	D	D				

**Time Slot Assignments – DSX-1 Port 8**

<b>TS01</b>	<b>TS02</b>	<b>TS03</b>	<b>TS04</b>	<b>TS05</b>	<b>TS06</b>	<b>TS07</b>
D	D	D	D	D	D	D
<b>TS08</b>	<b>TS09</b>	<b>TS10</b>	<b>TS11</b>	<b>TS12</b>	<b>TS13</b>	<b>TS14</b>
D	D	D	D	D	D	D
<b>TS15</b>	<b>TS16</b>	<b>TS17</b>	<b>TS18</b>	<b>TS19</b>	<b>TS20</b>	<b>TS21</b>
D	D	D	D	D	D	D
<b>TS22</b>	<b>TS23</b>	<b>TS24</b>				
D	D	D				



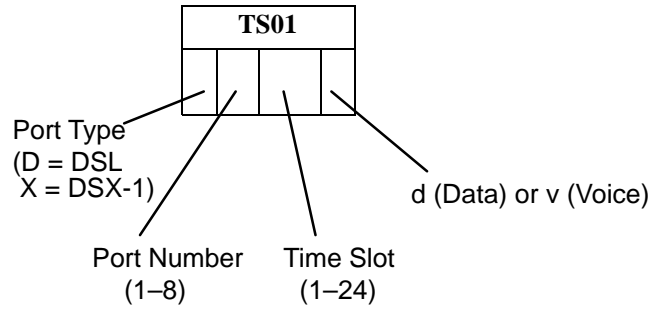

**Time Slot Assignments – DSL Port 1**

TS01	TS02	TS03	TS04	TS05	TS06	TS07
X	X	X	X	X	X	X
TS08	TS09	TS10	TS11	TS12	TS13	TS14
X	X	X	X	X	X	X
TS15	TS16	TS17	TS18	TS19	TS20	TS21
X	X	X	X	X	X	X
TS22	TS23	TS24				
X	X	X				

**Time Slot Assignments – DSL Port 2**

TS01	TS02	TS03	TS04	TS05	TS06	TS07
X	X	X	X	X	X	X
TS08	TS09	TS10	TS11	TS12	TS13	TS14
X	X	X	X	X	X	X
TS15	TS16	TS17	TS18	TS19	TS20	TS21
X	X	X	X	X	X	X
TS22	TS23	TS24				
X	X	X				

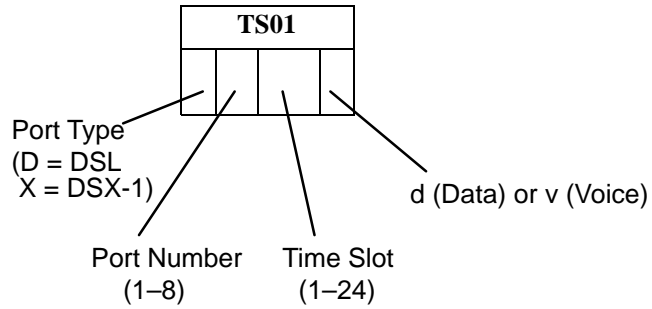

**Time Slot Assignments – DSL Port 3**

TS01	TS02	TS03	TS04	TS05	TS06	TS07
X	X	X	X	X	X	X
TS08	TS09	TS10	TS11	TS12	TS13	TS14
X	X	X	X	X	X	X
TS15	TS16	TS17	TS18	TS19	TS20	TS21
X	X	X	X	X	X	X
TS22	TS23	TS24				
X	X	X				

**Time Slot Assignments – DSL Port 4**

TS01	TS02	TS03	TS04	TS05	TS06	TS07
X	X	X	X	X	X	X
TS08	TS09	TS10	TS11	TS12	TS13	TS14
X	X	X	X	X	X	X
TS15	TS16	TS17	TS18	TS19	TS20	TS21
X	X	X	X	X	X	X
TS22	TS23	TS24				
X	X	X				

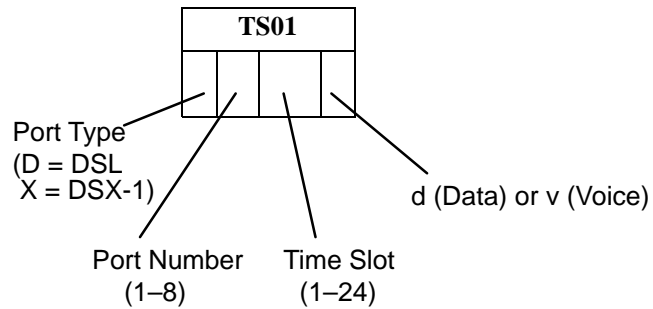

**Time Slot Assignments – DSL Port 5**

TS01	TS02	TS03	TS04	TS05	TS06	TS07
X				X		
X				X		
X				X		
X				X		
X				X		
X				X		
X				X		
X				X		
X				X		
X				X		
X				X		

**Time Slot Assignments – DSL Port 6**

TS01	TS02	TS03	TS04	TS05	TS06	TS07
X				X		
X				X		
X				X		
X				X		
X				X		
X				X		
X				X		
X				X		
X				X		
X				X		
X				X		

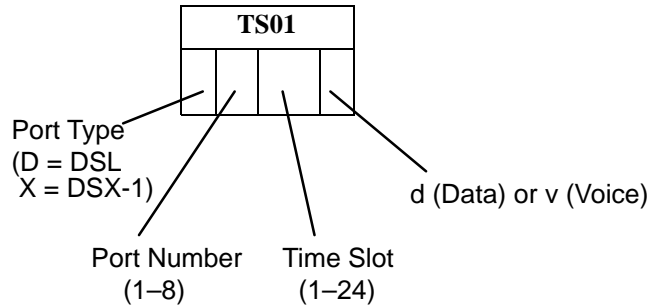

**Time Slot Assignments – DSL Port 7**

TS01				TS02				TS03				TS04				TS05				TS06				TS07											
X				X				X				X				X				X				X											
TS08				TS09				TS10				TS11				TS12				TS13				TS14											
X				X				X				X				X				X				X											
TS15				TS16				TS17				TS18				TS19				TS20				TS21											
X				X				X				X				X				X				X											
TS22				TS23				TS24																											
X				X				X																											

**Time Slot Assignments – DSL Port 8**

TS01				TS02				TS03				TS04				TS05				TS06				TS07											
X				X				X				X				X				X				X											
TS08				TS09				TS10				TS11				TS12				TS13				TS14											
X				X				X				X				X				X				X											
TS15				TS16				TS17				TS18				TS19				TS20				TS21											
X				X				X				X				X				X				X											
TS22				TS23				TS24																											
X				X				X																											

## G.703 Time Slot Assignments

Fill in the port number and time slot cross-connection and data/voice mode for each time slot. Then transfer the entries to the Assign Time Slots screen.

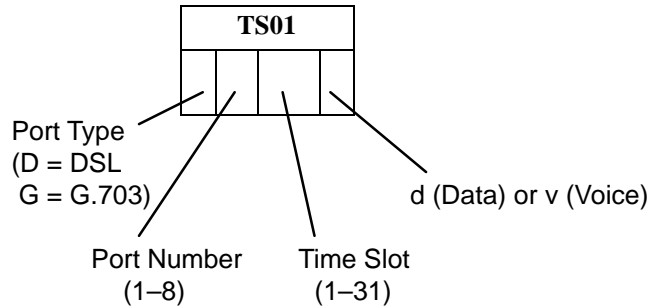

### Time Slot Assignments – G.703 Port 1

<b>TS01</b>	<b>TS02</b>	<b>TS03</b>	<b>TS04</b>	<b>TS05</b>	<b>TS06</b>	<b>TS07</b>
D	D	D	D	D	D	D
<b>TS08</b>	<b>TS09</b>	<b>TS10</b>	<b>TS11</b>	<b>TS12</b>	<b>TS13</b>	<b>TS14</b>
D	D	D	D	D	D	D
<b>TS15</b>	<b>TS16*</b>	<b>TS17</b>	<b>TS18</b>	<b>TS19</b>	<b>TS20</b>	<b>TS21</b>
D	D	D	D	D	D	D
<b>TS22</b>	<b>TS23</b>	<b>TS24</b>	<b>TS25</b>	<b>TS26</b>	<b>TS27</b>	<b>TS28</b>
D	D	D	D	D	D	D
<b>TS29</b>	<b>TS30</b>	<b>TS31</b>				
D	D	D				

**\*NOTE:**

When a G.703 port is configured for Channel Associated Signaling (CAS), Time Slot 16 is used for signaling and is unavailable for cross-connection. When a G.703 port is configured for Common Channel Signaling (CCS) in a DS0 Cross Connect, the user must cross-connect Time Slot 16 and any associated time slots.

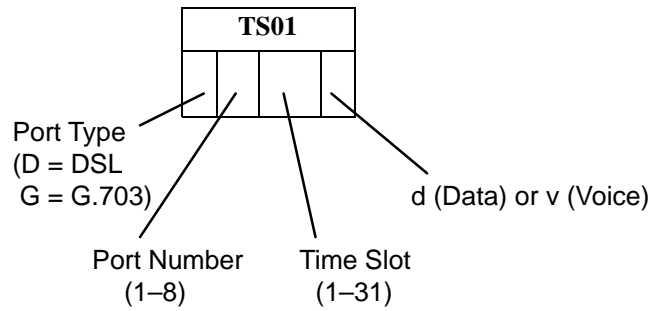

**Time Slot Assignments – G.703 Port 2**

<b>TS01</b>				<b>TS02</b>				<b>TS03</b>				<b>TS04</b>				<b>TS05</b>				<b>TS06</b>				<b>TS07</b>											
D				D				D				D				D				D				D				D							
<b>TS08</b>				<b>TS09</b>				<b>TS10</b>				<b>TS11</b>				<b>TS12</b>				<b>TS13</b>				<b>TS14</b>											
D				D				D				D				D				D				D				D							
<b>TS15</b>				<b>TS16*</b>				<b>TS17</b>				<b>TS18</b>				<b>TS19</b>				<b>TS20</b>				<b>TS21</b>											
D				D				D				D				D				D				D				D							
<b>TS22</b>				<b>TS23</b>				<b>TS24</b>				<b>TS25</b>				<b>TS26</b>				<b>TS27</b>				<b>TS28</b>											
D				D				D				D				D				D				D				D							
<b>TS29</b>				<b>TS30</b>				<b>TS31</b>																											
D				D				D																											

**\*NOTE:**

When a G.703 port is configured for CAS, Time Slot 16 is used for signaling and is unavailable for cross-connection. When a G.703 port is configured for CCS in a DS0 Cross Connect, the user must cross-connect Time Slot 16 and any associated time slots.

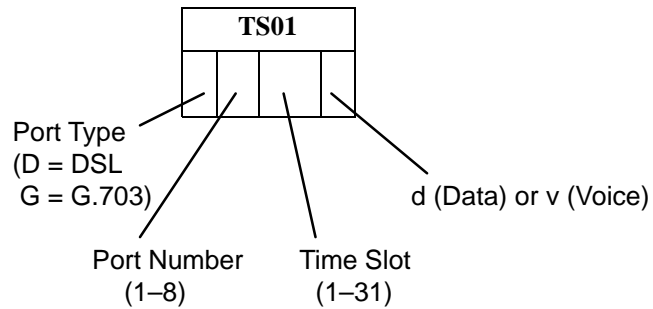

**Time Slot Assignments – G.703 Port 3**

<b>TS01</b>				<b>TS02</b>				<b>TS03</b>				<b>TS04</b>				<b>TS05</b>				<b>TS06</b>				<b>TS07</b>											
D				D				D				D				D				D				D				D							
<b>TS08</b>				<b>TS09</b>				<b>TS10</b>				<b>TS11</b>				<b>TS12</b>				<b>TS13</b>				<b>TS14</b>											
D				D				D				D				D				D				D				D							
<b>TS15</b>				<b>TS16*</b>				<b>TS17</b>				<b>TS18</b>				<b>TS19</b>				<b>TS20</b>				<b>TS21</b>											
D				D				D				D				D				D				D				D							
<b>TS22</b>				<b>TS23</b>				<b>TS24</b>				<b>TS25</b>				<b>TS26</b>				<b>TS27</b>				<b>TS28</b>											
D				D				D				D				D				D				D				D							
<b>TS29</b>				<b>TS30</b>				<b>TS31</b>																											
D				D				D																											

**\*NOTE:**

When a G.703 port is configured for CAS, Time Slot 16 is used for signaling and is unavailable for cross-connection. When a G.703 port is configured for CCS in a DS0 Cross Connect, the user must cross-connect Time Slot 16 and any associated time slots.

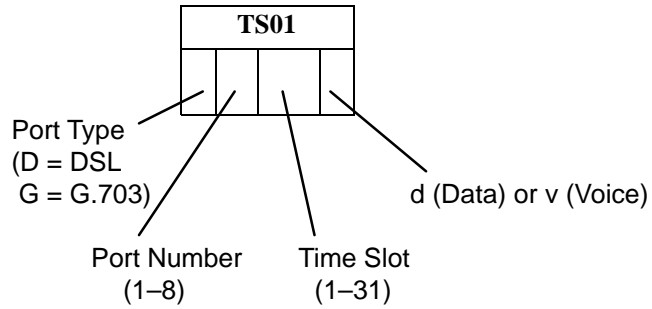

**Time Slot Assignments – G.703 Port 4**

<b>TS01</b>				<b>TS02</b>				<b>TS03</b>				<b>TS04</b>				<b>TS05</b>				<b>TS06</b>				<b>TS07</b>											
D				D				D				D				D				D				D				D							
<b>TS08</b>				<b>TS09</b>				<b>TS10</b>				<b>TS11</b>				<b>TS12</b>				<b>TS13</b>				<b>TS14</b>											
D				D				D				D				D				D				D				D							
<b>TS15</b>				<b>TS16*</b>				<b>TS17</b>				<b>TS18</b>				<b>TS19</b>				<b>TS20</b>				<b>TS21</b>											
D				D				D				D				D				D				D				D							
<b>TS22</b>				<b>TS23</b>				<b>TS24</b>				<b>TS25</b>				<b>TS26</b>				<b>TS27</b>				<b>TS28</b>											
D				D				D				D				D				D				D				D							
<b>TS29</b>				<b>TS30</b>				<b>TS31</b>																											
D				D				D																											

**\*NOTE:**

When a G.703 port is configured for CAS, Time Slot 16 is used for signaling and is unavailable for cross-connection. When a G.703 port is configured for CCS in a DS0 Cross Connect, the user must cross-connect Time Slot 16 and any associated time slots.



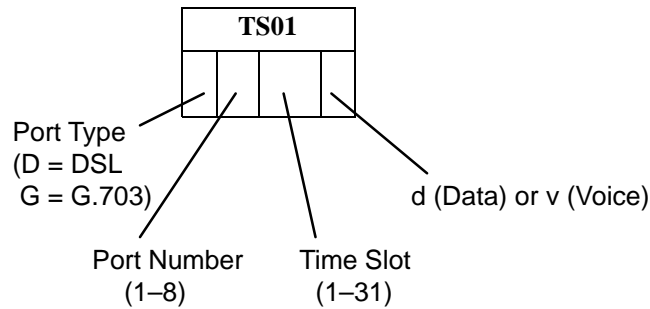

**Time Slot Assignments – G.703 Port 5**

<b>TS01</b>				<b>TS02</b>				<b>TS03</b>				<b>TS04</b>				<b>TS05</b>				<b>TS06</b>				<b>TS07</b>											
D				D				D				D				D				D				D				D							
<b>TS08</b>				<b>TS09</b>				<b>TS10</b>				<b>TS11</b>				<b>TS12</b>				<b>TS13</b>				<b>TS14</b>											
D				D				D				D				D				D				D				D							
<b>TS15</b>				<b>TS16*</b>				<b>TS17</b>				<b>TS18</b>				<b>TS19</b>				<b>TS20</b>				<b>TS21</b>											
D				D				D				D				D				D				D				D							
<b>TS22</b>				<b>TS23</b>				<b>TS24</b>				<b>TS25</b>				<b>TS26</b>				<b>TS27</b>				<b>TS28</b>											
D				D				D				D				D				D				D				D							
<b>TS29</b>				<b>TS30</b>				<b>TS31</b>																											
D				D				D																											

**\*NOTE:**

When a G.703 port is configured for CAS, Time Slot 16 is used for signaling and is unavailable for cross-connection. When a G.703 port is configured for CCS in a DS0 Cross Connect, the user must cross-connect Time Slot 16 and any associated time slots.

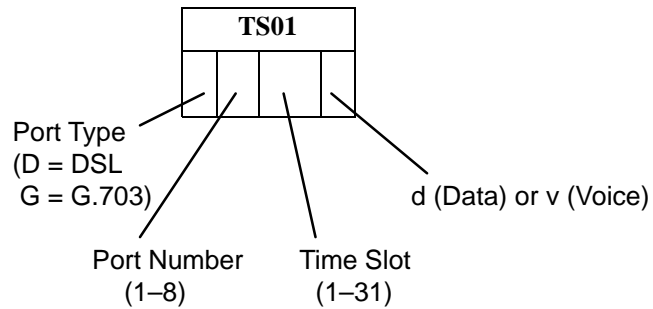

**Time Slot Assignments – G.703 Port 6**

<b>TS01</b>				<b>TS02</b>				<b>TS03</b>				<b>TS04</b>				<b>TS05</b>				<b>TS06</b>				<b>TS07</b>											
D				D				D				D				D				D				D				D							
<b>TS08</b>				<b>TS09</b>				<b>TS10</b>				<b>TS11</b>				<b>TS12</b>				<b>TS13</b>				<b>TS14</b>											
D				D				D				D				D				D				D				D							
<b>TS15</b>				<b>TS16*</b>				<b>TS17</b>				<b>TS18</b>				<b>TS19</b>				<b>TS20</b>				<b>TS21</b>											
D				D				D				D				D				D				D				D							
<b>TS22</b>				<b>TS23</b>				<b>TS24</b>				<b>TS25</b>				<b>TS26</b>				<b>TS27</b>				<b>TS28</b>											
D				D				D				D				D				D				D				D							
<b>TS29</b>				<b>TS30</b>				<b>TS31</b>																											
D				D				D																											

**\*NOTE:**

When a G.703 port is configured for CAS, Time Slot 16 is used for signaling and is unavailable for cross-connection. When a G.703 port is configured for CCS in a DS0 Cross Connect, the user must cross-connect Time Slot 16 and any associated time slots.

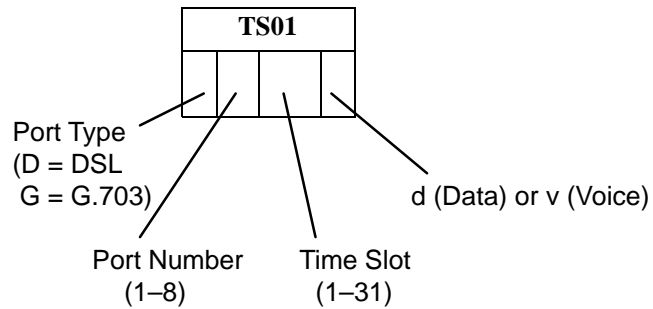

**Time Slot Assignments – G.703 Port 7**

<b>TS01</b>				<b>TS02</b>				<b>TS03</b>				<b>TS04</b>				<b>TS05</b>				<b>TS06</b>				<b>TS07</b>											
D				D				D				D				D				D				D				D							
<b>TS08</b>				<b>TS09</b>				<b>TS10</b>				<b>TS11</b>				<b>TS12</b>				<b>TS13</b>				<b>TS14</b>											
D				D				D				D				D				D				D				D							
<b>TS15</b>				<b>TS16*</b>				<b>TS17</b>				<b>TS18</b>				<b>TS19</b>				<b>TS20</b>				<b>TS21</b>											
D				D				D				D				D				D				D				D							
<b>TS22</b>				<b>TS23</b>				<b>TS24</b>				<b>TS25</b>				<b>TS26</b>				<b>TS27</b>				<b>TS28</b>											
D				D				D				D				D				D				D				D							
<b>TS29</b>				<b>TS30</b>				<b>TS31</b>																											
D				D				D																											

**\*NOTE:**

When a G.703 port is configured for CAS, Time Slot 16 is used for signaling and is unavailable for cross-connection. When a G.703 port is configured for CCS in a DS0 Cross Connect, the user must cross-connect Time Slot 16 and any associated time slots.

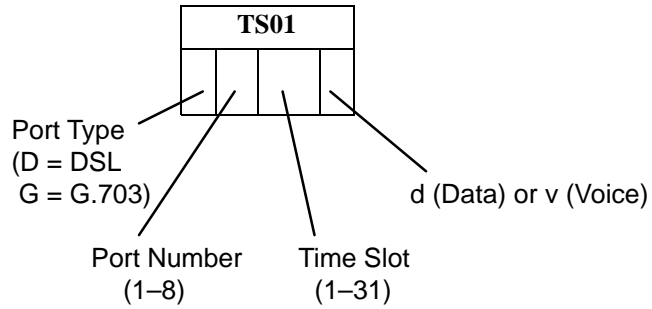

**Time Slot Assignments – G.703 Port 8**

<b>TS01</b>				<b>TS02</b>				<b>TS03</b>				<b>TS04</b>				<b>TS05</b>				<b>TS06</b>				<b>TS07</b>											
D				D				D				D				D				D				D				D							
<b>TS08</b>				<b>TS09</b>				<b>TS10</b>				<b>TS11</b>				<b>TS12</b>				<b>TS13</b>				<b>TS14</b>											
D				D				D				D				D				D				D				D							
<b>TS15</b>				<b>TS16*</b>				<b>TS17</b>				<b>TS18</b>				<b>TS19</b>				<b>TS20</b>				<b>TS21</b>											
D				D				D				D				D				D				D				D							
<b>TS22</b>				<b>TS23</b>				<b>TS24</b>				<b>TS25</b>				<b>TS26</b>				<b>TS27</b>				<b>TS28</b>											
D				D				D				D				D				D				D				D							
<b>TS29</b>				<b>TS30</b>				<b>TS31</b>																											
D				D				D																											

**\*NOTE:**

When a G.703 port is configured for CAS, Time Slot 16 is used for signaling and is unavailable for cross-connection. When a G.703 port is configured for CCS in a DS0 Cross Connect, the user must cross-connect Time Slot 16 and any associated time slots.

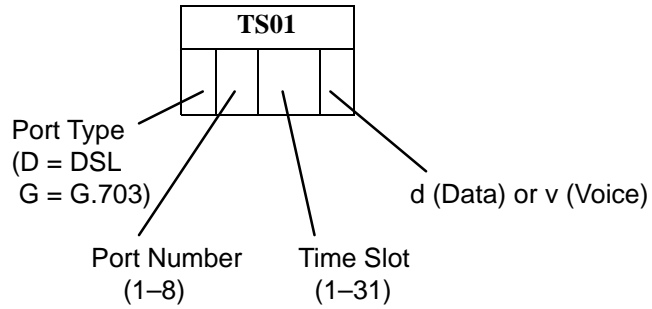

**Time Slot Assignments – DSL Port 1**

<b>TS01</b>				<b>TS02</b>				<b>TS03</b>				<b>TS04</b>				<b>TS05</b>				<b>TS06</b>				<b>TS07</b>							
X				X				X				X				X				X				X							
<b>TS08</b>				<b>TS09</b>				<b>TS10</b>				<b>TS11</b>				<b>TS12</b>				<b>TS13</b>				<b>TS14</b>							
X				X				X				X				X				X				X							
<b>TS15</b>				<b>TS16</b>				<b>TS17</b>				<b>TS18</b>				<b>TS19</b>				<b>TS20</b>				<b>TS21</b>							
X				X				X				X				X				X				X							
<b>TS22</b>				<b>TS23</b>				<b>TS24</b>				<b>TS25</b>				<b>TS26</b>				<b>TS27</b>				<b>TS28</b>							
X				X				X				X				X				X				X							
<b>TS29</b>				<b>TS30</b>				<b>TS31</b>																							
X				X				X																							

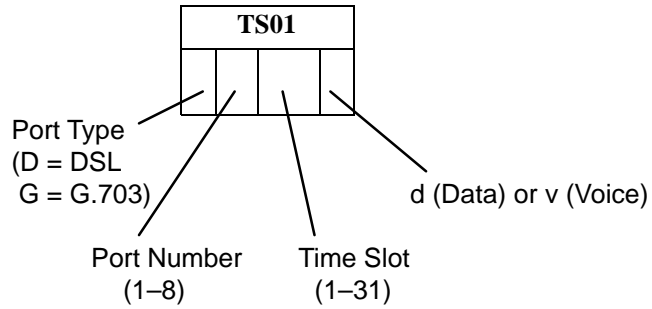

**Time Slot Assignments – DSL Port 2**

<b>TS01</b>				<b>TS02</b>				<b>TS03</b>				<b>TS04</b>				<b>TS05</b>				<b>TS06</b>				<b>TS07</b>																															
X				X				X				X				X				X				X				X																											
<b>TS08</b>								<b>TS09</b>								<b>TS10</b>								<b>TS11</b>								<b>TS12</b>								<b>TS13</b>								<b>TS14</b>							
X				X				X				X				X				X				X				X				X																							
<b>TS15</b>								<b>TS16</b>								<b>TS17</b>								<b>TS18</b>								<b>TS19</b>								<b>TS20</b>								<b>TS21</b>							
X				X				X				X				X				X				X				X				X																							
<b>TS22</b>								<b>TS23</b>								<b>TS24</b>								<b>TS25</b>								<b>TS26</b>								<b>TS27</b>								<b>TS28</b>							
X				X				X				X				X				X				X				X				X																							
<b>TS29</b>								<b>TS30</b>								<b>TS31</b>																																							
X				X				X																																															

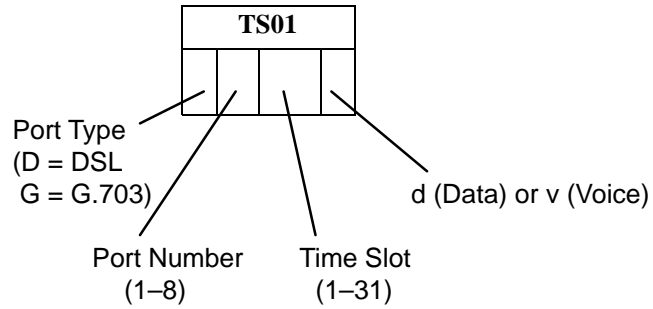

**Time Slot Assignments – DSL Port 3**

<b>TS01</b>				<b>TS02</b>				<b>TS03</b>				<b>TS04</b>				<b>TS05</b>				<b>TS06</b>				<b>TS07</b>							
X				X				X				X				X				X				X							
<b>TS08</b>				<b>TS09</b>				<b>TS10</b>				<b>TS11</b>				<b>TS12</b>				<b>TS13</b>				<b>TS14</b>							
X				X				X				X				X				X				X							
<b>TS15</b>				<b>TS16</b>				<b>TS17</b>				<b>TS18</b>				<b>TS19</b>				<b>TS20</b>				<b>TS21</b>							
X				X				X				X				X				X				X							
<b>TS22</b>				<b>TS23</b>				<b>TS24</b>				<b>TS25</b>				<b>TS26</b>				<b>TS27</b>				<b>TS28</b>							
X				X				X				X				X				X				X							
<b>TS29</b>				<b>TS30</b>				<b>TS31</b>																							
X				X				X																							

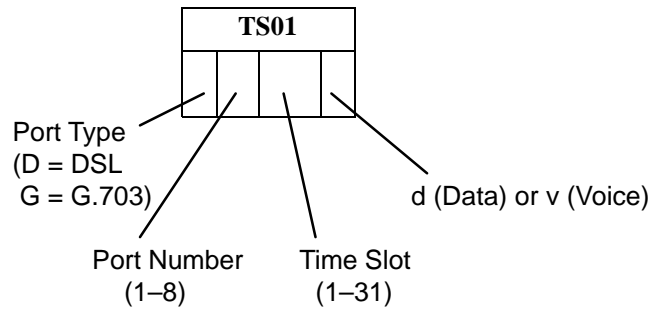

**Time Slot Assignments – DSL Port 4**

<b>TS01</b>				<b>TS02</b>				<b>TS03</b>				<b>TS04</b>				<b>TS05</b>				<b>TS06</b>				<b>TS07</b>											
X				X				X				X				X				X				X											
<b>TS08</b>				<b>TS09</b>				<b>TS10</b>				<b>TS11</b>				<b>TS12</b>				<b>TS13</b>				<b>TS14</b>											
X				X				X				X				X				X				X											
<b>TS15</b>				<b>TS16</b>				<b>TS17</b>				<b>TS18</b>				<b>TS19</b>				<b>TS20</b>				<b>TS21</b>											
X				X				X				X				X				X				X											
<b>TS22</b>				<b>TS23</b>				<b>TS24</b>				<b>TS25</b>				<b>TS26</b>				<b>TS27</b>				<b>TS28</b>											
X				X				X				X				X				X				X											
<b>TS29</b>				<b>TS30</b>				<b>TS31</b>																											
X				X				X																											



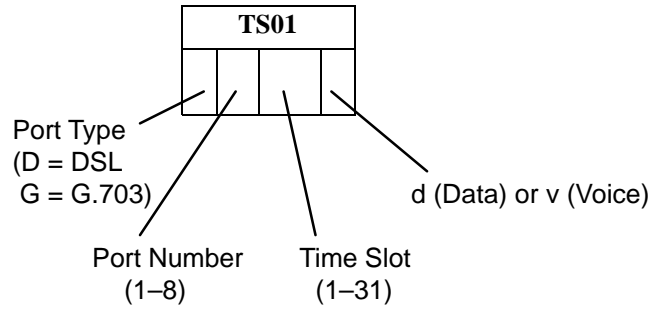

**Time Slot Assignments – DSL Port 5**

<b>TS01</b>				<b>TS02</b>				<b>TS03</b>				<b>TS04</b>				<b>TS05</b>				<b>TS06</b>				<b>TS07</b>																															
X				X				X				X				X				X				X				X																											
<b>TS08</b>								<b>TS09</b>								<b>TS10</b>								<b>TS11</b>								<b>TS12</b>								<b>TS13</b>								<b>TS14</b>							
X				X				X				X				X				X				X				X				X																							
<b>TS15</b>								<b>TS16</b>								<b>TS17</b>								<b>TS18</b>								<b>TS19</b>								<b>TS20</b>								<b>TS21</b>							
X				X				X				X				X				X				X				X				X																							
<b>TS22</b>								<b>TS23</b>								<b>TS24</b>								<b>TS25</b>								<b>TS26</b>								<b>TS27</b>								<b>TS28</b>							
X				X				X				X				X				X				X				X				X																							
<b>TS29</b>								<b>TS30</b>								<b>TS31</b>																																							
X				X				X																																															

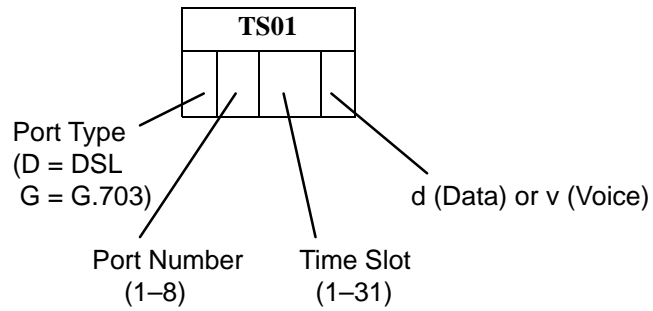

**Time Slot Assignments – DSL Port 6**

<b>TS01</b>				<b>TS02</b>				<b>TS03</b>				<b>TS04</b>				<b>TS05</b>				<b>TS06</b>				<b>TS07</b>																															
X				X				X				X				X				X				X				X																											
<b>TS08</b>								<b>TS09</b>								<b>TS10</b>								<b>TS11</b>								<b>TS12</b>								<b>TS13</b>								<b>TS14</b>							
X				X				X				X				X				X				X				X				X																							
<b>TS15</b>								<b>TS16</b>								<b>TS17</b>								<b>TS18</b>								<b>TS19</b>								<b>TS20</b>								<b>TS21</b>							
X				X				X				X				X				X				X				X				X																							
<b>TS22</b>								<b>TS23</b>								<b>TS24</b>								<b>TS25</b>								<b>TS26</b>								<b>TS27</b>								<b>TS28</b>							
X				X				X				X				X				X				X				X				X																							
<b>TS29</b>								<b>TS30</b>								<b>TS31</b>																																							
X				X				X																																															

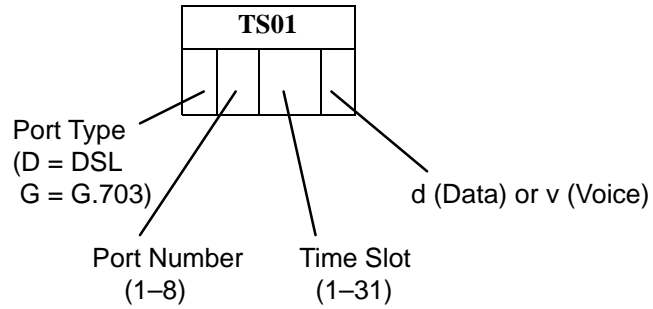

**Time Slot Assignments – DSL Port 7**

<b>TS01</b>				<b>TS02</b>				<b>TS03</b>				<b>TS04</b>				<b>TS05</b>				<b>TS06</b>				<b>TS07</b>																															
X				X				X				X				X				X				X				X																											
<b>TS08</b>								<b>TS09</b>								<b>TS10</b>								<b>TS11</b>								<b>TS12</b>								<b>TS13</b>								<b>TS14</b>							
X				X				X				X				X				X				X				X				X																							
<b>TS15</b>								<b>TS16</b>								<b>TS17</b>								<b>TS18</b>								<b>TS19</b>								<b>TS20</b>								<b>TS21</b>							
X				X				X				X				X				X				X				X				X																							
<b>TS22</b>								<b>TS23</b>								<b>TS24</b>								<b>TS25</b>								<b>TS26</b>								<b>TS27</b>								<b>TS28</b>							
X				X				X				X				X				X				X				X				X																							
<b>TS29</b>								<b>TS30</b>								<b>TS31</b>																																							
X				X				X																																															

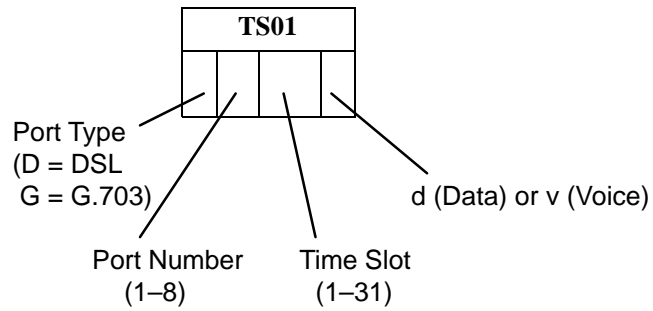

**Time Slot Assignments – DSL Port 8**

<b>TS01</b>				<b>TS02</b>				<b>TS03</b>				<b>TS04</b>				<b>TS05</b>				<b>TS06</b>				<b>TS07</b>																															
X				X				X				X				X				X				X				X																											
<b>TS08</b>								<b>TS09</b>								<b>TS10</b>								<b>TS11</b>								<b>TS12</b>								<b>TS13</b>								<b>TS14</b>							
X				X				X				X				X				X				X				X				X																							
<b>TS15</b>								<b>TS16</b>								<b>TS17</b>								<b>TS18</b>								<b>TS19</b>								<b>TS20</b>								<b>TS21</b>							
X				X				X				X				X				X				X				X				X																							
<b>TS22</b>								<b>TS23</b>								<b>TS24</b>								<b>TS25</b>								<b>TS26</b>								<b>TS27</b>								<b>TS28</b>							
X				X				X				X				X				X				X				X				X																							
<b>TS29</b>								<b>TS30</b>								<b>TS31</b>																																							
X				X				X																																															

---

# Glossary

---

<b>511</b>	A random bit test 511 bytes in length.
<b>AIS</b>	Alarm Indication Signal. A signal transmitted downstream instead of the normal signal to preserve transmission continuity and to indicate to the rest of the network that a fault exists. Also called a Blue Alarm.
<b>AMI</b>	Alternate Mark Inversion. A line coding technique used to accommodate the ones density requirements of E1 or T1 lines.
<b>ATI</b>	Asynchronous Terminal Interface. A menu-driven, VT100-compatible system for configuring and managing the termination unit.
<b>BER</b>	Bit Error Rate. The number of bits in error over a given period compared to the number of bits transmitted successfully.
<b>BES</b>	Bursty Error Seconds. A second in which more than one but less than 320 CRC6 error events have occurred.
<b>BPV</b>	Bipolar Violation. In a bipolar signal, a one (mark, pulse) which has the same polarity as its predecessor.
<b>bridged tap</b>	Any part of the local loop that is not in the direct talking path between the CO and the service user.
<b>CAP</b>	Carrierless Amplitude and Phase Modulation. A transmission technology for implementing a DSL. Transmit and receive signals are modulated into two wide-frequency bands using passband modulation techniques.
<b>CAS</b>	Channel Associated Signaling. A type of signaling in which the state of the circuit is denoted by status bits appropriated from information packets. Also called Robbed Bit Signaling.
<b>CCS</b>	Common Channel Signaling. A type of signaling in which a group of circuits share a single reserved signaling channel.
<b>CD</b>	Carrier Detect. The received line signal detector. V.24 circuit 109.
<b>CO</b>	Central Office/Central Site. The PSTN facility that houses one or more switches serving local telephone subscribers.
<b>COM port</b>	Communications port. A computer's serial communications port used to transmit to and receive data from a modem. The modem connects directly to this port.
<b>CP</b>	Customer Premises.
<b>CPE</b>	Customer Premises Equipment. Terminal equipment on the service user's side of the telecommunications network interface.
<b>CPU</b>	Central Processing Unit. The main or only computing device in a data processing system.
<b>CRC</b>	Cyclic Redundancy Check. A mathematical method of confirming the integrity of received digital data.
<b>CSS</b>	Controlled Slip Seconds. A period in which a frame was added or deleted because of a variance in timing.

<b>CTS</b>	Clear To Send. A signal indicating that the device is ready for the DTE to transmit data. Usually occurs in response to Request To Send (RTS).
<b>CV</b>	Code Violation. Detected when using HDB3 coding format, this is equivalent to a BPV when using AMI coding.
<b>DCE</b>	Data Communications Equipment. The equipment that provides the functions required to establish, maintain, and end a connection. It also provides the signal conversion required for communication between the DTE and the network.
<b>DCLB</b>	Data Channel LoopBack. Loops the data received from the network interface, for all DS0 channels allocated to the selected port, back to the network.
<b>DS0</b>	Digital signal level 0 (zero). A 64 kbps digital telecommunications signal or channel.
<b>DS1</b>	Digital signal level 1. A digital signal transmitted at the rate of 1.544 Mbps in North America.
<b>DSL</b>	Digital Subscriber Line. The non-loaded, local-loop copper connection between the customer and the first node within the network.
<b>DSLAM</b>	Digital Subscriber Line Access Multiplexer. A platform for DSL modems that provides high-speed data transmission over traditional twisted-pair wiring.
<b>DSR</b>	Data Set Ready. A signal from the modem to the DTE that indicates the modem is turned ON and connected to the DTE.
<b>DSX-1</b>	Digital Signal Cross Connect level 1. An interconnection point for terminals, multiplexers and transmission facilities.
<b>DTE</b>	Data Terminal Equipment. The equipment, such as a computer or terminal, that provides data in the form of digital signals for transmission.
<b>DTLB</b>	Data Terminal LoopBack. Loopback mode that loops the data for a particular synchronous data port back to the port just before it is combined with the rest of the T1 data stream.
<b>DTR</b>	Data Terminal Ready. A signal from the DTE to the modem, sent via Pin 20 of the EIA-232 interface (V.24 circuit 108/1, /2), that indicates the DTE is turned ON and connected to the modem.
<b>E1</b>	A wideband digital interface operating at 2.048 Mbps, defined by ITU recommendations G.703 and G.704. It is used primarily outside North America.
<b>EER</b>	Excessive Error Rate. An error rate that is greater than the threshold that has been configured in the device.
<b>EIA-530-A</b>	An Electronic Industries Association standard for a high-speed, 25-position, DCE/DTE interface.
<b>EOC</b>	Embedded Operations Channel. An in-band channel between DSL devices, used for 8 kbps management data.
<b>ES</b>	Errored Seconds. A second with one or more error events (one or more CRC error events or OOFs).
<b>ESF</b>	Extended SuperFrame. The T1 transmission standard that specifies 24 frames as an extended superframe to be used for frame synchronization and to locate signaling bits.
<b>Ethernet</b>	A type of network that supports high-speed communication among systems. It is a widely implemented standard for LANs. All hosts are connected to a coaxial cable where they contend for network access using a Carrier Sense, Multiple Access with Collision Detection (CSMA/CD) paradigm.
<b>ETSI</b>	European Telecommunications Standardization Institute. An organization that produces technical standards in the area of telecommunications.

---

<b>factory defaults</b>	A predetermined set of configuration options containing the optimum settings for operation on asynchronous dial networks.
<b>FAS</b>	Frame Alignment Signal. A loss of frame (LOF) error detection.
<b>FAW</b>	Frame Alignment Word. A loss of synchronization error detection.
<b>FCC</b>	Federal Communications Commission. The Board of Commissioners that regulates all electrical communications that originate in the United States.
<b>FDL</b>	Facility Data Link. The selected framing bits in the ESF format used in a wide-area link that are used for control, monitoring, and testing.
<b>FEBE</b>	Far-End Block Error. Block errors reported by remote equipment.
<b>frame</b>	One identifiable group of data bits that includes a sequence of bits for control and identification information.
<b>framer</b>	A program or device that assembles and disassembles frames.
<b>frame relay</b>	A high-speed connection-oriented packet switching WAN protocol using variable-length frames.
<b>FTP</b>	File Transfer Protocol. A TCP/IP standard protocol that allows a user on one host to access and transfer files to and from another host over a network, provided that the client supplies a login identifier and password to the server.
<b>G.703</b>	An ITU recommendation for the physical and logical characteristics of hierarchical digital devices.
<b>G.704</b>	An ITU recommendation for synchronous frame structures.
<b>HDB3</b>	High Density Bipolar Three Zeros Substitution. A line coding technique used to accommodate the ones density requirements of E1 lines.
<b>HDSL</b>	High-bit-rate Digital Subscriber Line. A technique for high bandwidth, bidirectional transmission over copper wire for T1 and E1 services.
<b>HDSL2</b>	High-bit-rate Digital Subscriber Line, 2nd generation. An ANSI specification for high bandwidth, bidirectional transmission over a single twisted pair.
<b>IP</b>	Internet Protocol. An open networking protocol used for internet packet delivery.
<b>IP address</b>	Internet Protocol address. The address assigned to an internet host.
<b>ITU</b>	International Telecommunications Union. The telecommunications agency of the United Nations, established to provide standardized communications procedures and practices. Before March 1993 it was called CCITT.
<b>LAN</b>	Local Area Network. A privately owned and administered data communications network limited to a small geographic area.
<b>LED</b>	Light Emitting Diode. A light or status indicator that glows in response to the presence of a certain condition (e.g., an alarm).
<b>LIU</b>	Line Interface Unit. A physical layer data transmitter and receiver.
<b>LLB</b>	Line LoopBack. A test in which the received signal on the network interface is looped back to the network without change.
<b>LOF</b>	Loss of Frame. Occurs when a DS1 terminal is unable to synchronize on the DS1 signal for some interval.
<b>LOFC</b>	Loss Of Frame Count. The number of LOFs declared.

<b>loopback</b>	A diagnostic procedure that sends a test message back to its origination point. Used to test various portions of a data link in order to isolate an equipment or data line problem.
<b>LOS</b>	Loss of Signal. The line condition where there are no pulses.
<b>LTU</b>	Line Termination Unit. The control unit on the network end of a link. (The NTU is on the customer premises end.)
<b>MCC</b>	Management Communications Controller. The DSLAM circuit card used to configure and monitor the DSLAM.
<b>M/HDSL</b>	Multirate High-bit-rate Digital Subscriber Line. (See HDSL.)
<b>MIB</b>	Management Information Base. A database of managed objects used by SNMP to provide network management information and device control.
<b>MIB II</b>	MIB Release 2. The current Internet-standard MIB, defined by RFC 1213.
<b>M/SDSL</b>	Multirate Symmetric Digital Subscriber Line. (See SDSL.)
<b>NMS</b>	Network Management System. A computer system used for monitoring and controlling network devices.
<b>NTU</b>	Network Termination Unit. The unit on the customer premises end of a link. (The LTU is on the network end.)
<b>OOF</b>	Out Of Frame. An error condition in which frame synchronization bits are in error.
<b>PPP</b>	Point-to-Point Protocol. A protocol for packet transmission over serial links, specified by Internet RFC 1661.
<b>RAI</b>	Remote Alarm Indication. A failure message sent by the remote unit in a link.
<b>receiver</b>	A circuit that accepts data signals from a transmitter.
<b>reset</b>	A reinitialization of the device that occurs at power-up or in response to a reset command.
<b>RLB</b>	Repeater LoopBack. Loops the signal being sent to the network back to the DTE Drop/Insert and data ports after it has passed through the framing circuitry of the device.
<b>router</b>	A device that connects LANs by dynamically routing data according to destination and available routes.
<b>RTS</b>	Request to Send. A signal from the DTE to the device, indicating that the DTE has data to send. V.24 circuit 105.
<b>RXD</b>	Received Data. Pin 3 of the EIA-232 interface that is used by the DTE to receive data from the modem. Conversely, the modem uses Pin 3 to transmit data to the DTE.
<b>SDSL</b>	Symmetric Digital Subscriber Line. A technique for the use of an existing twisted-pair line that permits high bandwidth, bidirectional transmission.
<b>SES</b>	Severely Errored Seconds. Usually defined as a second during which a specific number of CRC errors was exceeded, or an OOF or other critical error occurred.
<b>SNMP</b>	Simple Network Management Protocol. Protocol for open networking management.
<b>T1</b>	A term for a digital carrier facility used to transmit a DS1 formatted digital signal at 1.544 Mbps. It is used primarily in North America.
<b>TCP/IP</b>	Transmission Control Protocol/Internet Protocol. The dominant protocol suite in the worldwide Internet, TCP allows a process on one machine to send data to a process on another machine using the IP. TCP can be used as a full-duplex or one-way simplex connection.



<b>Telnet</b>	Virtual terminal protocol in the Internet suite of protocols. Allows the user of one host computer to log into a remote host computer and interact as a normal terminal user for that host.
<b>TFTP</b>	Trivial File Transfer Protocol. A standard TCP/IP protocol that allows simple file transfer to and from a remote system without directory or file listing. TFTP is used where FTP is not available.
<b>transceiver</b>	A circuit capable of acting as both a transmitter and a receiver.
<b>transmitter</b>	A circuit capable of generating, modulating, and sending a signal for communication, control, and other purposes.
<b>TXD</b>	Transmit Data. Pin 2 of the EIA-232 interface that is used by the DTE to transmit data to the modem. Conversely, the modem uses Pin 2 to receive data from the DTE.
<b>UAS</b>	Unavailable Seconds. A count of one-second intervals when service is unavailable.
<b>UNIX</b>	An operating system developed at AT&T Bell Laboratories and since used as the basis of similar operating systems.
<b>V.35</b>	An ITU-T standard for a high-speed, 34-position, DCE/DTE interface.
<b>WAN</b>	Wide Area Network. A network that spans a large geographic area.
<b>Yellow Alarm</b>	An outgoing signal transmitted when a DS1 or DS3 terminal has determined that it has lost the incoming signal.



---

# Index

---

## A

- Abort All Tests, 8-1
- access
  - SNMP, 6-5
  - to async terminal interface, 2-3
- access level
  - effective, 6-2
  - functions available for, 6-2
- administer login, 6-3
- AIS (Alarm Indication Signal), status message, 7-3
- Alarm, LED, 7-19
- applying downloaded firmware, 9-2
- ASCII, printable characters, 3-2
- Assign Time Slots, A-20
- ATI (Asynchronous Terminal Interface)
  - access, 2-1
  - defined, 1-2
  - exiting, 2-9
  - initiating session, 2-2
  - virtual function keys, 2-7
- authenticationFailure, B-2
- AutoRate
  - ceiling, A-3
  - disabling, 3-8
  - Network Interface Options screen, A-3
  - resetting, 3-8

## C

- Card Failed
  - self-test result, 7-6
  - status message, 7-3
- Change Identity, 3-2
- Circuit Identifier, A-4
- Clear\_All
  - cross-connect modes, A-18
  - time slots, A-21
- Clock Failed, status message, 7-5
- clocking
  - DSX-1 clock source, A-7
  - examples, A-14
  - G.703 clock source, A-9
  - System Clock configuration options, A-13
  - system clock references, A-16
- community names
  - for SNMP, 6-5
  - General SNMP Management Options, A-26

- configuration
  - AutoRate, 3-8
  - Copy Ports Options, A-10
  - Cross Connect, A-17
  - DSX-1 Interface Options, A-6
  - editing and displaying, 3-5
  - example of network, 1-3
  - G.703 Interface Options, A-8
  - General SNMP Management Options, A-25, A-26
  - loader, 9-3
  - menu, 3-4
  - Network Interface Options, A-2
  - option tables, A-1
  - saving changes, 3-6
  - SNMP Management, A-26
  - SNMP NMS Security Options, A-28
  - SNMP Traps Options, A-29
  - System Clock, A-13
  - System Options, A-11
  - Telnet Session Options, A-23
- connectors
  - front panel, C-1
  - Telco 50-pin for DSL loops and POTS splitters, C-3
- Control branch
  - Administer Logins, 6-3
  - Apply Download, 9-2
  - Change Identity, 3-2
  - Download Code, 9-1
  - PORTS LEDs, 7-20
  - Reset AutoRate, 3-8
  - Reset Device, 3-7
- Copy Ports Options, A-10
- CPU CPLD Fail, self-test result, 7-6
- CPU Fail, self-test result, 7-6
- create login ID, 6-3
- Cross-Connect Configuration Options, A-17
  - Cross-Connect Mode, A-19
  - Data/Voice Selection, A-22
  - DSL/DTE selection, A-21
  - Port Number, A-22
  - Port Type, A-22
  - Time Slot Number, A-22
- cross-connection
  - example, 4-2
  - procedures, 4-1
- customer configuration areas, 3-3

**D**

- Data Path Failure, self-test result, 7-6
- data/voice, time slot assignment, A-22
- default configuration area, 3-3
- delete, login ID, 6-4
- device
  - messages, 7-8– 7-9
  - name, 3-2
- device reset, 3-7
- dimensions, D-1
- Disconnect Time, for Telnet session, A-24
- documents, related, viii
- DOS, TFTP server on, 9-3
- download
  - configuration, 9-3
  - firmware, 9-1
- Download Failed, status message, 7-3
- DSL Framing x Fail, self-test result, 7-6
- DSL line rate
  - and payload rate, A-5
  - AutoRate ceiling, A-3
  - Fixed Rate, A-5
  - Network Interface option, A-3
- DSL Port, LEDs, 7-19
- DSLAM
  - defined, 1-2
  - exiting from session, 2-9
  - login, 2-2
- DSX-1 Failed, self-test result, 7-6
- DSX-1 Interface Options, A-6
  - Excessive Error Rate Threshold, A-7
  - Line Coding, A-6
  - Line Equalization, A-7
  - Line Framing, A-7
  - Port Status, A-6
  - Primary Clock Source, A-7
- DSX-1 port, LEDs, 7-19
- DTE Framing x Fail, self-test result, 7-6
- DTE LIU x Fail
  - self-test message, 7-6
  - self-test result, 7-6
- DTE loopback , 8-6

**E**

- EER (Excessive Error Rate) , status message, 7-3
- effective access level, 6-2
- EIA-530 Payload Rate, A-3
- ending an ATI session, 2-9
- enterprise, SNMP traps, B-5
- Enterprise Specific Traps, A-31
- environment requirements, D-1
- error messages, line 24, 7-8
- error statistics, 7-10
- Excessive Error Rate (EER) Threshold
  - DSL network, A-3
  - DSX-1, A-7

**F**

- factory defaults, 3-3
- Failure, self-test result, 7-6
- features, 1-2
- firmware, download from server, 9-1
- FPGA Failed, self-test result, 7-6
- framing
  - DS0 Cross Connect, A-4
  - DSX-1, A-7
  - G.703, A-8
- function keys, 2-7

**G**

- G.703
  - interface impedance, A-12
  - Line Termination, A-12
- G.703 Failed, self-test result, 7-6
- G.703 Interface Option settings, A-8
  - Line Coding, A-9
  - Line Framing, A-9
  - Primary Clock Source, A-9
  - Time Slot 16, A-9
- General Traps, A-30
- glossary, GL-1–GL-4

**H**

- health and status messages, 7-3

**I**

identity, 3-2  
 impedance, A-12  
 inactivity timeout, for Telnet session, A-24  
 intended audience, vii  
 IP address  
   DSL peer, A-4  
   example, 5-2  
   selecting, 5-1  
   SNMP manager, 6-5

**K**

keyboard functions, 2-6

**L**

lamp test, 8-9  
 LEDs  
   front panel, 7-19  
   testing, 8-9  
   viewing through the ATI, 7-17  
 Line Coding, A-9  
   DSX-1, A-6  
 Line Equalization, A-7  
 Line Framing  
   DS0 Cross Connect, A-4  
   DSX-1, A-7  
   G.703, A-9  
 Line Loopback, 8-4  
 Link Up, LEDs, 7-19  
 link-layer protocols, 5-1  
 linkUp and linkDown traps, B-3  
 loading firmware, 9-3  
 local line loopback (LLB), 8-4  
 LOF (Loss Of Frame), status message, 7-4  
 login, DSLAM, 2-2  
 login ID, 6-1  
   access levels, 6-2  
   adding, 6-3  
   deleting, 6-4  
 loopback  
   DTE Loopback, 8-6  
   effect on LEDs, 7-19  
   Network Line Loopback, 8-4  
   Remote Send Line Loopback, 8-7  
   Repeater Loopback, 8-5  
   Telco-initiated, 8-11  
 LOS (Loss Of Signal), status message, 7-4

**M**

main menu, 2-2  
 Management and Communication Options, A-23  
 management port  
   access, 6-1  
   settings, 2-1  
 Margin Threshold, A-2  
 Max DSL AutoRate, A-3  
 maximum payload rate, A-5  
 MCC, defined, 1-2  
 Memory Test n Fail, self-test result, 7-6  
 messages  
   health and status, 7-3  
   line 24, 7-8  
   self-test results, 7-6  
   test status, 7-7  
 MIB  
   list of supported MIBs, 1-4  
   support, 1-4  
 monitoring, 7-1

**N**

navigating the screens, 2-6  
 Net Margin Threshold, status message, 7-4  
 network, tests, 8-2  
 Network Interface Options, A-2  
   AutoRate, A-3  
   Circuit Identifier, A-4  
   DS0 Cross Connect Line Framing, A-4  
   Excessive Error Rate Threshold, A-3  
   Margin Threshold, A-2  
   Peer IP Address, A-4  
   Port Status, A-2  
   Transmit Attenuation, A-4  
 Network Line Loopback, 8-4  
 NMS  
   IP address, A-28  
   Number of Trap Managers, A-30  
   SNMP access, 6-5  
   SNMP connectivity, 5-1  
 No Test Active, status message, 7-7

**O**

OK, LED, 7-19  
 OOF (Out Of Frame), status message, 7-5  
 options, configuration tables, A-1  
 overview  
   device features, 1-2  
   user's guide, vii

**P**

- Passed, self-test result, 7-6
- payload rate
  - EIA-530, A-3
  - relative to line rate, A-5
- Peer IP Address, A-4
- performance statistics, 7-11
  - DSX-1, 7-13
  - G.703, 7-15
- physical environment requirements, D-1
- pin assignments
  - front panel, C-1
  - Telco 50-pin, C-3
- PLD Failure, self-test result, 7-7
- Port Status, A-2, A-6, A-8
- PORTS LEDs, switching between DSL and DTE, 7-20
- power requirements, D-1
- Primary Clock Failed, status message, 7-5
- Primary Clock Source
  - DSX-1, A-7
  - G.703, A-9
- Primary System Clock Failed, status message, 7-5
- Primary System Clock Reference, A-16

**R**

- related documents, viii
- remote send line loopback, 8-7
- repeater loopback (RLB), 8-5
- reset
  - ATI, 3-7
  - AutoRate, 3-8
  - device, 3-7
  - slot, 3-7
- restore access to ATI, 3-7

**S**

- Save Configuration screen, 3-6
- saving configuration option changes, 3-6
  - to TFTP server, 9-3
- screen function keys, 2-7
- screens, for user interface, 2-1– 2-6
- SDSL Mode, A-11
- secondary holdover mode, A-14
- secondary system clock failure, A-14
- Secondary System Clock Reference, A-16
- security, 6-1
- self-test, results, 7-6
- Send and Monitor 511, 8-8
- Send Remote Line Loopback, 8-7
- Set Cross Connect Mode, A-18
- size of card, D-1

**SNMP**

- enable/disable traps, A-30
- Enterprise Specific Traps, A-31
- general management capabilities, 1-4
- limiting management access, 6-5
- Link Trap Interfaces, A-31
- Link Traps, A-31
- NMS IP Address, A-28
- NMS Security Options, A-28
- Number of Trap Managers, A-30
- system entries, 3-2
- trap manager IP Address, A-30
- trap NMS destination, A-30
- traps, B-1
  - Traps Options, A-29
- start-up, ATI, 2-1
- status, test messages, 7-7
- system
  - device name fields, 3-2
  - LEDs, 7-19
- System Clock options, A-13
- System Options
  - DSL Mode, A-11
  - Telco-Initiated Loopback, A-12
  - Test Duration, A-11
  - Test Timeout, A-11

**T**

- technical specifications, D-1
- Telco-initiated
  - line loopback, 8-11
  - loopback, disabling, A-12
  - payload loopback, 8-12
  - remote line loopback, 8-12
- Telnet session
  - access, 6-1
  - access level, A-24
  - Disconnect Time (Minutes), A-24
  - enable/disable, A-24
  - inactivity timeout, A-24
  - login required, A-24
  - options, A-23
  - Session Access Level, A-24
- terminal port, direct connection, 2-1

## test

- aborting, 8-10
- DTE Loopback, 8-6
- LED, 7-19
- menu, 8-2
- Network Line Loopback, 8-4
- procedures, 8-1
- Remote Send Line Loopback, 8-7
- Repeater Loopback, 8-5
- Send and Monitor 511, 8-8
- status messages, 7-7
- Telco-initiated, 8-11, A-12
- terminating, 8-10
- Test Duration, A-11
- Test Timeout, A-11

Time Slot 16, A-9

time slots, relative to payload rate, A-5

## timeout

- Telnet session inactivity, A-24
- Test, A-11

## timing

- DSX-1 clock source, A-7
- examples, A-14
- G.703 clock source, A-9
- System Clock configuration options, A-13
- system clock references, A-16

Transmit Attenuation, A-4

traps, SNMP, B-1, B-2

## troubleshooting, 7-21

- DSX-1 performance statistics, 7-13
- error statistics, 7-10
- G.703 performance statistics, 7-15
- Health and Status messages, 7-3
- performance statistics, 7-11

TSI CPLD Fail, self-test result, 7-7

TSI Fail, self-test result, 7-7

**U**

UNIX, TFTP server on, 9-3

upload configuration, 9-3

## user interface

- access, 3-7
- async terminal, 2-1
- how to access, 2-1

**V**

virtual function keys, 2-7

voice/data, time slot assignment, A-22

**W**

warmStart, B-2

weight of card, D-1

worksheets, E-1