

**Accton**

Making Partnership Work

**CheetahHub Power-3008N/3016N  
Quick Installation Guide**

EH3008N(-SW)  
EH3016N(-SW)  
E1098-R01  
150001-102



# Accton

Making Partnership Work

## Quick Installation Guide

### CheetaHub Power-3008N/3016N

Fast Ethernet Dual-Speed Stackable Hubs  
with 8/16 10/100Mbps (RJ-45) Ports

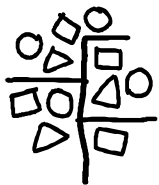

Copyright © 1998 by Accton Technology Corporation. All rights reserved.

No part of this document may be copied or reproduced in any form or by any means without the prior written consent of Accton Technology Corporation.

Accton makes no warranties with respect to this documentation and disclaims any implied warranties of merchantability, quality, or fitness for any particular purpose. The information in this document is subject to change without notice. Accton reserves the right to make revisions to this publication without obligation to notify any person or entity of any such changes.

## Accton

### International Headquarters

No. 1 Creation Road III,  
Science-based Industrial Park  
Hsinchu 300, Taiwan, R.O.C.  
Phone: 886-3-5770-270  
FAX: 886-3-5770-267  
Internet: [support@accton.com.tw](mailto:support@accton.com.tw)

### USA Headquarters

P.O. Box 51420  
Irvine, CA 92619-1420  
Phone Numbers -  
Sales: 949-707-4800 or 888-398-2101  
Support: 949-707-4847 or 888-398-4101  
RMA: 949-707-4828 or 888-398-3101  
FAX: 949-707-2460

Accton is a registered trademark of Accton Technology Corporation. Other trademarks or brand names mentioned herein are trademarks or registered trademarks of their respective companies.

EH3008N(-SW)  
EH3016N(-SW)  
E1098-R01  
150001-102

# Contents

---

<b>Introduction</b>	<b>1</b>
<b>Package Contents</b>	<b>1</b>
<b>Description of Hardware</b>	<b>1</b>
<b>Mounting the Hub</b>	<b>2</b>
Stacking Hubs on a Flat Surface	2
<b>Connecting the Hub System</b>	<b>3</b>
Making a Connection via an RJ-45 Station Port	3
Making a Connection to the BNC Port (EH3016N, EH3016N-SW only)	3
Making a Connection via an MDI Daisy-Chain Port	3
Connecting to the Stack's Backplane	4
<b>Powering On the Hub</b>	<b>4</b>
<b>Verifying Port Status</b>	<b>5</b>
<b>Verifying System Operation</b>	<b>5</b>
<b>Applications</b>	<b>5</b>
<b>Product Specifications</b>	<b>6</b>
Repeater Criteria	6
Internal Switching Criteria	7
<b>Troubleshooting</b>	<b>7</b>
Diagnosing Hub Indicators	7
Power and Cooling Problems	7
Installation	8
<b>Port and Cable Assignments</b>	<b>8</b>
RJ-45 Port Description	8
<b>EMI Certification</b>	<b>8</b>
EH3008N	8
EH3016N	10
<b>Safety Compliance</b>	<b>11</b>
Underwriters Laboratories Inc. (USA)	11
Wichtige Sicherheitshinweise (Germany)	11
<b>Warranty</b>	<b>12</b>

## Introduction

The CheetaHub Power-3008N/3016N provides 8 (or 16) RJ-45 ports for 10 Mbps or 100 Mbps Ethernet connections (detected by auto-sensing). These dual-speed stackable hubs contain two internal repeater buses – one for 10 Mbps traffic and another for 100 Mbps traffic. Traffic passing between attached devices that operate at the same speed is confined within the appropriate repeater bus.

**Note:** The EH3016N/SW also includes a BNC on the rear panel.

In the CheetaHub Power-3008N-SW/3016N-SW, an internal Ethernet switch, consisting of a 10 Mbps and a 100 Mbps switching port, is used to link the repeater buses. Only if traffic has to be passed between a 10 Mbps and a 100 Mbps device, if the destination address is not found in the address table, or broadcast traffic is sent, will data be forwarded to the other repeater bus. These hubs are designed to perform switching between the 10 Mbps and 100 Mbps repeater buses for the individual hub and for the attached stack.

These stackable hubs provide an ideal bridge between 10 Mbps and 100 Mbps Ethernet networks, all for a price that's comparable to a standard Ethernet or Fast Ethernet hub. Moreover, the smart design built into the display panel provides a friendly interface that simplifies installation and network troubleshooting.

## Package Contents

- CheetaHub Power-3008N (Model No. EH3008N)  
Fast Ethernet dual-speed hub with 8 10/100 Mbps ports
- or CheetaHub Power-3008N (Model No. EH3008N-SW)  
Fast Ethernet dual-speed hub with 8 10/100 Mbps ports; with internal switching
- or CheetaHub Power-3016N (Model No. EH3016N)  
Fast Ethernet dual-speed hub with 16 10/100 Mbps ports and 1 BNC port
- or CheetaHub Power-3016N (Model No. EH3016N-SW)  
Fast Ethernet dual-speed hub with 16 10/100 Mbps ports and 1 BNC port; with internal switching
- Four rubber foot pads
- Hub stack cable
- AC power cord
- Quick Installation Guide
- Owner registration card

## Description of Hardware

These four stackable hubs provide 8 (16) RJ-45 dual-speed ports (10/100 Mbps). Each of these ports automatically senses the speed of the attached device, and channels the data to the appropriate backplane (i.e., the 10 or 100 Mbps repeater bus). Hubs with the internal switching function (EH3008N-SW and EH3016N-SW) contain a 2-port switch that connects the two repeater buses. The two repeater buses are extended across the stack backplane (via the cable connection to the stack ports) to the other hubs in the stack. Up to six hubs can be stacked together.

The CheetaHub Power-3008N/3016N detects the speed of the device connected to each RJ-45 port, and directs traffic to the corresponding 10 or 100 Mbps repeater bus as required. However, when a CheetaHub Power-3008N-SW/3016N-SW is included in the stack, the learning function of this hub stores the node address and the corresponding segment number (i.e., bus 1 or 2) of each incoming packet in a routing table. This information is subsequently used to pass traffic to the segment containing the destination node. By confining traffic to its respective collision domain, and only forwarding traffic to the other segment when required, the overall load on the network is significantly reduced.

**Note:** If more than one hub with internal switching is used in the stack, switching between stack segments will be managed by the unit highest in the stack, and internal switching will be disabled for all other units.

These hubs provide a friendly design that simplifies installation and network troubleshooting. The following figure shows the components of these hubs:

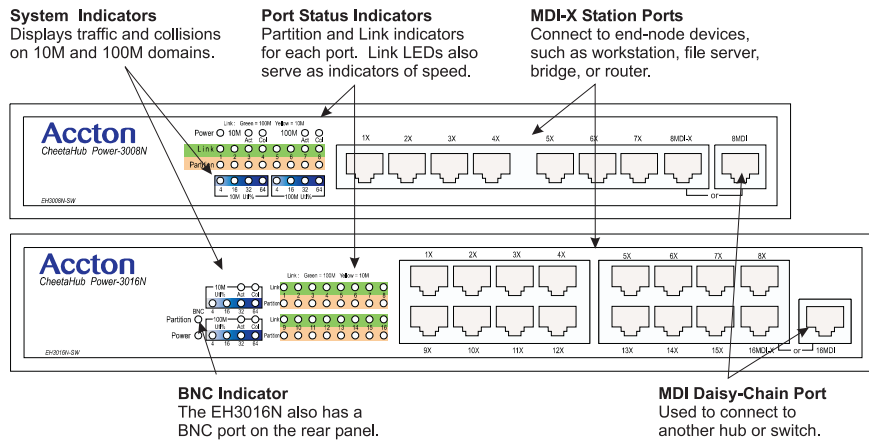

### Mounting the Hub

These hubs can be placed directly on your desktop or on any flat surface.

Before you start installing the hub, make sure you can provide the right operating environment, including power requirements, sufficient physical space, and proximity to other network devices that are to be connected. Verify the following installation requirements:

- Power requirements: 100 to 240 VAC (± 10%) at 50 to 60 Hz (± 3Hz). The hub's power supply automatically adjusts to the input voltage level.
- The hub should be located in a cool dry place, with at least 10 cm. (4 in.) of space at the front and back for ventilation.
- Place the hub out of direct sunlight, and away from heat sources or areas with a high amount of electromagnetic interference.
- Check if network cables and connectors needed for installation are available.

### Stacking Hubs on a Flat Surface

These CheetaHubs can be stacked anywhere there is a enough flat space, such as on a table or desktop.

1. Stick the self-adhesive rubber foot pads (that come with this package) on each of the 4 concave spaces located on the bottom of the first hub.
2. Place the first hub on a firm flat surface where you want to install the stack.
3. Repeat step 1 for each hub before stacking them. The rubber foot pads cushion the hub against shock/vibrations and provide space between each hub for ventilation.
4. For added stability when stacking hubs, you can purchase the optional Stack Mount Brackets from your Accton distributor, and secure each hub to the adjacent unit.

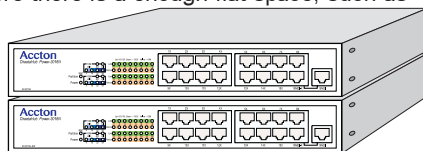

### Connecting the Hub System

These hubs have 8 (or 16) RJ-45 dual-speed RJ-45 station ports, one of which also serves as a dual-speed MDI daisy-chain port. Two stack backplane ports are also located on the rear panel; using these ports you can stack up to six hubs.

### Making a Connection via an RJ-45 Station Port

You can connect any RJ-45 (MDI-X) station port on the hub to any device that uses a standard network interface such as a workstation or server, or to a network inter-connection device such as a bridge or router (depending on the port type implemented).

1. Prepare the network devices you wish to network. Make sure you have installed 10BASE-T or 100BASE-TX network interface cards for connecting to the hub's RJ-45 (MDI-X) station ports.
2. You also need to prepare straight-through shielded or unshielded twisted-pair cables with RJ-45 plugs at both ends. Use 100Ω Category 3, 4 or 5 cable for standard 10 Mbps Ethernet connections, or 100Ω Category 5 cable for 100 Mbps Fast Ethernet connections.
3. Connect one end of the cable to the RJ-45 port of the network interface card, and the other end to any available (MDI-X) station port on the hub. The RJ-45 ports support 10 Mbps and 100 Mbps Ethernet connections. When inserting an RJ-45 plug, be sure the tab on the plug clicks into position to ensure that it is properly seated. Using a hub in a stand-alone configuration, you can network up to 8 (16) end nodes.

Do not plug a phone jack connector into any RJ-45 port. This may damage the hub. Use only twisted-pair cables with RJ-45 connectors that conform with FCC standards.

- Notes:**
1. Make sure each twisted-pair cable does not exceed 100 meters (328 feet).
  2. We advise using Category 5 cable for all network connections to avoid any confusion or inconvenience in the future when you upgrade attached devices to Fast Ethernet.

### Making a Connection to the BNC Port (EH3016N, EH3016N-SW only)

Plug the BNC T-type connector (provided with the hub) into a BNC port on the back of the EN3016N or EN3016N-SW. When connecting two devices via BNC ports, there should be at least 0.5 meters (1.64 feet) of coaxial cable between the two BNC ports. A thin Ethernet coaxial cable segment can be extended up to 185 meters (607 feet) and can link up to 30 nodes. If the unit is at the terminal end of a segment, connect a 50Ω terminator to the open end of the "T" connector.

### Making a Connection via an MDI Daisy-Chain Port

Use the RJ-45 MDI daisy-chain port to connect to another compatible hub or switch.

1. Prepare straight-through shielded or unshielded twisted-pair cables with RJ-45 plugs at both ends. Use 100Ω Category 3, 4 or 5 cable for standard 10 Mbps Ethernet connections, or 100Ω Category 5 cable for 100 Mbps Fast Ethernet connections.
2. Connect the MDI port on the switch to any MDI-X station port on the other device. When inserting an RJ-45 plug, be sure the tab on the plug clicks into position to ensure that it is properly seated.

- Notes:**
1. Make sure each twisted-pair cable does not exceed 100 meters (328 feet).
  2. To connect to another hub or switch, you can also connect from any MDI-X port on the switch to an MDI daisy-chain port on the other device, or attach to (MDI-X) station ports at both ends using crossover cable.

**Restrictions on Cascade Length** - When cascading to another repeater, note that the attached repeaters will function as a single logical repeater, with all ports attached to the same collision domain.

- **10 Mbps Cascade** - Based on the IEEE 802.3 recommendation, you may cascade up to four 10 Mbps hubs.
- **100 Mbps Cascade** - When cascading to a Fast Ethernet hub, limit the daisy-chain to two hubs. Another limitation for cascading Fast Ethernet concerns connection length. All end-node devices (e.g., workstations or servers) must be within 100 meters (328 feet) of the connected hub; and the overall length between any two nodes should not exceed 205 meters (672 feet). The easiest way to cascade two Fast Ethernet hubs is to connect the MDI daisy-chain port on the front panel to an MDI-X port on the other hub. For example, if both node A and B are linked to separate repeaters in a two hub system, each using 100 meters of cable to connect to their respective hub, then the inter-hub cabling will be limited to 5 meters (16 feet). The only way to extend the inter-hub cabling, would therefore be to reduce the length of the cabling used to attach the end nodes to the hubs.
- **Ethernet Switch** - There are no formal restrictions on cascade length if a device is connected to a switch, which effectively breaks up the collision domain. When a collision domain is broken up by a device like a switch, cascade length is limited only by the time-out requirements of the particular applications running over the network.

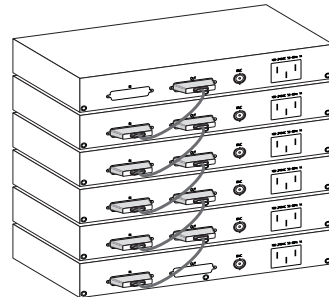

**Connecting to the Stack's Backplane**

Plug one end of the stacking cable (provided with this package) into the "Out" port of the top hub and the other end into the "In" port of the next hub. Repeat this step for each hub in the stack so that there is a simple chain starting from the "Out" port of the top hub and ending at the "In" port of the last hub.

You can stack up to six units using the stack ports.

- Notes:**
1. If more than one hub with internal switching (either the EH3008N-SW or EH3016N-SW) is placed in the stack, switching between stack segments will be managed by the highest unit in the stack, and internal switching will be disabled for all other units.
  2. If any hubs in the stack are powered off, traffic flowing across the stack's backplane will automatically bypass those units.

**Powering On the Hub**

1. Plug the power cord into the power socket at the rear of the hub, and the other end into a power outlet.
2. Check the LED marked Power on the front panel to see if it is on. The unit will automatically select the setting that matches the connected input voltage. Therefore, no additional adjustments are necessary when connecting it to any input voltage within the range marked on the rear panel.

**Verifying Port Status**

Check each connection by viewing the port status indicators shown in the following figure and table.

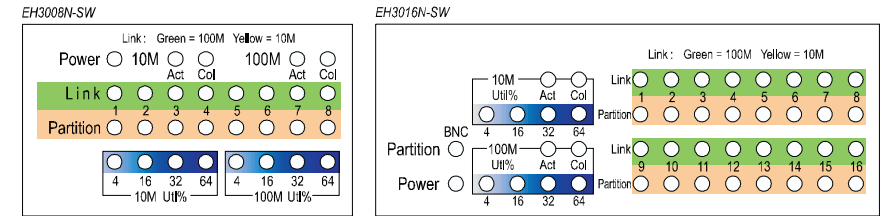

LED	State	Indication
Power	On (green)	Hub is receiving power.
Act	Flashing (green)	Traffic is traversing the 10M or 100M repeater bus.
Col	Flashing (yellow)	Packet collision detected in the 10M or 100M segment.
Link	On (green)	Port has established a valid 100M network connection.
	On (yellow)	Port has established a valid 10M network connection.
Partition	On (yellow)	The port has been partitioned from the network.
10M Util%	On (green/yellow)	10M segment utilization at 4/16/32% (green), 64% (yellow).
100M Util%	On (green/yellow)	100M segment utilization at 4/16/32% (green), 64% (yellow).
BNC	On (yellow)	Port partitioned from network. (EH3016N, EH3016N-SW only).

**Verifying System Operation**

Verify that all attached devices have a valid connection. The hub monitors the link status for each port. If any device is properly connected to the hub and transmitting a link beat signal, the Link indicator will light up for the corresponding port. If the Link indicator fails to light when you connect a device to the hub, check the following items:

- Be sure the twisted-pair cable is properly attached to the connected device and the hub. Verify that the media connector snaps into place when attached.
- See if your cable is functioning properly by using it for another port and attached device that displays valid indications when connected to the network.
- Check the length of each twisted-pair cable to be sure it does not exceed 100 meters (328 feet). If you have cascaded two Fast Ethernet hubs together, be sure the interhub cabling is no longer than 5 meters (16 feet).
- Verify that the workstation's adapter card is functioning properly by trying it in another computer that has been successfully connected to the network.

**Applications**

These dual-speed CheetaHubs allow great flexibility in configuring your network. You can use them in a stand-alone or multiple hub configuration to mix and match both legacy Ethernet and Fast Ethernet network resources on your local network. Moreover, you can easily extend your LAN by making a high-speed connection to a collapsed backbone device (e.g., a switch or a router).

**Stand-Alone Network** - The CheetaHubs with the internal switching function (EH3008N-SW, EH3016N-SW) can be used in a simple stand-alone configuration as illustrated in the figure below. Regardless of whether you are making 10 or 100 Mbps connections with twisted-pair cable, limit the distance for each cable to 100 meters (328 feet).

**Cascading Hubs with the Daisy-Chain Port** - You can easily connect to another hub or switch via the RJ-45 MDI daisy-chain port on the front panel. The figure below shows a sample configuration. When connecting to 10 Mbps Ethernet, the maximum number of hubs that can be cascaded is four (with up to 100 meters or 328 feet of cable allowed between each hub). However, when connecting to another Fast Ethernet hub, the number of hubs that can be cascaded is limited to two, and the total network span allowed is only 205 meters (672 feet).

**Stack of Hubs** - You can stack up to six hubs using the stack ports on the rear panel. A CheetaHub stack can include up to 96 RJ-45 ports. Also note that if more than one hub with internal switching (EH3008N-SW or EH3016N-SW) is placed in the stack, switching between stack segments will be managed by the uppermost unit in the stack, and internal switching will be disabled for all other units.

**Connecting to a Network Backbone** - You can easily connect to a collapsed backbone switch via the RJ-45 MDI daisy-chain port on the front panel. Because a switch breaks up the collision domain, it can be used to connect a group of CheetaHub stacks.

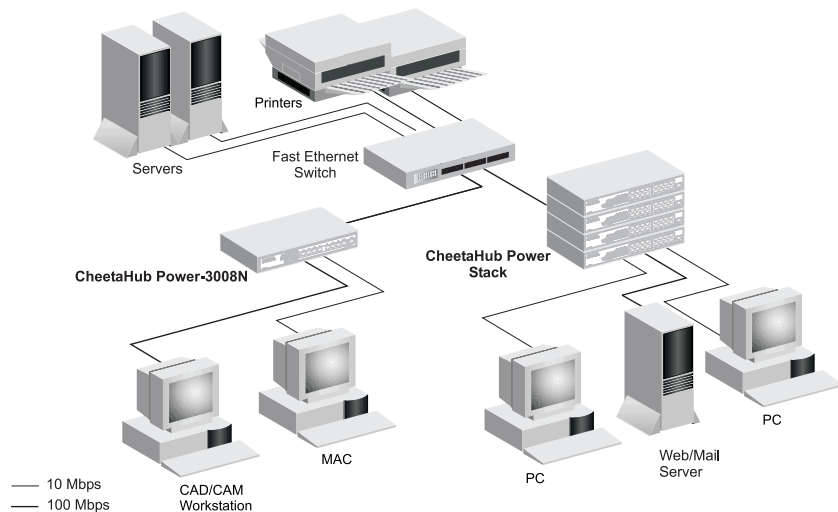

**Product Specifications**

**Repeater Criteria**

Access Method	CSMA/CD, 10 Mbps or 100 Mbps
Standards Conformance	IEEE 802.3 10BASE-T, IEEE 802.3u 100BASE-TX, IEEE 10BASE2 (EH3016N/SW)
Communication Rate	10/100 Mbps on RJ-45 ports, 10M on BNC port
Media Supported	10BASE-T - 100Ω Category 3,4,5 twisted-pair 100BASE-TX - 100Ω Category 5 twisted-pair 10BASE2 - thin Ethernet coaxial cable (EH3016N/SW)
Number of Ports	8 RJ-45 ports (EH3008N/SW) 16 RJ-45 ports (EH3016N/SW) 1 BNC port (EH3016N/SW) 1 MDI daisy-chain port (replaces 1 station port)
Indicator Panel	All models have 2 stack ports on the rear panel LEDs for monitoring power, activity, collision, port link (10/100M), port partition, and utilization

Input Power (full range)	100 to 240V (+6% ~ -10%), 50 to 60 Hz (±3Hz)	
	EH3008N	EH3016N
Power Consumption	15 Watts max.	27 Watts max.
Heat Dissipation	51 BTU/hr max.	92 BTU/hr max.
Maximum Current (110/240V)	0.10 / 0.05 A <sub>RMS</sub>	0.23 / 0.11 A <sub>RMS</sub>
Dimensions	251x116x37 mm 9.88x4.56x1.46 in	273x166x43 mm 10.75x6.54x1.69 in
Weight	0.83Kg (1.83lb)	1.65Kg (3.64lb)
Temperature	0~40°C (32~104°F) Standard Operating, -25~70°C (-13~158°F) Storage	
Humidity	5% to 95% (Non-condensing)	
Certification	CE Mark	
Emissions	EH3008N: FCC Class B, VCCI Class B, CISPR Class B EH3016N: FCC Class A, VCCI Class A, CISPR Class A	
Immunity	IEC 1000-4-2/3/4/6	
Safety	CSA/NRTL, TÜV/GS	

**Internal Switching Criteria**

Network Bridging Function	Filtering, forwarding and learning
Switching Method	Store-and-forward
Address Table	4K entries
Queue Buffer	9K bytes / 10M port, 87K bytes / 100M port
Filtering/Forwarding Rate	Line speed

**Troubleshooting**

**Diagnosing Hub Indicators**

The hub can be easily monitored through panel indicators to assist the network manager in identifying problems. This section describes common problems you may encounter and possible solutions.

- Symptom: Link 10/100M indicator does not light up after making a connection.  
Cause: Network interface (e.g., a network adapter card on the attached device), network cable, or hub port is defective.  
Solution: Verify that the hub and attached device are powered on. Be sure the cable is plugged into both the hub and corresponding device. Verify that the proper cable type is used and its length does not exceed specified limits. Check the adapter on the attached device and cable connections for possible defects. Replace the defective adapter or cable if necessary.
- Symptom: Power indicator does not light up (green) after power on.  
Cause: Defective power outlet, power cord, or internal power supply.  
Solution: Check the power outlet by plugging in another device that is functioning properly. Check the power cord with another device. If these measures fail to resolve the problem, have the unit's power supply replaced by a qualified Accton distributor.

**Power and Cooling Problems**

If the Power indicator does not turn on when the power cord is plugged in, you may have a problem with the power outlet, power cord, or internal power supply as explained in the previous section. However, if the unit powers off after running for a while, check for loose power connections, power losses or surges at the power outlet, and verify that the fan on back of the unit is unobstructed and running prior to shutdown. If you still cannot isolate the problem, then the internal power supply may be defective. In this case, contact your Accton distributor for assistance.

**Installation**

Verify that all system components have been properly installed. If one or more components appear to be malfunctioning (e.g., the power cord or network cabling), test them in an alternate environment where you are sure that all the other components are functioning properly.

**Port and Cable Assignments**

**RJ-45 Port Description**

RJ-45 (MDI-X) station ports can be attached to any devices which use a standard network interface (e.g., a workstation, server, bridge or router). RJ-45 (MDI) daisy-chain ports can be cascaded to a station port on similar networking devices (e.g., another hub or switch). Use unshielded twisted-pair (UTP) or shielded twisted-pair (STP) cable for RJ-45 connections: 100Ω Category 3, 4 or 5 cable for 10 Mbps connections or 100Ω Category 5 cable for 100 Mbps connections. Also be sure that the length of any twisted-pair connection does not exceed 100 meters (328 feet).

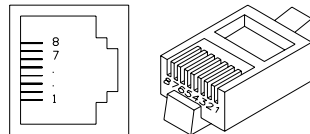

Pin	Assignment (Station Ports 1 - 8/16)	Assignment (Daisy-Chain Port, other device)
1	Input Receive Data +	Output Transmit Data +
2	Input Receive Data -	Output Transmit Data -
3	Output Transmit Data +	Input Receive Data +
6	Output Transmit Data -	Input Receive Data -
4,5,7,8	Not Used	Not Used

Schematics for both straight and crossover twisted-pair cable are shown below.

Straight-Through		Crossover	
(Hub)	(Adapter)	(Hub)	(Hub)
1 IRD+	1 OTD+	1 IRD+	2 IRD-
2 IRD-	2 OTD-	2 IRD-	3 OTD+
3 OTD+	3 IRD+	3 OTD+	6 OTD-
6 OTD-	6 IRD-	6 OTD-	1 IRD+

**EMI Certification (ES3008N)**

**FCC Class B (USA)**

Accton Technology Corporation  
Model Number: EH3008N

This device complies with Part 15 of the FCC Rules. Operation is subject to the following conditions:

1. This device may not cause harmful interference, and
2. This device must accept any interference received, including interference that may cause undesired operation.

Warning: This equipment has been tested and found to comply with the limits for a Class B digital device, pursuant to Part 15 of the FCC Rules. These limits are designed to provide reasonable protection against harmful interference in a residential installation. This equipment generates, uses and can radiate radio frequency energy and, if not installed and used in accordance with the instructions,

may cause harmful interference to radio communications. However, there is no guarantee that interference will not occur in a particular installation. If this equipment does cause harmful interference to radio or television reception, which can be determined by turning the equipment off and on, the user is encouraged to try to correct the interference by one or more of the following measures:

- Reorient or relocate the receiving antenna
- Increase the separation between the equipment and receiver
- Connect the equipment into an outlet on a circuit different from the one which the receiver is connected to
- Consult the dealer or an experienced radio/TV technician for help

You are cautioned that changes or modifications not expressly approved by the party responsible for compliance could void your authority to operate the equipment.

Note: In order to maintain compliance with the limits of a Class B digital device, Accton requires that you use a quality interface cable when connecting to this device. Changes or modifications not expressly approved by Accton could void your authority to operate this equipment. Suggested cable type is: RJ-45: Unshielded or shielded (UTP/STP) cable – Category 3 or greater for 10Mbps connections, and Category 5 for 100Mbps connections.

**Class B (Canada Department of Communications)**

This digital apparatus does not exceed the Class B limits for radio noise emissions from digital apparatus as set out in the interference-causing equipment standard entitled "Digital Apparatus", ICES-003 of the Department of Communications.

Cet appareil numérique respecte les limites de bruits radioélectriques applicables aux appareils numériques de Classe B prescrites dans la norme sur le matériel brouilleur: "Appareils Numériques", NMB-003 édictée par le ministère des Communications.

**VCCI Class B Compliance (Japan)**

この装置は、情報処理装置等電波障害自主規制協議会（VCCI）の基準に基づくクラスB情報技術装置です。この装置は、家庭環境で使用することを目的としていますが、この装置がラジオやテレビジョン受信機に近接して使用されると、受信障害を引き起こすことがあります。  
取扱説明書に従って正しい取り扱いをして下さい。

**CE Mark Declaration of Conformance (for EMI and Safety - Europe)**

This is to certify that this product complies with ISO/IEC Guide 22 and EN45014. It conforms to the following specifications:

EMC:	EN55022(1988)/CISPR-22(1985)	class B
	IEC1000-4-2(1995)	4kV CD, 8kV AD
	IEC1000-4-3(1995)	3V/m
	IEC1000-4-4(1995)	1kV - (power line), 0.5kV - (signal line)
	IEC1000-4-6(1995)	3Vrms

This product complies with the requirements of the Low Voltage Directive 73/23/EEC and the EMC Directive 89/336/EEC.

**EMI Certification (EH3016N)****FCC Class A Certification (USA)**

Warning: This equipment generates, uses, and can radiate radio frequency energy and, if not installed and used in accordance with the instruction manual, may cause interference to radio communications. It has been tested and found to comply with the limits for a Class A digital device pursuant to Subpart B of Part 15 of FCC Rules, which are designed to provide reasonable protection against such interference when operated in a commercial environment. Operation of this equipment in a residential area is likely to cause interference, in which case the user, at his own expense, will be required to take whatever measures are required to correct the interference.

You may use unshielded twisted-pair (UTP) for RJ-45 connections - Category 3 or greater for 10Mbps connections, and Category 5 for 100Mbps connections.

**Canada Department of Communications - Class A**

This digital apparatus does not exceed the Class A limits for radio noise emissions from digital apparatus as set out in the interference-causing equipment standard entitled "Digital Apparatus", ICES-003 of the Department of Communications.

Cet appareil numérique respecte les limites de bruits radioélectriques applicables aux appareils numériques de Classe A prescrites dans la norme sur le matériel brouilleur : "Appareils Numériques", NMB-003 édictée par le ministère des Communications.

**Class A (Taiwan Bureau of Commodities)**

警告使用者：這是甲類的資訊產品，在居住的環境中使用時，可能會造成射頻干擾，在這種情況下，使用者會被要求採取某些適當的對策。

**VCCI Class A Compliance (Japan)**

この装置は、情報技術装置等電源障害自主規制協議会（VCCI）の基準に基づくクラスA情報技術装置です。この装置を家庭環境で使用すると電波妨害を引き起こすことがあります。この場合には使用者が適切な対策を講ずるよう要求されることがあります。

**CE Mark Declaration of Conformance for EMI and Safety (EEC)**

This is to certify that this product complies with ISO/IEC Guide 22 and EN45014. It conforms to the following specifications:

EMC:	EN55022(1988)/CISPR-22(1985)	class A
	EN60555-2(1995)	class A
	EN60555-3	
	IEC1000-4-2(1995)	4kV CD, 8kV AD
	IEC1000-4-3(1995)	3V/m
	IEC1000-4-4(1995)	1kV - (power line), 0.5kV - (signal line)

This product complies with the requirements of the Low Voltage Directive 73/23/EEC and the EMC Directive 89/336/EEC.

**Warning!** Do not plug a phone jack connector in the RJ-45 port. This may damage this device. Les raccordeurs ne sont pas utilisés pour le système téléphonique!

**Safety Compliance****Underwriters Laboratories Inc. (USA)**

**Important!** Before making connections, make sure you have the correct Cord Set. Check it (read the label on the cable) against the following specification list.

Voltage	Cord Set Specifications
120 Volts	UL Listed/CSA Certified Cord Set
	Minimum 18 AWG; type SVT or SJT three conductor cord
	Maximum length of 15 feet
240 Volts (North America)	Parallel blade, grounding type attachment plug rated 15A, 125V
	UL Listed/CSA Certified Cord Set
	Minimum 18 AWG; type SVT or SJT three conductor cord
240 Volts (Europe only)	Maximum length of 15 feet
	Tandem blade, grounding type attachment plug rated 15A, 125V
	Cord Set with H05VV-F cord having three conductors with minimum diameter of 0.75 mm <sup>2</sup>
	IEC-320 receptacle; male plug rated 10A, 250V

**Wichtige Sicherheitshinweise (Germany)**

- Bitte lesen Sie diese Hinweise sorgfältig durch.
  - Heben Sie diese Anleitung für den späteren Gebrauch auf.
  - Vor jedem Reinigen ist das Gerät vom Stromnetz zu trennen. Verwenden Sie keine Flüssigoder Aerosolreiniger. Am besten eignet sich ein angefeuchtetes Tuch zur Reinigung.
  - Die Netzanschlusßsteckdose soll nahe dem Gerät angebracht und leicht zugänglich sein.
  - Das Gerät ist vor Feuchtigkeit zu schützen.
  - Bei der Aufstellung des Gerätes ist auf sicheren Stand zu achten. Ein Kippen oder Fallen könnte Beschädigungen hervorrufen.
  - Die Belüftungsöffnungen dienen der Luftzirkulation, die das Gerät vor Überhitzung schützt. Sorgen Sie dafür, daß diese Öffnungen nicht abgedeckt werden.
  - Beachten Sie beim Anschluß an das Stromnetz die Anschlusßwerte.
  - Verlegen Sie die Netzanschlusßleitung so, daß niemand darüber fallen kann. Es sollte auch nichts auf der Leitung abgestellt werden.
  - Alle Hinweise und Warnungen, die sich am Gerät befinden, sind zu beachten.
  - Wird das Gerät über einen längeren Zeitraum nicht benutzt, sollten Sie es vom Stromnetz trennen. Somit wird im Falle einer Überspannung eine Beschädigung vermieden.
  - Durch die Lüftungsöffnungen dürfen niemals Gegenstände oder Flüssigkeiten in das Gerät gelangen. Dies könnte einen Brand bzw. elektrischen Schlag auslösen.
  - Öffnen sie niemals das Gerät. Das Gerät darf aus Gründen der elektrischen Sicherheit nur von autorisiertem Servicepersonal geöffnet werden.
  - Wenn folgende Situationen auftreten ist das Gerät vom Stromnetz zu trennen und von einer qualifizierten Servicestelle zu überprüfen:
    - Netzkabel oder Netzstecker sind beschädigt.
    - Flüssigkeit ist in das Gerät eingedrungen.
    - Das Gerät war Feuchtigkeit ausgesetzt.
    - Wenn das Gerät nicht der Bedienungsanleitung entsprechend funktioniert oder Sie mit Hilfe dieser Anleitung keine Verbesserung erzielen.
    - Das Gerät ist gefallen und/oder das Gehäuse ist beschädigt.
    - Wenn das Gerät deutliche Anzeichen eines Defektes aufweist.
- Der arbeitsplatzbezogene Schalldruckpegel nach DIN 45 635 Teil 1000 beträgt 70dB(A) oder weniger.
- Zum Netzanschluß dieses Gerätes ist eine geprüfte Leitung zu verwenden. Für einen Nennstrom bis 6A und einem Gerätegewicht größer 3kg ist eine Leitung nicht leichter als H05VV-F, 3G, 0.75mm<sup>2</sup> einzusetzen.



**Warranty**

Accton warrants to the original owner that the product delivered in this package will be free from defects in material and workmanship for a period of three years from the date of purchase from Accton or its Authorized reseller. For the warranty to apply, you must register your purchase by returning the registration card indicating the date of purchase and including proof of purchase. There will be a minimal charge to replace consumable components, such as fuses, power transformers, and mechanical cooling devices. The warranty does not cover the product if it is damaged in the process of being installed. Accton recommends that you have the company from whom you purchased this product install it.

THE ABOVE WARRANTY IS IN LIEU OF ANY OTHER WARRANTY, WHETHER EXPRESS, IMPLIED OR STATUTORY, INCLUDING BUT NOT LIMITED TO ANY WARRANTY OF MERCHANTABILITY, FITNESS FOR A PARTICULAR PURPOSE, OR ANY WARRANTY ARISING OUT OF ANY PROPOSAL, SPECIFICATION OR SAMPLE. ACCTON SHALL NOT BE LIABLE FOR INCIDENTAL OR CONSEQUENTIAL DAMAGES. ACCTON NEITHER ASSUMES NOR AUTHORIZES ANY PERSON TO ASSUME FOR IT ANY OTHER LIABILITY.