

Multilayer Chip Baluns For WiMAX

Conformity to RoHS Directive

HHM Series HHM1711E1

SHAPES AND DIMENSIONS

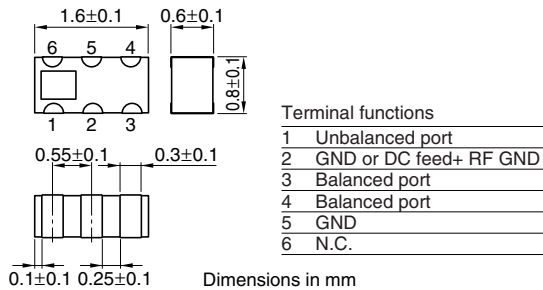

CIRCUIT DIAGRAM

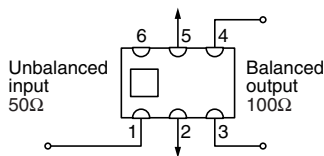

RECOMMENDED PC BOARD PATTERNS

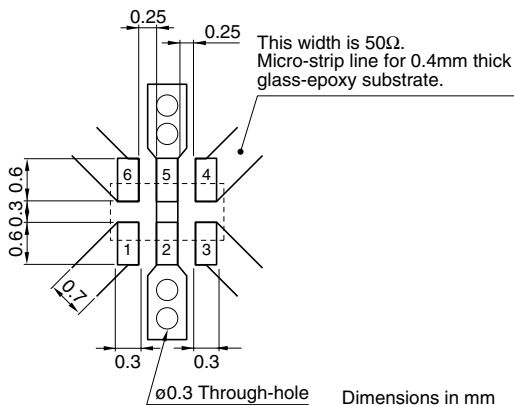

ELECTRICAL CHARACTERISTICS

Unbalanced impedance	50Ω
Balanced impedance	100Ω
Frequency range	2300 to 2700MHz
Unbalanced port return loss	10dB min.
Phase imbalance at balanced port	180±12deg
Amplitude imbalance at balanced port	0±1.5dB
Insertion loss	1.2dB max.
Power capacity	0.5W max.
Temperature range	Operating -40 to +85°C Storage -40 to +85°C
Packaging style and quantities	4000pieces/reel

• Conformity to RoHS Directive: This means that, in conformity with EU Directive 2002/95/EC, lead, cadmium, mercury, hexavalent chromium, and specific bromine-based flame retardants, PBB and PBDE, have not been used, except for exempted applications.

• All specifications are subject to change without notice.

FREQUENCY CHARACTERISTICS

Unbalance 50Ω/Balance 100Ω

RETURN LOSS

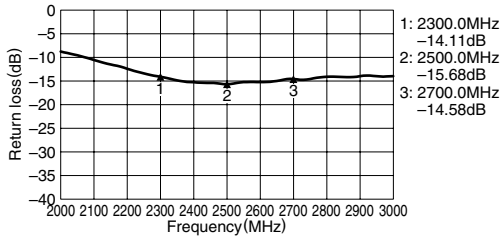

AMPLITUDE BALANCE

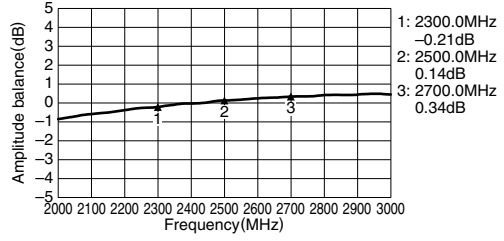

INSERTION LOSS

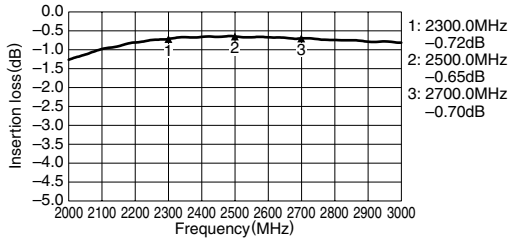

PHASE BALANCE

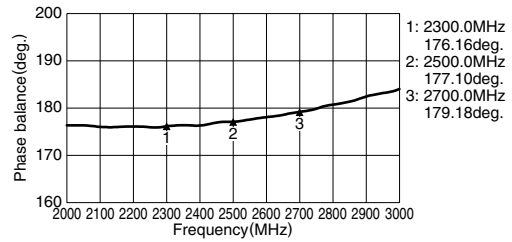

• All specifications are subject to change without notice.