

3G3RV-P10ST□-E

G7/F7/L7/E7 inverter PLC

The OMRON PLC technology embedded in the OMRON Yaskawa inverter family

- OMRON PLC programmability in the OMRON Yaskawa inverters.
- Flexibility and intelligence in the OMRON Yaskawa inverter family.
- Wireless installation and seamless access to the inverter parameters and analogue/digital inputs and outputs.
- OMRON Compubus/S fieldbus inside. Thus, able to control up to 256I/O's.
- Easy to integrate in the automation world: DeviceNet type available.
- Standard OMRON tools can be used for programming and commissioning.
- Ideal for applications like:
 - Pump sequencing, remote control, water treatment, etc together with the HVAC inverter: E7&E7 IP54.
 - Lift as control sequence inside, using the lift inverter: L7.
 - Cranes, winding/rewinding, position control, others combined with the powerful flux vector control inverter: F7Z.
 - General purpose using the high technology of G7 3-Level vector control.

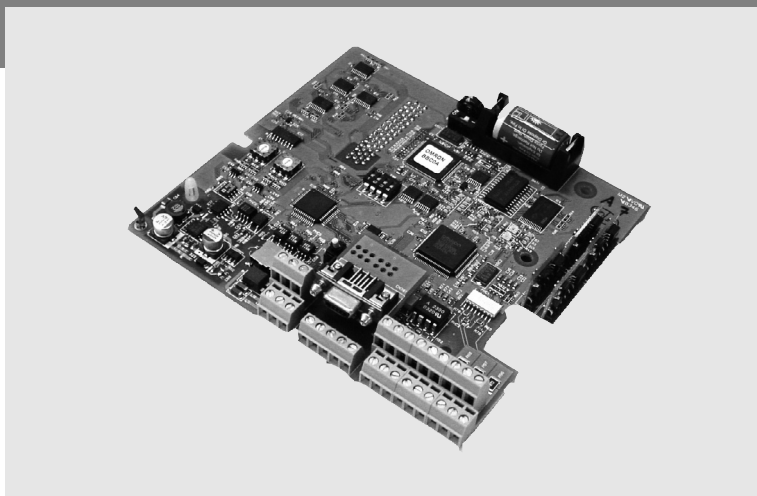

System configuration

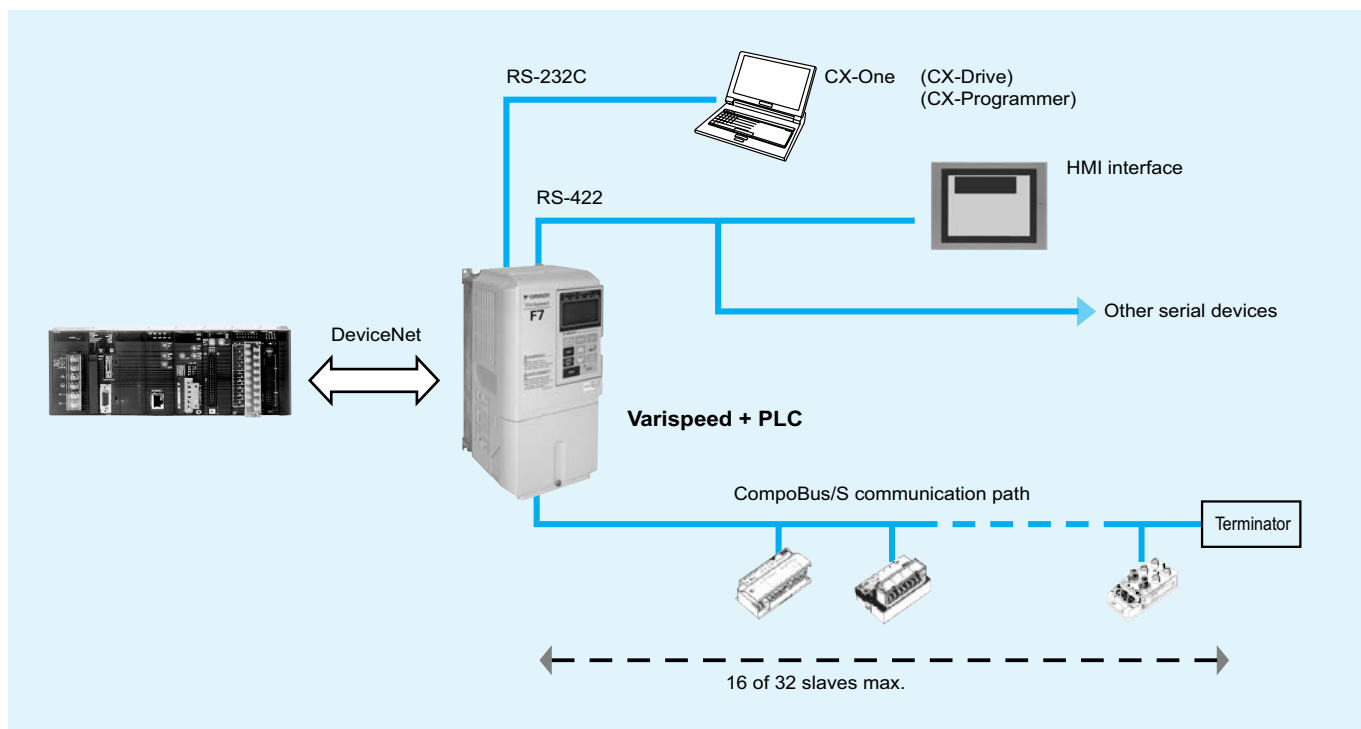

Type designation

PLC inverter

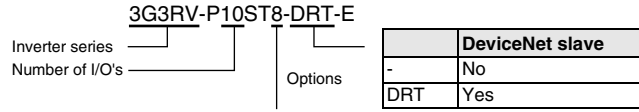

	Output	RTC	RS422	Remarks
-	NPN	NO	NO	
1	NPN	NO	YES	
2	NPN	YES	NO	
3	NPN	YES	YES	
5	PNP	NO	NO	
6	PNP	NO	YES	
7	PNP	YES	NO	
8	PNP	YES	YES	Standard

Specifications

Specifications by product

Item	3G3RV-P10ST8-E	3G3RV-P10ST8-DRT-E
PLC core	CPM2C-S	CPM2C-S
Inputs	6 24 VDC inputs	6 24 VDC inputs
Outputs	4 sourcing/PNP transistor outputs	4 sourcing/PNP transistor outputs
Peripheral port	Yes	Yes
RS-232C port	Yes	Yes
RS-422 port	No	Yes
Calendar/clock	Yes	Yes
Memory backup	Flash memory and battery	Flash memory and battery
CompoBus/S master interface	Yes	Yes
Encoder interface	Yes	Yes
DeviceNet Slave interface	No	Yes

General specifications

Item	Specifications	
	3G3RV-P10ST8-E	3G3RV-P10ST8-DRT-E
Rated power supply voltage	24 VDC ^{+10%} / _{-15%} (external power supply for I/O)	
Communications power supply voltage	---	11 to 25 VDC (supplied by communications connector)
Power consumption supply	Internal power	2 W (supplied internally) (see note)
	Communications power supply	3 W (supplied internally) (see note)
Vibration resistance	10 to 20 Hz, 9.8 m/s ² max. 20 to 50 Hz, 2 m/s ² max	
Ambient operating temperature	-10 to 45 °C	
Ambient operating relative humidity	10% to 90% (no condensation)	
Ambient storage temperature	-20 to 70 °C	
Atmosphere	Must be free from corrosive gas	
Control method	Store program method	
I/O control method	Cyclic scan method	
Programming language	Ladder chart method	
Instruction length	1 step/1 instruction; 1 to 5 words/1 instruction	
Instruction types	Basic	14 types (same as for programmable slaves)
	Special	105 types, 185 instructions (same as for programmable slaves)
Processing speed	Basic instructions	0.64 μs (LD)
	Special instructions	7.8 μs (MOV)
Program capacity	4,096 words	
Maximum number of I/O points	10	
Input bits	00000 to 00015 (6 physical inputs)	
Output bits	01000 to 01003 (4 physical outputs)	
CompoBus/S input bits	128 bits: IR 02000 to IR 02715 (bits not used for CompoBus/S input bits can be used for work bits.)	
CompoBus/S output bits	128 bits: IR 03000 to IR 03715 (bits not used for CompoBus/S output bits can be used for work bits.)	
Inverter interface	Direct interface with inverter through • IR-memory • DM-memory • Transfer command	
Inverter interface bits	176 bits: IR 20000 to IR 21015	
Encoder interface bits	48 bits: IR 02900 to IR 02915 and IR 04800 to IR 04915	
Work bits	448 bits: IR 02800 to IR 02815, IR 03800 to IR 04715, and IR 21100 to IR 22715	
Special bits (SR area)	448 bits: SR 22800 to SR 25507 (words SR 228 to SR 255)	
Temporary bits (TR area)	8 bits (TR 0 to TR 7)	
Holding bits (HR area)	320 bits: HR 0000 to HR 1915 (words HR 00 to 19)	
Auxiliary bits (AR area)	384 bits: AR 0000 AR 2315 (words AR 00 to AR 23)	

Item		Specifications	
		3G3RV-P10ST8-E	3G3RV-P10ST8-DRT-E
Link bits (LR area)		256 bits: LR 0000 to LR 1515 (words LR 00 to LR 15)	
Timers/counters		256 timers/counters (TIM/CNT 000 to TIM/CNT) <ul style="list-style-type: none"> 1-ms timers: TMHH(--) 10-ms timers: TIMH(15) 100-ms timers: TIM 1-s/10-s timers: TIML(--) Decrementing counters: CNT Reversible counters: CNTR(12) 	
CompoBus/S master functions		Remote I/O devices can be allocated up to 256 I/O points (128 inputs and 128 outputs) in input area IR 020 to IR 027 and output area IR 030 to IR 037. <ul style="list-style-type: none"> • The node numbers can be set to 0 to 7 (128-point mode) or 0 to 15 (256-point mode). • The communications mode can be set to high-speed mode (max. length 100 m) or long-distance mode (max. length 500 m). 	
DeviceNet slave functions		Up to 64 words (32 input words and 32 output words) can be allocated to the DeviceNet master's I/O. The master's I/O can be allocated to the following data areas: <ul style="list-style-type: none"> IR 000 to IR 049 IR 200 to IR 227 DM 0000 to DM 2047 LR 00 to LR 15 HR 00 to HR 19 AR 00 to AR 23 (3G3RV-P10ST ' master; read-only) TC 000 to TC 255 <ul style="list-style-type: none"> • Explicit message communications are supported. Any 3G3RV-P10ST data area can be accessed from the DeviceNet master. • The communications speed can be set to 500 kbps (total network length 100 m max.), 250 kbps (total network length 250 m max.), or 125 kbps (total network length 500 m max.). 	
DM area	Read/write	2,029 words (DM 0000 to DM 0999, DM 1019 to DM 2047) DM 2000 to DM 2021: error log storage area	
	Read only	456 words (DM6144 to 6599)	
	Inverter interface	19 words (DM 2022 to DM 2040)	
	Encoder interface	14 words (DM 1986 to DM 1999)	
	PLC setup	56 words (DM 6599 to DM 6655)	
Interrupts		Interrupt inputs 2 inputs Response time: 50 μs	
		Interval timer interrupts 1 input Set value: 0.5 to 319,968 ms Precision: 0.1 ms	Scheduled interrupts
		One-shot interrupt	
High-speed counters	High-speed counter 1 input, see note 5	No interrupt	
	Differential phase mode (5 kHz) Pulse plus direction input mode (20 kHz) Up/down input mode (20 kHz) Increment mode (20 kHz)	Count-check interrupt (An interrupt can be generated when the count equals the set value or the count lies within a preset range.)	
	Interrupt inputs (counter mode) 2 inputs	No interrupt	
	Incrementing counter (2 kHz) Decrementing counter (2 kHz)	Count-up interrupt	
Encoder interface		3 input modes: <ul style="list-style-type: none"> Differential-phase (up/down) Pulse plus direction Up/down pulse Maximum input frequency 50 kHz Maximum counter range 4,294,967,295 (232-1) Two capture registers, 3 selectable registration inputs One comparison value Counter reset through software or Z-phase Interrupt function	
Pulse outputs		<ul style="list-style-type: none"> • 2 outputs: Single-phase pulse output without acceleration/deceleration (see note 6.) 10 Hz to 10 kHz • 2 outputs: Variable duty ratio pulse output (see note 6.) 0.1 to 999.9 Hz, duty ratio 0 to 100% • 1 output: Pulse output with trapezoidal acceleration/deceleration (see note 6.) Pulse plus direction output, up/down pulse output, 10 Hz to 10 kHz 	
Synchronized pulse control		1 point, see notes 5 and 6 Input frequency range: 10 to 500 Hz, 20 Hz to 1 kHz, or 300 Hz to 20 kHz Output frequency range: 10 Hz to 10 kHz	
Pulse catch inputs		2 bits Minimum pulse input: 50 μs max. Used in common by input interrupts and input interrupt counter mode.	
Analog volume		None	
Input time constant (ON response time = OFF response time)		Determines the input time constant for all inputs. (settings: 1, 2, 3, 5, 10, 20, 40, or 80 ms)	
Clock/Calendar function		Shows the current year, month, day of the week, day of the month, hour, minute, and second.	
Communication function		Port 1 = Peripheral and RS-422: Host link, peripheral bus, no-protocol, programming console Port 2 = RS-232C port: Host link, no-protocol, 1:1 PLC link, 1:1 NT link	

Item	Specifications	
	3G3RV-P10ST8-E	3G3RV-P10ST8-DRT-E
Power-interruption hold function	Holds the contents of HR, AR, CNT, and DM areas.	
Memory backup (see notes 1 and 2.)	Flash memory: Program, read-only DM area, and PC setup Memory backup: The read/write DM area, HR area, AR area, and counter values are backed up. (The battery has a 5-year lifetime at 25 °C and it is replaceable.)	
Self-diagnostic function	CPU errors, memory errors, communications errors, setting errors, battery errors	
Program check	No END instruction, program errors (regularly checked during operation)	
Connected tools	CX-programmer	After version 2.1
	Programming console	C200H-PRO27, CQM1-PRO01
	SSS	PC98 & PC/AT (SYSMAC support software, all versions)
	CX-drive	Version 1 or higher

Note: 1. The DM area, HR area, AR area, and counter values are backed up. If the backup battery or capacitor is discharged, the contents of these areas will be lost and the data values will revert to the defaults.

2. The contents of the program area, read-only DM area (DM6144 to DM6599), and PLC setup (DM 6600 to DM 6655) are stored in flash memory. The contents of these areas will be read from flash memory the next time the power is turned ON, even if the backup battery or capacitor is discharged. When data has been changed in any of these areas, write the new values to flash memory by switching the 3G3RV-P10ST to MONITOR or RUN mode, or by turning the power OFF and then ON again.

- 3. Changes made while in MONITOR mode using, for example, online editing, are written to flash memory in real-time.
- 4. The above figure for power consumption includes the power consumption of the programming console.
- 5. This input is shared by the high-speed counter and synchronized pulse control functions.
- 6. This output is shared by the pulse output and synchronized pulse control functions.

I/O specifications

Input specifications

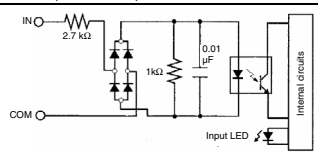
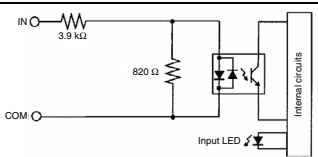
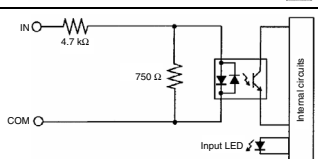
Item	Inputs	Specification
Input voltage	All	24 VDC $+10\%$ / -15%
Input impedance	IN 00000 to IN 00001	2.7 kΩ
	IN 00002 to IN 00004	3.9 kΩ
	IN 00005	4.7 kΩ
Input current	IN 00000 to IN 00001	8 mA typical
	IN 00002 to IN 00004	6 mA typical
	IN 00005	5 mA typical
ON voltage/current	IN 00000 to IN 00001	17 VDC min., 5 mA
	IN 00002 to IN 00005	14.4 VDC min., 3.5 mA
OFF voltage/current	All	5.0 VDC max., 1.1 mA
ON delay	All	1 to 80 ms max. Default: 10 ms (see note.)
OFF delay	All	1 to 80 ms max. Default: 10 ms (see note.)
Circuit configuration	IN 00000 to IN 00001	
	IN 00002 to IN 00004	
	IN 00005	

Note: The input time constant can be set to 1, 2, 3, 5, 10, 20, 40, or 80 ms in the PLC setup.

High-speed counter inputs

The following unit input bits can be used as high-speed counter inputs. The maximum count frequency is 5 kHz in differential phase mode and 20 kHz in the other modes.

Input	Function			
	Differential phase mode	Pulse plus direction input mode	Up/down input mode	Increment mode
IN 00000	A-phase pulse input	Pulse input	Increment pulse input	Increment pulse input
IN 00001	B-phase pulse input	Direction input	Decrement pulse input	Normal input
IN 00002	Z-phase pulse input or hardware reset input (IN00002 can be used as a normal input when it is not used as a high-speed counter input.)			

The minimum pulse widths for inputs IN00000 (A-phase input) and IN00001 (B-phase input) are as follows:

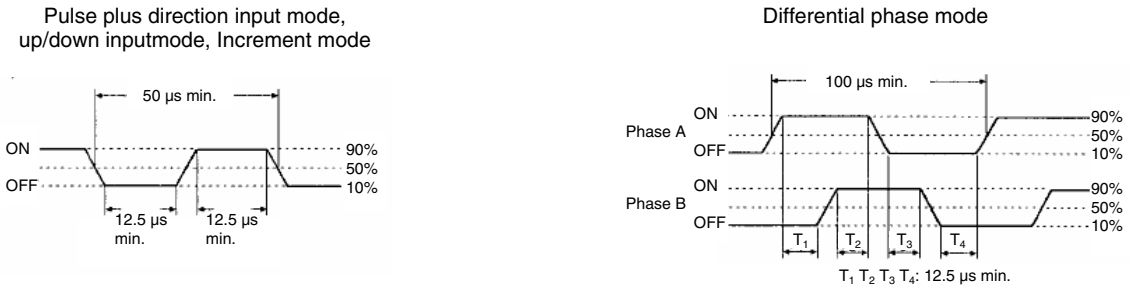

The minimum pulse width for input IN00002 (Z-phase input) is as follows:

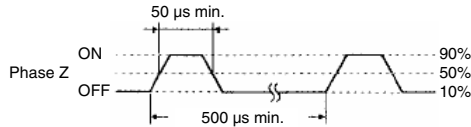

Interrupt inputs

3G3RV-P10ST is equipped with inputs that can be used as interrupt inputs (interrupt input mode or counter mode) and quick-response inputs. The minimum pulse width for these inputs is 50 µs. Inputs IN 00003 and IN 00004 can be used as interrupt inputs.

Output specifications

Transistor outputs (sourcing/PNP)

Item	Specification
Maximum switching capacity	4.5 to 30 VDC, 0.2 A/output
Minimum switching capacity	0.5 mA
Maximum inrush current	0.9 A for 10 ms
Leakage current	0.1 mA
Residual voltage	1.5 V max.
ON response time	20 µs max.
OFF response time	40 µs max. for 4.5 to 26.4 VDC, 10 to 100 mA 0.1 ms max for 4.5 to 30 VDC, 10 to 200 mA
Fuse	One fuse per output (cannot be replaced by user)
Circuit configuration	

Note: When using OUT 01000 or OUT 01001 as a pulse output, connect a dummy resistor as required to bring the load current between 0.01 and 0.1 A. If the load current is below 0.1 A, the ON-to-OFF response time will be longer and high-speed pulses (source-type transistor outputs) will not be output. If the load current is above 0.1 A, the transistor will generate more heat and components may be damaged.

Caution
Do not apply voltage in excess of the maximum switching capacity to an output terminal. It may result in damage to the product or fire.

Encoder input specifications

Signal level	All	EIA RS-422-A standards
Input impedance	A- and B-phase	280 Ω
	Z-phase	260 Ω
Response frequency	A- and B-phase	50 kHz max.
	Z-phase	1 kHz max.
Circuit configuration	A- and B-phase	
	Z-phase	

Operation

CPU unit component descriptions

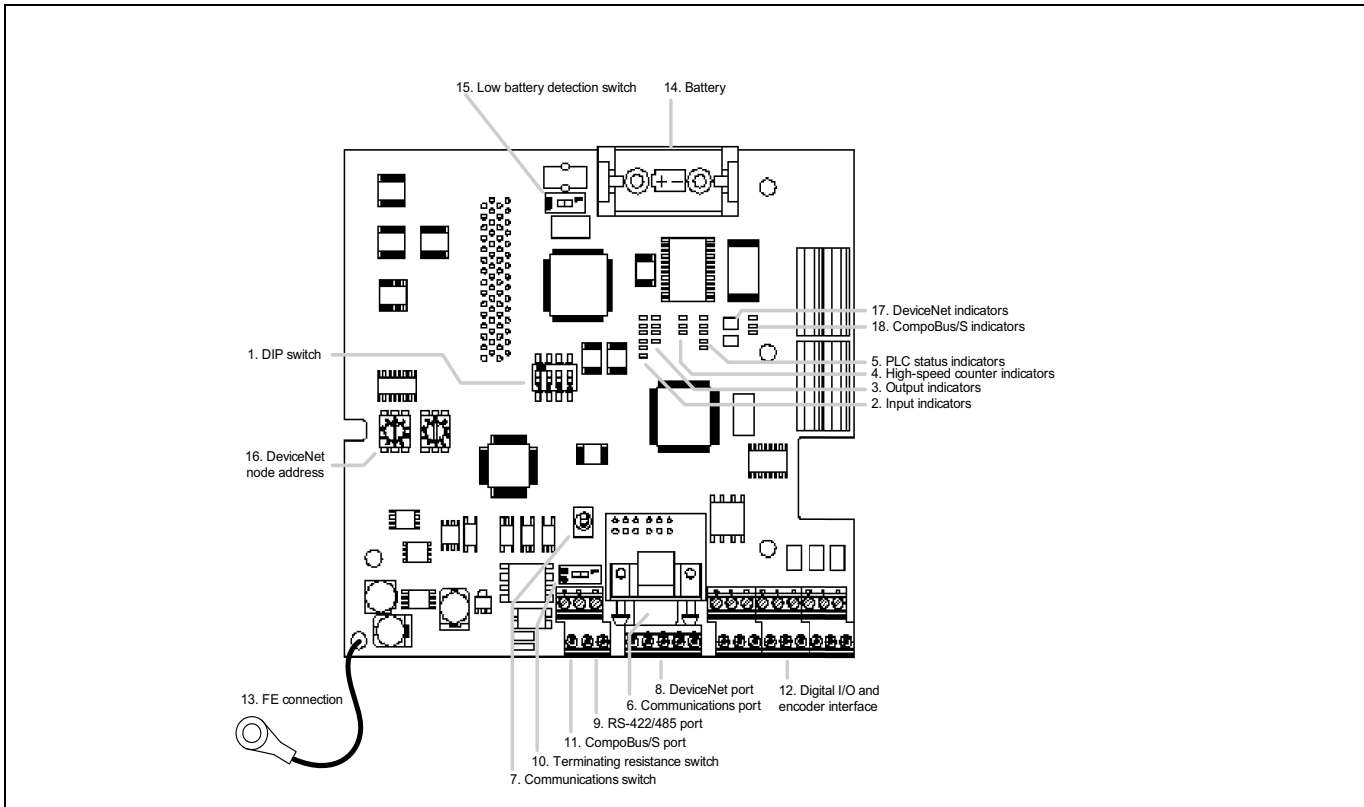

1. DIP switch

- RS-232C and peripheral port settings

	Pin 1	Effective port settings
	OFF (default)	The ports operate according to the settings in the PLC setup. RS-232C port settings: DM 6645 to DM 6649 Peripheral port settings: DM 6650 to DM 6654
	ON	The ports operate with the standard communications settings.

- Operating mode at startup

Pin 2 determines the operating mode at startup only if there isn't a programming device connected to the peripheral port.

Programming device connected	Startup mode with Pin 2 OFF (default)	Startup mode with Pin 2 ON
None	RUN mode	PROGRAM mode
Programming console	Operating mode set on the programming console's mode switch	
Other device	PROGRAM mode	

2. Input indicators (yellow)

The input indicators are lit when the corresponding input terminal is ON. The status of an input indicator will reflect the status of the input even when that input is being used for a high-speed counter.

- Note:**
1. When interrupt inputs are used in interrupt input mode, the indicator may not light even when the interrupt condition is met if the input is not ON long enough.
 2. Input indicators will reflect the status of the corresponding inputs even when the PLC is stopped, but the corresponding input bits will not be refreshed.

3. Output indicators (yellow)

The output indicators are lit when the corresponding output terminal is ON. The indicators are lit during I/O refreshing. The status of an output indicator will also reflect the status of the corresponding output when the output is being used as a pulse output.

4. High-speed counter indicators (yellow)

The indicators are lit when the corresponding input terminal is ON.

5. PLC status indicators

The following indicators show the operating status of the PLC.

Indicator	Status	Meaning
PWR	ON	Power is being supplied to the unit
	OFF	Power isn't being supplied to the unit
RUN	ON	The PLC is operating in RUN or MONITOR mode
	OFF	The PLC is in PROGRAM mode or a fatal error has occurred.
	Flashing	A non-fatal error has occurred. (PLC operation continues.)
ERR/ALM	ON	A fatal error has occurred. (PLC operation stops.)
	Flashing	A non-fatal error has occurred. (PLC operation continues.)
	OFF	Indicates normal operation.
COMM1 (yellow)	Flashing	Data is being transferred via the peripheral or RS-422/485 port.
	OFF	Data isn't being transferred via communications port.
COMM2 (yellow)	Flashing	Data is being transferred via the RS-232C port
	OFF	Data isn't being transferred via communications port.

6. Communications port

Connects the PLC to a programming device (including programming consoles), host computer, or standard external device. Use a proper connecting cable (CPM2C-CN111, CS1W-CN114, CS1W-CN118, or CS1W-CN226).

- Note:** 1. A CQM1H-PRO01-E programming console can be connected directly to the PLC.
 2. A C200H-PRO27-E programming console can be connected directly to the PLC with a CS1W-CN224/CN624 connecting cable.
 3. Use a CPM2C-CN111 or CS1W-CN114 connecting cable to connect to the communications port as a peripheral port. The communications port can be used simultaneously as both a peripheral port and RS-232C port by using the CPM2C-CN111 connecting cable.
 4. Use a CPM2C-CN111, CS1W-CN118 or CS1W-CN226 connecting cable to connect to the communications port as a RS-232C port. The communications port can be used simultaneously as both a peripheral port and RS-232C port by using the CPM2C-CN111 connecting cable

Note: The peripheral port and RS-422/485 port cannot be used simultaneously. When using the peripheral port disconnect any devices connected to the RS-422/485 port.

7. Communications switch

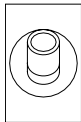

Switch to select port 1 type of connected device

Position	Communication port 1
OFF (up) (default)	Programming console
ON (down)	RS-422/485 communication

8. DeviceNet port (-DRT versions only)

Terminal arrangement

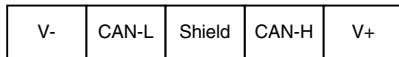

9. RS-422/485 port

Used to connect to host computers, or standard external devices.

Terminal arrangement

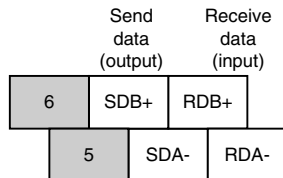

Note: The maximum line length is 500 m.
 The peripheral port and RS-422/485 port cannot be used simultaneously. When using the peripheral port disconnect any devices connected to the RS-422/485 port.
 When using RS-485 communication, connect RDA- to SDA- and RDB+ to SDB+.

10. Terminating resistance switch

	Position	Termination
	OFF (right) (default)	Disabled
	ON (left)	Enabled

Set this switch to ON only for double-ended connection to a host link network.

11. CompoBus/S port

Terminal arrangement

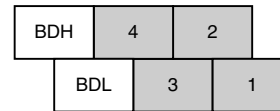

Use special flat cable or VCTF cable for the transmission lines that connect the nodes in the CompoBus/S I/O Link. (Special flat cables and VCTF cables cannot be combined in the same system.)

Name	Model number	Specifications
Flat cable	XB1T-W10	4-core flat cable, 0.75 mm ²
VCTF cable	---	2-core VCTF, 0.75 x 20

12. Digital inputs and outputs and encoder interface

Connects the CPU unit to external input and output devices.

Sourcing outputs

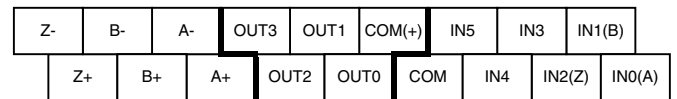

13. Functional earth-wire

To be connected the earth connection inside the inverter.

14. Battery

15. Low battery detection switch

This switch enables or disables the detection of a low-battery error.

	Position	Low-battery detection
	OFF (right) (default)	Error detection enabled
	ON (left)	Error detection disabled

16. DeviceNet node-number (-DRT versions only)

Please refer to the DeviceNet section

17. DeviceNet indicators (-DRT versions only)

Please refer to the DeviceNet section

18. CompoBus/S indicators

	Indicator	Status	Meaning
	SD (yellow)	Flashing	Data is being transmitted via CompoBus/S
		OFF	Data isn't being transmitted via CompoBus/S
	RD (yellow)	Flashing	Data is being received via CompoBus/S
		OFF	Data isn't being received via CompoBus/S
	ERC (red)	Flashing	A CompoBus/S communications error occurred.
		OFF	A CompoBus/S communications error hasn't occurred.

Dimensions

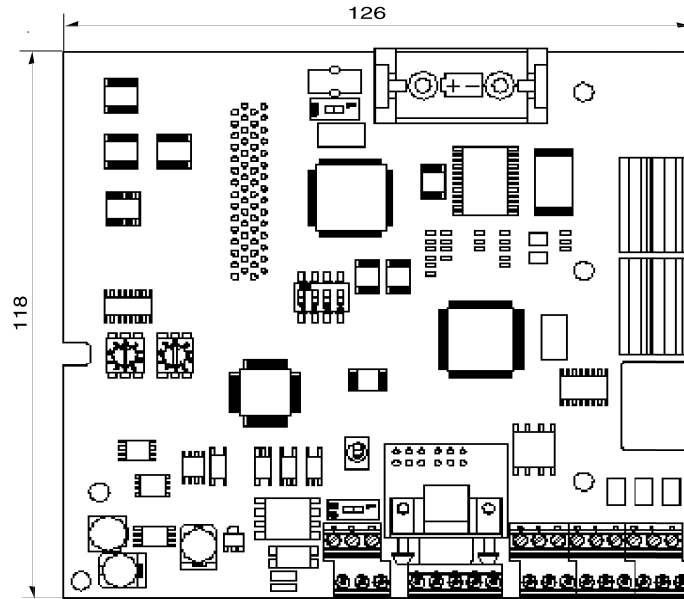

Application examples

G7 + PLC

Varispeed G7 is the OMRON Yaskawa solution using 3 level PWM control technology that provides lower surge voltage, low leakage current, low bearing current, low acoustic noise and better EMC. By combining with PLC option board, it is the ideal solution for winding/unwinding applications, handling / transfer / palletizer point-to-point positioning applications, press control applications, extruder control applications and pump applications for examples ..

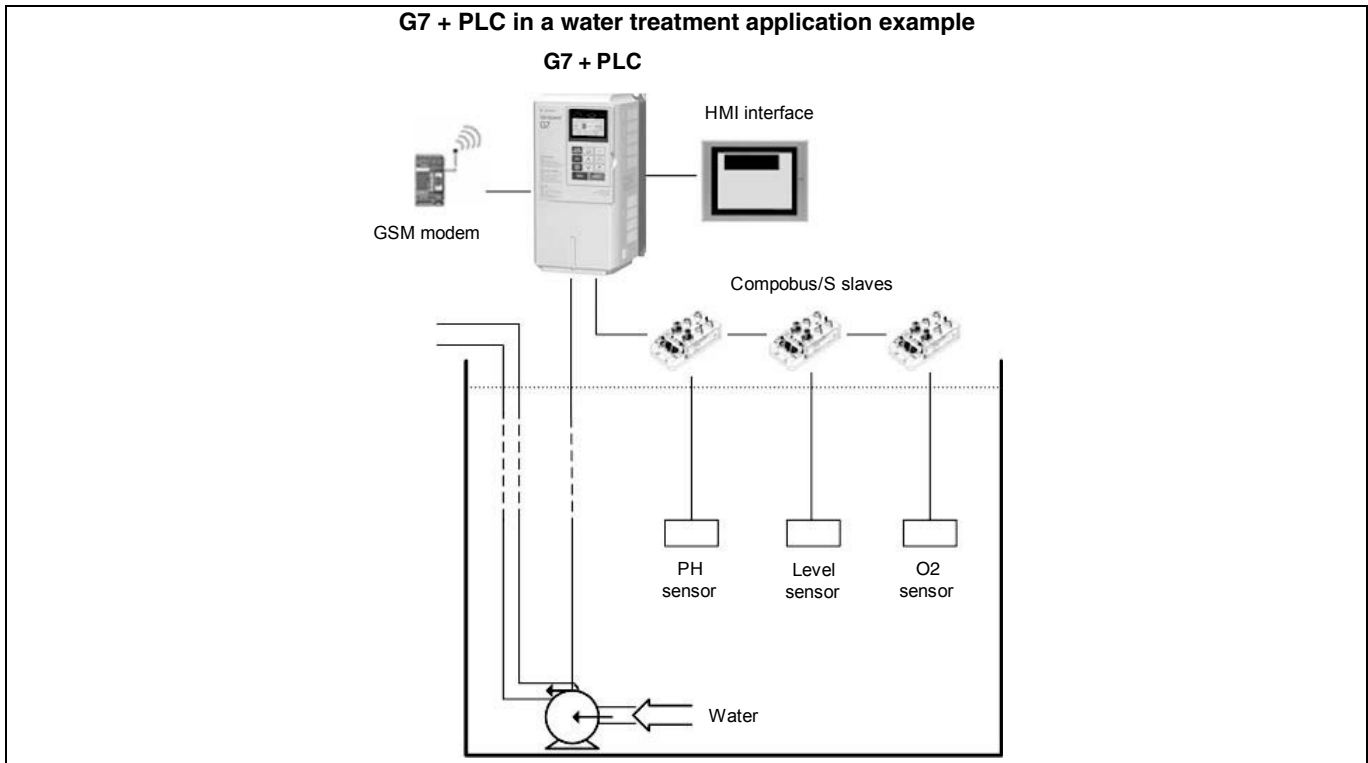

Note: For detailed information about the inverter, please see the Varispeed G7 series section.

F7 + PLC

The F7 drive is a flux vector control inverter. It is intended to handle every conventional drive application found in a typical industrial manufacturing plant from simple variable torque pumping to sophisticated networked material handling. By combining with PLC option board, is ideal solution winding/unwinding applications, handling/ transfer/ palletizer point-to-point positioning applications, food processing, packaging, printing, and textile machines for example .

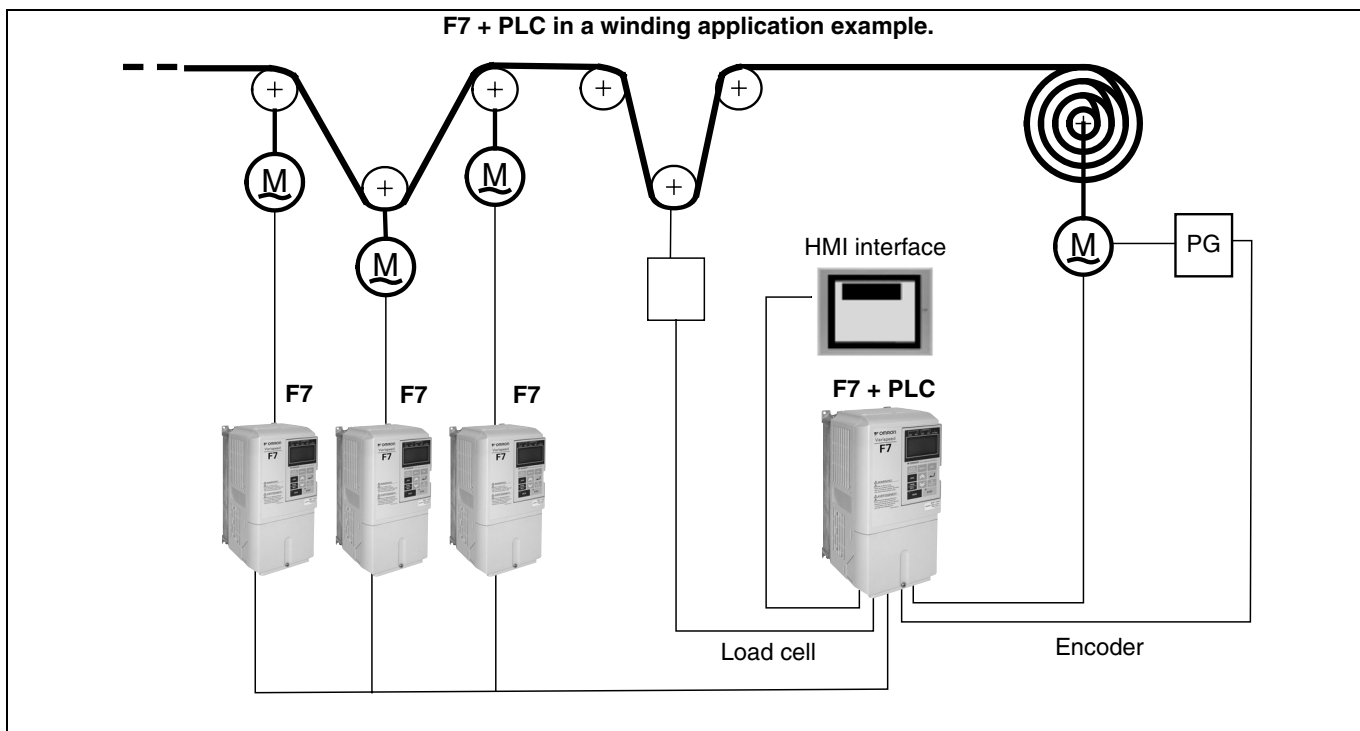

Note: For detailed information about the inverter, please see into the Varispeed F7 series section.

E7 + PLC

Varispeed E7 is the OMRON Yaskawa solution for energy saving applications The E7 is designed for variable torque applications such as fans and centrifugal pumps. By combining with PLC option board, it is the ideal solution for water treatment, pump sequencing, building automation and fan applications for example...

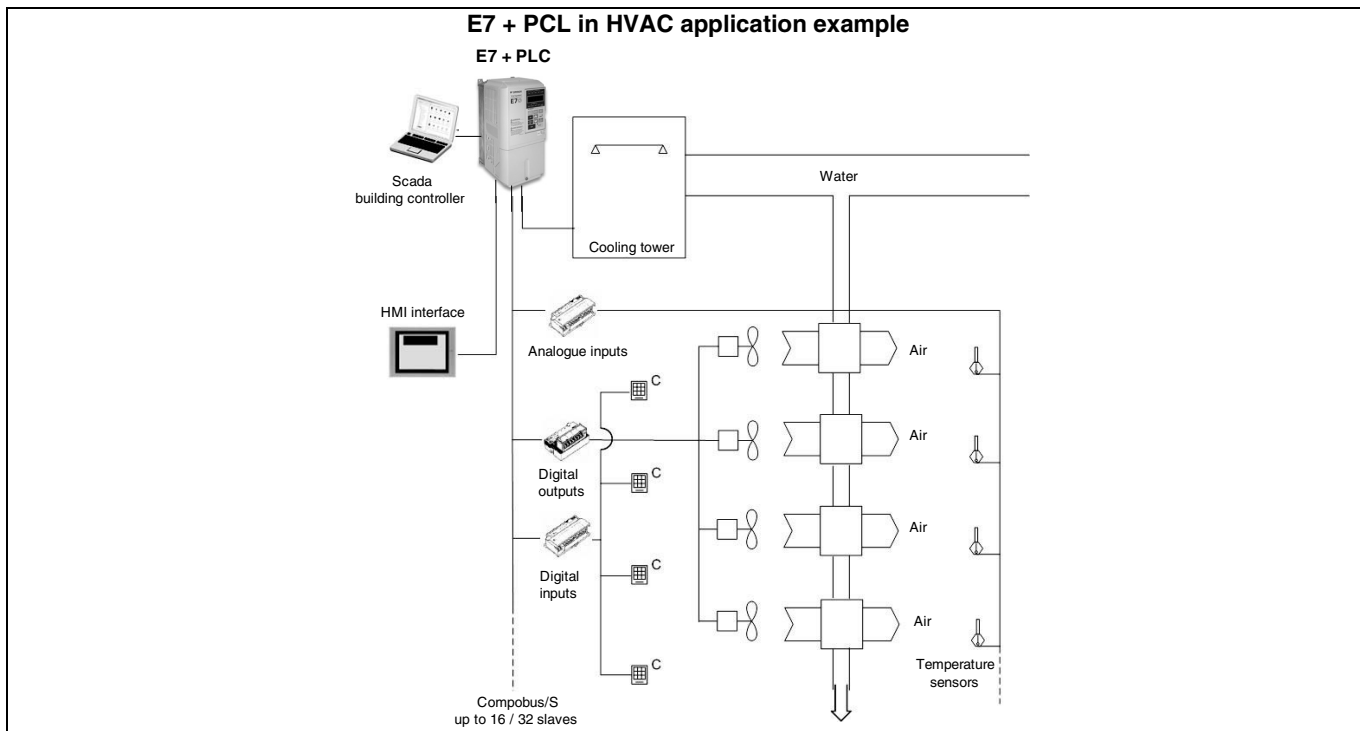

Note: For detailed information about the inverter, please see into the Varispeed E7 series section.

L7 + PLC

The L7 is the ultimate drive for lift applications up to 3m/s. High starting torque, silent operation, lift-specific operator interface and operation with both AC and PM motors are standard features of the L7 inverter. By combining with PLC option board, it is the ideal solution for controlling distributed I/O's, lift cabin HMI, GSM modem to send alarms for example..

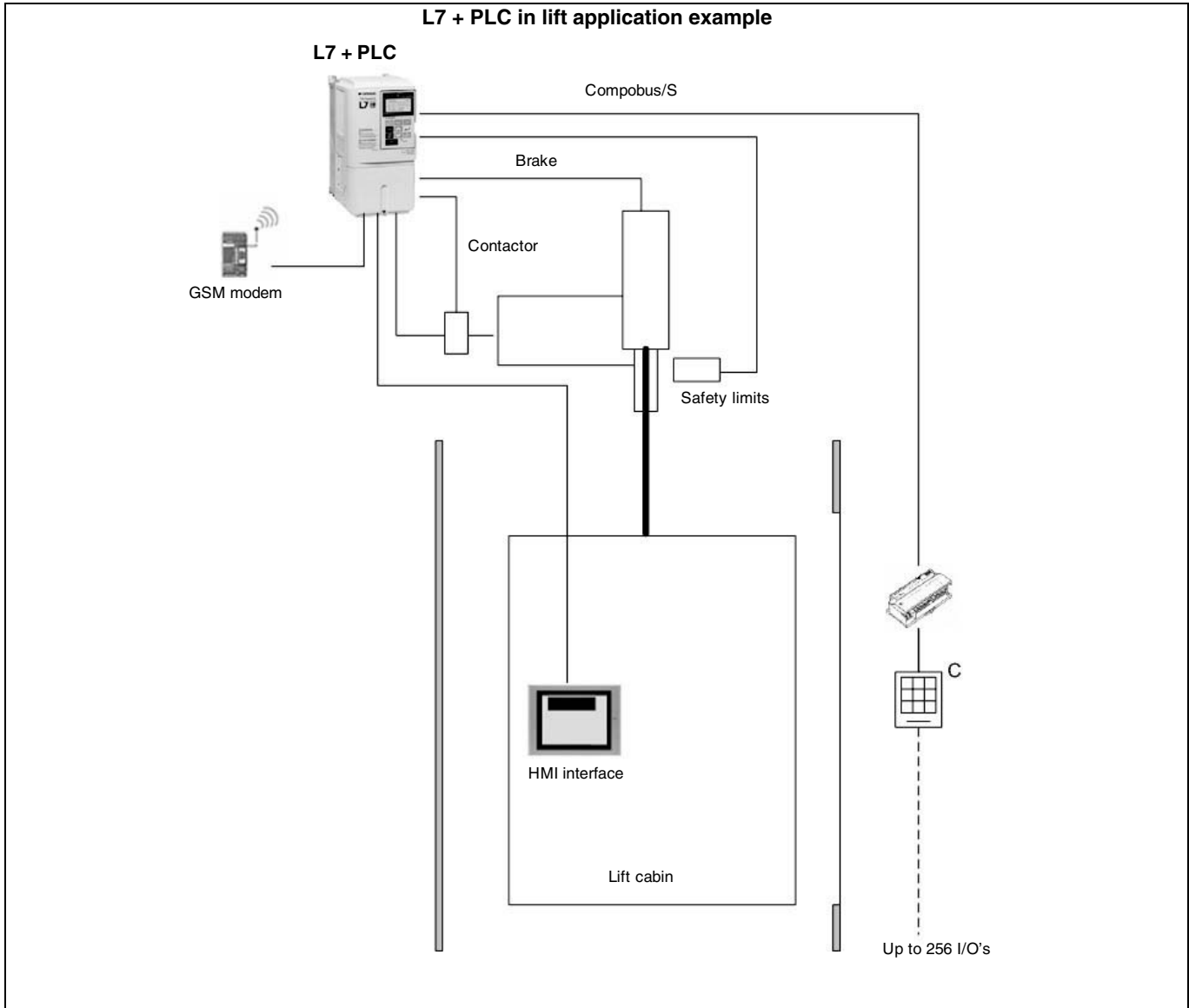

Note: For detailed information about the inverter, please see into the Varispeed L7 series section.

Ordering information

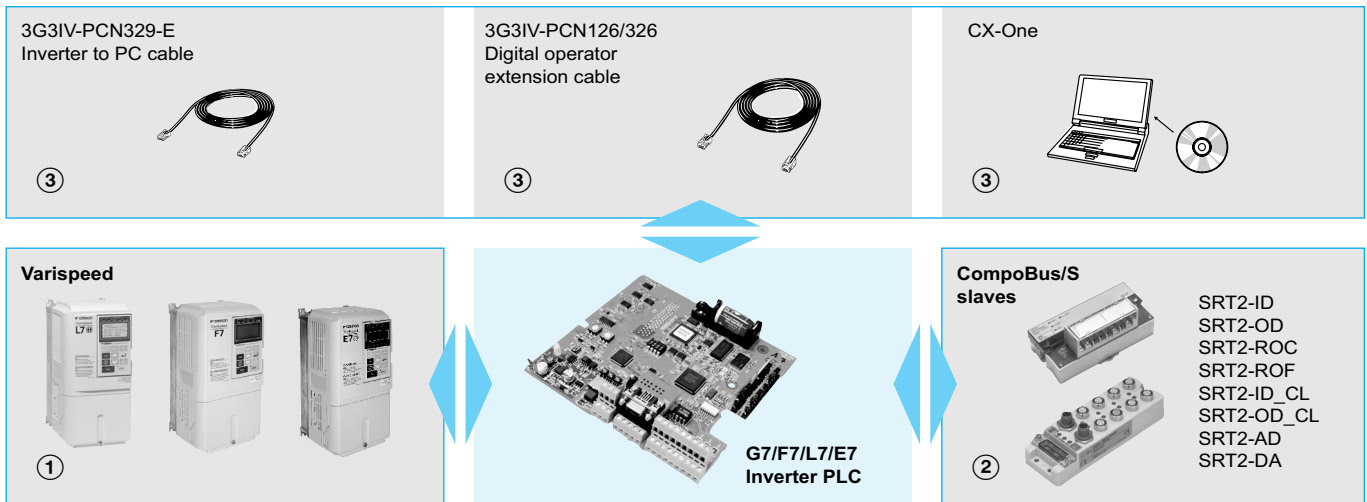

G7/F7/L7/E7 inverter PLC

Specifications						Model
Inputs	Ouputs	RTC	Compobus/S master	RS422 port	DeviceNet slave	
6	4	Yes	Yes	Yes	No	3G3RV-P10ST8-E
6	4	Yes	Yes	NO	Yes	3G3RV-P10ST8-DRT-E

① **Varispeed**

Specifications	Model
The 3-Level control method inverter	Varispeed G7
Flux vector control inverter	Varispeed F7
The lift inverter	Varispeed L7
The pumps and fans inverter	Varispeed E7

Note: For detailed information please refer to Varispeed G7/F7/L7/E7 series section.



② **Cables**

Specifications	Model
Computer connecting cable	CS1W-CN226
Programmable console cable	CS1W-CN224

② **Computer software**

Specifications	Model
PLC programming software: CX-programmer	CX-One
Inverter configurator software: CX-drive	

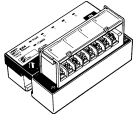
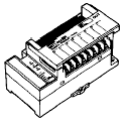
③ Compobus/S slaves

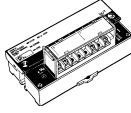
Product	Appearance	Specifications	Model
Digital I/O terminals		4 NPN inputs (+ common) 4 PNP inputs (- common) 4 NPN outputs (- common) 4 PNP outputs (+ common)	SRT2-ID04 SRT2-ID04-1 SRT2-OD04 SRT2-OD04-1
		8 NPN inputs (+ common) 8 PNP inputs (- common) 8 NPN outputs (- common) 8 PNP outputs (+ common)	SRT2-ID08 SRT2-ID08-1 SRT2-OD08 SRT2-OD08-1
		16 NPN inputs (+ common) 16 PNP inputs (- common) 16 NPN outputs (- common) 16 PNP outputs (+ common)	SRT2-ID16 SRT2-ID16-1 SRT2-OD16 SRT2-OD16-1
Relay output terminals		8 Relay outputs 8 Power MOS FET relay outputs	SRT2-ROC08 SRT2-ROF08
		16 Relay outputs 16 Power MOS FET relay outputs	SRT2-ROC16 SRT2-ROF16
Waterproof terminals		4 NPN inputs (+ common) 4 PNP inputs (- common) 4 NPN outputs (- common) 4 PNP outputs (+ common)	SRT2-ID04CL SRT2-ID04CL-1 SRT2-OD04CL SRT2-OD04CL-1
		8 NPN inputs (+ common) 8 PNP inputs (- common) 8 NPN outputs (- common) 8 PNP outputs (+ common)	SRT2-ID08CL SRT2-ID08CL-1 SRT2-OD08CL SRT2-OD08CL-1
Analog input terminal		1 to 4 inputs (set with DIP switch)	SRT2-AD04
Analog output terminal		1 or 2 outputs (set with DIP switch)	SRT2-DA02

Note: For detailed information about Compobus/S slaves, please refer to catalogue No. Y201-EN2-02 AS.

ALL DIMENSIONS SHOWN ARE IN MILLIMETERS.
To convert millimeters into inches, multiply by 0.03937. To convert grams into ounces, multiply by 0.03527.