



**COMSPHERE  
3900 SERIES MODEMS  
MODELS 3910 AND 3911  
POINT-TO-POINT/MULTIPOINT  
INSTALLATION AND OPERATION MANUAL**

Document No. 3910-A2-GN32-30

November 1996



## COMSPHERE 3900 Series Modems Models 3910 and 3911 Point-to-Point/Multipoint

Installation and Operation Manual  
3910-A2-GN32-30

4th Edition (November 1996)

Changes and enhancements to the product and to the information herein will be documented and issued as a new release to this manual.

For the 3900 Series standalone modems, the Universal Service Order Code (USOC) for Permissive mode is RJ11C. The Canadian equivalent to RJ11C is CA11A. For 3900 Series carrier-mounted modems, the USOC for Permissive mode is RJ21X. The Canadian equivalent to RJ21X is CA21A.

FCC Registration number: See label on modem  
Ringer Equivalence number (REN): See label on modem

### **Model 3910**

Canadian Certification number: See label on modem  
Canadian DOC Load number: See label on modem

### **Model 3911**

Canadian Certification number: See label on modem  
Canadian DOC Load number: See label on modem

## Warranty, Sales, and Service Information

Contact your sales or service representative directly for any help needed. For additional information concerning warranty, sales, service, repair, installation, documentation, or training, use one of the following methods:

- **Via the Internet:** Visit the Paradyne World Wide Web site at <http://www.paradyne.com>
- **Via Telephone:** Call our automated call system to receive current information via fax or to speak with a company representative.
  - Within the U.S.A., call 1-800-870-2221
  - International, call 813-530-2340

## Trademarks

All products and services mentioned herein are the trademarks, service marks, registered trademarks or registered service marks of their respective owners.



Printed on recycled paper

## COPYRIGHT © 1996 Paradyne Corporation. All rights reserved.

*This publication is protected by federal copyright law. No part of this publication may be copied or distributed, transmitted, transcribed, stored in a retrieval system, or translated into any human or computer language in any form or by any means, electronic, mechanical, magnetic, manual or otherwise, or disclosed to third parties without the express written permission of Paradyne Corporation, 8545 126th Avenue North, P.O. Box 2826, Largo, Florida 33779-2826.*

*Paradyne Corporation makes no representation or warranties with respect to the contents hereof and specifically disclaims any implied warranties of merchantability or fitness for a particular purpose. Further, Paradyne Corporation reserves the right to revise this publication and to make changes from time to time in the contents hereof without obligation of Paradyne Corporation to notify any person of such revision or changes.*

## Important Safety Instructions

1. Read and follow all warning notices and instructions marked on the product or included in the manual.
2. This product is intended to be used with a three-wire grounding type plug – a plug which has a grounding pin. This is a safety feature. Equipment grounding is vital to ensure safe operation. Do not defeat the purpose of the grounding type plug by modifying the plug or using an adaptor.

Prior to installation, use an outlet tester or a voltmeter to check the ac receptacle for the presence of earth ground. If the receptacle is not properly grounded, the installation must not continue until a qualified electrician has corrected the problem.

If a three-wire grounding type power source is not available, consult a qualified electrician to determine another method of grounding the equipment.

3. Slots and openings in the cabinet are provided for ventilation. To ensure reliable operation of the product and to protect it from overheating, these slots and openings must not be blocked or covered.
4. Do not allow anything to rest on the power cord and do not locate the product where persons will walk on the power cord.
5. Do not attempt to service this product yourself, as opening or removing covers may expose you to dangerous high voltage points or other risks. Refer all servicing to qualified service personnel.
6. General purpose cables are provided with this product. Special cables, which may be required by the regulatory inspection authority for the installation site, are the responsibility of the customer.
7. When installed in the final configuration, the product must comply with the applicable Safety Standards and regulatory requirements of the country in which it is installed. If necessary, consult with the appropriate regulatory agencies and inspection authorities to ensure compliance.
8. A rare phenomenon can create a voltage potential between the earth grounds of two or more buildings. If products installed in separate buildings are **interconnected**, the voltage potential may cause a hazardous condition. Consult a qualified electrical consultant to determine whether or not this phenomenon exists and, if necessary, implement corrective action prior to interconnecting the products.

In addition, if the equipment is to be used with telecommunications circuits, take the following precautions:

- Never install telephone wiring during a lightning storm.
- Never install telephone jacks in wet locations unless the jack is specifically designed for wet locations.
- Never touch uninsulated telephone wires or terminals unless the telephone line has been disconnected at the network interface.
- Use caution when installing or modifying telephone lines.
- Avoid using a telephone (other than a cordless type) during an electrical storm. There may be a remote risk of electric shock from lightning.
- Do not use the telephone to report a gas leak in the vicinity of the leak.

## Notices

### **WARNING**

THIS EQUIPMENT HAS BEEN TESTED AND FOUND TO COMPLY WITH THE LIMITS FOR A CLASS A DIGITAL DEVICE, PURSUANT TO PART 15 OF THE FCC RULES. THESE LIMITS ARE DESIGNED TO PROVIDE REASONABLE PROTECTION AGAINST HARMFUL INTERFERENCE WHEN THE EQUIPMENT IS OPERATED IN A COMMERCIAL ENVIRONMENT. THIS EQUIPMENT GENERATES, USES, AND CAN RADIATE RADIO FREQUENCY ENERGY AND, IF NOT INSTALLED AND USED IN ACCORDANCE WITH THE INSTRUCTION MANUAL, MAY CAUSE HARMFUL INTERFERENCE TO RADIO COMMUNICATIONS. OPERATION OF THIS EQUIPMENT IN A RESIDENTIAL AREA IS LIKELY TO CAUSE HARMFUL INTERFERENCE IN WHICH CASE THE USER WILL BE REQUIRED TO CORRECT THE INTERFERENCE AT HIS OWN EXPENSE.

THE AUTHORITY TO OPERATE THIS EQUIPMENT IS CONDITIONED BY THE REQUIREMENTS THAT NO MODIFICATIONS WILL BE MADE TO THE EQUIPMENT UNLESS THE CHANGES OR MODIFICATIONS ARE EXPRESSLY APPROVED BY PARADYNE.

### **WARNING**

TO USERS OF DIGITAL APPARATUS IN CANADA:

THE DIGITAL APPARATUS DOES NOT EXCEED THE CLASS A LIMITS FOR RADIO NOISE EMISSIONS FROM DIGITAL APPARATUS SET OUT IN THE RADIO INTERFERENCE REGULATIONS OF THE CANADIAN DEPARTMENT OF COMMUNICATIONS.

LE PRÉSENT APPAREIL NUMÉRIQUE N'ÉMET PAS DE BRUITS RADIOÉLECTRIQUES DÉPASSANT LES LIMITES APPLICABLES AUX APPAREILS NUMÉRIQUES DE LA CLASSE A PRESCRITES DANS LE RÈGLEMENT SUR LE BROUILLAGE RADIOÉLECTRIQUE ÉDICTÉ PAR LE MINISTÈRE DES COMMUNICATIONS DU CANADA.

---

# Table of Contents

## Preface

Objectives and Reader Assumptions .....	vii
How to Use this Manual .....	vii
Related Documents .....	viii
Ordering Information .....	viii

## 1. Introduction

Overview .....	1-1
Features .....	1-1
Multipoint Applications .....	1-2
Leased Backup Applications .....	1-2
COMSPHERE 391x Series Models .....	1-2
Government Requirements and Equipment Return .....	1-5
Technical Specifications .....	1-8

## 2. Modem Installation

Overview .....	2-1
391x Series Modem Package .....	2-1
Model 3910 Modem Installation .....	2-2
DTE Connection .....	2-4
Model 3910 4-Wire/2-Wire Leased-Line Connection .....	2-4
Dial Network Connection .....	2-4
Model 3910 Dial Backup Connection .....	2-4
Model 3910 Leased Backup Connection .....	2-4
Network Management System Connection .....	2-5
Power Supply Connection .....	2-5
Modem Power-Up .....	2-5
Selecting Factory Configuration Options .....	2-6
Removing and Replacing Model 3910 Modems .....	2-9
Model 3911 Modem Installation .....	2-9
Removing and Replacing Model 3911 Modems .....	2-12

### 3. DCP Operation

Overview .....	3-2
Diagnostic Control Panels .....	3-2
Status Indicators .....	3-4
Diagnostic Control Panel Operation .....	3-6
Menu Structure .....	3-8
Status Branch .....	3-15
Configure Branch .....	3-25
Poll List Branch .....	3-25
Control Branch .....	3-30
Test Branch .....	3-46
Sub-Network Health and Status Branch .....	3-53
Call Setup Branch .....	3-54
Talk/Data Branch .....	3-62
Security Branch .....	3-64
Remote Branch .....	3-65

### 4. DCP Configuration

Overview .....	4-1
Configure Branch .....	4-4
Configuration Tables .....	4-9

### 5. AT Command Set and S-Registers

Overview .....	5-1
Operating Modes .....	5-1
Command Guidelines .....	5-2
AT Command List .....	5-4
S-Register List .....	5-14

### 6. Dial Access Security

Overview .....	6-1
Security Branch .....	6-4
Security Configuration Options .....	6-13
Security Password Entry Techniques .....	6-16
Database Table Examples .....	6-18

---

## Appendices

A.	Menu Tree .....	A-1
B.	Troubleshooting .....	B-1
C.	Pin Assignments .....	C-1
D.	CCITT V.25bis Dialing Commands and Response .....	D-1
E.	ASCII Character Table .....	E-1
F.	Default Configuration Options .....	F-1
G.	Sample Configuration .....	G-1
H.	Equipment List .....	H-1

## Glossary

## Index

# List of Figures

Figure	Page
1-1 Model 3910 .....	1-3
1-2 Model 3911 .....	1-4
2-1 Model 3910 Rear Panel and Power Supply .....	2-3
2-2 Installing a Model 3911 Modem .....	2-10
2-3 Circuit Pack Lock .....	2-11
3-1 Model 3910 DCP .....	3-3
3-2 Optional SDCP, Model 3911 Faceplate, and Optional SDU .....	3-4
3-3 391x Series LCD and Keypad .....	3-6
3-4 Local Analog Loopback .....	3-48
3-5 Remote Digital Loopback .....	3-49
3-6 Local Digital Loopback .....	3-50
3-7 Pattern Test and Local Analog Loopback Test .....	3-51
3-8 Pattern Test and Digital Loopback Test .....	3-52
3-9 End-to-End Pattern Test .....	3-52
3-10 Dial Backup .....	3-58
4-1 DCP Configuration Process .....	4-2
4-2 AT Command Configuration Process .....	4-3
C-1 VF Pin Orientation .....	C-3
C-2 Wiring Diagram — “Y” Cable for External Telephone .....	C-4
C-3 Wiring Diagram — 8-Position to 6-Position Crossover Cable .....	C-5
C-4 Wiring Diagram — 25-Pin Crossover Cable .....	C-6
G-1 Sample Configuration — Point-to-Point .....	G-2
G-2 Sample Configuration — Multipoint .....	G-3
G-3 Sample Configuration — Point-to-Point with Automatic Dial Backup .....	G-4
G-4 Sample Configuration — Point-to-Point with Network Management .....	G-5
G-5 Sample Configuration — Carrier with Network Management .....	G-6
G-6 Sample Configuration — Extended Multipoint .....	G-7
G-7 Sample Configuration — Extended Diagnostics .....	G-9



# List of Tables

Table	Page	
1-1	Technical Specifications for 391x Series Modems . . . . .	1-8
3-1	Model 3910 and Model 3911 DCP LEDs . . . . .	3-5
3-1	SDCP LEDs . . . . .	3-6
3-3	Top-Level Menu Status . . . . .	3-9
3-4	Common Operational Messages . . . . .	3-12
3-5	Dial Access Security Messages . . . . .	3-13
3-6	Health and Status Messages . . . . .	3-17
3-7	Backup Status Screens . . . . .	3-23
3-8	Valid Ranges for VF Thresholds . . . . .	3-45
3-9	Valid Dial Command Modifiers . . . . .	3-61
4-1	DTE Interface Configuration Options . . . . .	4-10
4-2	DTE Dialer Configuration Options . . . . .	4-20
4-3	Line Dialer Configuration Options . . . . .	4-25
4-4	Dial Line Configuration Options . . . . .	4-30
4-5	Leased Line Configuration Options . . . . .	4-33
4-6	V.42/MNP/Buffer Configuration Options . . . . .	4-39
4-7	Test Configuration Options . . . . .	4-46
4-8	Miscellaneous Configuration Options . . . . .	4-48
5-1	Result Codes . . . . .	5-3
5-2	391x Series AT Commands . . . . .	5-5
5-3	391x Series S-Registers . . . . .	5-15
6-1	Edit Password Table Group Options . . . . .	6-8
6-2	Set Answer Security Group Options . . . . .	6-10
6-3	Set Originate Security Group Options . . . . .	6-11
6-4	Security Configuration Options . . . . .	6-14
6-5	Security Database Table Using VF-Side Passwords . . . . .	6-18
6-6	Security Database Table Using DTE-Side Passwords . . . . .	6-18
6-7	Security Database Table Using Both VF-Side and DTE-Side Passwords . . . . .	6-19
B-1	Modem Health . . . . .	B-1
B-2	Leased-Line Operation . . . . .	B-2
B-3	Dial Backup Operation . . . . .	B-2
B-4	Modem — DTE Connection . . . . .	B-3
B-5	Modem — VF Connection . . . . .	B-4
B-6	Online Operation . . . . .	B-5
C-1	EIA-232-D Pin Assignments . . . . .	C-2
C-2	VF Connector Pin Assignments . . . . .	C-3
D-1	V.25bis Commands . . . . .	D-7

<b>Table</b>		<b>Page</b>
D-2	V.25bis Response Messages .....	D-8
E-1	ASCII Characters .....	E-1
F-1	Factory Default Configuration Options .....	F-2

---

# Preface

## Objectives and Reader Assumptions

This manual describes how to install and operate the COMSPHERE® 391x Series standalone and carrier-mounted modems. This manual assumes that you have a basic understanding of modems and their operation.

## How to Use this Manual

Chapter 1 provides technical specifications, information about the 391x Series modems' features, and the government requirements for using these modems.

Chapter 2 provides instructions for installing the 391x Series modems.

Chapter 3 provides the information required to operate the Model 3910 using the diagnostic control panel and the Model 3911 using the COMSPHERE 3000 Series Carrier's shared diagnostic control panel (SDCP).

Chapter 4 provides the information required to set configuration options in the 391x Series modems using the modem's diagnostic control panel.

Chapter 5 provides instructions for displaying and changing AT commands and S-Registers.

Chapter 6 provides instructions for using the Dial Access Security feature.

Appendix A provides a menu tree for the 391x Series modems.

Appendix B provides instructions for performing diagnostic tests when data communication problems occur.

Appendix C provides EIA-232-D and VF TELCO pin assignments.

Appendix D provides V.25bis dialing information.

Appendix E provides an ASCII translation chart.

Appendix F provides a list of all default configuration options available for the factory preset configurations.

Appendix G provides diagrams of sample configurations for the 391x Series modems.

Appendix H provides an equipment list for the 391x Series modems.

The Glossary provides a description of terms used throughout this manual.

## Related Documents

3000-A2-GA31	<i>COMSPHERE 3000 Series Carrier, Installation Manual</i>
3610-A2-GZ45	<i>3600 Hubbing Device Feature Number 3600-F3-300, Installation Instructions</i>
3910-A2-GK41	<i>COMSPHERE 3900 Series Modems, Models 3910 and 3911, Installation Instructions</i>

Call your sales representative to order additional product documentation.

---

# Introduction 1

Overview .....	1-1
Features .....	1-1
Multipoint Applications .....	1-2
Leased Backup Applications .....	1-2
COMSPHERE 391x Series Models .....	1-2
Standalone Model 3910 4-Wire/2-Wire Modem .....	1-3
Carrier-Mounted Model 3911 4-Wire/2-Wire Modem .....	1-4
Government Requirements and Equipment Return .....	1-5
United States .....	1-5
Canada .....	1-7
Technical Specifications .....	1-8

## Overview

The COMSPHERE 391x Series modems, a new generation of full-feature, high-speed modems, offer reliable asynchronous and synchronous operation over leased-line or dial networks. The 391x Series modems' unique software defineability allows for the addition of future enhancements, whether it is installing new features or firmware upgrades.

The modem's compatibility with a number of dialing methods and protocols, such as asynchronous AT commands, CCITT V.25bis dialing, and the user-friendly diagnostic control panel (DCP), permits the 391x Series modem to be used in a variety of applications and environments while also allowing control over modem configuration, dialing, and diagnostics. The 391x Series modems offer preset factory configurations containing the most often used modem settings.

## Features

The 391x Series modems have a wide variety of features.

- Four-wire/two-wire point-to-point or four-wire multipoint operation.
- Four-wire/two-wire leased-line modulations: V.32 terbo (19200 and 16800 bps), V.32bis (14400, 12000, 9600, 7200, and 4800 bps), V.32 (9600 and 4800 bps), Paradyne Point-to-Point Diagnostic (1200, 2400 bps), Trellis Multipoint (19200, 14400, 9600, 7200, 4800, and 2400 bps), V.22bis (2400 bps), V.27bis (4800 and 2400 bps), V.33 (14400 and 12000 bps), and V.29 (9600, 7200, and 4800 bps).
- Dial-line modulations: V.32 terbo (19200 and 16800 bps), V.32bis (14400, 12000, 9600, 7200, and 4800 bps), V.32 (9600 and 4800 bps), Paradyne Point-to-Point Diagnostic (1200, 2400 bps), V.22bis (2400 bps), V.22 (1200 bps), V.23 (1200 and 600 bps), V.21 (300 bps), Bell 212A (1200 bps), and Bell 103J (300 bps).
- Channel adaptive Trellis-Coded Modulation, Paradyne's advanced Trellis-Coded transparent forward error correction for Trellis multipoint and high-speed point-to-point applications.

- Mixed inbound rates for multipoint applications.
- Convenient migration to new or optional features through software downloading.
- Extended data circuits with diagnostics.
- Network management system (NMS) support through the COMSPHERE 6800 or 6700 Series NMS using Advanced Diagnostic protocol (ADp).
- Complement of self-tests, local and remote loopbacks.
- CCITT V.42bis and MNP Class 5 data compression.
- Virtual error free data integrity with CCITT V.42 and MNP Level 4 error control.
- Dial access security.
- Automatic and manual backup with standby capabilities for 4-wire/2-wire leased-line applications. (The backup facility may be either a 2-wire dial line or a 2-wire leased line.)

## Multipoint Applications

In multipoint applications, leased-line circuits are used for time sharing the same front-end processor (FEP) port with multiple remote locations. The FEP (via the control modem) regulates traffic on the line by continuously polling the tributary DTE(s) in a predefined sequence. Only one tributary can communicate with the control modem at a given time. Modems configured for Trellis Multipoint (TMp) cannot be used in a point-to-point, constant carrier application. (Refer to the *Leased Line* section in Chapter 4 for configuration options.)

## Leased Backup Applications

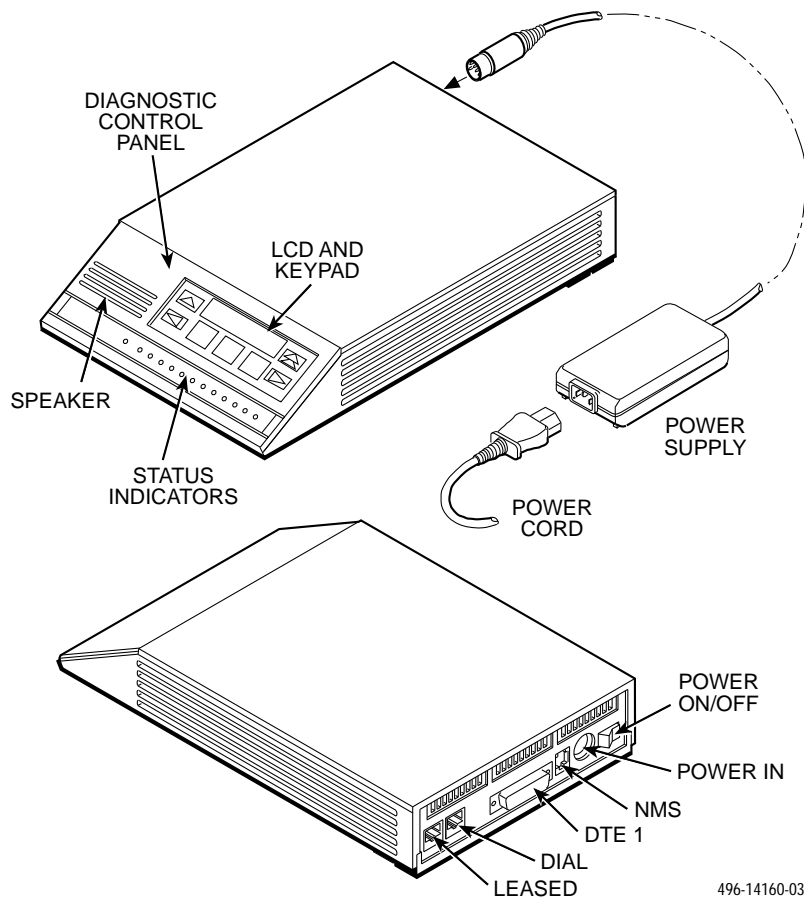
In leased backup applications, a 2-wire leased line is used as the backup facility instead of the normal 2-wire dial line. Plug the leased line into the jack labeled DIAL on the rear panel of the modem (see Figure 2-1 in Chapter 2), and enable the Dual\_Leased\_Ln configuration option. (Refer to the *Leased Line* section in Chapter 4 for configuration options.) Except for dialing, ring indication, and call progression functions, you control the backup function as if it were a normal dial backup.

## COMSPHERE 391x Series Models

The 391x Series family is available in two models: the Model 3910, a 4-wire/2-wire standalone modem, and the Model 3911, a carrier-mounted version of the standalone unit. Both models offer a variety of modulation schemes and network enhancements while still providing reliable, high-speed data transmission using the latest in modem technology.

## Standalone Model 3910 4-Wire/2-Wire Modem

The standalone Model 3910 modem (Figure 1-1) is capable of either 4-wire/2-wire leased-line or dial operation. The modem is controlled using either AT commands or the diagnostic control panel (DCP). The DCP consists of a liquid crystal display (LCD), three function keys, four directional keys, and a row of 13 LED status indicators. For a better understanding of DCP operation, refer to Chapter 3, *DCP Operation*.



**Figure 1-1. Model 3910**

The rear of the modem contains an ON/OFF power switch, a low voltage dc power connector, an 8-pin modular connector (LEASED) for leased-line connection, an 8-pin modular connector (DIAL) for dial-line or leased-line backup, a 4-pin modular connector (NMS) for network management, and a DB-25-S DTE connector.

## Carrier-Mounted Model 3911 4-Wire/2-Wire Modem

The carrier-mounted Model 3911 modem (Figure 1-2) is capable of either 4-wire/2-wire leased-line or dial operation and installs into a COMSPHERE 3000 Series Carrier. The

Model 3911's faceplate has 16 LED status indicators for displaying modem activity and an audio speaker jack for the carrier's optional speaker.

The Model 3911 modem's rear has two edge card connectors that mount into a connector plate located on the rear of the carrier. This connector plate has two DB-25-S connectors, one providing an EIA-232-D DTE interface and one for future functionality.

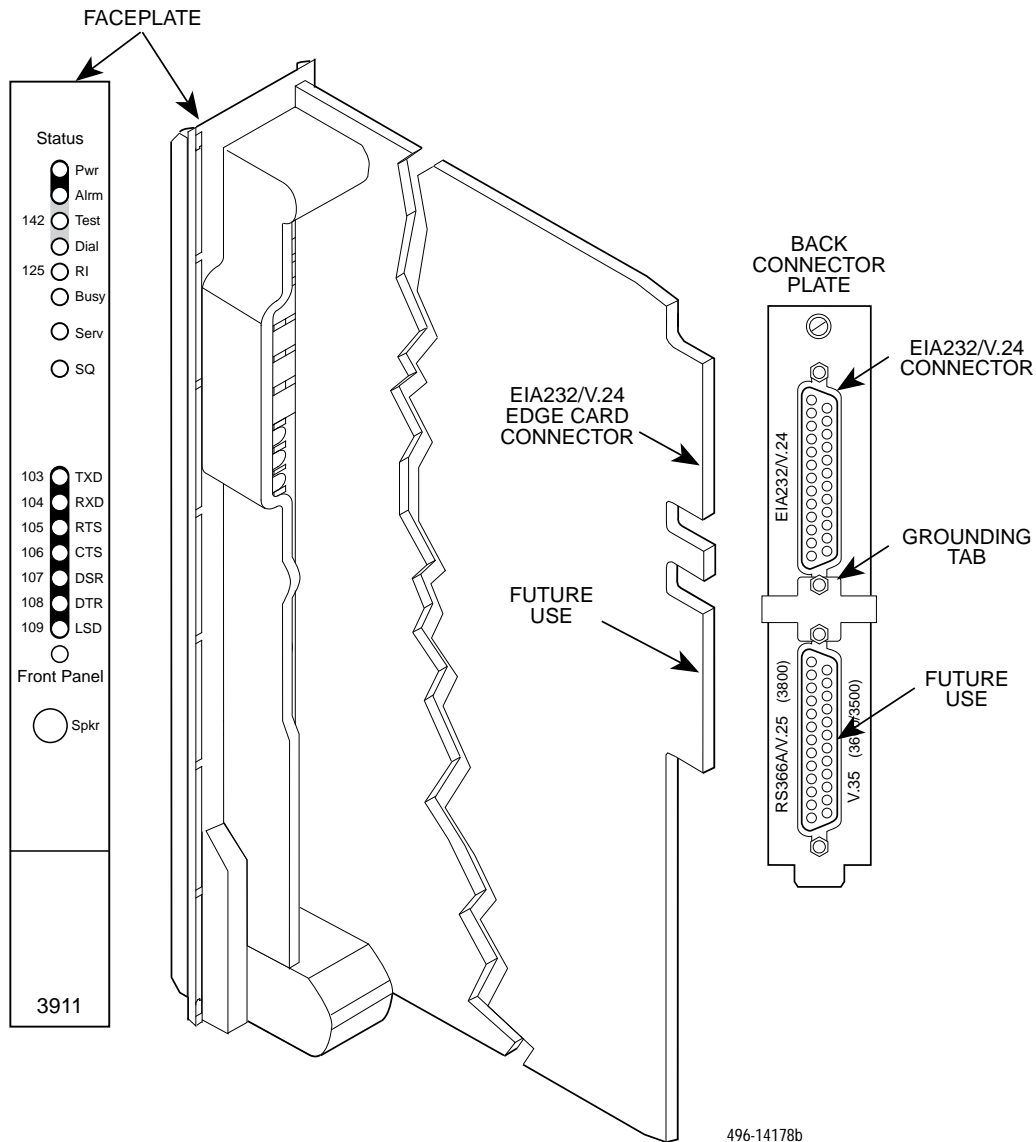


Figure 1-2. Model 3911

The Model 3911 derives ac power from the COMSPHERE 3000 Series Carrier's backplane, which is a common bus to all devices installed in the carrier. The user interface to any Model 3911 is through the shared diagnostic control panel (SDCP), an optional feature which operates in a



manner similar to the DCP on the Model 3910. For a better understanding of DCP operation, refer to Chapter 3, *DCP Operation*.

The COMSPHERE 3000 Series Carrier has a total of 17 slots. The first slot, Slot 0, is reserved for the shared diagnostic unit (SDU) while the remaining 16 slots can house up to 16 Model 3911 modems, or a combination of Model 3911 modems and other units. For more details on the COMSPHERE 3000 Series Carrier, refer to the *COMSPHERE 3000 Series Carrier, Installation Manual*.

## Government Requirements and Equipment Return

Certain governments require that instructions pertaining to modem connection to the public switched telephone network be included in the installation and operation manual. Specific instructions are listed in the following sections.

### United States

#### NOTICE TO USERS OF THE PUBLIC SWITCHED TELEPHONE NETWORK

1. This equipment complies with Part 68 of the FCC rules. On the equipment is a label that contains, among other information, the FCC registration number and ringer equivalence number (REN) for this equipment. The label is located on the bottom of the Model 3910 modem. This label is located on the Model 3911's circuit card assembly. If requested, this information must be provided to the telephone company.
2. Page A of this manual contains the Universal Service Order Codes (USOC) associated with the services on which the equipment is to be connected.
3. An FCC compliant telephone cord and modular plug is provided with this equipment. This equipment is designed to be connected to the telephone network or premises wiring using a compatible modular jack which is Part 68 compliant. See Installation Instructions for details.
4. The ringer equivalence (REN) is used to determine the quantity of devices which may be connected to the telephone line. Excessive RENs on the telephone line may result in the devices not ringing in response to an incoming call. In most, but not all areas, the sum of the RENs should not exceed five (5.0). To be certain of the number of devices that may be connected to the line, as determined by the total RENs, contact the telephone company to determine the maximum RENs for the calling area.
5. If the 391x Series modem causes harm to the telephone network, the telephone company will notify you in advance that temporary discontinuance of service may be required. But if advance notice is not practical, the telephone company will notify the customer as soon as possible. Also, you will be advised of your right to file a complaint with the FCC if you believe it is necessary.
6. The telephone company may make changes in its facilities, equipment, operations, or procedures that could affect the operation of the equipment. If this happens, the telephone company will provide advance notice in order for you to make the necessary modifications in order to maintain uninterrupted service.

7. If you experience trouble with this equipment, please contact your sales or service representative (as appropriate) for repair or warranty information. If the product needs to be returned to the company service center for repair, contact them directly for return instructions using one of the following methods:
  - **Via the Internet:** Visit the Paradyne World Wide Web site at <http://www.paradyne.com>
  - **Via Telephone:** Call our automated call system to receive current information via fax or to speak with a company representative.
    - Within the U.S.A., call 1-800-870-2221
    - International, call 813-530-2340

If the trouble is causing harm to the telephone network, the telephone company may request that you remove the equipment from the network until the problem is resolved.
8. The user is not authorized to repair or modify the equipment.
9. This equipment cannot be used on public coin service provided by the telephone company. Connection to Party Line Service is subject to state tariffs. (Contact the state public utility commission, public service commission or corporation commission for information.)

## Canada

### NOTICE TO THE USERS OF THE CANADIAN PUBLIC SWITCHED TELEPHONE NETWORK

The Canadian Department of Communications label identifies certified equipment. This certification means that the equipment meets certain telecommunications network protective, operational and safety requirements. The Department does not guarantee the equipment will operate to the user's satisfaction.

Before installing this equipment, users should ensure that it is permissible to be connected to the facilities of the local telecommunications company. The equipment must also be installed using an acceptable method of connection. In some cases, the company's inside wiring associated with a single line individual service may be extended by means of a certified connector assembly (telephone extension cord). The customer should be aware that compliance with the above conditions may not prevent degradation of service in some situations.

Repairs to certified equipment should be made by an authorized Canadian maintenance facility designated by the supplier. Any repairs or alterations made by the user to this equipment, or equipment malfunctions, may give the telecommunications company cause to request the user to disconnect the equipment.

Users should ensure for their own protection that the electrical ground connections of the power utility, telephone line and internal metallic water pipe system, if present, are connected together. This precaution may be particularly important in rural areas.

#### CAUTION

**Users should not attempt to make such connections themselves, but should contact the appropriate electric inspection authority, or electrician, as appropriate.**

The Load Number is labeled on the equipment. The Load Number (LN) assigned to each terminal device denotes the percentage of the total load to be connected to a telephone loop which is used by the device to prevent overloading. The termination on a loop may consist of any combination of devices subject only to the requirement that the total of the Load Numbers of all devices does not exceed 100.

**If your equipment is in need of repair**, refer to the procedure in the *Government Requirements and Equipment Return* section earlier in this chapter.

## Technical Specifications

Table 1-1 shows the technical specifications for the 391x Series modems.

**Table 1-1  
(1 of 3)  
Technical Specifications for 391x Series Modems**

Specifications	Description
<p><b>APPROVALS</b></p> <p>FCC Part 15</p> <p>FCC Part 68</p> <p><b>UL</b></p> <p>Model 3910</p> <p>COMSPHERE 3000 Series Carrier</p> <p><b>CSA</b></p> <p>Model 3910</p> <p>COMSPHERE 3000 Series Carrier</p> <p><b>DOC</b></p> <p>Model 3910</p> <p>Model 3911</p>	<p>Class A</p> <p>Registration Number: (See label on modem)</p> <p>Listed to UL 1950</p> <p>Recognized to UL 1950</p> <p>Certified to CSA C22.2 No. 950-M89</p> <p>Certified as a component to CSA C22.2 No. 950-M89</p> <p>Certification Number: (See label on modem)</p> <p>Certification Number: (See label on modem)</p>
<p><b>COMPATIBILITY</b></p>	<p>Leased-Line Modulations:</p> <p>Paradyne V.32 terbo (19200, 16800 bps)</p> <p>CCITT V.32bis (14400, 12000, 9600, 7200, 4800 bps)</p> <p>CCITT V.32 (9600, 4800 bps)</p> <p>Paradyne Trellis Multipoint (19200, 14400, 9600, 7200, 4800, 2400 bps)</p> <p>CCITT V.22bis (2400 bps)</p> <p>CCITT V.27bis (4800, 2400 bps)</p> <p>CCITT V.33 (14400, 12000 bps)</p> <p>CCITT V.29 (9600, 7200, 4800 bps)</p> <p>Paradyne Point-to-Point Diagnostic (1200, 2400 bps)</p> <p>Dial-Line Modulations:</p> <p>Paradyne V.32 terbo (19200, 16800 bps)</p> <p>CCITT V.32bis (14400, 12000, 9600, 7200, 4800 bps)</p> <p>CCITT V.32 (9600, 4800 bps)</p> <p>CCITT V.22bis (2400 bps)</p> <p>CCITT V.22 (1200 bps)</p> <p>CCITT V.23 (1200, 600 bps)</p> <p>CCITT V.21 (300 bps)</p> <p>Bell 212A (1200 bps)</p> <p>Bell 103J (300 bps)</p> <p>Paradyne Point-to-Point Diagnostic (1200, 2400 bps)</p>

**Table 1-1  
(2 of 3)  
Technical Specifications for 391x Series Modems**

Specifications	Description
<b>ENVIRONMENT</b>	
Operating Temperature	32°F (0°C) to 122°F (50°C)
Relative Humidity	5% to 90% (noncondensing)
Shock and Vibration	Withstands normal shipping
Storage Temperature	-4°F (-20°C) to 158°F (70°C)
<b>DTE INTERFACE</b>	
25-pin D-subminiature connector	EIA-232-D/CCITT V.24
<b>MODEL 3910 POWER SUPPLY AC POWER REQUIREMENTS</b>	100 to 250 Vac, 50 to 60 Hz
<b>POWER CONSUMPTION</b>	
Model 3910	6 watts (typical, including power supply, speaker off)
Model 3911	4 watts (typical, each card) (Speaker consumption is approximately 1 watt at high volume.)
<b>DIMENSIONS</b>	
Weight	2.5 pounds (1.14 kg) Model 3910 (without power supply) 1.0 pounds (0.45 kg) Model 3911
Height	2.1 inches (5.4 cm) Model 3910 7.1 inches (18.1 cm) Model 3911
Width	7.6 inches (19.4 cm) Model 3910 0.9 inches (2.3 cm) Model 3911
Depth	12.1 inches (30.8 cm) Model 3910 13.4 inches (34.0 cm) Model 3911
<b>TRANSMIT LEVEL</b>	
Leased Line (North America)	0 through -15 dBm (in 1 dBm decrements) Factory default is 0 dBm
Leased Line (All Other Countries)	0 through -15 dBm (in 1 dBm decrements) Factory default is country dependent
Dial Line (North America)	-10 through -32 dBm (in 1 dBm decrements) Factory default is Permissive (-9 dBm)
Dial Line (All Other Countries)	Level setting is not accessible to the user Factory default is country dependent
<b>TELEPHONE INTERFACE</b>	
Leased-Line Connectivity	JM8 (Model 3910) 50-pin mass termination (Model 3911)
Dial-Line Connectivity	RJ11C Permissive RJ21X Permissive 50-pin connector (Model 3911)

**Table 1-1**  
**(3 of 3)**  
**Technical Specifications for 391x Series Modems**

<b>Specifications</b>	<b>Description</b>
<b>DATA RATES</b> Leased Line Dial Line	19200, 16800, 14400, 12000, 9600, 7200, 4800, 2400 1200 bps 19200, 16800, 14400, 12000, 9600, 7200, 4800, 2400, 1200, 600, 300 bps
<b>ERROR CONTROL</b>	CCITT V.42 MNP 4-2
<b>DATA COMPRESSION</b>	CCITT V.42bis MNP Class 5

---

# Modem Installation 2

Overview .....	2-1
391x Series Modem Package .....	2-1
Customer-Supplied Equipment .....	2-2
Model 3910 Modem Installation .....	2-2
Connecting Cables to the Model 3910 Modems .....	2-3
DTE Connection .....	2-4
Model 3910 4-Wire/2-Wire Leased-Line Connection .....	2-4
Dial Network Connection .....	2-4
Model 3910 Dial Backup Connection .....	2-4
Model 3910 Leased Backup Connection .....	2-4
Network Management System Connection .....	2-5
Power Supply Connection .....	2-5
Modem Power-Up .....	2-5
Selecting Factory Configuration Options .....	2-6
Using the Diagnostic Control Panel (DCP) .....	2-6
Using AT Commands .....	2-7
Removing and Replacing Model 3910 Modems .....	2-9
Model 3911 Modem Installation .....	2-9
Removing and Replacing Model 3911 Modems .....	2-12

## Overview

This chapter provides a list of equipment supplied with the modem as well as a list of customer supplied equipment. In addition, it describes how to install and remove the 391x Series modem, and how to select a factory preset configuration using either the DCP or AT™ command set.

## 391x Series Modem Package

After opening the modem's package, check for damage and verify that the following items are present:

### *For the standalone model*

- Installation instructions
- Model 3910 modem
- Power supply
- One 6-position, 4-wire modular cord
- One 8-position, 8-wire modular cord

***For the carrier-mounted model***

- Installation instructions
- Model 3911 modem
- Rear connector plate with two DB-25-S edge card connectors

If any hardware components are damaged, notify your service representative. Return equipment using the procedures described in the *Government Requirements and Equipment Return* section of Chapter 1.

**Customer-Supplied Equipment**

The following customer-supplied equipment is required to complete a data communications system using the Model 3910 modem:

- A DTE with an available EIA-232-D serial port.
- A standard EIA-232-D cable with a DB-25-P (plug) connector at one end to attach to the modem.
- One of the following modular leased or dial network interfaces:
  - JM8 for leased-line applications.
  - RJ11C for dial permissive applications.

The following customer-supplied equipment is required for the installation of a Model 3911 modem:

- A COMSPHERE 3000 Series Carrier.
- A 50-pin mass termination cable.
- One of the following modular or 50-pin leased or dial network interfaces:
  - RJ11C for single line dial permissive applications.
  - RJ21X for multiple line dial permissive applications.
  - 66 punchdown block.
- One Network Interface Module (NIM) for modems installed in Slots 1–8 and one NIM for modems installed in Slots 9–16 (required for dial-line applications).

For installation of the COMSPHERE 3000 Series Carrier into a cabinet, refer to the *COMSPHERE 3000 Series Carrier, Installation Manual*.

**Model 3910 Modem Installation**

Before installing your standalone modem, make sure your installation site is clean and well-ventilated. Allow space around the modem for installing cables and telephone cords, and make sure the modem is located within reach of the ac power outlet. The distance between your modem and DTE should be minimized if DTE data rates exceed 19,200 bps. Also, low capacitance cables may be necessary for speeds greater than 19,200 bps or distances greater than 50 feet.



The rear panel of the Model 3910 modem (Figure 2-1) has the following switches and connectors:

- An ON/OFF power switch.
- An 8-pin DIN type power receptacle (PWR) for the dc power supply.
- An 8-pin modular keyed jack (LEASED) for 4-wire/2-wire leased lines.
- An 8-pin modular keyed jack (DIAL) for backup lines (2-wire dial or 2-wire leased).
- A 4-pin modular jack for the (NMS) network management system connection.
- A 25-pin DB-25-S receptacle for the DTE interface.

## Connecting Cables to the Model 3910 Modems

Figure 2-1 shows how Model 3910 modems are connected to certain TELCO jack types using the appropriate cables. For pin assignments, refer to Appendix C.

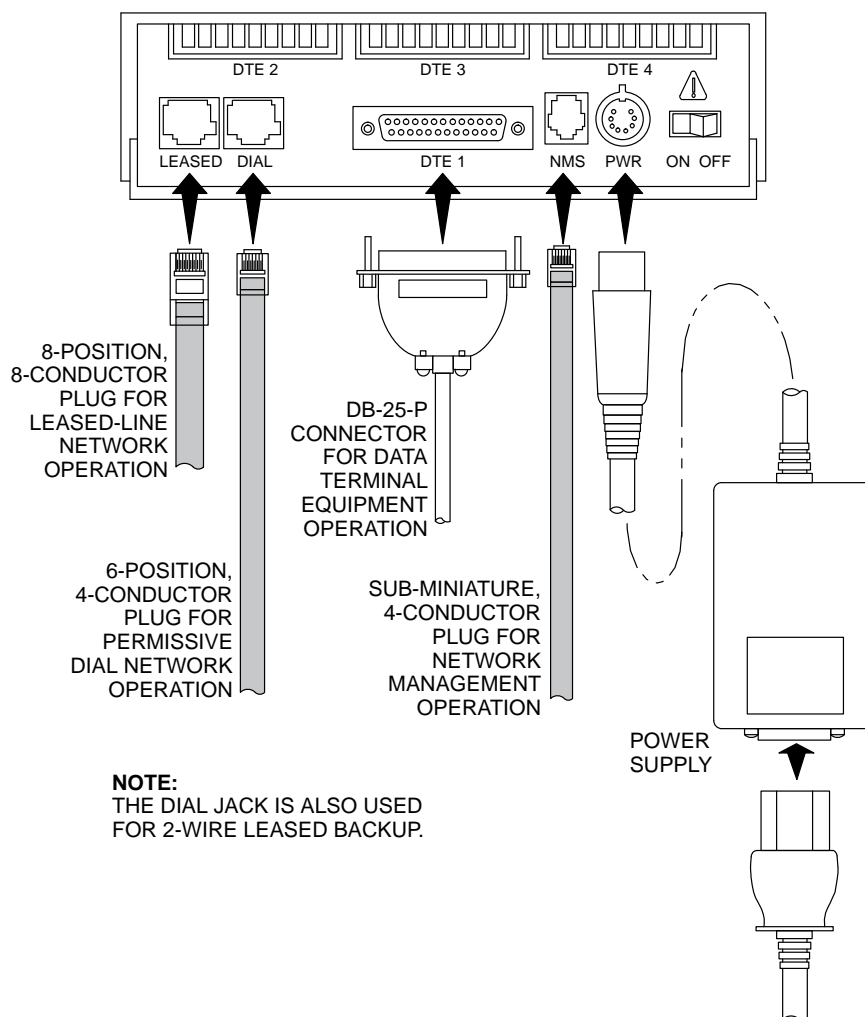


Figure 2-1. Model 3910 Rear Panel and Power Supply

## DTE Connection

Use the following procedures to connect the EIA-232-D cable from the modem to the DTE:

1. Make sure the modem's rear panel power switch is OFF.
2. Connect the DB-25-P (plug) connector on the cable to the DB-25-S (socket) connector labeled DTE (Figure 2-1) on the modem's rear panel. Use a small screwdriver to secure the cable to the modem.
3. Connect the DB-25-P connector on the cable to the DB-25-S connector on the DTE. Use a small screwdriver to secure the cable to the DTE.

## Model 3910 4-Wire/2-Wire Leased-Line Connection

Use the following procedures to connect a Model 3910 to the leased-line network interface:

1. Insert the 8-position, 8-conductor modular plug into the jack labeled LEASED (Figure 2-1).
2. Insert the other end of the modular cord into the leased-line network interface.

## Dial Network Connection

The telephone company provides the line termination jacks for the permissive service you request. Advance coordination with the telephone company is suggested when connecting the modem to telephone dial lines (PSTN).

In the Permissive mode, the modem's transmit output level is fixed at -9 dBm. The telephone company assumes that the line loss is 3 dB and no compensation is provided for additional losses. A Permissive mode telephone line is usually terminated with a USOC RJ11C jack.

## Model 3910 Dial Backup Connection

For the Model 3910, use the following procedures to connect the modem to the dial backup network interface:

1. Insert the 6-position, 4-conductor modular plug into the jack labeled DIAL (Figure 2-1).
2. Insert the other end of the modular cord into the dial network interface.

## Model 3910 Leased Backup Connection

For the Model 3910, use the following procedures to connect the modem to the 2-wire leased backup network interface:

1. Insert the 8-position, 8 conductor modular plug into the jack labeled DIAL (Figure 2-1).
2. Insert the other end of the modular cord into the leased-line network interface.

## Network Management System Connection

For the Model 3910, use the following procedures to connect the modem to the network management system interface:

1. Insert the sub-miniature, 4-conductor modular plug of the 3600 Hubbing Device into the jack labeled NMS (Figure 2-1). Refer to Document Number, 3610-A2-GZ45, *3600 Hubbing Device Feature Number 3600-F3-300, Installation Instructions*, for a description of the 3600 Hubbing Device. Installation for the 3910 is the same as for the 3610 DSU.
2. Connect the 3600 Hubbing Device to the network management channel (Figure G-4 in Appendix G).

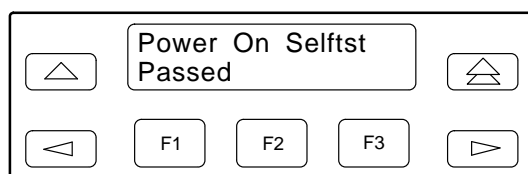
## Power Supply Connection

Use the following procedures to connect the modem to an ac power outlet:

1. Make sure the modem's power switch is in the OFF position.
2. Insert the power supply's 8-pin DIN connector into the modem's rear panel dc power receptacle (Figure 2-1).
3. Connect the power supply to a grounded ac power outlet.

## Modem Power-Up

Once your modem is properly connected to the power supply, leased and/or dial lines, and the DTE, press the modem's rear panel power switch to the ON position. The modem begins a power-up self-test, in which all DCP LEDs light. This test takes several seconds to perform, and verifies the operation of most hardware components within the modem. If successful, the LCD displays **Power on Selfst Passed** and continues to the Top-Level menu screen.



If a failure occurs during the self-test, the LCD displays **Power On Selfst Failed** for several seconds. The LCD then displays the Top-Level menu screen with the message **Power on Fail** appearing on the top line of the LCD. Although a failure has occurred, the modem will attempt to operate. This allows you to activate a more thorough self-test using the Test branch. Refer to the *Test* section in Chapter 3.

## Selecting Factory Configuration Options

After the modem passes the power-up self-test, configure it for operation using one of the six factory preset configurations.

The 391x Series modems have six factory preset templates that contain the most commonly used configuration options (straps) for Synchronous Leased (Answer or Originate), Asynchronous Leased (Answer or Originate), Trellis Multipoint (Control or Tributary), Asynchronous Dial, Synchronous Dial, and UNIX Dial hardware network configurations. Your modem ships from the factory with the Synchronous Leased (Answer) default configuration options stored in memory. If Synchronous Leased (Originate), Asynchronous Leased (Answer or Originate), Trellis Multipoint (TMp) (Control or Tributary), Async Dial, Sync Dial, or UNIX Dial is more appropriate for your configuration, then you must change the factory setting using either the modem's DCP or the AT command set as described in the following sections.

The purpose of having preset configurations is so that you can have a "head start" in getting your modem operating and reducing the amount of time required to configure your modem. For a better understanding of DCP operation and factory preset configuration options, refer to Chapter 4, *DCP Configuration*.

### Using the Diagnostic Control Panel (DCP)

The DCP's liquid crystal display (LCD) consists of two 16-character lines which display modem status, control functions, and configuration options as well as indicating your location in the Top-Level menu tree (Appendix A).

To change a factory template from the Sync Leased preset configuration using the DCP, perform the following steps:

1. Press the function key below **Configure** to select the Configure branch.

The LCD now displays **Ld EditArea frm**.

2. Press the  $\triangleright$  key until **Factory** comes into view, then press the F1 key to display the factory preset configurations.

Factory preset configurations are **Sync Leased**, **Async Leased**, **TMp** (Trellis Multipoint), **Async Dial**, **Sync Dial**, and **UNIX Dial**. If Sync Leased or Async Leased is selected, you must choose either **Answer** or **Originate** mode. If TMp is selected, you must choose either **Control** or **Trib** (Tributary) mode.

3. Press the  $\triangleright$  key until the appropriate factory preset template appears on the LCD, and press the corresponding function key to select your choice. (For certain factory templates you will also need to choose the appropriate mode.)
4. Choose Function appears and displays the Edit and Save functions.
5. Press the F3 key (Save) to save the new factory preset configuration to one of three configuration areas, **Active (Saved)**, **Customer 1**, or **Customer 2**.

(These three configuration areas are nonvolatile memory locations. Active (Saved) contains the most recently saved changes to any configuration options. In the event of power loss, the modem retrieves these configuration options. Customer 1 and Customer 2 are user-defined configuration areas.)

The LCD now displays **Sav EditArea to**.

6. Press the  $\triangleright$  key until the appropriate configuration area appears on the LCD, then press the corresponding function key to select your choice. (Saving configuration options to the Active (Saved) configuration area automatically saves them to the Active (Operating) configuration area.) The LCD displays **Command Complete**.
7. The modem is now configured with the selected factory template. Press the  $\triangleleft$  key to return to the Top-Level menu.

Refer to Chapter 4, *DCP Configuration*, for more information regarding default factory configuration options.

## Using AT Commands

When using AT commands, the following criteria must be met:

- Make sure the asynchronous DTE's communication software is configured for 10-bit character format (for example, 8 data bits, no parity, and 1 stop bit).
- Make sure the DTE cable is attached to the DTE connector on the rear of the 391x Series modem and to the correct serial communications port on the asynchronous DTE.
- Configure the modem for **Async Dial**, **Async Leased**, or **UNIX Dial** as described earlier in *Using the DCP*. To verify that the modem is connected and functioning properly, enter the following:

**TYPE:** AT

**PRESS:** Return (Enter)

The screen displays **OK**.

If the modem does not return **OK**, refer to Appendix B, *Troubleshooting*.

### NOTE

If the factory preset configuration is something other than Async Dial, Async Leased, or UNIX Dial, you do not have AT command control. To regain AT command control, select, via the DCP, the Async Dial factory preset configuration as described earlier in *Using the DCP*.

To change a factory template using AT commands, perform the following steps. For more information on changing factory templates using AT commands, refer to Chapter 5, *AT Command Set and S-Registers*.

1. Use the **AT&F&W** command to load the appropriate factory configuration to the appropriate storage area. Enter the following:

**TYPE:** AT&Fy&Wn

**Where:** y is one of the following Factory configurations:

- 0 for Async Dial
- 1 for Sync Dial
- 2 for Sync Leased (Answer)
- 3 for UNIX Dial
- 4 for Sync Leased (Originate)
- 5 for Async Leased (Answer)
- 6 for Async Leased (Originate)
- 7 for TMp (Control)
- 8 for TMp (Trib)

**NOTE**

Only &F0, &F3, &F5, and &F6 allow you to use AT commands after saving a factory configuration. Any other selection removes AT command control. The only way to return to AT command control is through the DCP as described earlier in *Using the DCP*.

**Where:** n is one of the following storage areas:

- 0 for Active (Saved)
- 1 for Customer 1
- 2 for Customer 2

**NOTE**

These three configuration areas are nonvolatile memory locations. Active (Saved) contains the most recently saved changes to any configuration options. In the event of power loss, the modem retrieves these configuration options. Customer 1 and Customer 2 are user-defined configuration areas.

**PRESS:** Return (Enter)

2. The selected factory configuration is saved.

To establish a connection with a remote modem, use the D (Dial) command. Refer to Chapter 5, *AT Commands and S-Registers*, for more on AT commands.

## Removing and Replacing Model 3910 Modems

To remove and replace a Model 3910 modem, perform the following steps:

1. Make sure the modem is offline, and press the modem's rear panel power switch to the OFF position.
2. Disconnect the power cord from the ac power outlet, and then disconnect the dc power cable from the connector on the rear of the modem.
3. Disconnect the leased-line and dial modular cords from the modem's rear panel.
4. Disconnect the DTE interface cable from the modem's rear panel.

If the modem is to be removed for service, return it to the company using the procedures described in *Government Requirements and Equipment Return* in Chapter 1.

5. Install the replacement modem as described in the *Model 3910 Modem Installation* section of this chapter, and configure it the same way as the modem being replaced.

## Model 3911 Modem Installation

### CAUTION

**If the Model 3911 is removed from the carrier, always use a ground strap when handling the modem. Always store the Model 3911 in an antistatic bag when it is removed from the carrier.**

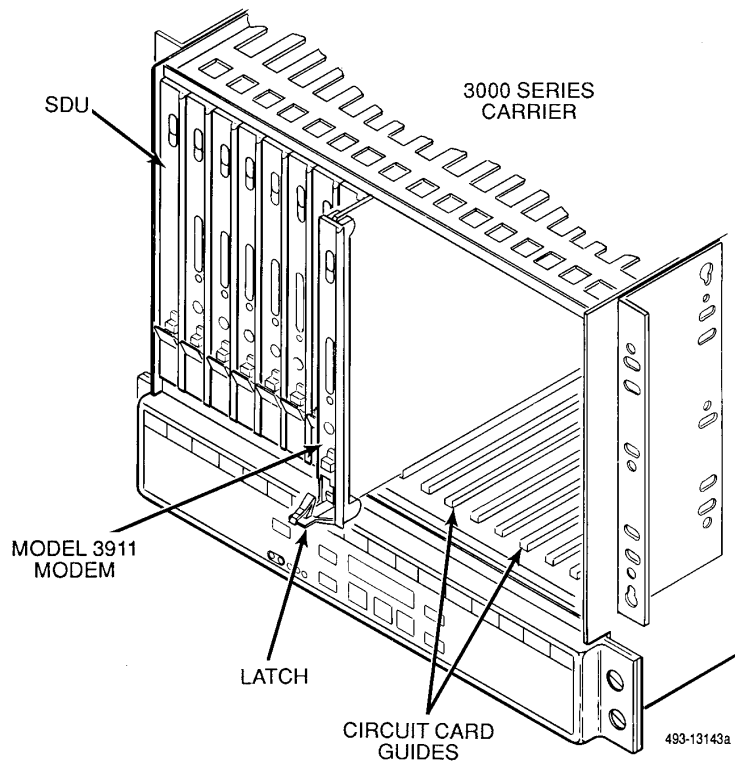
The Model 3911 is designed for installation in a COMSPHERE 3000 Series Carrier which supplies both the operating power and the leased and/or dial network connections. For additional information about the COMSPHERE 3000 Series Carrier, refer to the *COMSPHERE 3000 Series Carrier; Installation Manual*.

The COMSPHERE 3000 Series Carrier has 17 slots which can hold up to 16 modems and one shared diagnostic unit (SDU). The SDU is required when the modems in the carrier are controlled by an NMS, or when multiple carriers in a cabinet configuration are to be controlled by a single shared diagnostic control panel (SDCP). The SDCP of the COMSPHERE 3000 Series Carrier is the user interface to the Model 3911 modem. A single SDCP can control up to eight carriers containing up to 128 compatible modems.

The installation of a Model 3911 varies slightly if an SDCP is installed on the front of the carrier. To install a Model 3911 modem into the carrier without an SDCP, perform the following steps:

1. At the rear of the carrier, install the rear connector plate. Make sure the plate uses the same slot position as that intended for the modem.

Loosely fasten the plate. This allows for slight adjustments later when installing the modem.



**Figure 2-2. Installing a Model 3911 Modem**

2. At the front of the carrier, hold the modem vertically, with the latch on its faceplate in the open position, and insert it into the top and bottom card guides of one of the slots numbered 1–16 (Figure 2-2).

Slide the modem into the slot, aligning the modem with the rear connector plate, until the backplane connector and DTE connector seat firmly into the back of the carrier. The faceplate latch automatically closes as you push the modem into the carrier. To lock the modem into the carrier, press the faceplate latch until a “click” is heard.

3. If the carrier is ON, the **Power** LED on the faceplate of the 3911 lights. After several seconds the modem completes its power-up self-test, in which all faceplate LEDs light.

Return to the rear of the carrier and tighten the rear connector plate.

If the modem is to communicate with an installed SDCP, install the modem as described above and perform the following steps:

1. Press the  key on the SDCP. The cursor appears in the carrier selection entry.
2. Press the F1 (↑) or F2 (↓) key until the carrier number you want appears on the LCD.

The carrier number selection has a range of 1 to 8 since a single SDCP can control a configuration of up to eight carriers. (This is only possible if the SDU is installed.)

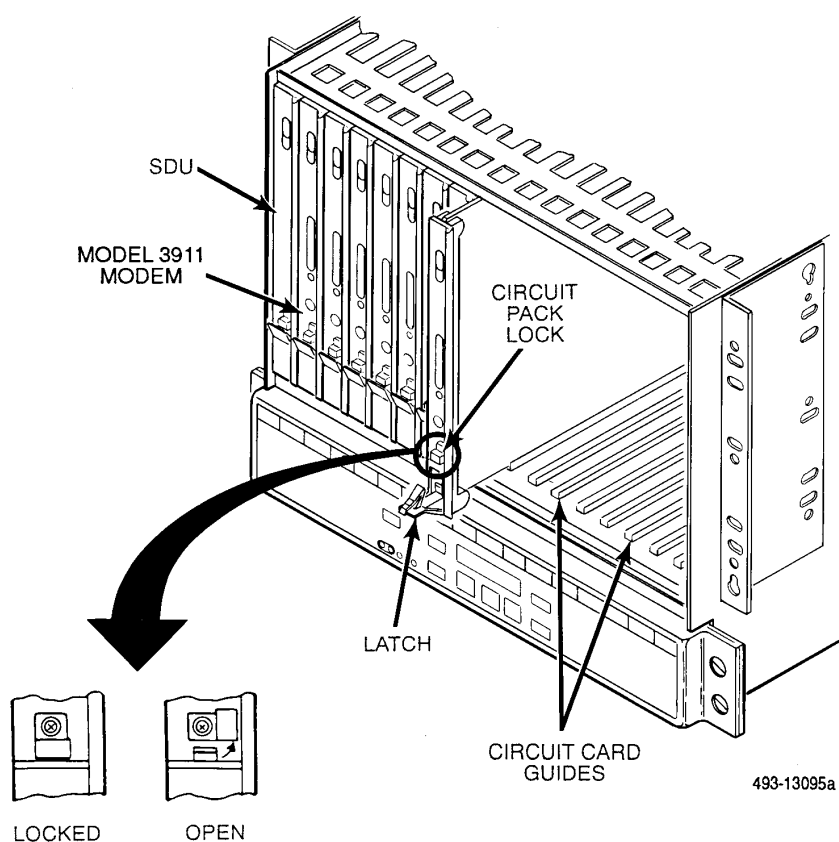
3. Press the  key to position the cursor on the slot selection entry.
4. Press the F1 (↑) or F2 (↓) key until the slot number you want (1–16) appears on the LCD.



5. Press the **Select** key to place the SDCP in direct communication with the selected modem.

The LCD displays the Top-Level menu for the selected modem. In addition, the **Front Panel LED** on the modem's faceplate and the **OK LED** on the SDCP light.

6. Once you have determined that the modem is installed properly and completed its power-up self-test, rotate the circuit pack lock until it covers the faceplate latch (Figure 2-3) and tighten the retention screw on the circuit pack lock. This prevents the modem from accidentally being removed once it is installed in a carrier.
7. Configure the modem as described in the *Selecting Factory Configuration Options* section earlier in this chapter.



**Figure 2-3. Circuit Pack Lock**

## Removing and Replacing Model 3911 Modems

**CAUTION**

**If the Model 3911 is removed from the carrier, always use a ground strap when handling the modem. Always store the Model 3911 in an antistatic bag when it is removed from the carrier.**

It is not necessary to power down the carrier to remove and replace a Model 3911 modem. Perform the following steps:

1. Rotate the circuit pack lock until the release tab is exposed.
2. Press down on the release tab and pull the modem away from the carrier's backplane.

---

# DCP Operation **3**

Overview .....	3-2
Diagnostic Control Panels .....	3-2
Model 3910 Diagnostic Control Panel .....	3-3
Model 3911 Faceplate and Shared Diagnostic Control Panel (SDCP) .....	3-3
Status Indicators .....	3-4
Diagnostic Control Panel Operation .....	3-6
LCD Display .....	3-6
Hidden Choice Indicators .....	3-7
Other Indicators .....	3-7
Keypad .....	3-7
Menu Structure .....	3-8
Top-Level Menu Status and Operational Messages .....	3-9
Quick Configuration Display .....	3-14
Status Branch .....	3-15
Device Health and Status (DeviceHS) .....	3-16
VF .....	3-19
Identity .....	3-20
DTE .....	3-21
Backup .....	3-21
Options .....	3-23
Record .....	3-24
Configure Branch .....	3-25
Poll List Branch .....	3-25
Display .....	3-26
Clear .....	3-27
Change .....	3-27
Add .....	3-28
Acquire .....	3-29
Control Branch .....	3-30
Speaker .....	3-31
Reset .....	3-31
Data Stream .....	3-32
EIA LEDs .....	3-33
Make Busy/Remove Make Busy .....	3-34
Service Line/Disconnect Service Line .....	3-35
Download Software .....	3-35
Selecting Clone Remote .....	3-36
Clone Remote in Point-to-Point Configurations .....	3-36
Clone Remote in Broadcast Configurations .....	3-37
Clone Remote in Multipoint Configurations .....	3-38
Implementing a Clone Remote Operation .....	3-40
VF Thresholds Update .....	3-42
Test Branch .....	3-46
Abort .....	3-46
Self .....	3-47
Loc Analog Loop .....	3-48
Rem Digital Loop .....	3-49
Loc Digital Loop .....	3-50
Pattern .....	3-51
Sub-Network Health and Status Branch .....	3-53

Call Setup Branch .....	3-54
Dial .....	3-55
Disconnect .....	3-56
Answer .....	3-57
Dial Standby/Return to Dial .....	3-57
Change Directory .....	3-59
Entering Telephone Numbers and Dial Command Modifiers into	
Directory Locations .....	3-60
Directory Status (Does Not Appear in North America) .....	3-61
Talk/Data Branch .....	3-62
Manual Dialing When the Remote Modem is Configured for	
Auto-Answer .....	3-63
Manual Dialing When the Remote Modem is Configured for	
Manual Answer .....	3-64
Security Branch .....	3-64
Remote Branch .....	3-65
Diagnostic Control Panel Access .....	3-69

## Overview

This chapter describes how to use the diagnostic control panel (DCP) of the 391x Series modem. It also describes how to select and use each branch of the Top-Level menu tree.

## Diagnostic Control Panels

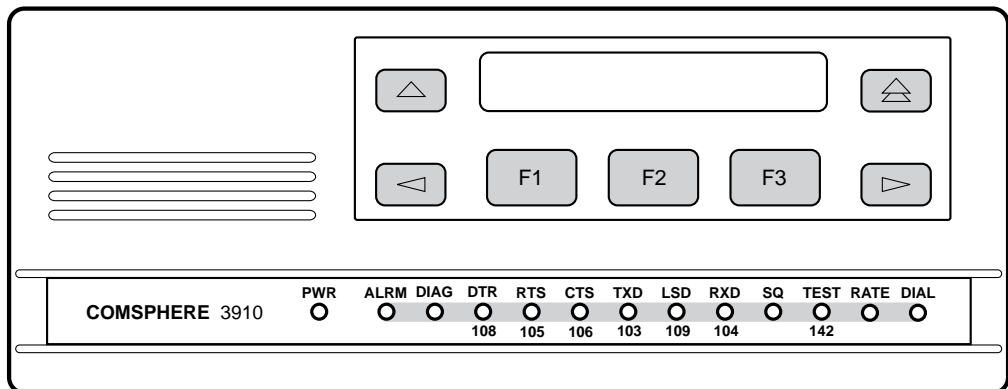
There are two types of diagnostic control panels (DCP), the DCP on the standalone Model 3910 modems and the shared diagnostic control panel (SDCP), an optional feature, used with the Model 3911 installed into a COMSPHERE 3000 Series Carrier. Both DCPs have a two-line, 32-character liquid crystal display (LCD) and keypad through which Top-Level menu branches are accessed to perform the following:

- Check modem status
- Set up configuration options
- Initiate diagnostic tests
- Initiate and disconnect dial operations
- Access remote modems through the local modem's DCP

The LCD displays the result of any command initiated using the DCP. Most of these operations can be performed from an attached asynchronous DTE using the AT command set.

## Model 3910 Diagnostic Control Panel

The diagnostic control panel (DCP) of the Model 3910 modem (Figure 3-1) contains status indicators, pushbutton-type keys, an LCD, and speaker grill.



496-14174-01

Figure 3-1. Model 3910 DCP

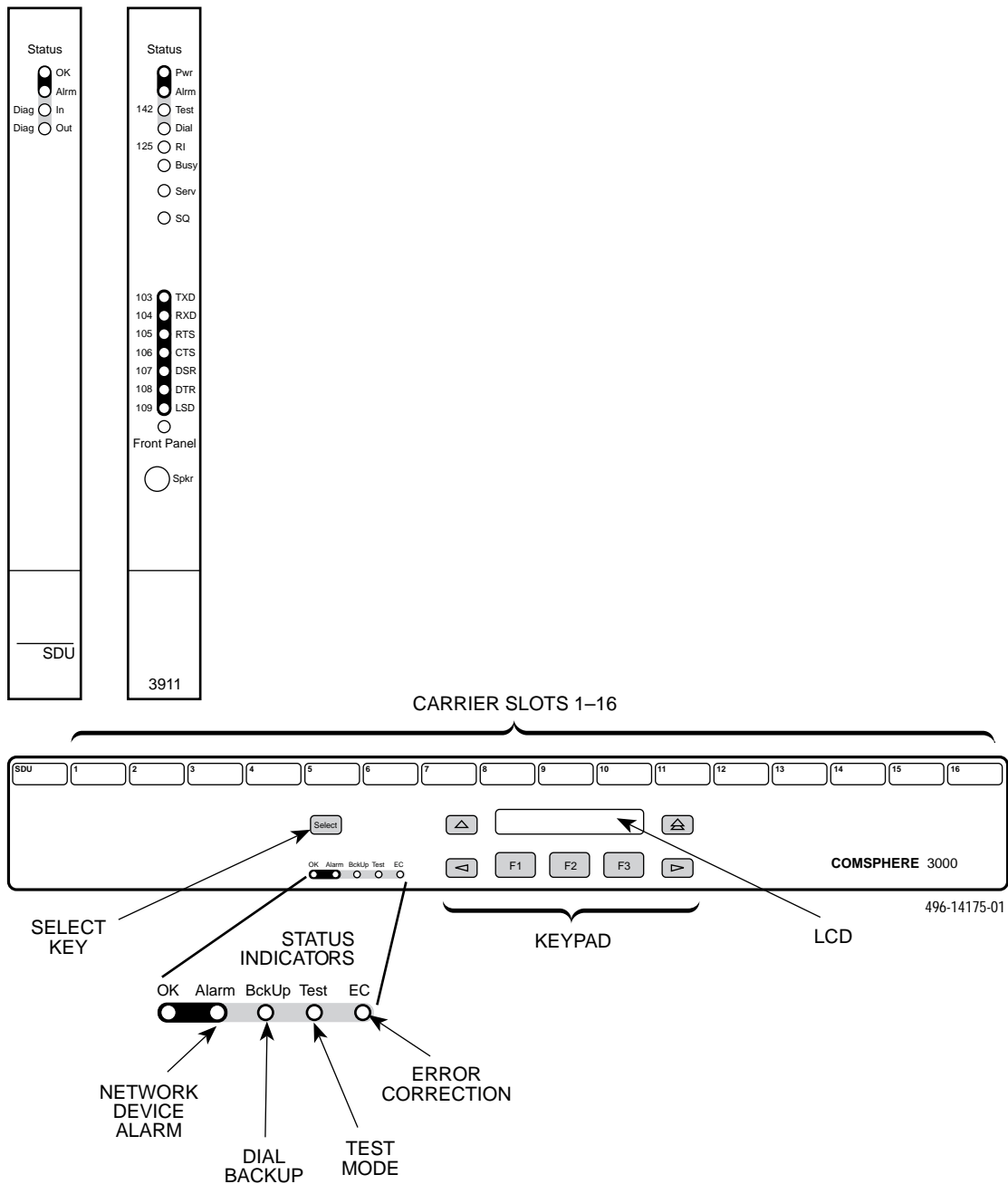
## Model 3911 Faceplate and Shared Diagnostic Control Panel (SDCP)

The shared diagnostic control panel (SDCP), Figure 3-2, is used to manage carrier-mounted Model 3911 modems.

The faceplate of the Model 3911 contains status indicators that monitor the operation of the modem. After the SDCP is connected to the modem, the **Front Panel** indicator of the selected modem lights to show that the modem is connected.

# Status Indicators

The 391x Series modems' status indicators continuously provide information on the modem's operating condition. All of the status indicators on the Model 3910 appear on the DCP (Figure 3-1), whereas the status indicators for the carrier-mounted Model 3911 are located on the Model 3911's faceplate, the SDCP, and the SDU faceplate (Figure 3-2).



**Figure 3-2. Optional SDCP, Model 3911 Faceplate, and Optional SDU**

The standalone Model 3910 modem's DCP has 13 light-emitting diodes (LEDs), and the carrier-mounted Model 3911 has 16 LEDs. These LEDs are listed and described in Table 3-1. LEDs specific to one model type have the appropriate model number shown in the table.

**Table 3-1**  
**Model 3910 and Model 3911 DCP LEDs**

<b>Label</b>	<b>Color</b>	<b>Indicates</b>
<b>Pwr</b>	green	Power has been applied to the modem.
<b>Alrm</b>	red	Flashing. A major alarm has been detected in a remote 391x Series modem. ON. A major alarm has been detected in the local modem. (For Health and Status alarm conditions, refer to Table 3-6 in the <i>Device Health and Status</i> (DeviceHS) section of this chapter.)
<b>Diag</b> (3910 only)	green	The modem is receiving diagnostic communications (either a command or a status poll).
<b>Test/142</b>	yellow	Flashing. The modem is involved in a firmware upgrade. Normal operation is not possible. ON. The modem is involved in a test. Normal operation is not possible. OFF. The modem is not involved in a test or firmware upgrade.
<b>Dial</b>	yellow	Flashing. The modem is attempting to establish a call over the dial network, or the modem is in Dial Standby mode. ON. The modem has established a dial connection. OFF. A dial connection does not exist.
<b>RI/125</b> (3911 only)	green	A ringing signal is being received.
<b>Busy</b> (3911 only)	yellow	The modem is placed in a forced busy condition and is off-hook.
<b>Serv</b> (3911 only)	yellow	The modem is connected to the carrier service line rather than the normally assigned network.
<b>SQ</b>	yellow	The receive telephone line signal is degraded or the modem's data path has been blocked (SQ flashes).
<b>TXD/103</b>	green	The modem is receiving data from the DTE to transmit. (ON equals space.)
<b>RXD/104</b>	green	Data is being transferred to the DTE. (ON equals space.)
<b>RTS/105</b>	green	RTS signal is ON.
<b>CTS/106</b>	green	CTS signal is ON.
<b>DSR/107</b> (3911 only)	green	DSR signal is ON.
<b>DTR/108</b>	green	The DTE has turned ON DTR or the modem has forced DTR ON.
<b>LSD/109</b>	green	The modem has detected a valid carrier signal and is capable of transferring data to the DTE.
<b>Rate</b> (3910 only)	yellow	ON. The modem is connected at a data rate lower than the data rate it is configured for. OFF. The modem is connected at its configured data rate.
<b>Front Panel</b> (3911 only)	yellow	The modem is connected to the carrier's SDCP.

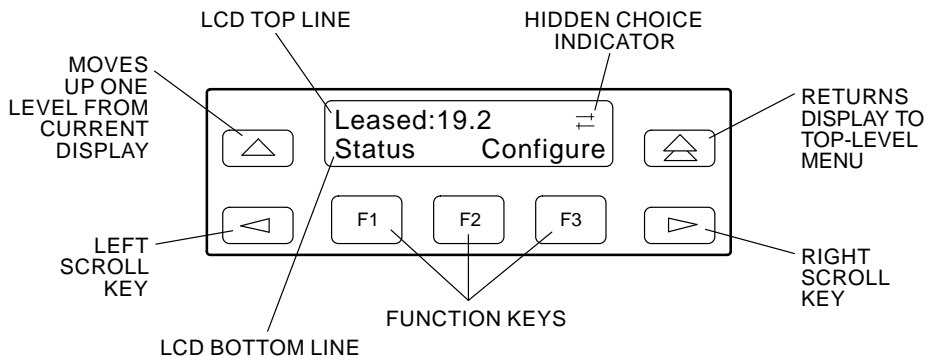
The SDCP LEDs are listed and described in Table 3-2.

**Table 3-2  
SDCP LEDs**

Label	Color	Indicates
<b>OK</b>	green	Power is ON and the modem is capable of operating.
<b>Alarm</b>	red	The modem has detected a problem with its operation. For example, the modem failed a self-test.
<b>BckUp</b>	yellow	The modem, originally configured for leased-line operation, is now operating on dial networks in a Dial Backup mode.
<b>Test</b>	yellow	The modem is involved in a test. Normal operation is not possible.
<b>EC</b>	green	The modem is in Error Control mode.

## Diagnostic Control Panel Operation

The 391x Series modem’s diagnostic control panel (DCP) is the user interface to all functions used to configure and control the modem. In addition to the status LEDs, this interface includes the liquid crystal display (LCD) and keypad (Figure 3-3).



**Figure 3-3. 391x Series LCD and Keypad**

### LCD Display

The LCD consists of a top line and bottom line, with each displaying a maximum of 16 characters at a time. If more information is available on the LCD than what is currently displayed, an indicator appears in the top right or bottom right-hand corner of the LCD. Use the ◀ or ▶ key to scroll in the indicated direction to display more selections onto the LCD.



## Hidden Choice Indicators

The hidden choice indicators serve as an alert that other choices are available besides what is currently displaying on the LCD. These indicators appear as one of the following symbols:

### Right Scroll Indicator >

The right scroll indicator appears when more choices are available to the right of what is currently displayed on the LCD.

### Left/Right Scroll Indicator ⇄

The left/right scroll indicator appears when more choices are available to the left and right of what is currently displayed on the LCD.


### Left Scroll Indicator <

The left scroll indicator appears when more choices are available to the left of what is currently displayed on the LCD.


## Other Indicators

Other indicators may turn on depending on existing conditions, such as error detection, informational alerts, and warnings. These indicators appear on the top or bottom line of the LCD.


### Remote Mode Indicator

If the local 391x Series modem establishes a connection with the remote 391x Series modem via the Remote branch, then  appears in the upper right corner of the LCD top line on both modems. For more information on the Remote Mode indicator, refer to *Remote Branch* in this chapter.

### Out of Range Indicator


If an invalid threshold (out of range) is selected in the VF Threshold update process, then  appears in the lower right corner of the LCD bottom line. For more information on the Out of Range indicator, refer to *VF Threshold Update* in this chapter.

## Keypad


The DCP on the Model 3910 has seven keys while the optional SDCP of the COMSPHERE 3000 Series Carrier has eight keys. The additional key on the carrier is the  key, used to connect the SDCP to a specific slot in the carrier.

### **Key**



The  key returns you to the Top-Level menu display from anywhere in the menu tree.

Pressing  while changing configuration options displays the message **Save Straps? Yes No**. If **No** is selected, changes made to configuration options are not saved and the Top-Level menu appears. If **Yes** is selected, then changes are saved to either Active (Saved), Customer 1, or Customer 2 configuration areas.

### **Key**

The  key moves you up one level in the menu tree.

### **and** **Keys**

Use the  and  keys to move the viewing window left or right and to scroll the remaining branches and selections into view. A maximum of three selections can be displayed at one time.

These keys also allow you to move the cursor one character to the left or right on data entry displays; for example, to allow entry of one digit at a time.

**F1** **F2** **F3** *Keys*

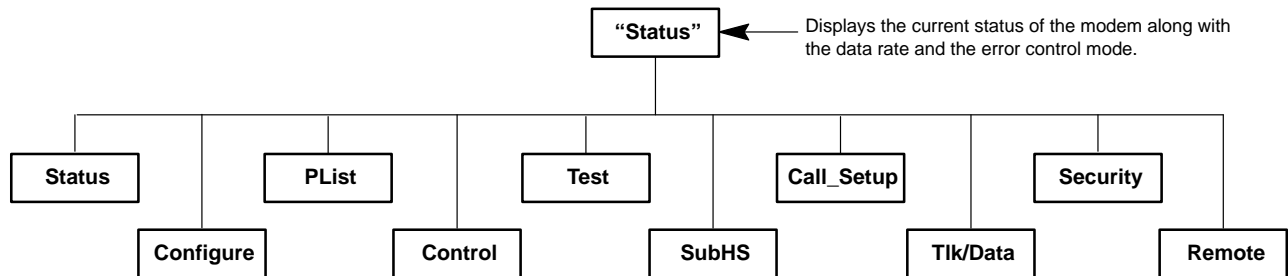
Function keys select the LCD choice that appears above the function key; they are labeled F1, F2, and F3. If a selection spans more than one function key, then any of those keys choose that selection.

**Select** *Key* (Model 3911 only)

The **Select** key appears on the optional SDCP of the COMSPHERE 3000 Series Carrier. It is used to connect the SDCP to a modem in a specific slot in the carrier.

## Menu Structure

The menu tree is a hierarchical structure used to display functions that configure and control local and remote 391x Series modems. It is accessed via the DCP and is shown in Appendix A.



The menu tree contains the following branches:

- Status** — Used to monitor the current status of the VF line and DTE interface as well as view the identity of the modem.
- Configure** — Used to change and save the modem's configuration options.
- PList** — (Poll List) Used to identify downstream modems in order to support multipoint health and status polling and multipoint link download broadcasting.
- Control** — Used to control the modem's hardware and software functions.
- Test** — Used to begin and end various modem tests.
- SubHS** — (Sub-Network Health and Status) Used to display alarm conditions in downstream modems.
- Call Setup** — Used to dial, disconnect, and answer telephone calls as well as store up to 24 telephone numbers in directory locations.
- Talk/Data** — Used to switch the modem between Talk mode (the modem is disconnected from the VF line) and Data mode (the modem is connected to the VF line) when dialing via either the DCP or a telephone.
- Security** — Used to control the modem's dial access security.
- Remote** — Used to access and control a remote 3900 Series modem.

All menu tree branches are discussed later in Chapter 3 except for Configure, which is discussed in Chapter 4, and Security, which is discussed in Chapter 6. Functions that appear on the LCD vary depending upon the type of model installed, its operating mode, and software configuration.

## Top-Level Menu Status and Operational Messages

Access to all menu tree branches from the DCP begins at the Top-Level menu, the head of the menu hierarchy. The LCD's top line identifies the modem status, as listed in Table 3-3, while the bottom line displays the main menu tree branches as well as operational and security messages, as listed in Table 3-4 and Table 3-5.

**Table 3-3**  
**(1 of 4)**  
**Top-Level Menu Status**

Status	Message	Indicates
<b>Normal Operation</b>	Leased:MR*	The modem is operating on leased lines and transmitting at the displayed data rate.
	Idle:MR*	The modem is configured for dial network operation and is on-hook.
	OnLine:MR* EC**	The modem is online, in Data mode, and operating at the displayed data rate. EC (error control) appears if error control is operational.
	Ring Indicate	The local modem is receiving an incoming ring.
	Test:MR*	The modem is in test mode operating at the displayed data rate.
<b>Alarm***</b>	Make Busy	The modem is in a Make Busy condition.
	Power On Fail	The modem has failed its Power-On Self-test.
	SelfHealth Fail	A failure has occurred in the modem's hardware components.
<b>Call Setup</b>	Off Hook	The modem is off-hook and waiting to dial a telephone number.
	Dialing	The originating modem is dialing a telephone number.
	Remote Ring	The remote modem is ringing.
	Training****	The modem is training or retraining.
	EC Negotiating	The local and remote modems are negotiating the highest possible level of error control compatible between both modems. Once a level is selected, this LCD message disappears.
<p>* MR. Modem Rate indicates the data rate the modem is using. One of the following values appears: 300, 1200, 2400, 4800, 7200, 9600, 12.0 (12,000), 14.4 (14,400), 16.8 (16,800), or 19.2 (19,200) bps.</p> <p>** EC. Error Control indicates the modem is online and using V.42 or MNP error control. One of the following values appears after the modem rates listed above: MNP2, MNP3, MNP4, MNP5, V42, V42b, or NoEC. (NoEC indicates the modem is connected in Buffer mode rather than error control. If an EC value does not appear, then the modem is in Direct mode.)</p> <p>*** The Alarm Status Messages only appear when the Normal Operation Status Messages appear; the LCD alternates between the two message sets.</p> <p>**** The Training message may also appear in normal Trellis Multipoint (TMp) operation.</p>		

**Table 3-3  
(2 of 4)  
Top-Level Menu Status**

<b>Status</b>	<b>Message</b>	<b>Indicates</b>
<b>Dial Backup or Leased Backup</b>	Standby: MR*	The modem is operating in Dial Standby mode.
	DialBckUp:MR*	The modem is operating in Dial Backup mode at the displayed data rate and is configured for Direct mode.
	Backup:MR* EC**	The modem is operating in Dial Backup mode and is configured for error control and data compression on leased lines.
	Standby:MR* EC**	The modem is operating in Dial Standby mode and is configured for error control and data compression on leased lines.
<b>Call Failure</b>	Busy Signal	The answering modem is busy.
	Delayed Number †	As a result of failed call attempts, this number cannot be called at this time. Please try again later.
	Dial Line in Use	The modem is operating on dial networks when another call attempt is issued.
	Forbidden Number †	As a result of failed call attempts, this number cannot be called again.
	Invalid Number	The modem has dialed a telephone number not stored in a directory location.
	Line Occupied ††	The line is being used by the associated telephone.
	No Answer Tone	The answering modem did not answer within the time limit specified by the No Answer Timeout configuration option. The network tones (if any) could not be interpreted by the modem.
<p>* MR. Modem Rate indicates the data rate the modem is using. One of the following values appears: 300, 1200, 2400, 4800, 7200, 9600, 12.0 (12,000), 14.4 (14,400), 16.8 (16,800), or 19.2 (19,200) bps.</p> <p>** EC. Error Control indicates the modem is online and using V.42 or MNP error control. One of the following values appears after the modem rates listed above: MNP2, MNP3, MNP4, MNP5, V42, V42b, or NoEC. (NoEC indicates the modem is connected in Buffer mode rather than error control. If an EC value does not appear, then the modem is in Direct mode.)</p> <p>*** The Alarm Status Messages only appear when the Normal Operation Status Messages appear; the LCD alternates between the two message sets.</p> <p>**** The Training message may also appear in normal Trellis Multipoint (TMp) operation.</p> <p>† The Delayed Number and Forbidden Number messages appear only in countries where the number of repeat call attempts are restricted. The regulations vary in each country. If the number is delayed, the value of the delay (in minutes) can be displayed by entering Directory Status (see Call Setup Branch).</p> <p>†† The Line Occupied message appears only in countries where the Offhook Detector is enabled. The purpose of the Offhook Detector is to detect whether the telephone associated with the modem is off-hook. It is enabled on a per-country basis, and this setting cannot be changed by a command. The Offhook Detector is enabled in Austria, Germany, and Switzerland.</p>		

**Table 3-3  
(3 of 4)  
Top-Level Menu Status**

<b>Status</b>	<b>Message</b>	<b>Indicates</b>
<b>Call Failure Cont.</b>	No Dial-DTR	The modem cannot dial because DTR is OFF.
	No Dial-Test	The modem cannot dial because it is running a Test.
	No Dial Tone	The modem has aborted the call because it cannot detect a dial tone.
	No Quiet Answer	The modem has detected No Quiet Answer (@) before the time-out setting of the No Answer Disconnect configuration option.
	Ringback Timeout	The answering modem did not answer within the time limit specified by the No Answer Timeout configuration option. A ringback signal was detected.
	Trunk Busy	The modem is receiving a fast (trunk) busy.
	Wrong Call	The call was answered, but not by a modem. No answer tone.
<b>Call Disconnect</b>	ATH Disconnect	The modem has disconnected due to an ATH command.
	Bad Lines Disc	The modem has disconnected because the lines do not support the modulation and/or data rate selected.
	No Carrier Disc	The modem disconnects due to the loss of carrier signal from the remote modem.
	DTR Disconnect	The modem has disconnected due to the loss of DTR from the DTE.
	EC Disconnect	The modem has disconnected due to failure to negotiate Error Control mode.
	Inv Rate Disc	When using V.32bis modulation, the remote modem does not support the data rate used by the local modem.
	LnCurrnt Disc	The modem has disconnected due to the loss of line current.
	LongSpace Disc	The modem has disconnected due to the detection of a long space.
	NoData Disc	The modem has disconnected due to a lack of transmitted and received data.
	Disconnecting	The modem has begun the disconnect sequence.
	RmtCmnded Disc	The modem has disconnected due to a V.32 Cleardown received from the remote modem.
	Talk Mode	The modem is in Talk mode.
<b>Firmware Download Result</b>	DownldOnly Mode	A local download of firmware or a remote cloning of firmware has failed. The modem is currently in a Download Only mode in which only another download attempt is possible.
	Frmware Upgrade	A local download of firmware or a remote cloning of firmware was successful.
	RemClone Failed	A remote cloning of firmware has failed. This message appears on the local modem's LCD.

**Table 3-3  
(4 of 4)  
Top-Level Menu Status**

<b>Status</b>	<b>Message</b>	<b>Indicates</b>
<b>Firmware Download Result Cont.</b>	Remote Clone OK	A remote cloning of firmware was successful. This message appears on the local modem's LCD.
	Bcast Clone Done	A broadcast cloning of firmware has completed. You must look under the Control branch for cloning results. This message appears on the local modem's LCD.
<b>AT Command Reset</b>	Reset by AT command	The modem has performed a reset in response to an ATZ command.

Messages listed in Table 3-4 are common operational messages that occur during modem operation. These messages normally appear on the second line of the LCD.

**Table 3-4  
Common Operational Messages**

<b>Common Operational Message</b>	<b>Indicates</b>
Please Wait...	A command to a local device takes more than two seconds to complete.
Command Sent...	A command is sent to a remote modem.
No Rem Response or Remote Modem Fail	A remote modem does not respond to a command within 5 seconds.
Command Complete	A command, issued to a local or remote modem, is completed.
Invalid Command	The modem cannot complete a command.

Messages listed in Table 3-5 are dial access security messages.

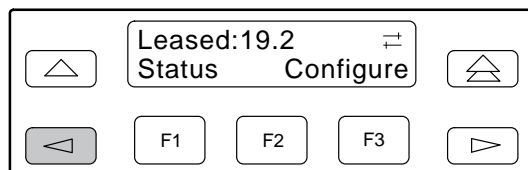
**Table 3-5  
Dial Access Security Messages**

<b>Dial Access Security Message</b>	<b>Indicates</b>
Get VF PsWd	The answering modem is waiting for the originating caller to transmit a VF password.
Get DTE PsWd	The answering modem is waiting to receive a valid DTE password from the remote DTE.
VF PsWd Timeout	The modem did not finish answering a call (disconnected) because the allowed time limit was exceeded before the modem received a VF password from the originating dialer.
Unknown DTEpswd	The modem did not finish answering a call (disconnected) because the DTE passwords received from the remote DTE were invalid.
No Orig PsWd	The modem did not attempt to establish a call as requested because the AT dial command did not contain an originate access password.
Unknown VF PsWd	The modem did not finish answering a call (disconnected) because the modem received an invalid VF password.
DTEpswd Timeout	The modem did not finish answering a call (disconnected) because the allowed time limit was exceeded before the modem received a DTE password from the remote DTE.
Inval Orig PsWd	The modem did not attempt to establish the call as requested because the originate password in the AT dial command was not valid.
DTR Dial Blockd	DTR dialing is not permitted when security is enabled. This message appears if DTR dialing is used and Answer Access or Originate Access security is enabled.
SecurityBlocked	The access verification capabilities are not available and the modem does not pass data to the DTE under any circumstances. This message appears only when the modem is in base mode (a mode that occurs during a firmware download) and Answer Access Security is enabled.

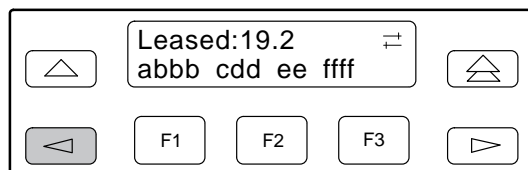
The Top-Level menu's main branches appear on the LCD in the order of Status, Configure, Control, Test, Call Setup, Talk/Data, Security, and Remote. These branches are discussed in this chapter except for the Configure branch which is reserved for Chapter 4, *DCP Configuration*, and the Security branch which is reserved for Chapter 6, *Dial Access Security*.

## Quick Configuration Display

The Quick Configuration display indicates the basic operational characteristics of the modem.



To access the Quick Configuration display from the Top-Level display, press the  $\triangleleft$  key.



The modem's Quick Configuration information appears on the LCD's bottom line.

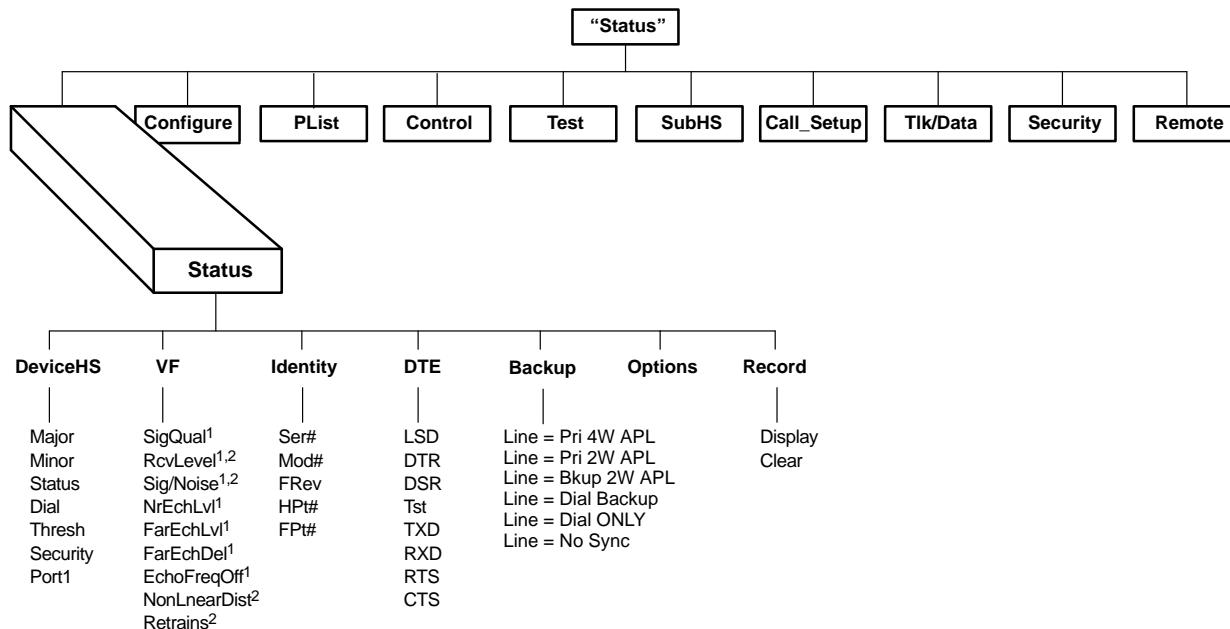
- a            Displays the network position of the modem. The letter **C** indicates this is a control modem, and **T** indicates this is a tributary modem.
- bbb        Displays the network management address of the modem. The valid address field range is from 001 to 256.
- c            Displays the DTE mode. The letter **A** indicates the modem is in Asynchronous mode, and **S** indicates the modem is in Synchronous mode.
- dd         Displays the line mode. The letters **LA** indicate Leased Answer mode, **LO** indicate Leased Originate mode, and **D** indicates Dial mode.
- ee         Displays the modem DTE port that is currently being displayed by the EIA status indicators on the DCP.
  - P1**        indicates Port 1.
  - CC**        indicates Control Channel.
  - DC**        indicates Diagnostic Channel.
- ffff        Displays the modem's modulation scheme as shown below:
  - V32t**     indicates V.32 terbo modulation.
  - V32b**     indicates V.32bis modulation.
  - V32**      indicates V.32 modulation.
  - TMP**     indicates Trellis Multipoint modulation.
  - V22b**     indicates V.22bis modulation.
  - V27b**     indicates V.27bis modulation.
  - V33**      indicates V.33 modulation.
  - V29**      indicates V.29 modulation.
  - V22**      indicates V.22 modulation.
  - V23**      indicates V.23 modulation.
  - V21**      indicates V.21 modulation.
  - 212A**     indicates Bell 212A modulation.
  - 103J**     indicates Bell 103J modulation.

To exit the Quick Configuration function and return to the Top-Level menu, press the  $\triangleright$  ,  $\triangle$  , or  $\triangleleft$  key.



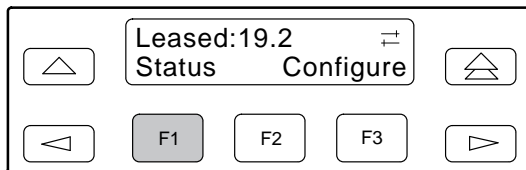
# Status Branch

The Status branch of the Top-Level menu allows you to view the current status of the leased-line or dial connection, the identity (for example, serial number and model number) of your equipment, and the DTE interface.



<sup>1</sup> These parameters appear for V.32 terbo, V.32bis, and V.32 modulations.  
<sup>2</sup> These parameters appear for Trellis Multipoint modulation.

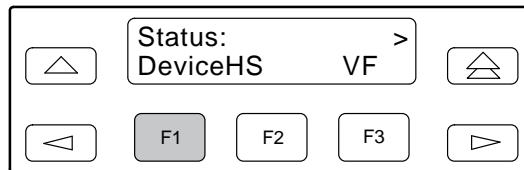
To access Status from the Top-Level menu, select Status.



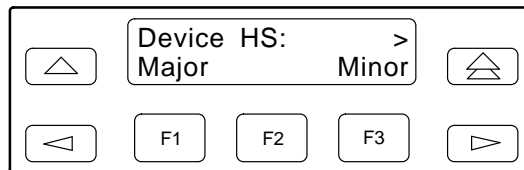
## Device Health and Status (DeviceHS)

DeviceHS provides a “snapshot” of current modem alarms which are active at the time the DeviceHS function is selected.

To access DeviceHS from the Status branch, make the following selection:



Select DeviceHS.



If alarms are present, press the appropriate function key to view the messages associated with these alarms (Table 3-6). If needed, press the  $\triangleright$  key to scroll to additional alarm types. If no alarms are present, the word **Normal** appears on the LCD.

**Table 3-6  
(1 of 2)  
Health and Status Messages**

<b>Type</b>	<b>Message</b>	<b>Indicates</b>
<b>Major</b>	Device Failure	A device/self test has failed. The probable cause is a modem hardware problem or diagnostic memory failure.
	Facility Fault	A severe data transport problem is occurring due to poor line conditions. No signal or a very poor signal is being received.
	Streaming DTE	The modem is in an Antistreaming condition. The RTS input to the modem was held ON for a period exceeding the time selected by the RTS Antistream configuration option. (Refer to the <i>DTE Interface</i> section in Chapter 4 for a description of the RTS Antistream configuration option.)
	Access Security	A dial access security alarm is active. (Refer to the Security section of this table for dial access security conditions.)
<b>Minor</b>	VF Threshold	One or more of the analog parameter thresholds have been exceeded. The probable cause is poor line conditions or improper threshold settings. Thresholds may be set through the DCP or NMS commands.
	DTE Alarm	One or more of the DTE signals are in alarm mode. (Refer to the Port 1 section of this table for Port 1 DTE alarm conditions.)
	Rate Fallback	Due to poor line conditions, the modem's transmit rate is below the configured rate. (Refer to the <i>Leased Line</i> and <i>Dial Line</i> sections in Chapter 4 for a description of configuration options affecting rate.)
<b>Status</b>	Subtree Truncate	Downstream health and status information has been truncated because it overflowed system limits. There is a large amount of health and status information in the subnetwork. This information can be recovered by sending device health and status commands to specific modems.
	Test Mode	The modem or an upstream device is running a disruptive test.
	Disabled	The modem's DTE port has been disabled.
	On Dial Backup	The modem is operating in Dial Backup mode.
	FW Downloading	A firmware download is in progress.
	On Lease Backup	The modem is operating in Lease Backup mode. This status occurs only if the Dual Lease Line is enabled.
	Primary Line Bad	The modem is currently operating on the 2-wire backup facility, the Lease Lookback option is enabled, and the modem does not detect continuity on the primary 4-wire leased lines.
	Backup Line Good	The modem is currently operating on the primary 4-wire leased facility with 2-wire leased lines selected as the backup facility, the Backup Line Check option is enabled, and the modem detects continuity on the 2-wire backup leased lines.
	Data Blocked	The modem's primary data path is blocked.
	PSTN Test Fail	The modem failed either the Dial Tone Detection or the Ring Tone Detection portion of the Call Test command.

**Table 3-6  
(2 of 2)  
Health and Status Messages**

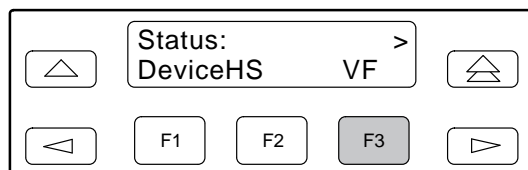
Type	Message	Indicates
<b>Dial</b>	Make Busy Mode	The modem is in a Make Busy condition.
	Service Line	(Model 3911 only) The modem installed in a COMSPHERE 3000 Series Carrier has been switched to a service line.
	Short Hold Time	The modem's dial hold time has been shortened.
	Non-Answering	The modem is in a non-answering mode.
<b>Thresh*</b>	RSL High Threshd	The received signal level (RSL) has exceeded the upper threshold.
	RSL Low Threshld	The RSL is less than the lower threshold.
	SNR Threshold	The signal-to-noise ratio has exceeded the threshold.
	Non-linear Dist	The non-linear distortion has exceeded the threshold.
	Retrains	The number of retrains has exceeded the threshold.
	Signal Quality	The signal quality is less than the threshold.
	Far Echo Threshd	The far end echo level has exceeded the threshold.
	Near Echo Thresh	The near end echo level has exceeded the threshold.
<b>Security</b>	Database Reset	The security database has been reset (passwords erased).
	Password Protect	Security password protection has been enabled.
	Mode Change	There has been a change in security mode. (Refer to Chapter 6, <i>Dial Access Security</i> .)
	Password Change	A security password has been changed.
	Database Change	The security database containing passwords has been changed.
<b>Port 1</b>	Rx Data Alarm	The DTE port's RXD signal is in an alarm condition.
	Tx Data Alarm	The DTE port's TXD signal is in an alarm condition.
	DTR Alarm	The DTE port's DTR signal is in an alarm condition.
	CTS Alarm	The DTE port's CTS signal is in an alarm condition.
	RTS Alarm	The DTE port's RTS signal is in an alarm condition.
	DSR Alarm	The DTE port's DSR signal is in an alarm condition.
	LSD Alarm	The DTE port's LSD signal is in an alarm condition.
	Auto Stream Dis	The modem is in an Antistreaming condition. (Refer to the Streaming DTE message in the Major Alarm section of this table.)
	Disabled	The modem's DTE port has been disabled.
*Not supported in every modulation.		

To exit DeviceHS and remain in the Status Branch, press the  $\triangle$  key. To exit and return to the Top-Level menu, press the  $\triangleleft$  key.

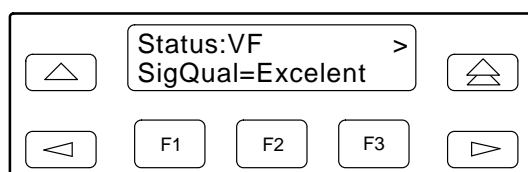
## VF

VF displays the condition of the leased or dial connection.

To access VF from the Status branch, make the following selection:



Select VF.



If the modem is receiving a signal, the signal quality appears on the LCD's bottom line. Press the  $\triangleright$  key to scroll and view the receive signal level, signal-to-noise ratio, near end echo level, far end echo level, far end echo delay, and echo frequency offset. If the modem is not receiving a signal, the message **No Signal** appears on the LCD.

<b>SigQual</b>	Signal Quality displays the condition of the VF line. Possible values are <i>Excelent</i> (Excellent), <i>Good</i> , <i>Fair</i> , <i>Poor</i> , or <i>No Signal</i> . These values appear for V.32 terbo, V.32bis, and V.32 modulations.
<b>RcvLevel</b>	Receive Signal Level displays, in decibels referenced to one milliwatt (dBm), the actual strength of the incoming signal. This value appears for V.32 terbo, V.32bis, V.32, and Trellis Multipoint modulations.
<b>Sig/Noise</b>	Signal-to-Noise Ratio displays, in decibels, the receive signal strength relative to noise on the line. This value appears for V.32 terbo, V.32bis, V.32, and Trellis Multipoint modulations.
<b>NrEchLvl</b>	Near End Echo Level displays the signal level, in decibels referenced to one milliwatt (dBm), of that portion of the transmit signal which has been echoed back by the local line termination. This value appears for V.32 terbo, V.32bis, and V.32 modulations.
<b>FarEchLvl</b>	Far End Echo Level displays the signal level, in decibels referenced to one milliwatt (dBm), of that portion of the transmit signal which has been echoed back by the remote line termination. This value appears for V.32 terbo, V.32bis, and V.32 modulations.
<b>FarEchDel</b>	Far End Echo Delay displays the roundtrip delay in milliseconds of the far end echo. This value appears for V.32 terbo, V.32bis, and V.32 modulations.
<b>EchoFreqOff</b>	Echo Frequency Offset displays the frequency offset of the far end echo. This value appears for V.32 terbo, V.32bis, and V.32 modulations.

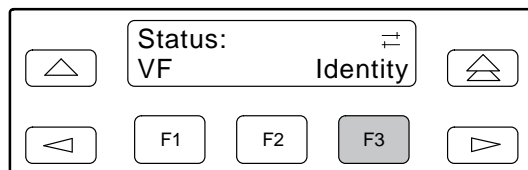
- NonLnearDist** Non-Linear Distortion displays distortion which is usually associated with pulse-code modulation (PCM) compandor noise on the phone line. This value appears for Trellis Multipoint modulation.
- Retrains** Retrains displays the number of retrains over the last 15 minutes of operation. The total 15-minute accumulation is updated every minute. This value appears for Trellis Multipoint modulation.

To exit VF and remain in the Status Branch, press the  $\triangle$  key. To exit and return to the Top-Level menu, press the  $\triangle$  key.

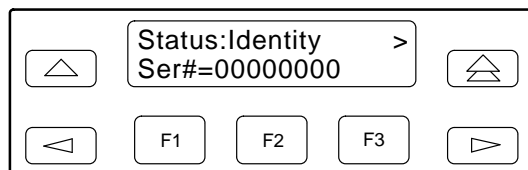
## Identity

Identity displays the modem's serial number, model number, firmware revision level, hardware revision number and firmware part number. Retrieval of this information is useful if you are purchasing additional or replacement modems and/or making firmware upgrades.

To access Identity from the Status branch, make the following selection:



Press the  $\triangleright$  key until Identity appears. Select Identity.



The modem's serial number appears on the LCD's bottom line. Press the  $\triangleright$  key to scroll and view the model number, firmware revision level, hardware part number, and firmware part number.

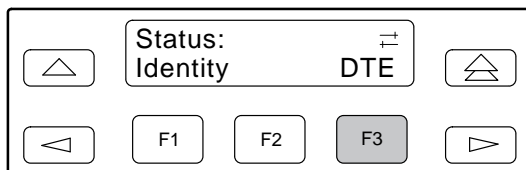
- Ser #** Serial number is an 8-digit number that identifies the modem.
- Mod #** Model number is an alphanumeric number that identifies the modem as either a Model 3910 or Model 3911 modem.
- FRev** Firmware revision level is an alphanumeric number that identifies the level of firmware loaded in the modem.
- HPt #** Hardware part number is an 11-digit number that identifies the circuit card in the modem.
- FPt #** Firmware part number is an 11-digit number that identifies to customer service personnel the firmware release number.

To exit the Identity function and remain in the Status branch, press the  $\triangle$  key. To exit and return to the Top-Level menu, press the  $\triangle$  key.

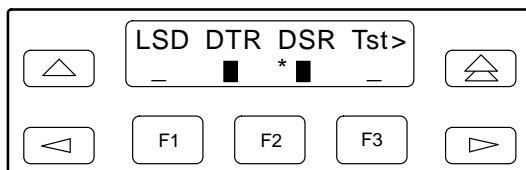
## DTE

DTE displays the state and/or activity of the following interface leads: LSD, DTR, DSR, Tst, TXD, RXD, RTS, and CTS. The interface leads status is updated every 5 seconds.

To access DTE from the Status branch, make the following selections:



Press the  $\triangleright$  key until DTE appears. Select DTE.



The activity and state of the modem's DTE signal appear on the LCD's bottom line. Press the  $\triangleright$  key to scroll other signals into view.

The LCD's bottom line displays a pair of symbols for each interface lead. The first symbol indicates the signal's activity since entering the DTE status display. An \* (asterisk) indicates at least one transition while a blank space indicates no transitions.

The second symbol indicates the state of the interface lead at the sampling time. A ■ (solid block) indicates a Space or ON condition while an underscore ( \_ ) indicates a Mark or OFF condition.

To exit this function and remain in the Status branch, press the  $\triangle$  key. To exit and return to the Top-Level menu, press the  $\triangle$  key.

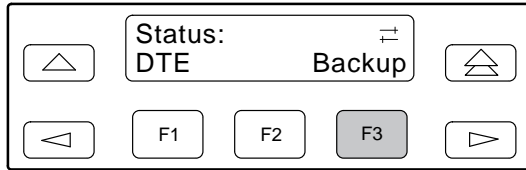
## Backup

The Status Backup function displays the configuration of the modem's current operating line facility and the configuration and condition of the inactive line.

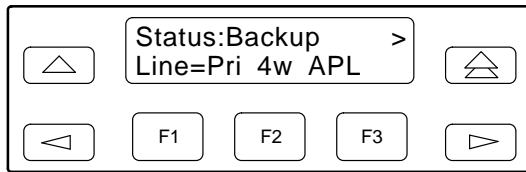
### NOTE

The modem's rear panel has two line interface jacks: LEASE and DIAL (see Figure 2-1 in Chapter 2). The jack labeled LEASE is the APL primary interface and accepts either 2-wire or 4-wire APL. The jack labeled DIAL is the backup interface and accepts either 2-wire APL (Dual Lease Line) or Dial lines.

To access Backup from the Status branch, make the following selection:  
 Press the  $\triangleright$  key until Backup appears.

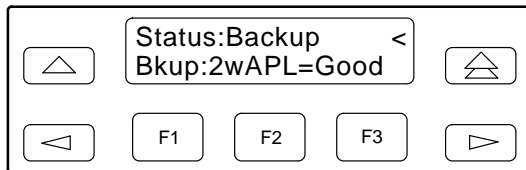


Select Backup.



The configuration of the current operating line facility (either APL primary or backup) appears (Refer to Table 3-7).

Press the  $\triangleright$  key to display the next screen.



This screen displays the configuration and condition of the inactive line facility (either APL primary or backup).

There are four condition codes, **Good**, **Bad**, **????**, and ' ' (blank).

Table 3-7 provides information about the Status Backup screens. The first column lists all possible configurations for the modem's currently active line. The second column lists all possible configurations for the modem's inactive lines. The third column provides information about the inactive line condition.

XXXX represents the condition code of the inactive line.



**Table 3-7  
Backup Status Screens**

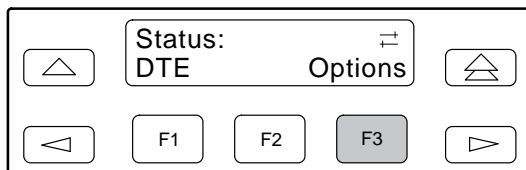
Active Line 1st Screen Display	Inactive Line 2nd Screen Display	Possible Inactive/Backup Line Condition
Line=Pri 4w APL or Line=Pri 2w APL	Bckup:2wAPL=XXXX or Bckup : Dial =(blank)	<b>Good</b> indicates that line continuity is detected. <b>Bad</b> indicates that line continuity is not detected. <b>????</b> indicates that the line condition is unknown (Backup Facility Check is making its first determination of the line conditions since the last retrain). <b>blank</b> indicates that the Backup Line Check option is disabled.
Line=Bkup 2w APL or Line = Dial Backup	Pri 4w APL =XXXX or Pri 2w APL =XXXX	<b>Good</b> indicates the line condition is good. <b>Bad</b> indicates the line condition is bad. <b>????</b> indicates the line condition is unknown (Lease Lookback has not had enough time to make an initial appraisal of the line conditions since the last retrain). <b>blank</b> indicates the Lease Lookback option is disabled.
Line=Dial Only	No second screen display.	<b>NOTE:</b> When the modem is configured for Dial Only, there is no backup. <b>NOTE:</b> The leased-line interface is disabled when the factory default options are loaded from the Async Dial, Sync Dial, or UNIX Dial templates.
Line=No Sync	No second screen display.	<b>NOTE:</b> No Sync appears when the modem is not trained on either the primary or backup line facility.

To exit this function and remain in the Status branch, press the  $\triangle$  key. To exit and return to the Top-Level menu, press the  $\triangleleft$  key.

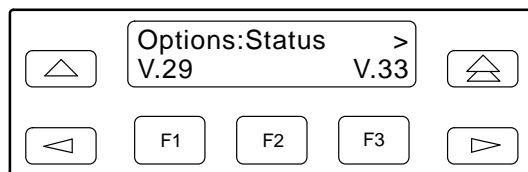
## Options

The Options Status function displays all optional firmware features currently installed in the modem. If no firmware options are installed, **None\_Installed** appears on the LCD.

To access Options from the Status branch, make the following sections:



Press the  $\triangleright$  key until Options appears. Select Options.



If optional features are installed in the modem, they appear on the LCD's bottom line. If other features are installed, press the  $\triangleright$  key to scroll other features into view.

To exit this function and remain in the Status branch, press the  $\triangle$  key. To exit and return to the Top-Level menu, press the  $\triangle$  key.

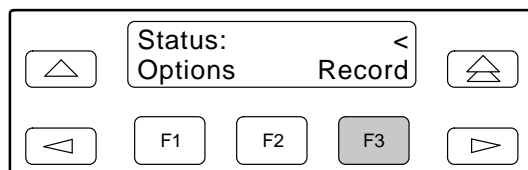
## Record

Record is a troubleshooting tool used by the end user in conjunction with support personnel. This function allows the end user to retrieve and report any sequence faults to support personnel. A sequence fault is an irregular or unexpected event.

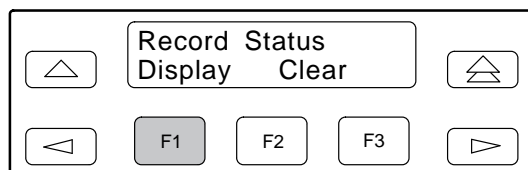
There are two selections under Record: Display and Clear. Display allows up to eight sequence fault messages that have been recorded by the modem to be displayed on the LCD. If no sequence faults have occurred, then **Modem O.K.** appears.

Clear is used to remove all sequence fault messages from nonvolatile memory and the LCD.

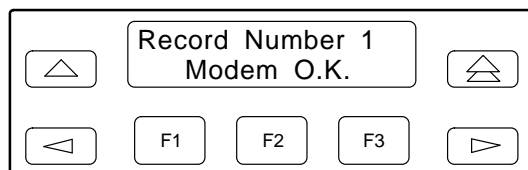
To access Record from the Status branch, make the following selections:



Press the  $\triangleright$  key until Record appears. Select Record.



To display sequence faults, select Display.



The LCD displays the first sequence fault field. (Sequence fault fields range from 1 to 8 and are identified by a number in the upper right corner.) Press the  $\triangleright$  key to view the remaining fields. The message **Modem O.K.** appears if no sequence faults have occurred.

To remove sequence fault records from both the LCD and nonvolatile memory, select Clear. The message **Modem O.K.** appears.

To exit this function and remain in the Status branch, press the  $\triangle$  key. To exit and return to the Top-Level menu, press the  $\triangleleft$  key.

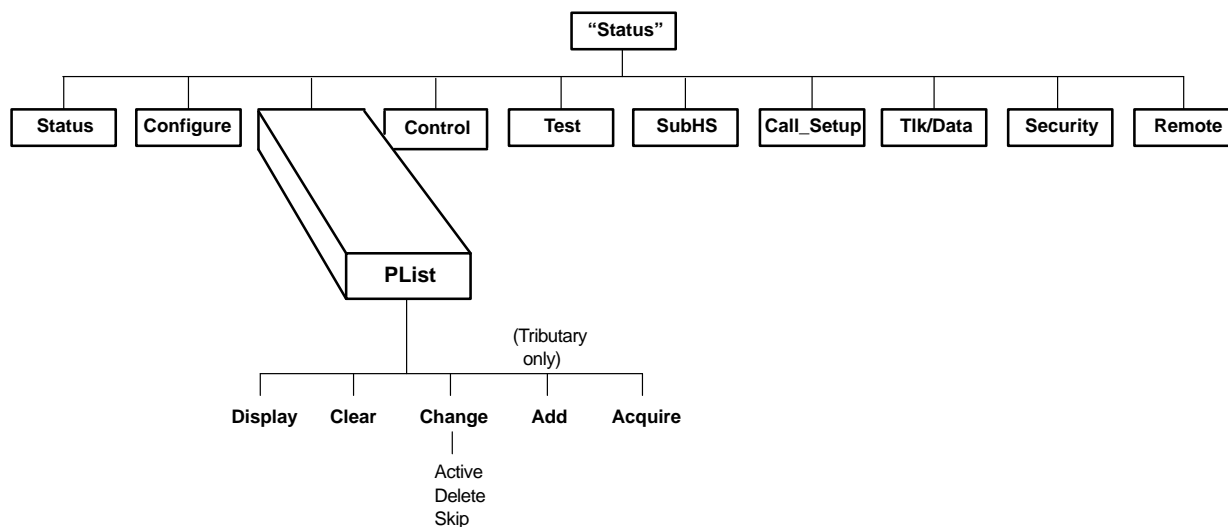
## Configure Branch

The Configure branch of the LCD allows you to change and save the modem's configuration options. For configuration options and DCP configuration procedures, refer to Chapter 4, *DCP Configuration*.

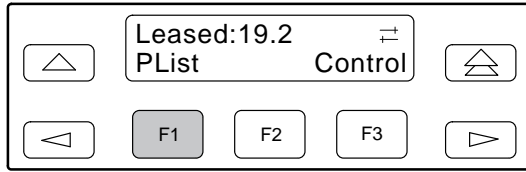
## Poll List Branch

**The Poll List function is not available on Point-to-Point control modems or Multipoint Tributary modems..**

The Poll List (Plist) branch of the Top-Level menu allows you to identify downstream modems in order to support health and status polling and download broadcasting. The maximum number of devices is 32 on the secondary channel and 64 on the diagnostic channel.



To access PList from the Top-Level menu, make the following selections:



Press the  $\triangleright$  key until PList appears. Select PList.

Within a network link, a control modem can communicate with a tributary modem by using the tributary modem's network management address for polling functions. Each tributary modem must have a different network management address. Refer to the *Misc* section in Chapter 4 for a description of the network management address (NetMngmtAddress) configuration option.

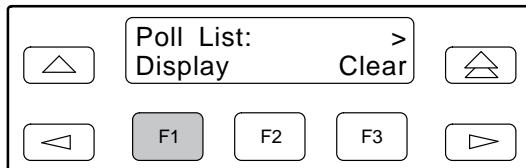
Over a diagnostic channel a tributary modem can communicate with control modems by using the control modem's network management address for polling functions.

In the poll list, modems may be listed as either Active or Skip. Modems in the Active poll list are polled by the upstream modem. Modems in the Skip poll list are passed over during the polling process, but they are not deleted from the poll list.

## Display

Display allows you to view the modem's poll list.

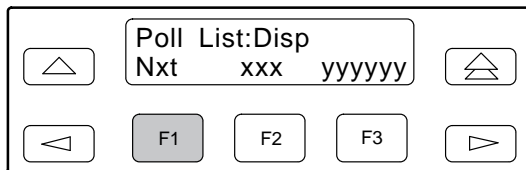
To access Display from the PList branch, make the following selection:



Select Display.

**NOTE**

If there are no modems in the poll list when you select Display, the message **Poll List Empty!** appears on the second line of the LCD.



If there are modems in the poll list when you select Display,

- xxx        Displays the network management address of the modem in the poll list.
- yyyyyy    Displays either Active or Skip to indicate the poll list in which the network management address is included.

Select Nxt to scroll through the entries in the Active or Skip poll lists.

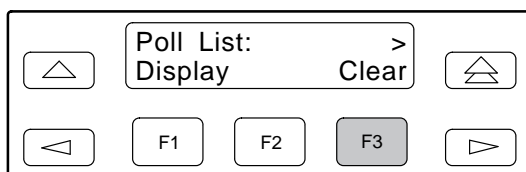
To exit this function and remain in the PList Display branch, press the  $\triangle$  key. To exit and return to the Top-Level menu, press the  $\triangle$  key.

## Clear

**The Clear function does not appear in Remote mode.**

Clear deletes the modem's poll list.

To access Clear from the PList branch, make the following selection:



Select Clear.

The message **Command Complete** appears on the second line of the LCD to indicate that the poll list has been cleared.

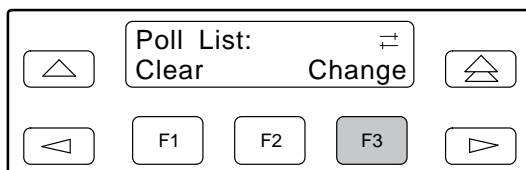
To exit this function and remain in the PList branch, press the  $\triangle$  key. To exit and return to the Top-Level menu, press the  $\triangle$  key.

## Change

**The Change function does not appear in Remote.**

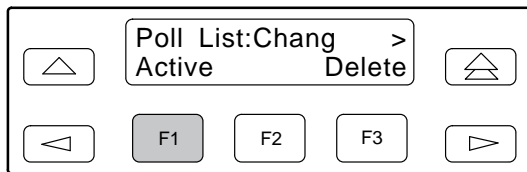
Change allows you to change the modem's poll list.

To access Change from the PList branch, make the following selections:



Press the  $\triangleright$  key until Change appears. Select Change.

Change allows you to add modems to the Active poll list (Active), delete modems from both Active and Skip poll lists (Delete), and move modems from the Active to the Skip poll list.



To implement Change, select the appropriate function (Active, Delete, or Skip). (For Skip, you will need to press the > key until Skip appears.)



The function field (yyyyyy) displays the function you selected (Active, Delete, or Skip).

The address field (xxx) displays the network management address of the modem to be changed. The valid address field range is from 001 to 256.

To increment digits within the address field (xxx), use the < and > keys to position the cursor ( \_ ) under the digit that will be incremented. Press the F2 (↑) key to increment the digit.

Press Enter (Ent) to implement the function (yyyyyy) you selected (Active, Delete, or Skip). The message **Command Complete** appears on the second line of the LCD to indicate that the poll list change has occurred. If the message **Poll List Check** appears, you have attempted to delete an address that was not on the poll list, or you have attempted to add an address that was already on the poll list. If the message **Poll List Error** appears, you are in a point-to-point mode that does not support secondary channel (V.29). If the message **Poll Lst too Big** appears, you have entered a number greater than the maximum number of downstream devices. To return to the selected function (Active, Delete, or Skip), press the △ key. The address automatically increments upon returning to this function.

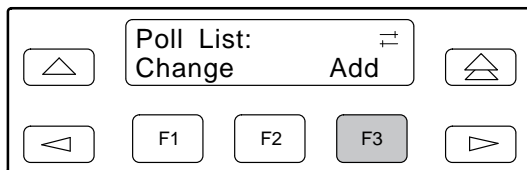
To exit this function (Active, Delete, or Skip) and remain in the PList Change branch, press the △ key. To exit and return to the Top-Level menu, press the ≡ key.

## Add

**The Add function does not appear in Remote mode or on control modems.**

Add allows you to add the tributary modem to a control modem's poll list. This function should be initiated from only one tributary modem at a time.

To access Add from the Plist branch, make the following selections:



Press the > key until Add appears. Select Add.



The message **Command Complete** appears on the LCD to indicate that the tributary modem will be added to the control modem's poll list.

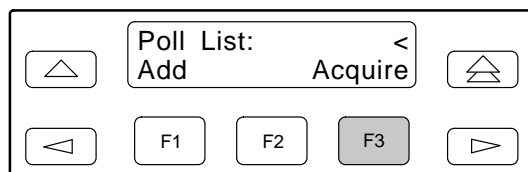
To exit this function and remain in the PList branch, press the  $\triangle$  key. To exit and return to the Top-Level menu, press the  $\triangle$  key.

## Acquire

**The Acquire function does not appear in Remote mode.**

Acquire allows you to acquire an active poll list consisting of all modems that are one tier downstream. A modem will add to its poll list all downstream devices that respond to a poll.

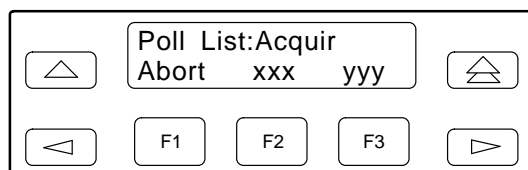
To access Acquire from the Plist branch, make the following selections:



Press the  $\triangleright$  key until Acquire appears. Select Acquire.

### NOTE

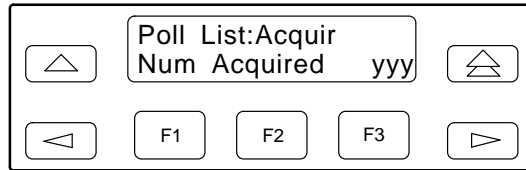
If an error message (**OtherTestActive** or **Unable To Acquir**) appears on the second line of the LCD, move up one level in the menu tree to clear the message and return to the PList Acquire branch. The **OtherTestActive** message indicates that a test is running which blocks the Acquire function. The **Unable To Acquir** message indicates that the diagnostic network is in a busy state.



The address field (xxx) increments sequentially from 001 to 256 as polls are transmitted from the modem to the downstream modem(s). To be added to the modem's poll list, the device must respond to a poll after receiving its address. The Acquire function can be canceled by selecting Abort.

The number field (yyy) indicates the total number of devices that responded to the modem's polls. These devices have been acquired for the poll list.

Select Abort or allow the function to complete.

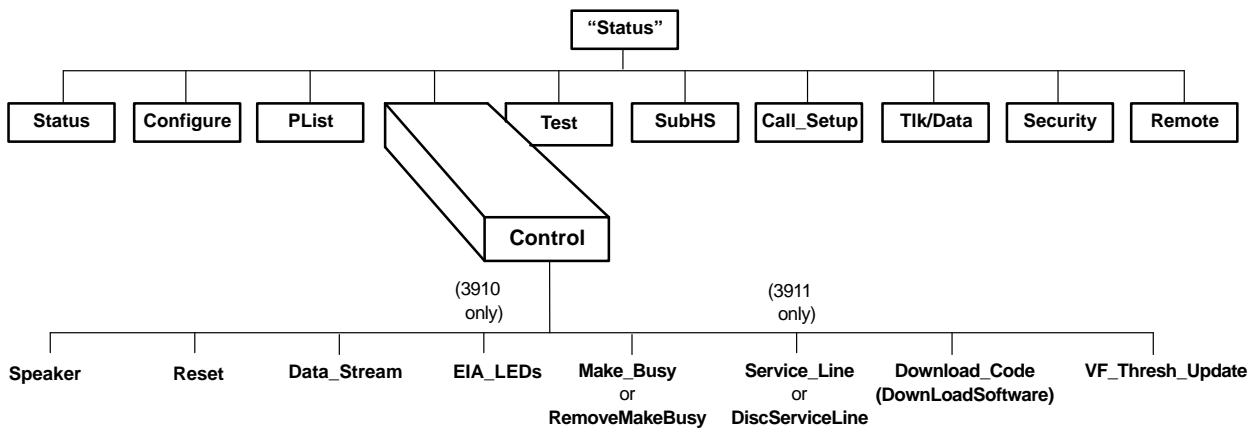


The number field (yyy) indicates the total number of devices acquired for the poll list.

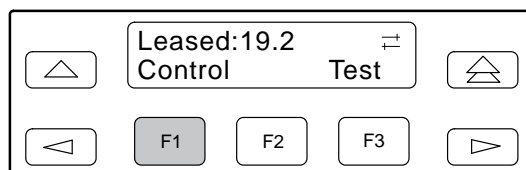
To exit this function and remain in the PList branch, press the  $\triangle$  key. To exit and return to the Top-Level menu, press the  $\triangle$  key.

## Control Branch

The Control branch of the Top-Level menu allows you to manage hardware and software functions, such as speaker volume, reset, busy out, and firmware download.



To access Control from the Top-Level menu, make the following selections:



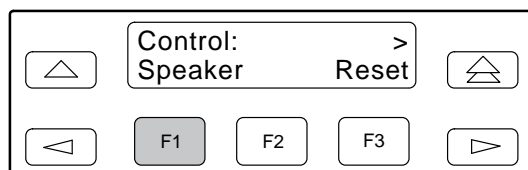
Press the  $\triangleright$  key until Control appears. Select Control.



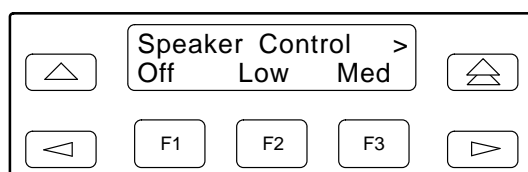
## Speaker

Speaker allows you to make temporary adjustments to the modem's speaker volume. Upon a reset, speaker volume returns to its configured setting. For more information on speaker settings, refer to the *Misc* section in Chapter 4.

To access Speaker from the Control branch, make the following selection:



Select Speaker.



Press the  $\triangleright$  key and appropriate function keys to choose the desired selection.

DCP selections are

- Off**            Turns the speaker off.
- Low**           Adjusts the speaker to low volume.
- Med**           Adjusts the speaker to medium volume.
- High**          Adjusts the speaker to high volume.

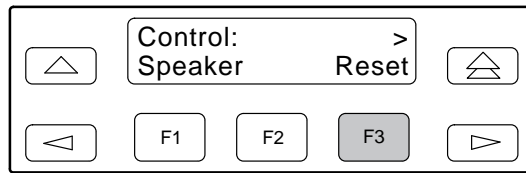
The message **Command Complete** appears on the LCD.

To exit Speaker and remain in the Control branch, press the  $\triangle$  key. To exit and return to the Top-Level menu, press the  $\triangle$  key.

## Reset

Reset causes the modem to stop operation and perform a complete program restart. The modem begins the power-up test sequence that ends with the Top-Level menu displayed on the LCD. Configuration options stored in an Active (Saved) configuration area are copied to the Active (Operating) configuration area.

To access Reset from the Control branch, make the following selection:



Select Reset.

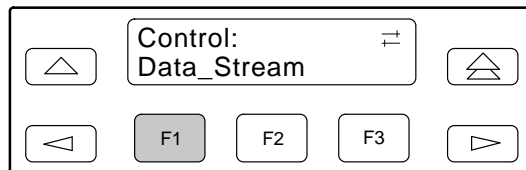
The message **Reset** appears momentarily before the modem performs the power-up diagnostic test sequence.

## Data Stream

**The Data Stream function is not available in Async mode.**

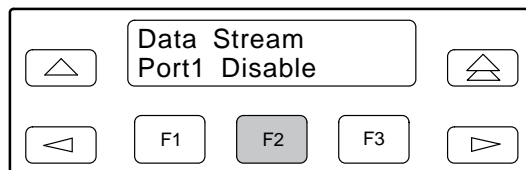
Use Data Stream to enable or disable the modem's data transmitter function.

To access Data Stream from the Control branch, make the following selections:

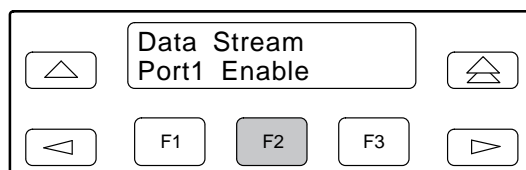


Press the  $\triangleright$  key until Data\_Stream appears. Select Data\_Stream.

The Data Stream action which is available (Disable or Enable) appears on the second line of the LCD beside the word **Port1**. If the modem's data transmitter is enabled, the word **Disable** appears to indicate that you may disable the data transmitter by selecting this action.



If you want to disable the modem's data stream, press the F2 key. When the message **Command Complete** appears, press the  $\triangle$  key to clear the message.



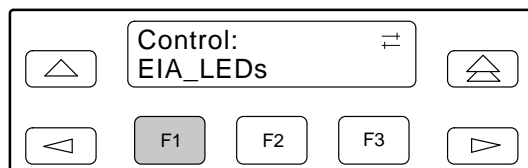
Press the F2 key again to enable the modem's data stream.

To exit this function and remain in the Control branch, press the  $\triangle$  key. To exit and return to the Top-Level menu, press the  $\triangle$  key.

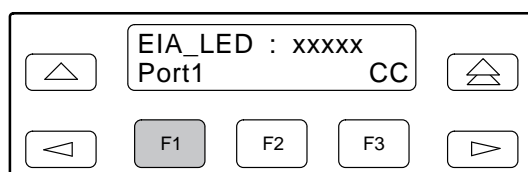
## EIA LEDs

Use the EIA LEDs function to change the port that controls the front panel LEDs. This function allows the front panel EIA LEDs to display the activity of a selected digital interface.

To access EIA LEDs from the Control branch, make the following selections:



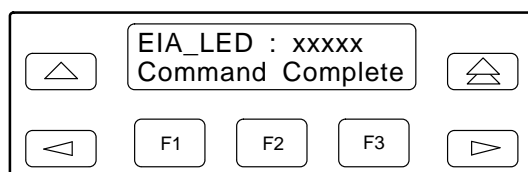
Press the  $\triangleright$  key until EIA\_LEDs appears. Select EIA\_LEDs.



Press the F1 key until the appropriate digital interface appears.

The xxxxx field displays the currently selected interface. The valid interfaces are Port1, and depending on the configuration option, either CC (NMS Control Channel), or DC (Diagnostic Channel). Refer to the section *Miscellaneous Configuration Options, Diag Connection* in Chapter 4.

Select the appropriate interface by pressing the corresponding function key.



After selecting the desired interface, the message **Command Complete** appears on the bottom line of the LCD and the selected interface appears in the xxxxx field.

To exit this function and remain in the Control branch, press the  $\triangle$  key. To exit and return to the Top-Level menu, press the  $\triangle$  key.

### NOTE

The Port1 interface is the only display allowed on the 3911 modem, therefore, the entire EIA LEDs branch is masked.

## Make Busy/Remove Make Busy

The Make Busy function forces the modem off-hook so it cannot answer a call. This is often used with PBX systems to permit the busy out of a PBX port for rotary or hunt groups.

### WARNING

**To prevent violations of FCC and DOC regulations, this function must only be used behind a user's PBX.**

To access Make Busy from the Control branch, make the following selections:

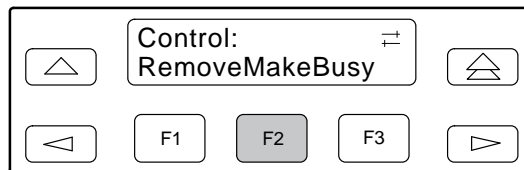


Press the  $\triangleright$  key until Make\_Busy appears. Select Make Busy.



The modem is now in a forced busy condition. **Command Complete** appears on the LCD.

To remove the modem from Make Busy mode, press the  $\triangleleft$  key once and the  $\triangleright$  key until **RemoveMakeBusy** appears.



Press any function key to select RemoveMakeBusy. The message **Command Complete** appears on the LCD.

## Service Line/Disconnect Service Line

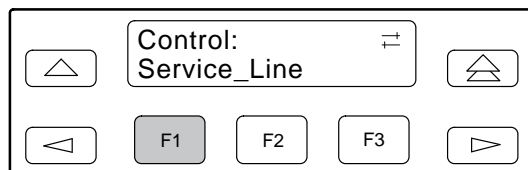
The Service Line function allows you to switch a specific Model 3911 installed in a COMSPHERE 3000 Series Carrier from normal leased or dial operation to service-line operation. This switch only places the modem on the service line. For a connection to be established, you must still use the normal dialing methods as described earlier in this chapter in the *Call Setup Branch* section.

A service line is an extra dial line connected to a COMSPHERE 3000 Series Carrier. This line is normally shared by up to eight Model 3911 modems installed in either Slots 1–8 or Slots 9–16.

However, by daisy chaining the service-line connector of one Network Interface Module (NIM) to the service line of another NIM installed in the same carrier, you can permit all 16 modems to share one service line. The service line can also be extended to other carriers in a cabinet. For more information regarding daisy chaining of modems to the service line, refer to the *COMSPHERE 3000 Series Carrier, Installation Manual*.

A service line is ideal for a dial backup of Model 3911 modems operating on leased lines. Remember that a service line can back up only one failed leased line at a time.

To enable Service Line from the Control branch, make the following selections:



Press the  $\triangleright$  key until `Service_Line` appears. Select `Service_Line` to switch the modem from its normal dial line to the service line. Now, when the modem places a call, instead of using the dial line, the call is placed on the service line.

To disconnect the modem from the service line and resume normal operation, press the  $\triangle$  key once and the  $\triangleright$  key until `DiscServiceLine` appears.

Select `DiscServiceLine`. The call and service line disconnect and the message **Command Complete** appears on the LCD.

## Download Software

The Download Software function sets parameters within the modem when transferring firmware to one or more modems or when receiving firmware upgrades from a locally attached PC-based controller. The latter is only performed by customer service personnel.

There are two selections under Download Software: Clone Remote and To Local via DTE. Clone Remote is used to transfer an exact copy of the firmware currently stored in a 391x Series modem to either one or more remote 391x Series modems or one or more DC-attached 391x Series modems. Remote modems must be connected to the local modem via a leased-line network or an established dial-line network. If these prerequisites do not exist, Clone Remote will not appear on the LCD.

The second selection appearing on the LCD is To Local via DTE. This function permits firmware upgrades to be transferred to a 391x Series modem. This type of download requires a locally attached PC controller to be connected to the modem's DTE port as well as special download software. **Any downloads using this selection are intended to be performed by customer service personnel only.**

## Selecting Clone Remote

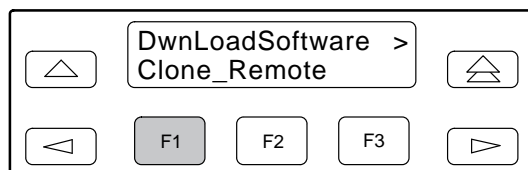
### NOTE

Clone Remote operations are **not** supported unless both local and remote modems are 391x Series modems. (The 3800 or 392x Series modems cannot be used in cloning operations with 391x Series modems.)

To access DwnLoadSoftware from the Control branch, make the following selections:



Press the  $\triangleright$  key until Download\_Code appears. Press any function key to select Download\_Code. The DwnLoadSoftware screen appears.



Press any function key to select Clone\_Remote.

The next screen to appear is determined by the modem's configuration. Refer to the appropriate section (Point-to-Point, Broadcast, or Multipoint).

## Clone Remote in Point-to-Point Configurations

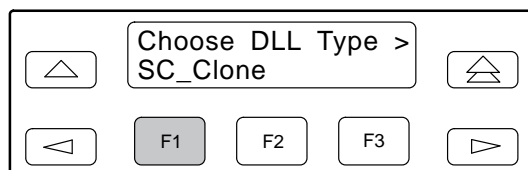
Before using Clone Remote in point-to-point configurations, perform the following:

- Make sure the 391x Series modems have an established leased-line connection using either V.33, V.32 terbo, V.32bis, V.32, or V.29 modulation (refer to the *Leased Line* section in Chapter 4) or a dial network connection using either V.32 terbo, V.32bis or V.32 modulation (refer to the *Dial Line* section in Chapter 4).
- Make sure the remote modem's Access From Remote configuration option is enabled (refer to the *Misc* section in Chapter 4).
- Make sure the password (Remote Access Password configuration option) is the same in both the local and remote modems. (For an example of how to change the password, refer to the *Editing and Saving a Configuration Option* section in Chapter 4.)

After completing these checks, proceed to the section titled *Implementing a Clone Remote Operation*, which follows the descriptions of multipoint cloning operations.

### Clone Remote in Broadcast Configurations

A tributary modem configured for extended diagnostics (Diagnostic Connection configuration option set to Modem(DC)) can perform two types of Remote Clone operations. It can clone the upstream, VF connected, control modem (SC\_Clone) or it can clone all the 391x modems attached to its downstream Diagnostic Channel (DC\_Broadcast).

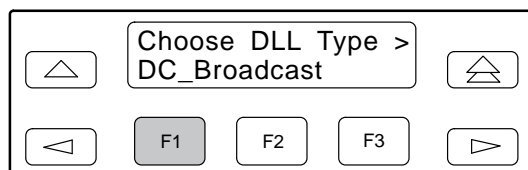


From the Choose DLL Type screen, press the F1 key to select SC\_Clone to request the transfer of an exact copy of the tributary modem's firmware to the VF connected control modem.

Proceed to the section titled *Implementing a Clone Remote Operation*, which follows the descriptions of multipoint cloning operations.

### Cloning DC Broadcast Remote

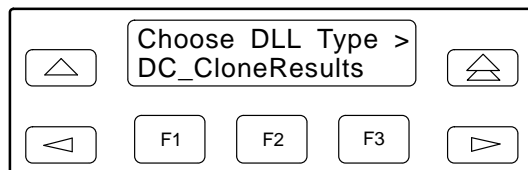
Before using Clone Remote in DC Broadcast configurations, make sure the tributary modem's active poll list contains all the network management addresses for the control modems that receive the download (refer to the *Poll List* section in this chapter), and ensure that the control modems are responding properly to polls (refer to the *Sub-Network Health and Status Branch* sections in this chapter).



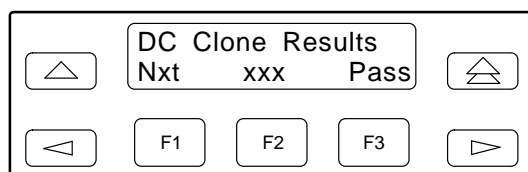
From the Choose DLL Type screen, press the  $\triangleright$  key until DC\_Broadcast appears. Press F1 or F2 to transfer an exact copy of the tributary modem's firmware to the DC-connected control modem(s) using the Active Poll list.

Proceed to the section titled *Implementing a Clone Remote Operation*, which follows the descriptions of multipoint cloning operations.

## Viewing DC Broadcast Clone Results



From the Choose DLL Type screen, press the  $\triangleright$  key until DC\_CloneResults appears to view the results of the last DC\_Broadcast clone operation. If the message **Trib List Empty** appears, this indicates that a multiple download was never initiated.



The address field (xxx) displays the network management address of one of the remote modems. Pressing the F1 key allows you to select various remote modems to determine the download result for those modems (Pass or Fail).

*Clone Remote in Multipoint Configurations*

A Trellis Multipoint (TMp) control modem can be used to download firmware to just one tributary modem (**Single**) or to all of its tributary modems (**Multiple**).

**NOTE**

A Trellis Multipoint (TMp) tributary modem cannot download firmware to its control modem. To download firmware to a TMp control modem use a point-to-point dial connection, an NMS, or a PC controller.

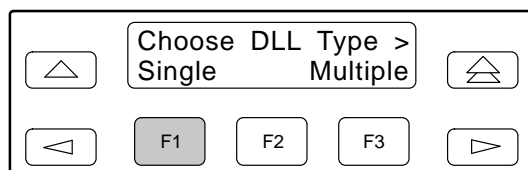
Before using Clone Remote in multipoint configurations (**Single** or **Multiple**), perform the following:

- Make sure the 391x Series modems have an established leased-line connection using the Trellis Multipoint (TMp) modulation (refer to the *Leased Line* section in Chapter 4).
- Make sure the remote modem's Access From Remote configuration option is enabled (refer to the *Misc* section in Chapter 4).
- For **Single** download configurations, know the remote access password and the network management address of the remote tributary modem that will receive the download. Refer to the *Misc* section in Chapter 4 for a description of the remote access password (RemAccsPasswrd) configuration option and the network management address (NetMngmtAddress) configuration option.

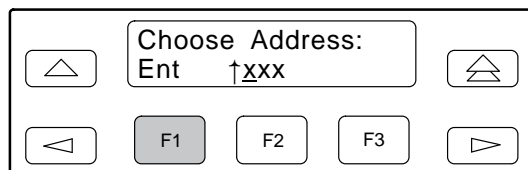


- For **Multiple** download configurations, ensure that the control modem's active poll list contains all the network management addresses for the remote tributary modems that will receive the download (refer to the *Poll List* section in this chapter), and ensure that the tributaries are responding properly to polls (refer to the *Sub-Network Health and Status Branch* section in this chapter).

### Cloning a Single TMp Remote



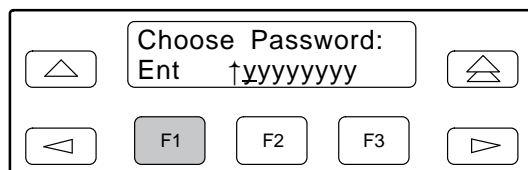
Press the F1 key to select Single Clone Remote.



The address field (xxx) displays the network management address of the modem that will receive the download. The valid address field range is from 001 to 256.

To increment digits within the address field (xxx), use the ◀ and ▶ keys to position the cursor ( \_ ) under the digit that will be incremented. Press the F2 (↑) key to increment the digit.

Press Enter (Ent) to select the modem that will receive the download.



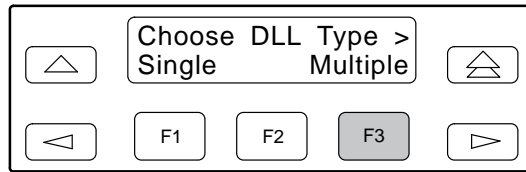
The password field (yyyyyyy) displays the remote access password for the modem that will receive the download.

To increment digits within the password field (yyyyyyy), use the ◀ and ▶ keys to position the cursor ( \_ ) under the digit that will be incremented. Press the F2 (↑) key to increment the digit.

Press Enter (Ent) to select the modem that will receive the download.

After completing these actions, proceed to the section titled *Implementing a Clone Remote Operation*.

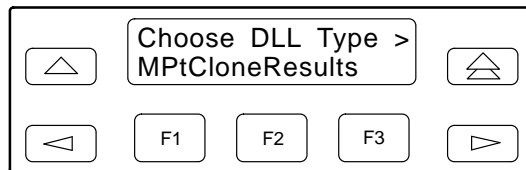
## Cloning a Multiple Tmp Remote



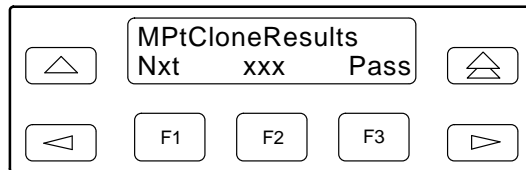
Press the F3 key to select Multiple Clone Remote.

After completing this action, proceed to the next section, *Implementing a Clone Remote Operation*.

## Viewing Multiple Tmp Clone Results



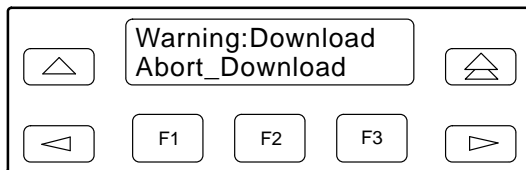
From the Choose DLL Type screen, press the  $\triangleright$  key until the MPtCloneResults screen appears to view the results of the last multiple Tmp clone operation. If the message **Trib List Empty** appears, this indicates that a multiple download was never initiated.



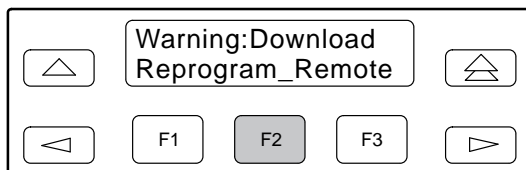
The address field (xxx) displays the network management address of one of the remote modems. Pressing the F1 key allows you to select various remote modems to determine the download result for those modems (Pass or Fail).

*Implementing a Clone Remote Operation***WARNING**

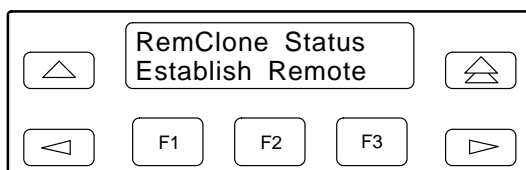
**The modem begins a transfer of its own program to the remote modem. This process takes the communication link out-of-service for several minutes depending on the data rate of the link. If the Clone Remote process is started and then interrupted, the remote modem is left in a partially programmed state in which its functional capabilities are limited to those required to initiate and complete another download attempt.**



At this point, if you do not want to continue this process, abort the transfer by selecting any function key. This returns the modem to the DwnLoadSoftware menu. However, to continue with the transfer, press the  $\triangleright$  key to display the Reprogram\_Remote selection.



Press any function key to begin the transfer.

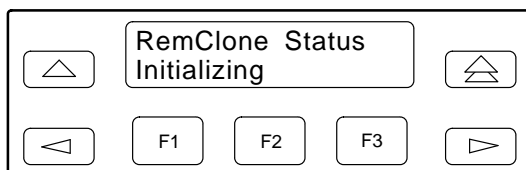


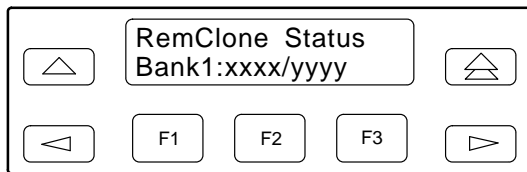
The local modem's LCD displays Establish Remote, indicating the modem is attempting to establish a Remote Cloning Download session with the remote modem.

If unsuccessful, the modem remains in the Download Transfer mode. The LCD's top line displays **RemClone Failed** and the bottom line displays one of the following messages:

- |                         |   |
|-------------------------|---|
| <b>Incompat Modulat</b> | The modems are connected, but are using a modulation scheme other than V.33, V.32 terbo, V.32bis, V.32, V.29, or Tmp.   |
| <b>No Response</b>      | The remote modem is not a 3900 Series modem or the connection between the two modems is poor.   |
| <b>Access Disabled</b>  | The remote modem's Access from Remote configuration is disabled.  |
| <b>Password Invalid</b> | The local and remote modems' passwords do not match. Correct the problem and attempt another download from the local modem. If this fails, contact your service representative. |
| <b>No Circuit</b>       | There is no connection between the local and remote modem.  |

After successful establishment of a Remote Cloning Download session, the following screens appear.





As data banks are transferred, the local and remote LCD's bottom line displays the status of the download process, and the number of records sent versus the total number of records for that bank.

For **Single** download applications, if the download is successful, the local modem displays **Remote Clone OK** and the remote modem displays **Firmware Upgrade**. If the download took place over the dial network, the modems disconnect when the download is complete.

If the **Single** download is unsuccessful, **RemClone Failed** appears on the LCD's top line. Attempt another download from the local modem. If this fails, contact your service representative.

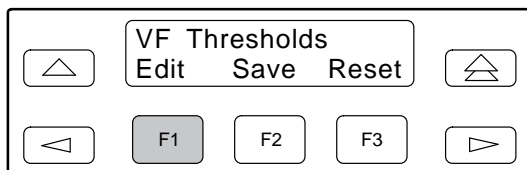
### VF Thresholds Update

The VF Thresholds Update function allows you to set the thresholds that determine the Health and Status alarm conditions for the VF parameters. The following thresholds may be edited: RSL High, RSL Low, Sig/Noise, NonLinear, Retrains/15min, Signal Quality, Near Echo, and Far Echo. (For Health and Status alarm conditions, refer to Table 3-6 in the *Device Health and Status* (DeviceHS) section of this chapter.)

To access VF Thresh Update from the Control branch, make the following selections:

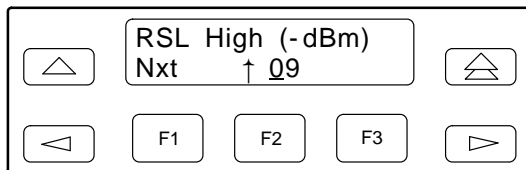


Press the  $\triangleright$  key until VF\_Thresh\_Update appears. Press any function key to select VF\_Thresh\_Update.

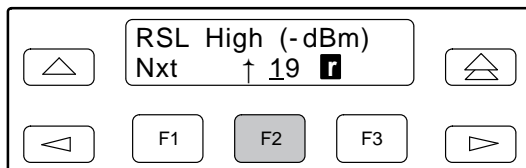


Select Edit.

In the following example, the RSL High threshold is changed from 09 (-dBm) to 10. This example demonstrates VF threshold editing and saving. With the exception of Signal Quality, all VF thresholds may be modified in this manner. Signal Quality uses a menu selection with possible values of *Excellent* (Excellent), *Good*, *Fair*, *Poor*, or *No Signal*. Editing and saving a VF threshold is similar to editing and saving a configuration option. (For another example of editing and saving, refer to the *Editing and Saving a Configuration Option* section in Chapter 4.)



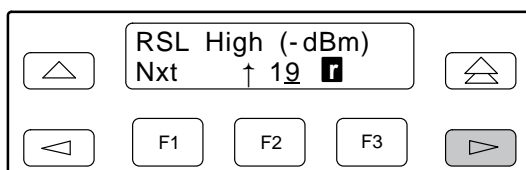
In the example shown above, 09 is the upper (High) RSL threshold (in -dBm). To change the 09 to 10, make the following selections:



Select the F2 (↑) key to increment the number above the cursor (0) to 1.

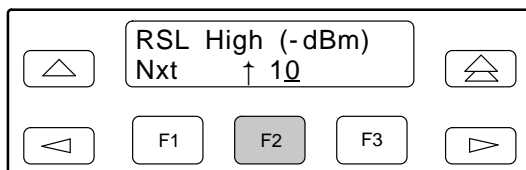
#### NOTE

Note that a warning (■) appears on the second line of the screen if you enter an invalid VF threshold (out of range). You will not be able to save your edits until all thresholds are within their valid range. Refer to Table 3-8 for valid VF threshold ranges.



Press the ▷ key to move the cursor to the next position (9).

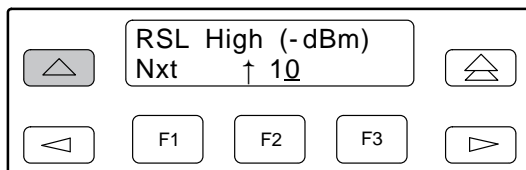
Select the F2 (↑) key to change the number above the cursor (9) to 0.



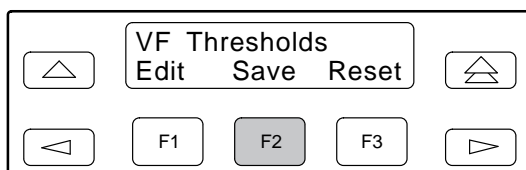
#### NOTE

If you want to modify additional VF thresholds, select Nxt.

To save the edited threshold(s):

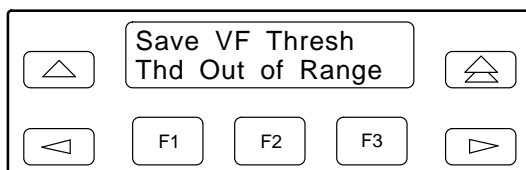


Press the  $\triangle$  key to scroll up to the Edit/Save screen.



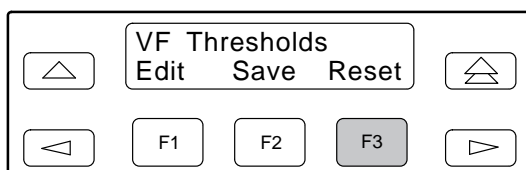
Select Save.

If the edited VF thresholds are valid, the Save command stores them into nonvolatile memory. When the Save completes, the message **Save Completed** appears.



If the edited VF threshold is invalid (out of range), the error message **Thd Out of Range** appears. This indicates the Save procedure was unsuccessful. Return to the Edit screen and correct the invalid threshold range.

To correct the invalid VF threshold, press the  $\triangle$  key to return to the VF Threshold Edit/Save/Reset screen.



Select Reset to restore the original default values into memory.

Repeat the Edit and Save procedure until the VF threshold(s) is valid and the Save completes successfully (**Save Completed**).

To exit this function and remain in the Control branch, press the  $\triangle$  key. To exit and return to the Top-Level menu, press the  $\triangle$  key.

**Table 3-8**  
**Valid Ranges for VF Thresholds**

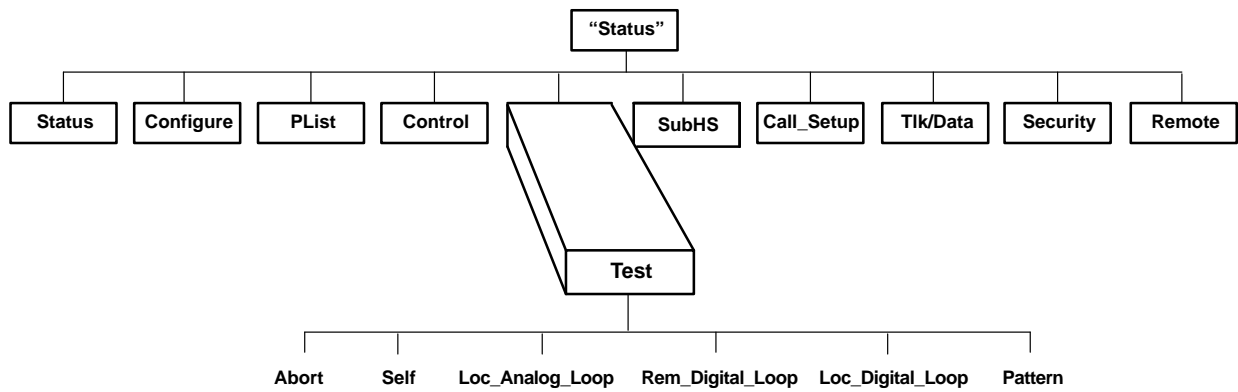
<b>VF Thresholds</b>	<b>Valid Ranges</b>	<b>Default Values</b>
Receive Signal Level High	0 dBm to -15 dBm	Above -9 dBm
Receive Signal Level Low	-16 dBm to -50 dBm	Below -23 dBm
Signal to Noise Ratio	5 dB to 40 dB	Below 23 dB
Non-Linear Distortion	15 dB to 50 dB	Below 30 dB
Retrains	1 to 256 trains	15 trains per 15 minutes
Signal Quality	Excellent (lowest) Good Fair Poor No Signal (highest)	Good
Near Echo	0—38 dBm	Above -20 dBm
Far Echo	0—38 dBm	Above -20 dBm

## Test Branch

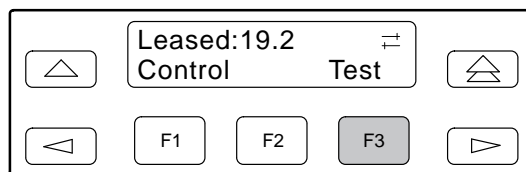
The Test branch of the Top-Level menu allows you to initiate various modem tests. Use these tests if you are having data communication problems, such as periodic character loss, random errors, or constant format errors. By the process of elimination, you can usually isolate the fault in your system.

There are six selections under Test: Abort, Self (Self-Test), Loc Analog Loop (Local Analog Loopback), Rem Digital Loop (Remote Digital Loopback), Loc Digital Loop (Local Digital Loopback), and Pattern. The only tests that can operate concurrently on a single modem are Pattern with a Local Analog Loopback and Pattern with a Remote Digital Loopback. If any test is operating, besides the two combinations just mentioned, it must be canceled before starting another test.

The Test branch only initiates and cancels tests. If any parameters need to be set, refer to the *Test* section discussed in Chapter 4, *DCP Configuration*.



To access the Test branch from the Top-Level menu, make the following selections:



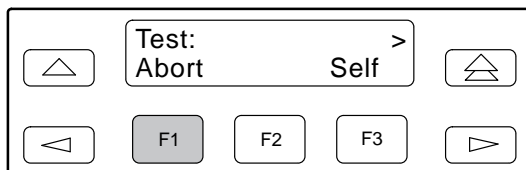
Press the  $\triangleright$  key until Test appears. Select Test.

### Abort

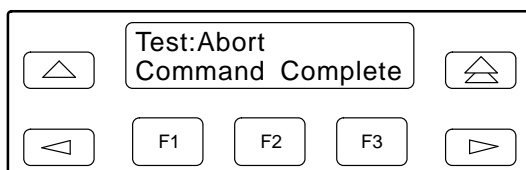
Abort ends any test that is in progress and brings the modem back to the normal mode of operation. Confirmation is provided by the **Command Complete** message.



To access Abort from the Test branch, make the following selection:



Select Abort.



The modem stops all tests currently in progress and displays the **Command Complete** status message on the LCD.

To exit this function and remain in the Test branch, press the  $\triangleleft$  key. To exit and return to the Top-Level menu, press the  $\triangleup$  key.

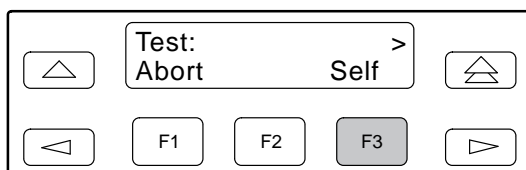
## Self

Self performs an internal self-test of the modem, which takes less than a minute to complete. The modem must be offline; otherwise, **Invalid Command** appears.

### WARNING

**When this test is run in Remote mode, it will cause the Remote mode session to be lost. The Remote mode session can be reestablished after the self-test is complete (usually one or two minutes). If the remote self-test fails, there will be a Device Failure alarm message when the remote modem's Device Health and Status (DeviceHS) branch is accessed.**

To access Self from the Test branch, make the following selection:



Select Self. (All LCD cells and DCP status indicators light.)

**NOTE**

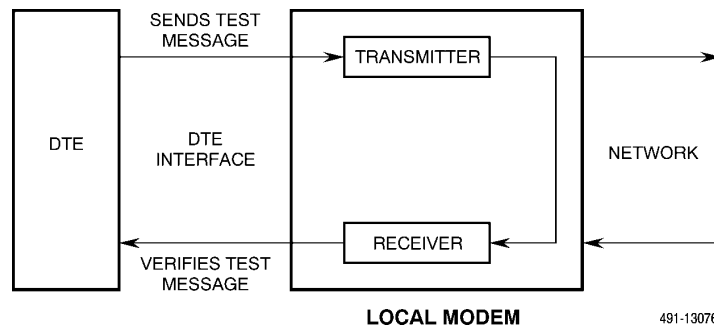
For tributary modems only, the test is delayed 30 seconds to allow any outstanding network management messages to propagate upstream before the VF channel is interrupted by the test.

If the modem passes the self-test, **Pass** appears on the LCD. If it fails, **Failed** appears. If the modem fails, contact your service representative. If **Invalid Command** appears on the LCD, the modem is operating on dial lines or another test is in progress. If another test is in progress, select **Abort** to clear the current test and try again. If the modem is operating on dial lines, disconnect to clear the dial lines, and then choose **Self**. If the modem receives a ring signal during this test, the test is canceled and the **RI Abort** message appears.

To exit this function and remain in the Test branch, press the  $\triangle$  key. To exit and return to the Top-Level menu, press the  $\triangle$  key.

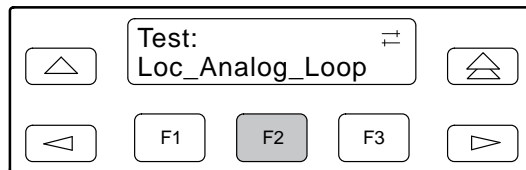
**Loc Analog Loop**

Loc Analog Loop performs a local analog loopback (CCITT V.54 Loop 3), Figure 3-4, that verifies modem operation as well as the connection between the DTE and modem. The modem must be offline and in Synchronous or Asynchronous Direct mode to perform this test, otherwise **Invalid Command** appears.

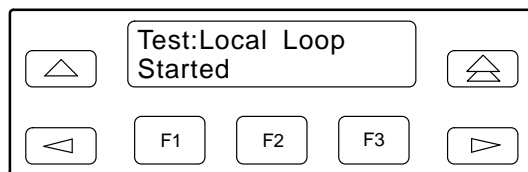


**Figure 3-4. Local Analog Loopback**

To access Loc Analog Loop from the Test branch, make the following selections:



Press the  $\triangleright$  key until **Loc\_Analog\_Loop** appears. Press any function key to start this test.

**NOTE**

For tributary modems only, the test is delayed 30 seconds to allow any outstanding network management messages to propagate upstream before the VF channel is interrupted by the test.

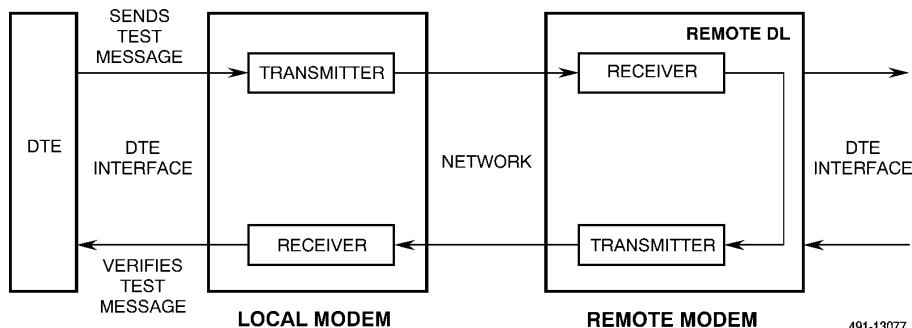
The message **Started** appears on the LCD, and the Test LED lights for the duration of the test. If **Invalid Command** appears on the LCD, another test is in progress. Select Abort to clear the current test and try again. If the Test Timeout configuration option is enabled, **Test Timeout** appears at the conclusion of the test. If it is disabled, the test operates until aborted. For more information on the Test Timeout configuration option, refer to the *Test* section in Chapter 4. A Ring Indicate during this test can cause errors.

To exit this function and remain in the Test branch, press the  $\triangle$  key. To exit and return to the Top-Level menu, press the  $\triangle$  key.

## Rem Digital Loop

**This test is not available when using Tmp modulation or Remote mode.**

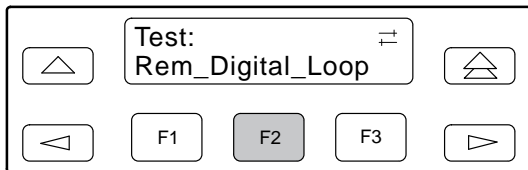
Rem Digital Loop performs a remote digital loopback (CCITT V.54 Loop 2), Figure 3-5. This test can verify the integrity of the local modem, the communication link, and the remote modem. Any data or pattern entered at the local DTE is sent to and returned from the remote modem. For this test to operate properly, **the modems must be operating at the same rate** and in Synchronous or Asynchronous Direct mode.



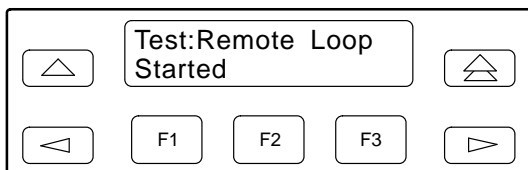
491-13077

**Figure 3-5. Remote Digital Loopback**

To access Rem Digital Loop from the Test branch, make the following selections:



Press the  $\triangleright$  key until Rem\_Digital\_Loop appears. Press any function key to start this test.



The message **Started** appears on the LCD, and the Test LED lights for the duration of the test. If **Invalid Command** appears on the LCD, another test is in progress. Select Abort to clear the current test and try again. If the Test Timeout configuration option is enabled, **Test Timeout** appears at the conclusion of the test. If it is disabled, the test operates until aborted. For more information on the Test Timeout configuration option, refer to the *Test* section in Chapter 4.

To exit this function and remain in the Test branch, press the  $\triangle$  key. To exit and return to the Top-Level menu, press the  $\triangle$  key.

### Loc Digital Loop

Loc Digital Loop is issued by a local modem and forces it to loopback any data received from the remote modem (Figure 3-6). (This test operates the same as a CCITT V.54 Loop 2 except it is issued at your modem.) This is useful if a remote modem is incapable of initiating a remote digital loopback from its location. For this test to operate properly, **the modems must be operating at the same rate** and in Synchronous or Asynchronous Direct mode.

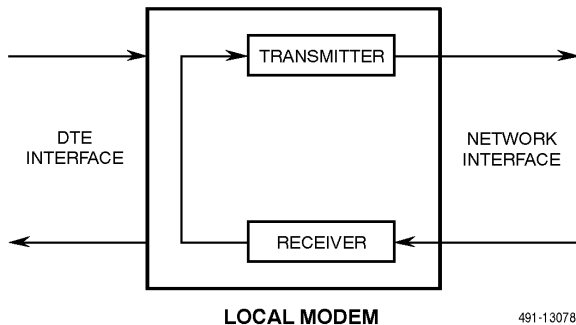
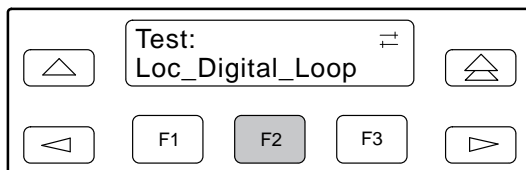
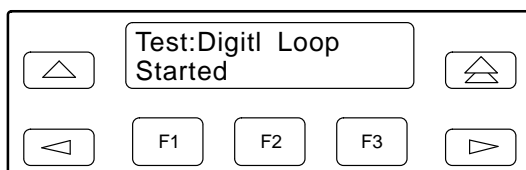


Figure 3-6. Local Digital Loopback

To access Loc Digital Loop from the Test branch, make the following selections:



Press the  $\triangleright$  key until `Loc_Digital_Loop` appears. Press any function key to start this test.

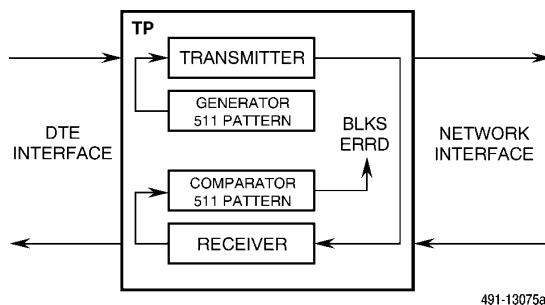


The message **Started** appears on the LCD and the Test LED lights. If **Invalid Command** appears on the LCD, another test is in progress. Select **Abort** to clear the current test and try again. If the Test Timeout configuration option is enabled, **Test Timeout** appears at the conclusion of the display. If it is disabled, the test operates until aborted. For more information on the Test Timeout configuration option, refer to the *Test* section in Chapter 4.

To exit this function and remain in the Test branch, press the  $\triangle$  key. To exit and return to the Top-Level menu, press the  $\triangle$  key.

## Pattern

Pattern can transmit and receive a 511 bit error rate test pattern. It can also be used with a currently running local analog loopback or a remote digital loopback to simulate data passing through the modem. You will need to start the local analog or remote digital loopback test before you start the pattern test. For this test to operate properly, the modems must be online and in Synchronous or Asynchronous Direct mode (Figures 3-7 through 3-9).



491-13075a

**Figure 3-7. Pattern Test and Local Analog Loopback Test**

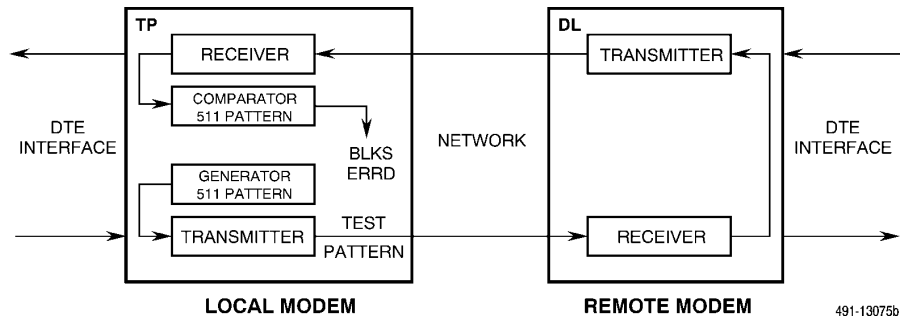


Figure 3-8. Pattern Test and Digital Loopback Test

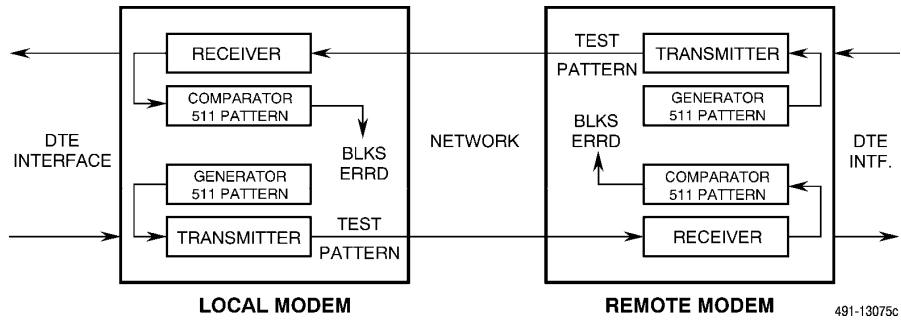
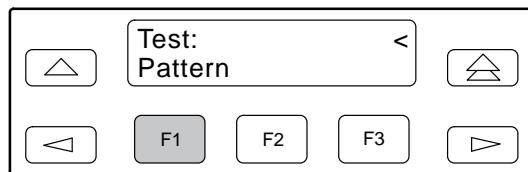
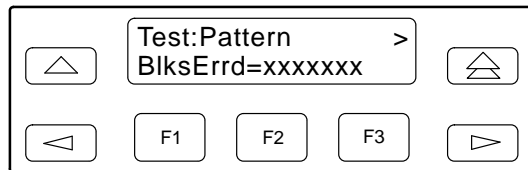


Figure 3-9. End-to-End Pattern Test

To access Pattern from the Test branch, make the following selections:



Press the  $\triangleright$  key until Pattern appears. Select Pattern to start this test.



**BlksErrd=xxxxxxx** displays the number of blocks of data found in error (block size is 1000 bits per block). **BlksRcvd=xxxxxxx** displays the total number of blocks of data received. The message **NoSync** appears as a value for BlksErrd while the modem's receiver is synchronizing. The message **OvrFlw** appears as the value for BlksErrd if the counter overflows.

Press the  $\triangleright$  key to display **BlksRcvd=xxxxxxx**, number of blocks of data received.

The Pattern test can be exited and reentered without restarting the test. The BlksErrd and BlksRcvd continue counting.

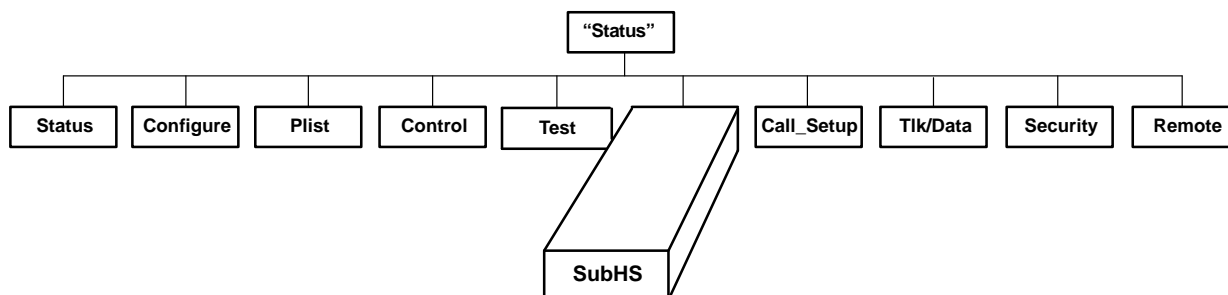
If the Test Timeout configuration option is enabled, **Test Timeout** appears at the conclusion of the test. If it is disabled, the test operates until aborted. For more information on the Test Timeout configuration option, refer to the *Test* section in Chapter 4.

To exit this function and remain in the Test branch, press the  $\triangle$  key. To exit and return to the Top-Level menu, press the  $\triangleleft$  key.

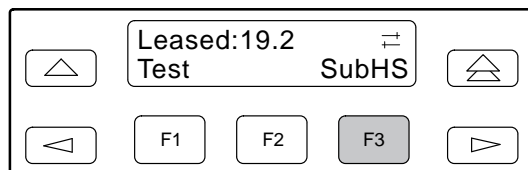
## Sub-Network Health and Status Branch

The Sub-Network Health and Status (SubHS) function is not available on multipoint tributary modems or with certain modulations (V.29, V.33, V.22bis, and V.27bis).

The SubHS branch of the Top-Level menu allows you to display alarm conditions in downstream modems.



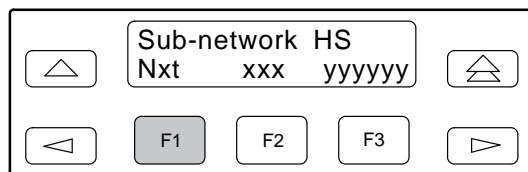
To access the SubHS branch from the Top-Level menu, make the following selections:



Press the  $\triangleright$  key until SubHS appears. Select SubHS.

### NOTE


If there are no modems in the multipoint poll list, the message **Poll List Empty!** appears on the second line of the LCD.



When you select SubHS,

- xxx        Displays the network management address of the downstream modem selected.
- yyyyyy    Displays the status of the downstream modem. This message is updated every several seconds to display the latest status. **MAJOR**, **MINOR**, and **STATUS** display Health and Status alarm conditions; refer to Table 3-6 in the *Device Health and Status* (DeviceHS) section of this chapter for additional information. **UNKNWN** appears when the modem does not recognize the downstream health and status information or device communication is not established. **Normal** appears if no alarms are present. **NO RSP** appears when the downstream modem does not respond to the poll.

Select Nxt to scroll through the entries in the poll lists.

To exit this function and return to the Top-Level menu, press the  key.

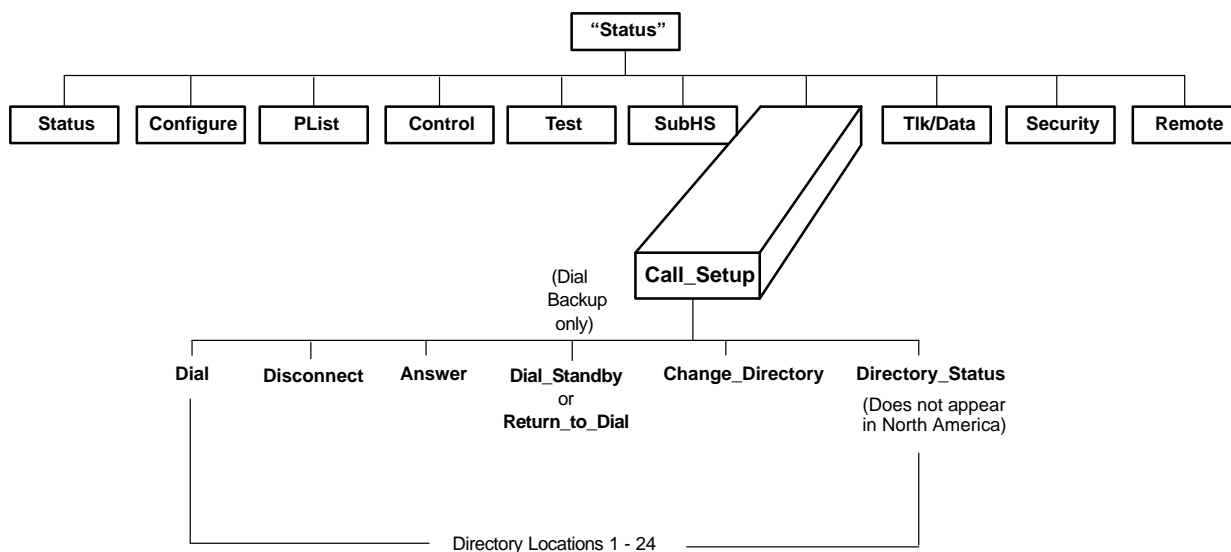
## Call Setup Branch

**The Call Setup function is not available in Tmp Control mode.**

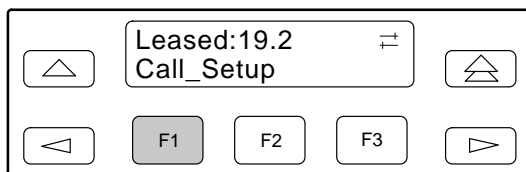
For dial backup applications, the Call Setup branch of the Top-Level menu allows you to dial, disconnect, and answer telephone calls. For leased backup applications, the Call Setup branch allows you to switch between the primary leased line and the backup leased line.

In leased backup operation, a 2-wire leased line is used as the backup facility instead of the normal 2-wire dial line. Plug the leased line into the jack labeled DIAL on the rear panel of the modem and enable the Dual\_Leased\_Ln configuration option. (Refer to the *Leased Line* section in Chapter 4 for configuration options.) Except for dialing, ring indication, and call progression functions, you control the backup function as if it were a normal dial backup.





To access the Call Setup branch from the Top-Level menu, make the following selections:



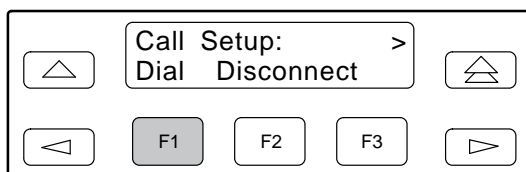
Press the  $\triangleright$  key until Call\_Setup appears. Select Call\_Setup.

## Dial

For dial backup applications, Dial allows you to dial any telephone number stored in directory locations 1–24. Any telephone number dialed using the DCP must already exist in a directory location. Refer to *Change Directory* for information on storing telephone numbers in directory locations.

For leased backup applications, Dial allows you to switch to the backup leased line. Any directory location may be used. The remote modem cannot automatically answer the simulated call. Use the Answer function of the remote modem in conjunction with the Dial function to manually switch to the backup leased line.

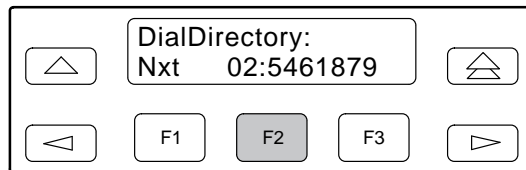
To access Dial from the Call Setup branch, make the following selection:



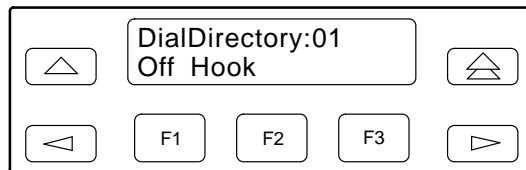
Select Dial to display the first directory telephone number.



To view other directory locations, select Nxt.



Once the directory location you want appears on the LCD, press the F2 or F3 key to dial the number.

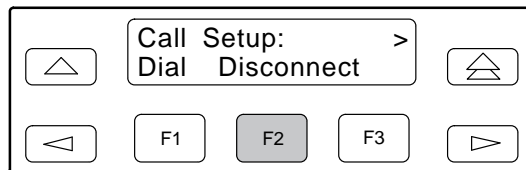


The Call Setup status **Off Hook** appears during the connection process. If the connection is successful, one of the Normal Operation status messages (Table 3-3) appears on the LCD. If the connection is not successful, the LCD displays one of the Call Failure status messages (Table 3-3).

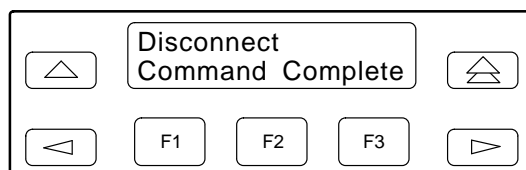
## Disconnect

For dial backup applications, use this function when you want to disconnect an established call on a dial line. For leased backup applications, use this function to switch between the primary leased line and the backup leased line.

To access Disconnect from the Call Setup branch, make the following selection:



Select Disconnect.



For dial backup applications, the modem goes on-hook (hangs up) and the call is disconnected. The **Command Complete** status message appears.

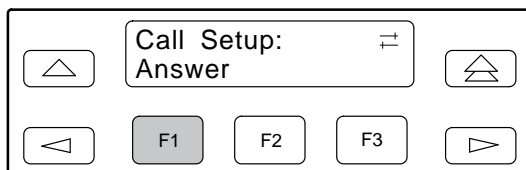
To exit this function and remain in the Call Setup branch, press the  $\triangle$  key. To exit and return to the Top-Level menu, press the  $\triangle$  key.

## Answer

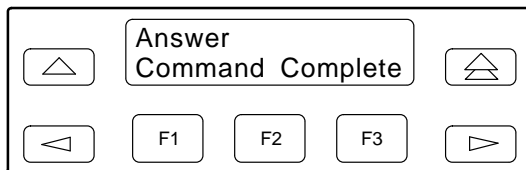
For dial backup applications, Answer allows the modem to go off-hook, generate an answer tone, and begin the handshaking process with the calling modem. Use the Answer function when the Auto-Answer Ring Count configuration option is disabled. (Refer to the *Line Dialer* section in Chapter 4.)

For leased backup applications, Answer allows the modem to begin the handshaking process with the remote modem.

To access Answer from the Call Setup branch, make the following selections:



Press the  $\triangleright$  key until Answer appears. Select Answer.

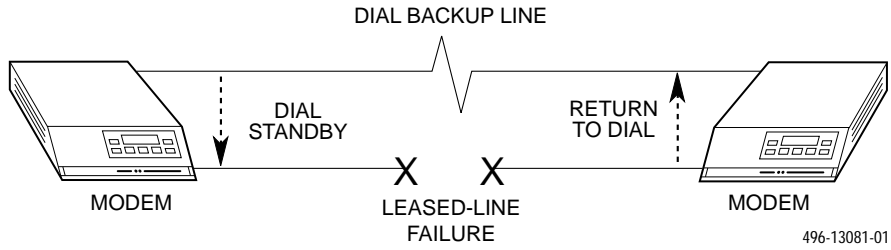


The modem goes off-hook and attempts to establish a connection in Answer mode. The **Command Complete** status message appears on the LCD.

To exit this function and remain in the Call Setup branch, press the  $\triangle$  key. To exit and return to the Top-Level menu, press the  $\triangle$  key.

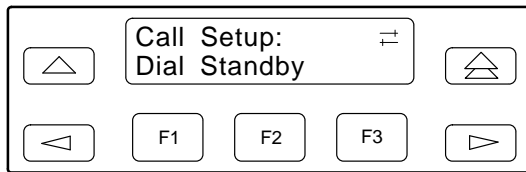
## Dial Standby/Return to Dial

When the modem is operating in Dial Backup mode (DialBckUp), Dial Standby and Return to Dial allow the modem to switch back and forth between primary leased-line and primary leased-line backup operation while still maintaining the backup connection (Figure 3-10). Switching between backup and primary leased-line operation can be performed manually or automatically. (Refer to the *Leased Line* section in Chapter 4 to enable the Automatic Dial Backup configuration option.)

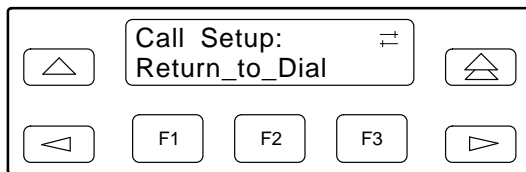


**Figure 3-10. Dial Backup**

Under normal backup conditions, when a problem occurs on the primary leased line, the modems establish a connection over the backup network.

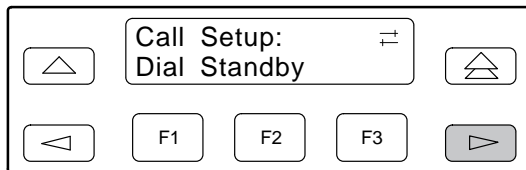


When this occurs, Dial Standby appears on the LCD in the Call Setup menu branch. If you select Dial Standby, the modem switches back to the primary leased line while still maintaining the backup connection. As a result, Return\_to\_Dial appears on the LCD instead of Dial Standby.

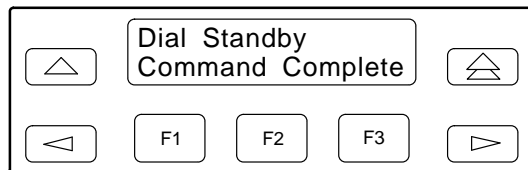


If the primary leased line is unacceptable, select Return\_to\_Dial which switches the modem back to backup network operation (LCD displays Dial Standby). If, however, the primary leased line is operating properly, select Disconnect from the Call Setup branch to drop the dial backup connection. Also, if the primary leased-line operation is maintained uninterrupted for the amount of time specified in the Dial Standby configuration option, the dial backup network disconnects.

To access Dial Standby or Return to Dial from the Call Setup branch, make the following selections:



Press the  $\triangleright$  key until Dial Standby or Return\_to\_Dial appears. Select the appropriate function.



If the modem is operating in a Dial Backup mode, the Dial Standby function forces the modem to primary leased lines and the LCD displays the status message **Command Complete**.

Once the modem is in Dial Standby mode, Return\_to\_Dial appears on the LCD. Selecting this function forces the modem to the backup network and the LCD displays the status message **Command Complete**.

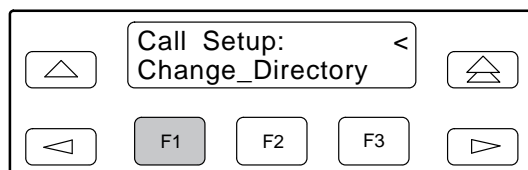
## Change Directory

Change Directory allows you to enter or modify telephone numbers. The modem has nonvolatile memory locations that allow you to store up to 24 telephone numbers. Each directory location can accept up to 40 characters; this includes the telephone number and dial command modifiers. Any telephone number dialed using the DCP Dial command must appear in a directory location.

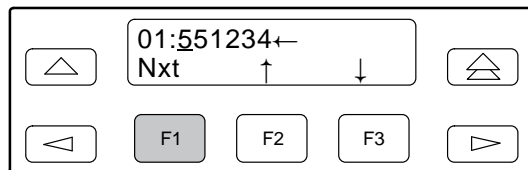
### NOTE

If the modem is operating on leased lines and has a dial line attached for dial backup purposes, it is required that directory location 1 contain the telephone number used for dial backup.

To access Change Directory from the Call Setup branch, make the following selections:



Press the  $\triangleright$  key until Change\_Directory appears. Press any function key to select Change\_Directory.

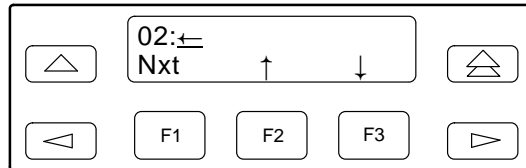


The phone number listed in directory location 1 appears. Select Nxt to display other directory locations.

### Entering Telephone Numbers and Dial Command Modifiers into Directory Locations

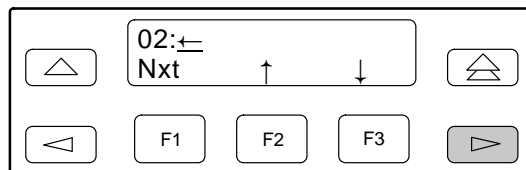
The following example uses an empty directory location for describing how to enter a telephone number. If you want to change an existing telephone number in any of the 24 directory locations, follow the same procedures.

To add a telephone number to a directory location, make the following selections:



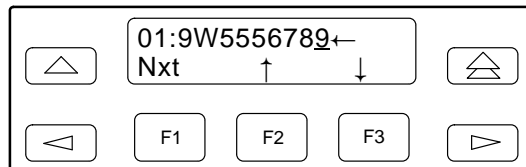
Select Nxt until a blank directory appears on the LCD. (The cursor (   ) always appears in the first character position.)

Select F2 ( ↑ ) or F3 ( ↓ ) until the desired character is selected. This can be an alpha or numeric character.



Press the ▷ key to move the cursor to the next character position.

Continue this key sequence until the dial command modifiers and telephone number are entered. (Refer to Table 3-6 for a list of valid dial command modifiers.)



To save the number just entered, scroll to the next directory location by selecting Nxt. The number is now stored in nonvolatile memory.

Table 3-9 describes what can be entered in directory locations.

**Table 3-9**  
**Valid Dial Command Modifiers**

Dial command modifiers are parameters entered in the dial command string which specify how, when, and what number to dial. The following is a list of parameters the 391x Series modems recognize:

- T** — Tone (DTMF) dial. Any digit 0–9, \*, or # can be dialed as tone.
- P** — Pulse dial. Only the digits 0–9 can be dialed in Pulse Dial mode.

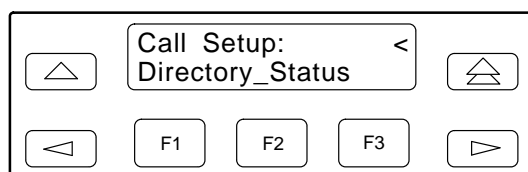
**NOTE:** Once a dialing method (tone or pulse) has been specified, it will only remain active until the end of that dial string. The modem defaults to the value set by the Dialer Type configuration option.

- ,** — Pause. Causes the modem to pause before processing the next character in the dial string. The length of this pause is determined by the setting of the Pause Time configuration option (refer to the Line Dialer configuration option group) or by the value held in S-Register S8.
- W** — Wait for tone dial. The modem waits for a second dial tone before processing the dial string. This can be the initial dial tone or can be used when dialing through a tandem PBX.
- R** — Reverse Dial mode. Causes the originating modem to send out an answertone once it no longer detects ringback. (Ringback is the ring you hear at the originating site when making a call.) The R modifier must be the last character in the dial string.
- @** — Quiet answer. Wait for five seconds of silence after dialing the number. If the silence is not detected, the modem sends the NO ANSWER result code to the DTE or displays the No Quiet Answer LCD status message.
- !** — Hook flash. Causes the modem to go on-hook for 0.5 seconds then return to off-hook.
- ;** — Return to Command mode. Causes the modem to return to Command mode after dialing a number without disconnecting the call.
- Space** — Ignored by the dial string, can be included to enhance readability.
- — Ignored by the dial string, can be included to enhance readability.
- ( )** — Ignored by the dial string, can be included to enhance readability.
- ←** — End of Number. Hides all characters appearing on the LCD entered to the right of this indicator.

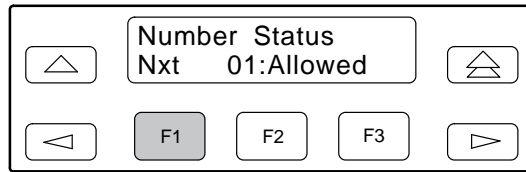
### Directory Status (Does Not Appear in North America)

Directory Status displays the status of each directory location.

To access Directory Status from the Call Setup branch, make the following selections:



Press the  $\triangleright$  key until `Directory_Status` appears. Press any function key to select `Directory_Status`.



Select Nxt to display other directory locations.

The status of a directory location can be:

- No Number**     The directory location is empty.
- Allowed**        The number in this directory location may be dialed at this time.
- Delayed**        The number in this directory location may be dialed later.
- Forbidden**      The number in this directory location may not be dialed.

**Delayed** and **Forbidden** only appear in certain countries.

When a number is delayed, press the  $\triangleright$  key to display the value of the delay in minutes.

The delayed and forbidden conditions can be cleared by power cycling the modem. This is actually the only way to reenale a forbidden number. Deleting a number from a directory location and reentering it into another directory location will not change the delayed or forbidden condition of this number.

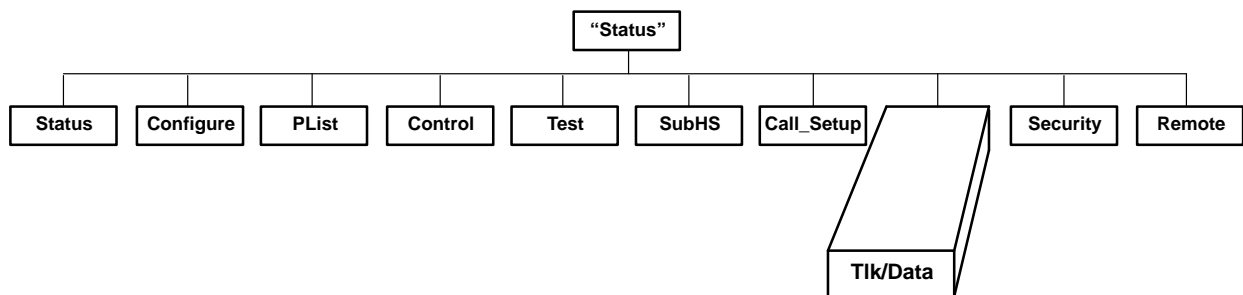
## Talk/Data Branch

**The Talk/Data function is not available in Tmp Control mode.**

The Talk/Data branch of the Top-Level menu allows you to switch the modem between Talk mode and Data mode when manually dialing using either the DCP or an externally attached telephone.

To add an external telephone to your modem, use an external “Y” cable to connect the phone line to both the modem and the telephone (refer to Appendix C). This cable is not supplied with your modem.

On initial power-up, the modem is in Talk mode. When in Talk mode, the modem is disconnected and you are free to use the telephone. When in Data mode, the modem is connected and data can be transmitted or received. **This function is not available for Model 3911 modems.**





The following sections describe three uses of the Talk/Data function.

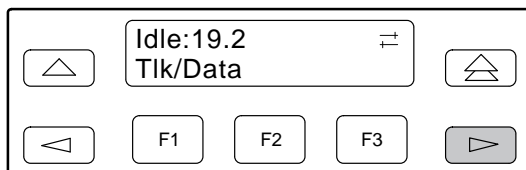
## Manual Dialing When the Remote Modem is Configured for Auto-Answer

### NOTE

On the remote modem, the Line Current Disconnect configuration option (refer to the *Line Dialer* section in Chapter 4) must be set to Disable.

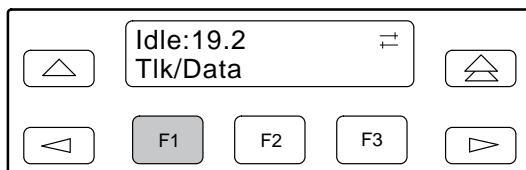
This configuration option does not appear on Models 3910-A1-401 and 3911-B1-001.

If you are originating a call using a telephone and the remote modem is configured for Auto-Answer, perform the following procedure.

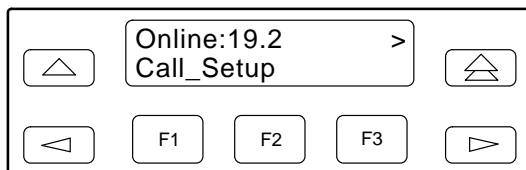


Press the  $\triangleright$  key until Tlk/Data appears.

Lift the attached handset and dial the telephone number of the remote modem. When the remote modem answers, it transmits an answer tone.



When you hear this tone, immediately select Tlk/Data and hang up the handset. This starts the handshaking sequence between your modem and the remote modem.



If this is successful, the modems are in Data mode and **OnLine** appears on the LCD.

## Manual Dialing When the Remote Modem is Configured for Manual Answer

### NOTE

On both modems, the Line Current Disconnect configuration option (refer to the *Line Dialer* section in Chapter 4) must be set to Disable.

This configuration option does not appear on Models 3910-A1-401 and 3911-B1-001.

If you are originating a call using a telephone and the remote modem is configured for Manual Answer, perform the following procedure.

Once the remote telephone is answered by the remote user, you must both decide when to place the modems into Data mode. You must both select Tlk/Data at approximately the same time and hang up the handset to begin the handshaking sequence.

If the handshake is successful, the modems are in Data mode and **OnLine** appears on the LCD.

### NOTE

If the remote modem is not a 3900 Series modem, then the remote user must consult that modem's operator's manual to perform a similar operation.

Once the modems are online, the status messages listed in Table 3-3 appear on the Top-Level display.

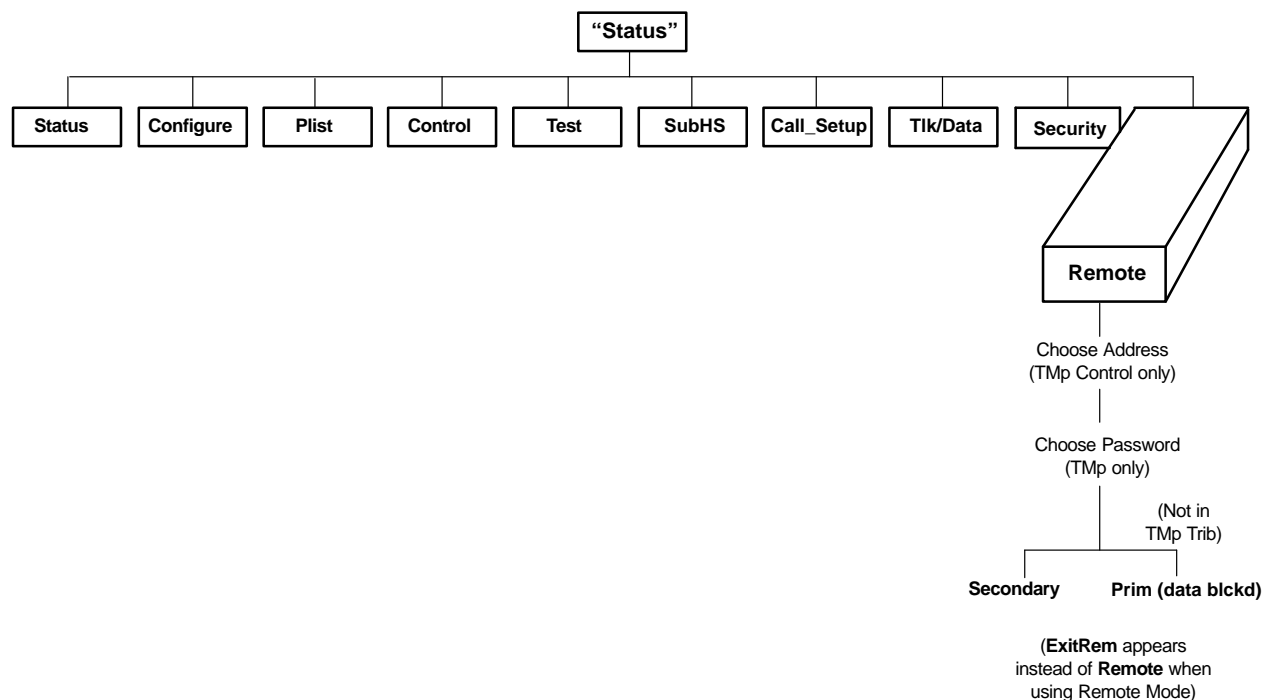
It is not necessary to specify an originating or answering modem when dialing via the DCP because the answering modem detects that it is receiving a ringing voltage and automatically defaults to Answer mode.

## Security Branch

The Security branch allows you to create, edit, and save parameters that determine how the modem's security is executed. For security procedures and configuration options, refer to Chapter 6, *Dial Access Security*.

## Remote Branch

The Remote branch of the Top-Level menu allows you to control the remote modem's DCP using the local modem's DCP. This function allows you to change configuration options and control test functions in a remote modem. Any changes made to configuration options while using the Remote branch are not saved until you exit the Remote branch. This function is only available when using either V.32 terbo, V.32bis, V.32, TMp, V.33, or V.29 modulation schemes.



The following conditions must be met before using the Remote branch:

- A connection using either leased lines or the dial network must be established.
- The Access from the Remote configuration option must be enabled in the remote modem.
- In point-to-point networks, the Remote Access Password configuration option must be the same for both the local and remote modems. In multipoint networks the remote access password must be entered at the appropriate prompt.
- For multipoint control modems, the network management address of the tributary modem must be entered at the appropriate prompt.

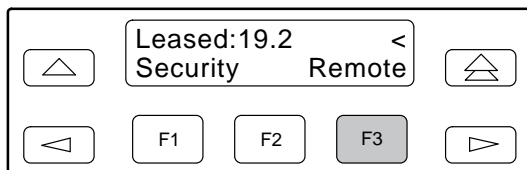
Remote DCP access is accomplished using either the primary or secondary channel (if available) of the VF line. Using the primary channel gives a much faster response time due to the higher data rate, but it also interrupts data flow because primary data is stopped when Remote mode is active. Once Remote mode is terminated, the primary channel is automatically made available for data transmission.

Unlike primary channel communications, the secondary channel operates at a slower data rate and does not interrupt data flow. (V.32 terbo, V.32bis, V.32, and TMp are the only modulations available for the secondary channel.)

**NOTE**

When initiating a Remote function from a TMp tributary modem, primary channel operation is not available. Also, if the tributary modem is not on the control modem's poll list, the error message **No Trib Session** appears when the function is executed.

To access the Remote branch, make the following selections:

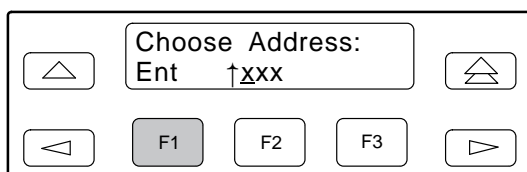


Press the  $\triangleright$  key until Remote appears. Select Remote.

**NOTE**

If a connection is not established between a local 3900 Series modem and a remote 3900 Series modem, the LCD displays **Remote Mode Fail-No Circuit**. Return to the Top-Level menu.

For Trellis Multipoint (TMp) control modems, you must specify the network management address of a tributary modem. **The following display does not appear in point-to-point or Trellis Multipoint tributary modems.**

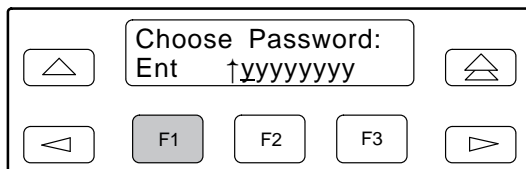


The address field (xxx) displays the network management address of the modem to be accessed by the Remote function. The valid address field range is from 001 to 256.

To increment digits within the address field (xxx), use the  $\triangleleft$  and  $\triangleright$  keys to position the cursor (  $\uparrow$  ) under the digit that will be incremented. Press the F2 (  $\uparrow$  ) key to increment the digit.

Press Enter (Ent) to select the modem that will be accessed by the Remote function.

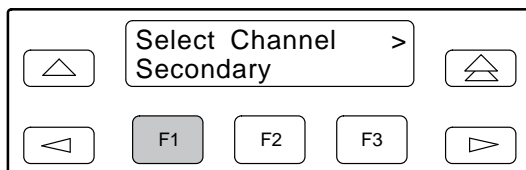
For Trellis Multipoint (TMp) modems (control or tributary), you must specify the remote access password of the modem that will be accessed by the Remote function. **The following display does not appear in point-to-point modems.**



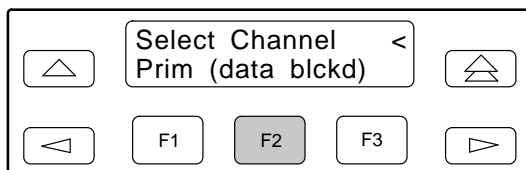
The password field (yyyyyyyy) displays the remote access password of the modem to be accessed by the Remote function.

To increment digits within the password field (yyyyyyyy), use the  $\triangleleft$  and  $\triangleright$  keys to position the cursor (  $\_$  ) under the digit that will be incremented. Press the F2 (  $\uparrow$  ) key to increment the digit.

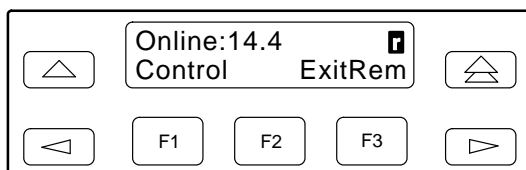
Press Enter (Ent) to select the modem that will be accessed by the Remote function.



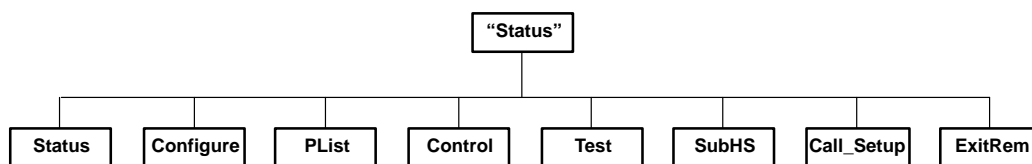
or



If operation over the secondary channel is desired, press any function key to select the secondary channel. **Secondary channel only appears if using V.32 terbo, V.32bis, V.32 or TMp modulation.** If operation over the primary channel is desired, press the  $\triangleright$  key until primary displays and press any function key. **Primary channel operation is not available when initiating a Remote function from a TMp tributary modem.**



If the remote modem accepts the password and the entry is successful, the Top-Level menu of the remote modem appears on the local modem's LCD. An  $\blacksquare$  appears in the upper right-hand corner indicating that what is displayed on your LCD is actually the Top-Level menu of the remote 391x Series modem. If the message **Remote FP Busy** appears, the remote modem's front panel is already in Remote mode.



The Top-Level menu of the remote 391x Series modem is similar to the local 391x Series modem with the following exceptions:

- The Talk/Data and Security branches do not appear.
- Change Directory is the only function available under the Call Setup branch.
- Local Analog Loop and Remote Digital Loop do not appear under the Test branch when using the secondary channel. When using the primary channel, the Test branch does not appear.
- Poll List Display is the only function available under the PList branch.
- Exit Remote replaces Remote on the local modem's LCD.

To return to local modem operation, select ExitRem. Any changes made to configuration options in the remote modem are saved.

The following conditions can cause Remote branch access to fail:

- The local modem is not able to communicate with the remote modem because of a poor dial network or leased-line connection, or the remote modem is not a 3900 Series modem. If this is the case, the status message **No Response** appears on the LCD.
- If a connection is established but the remote modem's Access from Remote configuration option is disabled, then the status message **Access Disabled** appears on the LCD.
- If a connection is established but the wrong password is stored, the status message **Password Invalid** appears on the LCD. This configuration option must be enabled by the remote user. (Refer to the Remote Access Password configuration option in Chapter 4.)
- The Remote mode command displays **Other Test Active** if an Analog Loopback test is currently running.

## Diagnostic Control Panel Access


### NOTE

This page of the manual is self supporting and can be removed to prevent unwanted knowledge of the DCP security access selections.

Use the DCP security access function to “lock” the DCP of any 391x Series modem and prevent unwanted user access. Two options are available for this function: **Grant** and **Deny**.

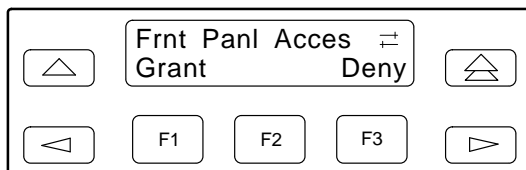
Grant allows any branch of the Top-Level menu to be accessed from the DCP. Deny only allows access to the Status branch of the Top-Level menu. All 391x Series modems are shipped from the factory with DCP access granted.

To access the Front Panel (DCP) Security Access function, perform the following:

Press the  key three times.

Press the  key twice.

Press the  key once.



Select Grant to allow access or select Deny to lock DCP access.

Either selection results in a return to the Top-Level menu.

---

# DCP Configuration 4

Overview .....	4-1
Configure Branch .....	4-4
Editing and Saving a Configuration Option .....	4-5
Summary .....	4-8
Configuration Tables .....	4-9
DTE Interface .....	4-9
DTE Dialer .....	4-19
Line Dialer .....	4-25
Dial Line .....	4-30
Leased Line .....	4-33
V.42/MNP/Buffer .....	4-38
Test .....	4-46
Misc .....	4-48
Security .....	4-51

## Overview

After installing a 391x Series modem, its software configuration options must be set using either the diagnostic control panel (DCP) or the AT command set. This chapter describes how to access and use the Configure branch of the Top-Level menu via the DCP.

The Configure branch accesses the Edit Area which is a work space where you view and change any configuration options (straps). These configuration options are loaded to the Edit Area from one of five configuration option areas: Active (Operating), Active (Saved), Customer 1, Customer 2, or Factory.

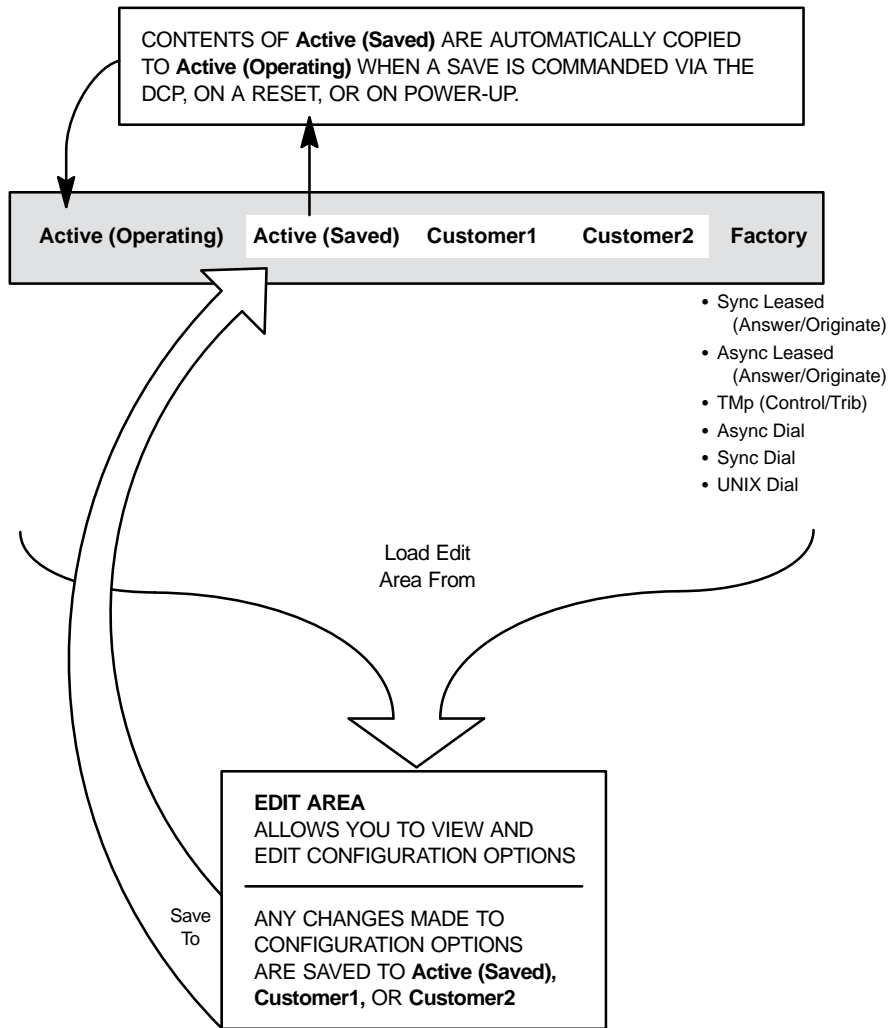
- **Active (Operating)** is a configuration area containing configuration options currently used by the modem. When the modem is powered on or when a save is performed, the contents of Active (Saved) are loaded into Active (Operating). Any changes made using AT commands directly affect this configuration area.
- **Active (Saved)** is a read from and write to configuration option area containing the most recently saved changes made to any configuration options. In the event of a power cycle or reset, the modem retrieves these settings from nonvolatile memory.
- **Customer 1** and **Customer 2** are two additional read and write (changeable) configuration areas where you can create and store additional configurations for specific applications.
- **Factory** is a read-only (unchangeable) configuration area containing six sets of predefined configuration options labeled **Sync Leased**, **Async Leased**, **TMP** (Trellis Multipoint), **Async Dial**, **Sync Dial**, and **UNIX Dial**. If Sync Leased or Async Leased is selected, you must choose either **Answer** or **Originate** mode. If TMP is selected, you must choose either **Control** or **Trib** (Tributary) mode. These sets contain the most commonly used configurations options for modems installed into these hardware environments. These predefined configuration options are intended to give you a head start and only require a minimum of changes to the default settings. Factory default settings are listed in Appendix F.



**NOTE**

If you are using AT commands, a period of time can exist in which the contents of Active (Operating) and Active (Saved) differ. Once you issue an AT&W0 (write) command, however, the two storage areas are identical.

Figures 4-1 and 4-2 graphically display the interaction between the edit area and configuration areas as viewed from the perspective of the DCP and the AT command set.



**Figure 4-1. DCP Configuration Process**

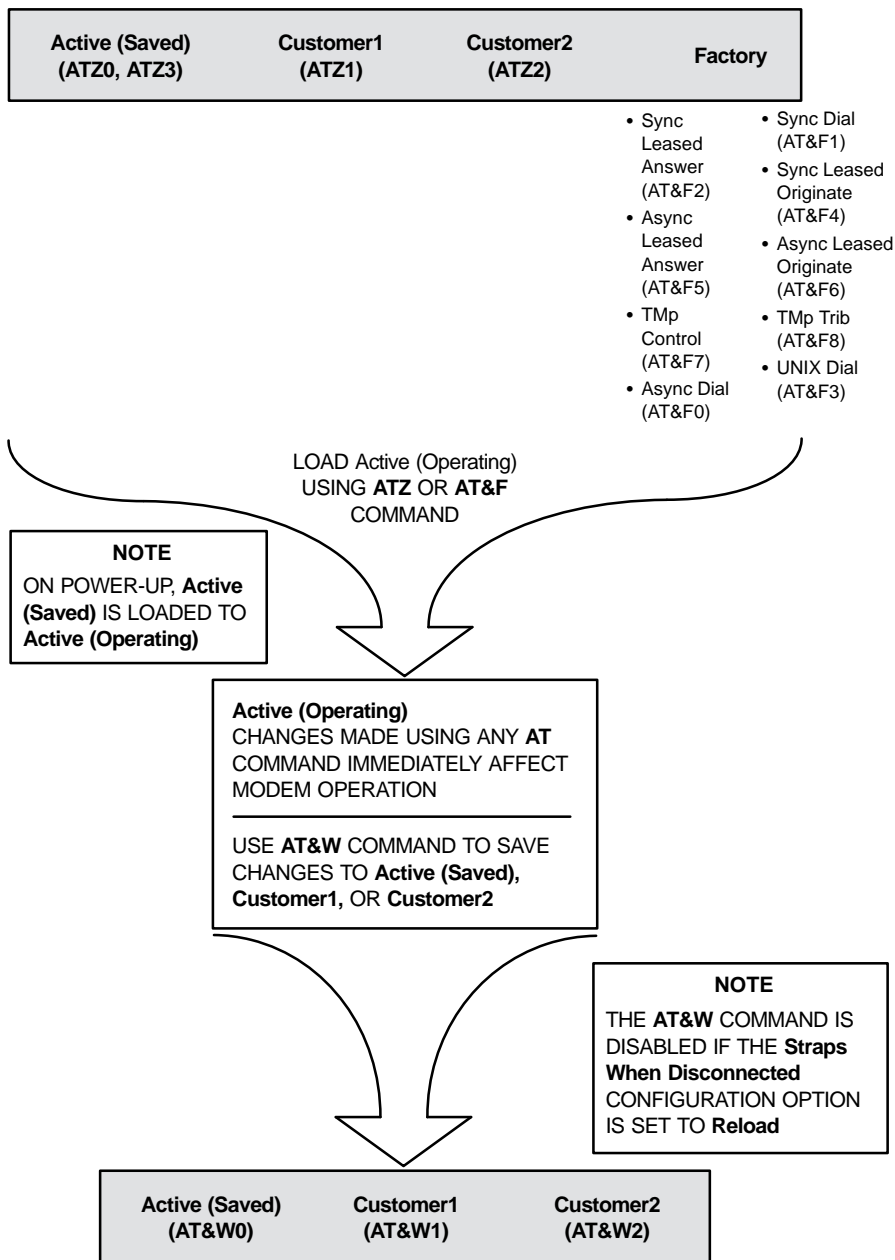
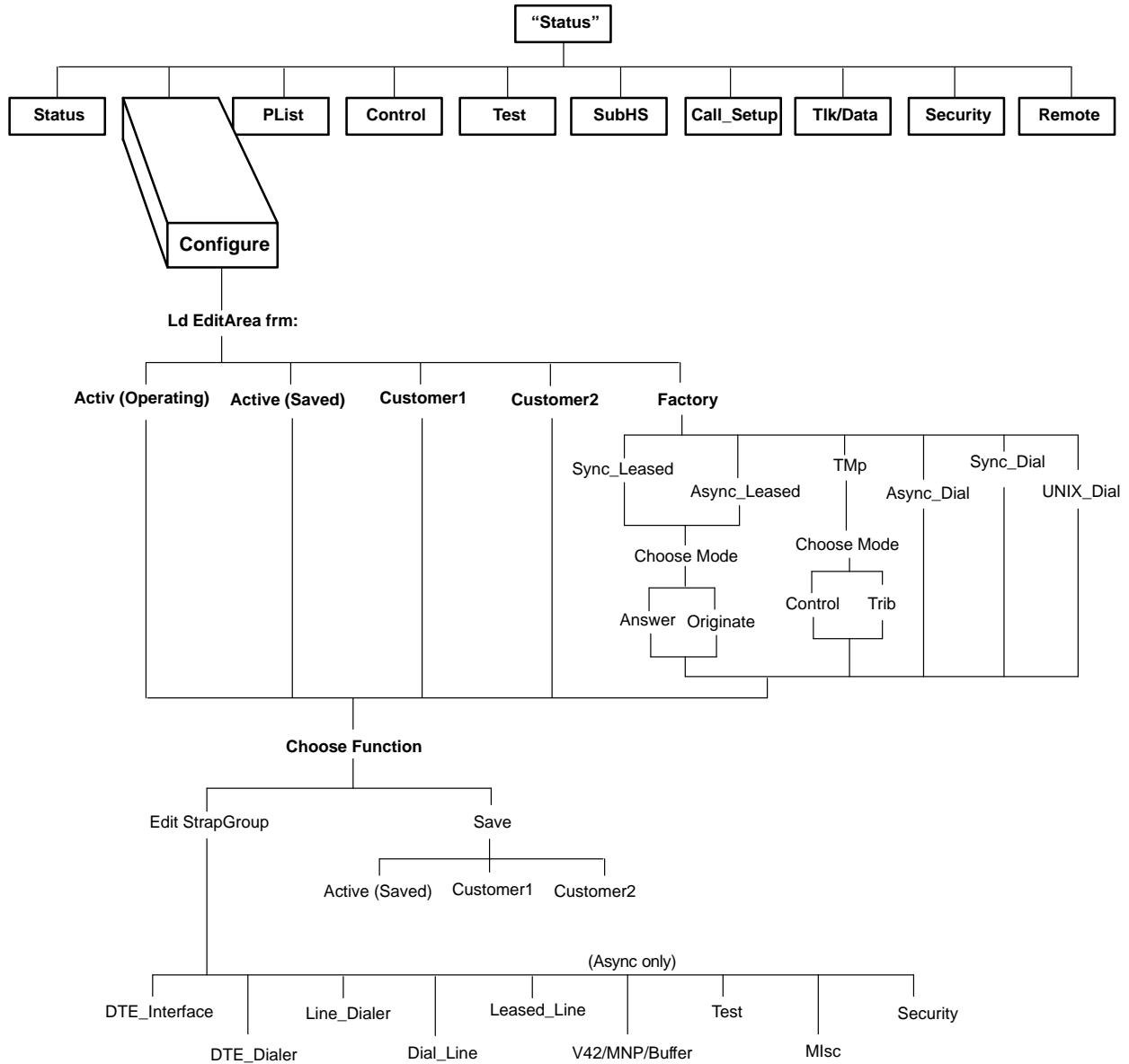


Figure 4-2. AT Command Configuration Process

# Configure Branch

The Configure branch of the Top-Level menu contains all of the modem's configuration options (straps) which determine how the modem operates. These configuration options are accessed by scrolling down and across various levels of the Configure branch.

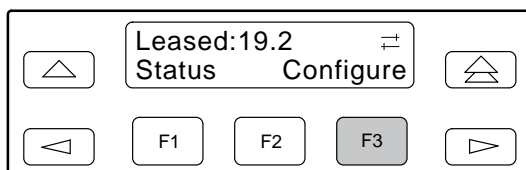


The Configure branch consists of the following three levels:

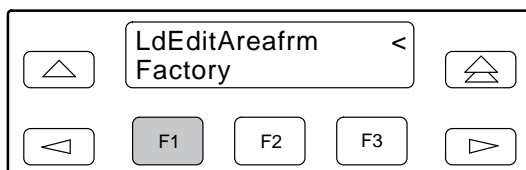
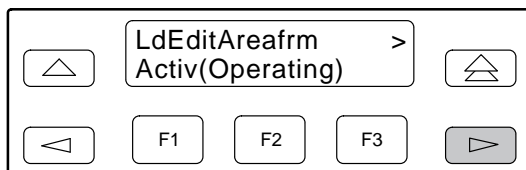
- **Ld EditArea frm.** Allows the selection of the Active (Operating), Active (Saved), Customer 1, Customer 2, and Factory configuration areas.
- **Choose Function.** Allows you to make changes (Edit) to existing configuration options or write (Save) these changes to either the Active (Saved), Customer 1, or Customer 2.
- **Edit Strap Group.** Contains the eight software configuration option groups that determine how the modem operates, plus the Security group, which can be viewed but not changed using this branch.

## Editing and Saving a Configuration Option

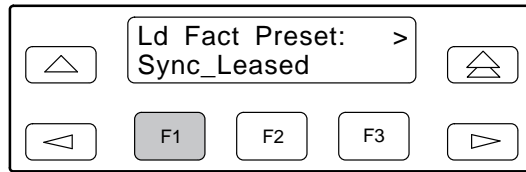
The following example shows how to change the Remote Access Password using the DCP. (If you intend to access another 3900 Series modem via the Remote branch of the Top-Level menu, the Remote Access Password must be the same for both modems.) By following these procedures you learn how to load a factory preset configuration area (in this case, Sync Leased), how to edit a configuration option (Remote Access Password), and how to save changes to a configuration area (Active (Saved)). The shaded key indicates what key to press.



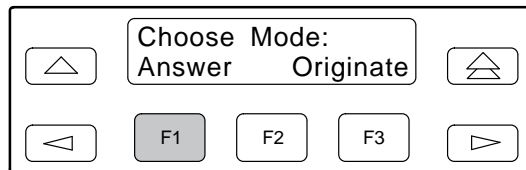
Select Configure from the Top-Level menu.



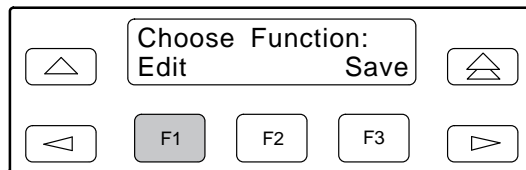
Scroll across the LCD and select the Factory configuration area.



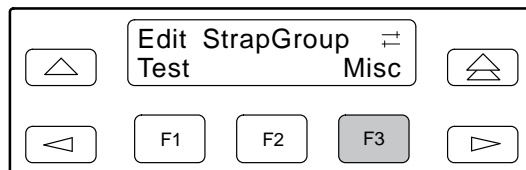
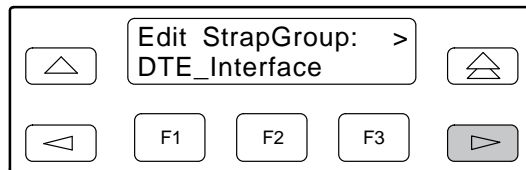
Select Sync\_Leased.



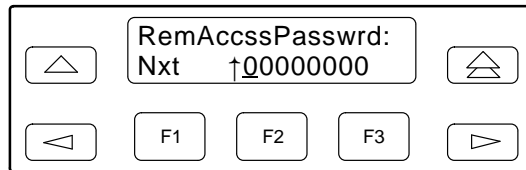
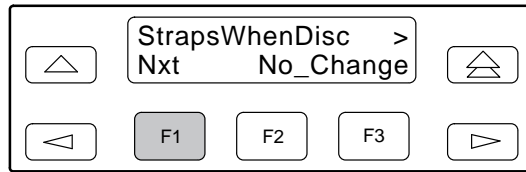
Select Answer.



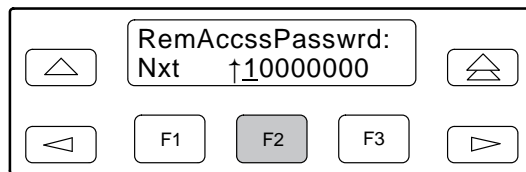
Select Edit.



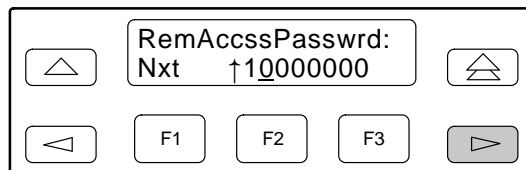
Scroll across the LCD and select the Misc configuration options group.



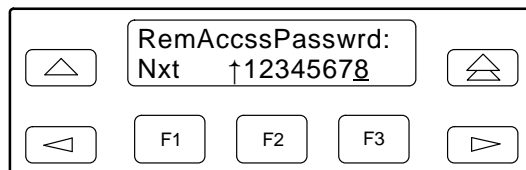
Select Nxt until RemAccssPasswr appears.



Select the F2 (↑) key to increment password values.

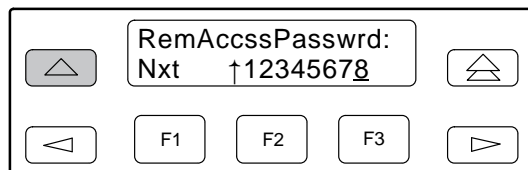


Press the ▷ key to move the cursor to the next position.

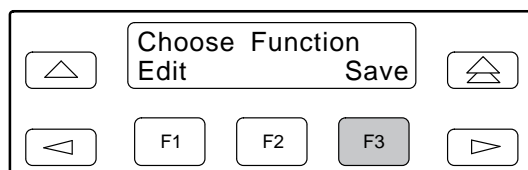


Continue this sequence until you have entered the new password value.

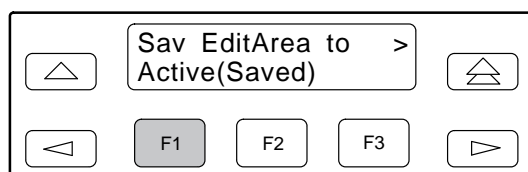
To save the new password to a configuration area, make the following selections:



Press the  $\triangle$  key to scroll up (twice).



Select Save.



Select a configuration area (Active (Saved), Customer 1, or Customer 2) to save the changes.

Select the  $\triangle$  key to exit to the Top-Level menu or select the  $\triangle$  key to remain in the Configure branch.

## Summary

When using the DCP to edit configuration options, keep the following in mind:

- **Nxt** has two functions. First, it indicates that more configuration options are available within that group. These are accessed by selecting Nxt (pressing F1) and scrolling down to the next configuration option. Second, it indicates that what is displayed on the LCD is the current setting. If you scroll left or right, Nxt disappears and reappears if a new value is selected.
- **End** appears when you have scrolled down to the last configuration option available in that group. Selecting End returns you to the top of the configuration group. You are free to enter that group again or scroll left or right to the next configuration options group.
- The  $\triangle$  key takes you one step up in the Configure branch each time it is pressed.
- The  $\triangle$  key causes you to exit the Configure branch and return to the Top-Level menu. If any changes are made to configuration options, the DCP allows you to save these changes to either the Active (Saved), Customer 1, or Customer 2 configuration areas.
- The  $\triangleleft$  and  $\triangleright$  keys move selections across the LCD.
- The function keys F1, F2, and F3 select the LCD choice that appears above that function key.

## Configuration Tables

The modem's configuration options are arranged into nine groups based on functionality: DTE Interface (Table 4-1), DTE Dialer (Table 4-2), Line Dialer (Table 4-3), Dial Line (Table 4-4), Leased Line (Table 4-5), V.42/MNP/Buffer (Table 4-6), Test (Table 4-7), Misc (Table 4-8), and Security (Chapter 6).

Throughout these tables, two selections frequently appear on the LCD: Enable and Disable. Unless otherwise stated, Enable selects a configuration option and makes it available for use; Disable makes a configuration option unavailable for use.

### NOTE

In some countries, the range of allowable values of some configuration options is restricted. The modem will accept any selection, but it will set the configuration option to the closest legal value. The actual value that is accepted by the modem is displayed when the F2 key is pressed to enter a selection.

## DTE Interface

The DTE Interface configuration options contain EIA-232-D (CCITT V.24) and asynchronous character format information essential for maintaining a connection and for transmitting data between the DTE and the modem.

Table 4-1 shows each DTE Interface configuration option as it appears on the LCD, with the Sync Leased factory default setting (the default value if the modem is just being installed) shown following the colon ( : ) on the first line and with all available selections listed on the second line. Following this is a description of the configuration option. Factory default settings are listed in Appendix F.



**Table 4-1**  
**(1 of 10)**  
**DTE Interface Configuration Options**

<p>Async/Sync Mode: Sync Nxt Sync Async</p> <p>Asynchronous/Synchronous Mode. Determines whether the modem operates in Asynchronous mode or Synchronous mode. If the AT command set is enabled and this configuration option is set to Sync, then the modem operates in Async mode when offline.</p> <p>For Async Dial, Async Leased and UNIX Dial, Async is the factory default.</p> <p>The AT commands for Async Mode are &amp;M0 or &amp;Q0. The AT commands for Sync Mode are &amp;M1, &amp;M2, &amp;M3, or &amp;Q1, &amp;Q2, &amp;Q3.</p>
<p>Async DTE Rate: 19200 Nxt 19200 57600 38400 14400 12000 9600 7200 4800 2400 1200 0-300</p> <p><b>This configuration option only appears if Async/Sync Mode is configured for Async.</b></p> <p>Asynchronous DTE Data Rate. Identifies the asynchronous DTE's operating rate to the modem. Data rates from 57,600 bps to 300 bps are supported.</p> <p><b>NOTE:</b> To prevent losing data in 57,600 bps applications, a 16650 UART on the PC's serial port is required, as well as a communications package which can take advantage of its 16-byte buffer. In addition, a 386 PC (25 MHz or faster) is required, and the RS232 cable length must be minimized to reduce capacitance.</p> <p><b>NOTE:</b> To configure the Async DTE Rate different than the modem rate, ensure that the Error Control Mode configuration option (see the <i>V.42/MNP/Buffer</i> section) is set to BufferMode.</p> <p>The AT prefix determines Async DTE Rate.</p>
<p>Asyn #Data Bits: 8 Nxt 8 7 9(DirectMde) 6(DirectMde)</p> <p><b>This configuration option only appears if Async/Sync Mode is configured for Async.</b></p> <p>Asynchronous Number of Data Bits. Determines if the asynchronous data length is composed of 6, 7, 8, or 9 data bits. This data length excludes start, parity, and stop bits.</p> <ul style="list-style-type: none"> <li>■ 8 Sets data length to 8 data bits.</li> <li>■ 7 Sets data length to 7 data bits.</li> <li>■ 9(DirectMode) Sets data length to 9 data bits. Only valid when Error Control configuration option is set to Direct Mode.</li> <li>■ 6(DirectMode) Sets data length to 6 data bits. Only valid when Error Control configuration option is set to Direct Mode.</li> </ul> <p><b>NOTE:</b> If the DTE Dialer Type configuration option is set to AT or V.25bis Async, then the total character size must equal 10 bits. Total character size consists of start, data, parity, and stop bits. V.25bis Async must use 7 data bits with even parity and 1 stop bit. The total character size for Error Control mode, Direct mode, or Buffer mode must be 11 bits or less.</p> <p>The AT prefix determines the async character length.</p>

**Table 4-1**  
**(2 of 10)**  
**DTE Interface Configuration Options**

Asyn Parity Bit: None

Nxt None Even Odd Mark Space

**This configuration option only appears if Async/Sync Mode is configured for Async.**

Asynchronous Parity Bit. Determines the type of asynchronous parity bit. The parity of the DTE must match the parity of the modem. Parity options include None, Even, Odd, Mark, or Space.

- None  
No parity bit is used.
- Even  
Parity bit is set so that total number of 1's in data bits plus parity bit is even.
- Odd  
Parity bit is set so that total number of 1's in data bits plus parity bit is odd.
- Mark  
Parity bit is always set to 1. Only valid if Async #Data Bits configuration option is set to 7.
- Space  
Parity bit is always set to 0. Only valid if Async #Data Bits configuration option is set to 7.

**NOTE:** If the DTE Dialer Type configuration option is set to AT or V.25bis Async, then the total character size must equal 10 bits. Total character size consists of start, data, parity, and stop bits. V.25bis Async must use 7 data bits with even parity and 1 stop bit. The total character size for Error Control mode, Direct mode, or Buffer mode must be 11 bits or less.

The AT prefix determines parity of the async character.

Asyn #Stop Bits: 1

Nxt 1 2

**This configuration option only appears if Async/Sync Mode is configured for Async.**

Asynchronous Number of Stop Bits. Selects 1 or 2 bits to signal the end of an asynchronous character.

**NOTE:** If the DTE Dialer Type configuration option is set to AT or V.25bis Async, then the total character size must equal 10 bits. Total character size consists of start, data, parity, and stop bits. V.25bis Async must use 7 data bits with even parity and 1 stop bit. The total character size for Error Control mode, Direct mode, or Buffer mode must be 11 bits or less.

The AT prefix determines the number of stop bits via autobauding.

**Table 4-1**  
**(3 of 10)**  
**DTE Interface Configuration Options**

DTR Action: Ignore

Nxt Ignore Stndrd\_RS232 CntrlsOnHook CntrlsTxMute

Data Terminal Ready Action. DTR is a signal from the DTE to the modem indicating that the DTE is connected and ready for operation.

- Ignore  
Modem assumes DTR is always ON. This is used when the DTE does not provide DTR.
- Standard RS232  
Allows the DTE to control DTR to the modem as specified in EIA-232-D and CCITT V.24 specifications. If this signal is not present, the modem will not answer or dial.
- Controls On-Hook  
Required for applications in which the host processor must reset itself for the next session before the current session is terminated. When selected, the modem does not disconnect from the VF line during an active call until DTR is lowered by the attached DTE. This setting is ignored if the modem is commanded to disconnect from its own front panel or by the COMSPHERE 6700 Series Network Management System.
- Controls Transmitter Mute  
Mutes the transmitter whenever DTR drops on the DTE interface. This selection can be used on the answer side modem to force the originate modem to initiate a dial backup.

**NOTE:** If V.25bis mode is used, then this configuration option must be set to Stndrd\_RS232. The DTE must provide DTR to dial or answer a call.

**NOTE:** When operating over the dial network, this selection forces DTR Action to behave as CT108/2 (Data Terminal Ready). If DTE Dialer Type configuration option is set to DTR=Direct 1, then DTR Action behaves as CT108/1 (Connect Data Set to Line).

**NOTE:** Only the Stndrd\_RS232 setting is allowed in Austria.

The AT command for Ignore is &D0.

The AT commands for Standard RS232 are &D1 or &D2.

The AT command for CntrlsOnHook is &D4

The AT command for CntrlsTxMute is &D5.

**Table 4-1**  
**(4 of 10)**  
**DTE Interface Configuration Options**

DSR Control: Stndrd\_RS232

Nxt Stndrd\_RS232 Forced\_On WinkWhenDisc Follows\_DTR On\_Early Delay\_ToData

Data Set Ready Control. DSR is a signal from the modem to the DTE indicating the modem is connected and ready for operation.

- Standard RS232

Allows the modem to control DSR to the DTE. The modem raises DSR when it begins the handshake process. DSR lowers upon disconnect. The modem is not ready to receive data until DSR, CTS, and LSD are active. An ON state indicates to the DTE that the modem is ready to receive data. An OFF state indicates that the modem is not ready to receive data, and the DTE will not send data to the modem. During a Local Analog Loop and a Remote Digital Loop, DSR is ON.

- Forced On

Forces DSR output ON constantly. This is usually used for leased-line applications and when the DTE requires DSR to always be ON.

- Wink When Disconnect

DSR is normally forced ON, but is turned OFF for 1 to 2 seconds upon a disconnect.

- Follows DTR

When the modem receives DTR from the DTE, it sends DSR to the DTE.

- On Early

DSR is low when the modem is in the idle state. DSR goes high immediately upon a command to enter Data mode. This setting is required for some modem pooling applications.

- Delay to Data

Operation is similar to the Standard RS232 except that DSR does not turn ON until the modem enters Data mode. Normally, the modem raises DSR when it begins the handshaking process. Use this setting when the DTE cannot operate with a long DSR-to-CTS delay (common for V.32bis modulation) or when dial access security is enabled and requires a DTE-side password entry. Often, the DTE cannot accept the long delay between DSR and CTS turning ON due to the remote user entering the DTE-side password.

The AT command for Forced On is &S0.

The AT command for Standard RS232 is &S1.

The AT command for Wink When Disconnect is &S2.

The AT command for Follows DTR is &S3.

The AT command for On Early is &S4.

The AT command for Delay to Data is &S5.

**Table 4-1**  
**(5 of 10)**  
**DTE Interface Configuration Options**

RTS Action: Stndrd\_RS232

Nxt Stndrd\_RS232 Ignore Sim\_Cntl\_Car Cntl\_Car

Request-to-Send Action. RTS is a signal from the DTE indicating the DTE has data to send.

■ **Standard RS232**

Allows the DTE to control RTS to the modem in normal EIA-232-D operation. RTS must be ON for the DTE to transmit to the modem.

■ **Ignore**

Modem assumes RTS is always ON. Use this selection when the DTE does not provide RTS to the modem.

■ **Simulated Control Carrier**

RTS input controls the remote modem's LSD signal. This is used for DTEs that require Line Signal Detect (LSD) to toggle ON and OFF to simulate half-duplex operation. If RTS Action is set to simulated control carrier, then the remote modem's LSD Control configuration option must be set to Simulated Control Carrier. Simulated Control Carrier conforms to V.13 specifications. This setting is ignored when the modem is configured for Asynchronous mode and RTS/CTS flow control is selected.

■ **Control Carrier**

Allows the DTE's RTS signal to control the modem's carrier signal. When RTS is ON, carrier is present on the VF line. When RTS turns OFF, carrier is not present. This is only valid for V.29 and V.27bis leased-line modulations. Auto Dial Backup is always disabled for this setting.

The AT command for Standard RS232 is &R0.

The AT command for Ignore is &R1.

The AT command for Simulated Control Carrier is &R2.

The AT command for Control Carrier is &R3.

RTS Antistream: 10sec

Nxt 10sec Disable 30sec 1min 2min 3min 5min

**This configuration option only appears in Tmp Tributary mode, or if RTS\_Action is configured for Cntl\_Car (V.29 and V.27bis).**

Request-to-Send Antistreaming. If enabled, the operation of the antistreaming function is as follows. If RTS is ON for a period exceeding the selected time, the modem will take over control of the carrier and will force it OFF. The modem will also force CTS OFF during this time. This condition will stay in effect until the DTE turns RTS OFF. After this, the next time the DTE turns RTS ON, carrier will be turned ON and the RTS timer will start again.

■ **Disable**

The antistreaming function is not in effect.

■ **10 sec, 30 sec, 1 min, 2 min, 3 min, 5 min**

Enables the antistreaming function and sets the maximum ON time for RTS before antistreaming control takes effect.

The AT command is S-Register S72=*n*, where *n* is 0 for Disable, 1 for 10 sec, 2 for 30 sec, 3 for 1 min, 4 for 2 min, 5 for 3 min, and 6 for 5 min.

**Table 4-1**  
**(6 of 10)**  
**DTE Interface Configuration Options**

CTS Control: Stndrd\_RS232

Nxt Stndrd\_RS232 Forced\_On WinkWhenDisc Follows\_DTR Follows\_RTS40

Clear-to-Send Control. CTS is a signal from the modem to the DTE indicating that it can accept data from the DTE.

■ **Standard RS232**

In Synchronous mode, forces the state of CTS to follow the state of RTS in normal EIA-232-D operation. The minimum time that elapses between CTS and RTS is determined by the RTS/CTS Delay configuration option. Use this setting for most synchronous applications. In AT Command mode, CTS goes low just prior to DSR going active and goes high when the modem enters Data mode. This operation prevents losing data in applications which begin transmitting as soon as DSR and CTS are both active.

■ **Forced On**

CTS is forced ON at all times. Use this selection for most asynchronous applications.

■ **Wink When Disconnect**

CTS is normally forced ON, but is turned OFF for 1 to 2 seconds upon a disconnect. Use this for most UNIX® applications.

■ **Follows DTR**

The state of CTS follows the state of DTR. When DTR turns ON, CTS turns ON. When DTR turns OFF, CTS turns OFF.

■ **Follows RTS**

The state of CTS follows the state of RTS. When RTS turns ON, CTS turns ON. When RTS turns OFF, CTS turns OFF.

**NOTE:** When CTS flow control or CTS/RTS flow control is enabled, CTS will turn ON and OFF regardless of the setting of CTS Control.

The AT command for Forced On is \D0.

The AT command for Standard RS232 is \D1.

The AT command for Wink When Disconnect is \D2.

The AT command for Follows DTR is \D3.

The AT command for Follows RTS is \D4.

RTS/CTS Delay: 0msec

Nxt 0msec 10msec 50msec 150msec 600msec

Request-to-Send/Clear-to-Send Delay. RTS/CTS Delay sets the delay time between the modem receiving RTS from the DTE and the modem sending CTS to the DTE.

**NOTE:** This delay is only valid in Async Direct mode and synchronous applications when it is necessary to have a short delay between the time the DTE raises RTS and the time the modem presents CTS to allow the DTE to send data.

**NOTE:** For this configuration option to be valid, both the RTS Action and the CTS Control configuration options must be set to Stndrd RS232. If RTS Action is set to Ignore, RTS is always ON and this configuration option has no effect.

The AT command is S-Register S26=*n*, where *n* is a value from 0 to 255 in 10 millisecond increments.

**Table 4-1**  
**(7 of 10)**  
**DTE Interface Configuration Options**

LSD Control: Stndrd\_RS232

Nxt Stndrd\_RS232 Forced\_On WinkWhenDisc Follows\_DTR Sim\_Cntl\_Car =DTR/DiscOFF

Line Signal Detect Control. LSD is a signal indicating that the carrier signal is being received from the remote modem. It is normally turned OFF to the DTE when the power level of the received carrier signal drops below the carrier detect threshold.

- Standard RS232

LSD is ON when the modem detects the remote modem's carrier signal. LSD turns OFF when the carrier signal strength drops below carrier detect threshold.

- Forced On

Forces LSD to be ON at all times.

- Wink When Disconnect

LSD is normally forced ON, but can be turned OFF for 1 to 2 seconds upon a disconnect. This is used for UNIX® DTEs.

- Follows DTR

The state of LSD follows the state of DTR. When DTR turns ON, LSD turns ON. When DTR turns OFF, LSD turns OFF.

- Simulated Control Carrier

LSD follows the state of RTS of the remote DTE via the V.13 simulated control carrier signaling. This is required for hosts that cannot support full-duplex operation. If LSD Control is set to simulated control carrier, then the RTS Action configuration option on the remote modem must be set to Simulated Control Carrier.

- =DTR/Disconnect OFF

The state of LSD follows the state of DTR except when disconnecting once a connection is established. In this instance, DTR remains ON and LSD turns OFF. DTR must then toggle OFF and then ON again for LSD to turn ON. This setting is required for AT&T DATAKIT™ dial-out applications.

**NOTE:** If LSD Control is set to =DTR/DiscOff, then the DTR Action configuration option must be set to Stndrd\_RS232.

The AT command for Forced On is &C0.

The AT command for Standard RS232 is &C1.

The AT command for Wink When Disconnect is &C2.

The AT command for Follows DTR is &C3.

The AT command for Simulated Control Carrier is &C4.

The AT command for =DTR/Disconnect OFF is &C5.

**Table 4-1  
(8 of 10)  
DTE Interface Configuration Options**

<p>TX Clock Source: Internal Nxt Internal External RXC_Loop</p> <p><b>This configuration option only appears if Async/Sync Mode is configured for Sync.</b></p> <p>Transmit Clock Source. Determines the source of timing for synchronous data transmitted from the modem to the analog channel.</p> <ul style="list-style-type: none"> <li>■ Internal The transmit data's clock source is derived from the modem's internal clock. This clock is available as an output on Pin 15 (TXC) of the EIA-232-D interface.</li> <li>■ External The transmit data's clock source is provided by the DTE on Pin 24 (XTXC) on the EIA-232-D interface.</li> <li>■ Receive Clock Loop The modem's transmit clock is derived from its received analog signal. The derived clock is available as an output on Pin 15 (TXC) of the EIA-232-D interface.</li> </ul> <p>The AT command for Internal is &amp;X0. The AT command for External is &amp;X1. The AT command for RXC Loop is &amp;X2.</p>
<p>Bakup_TXClk_Src: Internal Nxt Internal External RXC_Loop</p> <p><b>This configuration option only appears in customized installations in which the Dual_Leased_Ln is configured for Enable and Async/Sync Mode is Sync.</b></p> <p>Backup Transmit Clock Source. Selects the clock reference source when operating in the Dual Leased Line Mode. This is a special mode in which one leased line is used to back up another.</p> <ul style="list-style-type: none"> <li>■ Internal The transmit data's clock source is derived from the modem's internal clock. This clock is available as an output on Pin 15 (TXC) of the EIA-232-D interface.</li> <li>■ External The transmit data's clock source is provided by the DTE on Pin 24 (XTXC) on the EIA-232-D interface.</li> <li>■ Receive Clock Loop The modem's transmit clock is derived from its received analog signal. The derived clock is available as an output on Pin 15 (TXC) of the EIA-232-D interface.</li> </ul>
<p>XTXC Clamps TXC: Enable Nxt Enable Disable</p> <p><b>This configuration option only appears if TX Clock Source is configured for External.</b></p> <p>External Transmit Clock Clamps Transmit Clock. Allows the modem's TXC output (Pin 15 on the EIA-232-D interface) to be clamped OFF when TX Clock Source is configured for External.</p> <ul style="list-style-type: none"> <li>■ Enable TXC is clamped off when TX Clock Source is configured for External.</li> <li>■ Disable TXC continues to be provided when TX Clock Source is configured for External.</li> </ul> <p>The AT command is S-Register S71=<i>n</i>, where <i>n</i> is 0 for Enable and 1 for Disable.</p>



**Table 4-1**  
**(9 of 10)**  
**DTE Interface Configuration Options**

CT111\_Rate Cntl: Disable

Nxt Disable Fallback1 Fallback2

CT111 Rate Control. Allows the DTE to control modem rate via Pin 23 of the EIA-232-D interface. This configuration option determines the effect of the DTE Rate control signal. CT111 is also known as CH on the EIA-232-D interface.

- Disable  
Disregards CT111 Rate Control.
- Fallback1  
Forces the modem to decrease its configured data rate to the next lower data rate when CT111 is OFF. Valid only for V.32bis, V.33, V.29 modulation. Modem will only fall back within the same modulation scheme. When CT111 turns ON, the modem returns to its previous data rate.
- Fallback2 (**Not available for Tmp tributaries**)  
Forces the modem to decrease two data rates while remaining in the same modulation scheme. When CT111 turns ON, the modem returns to its previous data rate.

**NOTE:** This configuration option is only valid in Async Direct mode and Synchronous mode. For proper operation, disable the V.32bis Autorate and V.32bis Automode configuration options.

The AT command is S-Register S61=*n*, where *n* is 0 for Disable, 1 for Fallback1, and 2 for Fallback2.

DTE\_Rate=VF: Disable

End Disable Enable

**This configuration option does not appear if Async/Sync is configured for Sync.**

DTE Rate = VF. Forces the DTE's data rate to be equal to the VF (telephone line) data rate.

- Disable  
The data rate of the connection between the DTE and modem is the value of the Async DTE Rate configuration option.
- Enable  
The data rate between the DTE and modem is the same as the modem's VF data rate. As a result, when the modem is in Data mode, the speed of the data passed between the modem and DTE occurs at the VF data rate.

The AT command is S-Register S90=*n*, where *n* is 0 for Disable and 1 for Enable.

**Table 4-1**  
**(10 of 10)**  
**DTE Interface Configuration Options**

<p>Extend Main Ch.: Disable Nxt Disable Enable</p> <p><b>Primary data can only be extended one link.</b></p> <p>Extend Main Channel. This configuration option supports extended diagnostics. Specifies whether there is main (primary) channel connectivity between the modem's DTE ports and the DTE ports of modems one level below (downstream) or above (upstream) in the diagnostic network.</p> <ul style="list-style-type: none"> <li>■ Enable If this configuration option is set to Enable on a port of a tributary modem, test mode is propagated to the modems downstream when test mode goes ON for that port.</li> <li>■ Disable If this configuration option is set to Disable on a port of a tributary modem, test mode is not propagated for that port and primary channel data is clamped when in test mode.</li> </ul> <p><b>NOTE:</b> For an extended control modem, this configuration option is used along with the upstream port number where the main (primary) channel is extended.</p>
<p>Upstream Port: Port1 End Port1 Port2 Port3 Port4 Port5 Port6 Port7 Port8</p> <p><b>This configuration option only appears on a control modem when the Extended Main Channel is enabled.</b></p> <p>Upstream Port. When an extended control modem's main (primary) channel is connected to a tributary modem that is one link above it in the diagnostic network, this configuration option is set to the port number to which it is connected on the tributary modem.</p>

## DTE Dialer

The DTE Dialer configuration options establish the DTE-to-modem protocol for call establishment and control.

Table 4-2 shows each DTE Dialer configuration option as it appears on the LCD, with the Sync Leased factory default setting (the default value if the modem is just being installed) shown following the colon ( : ) on the first line and with all available selections listed on the second line. Following this is a description of the configuration option. Factory default settings are listed in Appendix F.

**Table 4-2**  
**(1 of 5)**  
**DTE Dialer Configuration Options**

DTE Dialer Type: Disable

Nxt Disable AT V25bis\_Async V25bis\_Bsync V25bis\_HDLC DTR=Direct1 AT&T\_Exclusv

Data Terminal Equipment Dialer Type. Identifies to the modem the type of dialing method and protocol used by the DTE.

■ **Disable**

Disables any type of DTE dialing method. Dialing can only be performed using the DCP's Dial command or attached telephone.

■ **AT**

Allows AT command protocol to be used as a method for entering commands and dialing when used in an asynchronous application. This is the only valid setting for leased-line applications. The modem will not respond to AT commands if DTE Dialer Type is not set to AT.

■ **V.25bis Async**

Selects V.25bis Async as the dialing method and protocol used by the modem. The character length must be 7 data bits with even parity and 1 stop bit.

■ **V.25bis Bsync**

Selects V.25bis Bsync as the dialing method and protocol used by the modem. This is also known as character-oriented protocol. This framing protocol uses two synchronous control characters and a start-of-text control character before the text block and an end-of-text control character after the text block. The correct character structure for V.25bis Bsync dialing is 7 data bits, Odd parity, and 1 stop bit. If the modem is in Asynchronous mode, enter the following command string to configure it for V.25bis Bsync dialing: AT&F&D1&S1&M233&W. If the modem is already configured for synchronous operation, perform the following to set the character format: (1) use the modem's front panel to access the Async/Sync Mode configuration option and set it to Async; (2) scroll down until the Asyn #Data Bits configuration option appears and set it to 7 data bits; (3) scroll down and set the Asyn Parity Bit configuration option to Odd; (4) scroll through the DTE Interface group until the Async/Sync Mode configuration option appears and set it to Sync; (5) move up one level in the menu tree or move to the Top-Level menu, and follow the LCD messages to save the new modem settings.

■ **V.25bis HDLC**

Selects V.25bis HDLC as the dialing method and protocol used by the modem. This is also known as bit-oriented protocol. This framing protocol uses flag, address and control characters before the text block and a frame sequence check and flag after the text block.

■ **DTR=Direct1**

Allows the modem to automatically dial the number stored in directory location 1 whenever DTR turns ON. DTR dialing cannot be used if dial access security is enabled.

■ **AT&T Exclusive**

Enables a subset of the proprietary AT&T command set, which is required for some applications that use AT&T equipment. Currently, the only application supported is AT&T DATAKIT.

The AT commands for AT are &M0, &M1, &M3 or &Q0, &Q1, &Q3.

The AT commands for DTR=Direct1 dialing are &M2 or &Q2.

**Table 4-2**  
**(2 of 5)**  
**DTE Dialer Configuration Options**

<p>AT Escape Char: 043 ASCI Nxt ↑ 043 ASCI</p> <p><b>This configuration option only appears if DTE Dialer Type is configured for AT.</b></p> <p>AT Escape Character. The escape sequence (+++) allows you to move from Data mode to Command mode. Use the AT Originate (ATO) command to return to Data mode. The ASCII value of the escape character (43 ASCII) can be set to any ASCII value from 0 ASCII to 255 ASCII. However, the escape character is disabled if a value greater than 127 ASCII is entered. When disabled, the call must be disconnected to return to Command mode.</p> <p>The AT command is S-Register S2=<i>n</i>, where <i>n</i> is a value from 0 to 127. The AT command to disable is S-Register S2=<i>n</i> where <i>n</i> is a value from 128 to 255. (When disabled, the modem cannot return to Command mode unless disconnected.)</p>
<p>Escape GuardTim: 1sec Nxt 1sec 200msec 400msec 600msec 800msec 2sec</p> <p><b>This configuration option only appears if DTE Dialer Type is configured for AT.</b></p> <p>Escape Guard Time. Determines the length of the required pause before and after the escape sequence is issued. The guard time prevents the modem from interpreting data as the escape sequence characters.</p> <p>The AT command is S-Register S12=<i>n</i>, where <i>n</i> is a value from 0 to 255 in 20 millisecond increments.</p>
<p>BreakForceEscap: Disable Nxt Disable Enable</p> <p><b>This configuration option only appears if DTE Dialer Type is configured for AT.</b></p> <p>Break Forces Escape. Determines whether or not the modem should enter Command mode when it receives a break character from the DTE.</p> <ul style="list-style-type: none"> <li>■ Disable A break character is sent to the remote end.</li> <li>■ Enable Modem escapes into AT Command mode, and a break character is not sent to the remote end.</li> </ul> <p>The AT commands for Enable are \K0, \K2, or \K4. The AT commands for Disable are \K1, \K3, or \K5.</p>
<p>CommandCharEcho: Enable Nxt Enable Disable</p> <p><b>This configuration option only appears if DTE Dialer Type is configured for AT.</b></p> <p>Command Character Echo. Controls whether or not characters are echoed back to the DTE when the modem is in Command mode.</p> <p>The AT command for Disable is E0. The AT command for Enable is E1.</p>

**Table 4-2**  
**(3 of 5)**  
**DTE Dialer Configuration Options**

<p>CarriageRtn Char: 013 ASCI Nxt ↑ 013 ASCI</p> <p><b>This configuration option only appears if DTE Dialer Type is configured for AT.</b></p> <p>Carriage Return Character. Allows you to change the ASCII character used to terminate an AT command to any ASCII value from 0 to 127.</p> <p>The AT command is S-Register S3=<i>n</i>, where <i>n</i> is a value from 0 to 127.</p>
<p>Backspace Char: 008 ASCI Nxt ↑ 008 ASCI</p> <p><b>This configuration option only appears if DTE Dialer Type is configured for AT.</b></p> <p>Backspace Character. Sets the character used to perform a backspace in Command mode.</p> <p>The AT command is S-Register S5=<i>n</i>, where <i>n</i> is a value from 0 to 127.</p>
<p>Linefeed Char: 010 ASCI Nxt ↑ 010 ASCI</p> <p><b>This configuration option only appears if DTE Dialer Type is configured for AT.</b></p> <p>Line Feed Character. Sets the character used to perform a line feed in Command mode for responses from the modem.</p> <p>The AT command is S-Register S4=<i>n</i>, where <i>n</i> is a value from 0 to 127.</p>
<p>Result Codes: Enable Nxt Enable Disable EnableInOrig</p> <p><b>This configuration option only appears if DTE Dialer Type is configured for AT.</b></p> <p>Result Codes. Result codes are informational messages (such as Connect and Ring) sent from the modem and displayed on the asynchronous DTE terminal. (For a list of Result Codes, refer to Table 5-1 in Chapter 5, <i>AT Commands and S-Registers</i>.)</p> <ul style="list-style-type: none"> <li>■ Enable Modem sends result codes to the DTE.</li> <li>■ Disable Modem does not send result codes to the DTE.</li> <li>■ Enable in Originate For UNIX® applications, enable result codes only on the originating modem. This prevents the DTE on the answer side from interpreting result codes as login attempts.</li> </ul> <p>The AT command for Enable is Q0. The AT command for Disable is Q1. The AT command for Enable in Originate mode is Q2.</p>

**Table 4-2**  
**(4 of 5)**  
**DTE Dialer Configuration Options**

ExtendResltCode: Enable

Nxt Enable Disable Add/EC Add/V42,MNP Use\_DTE\_Rate

**This configuration option only appears if DTE Dialer Type is configured for AT.**

Extended Result Codes. Informational messages such as VF data rate and Error Control are displayed with the result codes. (For a list of Extended Result Codes, refer to Table 5-1 in Chapter 5, *AT Commands and S-Registers*.)

■ Enable

**NO DIALTONE, BUSY, NO ANSWER, and CONNECT xxxx** (xxxx = VF data rate) appear along with result codes listed in Table 5-1 in Chapter 5.

■ Disable

Only **OK, CONNECT, RING, NO CARRIER, and ERROR** result codes appear.

■ Add/EC

Places the EC suffix after the result code text if error control is used. For example, **CONNECT 9600/EC**.

■ Add/V.42 or /MNP

Places either the /V.42 or /MNP suffix after the result code text if data compression is used. For example, **CONNECT 9600/V42b**.

■ Use DTE Rate

Allows the DTE rate to be displayed in the Connect message instead of the line rate. This feature is required in some modem pooling applications.

**NOTE:** NO DIALTONE is valid only if Dial Tone Detect configuration option is enabled. BUSY appears if Busy Detect configuration option is enabled.

The AT command for Disable is X0.

The AT commands for Enable are X1, X2, X3, or X4.

The AT command for Add/EC is X5.

The AT command for Add/V42,MNP is X6.

The AT command for Use DTE Rate is X7.

ResultCode Form: Words

Nxt Words Numbers (1) Numbers (2)

**This configuration option only appears if DTE Dialer Type is configured for AT.**

Result Codes Format. Controls whether or not result codes appear as words or as numeric codes. Some DTEs do not recognize Result Codes as words; therefore, numbers are required. The Numbers (2) format is required for some modem pooling applications. (For a list of Result Codes, refer to Table 5-1 in Chapter 5, *AT Commands and S-Registers*.)

The AT command for Numbers (1) is V0.

The AT command for Words format is V1.

The AT command for Numbers (2) is V2.

**Table 4-2**  
**(5 of 5)**  
**DTE Dialer Configuration Options**

<p>AT Cmnd Mode: Normal Nxt Normal No_ERROR NoStrapOrERR</p> <p><b>This configuration option only appears if DTE Dialer Type is configured for AT.</b></p> <p>AT Command Mode. Determines how the modem responds to valid and invalid AT commands.</p> <ul style="list-style-type: none"> <li>■ Normal Allows normal operation of the AT command set. The modem acts upon all valid AT commands and issues the ERROR result code for invalid commands. If a string with multiple commands is entered, then an invalid command within that string will prevent the execution of subsequent valid commands.</li> <li>■ No ERROR Operates similar to Normal mode, however, the modem does not issue an ERROR result code for invalid commands. When an invalid command is encountered, the modem ignores it and issues the OK result code. If a string with multiple commands is entered, then an invalid command within that string will not prevent the execution of subsequent valid commands.</li> <li>■ No Strap or ERROR Ignores all AT commands (including valid commands) that cause a configuration option to change. Only non-configuring commands (for example ATD, ATA, and ATI) are executed; the ERROR result code is never returned.</li> </ul> <p><b>NOTE:</b> Since this configuration option affects AT commands, it cannot be changed by the AT&amp;F command. However, it can be changed by selecting a factory preset configuration via the DCP.</p> <p>The AT command is S-Register S84=<i>n</i>, where <i>n</i> is 0 or 231 for Normal, 1 or 232 for No ERROR, and 2 or 233 for No Strap or ERROR.</p>
<p>V25bis Coding: ASCII Nxt ASCII EBCDIC</p> <p><b>This configuration option only appears if DTE Dialer is configured for V.25bis HDLC or V.25bis Bsync.</b></p> <p>V.25bis Coding. Identifies to the modem whether the DTE is using ASCII code or EBCDIC code for V.25bis commands. The modem responds to the DTE using the same coding.</p> <p>The AT command is S-Register S62=<i>n</i>, where <i>n</i> is 0 for ASCII or 1 for EBCDIC.</p>
<p>V25bis IdleFill: Mark Nxt Mark Flag</p> <p><b>This configuration option only appears if DTE Dialer is configured for V.25bis HDLC.</b></p> <p>V.25bis Idle Fill. Determines whether a mark or flag is used as an idle fill character for the DTE. The modem responds to the DTE using the same idle fill.</p> <p>The AT command is S-Register S63=<i>n</i>, where <i>n</i> is 0 for Mark or 1 for Flag.</p>
<p>V25b NewLineChr: CR+LF End CR+LF CR LF</p> <p><b>This configuration option only appears if DTE Dialer is configured for V.25 bis Async.</b></p> <p>V.25bis New Line Character. Sets the modem for the command line terminator used by the DTE in V.25bis Async mode. The modem responds to the DTE using the same line terminator.</p> <p>The AT command is S-Register S64=<i>n</i>, where <i>n</i> is 0 for carriage return and line feed, 1 for carriage return, or 2 for line feed.</p>

## Line Dialer

The Line Dialer configuration options establish parameters used by the modem to answer or originate calls.

Table 4-3 shows each Line Dialer configuration option as it appears on the LCD, with the Sync Leased factory default setting (the default value if the modem is just being installed) shown following the colon ( : ) on the first line and with all available selections listed on the second line. Following this is a description of the configuration option. Factory default settings are listed in Appendix F.

**Table 4-3**  
**(1 of 5)**  
**Line Dialer Configuration Options**

<p>AutoAnswerRing#: 1 Nxt 1 Disable 2 4 6 8 10</p> <p>Auto-Answer Ring Count. Determines the number of rings necessary before the answering modem answers an incoming call. For example, if this option is set to 2, then the answering modem answers after the second ring.</p> <ul style="list-style-type: none"> <li>■ Disable           <ul style="list-style-type: none"> <li>If selected, the modem must be answered using either the DCP's Answer command or Tlk/Data function or via AT commands. Refer to Talk/Data in Chapter 3, <i>DCP Operation</i>, for more on Manual Answer.</li> </ul> </li> </ul> <p><b>NOTE:</b> Although DCP selections are limited (1, 2, 4, 6, 8, or 10), values set by AT commands can display from 1 to 255 rings.</p> <p><b>NOTE:</b> The range of allowable values may be restricted in some countries.</p> <p>The AT command for Disable is S0=0. The AT command is S-Register S0=<i>n</i>, where <i>n</i> is a ring count from 1 to 255.</p>
<p>Dialer Type: Tone Nxt Tone Pulse</p> <p>Dialer Type. Selects either tone (DTMF) dialing or pulse (rotary) dialing mode.</p> <p><b>NOTE:</b> Pulse Mode is disabled in Denmark and in Sweden.</p> <p>The AT command for Tone is T. The AT command for Pulse is P.</p>
<p>DialTone Detect: Enable Nxt Enable Disable</p> <p>Dial Tone Detect. Sets the modem for dial tone detection (enable) or blind dialing (disable).</p> <ul style="list-style-type: none"> <li>■ Enable           <ul style="list-style-type: none"> <li>Modem disconnects the call if a dial tone is not detected within 10 seconds and displays <b>No Dial Tone</b> on both the LCD and asynchronous DTE terminal.</li> </ul> </li> <li>■ Disable           <ul style="list-style-type: none"> <li>Modem dials a call whether or not it detects a dial tone on the line. This is known as blind dialing. The period of time the modem waits before dialing is specified in the Blind Dial Pause configuration option.</li> </ul> </li> </ul> <p><b>NOTE:</b> It may not be possible to disable Dial Tone Detect in some countries.</p> <p>The AT commands for Disable are X0, X1, and X3. The AT commands for Enable are X2, X4, X5, X6, and X7.</p>



**Table 4-3**  
**(2 of 5)**  
**Line Dialer Configuration Options**

<p>Blind Dial Pause: 2sec Nxt 2sec 4sec 6sec 8sec 10sec 20sec</p> <p><b>This configuration option only appears when Dial Tone Detect is configured for Disable.</b></p> <p>Blind Dial Pause. Determines how long the modem waits before dialing a telephone number when Dialtone Detect is disabled.</p> <p><b>NOTE:</b> The range of allowable values may be restricted in some countries.</p> <p>The AT command is S-Register S6=<i>n</i>, where <i>n</i> is from 2 to 255 in 1-second increments.</p>
<p>BusyTone Detect: Enable Nxt Enable Disable</p> <p>Busy Tone Detect. Sets the modem to monitor for Busy Tone (Enable) or ignore Busy Tone (Disable).</p> <p><b>NOTE:</b> This configuration option is normally enabled; however, if the modem receives false busy tones, this configuration option can be disabled and the modem ignores all busy tones.</p> <p>The AT commands for Disable are X0, X1, and X2. The AT commands for Enable are X3, X4, X5, X6, and X7.</p>
<p>“,” Pause Time: 2sec Nxt 2sec 4sec 6sec 8sec 10sec 20sec</p> <p>Pause Time. Determines the number of seconds the modem pauses when it encounters a comma (,) in the dial command string.</p> <p><b>NOTE:</b> Although DCP selections are limited (2, 4, 6, 8, 10, or 20), values set by the AT commands can display from 0 to 255 seconds.</p> <p>The AT command is S-Register S8=<i>n</i>, where <i>n</i> is from 0 to 255 in 1-second increments.</p>
<p>NoAnswer Timeout: 45sec Nxt 45sec 30sec 60sec 120sec</p> <p>No Answer Abort Time-out. Determines the number of seconds an originating modem waits before abandoning a call attempt when no answer tone is received.</p> <p><b>NOTE:</b> Although DCP selections are limited (30, 45, 60, or 120), values set by AT commands can display from 1 to 255 seconds.</p> <p><b>NOTE:</b> The range of allowable values may be restricted in some countries.</p> <p>The AT command is S-Register S7=<i>n</i>, where <i>n</i> is from 1 to 255 in 1-second increments.</p>

**Table 4-3**  
**(3 of 5)**  
**Line Dialer Configuration Options**

<p>Fast Disconnect: Disable Nxt Disable Enable</p> <p>Fast Disconnect. Allows the modem to disconnect immediately after receiving a disconnect command from a local DTE or its own diagnostic control panel.</p> <ul style="list-style-type: none"> <li>■ Disable The modem follows its normal disconnect sequence by issuing a cleardown sequence or long space disconnect. This is also known as a graceful disconnect since the other modem receives advance notice of a disconnection.</li> <li>■ Enable Use this setting if the DTE requires that the modem be made available as soon as possible after receiving a disconnect command.</li> </ul> <p><b>NOTE:</b> This abrupt method of disconnecting may cause problems with the remote modem, which may interpret the disconnection as an error instead of a valid disconnect.</p> <p>The AT command is S-Register S85=<i>n</i>, where <i>n</i> is 0 for Disable and 1 for Enable.</p>
<p>Line Crnt Disc: Enab(&gt;8msec) Nxt Enab(&gt;8msec) Enab(&gt;90msec) Disable</p> <p><b>This configuration option does not appear on Models 3910-A1-401 and 3911-B1-001.</b></p> <p>Line Current Disconnect. Determines the modem's response to short interruptions of line current. The loss of line current is one method of disconnecting a call.</p> <ul style="list-style-type: none"> <li>■ Enable &gt; 8-millisecond Disconnects the modems if line current is disrupted for more than 8 milliseconds.</li> <li>■ Enable &gt; 90-millisecond Disconnects the modems if line current is disrupted for more than 90-milliseconds. Use this setting if the modem constantly disconnects when set to Enab(&gt;8msec).</li> <li>■ Disable Ignores any disruptions in line current such as call waiting.</li> </ul> <p>The AT command is S-Register S65=<i>n</i>, where <i>n</i> is 0 for Enable (&gt;8 msec), 1 for Enable (&gt;90 msec), and 2 for Disable.</p>
<p>Long Space Disc: Enable Nxt Enable Disable</p> <p>Long Space Disconnect. Determines the modem's response to a continuous spacing condition sent from the remote modem before it goes on-hook. Issuing a long space is one method of disconnecting a call.</p> <ul style="list-style-type: none"> <li>■ Enable Modem disconnects if it receives a continuous space from the DTE. For modulations lower than 4800 bps, the modem's transmitter will transmit 4 seconds of long space upon a disconnect.</li> <li>■ Disable Modem does not disconnect if it receives a continuous space from the DTE. Modem will not transmit a long space disconnect.</li> </ul> <p>The AT command for Disable is Y0. The AT command for Enable is Y1.</p>

**Table 4-3**  
**(4 of 5)**  
**Line Dialer Configuration Options**

<p>No Carrier Disc: 2sec Nxt 2sec Disable 5sec 10sec 20sec</p> <p>No Carrier Disconnect. If the modem no longer receives carrier from the remote modem, it disconnects the call. This configuration option determines how long carrier is OFF before the modem disconnects. Loss of carrier is one method of disconnecting a call.</p> <ul style="list-style-type: none"> <li>■ 2, 5, 10, 20 sec Modem disconnects if carrier turns OFF for more than 2 seconds, 5 seconds, 10 seconds, or 20 seconds.</li> <li>■ Disable Modem does not disconnect if carrier turns OFF.</li> </ul> <p><b>NOTE:</b> The range of allowable values may be restricted in some countries.</p> <p>The AT command is S-Register S10=<i>n</i>, where <i>n</i> is 255 for Disable or 0 to 254 in 0.1 second increments for Enable.</p>
<p>No Data Disc: Disable Nxt Disable 10min 30min 60min</p> <p>No Data Disconnect. Forces the modem to disconnect if no data is transmitted and received within a specified amount of time.</p> <ul style="list-style-type: none"> <li>■ Disable Modem remains connected despite the lack of data flow.</li> <li>■ 10, 30, 60 min Modem disconnects if data is not received and transmitted within 10-minute, 30-minute, or 60-minute intervals.</li> </ul> <p><b>NOTE:</b> The factory default value is country dependent.</p> <p>The AT command for Enable is \T<i>n</i>, where <i>n</i> is from 1 minute to 255 minutes. The AT command for Disable is \T0.</p>
<p>Auto Make Busy: Disable Nxt Disable Enable</p> <p><b>This option is only valid with the Model 3911 and does not appear on the Model 3910's LCD.</b></p> <p>Automatic Make Busy. Forces the modem to go off-hook under the following conditions: if a local analog loopback is performed, a self-test is performed, or if the modem is switched to the service line.</p> <p><b>NOTE:</b> This configuration option should only be used when the modem is located behind a user's Private Branch Exchange (PBX). The Make Busy Network Interface Module (NIM) must be installed on the COMSPHERE 3000 Series Carrier. Refer to the <i>COMSPHERE 3000 Series Carrier, Installation Manual</i>.</p> <p>The AT command is S-Register S40=<i>n</i>, where <i>n</i> is 0 for Disable and 1 for Enable.</p>

**Table 4-3**  
**(5 of 5)**  
**Line Dialer Configuration Options**

MakeBusyVia DTR: Disable  
End Disable Enable

Make Busy Via DTR. Determines if the modem goes off-hook when DTR is OFF. Enable this setting if the DTE normally keeps DTR ON and turns DTR OFF when the DTE cannot accept a call.

**NOTE:** This configuration option should only be used when the modem is located behind a user's Private Branch Exchange (PBX). For 3911 modems, the Make Busy Network Interface Modules (NIMs) must be installed on the COMSPHERE 3000 Series Carrier. Refer to the *COMSPHERE 3000 Series Carrier, Installation Manual*.

The AT command is S-Register S69= $n$ , where  $n$  is 0 for Disable and 1 for Enable.

## Dial Line

The Dial Line configuration options are used to configure the modem for operation over dial lines.

Table 4-4 shows each Dial Line configuration option as it appears on the LCD, with the Sync Leased factory default setting (the default value if the modem is just being installed) shown following the colon ( : ) on the first line and with all available selections listed on the second line. Following this is a description of the configuration option. Factory default settings are listed in Appendix F.

**Table 4-4**  
**(1 of 3)**  
**Dial Line Configuration Options**

Dial Line Rate: 19200(V32t)

Nxt 19200(V32t) 16800(V32t) 14400(V32b) 12000(V32b) 9600(V32b) 7200(V32b) 4800(V32b)  
2400(V22bis) 1200(V22) 1200(212A) 0-300(V21) 0-300(103J) 1200/75(V23) 75/1200(V23)  
600/75(V23) 75/600(V23)

Dial Line Rate. This configuration option determines the modem's data rate and modulation scheme for operation on dial lines. Online changes do not take effect until a disconnect occurs.

**NOTE:** Certain changes to this configuration option will cause the modem to reset.

- 19200(V32t), 16800(V32t), 14400(V32b), 12000(V32b), 9600(V32b), 7200(V32b), 4800(V32b)  
The modem operates using V.32 terbo, V.32bis, or V.32 modulation at the data rate selected.
- 2400(V22bis), 1200 (V22), 1200(212A)  
Modem operates using the modulation and data rate selected.
- 0-300(V21), 0-300(103J)  
Modem operates in full-duplex, Asynchronous mode. These data rates do not support V.42 or MNP error control.
- 1200/75(V23), 75/1200(V23), 600/75(V23), 75/600(V23)  
The modem will run in asynchronous semi-full duplex mode at the rate chosen.

The AT command is S-Register S41=*n*, where *n* is:

1 = 14,400 (V.32bis)	6 = 2400 (V.22bis)	12 = 1200/75 (V.23)	20 = 19200 (V.32 terbo)
2 = 12,000 (V.32bis)	7 = 1200 (V.22)	13 = 75/1200 (V.23)	21 = 16800 (V.32 terbo)
3 = 9600 (V.32bis/V.32)	8 = 1200 (212A)	18 = 600/75 (V.23)	
4 = 7200 (V.32bis)	10 = 0-300 (V.21)	19 = 75/600 (V.23)	
5 = 4800 (V.32bis/V.32)	11 = 0-300 (103J)		

**Table 4-4**  
**(2 of 3)**  
**Dial Line Configuration Options**

<p>V32bis Automode: Enable Nxt Enable Disable System 85</p> <p><b>This configuration option only appears when Dial Line Rate is configured for V.32 terbo, V.32bis, or V.32 data rate.</b></p> <p>V.32bis Automode. The modem automatically adapts to the modulation scheme and line rate of the remote modem. However, the maximum data rate the modem uses is determined by the Dial Line Rate configuration option.</p> <ul style="list-style-type: none"> <li>■ System 85 Enables the full automode function with special provisions which are needed to work reliably in a System 85 or similar PBX modem pool.</li> </ul> <p><b>NOTE:</b> When the V.32bis Automodding configuration option is enabled, the V.21 protocol (0–300 bps) is excluded from the Automodding sequence. Instead, the modem uses the Bell 103J protocol for 0–300 bps operation.</p> <p>The AT command is S-Register S78=<i>n</i>, where <i>n</i> is 0 for Enable, 1 for Disable, and 2 for System 85.</p>
<p>V32bis Autorate: Enable Nxt Enable Disable StartAt48 StartAt96</p> <p><b>This configuration option only appears when Dial Line Rate is configured for V.32 terbo, V.32bis, or V.32 data rate.</b></p> <p>V.32bis Autorate. Once connected, the modem automatically lowers the line rate if line conditions become impaired. When line conditions improve, the modem automatically shifts up to the highest data rate the line can support. This autorating only occurs between 19,200 bps and 4800 bps during V.32/V.32bis/V.32 terbo connections.</p> <ul style="list-style-type: none"> <li>■ Start at 48 and Start at 96 Set the maximum connect rate for V.32/V.32bis/V.32 terbo connections.</li> </ul> <p>The AT command is S-Register S76=<i>n</i>, where <i>n</i> is 0 for Enable, 1 for Disable, 2 for Start at 48, and 3 for Start at 96.</p>
<p>V32bis Override: Disable Nxt Disable 2400 1200</p> <p><b>This configuration option is ignored unless Dial Line Rate is 4800(V32b).</b></p> <p>V.32bis Override. Activates the Paradyne Point-to-Point Diagnostic 2400 bps or 1200 bps modulation. Allows the modem to use a non-standard, point-to-point modulation capable of secondary channel diagnostics while running at 2400 bps or 1200 bps.</p> <p><b>NOTE:</b> This configuration option must be the same in both the local and remote modems.</p> <p><b>NOTE:</b> The 1200 bps selection is available only if the Proprietary 1200 device option is installed.</p>
<p>Dial TX Level: The factory default setting is country dependent. It is Permissv(–9) in North America Nxt Permissv(–9) –10 –11 –12 –13 –14 –15 –16 –17 –18 –19 –20 –21 –22 –23 –24 –25 –26 –27 –28 –29 –30 –31 –32</p> <p>Dial Transmit Level. Selects the modem's transmit power level over dial lines. The transmit output level can be selected in 1 dBm decrements from –9 dBm to –32 dBm.</p> <p><b>NOTE:</b> In North America the range of allowable values is –10 dBm to –32 dBm, plus Permissive (–9 dBm). This configuration option is locked in other countries (the user cannot change the level).</p> <p>The AT command is &amp;In, where <i>n</i> is from 10 to 32 corresponding to –10 dBm to –32 dBm.</p>

**Table 4-4**  
**(3 of 3)**  
**Dial Line Configuration Options**

V22b Guard Tone: Disable  
Nxt Disable 550Hz 1800Hz

**This configuration option only appears when Dial Line Rate is configured for V.22bis or V.22 data rate, or when V.32bis Automode is configured for Enable.**

V.22bis Guard Tone. Determines whether the V.22bis guard tone is disabled, set to 550 Hz, or set to 1800 Hz.

- Disable  
No guard tone.
- 550 Hz or 1800 Hz  
When the modem is in Answer mode, it transmits the guard tone at this frequency.

**NOTE:** The V.22bis Guard Tone cannot be disabled in some countries.

The AT command for Disable is &G0.

The AT command for 550 Hz is &G1.

The AT command for 1800 Hz is &G2.

V32bis Train: Long  
End Long Short

**This configuration option only appears when Dial Line Rate is configured for V.32 terbo, V.32bis, or V.32 data rate.**

V.32bis Train. Controls V.32 terbo/V.32bis/V.32 train time. Determines whether minimum or maximum time durations are used during the V.32 terbo/V.32bis/V.32 handshaking sequence for both dial and 4-wire/2-wire leased-line applications.

- Long  
Selects long train. Use this setting whenever far-end frequency offset (phase roll) may be encountered. This is usually only required when transmitting over satellite links.
- Short  
Allows the modem to train-up faster when using V.32 terbo/V.32bis/V.32 modulation.

The AT command is S-Register S43=*n*, where *n* is 0 for Long and 1 for Short.

## Leased Line

The Leased Line configuration options only appear when the Sync Leased factory preset template is selected. They are used to configure the modem for operation over leased lines.

Table 4-5 shows each Leased Line configuration option as it appears on the LCD, with the Sync Leased factory default setting (the default value if the modem is just being installed) shown following the colon ( : ) on the first line and with all available selections listed on the second line. Following this is a description of the configuration option. Factory default settings are listed in Appendix F.

**Table 4-5**  
**(1 of 6)**  
**Leased Line Configuration Options**

<p>Leased Mode: 4WLL-Ans Nxt 4WLL-Ans 4WLL-Orig 2WLL-Orig 2WLL-Ans</p> <p>Leased Mode. Sets the modem for either 2-wire or 4-wire operation in Answer mode (receiving a call) or 2-wire or 4-wire operation in Originate (initiating a call) mode.</p> <p><b>NOTE:</b> For proper operation of V.32 modulations over leased lines, one modem must be set to Originate mode and the other set to Answer mode.</p> <p>For Sync Leased Answer Mode, Async Leased Answer Mode and Trellis Multipoint Tributary Mode, 4-wire Answer is the factory default.</p> <p>For Sync Leased Originate Mode, Async Leased Originate Mode and Trellis Multipoint Control Mode, 4-wire Originate is the factory default.</p> <p>The AT command for Disable is &amp;L0. The AT command for 2-wire Originate is &amp;L1. The AT command for 4-wire Originate is &amp;L2. The AT command for 2-wire Answer is &amp;L3. The AT command for 4-wire Answer is &amp;L4.</p>
---



**Table 4-5**  
**(2 of 6)**  
**Leased Line Configuration Options**

LeasedLine Rate: 19200(V32t)

Nxt 19200(V32t) 16800(V32t) 14400(V32b) 12000(V32b) 9600(V32b) 7200(V32b) 4800(V32b)  
19200(TMp) 14400(TMp) 9600(TMp) 7200(TMp) 4800(TMp) 2400(TMp) 2400(V22bis) 14400(V33)  
12000(V33) 9600(V29) 7200(V29) 4800(V29) 4800(V27bis) 2400(V27bis)

Leased-Line Rate. Determines the modem's data rate and modulation scheme for operation on leased lines.

**NOTE:** Certain changes to this configuration option will cause the modem to reset.

- 19200(V32t), 16800(V32t), 14400(V32b), 12000(V32b), 9600(V32b), 7200(V32b), 4800(V32b)  
The modem operates using V.32bis or V.32 terbo modulation at the data rate selected. These modulation schemes are available on 2-wire or 4-wire leased lines.
- 19200(TMp), 14400(TMp), 9600(TMp), 7200(TMp), 4800(TMp), 2400(TMp)  
The modem operates in Trellis Multipoint mode at the data rate selected. These modulation schemes are available on 4-wire leased lines. The 19200(TMp) modulation does not appear on tributary modems.

**NOTE:** TMp control modems can accept mixed inbound rates from tributary modems. For example, one inbound link may be configured for 14.4 kbps while another link experiencing line impairments may be configured for 9.6 kbps. The following control/tributary rate combinations are allowed: control at 19.2 kbps, tributaries at 14.4 or 9.6 kbps; control at 14.4 kbps, tributaries at 14.4 or 9.6 kbps; control at 9.6 kbps, tributaries at 9.6 or 7.2 kbps; control at 7.2 kbps, tributaries at 7.2 or 4.8 kbps; control at 4.8 kbps, tributaries at 4.8 or 2.4 kbps; control at 2.4 kbps, tributaries at 2.4 kbps. Tributary rates will never exceed control rates. If tributary and control rates are equal, reducing the control rate automatically reduces the tributary rate.

- 2400(V22bis)  
This modulation scheme is available on 2-wire and 4-wire leased lines.
- 14400(V33), 12000(V33)  
These modulation schemes are only available on 4-wire leased lines.
- 9600(V29), 7200(V29), 4800(V29)  
These modulation schemes are only available on 4-wire leased lines.
- 4800(V27bis), 2400(V27bis)  
This modulation scheme is available on 2-wire (half-duplex) and 4-wire leased lines.

**NOTE:** It is recommended that both modems use the same fixed data rate.

**NOTE:** The modem must be in Direct mode before the modulation scheme can be changed from V.32bis to another leased-line modulation (V.33, V.29, or V.22bis). See Err Contrl Mode configuration option for more about Direct mode. On leased lines, V.42 error control and Buffer mode are only supported by V.32bis. An error occurs if the modem is not in Direct mode when the modulation is changed from V.32bis.

The AT command is S-Register S44=*n*, where *n* is:

1 = 14,400 (V.32bis)	12 = 12,000 (V.33)	19 = 16,800 (V.32 terbo)
2 = 12,000 (V.32bis)	13 = 9600 (V.29)	20 = 19,200 (TMp)
3 = 9600 (V.32bis)	14 = 7200 (V.29)	21 = 14,400 (TMp)
4 = 7200 (V.32bis)	15 = 4800 (V.29)	22 = 9600 (TMp)
5 = 4800 (V.32bis)	16 = 4800 (V.27bis)	23 = 7200 (TMp)
6 = 2400 (V.22bis)	17 = 2400 (V.27bis)	24 = 4800 (TMp)
11 = 14,400 (V.33)	18 = 19,200 (V.32 terbo)	25 = 2400 (TMp)

**Table 4-5**  
**(3 of 6)**  
**Leased Line Configuration Options**

<p>V32bis Autorate: Enable Nxt Enable Disable</p> <p><b>This configuration option only appears when Leased Line Rate is configured for V.32 terbo or V.32bis data rate.</b></p> <p>V.32bis Autorate. Once connected, the modem automatically lowers the line rate if line conditions become impaired. When line conditions improve, the modem automatically shifts up to the highest data rate the line can support. This autorating only occurs between 19,200 bps and 4800 bps during V.32/V.32bis/V.32 terbo connections.</p> <p>The AT command is S-Register S82=<i>n</i>, where <i>n</i> is 0 for Enable and 1 for Disable.</p>
<p>V32bis Override: Disable Nxt Disable 2400 1200</p> <p><b>This configuration option is ignored unless Leased-Line Rate is 4800(V32b).</b></p> <p>V.32bis Override. Activates the Paradyne Point-to-Point Diagnostic 1200 bps or 2400 bps modulation. Allows the modem to use a non-standard, point-to-point modulation capable of secondary channel diagnostics while running at 1200 bps or 2400 bps.</p> <p><b>NOTE:</b> This configuration option must be the same in both the local and remote modems.</p> <p><b>NOTE:</b> The 1200 selection bps is available only if the Proprietary 1200 device option is installed.</p>
<p>Leased Tx Level: The factory default setting is country dependent. It is 0 dBm in North America Nxt 0 -1 -2 -3 -4 -5 -6 -7 -8 -9 -10 -11 -12 -13 -14 -15</p> <p>Leased Transmit Level. Selects the modem's transmit power level over leased lines. The transmit output level can be selected in 1 dBm decrements from 0 dBm to -15 dBm.</p> <p><b>NOTE:</b> The leased TX level is limited to -1 dBm in all countries except North America.</p> <p>The AT command is S-Register S45=<i>n</i>, where <i>n</i> is from 0 to 15 corresponding to 0 dBm to -15 dBm.</p>
<p>Auto Dial Back: Disable Nxt Disable Enable FastBackup</p> <p><b>This configuration option is not available if the LeaseLine Rate is configured for Tmp and the NetworkPosition is configured for Control.</b></p> <p>Automatic Dial Backup. Allows the modem to dial the number stored in directory location 1 to restore communications with the remote modem when the leased lines fail.</p> <p><b>NOTE:</b> In point-to-point applications, this configuration option must be set to Enable in both the local and remote modem. The answering modem must have its Auto-Answer Ring Number configuration option enabled. Refer to the Line Dialer configuration option group for information regarding Auto-Answer.</p> <p><b>NOTE:</b> When this configuration option is enabled, the originating modem will attempt the dial backup for a maximum of 10 call attempts, with a 2-minute delay between calls. This function can be reset with a completed manual dial backup, a power cycle, or using NMS.</p> <ul style="list-style-type: none"> <li>■ Fast Backup <ul style="list-style-type: none"> <li>Only used in special applications requiring a shortened delay time from the failure of the leased lines to the initiation of the automatic dial backup.</li> </ul> </li> </ul> <p>The AT command is S-Register S46=<i>n</i>, where <i>n</i> is 0 for Disable, 1 for Enable, and 2 for FastBackup.</p>

**Table 4-5**  
**(4 of 6)**  
**Leased Line Configuration Options**

<p>AutoDialStandby: Disable Nxt Disable 15min 1hr 4hr Test(2min) Adv 15min Adv 30min Adv 1 hr TestAdv2min</p> <p><b>This configuration option is not available if the LeaseLine Rate is configured for Tmp and the NetworkPosition is configured for Control.</b></p> <p>Automatic Dial Standby. Permits a modem operating on dial lines (regardless of the method of dialing origination) to check the quality of the leased lines periodically and, if they are good, to disconnect from the dial lines and resume operations on the leased lines. The time interval that the modem uses to check the quality of the leased lines is determined by the configuration option. These intervals are 15 minutes, 1 hour, and 4 hours. The Test(2min) and TestAdv2min selections are for testing purposes only. The Adv 15min, Adv 30min, and Adv 1 hr selections cause the modem to evaluate the leased lines continuously in a manner which is non-disruptive to the dial-line communication.</p> <p>The AT command is S-Register S47=<i>n</i>, where <i>n</i> is 0 for Disable, 1 for 15min, 2 for 1hr, 3 for 4hrs, 4 for Test(2min), 5 for Adv 15min, 6 for Adv 30min, 7 for Adv 1 hr, and 8 for TestAdv2min.</p>
<p>SpecialStandby: Disable Nxt Disable Enable</p> <p><b>This configuration option is only available if Automatic Dial Standby is configured for 15min, 1hr, 4hr or Test(2min) and Leased mode is configured for Originate mode, or if Automatic Dial Standby is configured for Adv15min, Adv30min, Adv1hr or TestAdv(2min).</b></p> <p>Special Standby. Used to support Automatic Dial Standby configurations when a third modem is used for the dial backup. When the leased line is restored, the Special Standby configuration allows the leased-line modems to return service to the original point-to-point modems.</p> <p><b>NOTE:</b> When the modems are set for normal dial standby (15min, 1hr 4hr, or Test(2min)), the Special Standby configuration option allows the originate modem to test the lease connection in one direction before interrupting primary data on the dial lines.</p> <p><b>NOTE:</b> When the modems are set for advanced dial standby (Adv15min, Adv 30min, Adv1hr or Adv Test(2min)), the Special Standby configuration option allows a non-interruptive algorithm to test the original point-to-point lease connection in both directions before interrupting primary data on the dial lines.</p> <p>The AT command is S-Register S98=<i>n</i>, where <i>n</i> is 0 for Disable and 1 for Enable.</p>
<p>Dial StandbyTime: 10min Nxt 10min 5min 1min</p> <p>Dial Standby Time. Selects the amount of time that a dial circuit is held after returning to the leased lines.</p>
<p>CarrierOn Level: -43dbm Nxt -43dbm -26dbm</p> <p>Carrier On Level. Controls the carrier detection threshold for leased lines. When the power level of the receive carrier signal drops 2 dBm below this level (either -26 dBm or -43 dBm), LSD turns OFF. When the carrier signal is greater than this level, LSD turns ON.</p> <p>For Tmp Control, -26dbm is the factory default.</p> <p>The AT command is S-Register S48=<i>n</i>, where <i>n</i> is 0 for -43 dBm and 1 for -26 dBm.</p>
<p>V27bis Train: Short Nxt Short Long</p> <p><b>This configuration option is only available if Leased-Line Rate is configured for V27bis.</b></p>

**Table 4-5  
(5 of 6)  
Leased Line Configuration Options**

<p>V.27bis Train. Controls the train time for V.27bis operation. The AT command is S-Register S70=<math>n</math>, where <math>n</math> is 0 for Short and 1 for Long.</p>
<p>V29 TrainOnData: Disable Nxt Disable Enable</p> <p><b>This configuration option is only available if Leased-Line Rate is configured for V29.</b></p> <p>V.29 Train On Data. When enabled, the modem receiver can train based upon the incoming data or a training sequence from the distant modem. This function is necessary for a remote (tributary) modem in a V.29 multipoint network and is recommended for a control modem as well. The AT command is S-Register S92=<math>n</math>, where <math>n</math> is 0 for Disable and 1 for Enable.</p>
<p>V29 Retrain: Enable Nxt Disable Enable</p> <p><b>This configuration option is only available if Leased-Line Rate is configured for V29.</b></p> <p>V.29 Retrain. When enabled, the modem transmits a training sequence whenever it receives one. This configuration option should normally be disabled for control modems. The AT command is S-Register S93=<math>n</math>, where <math>n</math> is 0 for Enable and 1 for Disable.</p>
<p>V29 Link Config: PointToPoint Nxt PointToPoint Multipoint</p> <p><b>This configuration option is only available if Leased-Line Rate is configured for V29.</b></p> <p>V.29 Link Configuration. Selects point-to-point or multipoint operation. <b>NOTE:</b> Remote mode and the Cloning function are not available when configured for V.29 Multipoint. The AT command is S-Register S94=<math>n</math>, where <math>n</math> is 0 for PointToPoint and 1 for Multipoint.</p>
<p>Tmp Train Time: 50 Nxt 50 10 20 100 200 300</p> <p><b>This configuration option is only available if Leased-Line Rate is configured for TMP.</b></p> <p>Trellis Multipoint (TMP) Train Time. Defines the length of time energy is sent from the tributary modem to the control modem. More severe line conditions require longer time selections. The AT command is S-Register S95=<math>n</math>, where <math>n</math> is 0 for 10 milliseconds, 1 for 20 milliseconds, 2 for 50 milliseconds, 3 for 100 milliseconds, 4 for 200 milliseconds, and 5 for 300 milliseconds.</p>
<p>Tmp TxPreemphasis: Enable Nxt Enable Disable</p> <p><b>This configuration option is only available if Leased-Line Rate is configured for TMP.</b></p> <p>Trellis Multipoint (TMP) Transmit Preemphasis. Provides amplification for frequencies above the carrier frequency to compensate for high frequency line attenuation. The AT command is S-Register S96=<math>n</math>, where <math>n</math> is 0 for Enable and 1 for Disable.</p>
<p>Lease_Lookback: Disable Nxt Disable Enable</p> <p>Lease Lookback. While operating on backup lines, this configuration option allows the modem to test the primary 4-wire leased lines for connectivity by detecting line energy across the normal line bandwidth. This test of the primary lines will not interrupt the data flow on the backup lines. The configuration option settings must be the same at both ends.</p>

**Table 4-5  
(6 of 6)  
Leased Line Configuration Options**

<p>Dual_Leased_Ln: Disable Nxt Disable Enable</p> <p><b>This configuration option is only available when the Dual Leased Line device option is installed.</b></p> <p>Dual Leased Line. Allows the 2-wire backup facility to function as a 2-wire leased-line facility. When this configuration option is disabled, the backup facility is a 2-wire dial line.</p> <p><b>NOTE:</b> Plug the leased line into the jack labeled DIAL on the rear panel of the modem. Except for dialing, ring indication, and call progression functions, you control the backup function as if it were a normal dial backup.</p> <p><b>NOTE:</b> Once the Dual_Leased_Ln configuration option is enabled, the Backup_TXClk_Src configuration option can be enabled.</p>
<p>BackupLineCheck: Disable Nxt Disable Enable</p> <p><b>This configuration option is only available when the Dual Leased Line device option is installed.</b></p> <p>BackupLine Check. Tests the backup circuit for availability while the modem is operating on the primary leased lines. The test involves detecting line energy across the normal bandwidth. This test of the backup lines will not interrupt the data flow on the primary lines. The configuration option settings must be the same at both ends.</p> <p><b>NOTE:</b> In network applications where the modem is in backup mode and is connected to a modem other than the modem connected to the primary leased-line, enabling this configuration option can cause problems.</p>

## V.42/MNP/Buffer

V.42/MNP/Buffer configuration options determine the type of error correction and flow control used by the modems and attached DTEs.

Some choices within this group may not appear depending upon how previous configuration options have been selected. **If the Async/Sync Mode configuration option is set for synchronous operation (refer to the DTE Interface configuration options group), then the V.42/MNP/Buffer group does not appear on the LCD.** Any changes made to configuration options within this group only take effect after a disconnect.

Table 4-6 shows each V.42/MNP/Buffer configuration option as it appears on the LCD, with the Async Dial factory default setting shown following the colon ( : ) on the first line and with all available selections listed on the second line. Following this is a description of the configuration option. Factory default settings are listed in Appendix F.

**Table 4-6**  
**(1 of 8)**  
**V.42/MNP/Buffer Configuration Options**

Err Contrl Mode: V42/MNPorBfr

Nxt V42/MNPorBfr V42/MNPorDsc MNP\_or\_Bufr MNP\_or\_Disc BufferMode DirectMode

LAPM\_or\_Disc LAPM\_or\_Bufr

**This configuration option is only available if Async/Sync Mode is configured for Async.**

Error Control Mode. Determines the type of error control used by the modem. In most cases, V42/MNPorBfr is the best choice. If V.42bis and MNP are enabled, then the modem uses the following priority for error control negotiation: V.42bis, V.42, MNP 5 and below. Online changes do not take effect until a disconnect occurs.

■ V.42/MNP or Buffer

Modem attempts to connect in V.42 Error Control mode using V.42 Link Access Procedure for Modems (LAPM) protocol. If this fails, the modem attempts to connect in MNP mode. If this fails, the modem connects in Buffer mode and continues operation. This is also known as V42/MNP Autoreliable Mode.

■ V.42/MNP or Disconnect

Modem attempts to connect in V.42 Error Control mode using V.42 LAPM protocol. If this fails, the modem attempts to connect in MNP mode. If this fails, the modem disconnects. This is also known as Reliable mode.

■ MNP or Buffer

Modem attempts to connect in MNP mode. If this fails, the modem connects in Buffer mode. This is also known as MNP Autoreliable Mode.

■ MNP or Disconnect

Modem attempts to connect in MNP mode. If this fails, the modem disconnects. This is also known as Reliable mode.

■ Buffer Mode

Modem does not use error control and allows the DTE rate to differ from the communications line rate. This mode should only be used if the DTE provides its own error control or if errors in data can be tolerated. This setting is also known as Normal mode and is valid even if the remote modem is set to Direct mode.

■ Direct Mode

Modem connects at a data rate equal to or less than the initial DTE interface rate. (The modem never connects at a data rate greater than the initial DTE rate.) If the modem connects at a data rate lower than the DTE rate, the DTE must then adjust its data rate to equal the modem rate. Ultimately, the modem speed and DTE speed must be the same. Direct mode does not support error control or data buffering.

■ LAPM or Disconnect

Modem attempts to connect in LAPM mode. If this fails, the modem disconnects.

■ LAPM or Buffer

Modem attempts to connect in LAPM mode. If this fails, the modem connects in Buffer mode.

**NOTE:** The modem must be reconfigured for Direct mode before changing the leased-line modulation if V.42 error control or Buffer mode are enabled with V.32bis or Tmp on leased lines.

**Table 4-6**  
**(2 of 8)**  
**V.42/MNP/Buffer Configuration Options**

<p>Err Contrl Mode (Continued)</p> <p>Nxt V42/MNPorBfr V42/MNPorDsc MNP_or_Bufr MNP_or_Disc BufferMode DirectMode LAPM_or_Disc LAPM_or_Bufr</p> <p>The AT command for Buffer Mode is \N0. The AT command for Direct Mode is \N1. The AT command for MNP or Disconnect is \N2. The AT command for MNP or Buffer is \N3. The AT command for V42/MNP or Disconnect is \N4. The AT command for V42/MNP or Buffer is \N5. The AT command for LAPM or Disconnect is \N6. The AT command for LAPM or Buffer is \N7.</p>
<p>V42bis Compress: Enable</p> <p>Nxt Enable Disable</p> <p><b>This configuration option is only available if Async/Sync Mode is configured for Async, and Error Control Mode is configured for V42/MNPorBfr or V42/MNPorDsc.</b></p> <p>V.42bis Data Compression. Enables or disables V.42bis data compression.</p> <ul style="list-style-type: none"> <li>■ Enable Data compression operates in both the transmit and receive directions. This is the recommended setting for all applications.</li> <li>■ Disable V.42bis data compression is disabled. This is rarely needed because V.42bis data compression does not cause data expansion for compressed data.</li> </ul> <p>The AT command for Disable is "H0. The AT command for Enable is "H1, "H2, or "H3.</p>
<p>MNP5 Compress: Enable</p> <p>Nxt Enable Disable</p> <p><b>This configuration option is only available if Async/Sync Mode is configured for Async, and Error Control Mode is configured for V42/MNPorBfr, V42/MNPorDsc, MNP_or_Bufr, or MNP_or_Disc.</b></p> <p>MNP5 Compression. Determines if the modem uses MNP Class 5 data compression. It can be set independently of V.42bis data compression. Online changes do not take effect until a disconnect occurs.</p> <p>The AT command for Disable is %C0. The AT command for Enable is %C1.</p>

**Table 4-6**  
**(3 of 8)**  
**V.42/MNP/Buffer Configuration Options**

<p>EC Negotiat Bfr: Disable Nxt Disable Enable Disab&amp;Switch</p> <p><b>This configuration option is only available if Async/Sync Mode is configured for Async, and Error Control Mode is configured for V42/MNPorBfr, MNP_or_Bufr, or LAPM_or_Bufr.</b></p> <p>Error Control Negotiate Buffer. Determines if the answering modem buffers the data that it received from the remote modem during an interval in which the modem attempts to establish a connection using error control. Online changes do not take effect until a disconnect occurs.</p> <ul style="list-style-type: none"> <li>■ Disable Data is not buffered during the link negotiating (handshaking) sequence.</li> <li>■ Enable Data is buffered while the link is being established. Initialization data is not passed on the DTE during the handshaking sequence.</li> <li>■ Disable and Switch Data is not buffered during the handshaking sequence. However, when the modem receives an error control fallback character, it switches to Buffer mode. (Refer to the EC Fallback Char configuration option.)</li> </ul> <p>The AT command for Disable is \C0. The AT command for Enable is \C1. The AT command for Disab&amp;Switch is \C2.</p>
<p>EC Fallbck Char: 013 ASCI Nxt ↑ 013 ASCI</p> <p><b>This configuration option is only available if Async/Sync Mode is configured for Async, and EC Negotiate Buffer is <i>not</i> configured for Disable.</b></p> <p>Error Control Fallback Character. This configuration option allows you to enter the ASCII value of the error control fallback character. This provides the remote modem with the ability to end the error control link negotiating (handshaking) sequence by sending this character. The modems will connect in Buffer mode (no error control). Online changes do not take effect until a disconnect occurs. When the modem receives this fallback character it switches to Buffer mode and transmits an EC fallback character to the DTE. When comparing incoming characters for a match against the EC fallback character, the modem ignores parity.</p> <p>The AT command is %An, where <i>n</i> is a value from 0 to 127.</p>



**Table 4-6**  
**(4 of 8)**  
**V.42/MNP/Buffer Configuration Options**

Flw Cntl of DTE: CTS\_to\_DTE

Nxt CTS\_to\_DTE Disable XON/XOFF

**This configuration option is only available if Async/Sync Mode is configured for Async, and Error Control Mode is *not* configured for DirectMode.**

Flow Control of DTE. Determines how the modem controls the flow of data from the DTE.

- CTS to DTE  
Method of flow control in which the modem raises and lowers its CTS interface lead to indicate when the DTE should start and stop sending data.
- Disable  
The modem cannot control the flow of data from the DTE.
- XON/XOFF  
Method of flow control in which the modem sends XON and XOFF characters to the DTE to start and stop the flow of data.

The AT commands for Disable are \Q0, \Q5, and \Q6.

The AT commands for XON/XOFF are \Q1 and \Q4.

The AT commands for CTS to DTE are \Q2 and \Q3.

Flw Cntl of Mdm: RTS\_to\_Mdm

Nxt RTS\_to\_Mdm Disable XON/XOFF

**This configuration option is only available if Async/Sync Mode is configured for Async, and Error Control Mode is *not* configured for DirectMode.**

Flow Control of Modem. Determines how the DTE controls the flow of data from the modem.

- RTS to Modem  
Method of flow control in which the modem respectively starts and stops data transmission based upon the ON and OFF state of the DTE's RTS signal.
- Disable  
The DTE cannot control the flow of data from the modem.
- XON/XOFF  
Method of flow control in which the modem starts and stops data flow based upon XON and XOFF characters received from the DTE.

The AT commands for Disable are \Q0, \Q2, and \Q4.

The AT commands for XON/XOFF are \Q1 and \Q5.

The AT commands for RTS to Modem are \Q3 and \Q6.

**Table 4-6**  
**(5 of 8)**  
**V.42/MNP/Buffer Configuration Options**

XON/XOFF Psthru: Disable  
Nxt Disable Enable

**This configuration option is only available if Async/Sync Mode is configured for Async, and Flow Control of Modem is configured for XON/XOFF.**

XON/XOFF Passthrough. Considers an XON/XOFF character as data and passes it on to the remote modem. In this case, the DTE at one end of the communications link can send flow control characters to the other DTE. This is also known as DTE to DTE flow control.

- Disable  
Flow control characters are processed but are not passed on to the remote modem.
- Enable  
Flow control characters are processed and passed on to the remote modem.

The AT command for Disable is \X0.  
The AT command for Enable is \X1.

Mdm/Mdm FlowCtl: Disable  
Nxt Disable Enable

**This configuration option is only available if Async/Sync Mode is configured for Async, and Error Control Mode is configured for V42/MNPorBfr, MNP\_or\_Bufr, LAPM\_or\_Bufr, or BufferMode.**

Modem-to-Modem Flow Control. If a modem's buffers begin to fill due to data it is receiving from the remote modem, but is not passing on to the DTE, it can issue XON/XOFF flow control characters to the remote modem. This only applies if Buffer (nonerror control) mode is selected. If Error Control mode is enabled, flow control between the modems will happen automatically, regardless of the setting of this option.

- Disable  
Modem does not respond to XON and XOFF characters received over the VF line. Also, the modem will not transmit an XOFF character to the remote end if its receive buffers are full.
- Enable  
Modem stops transmitting data to the remote modem if it receives an XOFF character over the VF line. An XON character will enable data transmission. Also, the modem will transmit an XOFF character to the remote end if its receive buffers are full. Select this setting if the DTE rate is less than the VF line rate or if the DTE must frequently stop the flow of data to process it.

The AT Command for Disable is \G0.  
The AT Command for Enable is \G1.

**Table 4-6**  
**(6 of 8)**  
**V.42/MNP/Buffer Configuration Options**

Break Buffr Ctl: Keep\_Data  
Nxt Keep\_Data Discard\_Data

**This configuration option is only available if Async/Sync Mode is configured for Async, and Error Control Mode is *not* configured for DirectMode.**

Break Buffer Control. Determines if data stored in the modem's buffer is saved or discarded when the DTE issues a break sequence.

- Keep Data (Nondestructive mode)  
Saves the data in the buffer in both the local and remote modems.
- Discard Data (Destructive mode)  
Empties the data buffer. Only buffers in the same direction of travel as the break are discarded.

**NOTE:** This configuration option is ignored if the Break Forces Escape configuration option (refer to the DTE Dialer configuration options group) is enabled.

The AT commands for Discard Data are \K0 and \K1.

The AT commands for Keep Data are \K2, \K3, \K4, and \K5.

Send Break Cntl: Data\_First  
End Data\_First Break\_First

**This configuration option is only available if Async/Sync Mode is configured for Async, and Error Control Mode is *not* configured for DirectMode.**

Send Break Control. Determines what is sent from the modem first, data or break if a break sequence is sent from the DTE.

- Data First (Nonexpedited)  
A break is treated as a data character and is sent in the order it was received. This is also known as Nonexpedited mode.
- Break First (Expedited)  
A break is sent before the data currently in the buffer. This is also known as Expedited mode.

**NOTE:** This configuration option is ignored if the Break Forces Escape configuration option (refer to the DTE Dialer configuration options group) is enabled.

The AT commands for Break First are \K0, \K1, \K2, and \K3.

The AT commands for Data First are \K4 and \K5.

**Table 4-6  
(7 of 8)  
V.42/MNP/Buffer Configuration Options**

<p>BufDiscDelay: 10sec Nxt 10sec Disable 60sec</p> <p><b>This configuration option is only available if Async/Sync Mode is configured for Async, and Error Control Mode is <i>not</i> configured for DirectMode.</b></p> <p>Buffer Disconnect Delay. Determines how long the modem continues to transmit data stored in its buffers when the modem is commanded to disconnect by a locally attached DTE. This also applies to the modem's receiving buffers when it is commanded to disconnect from a remote modem or DTE.</p> <ul style="list-style-type: none"> <li>■ Disable Modem disconnects immediately without attempting to send data stored in its buffers.</li> <li>■ 10, 60 sec Maximum amount of time the modem tries to empty its buffers before disconnecting. In both cases (10 sec and 60 sec), the modem disconnects much sooner if it can empty its buffers.</li> </ul> <p><b>NOTE:</b> This configuration option is not available if Error Control Mode configuration option is set to Direct Mode.</p> <p>The AT command is S-Register S49=<i>n</i>, where <i>n</i> is 0 for Disable and any value from 1 to 255 in 1 second increments.</p>
<p>Max Frame Size: 256 Nxt 256 192 128 64 32 16</p> <p><b>This configuration option is only available if Async/Sync Mode is configured for Async, and Error Control Mode is <i>not</i> configured for BufferMode or DirectMode.</b></p> <p>Maximum Frame Size. Sets the maximum frame size for V.42 and MNP. For V.42 operation, 128 is the maximum value. Any value which exceeds this will automatically default to 128 for V.42. For MNP operation, 64 is the minimum value. Any value less than that will automatically default to 64. For cellular applications, at least one of the sides should be set to a low value. A setting of 32 is recommended. Only one modem needs this setting; both modems will automatically default to the greatest common value.</p> <p>The AT Command for 256 is \A3. The AT Command for 192 is \A2. The AT Command for 128 is \A1. The AT Command for 64 is \A0. The AT Command for 32 is \A4. The AT Command for 16 is \A5.</p>
<p>CellularEnhance: Disable Nxt Disable Enable</p> <p><b>This configuration option is only available if Async/Sync Mode is configured for Async, and Error Control Mode is configured for V42/MNPorBfr, V42/MNPorDsc, LAPM_or_Disc, or LAPM_or_Bufr.</b></p> <p>Cellular Enhancement. When enabled, the modem uses non-standard techniques to enhance V.42 operation for cellular applications. It is still compatible, however, with modems which do not have the cellular enhancement implemented or enabled.</p> <p>The AT command is S-Register S91=<i>n</i>, where <i>n</i> is 0 for Disable and 1 for Enable.</p>

**Table 4-6**  
**(8 of 8)**  
**V.42/MNP/Buffer Configuration Options**

RdcdAsyncBufSiz: Disable  
End Disable Enable

**This configuration option is only available if Async/Sync Mode is configured for Async, and Error Control Mode is configured for BufferMode, V42MNPorBuf, MNP\_or\_Bufr, and LAPM\_or\_Bufr mode.**

Reduced Asynchronous Buffer Size. When enabled, the modem's buffer size is limited to a maximum of 20 characters.

The AT command is S-Register S97= $n$ , where  $n$  is 0 for Disable and 1 for Enable.

## Test

The Test configuration options determine specifics, such as the duration of a test, for the various diagnostic tests available to the modem.

Table 4-7 shows each Test configuration option as it appears on the LCD, with the Sync Leased factory default setting (the default value if the modem is just being installed) shown following the colon (:) on the first line and with all available selections listed on the second line. Following this is a description of the configuration option. Factory default settings are listed in Appendix F.

**Table 4-7**  
**(1 of 2)**  
**Test Configuration Options**

DTE RL (CT140): Disable  
Nxt Disable Enable

DTE Remote Loopback. Controls the use of Pin 21 of the EIA-232-D/CCITT V.24 interface by the DTE to initiate a remote loopback. An Abort command or test time-out ends this test.

**This configuration option is not available if the LeasedLine Rate is configured for TMp.**

■ Enable

The DTE forces the modem into remote loopback when the signal on Pin 21 (CCITT 140) is turned ON. Remote Loop ends when the signal is dropped.

■ Disable

The DTE does not initiate remote loopback in response to the signal on Pin 21.

The AT command is S-Register S51= $n$ , where  $n$  is 0 for Disable and 1 for Enable.

DTE LL (CT141): Disable  
Nxt Disable Enable

DTE Local Loopback. Controls the use of Pin 18 of the EIA-232-D/CCITT V.24 interface by the DTE to initiate a local loopback. An Abort command or test time-out ends this test.

■ Enable

The DTE forces the modem into local loopback when the signal on Pin 18 (CCITT 141) is turned ON. Local loopback ends when the signal is dropped.

■ Disable

The DTE will not initiate local loopback in response to the signal on Pin 18.

The AT command is S-Register S52= $n$ , where  $n$  is 0 for Disable and 1 for Enable.

**Table 4-7  
(2 of 2)  
Test Configuration Options**

<p>Test Timeout: Disable Nxt Disable 30sec 60sec 240sec</p> <p>Test Time-out. Determines how long a test runs before aborting.</p> <ul style="list-style-type: none"> <li>■ Disable Allows a test to run indefinitely.</li> <li>■ 30, 60, or 240 seconds Allows the test to run for 30 seconds, 60 seconds, or 240 seconds.</li> </ul> <p>The AT command is S-Register S18=<i>n</i>, where <i>n</i> is 0 for Disable and 1 to 255 seconds.</p>
<p>Rcv Remote Loop: Enable Nxt Enable Disable</p> <p><b>This configuration option is not available if the LeasedLine Rate is configured for Tmp.</b></p> <p>Receive Remote Loopback Response. Determines if the modem responds to a request for a remote loopback issued from a remote modem.</p> <p>The AT command for Enable is &amp;T4. The AT command for Disable is &amp;T5.</p>
<p>V54 Address: Disable Nxt Disable (Address Values)</p> <p><b>This configuration option is not available if the LeasedLine Rate is configured for Tmp.</b></p> <p>V.54 Address. Determines which remote 391x Series modem is placed into a remote loopback test. This test can be either a remote digital loopback or local analog loopback. This type of addressing is recommended for use in extended data circuits (tail circuits).</p> <ul style="list-style-type: none"> <li>■ Disable This is used for normal point-to-point leased-line and dial networks.</li> <li>■ Address Values 01, 03, 05, 07, 09, 0B, 0D, 0F, 11, 13, 15, 17, 19, 1B, 1D, 1F, 25, 27, 2B, 2D, 2F, 33, 35, 37, 3B, 3D, 3F, 55, 57, 5B, 5F, 6F, 77, or 7F. This configuration option selects the address of a modem that is to be placed into a loopback test. This option is used for more complex networks where multiple modems, used in extended data circuits (tail circuits), can be commanded to loopback.</li> </ul> <p>The AT command for Disable is S-Register S53=0. The AT command for V.54 Address is S-Register S53=<i>n</i>, where <i>n</i> is a value from 1 to 34.</p>
<p>V54 Device Type: Peripheral End Peripheral Intermediate</p> <p><b>This configuration option is only available if V54 Address is enabled and the LeasedLine Rate is configured for Tmp.</b></p> <p>V.54 Device Type. Identifies where the modem is physically located in the network.</p> <ul style="list-style-type: none"> <li>■ Peripheral The modem is located at the endpoint of the network and is not connected back-to-back with another modem.</li> <li>■ Intermediate The modem is either of the two modems connected back-to-back.</li> </ul> <p>The AT command for Peripheral is S-Register S54=0. The AT command for Intermediate is S-Register S54=1.</p>

## Misc

The Miscellaneous configuration options determine specifics for various functions, including network management parameters and remote modem access.

Table 4-8 shows each Misc (Miscellaneous) configuration option as it appears on the LCD, with the Sync Leased factory default setting (the default value if the modem is just being installed) shown following the colon ( : ) on the first line and with all available selections listed on the second line. Following this is a description of the configuration option. Factory default settings are listed in Appendix F.

**Table 4-8**  
**(1 of 4)**  
**Miscellaneous Configuration Options**

<p>StrapsWhenDisc: No_Change Nxt No_Change Reload</p> <p>Straps When Disconnected. Determines whether or not configuration options in the Active (Saved) configuration area are reloaded to Active (Operating) when a disconnect occurs. This is useful in modem pooling applications.</p> <ul style="list-style-type: none"> <li>■ No Change Configuration options do not change if a disconnect occurs.</li> <li>■ Reload The Active (Operating) configuration area, which controls modem operation, is reloaded from the Active (Saved) configuration area when a disconnect occurs. This is useful in modem pooling applications where it is desirable to start the modem from a known condition after every call. This allows multiple users to issue AT commands to change the modem's operation for their particular call.</li> </ul> <p><b>NOTE:</b> If Reload is selected, the following AT commands are disabled although the OK result code appears when the following commands are issued: AT&amp;F0, AT&amp;F1, AT&amp;F2, AT&amp;F3, AT&amp;F4, AT&amp;F5, AT&amp;F6, AT&amp;F7, AT&amp;F8, AT&amp;W0, AT&amp;W1, AT&amp;W2, and AT&amp;Zn=x.</p> <p>The AT command for the Straps When Disconnected configuration option is S-Register S88=<i>n</i>, where <i>n</i> is 0 or 231 for No_Change, and 1 or 232 for Reload.</p>
<p>Speaker Control: OnUntilCarr Nxt OnUntilCarr Off On</p> <p>Speaker Control. Determines if the speaker is OFF, ON until carrier signal is received by the modem, or ON all the time.</p> <p><b>NOTE:</b> Speaker Control can also be temporarily set using the Control branch; however, a reset or power cycle will restore the modem to the Speaker Control and Speaker Volume configuration option settings.</p> <p>The AT command for Off is M0 The AT command for On Until CD is M1. The AT command for On is M2.</p>

**Table 4-8**  
**(2 of 4)**  
**Miscellaneous Configuration Options**

<p>Speaker Volume: Medium Nxt Medium Low High</p> <p>Speaker Volume. Controls the level of speaker volume.</p> <p><b>NOTE:</b> Speaker Volume can also be temporarily set using the Control branch; however, a reset or power cycle will restore the modem to the Speaker Control and Speaker Volume configuration option settings.</p> <p>The AT command for Low is L0 or L1. The AT command for Medium is L2. The AT command for High is L3.</p>
<p>Access frm Remt: Enable Nxt Enable Disable</p> <p>Access from Remote. Determines if your modem's DCP can be accessed by a remote modem via the VF line.</p> <p><b>CAUTION:</b> If this configuration option is disabled, the modem cannot be accessed by another modem.</p> <ul style="list-style-type: none"> <li>■ Enable Allows access from a remote modem.</li> <li>■ Disable Does not allow access from a remote modem.</li> </ul> <p><b>NOTE:</b> The remote modem must be a 3900 Series modem.</p> <p>The AT command is S-Register S55=<i>n</i>, where <i>n</i> is 0 for Enable and 1 for Disable.</p>
<p>RemAccssPasswrd: 00000000 Nxt ↑ 00000000</p> <p>Remote Access Password. Allows the entry of a password for establishing control of a remote modem from the DCP of a local modem. The same password must be used in both the local and remote modem.</p> <p><b>CAUTION:</b> A remote access password should be selected for security purposes.</p> <p><b>NOTE:</b> If the Access from Remote configuration option is set to Disable, the password has no effect.</p> <p>The AT command equivalent is S-Registers S56=<i>n</i>, S57=<i>x</i>, S58=<i>y</i>, and S59=<i>z</i>, where <i>n</i> is the leftmost pair of digits, <i>x</i> is the second pair of digits, <i>y</i> is the third pair of digits, and <i>z</i> is the rightmost pair (or fourth) pair of digits. For example, if the remote access password is 12345678, then the value for S56 is 1 and 2, and the value for S59 is 7 and 8.</p>
<p>Dir#1_Callback: Disable Nxt Disable Enable</p> <p>Directory Location 1 Callback. This configuration option controls whether or not the modem's single number callback function is used.</p> <ul style="list-style-type: none"> <li>■ Disable Modem does not use the single number callback function.</li> <li>■ Enable Modem answers a call, disconnects, and dials the number stored in directory location 1.</li> </ul> <p><b>NOTE:</b> This function is disabled if dial access security is enabled.</p> <p>The AT Command to Disable is S-Register S67=0. The AT Command to Enable is S-Register S67=1.</p>



**Table 4-8**  
**(3 of 4)**  
**Miscellaneous Configuration Options**

<p>NMS_Call_Msgs: CallCnct&amp;Prg Nxt CallCnct&amp;Prg Disable CallCnctOnly CallProgOnly</p> <p>NMS Call Messages. Determines if the modem status and/or call summary information is sent to the NMS. The modem can itemize status, such as CallProgress messages, or it can report a summary of activity, such as Call Connect messages, to the NMS.</p> <ul style="list-style-type: none"> <li>■ Call Connect &amp; Progress Enables both Call Connect and Call Progress information to be transmitted to the NMS.</li> <li>■ Disable Modem status and call summary information is not sent to the NMS.</li> <li>■ Call Connect Only The modem accumulates call statistics over a period of time and then transmits a summary of these statistics to the NMS. The NMS uses this data to produce utilization reports.</li> <li>■ Call Progress Only The modem transmits detailed modem status information to the NMS. These messages include any events that can display on the LCD.</li> </ul> <p><b>NOTE:</b> For 6800 Series NMS applications, Disable must be selected.</p> <p>The AT commands are S-Register S66=<i>n</i> where <i>n</i> is 0 for Call Connect &amp; Progress, 1 for Disable, 2 for Call Connect Only, and 3 for Call Progress Only.</p>
<p>NetworkPosition: Tributary End Tributary Control</p> <p>Network Position Identification. Each modem must be identified either as a control modem or a tributary modem.</p> <p><b>NOTE:</b> Changes to this configuration option will cause the modem to reset.</p> <p><b>NOTE:</b> This configuration option is only applicable for leased-line network management applications.</p> <p>For the Model 3910, Tributary is the factory default. For the Model 3911, Control is the factory default.</p> <p>The AT command for Tributary is S74=0. The AT command for Control is S74=1.</p>
<p>NetMngmtAddress: 256 Nxt ↑ 256</p> <p><b>This configuration option is not available in point-to-point tributaries.</b></p> <p>Network Management Address. Determines the address used when accessing a modem from the NMS or when using DCP functions that require network management addresses. Within a network link, a control modem can communicate with a tributary modem by using the tributary modem's network management address. Each tributary modem must have a different network management address.</p> <p><b>NOTE:</b> Changes to this configuration option will cause the modem to reset.</p> <p><b>NOTE:</b> A point-to-point tributary is always Address 1.</p> <p>Address values range from 001 to 256.</p> <p>The AT command is S-Register S75=<i>n</i>, where <i>n</i> is a value from 0 to 255 (001 to 256).</p>

**Table 4-8**  
**(4 of 4)**  
**Miscellaneous Configuration Options**

<p>Diag Connection: Modem(DC) Nxt Modem(DC) NMS(CC) Disable</p> <p><b>This configuration option is not available if the LeaseLine Rate is configured for TMp and the NetworkPosition is configured for Tributary.</b></p> <p>Diagnostic Connection. Allows the configuration of the serial diagnostic port of the modem to be either a diagnostic channel that is connected to another modem (DC), or a control channel that is connected to a network management device (CC).</p> <ul style="list-style-type: none"> <li>■ Modem Selects the Diagnostic Channel.</li> <li>■ NMS Selects the Control Channel.</li> <li>■ Disable Prevents messages being sent from the diagnostic port.</li> </ul>
<p>Link Delay (sec): 0 1 Nxt 0 1 2 5 10 20 50</p> <p>Link Delay Seconds: Controls the length of time (in seconds) a modem will wait for responses from the downstream devices. This configuration option is used to calculate protocol timers for polling and normal selection.</p> <p><b>NOTE:</b> The estimated roundtrip delay in the diagnostic link is entered.</p>

## Security

The Security configuration options allow you to set the parameters that control how a dial access security password is entered. For security configuration options, refer to Chapter 6, *Dial Access Security*.

---

# AT Command Set and S-Registers 5

Overview .....	5-1
Operating Modes .....	5-1
Switching Between Data Mode and Online Command Mode .....	5-1
Escape Sequence and Escape Guard Time .....	5-2
Command Guidelines .....	5-2
Result Codes .....	5-3
AT Command List .....	5-4
AT Command Format .....	5-4
S-Register List .....	5-14
S-Register Format .....	5-15

## Overview

The AT command set provides an alternative method to the modem's DCP for entering commands that control the operation and configuration of the 391x Series modems. This chapter discusses guidelines necessary to operate AT commands as well as listing the modifiers for all AT commands supported by the 391x Series modems. AT commands are issued from asynchronous DTEs.

## Operating Modes

The 391x Series modem has two operating modes, Command mode and Data mode. Before a modem goes online (establishes a successful connection with a remote modem), it is considered to be in Command mode; an idle state where you can modify its operating parameters or issue modem commands. (Any command issued is acknowledged with a response in either words or digits known as Result Codes. Refer to Table 5-1 for a listing of result codes.)

Once the modems are online, either by answering or originating a call, they automatically switch to Data mode. Data mode is a state where any entries made from the DTE are considered data and are transmitted and received between modems. The modems remain in Data mode until the connection is broken or until they are forced into online Command mode using the escape sequence.

### Switching Between Data Mode and Online Command Mode

Sometimes it is necessary to change operating parameters while the modems are online. The Escape Sequence allows you to toggle the modem between Data mode and online Command mode while maintaining a connection with the remote modem. This is accomplished using the escape sequence ( + + + ) to exit Data mode and the O command to return to Data mode.

## Escape Sequence and Escape Guard Time

The escape sequence is only issued when the modem is online and in Data mode. The 391x Series modem uses three consecutive plus ( + ) characters as the escape sequence. (To change this value, refer to S-Register S2 discussed later in Table 5-3 in the *S-Register Format* section.)

To prevent the modem from interpreting an embedded + + + in data as an escape sequence, the Escape Guard Time value determines the length of the pause before and after the escape sequence is issued. The 391x Series modem uses a one-second pause as the Escape Guard Time. (To change this value, refer to S-Register S12 discussed later in Table 5-3 in the *S-Register Format* section.)

To enter online Command mode while in Data mode, enter the following sequence:

**TYPE:** + + +

Use the O command to return to Data mode from online Command mode. Enter the following command:

**TYPE:** ATO

**PRESS:** Enter

## Command Guidelines

Review the following guidelines before using any AT Commands.

- The escape sequence ( + + + ) is used to enter online Command mode from Data mode.
- The asynchronous character format for the AT command set must be one of the following:
  - 8 data bits + no parity + 1 stop bit.
  - 7 data bits + no parity + 2 stop bits.
  - 7 data bits + parity + 1 stop bit (parity can be odd, even, mark, or space).
- All commands (except A/ and + + + ) must begin with the characters AT and end by pressing the Enter key. The AT (or at) prefix clears the command buffer and matches the modem speed and parity to that of the DTE. Commands can be upper- or lowercase, but the modem will not recognize mixed case prefixes (At or aT).
- Commands can be entered one at a time or in strings. Strings can have up to 40 characters after the AT prefix. You can use spaces, hyphens ( - ), and parentheses ( ) as fillers to make the commands easier to read; the modem ignores these fillers and they are not counted among the characters which make up the command string. Commands must be entered on one line and end with the carriage return character (Enter key).
- Commands with the suffix *n* have several options associated with them. For example, in the *Ln* command, L1 sets the speaker volume to Low and L3 sets the speaker volume to High. If no value is entered for the *n* suffix, the modem assumes a zero ( 0 ) value.
- The A/ command (without pressing the Enter key) causes the modem to repeat the last command entered.
- Valid commands are acknowledged with numeric or word result codes (unless the result codes have been disabled using the Q1 command). Table 5-1 lists all available result codes with numeric and word equivalents.

## Result Codes

Table 5-1 lists all valid result codes for the 391x Series modem.

**Table 5-1  
(1 of 2)  
Result Codes**

Numbers (1)	Numbers (2)	Word	Description
0	0	OK	Command executed
1	1	CONNECT	Modem connected to line
2	2	RING	Modem receiving a ring voltage from the VF line
3	3	NO CARRIER	Modem lost carrier signal, does not detect carrier signal, or does not detect answer tone
4	4	ERROR	Invalid command
5	5	CONNECT 1200*	Connection at 1200 bps
6	6	NO DIALTONE*	No dial tone detected
7	7	BUSY*	Busy or trunk busy signal detected
8	8	NO ANSWER*	No "quiet" answer (@)
10	10	CONNECT 2400*	Connection at 2400 bps
11	11	CONNECT 4800*	Connection at 4800 bps
12	12	CONNECT 9600*	Connection at 9600 bps
13	16	CONNECT 12000*	Connection at 12,000 bps
14	13	CONNECT 14400*	Connection at 14,400 bps
15	14	CONNECT 19200**	Connection at 19,200 bps
16	15	CONNECT 7200*	Connection at 7200 bps
17	17	CONNECT 16800**	Connection at 16,800 bps
19	19	CONNECT 300*	Connection at 300 bps
20	10	CONNECT 2400/ EC***	Connection at 2400 bps with error control
21	11	CONNECT 4800/ EC***	Connection at 4800 bps with error control
22	12	CONNECT 4800/ EC***	Connection at 4800 bps with error control
23	16	CONNECT 12000/ EC***	Connection at 12,000 bps with error control
24	13	CONNECT 14400/ EC***	Connection at 14,400 bps with error control
25	17	CONNECT 16800/ EC**	Connection at 16,800 bps with error control
<p>* Only appears when the Extended Result Codes configuration option is enabled.  ** Only appears when the Extended Result Codes configuration option is set for Use_DTE_Rate. This displays the DTE data rate instead of the line rate.  *** Only appears when the Extended Result Codes configuration option is set for Add/EC. If this configuration option is set for Add/V42, MNP, then either V42b, V42, MNP5, MNP4, MNP3, MNP2, or NoEC appears.</p>			

**Table 5-1  
(2 of 2)  
Result Codes**

Numbers (1)	Numbers (2)	Word	Description
26	15	CONNECT 7200/ EC***	Connection at 7200 bps with error control
27	5	CONNECT 1200/ EC*	Connection at 1200 bps with error control
28	28	CONNECT 38400**	Connection at 38,400 bps
29	14	CONNECT 19200/ EC**	Connection at 19,200 bps with error control
30	30	CONNECT 57600**	Connection at 57,600 bps
77	77	FORBIDDEN	Forbidden number
78	78	DELAYED	Delayed number
<p>* Only appears when the Extended Result Codes configuration option is enabled.</p> <p>** Only appears when the Extended Result Codes configuration option is set for Use_DTE_Rate. This displays the DTE data rate instead of the line rate.</p> <p>*** Only appears when the Extended Result Codes configuration option is set for Add/EC. If this configuration option is set for Add/V42, MNP, then either V42b, V42, MNP5, MNP4, MNP3, MNP2, or NoEC appears.</p>			

## AT Command List

AT commands are issued from an asynchronous DTE, such as a PC, and control the modem's operation and software configuration. AT commands are only applicable when the DTE Dialer Type configuration option is set for AT. (Refer to the &Mn and &Qn commands.)

Table 5-2 lists all AT commands supported by the 391x Series modem. The first column lists the AT command. The second column defines and lists all possible values for that command. **The Async Dial factory default is listed in bold.** The third column lists the key sequence used to enter the equivalent DCP command. Use this to reference commands in Chapter 3 or Chapter 4 if further description is necessary.

### AT Command Format

AT commands are entered in Command mode using the following format:

**TYPE:**     ATXn

**Where:**    X is the AT command and n is the specific value for that command.

**PRESS:**    Enter

In Table 5-2, the value for X is listed in the AT Command column and the value for n is listed in the Description column.

**Table 5-2**  
**(1 of 3)**  
**391x Series AT Commands**

AT Command	Description	DCP LCD Command Sequence
A/	Repeat Last Command. Reexecutes last command string. (Not to be preceded with AT or followed by pressing the Return key.)	Call Setup\ Answer
A	Answer Mode. Goes off-hook and attempts to establish a connection without waiting for a ring.	None
Dn	<p>Dial. Begins the dialing sequence. The dial string <i>n</i> (modifiers and telephone number) is entered after the D command.</p> <p>Any digit 0–9, *, or # may be dialed as a DTMF tone. Only the digits 0–9 can be dialed in Pulse Dial mode. The following example shows how to dial through a PBX. The dial string consists of the command string and the telephone number:</p> <p style="text-align: center;"><b>ATD9W5551234</b></p> <p>Modifiers include the following parameters:</p> <p><b>T</b> — Tone (DTMF) dial. Any digit 0–9, *, or # can be dialed as tone.</p> <p><b>P</b> — Pulse dial. Only digits 0–9 can be dialed in Pulse Dial mode.</p> <p><b>NOTE:</b> Once a dialing method (tone or pulse) has been specified, it will only remain active until the end of that dial string. The modem defaults to the value set by the Dialer Type configuration option.</p> <p><b>,</b> — Pause. Causes the modem to pause before processing the next character in the dial string. The length of this pause is determined by the setting of the Pause Time configuration option (refer to the Line Dialer configuration option group) or by value held in S-Register S8.</p> <p><b>W</b> — Wait for dial tone. The modem waits for a second dial tone before processing the dial string. This can be the initial dial tone or can be used when dialing through a tandem PBX. For example, 9W 555-6789.</p> <p><b>R</b> — Reverse Dial mode. Causes the originating modem to send out an answertone once it no longer detects ringback. (Ringback is the ring you hear at the originating site when making a call.) The R parameter must be the last character in the dial string. For correct operation, at least one ringback must be detected; therefore, the remote modem should be configured to answer on the second ring or subsequent rings.</p>	None

**Table 5-2**  
**(2 of 3)**  
**391x Series AT Commands**

AT Command	Description	DCP LCD Command Sequence
<i>Dn</i> (cont.)	<p><b>@</b> — Quiet answer. Wait for five seconds of silence after dialing the number. If the silence is not detected, the modem sends either a NO ANSWER result to the DTE.</p> <p><b>!</b> — Hook flash. This causes the modem to go on-hook for 0.5 seconds then return to off-hook.</p> <p><b>;</b> — Return to Command mode. Modem returns to Command mode after dialing a number without disconnecting the call.</p> <p><b>Space</b> — Ignored by the dial string, can be included to enhance readability.</p> <p><b>-</b> — Ignored by the dial string, can be included to enhance readability.</p> <p><b>( )</b> — Ignored by the dial string, can be included to enhance readability.</p>	
<i>DS=n</i>	Dial Stored Number. Dials the number stored in Location <i>n</i> (1–24). (To store a telephone number, refer to the <b>&amp;Zn=x</b> command.)	Call Setup\Dial\ Dial Directory:
<i>En</i>	Command Character Echo. <b>E0</b> Disables echo to the DTE. <b>E1</b> Enables echo to the DTE.	Configure>Edit\ DTE Dialer
<i>Hn</i>	Hook Switch Control. <b>H0</b> Modem goes on-hook. <b>H1</b> Modem goes off-hook.	<b>H0:</b> Call Setup\ Disconnect or Control\Remove Make Busy  <b>H1:</b> Control\ Make Busy
<i>In</i>	Identification. <b>I0</b> Displays product code — 144. <b>I1</b> Displays 3-digit firmware revision number. <b>I2</b> Performs an EPROM check.	Status\Identity
<i>Ln</i>	Speaker Volume. <b>L0</b> Selects low volume. <b>L1</b> Selects low volume. <b>L2</b> Selects medium volume. <b>L3</b> Selects high volume.	Control\Speaker Configure>Edit\ Misc
<i>Mn</i>	Speaker On/Off. <b>M0</b> Speaker always OFF. <b>M1</b> Speaker ON until carrier signal is detected. <b>M2</b> Speaker always ON.	Control\Speaker Configure>Edit\ Misc



**Table 5-2**  
**(3 of 3)**  
**391x Series AT Commands**

AT Command	Description	DCP LCD Command Sequence
O	Return to Online or Data Mode. Returns modem to Data mode from Online Command mode.	None
P	Pulse Dial. Sets the modem for Pulse Dial mode.  <b>NOTE:</b> Pulse Mode is disabled in Denmark and Sweden.	Configure\Edit\ Line Dialer

**Table 5-3**  
**(1 of 8)**  
**391x Series AT Commands**

AT Command	Description	DCP LCD Command Sequence
<i>Qn</i>	Result Codes.  <b>Q0</b> Enables modem to send result codes to the DTE. <b>Q1</b> Disables modem from sending result codes to the DTE. <b>Q2</b> Enables in Originate mode only for modem to send result codes to the DTE. Required for most UNIX® applications.	Configure\Edit\ DTE Dialer
<i>Sn=r</i>	Change S-Register. Changes contents of S-Register (where <i>n</i> is the S-Register, and <i>r</i> is the new value).	None
<i>Sn?</i>	Display S-Register. Displays value of S-Register where <i>n</i> is the S-Register number.	None
T	Tone Dial. Sets the modem for tone dial mode.	Configure\Edit\ Line Dialer
<i>Vn</i>	Result Codes Format.  <b>V0</b> Displays result codes in Number (1) format (digits). <b>V1</b> Displays result codes as text. <b>V2</b> Displays result codes in Number (2) format (digits).	Configure\Edit\ DTE Dialer

**Table 5-3  
(2 of 8)  
391x Series AT Commands**

AT Command	Description	DCP LCD Command Sequence																																				
Xn	<p>Extended Result Code, Dial Tone Detect, and Busy Tone Detect Configuration Options.</p> <table border="0"> <thead> <tr> <th></th> <th align="center">Extended Result Code:</th> <th align="center">Dial Tone Detect:</th> <th align="center">Busy Tone Detect:</th> </tr> </thead> <tbody> <tr> <td>X0</td> <td>Disable</td> <td>Disable</td> <td>Disable</td> </tr> <tr> <td>X1</td> <td>Enable</td> <td>Disable</td> <td>Disable</td> </tr> <tr> <td>X2</td> <td>Enable</td> <td>Enable</td> <td>Disable</td> </tr> <tr> <td>X3</td> <td>Enable</td> <td>Disable</td> <td>Enable</td> </tr> <tr> <td><b>X4</b></td> <td>Enable</td> <td>Enable</td> <td>Enable</td> </tr> <tr> <td>X5</td> <td>Add/EC</td> <td>Enable</td> <td>Enable</td> </tr> <tr> <td>X6</td> <td>Add/V42.MNP</td> <td>Enable</td> <td>Enable</td> </tr> <tr> <td>X7</td> <td>Use DTE Rate</td> <td>Enable</td> <td>Enable</td> </tr> </tbody> </table> <p><i>Extended Result Code:</i></p> <p>Enable      Displays all result codes listed in Table 5-1 except for error control suffix.</p> <p>Disable      Only displays <b>OK, CONNECT, RING, NO CARRIER, ERROR.</b></p> <p>Add/EC      Displays result codes with /EC suffix.</p> <p>Add/V42,MNP      Displays result codes with V.42 or MNP suffix.</p> <p>Use DTE Rate      Displays DTE data rate instead of line rate.</p> <p><i>Dial Tone Detect:</i></p> <p>Enable      Sets the modem for dial tone detect.</p> <p>Disable      Sets the modem for blind dialing.</p> <p><b>NOTE:</b> It may not be possible to disable Dial Tone Detect in some countries.</p> <p><i>Busy Tone Detect:</i></p> <p>Enable      Modem monitors for busy tone.</p> <p>Disable      Modem ignores busy tone.</p>		Extended Result Code:	Dial Tone Detect:	Busy Tone Detect:	X0	Disable	Disable	Disable	X1	Enable	Disable	Disable	X2	Enable	Enable	Disable	X3	Enable	Disable	Enable	<b>X4</b>	Enable	Enable	Enable	X5	Add/EC	Enable	Enable	X6	Add/V42.MNP	Enable	Enable	X7	Use DTE Rate	Enable	Enable	<p>Extended Result Code: Configure/Edit\ DTE Dialer</p> <p>Dial Tone Detect: Configure/Edit\ Line Dialer</p> <p>Busy Tone Detect: Configure/Edit\ Line Dialer</p>
	Extended Result Code:	Dial Tone Detect:	Busy Tone Detect:																																			
X0	Disable	Disable	Disable																																			
X1	Enable	Disable	Disable																																			
X2	Enable	Enable	Disable																																			
X3	Enable	Disable	Enable																																			
<b>X4</b>	Enable	Enable	Enable																																			
X5	Add/EC	Enable	Enable																																			
X6	Add/V42.MNP	Enable	Enable																																			
X7	Use DTE Rate	Enable	Enable																																			
Yn	<p>Long Space Disconnect.</p> <p>Y0    Disable. Ignores long space.</p> <p>Y1    Enable. Disconnects if long space is detected. Enables transmission of a long space.</p>	Configure/Edit/ Line Dialer																																				

**Table 5-3  
(3 of 8)  
391x Series AT Commands**

AT Command	Description	DCP LCD Command Sequence
<i>Zn</i>	Reset and Load Active. Z0 Loads configuration options from Active (Saved) to Active (Operating). Z1 Loads configuration options from Customer 1 to Active (Operating). Z2 Loads configuration from Customer 2 to Active (Operating). Z3 Loads configuration options from Active (Saved) to Active (Operating) and performs a reset.	Control\Reset
<i>&amp;Cn</i>	LSD Control. &C0 Forced On. LSD ON at all times. &C1 Standard RS232. LSD is ON when the remote modem's carrier signal is detected. LSD is OFF when carrier signal is not detected. &C2 Wink When Disconnect. LSD normally forced ON, turns OFF for approximately one second upon disconnecting. &C3 Follows DTR. State of LSD follows state of DTR. &C4 Simulated Control Carrier. State of LSD follows state of remote modem's RTS. &C5 =DTR/Disconnect Off. State of LSD follows state of DTR except upon a disconnect where DTR remains ON and LSD turns OFF. DTR must then toggle OFF and ON to turn LSD ON. Use this setting for AT&T DATAKIT® applications. Note that to use this option, the DTR Action configuration option must be set to Stndrd_RS232 (&D1 or &D2).	Configure\Edit\ DTE Interface
<i>&amp;Dn</i>	DTR Action. &D0 Ignore. Modem ignores the true status of DTR and treats it as always ON. &D1,&D2,&D3 Standard RS232. DTR Signal is controlled by the DTE. &D4 Controls On-Hook. Modem does not disconnect from the VF line until DTR turns OFF. &D5 Controls Transmitter Mute. Mutes the transmitter whenever DTR drops on the DTE interface. This can be used on the answer side modem to force the originate modem to initiate a dial backup. <b>NOTE:</b> Only the Standard RS232 setting is allowed in Austria.	Configure\Edit\ DTE Interface

**Table 5-3**  
**(4 of 8)**  
**391x Series AT Commands**

AT Command	Description	DCP LCD Command Sequence
&Fn	<p>Select Factory Default Configuration Options. Loads factory configuration options into Active (Operating) area.</p> <p>&amp;F0 Async Dial  &amp;F1 Sync Dial  &amp;F2 Sync Leased: Answer  &amp;F3 UNIX Dial  &amp;F4 Sync Leased: Originate  &amp;F5 Async Leased: Answer  &amp;F6 Async Leased: Originate  &amp;F7 Tmp: Control  &amp;F8 Tmp: Trib</p> <p>Only the &amp;F0 and &amp;F3 commands will leave you in AT Command mode. The other commands will take you out of AT command control and place the modem into Dumb mode. The only way to return to AT command control is via the diagnostic control panel (DCP).</p>	Configure/ Factory
&Gn	<p>V.22bis Guard Tone.</p> <p><b>&amp;G0</b> Disable.  <b>&amp;G1</b> 550 Hz.  <b>&amp;G2</b> 1800 Hz.</p> <p><b>NOTE:</b> The V.22bis Guard Tone cannot be disabled in some countries.</p>	Configure\Edit\ Dial Line
&In	<p>Dial Transmit Level.</p> <p>The AT command is &amp;In, where <i>n</i> is  0 for -1 dBm  1 for -1 dBm  •  •  •  32 for -32 dBm</p> <p><b>NOTE:</b> In North America the range of allowable values is -10 dBm to -32 dBm. This command is disabled in some countries (it answers OK but does not change the level).</p>	Configure\Edit\ Dial Line
&Ln	<p>Leased Mode.</p> <p>&amp;L0 Disables leased-line operation.  &amp;L1 2-wire originate leased-line operation.  &amp;L2 4-wire originate leased-line operation.  &amp;L3 2-wire answer leased-line operation.  &amp;L4 4-wire answer leased-line operation.</p> <p>The &amp;L command will cause the modem to reset before entering or exiting Leased-Line mode. Therefore, it must be entered as the last command in an initialization string.</p>	Configure\Edit\ Leased Line

**Table 5-3**  
**(5 of 8)**  
**391x Series AT Commands**

AT Command	Description	DCP LCD Command Sequence
&Mn and &Qn	<p>Async/Sync Mode and DTE Dialer Type.</p> <p><b>&amp;M0, &amp;Q0</b> Modem operates in Asynchronous mode and uses AT Command protocol.</p> <p><b>&amp;M1, &amp;Q1</b> Modem operates in Synchronous mode and uses AT Command protocol.</p> <p><b>&amp;M2, &amp;Q2</b> Modem operates in Synchronous mode and dials telephone number stored in directory location 1 when DTR signal turns OFF and then ON.</p> <p><b>&amp;M3, &amp;Q3</b> Modem operates in Synchronous mode and uses AT Command protocol.</p> <p>The &amp;M2 and &amp;Q2 commands disable the use of AT commands and force the modem into Dumb mode. The only way to gain control of the modem is via the DCP.</p>	Configure/Edit\ DTE Dialer
&Rn	<p>RTS Action.</p> <p><b>&amp;R0</b> Standard RS232.</p> <p><b>&amp;R1</b> Ignores RTS.</p> <p><b>&amp;R2</b> Simulated Control Carrier.</p> <p><b>&amp;R3</b> Control Carrier.</p>	Configure/Edit\ DTE Interface
&Sn	<p>DSR Control.</p> <p><b>&amp;S0</b> Forced On.</p> <p><b>&amp;S1</b> Standard RS232.</p> <p><b>&amp;S2</b> Wink When Disconnect.</p> <p><b>&amp;S3</b> Follows DTR.</p> <p><b>&amp;S4</b> On Early.</p> <p><b>&amp;S5</b> Delay to DTE.</p>	Configure/Edit\ DTE Interface
&Tn	<p>Tests.</p> <p><b>&amp;T0</b> Abort. Stops any test in progress.</p> <p><b>&amp;T1</b> Local Analog Loop.</p> <p><b>&amp;T2</b> Pattern. Transmits and receives a 511 Bit Error Rate Test (BERT).</p> <p><b>&amp;T3</b> Local Digital Loopback test.</p> <p><b>&amp;T4</b> Enables Receive Remote Loopback Response configuration option.</p> <p><b>&amp;T5</b> Disables Receive Remote Loopback Response configuration option.</p> <p><b>&amp;T6</b> Remote Digital Loopback test.</p> <p><b>&amp;T7</b> Remote Digital Loopback with Pattern.</p> <p><b>&amp;T8</b> Local Loopback with Pattern.</p> <p><b>&amp;T9</b> Self-Test.</p>	Test  &T4 and &T5: Configure/Edit\ Tests

**Table 5-3  
(6 of 8)  
391x Series AT Commands**

AT Command	Description	DCP LCD Command Sequence
&Vn	<p>View Configuration Options. Displays each configuration group within the Active (Operating), Active (Saved), Customer 1, and Customer 2 configuration areas as well as the telephone numbers stores in directory locations 1–24.</p> <p>&amp;V0 Active (Operating) configuration options.            &amp;V1 Active (Saved) configuration options.            &amp;V2 Customer 1 configuration options.            &amp;V3 Customer 2 configuration options.            &amp;V4 Directory locations 1–24.</p>	None
&Wn	<p>Write (Save to Memory). Saves the current configuration options in Active (Operating) to one of three configuration areas:</p> <p>&amp;W0 Saved to Active(Save).            &amp;W1 Saved to Customer 1.            &amp;W2 Saved to Customer 2.</p>	Configure\Save
&Xn	<p>Transmit Clock Source.</p> <p><b>&amp;X0</b> Internal. Modem provides transmit clock source for synchronous data (Pin 15).            &amp;X1 External. Modem derives external transmit clock source provided on Pin 24 for synchronous data.            &amp;X2 Receive Clock Loop. Modem derives transmit clock source from receive signal for synchronous data (Pin 17).</p>	Configure\Edit\ DTE Interface
&Zn=x	<p>Store Telephone Numbers. Modem saves the telephone numbers and dial command modifiers (if any) entered for x (up to 40 characters in length) in Directory Location n (1–24). For example, the command AT&amp;Z1 = 5551234 stores the telephone number 555-1234 into directory location 1.</p> <p>To clear a telephone number from a memory location, issue the &amp;Zn=x command without entering a telephone number.</p>	Call Setup\ Change Directory
\An	<p>Maximum Frame Size.</p> <p>\A0 64 bytes.            \A1 128 bytes.            \A2 192 bytes.  <b>\A3</b> 256 bytes.            \A4 32 bytes.            \A5 16 bytes.</p>	Configure\Edit\ V42/MNP/Buffer
\Cn	<p>Error Control Negotiate Buffer.</p> <p>\C0 Disable.            \C1 Enable.            \C2 Disables and switches modem to Buffer mode.</p>	Configure\Edit\ V42/MNP/Buffer

**Table 5-3  
(7 of 8)  
391x Series AT Commands**

AT Command	Description	DCP LCD Command Sequence																												
\Dn	CTS Control. <b>\D0</b> Forced On. Forces CTS to always ON. <b>\D1</b> Standard RS232. <b>\D2</b> Wink When Disconnect. CTS is turned OFF for 1 to 2 seconds upon a disconnect. <b>\D3</b> Follows DTR. The state of CTS follows the state of DTR. <b>\D4</b> Follows RTS. The state of CTS follows the state of RTS.	Configure>Edit\ DTE Interface																												
\Gn	Modem to Modem Flow Control. <b>\G0</b> Disable. <b>\G1</b> Enable.	Configure>Edit\ V42/MNP/Buffer																												
\Kn	Buffer Control, Send Break Control, Break Forces Escape.  <table border="0" style="width: 100%; border-collapse: collapse;"> <thead> <tr> <th style="width: 10%;"></th> <th style="width: 35%; text-align: center;">Break Buffer Control:</th> <th style="width: 35%; text-align: center;">Send Break Control:</th> <th style="width: 20%; text-align: center;">Break Forces Escape:</th> </tr> </thead> <tbody> <tr> <td>\K0</td> <td>Discard Data</td> <td>Break First</td> <td>Enable</td> </tr> <tr> <td>\K1</td> <td>Discard Data</td> <td>Break First</td> <td>Disable</td> </tr> <tr> <td>\K2</td> <td>Keep Data</td> <td>Break First</td> <td>Enable</td> </tr> <tr> <td>\K3</td> <td>Keep Data</td> <td>Break First</td> <td>Disable</td> </tr> <tr> <td>\K4</td> <td>Keep Data</td> <td>Data First</td> <td>Enable</td> </tr> <tr> <td>\K5</td> <td>Keep Data</td> <td>Data First</td> <td>Disable</td> </tr> </tbody> </table>		Break Buffer Control:	Send Break Control:	Break Forces Escape:	\K0	Discard Data	Break First	Enable	\K1	Discard Data	Break First	Disable	\K2	Keep Data	Break First	Enable	\K3	Keep Data	Break First	Disable	\K4	Keep Data	Data First	Enable	\K5	Keep Data	Data First	Disable	Break Buffer Control: Configure>Edit\ V42/MNP/ Send Break Control: Configure>Edit\ V42/MNP/Buffer Break Forces Escape: Configure>Edit\ DTE Dialer
	Break Buffer Control:	Send Break Control:	Break Forces Escape:																											
\K0	Discard Data	Break First	Enable																											
\K1	Discard Data	Break First	Disable																											
\K2	Keep Data	Break First	Enable																											
\K3	Keep Data	Break First	Disable																											
\K4	Keep Data	Data First	Enable																											
\K5	Keep Data	Data First	Disable																											
\Nn	Error Control Mode. <b>\N0</b> Buffer Mode. <b>\N1</b> Direct Mode. <b>\N2</b> MNP or Disconnect. <b>\N3</b> MNP or Buffer. <b>\N4</b> V.42/MNP or Disconnect. <b>\N5</b> V.42/MNP or Buffer. <b>\N6</b> LAPM_or_Disc <b>\N7</b> LAPM_or_Bufr	Configure>Edit\ V42/MNP/Buffer																												
\Qn	Flow Control of DTE, Flow Control of Modem.  <table border="0" style="width: 100%; border-collapse: collapse;"> <thead> <tr> <th style="width: 10%;"></th> <th style="width: 35%; text-align: center;">Flow Control of DTE:</th> <th style="width: 35%; text-align: center;">Flow Control of Modem:</th> </tr> </thead> <tbody> <tr> <td>\Q0</td> <td>Disable</td> <td>Disable</td> </tr> <tr> <td>\Q1</td> <td>XON/XOFF</td> <td>XON/XOFF</td> </tr> <tr> <td>\Q2</td> <td>CTS to DTE</td> <td>Disable</td> </tr> <tr> <td>\Q3</td> <td>CTS to DTE</td> <td>RTS to Mdm</td> </tr> <tr> <td>\Q4</td> <td>XON/XOFF</td> <td>Disable</td> </tr> <tr> <td>\Q5</td> <td>Disable</td> <td>XON/XOFF</td> </tr> <tr> <td>\Q6</td> <td>Disable</td> <td>RTS to Mdm</td> </tr> </tbody> </table>		Flow Control of DTE:	Flow Control of Modem:	\Q0	Disable	Disable	\Q1	XON/XOFF	XON/XOFF	\Q2	CTS to DTE	Disable	\Q3	CTS to DTE	RTS to Mdm	\Q4	XON/XOFF	Disable	\Q5	Disable	XON/XOFF	\Q6	Disable	RTS to Mdm	Configure>Edit\ V42/MNP/Buffer				
	Flow Control of DTE:	Flow Control of Modem:																												
\Q0	Disable	Disable																												
\Q1	XON/XOFF	XON/XOFF																												
\Q2	CTS to DTE	Disable																												
\Q3	CTS to DTE	RTS to Mdm																												
\Q4	XON/XOFF	Disable																												
\Q5	Disable	XON/XOFF																												
\Q6	Disable	RTS to Mdm																												

**Table 5-3  
(8 of 8)  
391x Series AT Commands**

AT Command	Description	DCP LCD Command Sequence
\Tn	No Data Disconnect Timer. \T0      Disable. \Tn      Where <i>n</i> is a value from 1 to 255 in 1-minute increments. <b>NOTE:</b> The factory default value is country dependent.	Configure/Edit\ Line Dialer
\Xn	XON/XOFF Passthrough Flow Control. \X0      Disable. \X1      Enable.	Configure/Edit\ V42/MNP/Buffer
%An	Error Control Fallback Character. %An      Where <i>n</i> is an ASCII value from 0 to 127. Factory default is 013 ASCII.	Configure/Edit\ V42/MNP/Buffer
%Cn	MNP5 Data Compression. %C0      Disable. %C1      Enable.	Configure/Edit\ V42/MNP/Buffer
"Hn	V.42bis Compression. "H0      Disable. "H1      Enable. "H2      Enable. "H3      Enable.	Configure/Edit\ V42/MNP/Buffer

## S-Register List

S-Registers affect the operating parameters of the 391x Series modems. S-Registers are only applicable when the DTE Dialer Type configuration option is set for AT. (Refer to the &Mn and &Qn commands.)

Table 5-4 lists all S-Registers supported by the 391x Series modems. The first column lists the S-Register. The second column lists all possible values for that register. The third column lists the key sequence used to enter the equivalent from the DCP. Use this column to reference commands in Chapter 4 if further description is necessary.

### NOTE

In some countries, the range of allowable values of some S-Registers are restricted. If the DTE attempts to enter an illegal value, the modem will answer **OK**, but it will set the register to the closest legal value. The DTE can check the actual value of the register with Sn? command.



## S-Register Format

S-Registers can be displayed and/or modified when the modem is in Command mode. To display the value of an S-Register, issue the following command:

**TYPE:** ATSn?

**Where:** *n* is the register number.

**PRESS:** Enter

To modify the value of an S-Register, issue the following command:

**TYPE:** ATSn=*r*

**Where:** *n* is the register number, and *r* is the new value.

**PRESS:** Enter

In Table 5-4, the value for *n* is listed in the S-Register column, and the value for *r* is listed in the Description column.

**Table 5-4  
(1 of 13)  
391x Series S-Registers**

S-Register	Description	DCP LCD Command Sequence
S0	Auto-Answer Ring Number <sup>1</sup> . Register determines number of rings the modem will count before automatically answering a call.  Enter zero (0) if you do not want the modem to automatically answer any calls. Otherwise, enter a value from 1–255 for the number of rings to count before answering. The factory setting is 1.	Configure\Edit\ Line Dialer
S2	AT Escape Character. Register determines ASCII value used for escape sequence to enter Command mode from Data mode.  Enter a value from 0 to 127 for the escape character. Any value greater than 127 causes the modem to disable the escape sequence. When the escape sequence is disabled, the modem cannot return to Command mode until the call is disconnected. The factory setting is 43 (+ key).	Configure\Edit\ DTE Dialer
S3	Carriage Return Character. Register determines ASCII value used as the carriage return (Return key). This character is used to end command lines and result codes.  Enter a value from 0 to 127 for the command end character. The factory setting is 13 (carriage return key).	Configure\Edit\ DTE Dialer
S4	Line Feed Character. Register determines ASCII value used as the line feed character.  Enter a value from 0–127 for the line feed character. The factory setting is 10 (ASCII carriage return or line feed).	Configure\Edit\ DTE Dialer
<sup>1</sup> The range of allowable values may be restricted in some countries.		

**Table 5-4  
(2 of 13)  
391x Series S-Registers**

<b>S-Register</b>	<b>Description</b>	<b>DCP LCD Command Sequence</b>
S5	<p>Backspace Character. Register determines ASCII value used as the backspace (Backspace key). This character moves the cursor to the left and erases the previous character.</p> <p>Enter a value from 0–127. The factory setting is 8 (backspace key).</p>	Configure\Edit\ DTE Dialer
S6	<p>Blind Dial Pause<sup>1</sup>. Register determines how long (in seconds) the modem waits after going off-hook before dialing a telephone number if using result code X0, X1, or X3.</p> <p>Enter a value from 2–255 seconds. The factory setting is 2.</p>	Configure\Edit\ Line Dialer
S7	<p>No Answer Time-out<sup>1</sup>. Register determines how long (in seconds) an originating modem waits before abandoning a call when no answer tone is received.</p> <p>Enter a value from 1–255 seconds. The factory setting is 45.</p>	Configure\Edit\ Line Dialer
S8	<p>“,” Pause Time for the Dial Modifier. Register determines how long (in seconds) the modem pauses when it encounters a comma (,) in the Dial command string.</p> <p>Enter a value from 0–255 seconds. The factory setting is 2.</p>	Configure\Edit\ Line Dialer
S10	<p>No Carrier Disconnect<sup>1</sup>. Register determines how long (in tenths of seconds) the modem allows the carrier signal to be OFF before disconnecting the call.</p> <p>Enter a value from 0–254 in 0.1 second increments. A value of 255 disables this register. The factory setting is 20 (2 seconds).</p>	Configure\Edit\ Line Dialer
S12	<p>Escape Guard Time. Register sets the value (in 20-millisecond increments) for the required pause before and after the escape sequence is issued. The guard time prevents the modem from interpreting data as the escape sequence characters.</p> <p>Enter a value from 0–255 in 20-millisecond increments. The factory setting of 50 equals 1000 milliseconds or one second.</p>	Configure\Edit\ DTE Dialer
S18	<p>Test Time-out. Register sets the duration (in seconds) for the modem tests. This automatically cancels any test in progress after the time of this register expires. Any test can be manually canceled by issuing the escape sequence (+++) followed by the &amp;T0 command.</p> <p>Enter a value from 0–255 seconds. A value of 0 disables this register. The factory setting is Disable (0).</p>	Configure\Edit\ Tests
S26	<p>RTS-to-CTS Delay. Register sets the length of time (in 10-millisecond increments) the modem waits after receiving RTS before issuing CTS to the DTE.</p> <p>Enter a value from 0–255. The factory setting is 0.</p>	Configure\Edit\ DTE Interface
<p><sup>1</sup> The range of allowable values may be restricted in some countries.</p>		

**Table 5-4**  
**(3 of 13)**  
**391x Series S-Registers**

<b>S-Register</b>	<b>Description</b>	<b>DCP LCD Command Sequence</b>
S40	<p>Auto Make Busy. Register determines if the modem goes off-hook under certain conditions. This register should only be enabled when the modem is located behind a user's Private Branch Exchange (PBX). This register is only valid for Model 3911 modems.</p> <p>Register has the following values:            0 = Disable            1 = Enable</p> <p>The factory setting is Disable.</p>	Configure/Edit\ Line Dialer
S41	<p>Dial-Line Rate. Register determines the modem's data rate and modulation scheme for operation on dial lines.</p> <p>Register has the following values:            1 = 14,400 (V.32bis)            2 = 12,000(V.32bis)            3 = 9600 (V.32bis)            4 = 7200 (V.32bis)            5 = 4800 (V.32bis)            6 = 2400 (V.22bis)            7 = 1200 (V.22)            8 = 1200 (212A)            10 = 0-300 (V.21)            11 = 0-300 (103J)            12 = 1200/75 (V.23)            13 = 75/1200 (V.23)            18 = 600/75 (V.23)            19 = 75/600 (V.23)            20 = 19,200 (V.32 terbo)            21 = 16,800 (V.32 terbo)</p> <p>The factory setting is 19200 (V.32 terbo).</p>	Configure/Edit\ Dial Line
S43	<p>V.32bis Train. Register controls the modem's train time for V.32bis/V.32 mode.</p> <p>Register has the following values:            0 = Long            1 = Short</p> <p>The factory setting is Long.</p>	Configure/Edit\ Dial Line

**Table 5-4**  
**(4 of 13)**  
**391x Series S-Registers**

<b>S-Register</b>	<b>Description</b>	<b>DCP LCD Command Sequence</b>
S44	<p>Leased-Line Rate. Register determines the modem's data rate and modulation scheme for operation on either 2-wire or 4-wire leased lines in either Answer or Originate mode.</p> <p>Register has the following values:</p> <ul style="list-style-type: none"> <li>1 = 14,400 (V.32bis)</li> <li>2 = 12,000 (V.32bis)</li> <li>3 = 9600 (V.32bis)</li> <li>4 = 7200 (V.32bis)</li> <li>5 = 4800 (V.32bis)</li> <li>6 = 2400 (V.22bis)</li> <li>11 = 14,400 (V.33)</li> <li>12 = 12,000 (V.33)</li> <li>13 = 9600 (V.29)</li> <li>14 = 7200 (V.29)</li> <li>15 = 4800 (V.29)</li> <li>16 = 4800 (V.27)</li> <li>17 = 2400 (V.27bis)</li> <li>18 = 19,200 (V.32 terbo)</li> <li>19 = 16,800 (V.32 terbo)</li> <li>20 = 19,200 (TMp)</li> <li>21 = 14,400 (TMp)</li> <li>22 = 9600 (TMp)</li> <li>23 = 7200 (TMp)</li> <li>24 = 4800 (TMp)</li> <li>25 = 2400 (TMp)</li> </ul> <p>The factory setting is 19200 (V.32 terbo).</p>	Configure/Edit\ Leased Line
S45	<p>Leased Tx Level<sup>2</sup>. Register determines the modem's transmit power output level over leased lines.</p> <p>Enter a value from 0 to -15 dBm. The factory setting is 0 dBm.</p>	Configure/Edit\ Leased Line
S46	<p>Auto Dial Backup. Register determines if the modem performs an automatic dial backup if the leased lines fail.</p> <p>Register has the following values:</p> <ul style="list-style-type: none"> <li>0 = Disable</li> <li>1 = Enable</li> </ul> <p>The factory setting is Disable.</p>	Configure/Edit\ Leased Line
<p><sup>2</sup> The range of allowable values is 0 through 15 in North America, and 1 through 15 in other countries. The default is country dependent.</p>		

**Table 5-4**  
**(5 of 13)**  
**391x Series S-Registers**

<b>S-Register</b>	<b>Description</b>	<b>DCP LCD Command Sequence</b>
S47	<p>Auto Dial Standby. Register determines if the modem performs an automatic dial standby if in Dial Backup mode.</p> <p>Register has the following values:</p> <ul style="list-style-type: none"> <li>0 = Disable</li> <li>1 = 15 minutes</li> <li>2 = 1 hour</li> <li>3 = 4 hours</li> <li>4 = Test(2min)</li> <li>5 = Adv 15min</li> <li>6 = Adv 30min</li> <li>7 = Adv 1 hr</li> <li>8 = Adv2minTest</li> </ul> <p>The factory setting is Disable.</p>	Configure/Edit\ Leased Line
S48	<p>Leased-Line Carrier On Level. Register determines if the modem disconnects if the carrier signal on leased lines falls below <math>-26</math> dBm or <math>-43</math> dBm.</p> <p>Register has the following values:</p> <ul style="list-style-type: none"> <li>0 = <math>-43</math> dBm</li> <li>1 = <math>-26</math> dBm</li> <li>2 = <math>-33</math> dBm</li> </ul> <p>The factory setting is country dependent (usually <math>-43</math> dBm). In France, the factory setting is <math>-26</math> dBm in 4-wire operation and <math>-33</math> dBm in 2-wire operation.</p>	Configure/Edit\ Leased Line
S49	<p>Buffer Disconnect Delay. Register determines how long the modem continues to transmit data stored in its buffers when the modem is commanded to disconnect by a locally attached DTE.</p> <p>Enter a value from 0–255 seconds. (A value of 0 disables this register.) The factory setting is 10 seconds.</p>	Configure/Edit\ V42/MNP/Buffer
S51	<p>DTE RL (CT140). Register determines if the modem performs a remote digital loopback if it receives a CT140 signal from the DTE.</p> <p>Register has the following values:</p> <ul style="list-style-type: none"> <li>0 = Disable</li> <li>1 = Enable</li> </ul> <p>The factory setting is Disable.</p>	Configure/Edit\ Tests
S52	<p>DTE LL (CT141). Register determines if the modem performs a local analog loopback if it receives a CT141 signal from the DTE.</p> <p>Register has the following values:</p> <ul style="list-style-type: none"> <li>0 = Disable</li> <li>1 = Enable</li> </ul> <p>The factory setting is Disable.</p>	Configure/Edit\ Tests

**Table 5-4  
(6 of 13)  
391x Series S-Registers**

S-Register	Description	DCP LCD Command Sequence
S53	V.54 Address. Identifies the address of the modem to be placed in a loopback test.  Register has the following values: 0 = Disable 1–34 = Modem address  The factory setting is Disable.	Configure\Edit\ Tests
S54	V.54 Device Type. Identifies where the modem is physically located in the network.  Register has the following values: 0 = Peripheral 1 = Intermediate  The factory setting is Peripheral.	Configure\Edit\ Tests
S55	Access From Remote. Register determines if a modem's DCP can be accessed by a remote modem.  Register has the following values: 0 = Enable 1 = Disable  The factory setting is Enable.	Configure\Edit\ Misc
S56	Remote Access Password. Register allows entry of the first pair (leftmost) of digits of a remote access password. Any value from 00 to 99 is valid. For example, if the remote access password is 12345678, then S56 = 1 and 2.	Configure\Edit\ Misc
S57	Remote Access Password. Register allows entry of the second pair of digits of a remote access password. Any value from 00 to 99 is valid.	Configure\Edit\ Misc
S58	Remote Access Password. Register allows entry of the third pair of digits of a remote access password. Any value from 00 to 99 is valid.	Configure\Edit\ Misc
S59	Remote Access Password. Register allows entry of the fourth pair (rightmost) of digits of a remote access password. Any value from 00 to 99 is valid.	Configure\Edit\ Misc

**Table 5-4  
(7 of 13)  
391x Series S-Registers**

<b>S-Register</b>	<b>Description</b>	<b>DCP LCD Command Sequence</b>
S61	<p>CT111 Rate Control. Register determines if CT111 Rate is disabled, set for Fallback 1 or Fallback 2.</p> <p>CT111 Rate allows the DTE to control modem rate via Pin 23 of the EIA-232-D interface. This configuration option determines the effect of the DTE Rate Control signal. It is only valid in Async Direct mode and Synchronous mode. For proper operation, disable the V.32bis Autorate and V.32bis Automode configuration options.</p> <p>Register has the following values:            0 = Disable            1 = Fallback            2 = Fallback 2</p> <p>The factory setting is Disable.</p>	Configure\Edit\ DTE Interface
S62	<p>V.25bis Coding. Register identifies to the modem the type of coding used by the DTE while in V.25bis mode.</p> <p>Register has the following values:            0 = ASCII            1 = EBCDIC</p> <p>The factory setting is ASCII.</p>	Configure\Edit\ DTE Dialer
S63	<p>V.25bis Idle Character. Register identifies to the modem the type of idle fill used by the DTE while in V.25bis mode.</p> <p>Register has the following values:            0 = Mark            1 = Flag</p> <p>The factory setting is Mark.</p>	Configure\Edit\ DTE Dialer
S64	<p>V.25bis New Line Character. Register identifies to the modem the type of line terminator used by the DTE while in V.25bis mode.</p> <p>Register has the following values:            0 =Carriage Return and Line Feed            1 =Carriage Return            2 =Line Feed</p> <p>The factory setting is carriage return and line feed (CR + LF).</p>	Configure\Edit\ DTE Dialer
S65	<p>Line Current Disconnect. Register determines if the modem disconnects if an 8-millisecond or 90-millisecond interruption in loop current occurs.</p> <p>Register has the following values:            0 = Enable (8msec)            1 = Enable (90msec)            2 = Disable</p> <p>The factory setting is Enable (8msec).</p>	Configure\Edit\ Line Dialer

**Table 5-4  
(8 of 13)  
391x Series S-Registers**

<b>S-Register</b>	<b>Description</b>	<b>DCP LCD Command Sequence</b>
S66	<p>NMS Call Messages. Register determines if the modem sends information regarding status (Call Progress) and/or sends summarized call statistics (Call Connect) to the 6700 Series Network Management System (NMS).</p> <p>Register has the following values:            0 = Call Connect &amp; Progress            1 = Disable            2 = Call Connect Only            3 = Call Progress Only</p> <p>The factory setting is Call Connect &amp; Progress.</p>	Configure\Edit\ Misc
S67	<p>Directory Location 1 Callback. Register determines if the modem uses the single number callback function.</p> <p>Register has the following values:            0 = Disable            1 = Enable</p> <p>The factory setting is Disable.</p>	Configure\Edit\ Misc
S69	<p>Make Busy Via DTR. Register determines if the modem goes off-hook (busy) when DTR is OFF.</p> <p>Register has the following values:            0 = Disable            1 = Enable</p> <p>The factory setting is Disable.</p>	Configure\Edit\ Line Dialer
S70	<p>V.27bis Train. Register controls the train time for V.27bis operation.</p> <p>Register has the following values:            0 = Short            1 = Long</p> <p>The factory setting is Short.</p>	Configure\Edit\ Leased Line
S71	<p>XTXC Clamps TXC. Register allows the modem's TXC output to be clamped off when TX Clock Source is configured for External.</p> <p>Register has the following values:            0 = Enable            1 = Disable</p> <p>The factory setting is Enable.</p>	Configure\Edit\ DTE Interface



**Table 5-4  
(9 of 13)  
391x Series S-Registers**

<b>S-Register</b>	<b>Description</b>	<b>DCP LCD Command Sequence</b>
S72	<p>RTS Antistreaming. Register determines the antistreaming operation of the modem.</p> <p>Register has the following values:</p> <ul style="list-style-type: none"> <li>0 = Disable</li> <li>1 = 10 sec</li> <li>2 = 30 sec</li> <li>3 = 1 min</li> <li>4 = 2 min</li> <li>5 = 3 min</li> <li>6 = 5 min</li> </ul> <p>The factory setting is Disable.</p>	Configure/Edit\ DTE Interface
S74	<p>Network Position Identification. Register identifies each modem as either a control or tributary modem.</p> <p>Register has the following values:</p> <ul style="list-style-type: none"> <li>0 = Tributary</li> <li>1 = Control</li> </ul> <p>The factory setting is Tributary.</p>	Configure/Edit\ Misc
S75	<p>Network Management Address. Register determines the modem's network address. This address is used when accessing the modem from the 6700 Series NMS.</p> <p>Enter a value from 0 (network address 001) to 255 (network address 256). The factory setting is 0.</p>	Configure/Edit\ Dial
S76	<p>V.32bis Autorate (Dial Line). Register determines if Autorating is used on dial lines when connected in V.32bis mode.</p> <p>Register has the following values:</p> <ul style="list-style-type: none"> <li>0 = Enable</li> <li>1 = Disable</li> </ul> <p>The factory setting is Enable.</p>	Configure/Edit\ Dial Line
S78	<p>V.32bis Automode (Dial Line). Register allows the modem (when operating on dial lines) to automatically detect and connect to the remote modem's modulation scheme.</p> <p>Register has the following values:</p> <ul style="list-style-type: none"> <li>0 = Enable</li> <li>1 = Disable</li> </ul> <p>The factory setting is Enable.</p>	Configure/Edit\ Dial Line

**Table 5-4  
(10 of 13)  
391x Series S-Registers**

<b>S-Register</b>	<b>Description</b>	<b>DCP LCD Command Sequence</b>
S82	<p>V.32bis Autorate (Leased Line). Register determines if Autorating is used on leased lines when connected in V.32bis mode.</p> <p>Register has the following values:            0 = Enable            1 = Disable</p> <p>The factory setting is Enable.</p>	Configure\Edit\ Leased Line
S84	<p>AT Command Mode. Register determines how the modem responds to valid and invalid AT commands.</p> <p>Register has the following values:            0 = Normal            1 = No ERROR            2 = No Strap or ERROR</p> <p>The factory setting is Normal.</p>	Configure\Edit\ DTE Dialer
S85	<p>Fast Disconnect. Register allows the modem to disconnect immediately after receiving a disconnect command from a local DTE or its own diagnostic control panel.</p> <p>Register has the following values:            0 = Disable            1 = Enable</p> <p>The factory setting is Disable.</p>	Configure\Edit\ Line Dialer
S88	<p>Straps When Disconnected. Register determines whether or not configuration options in the Active (Saved) configuration area are reloaded to Active (Operating) when a disconnect occurs.</p> <p>Register has the following values:            0 or 231 = No Change            1 or 232 = Reload</p> <p>The factory setting is No Change.</p>	Configure\Edit\ Misc

**Table 5-4  
(11 of 13)  
391x Series S-Registers**

<b>S-Register</b>	<b>Description</b>	<b>DCP LCD Command Sequence</b>
S89	<p>V.42 Automatic Request for Retransmission (ARQ) Window Size Increase. Register allows the ARQ window size to be set to a value from six frames to fifteen frames.</p> <p>For best performance, this register should remain at its default setting of six frames (ATS89 = 0). The only reason to change it is for satellite delays.</p> <p>Register has the following values:</p> <ul style="list-style-type: none"> <li>0 = six frames</li> <li>1 = seven frames</li> <li>2 = eight frames</li> <li>3 = nine frames</li> <li>4 = ten frames</li> <li>5 = eleven frames</li> <li>6 = twelve frames</li> <li>7 = thirteen frames</li> <li>8 = fourteen frames</li> <li>9 = fifteen frames</li> </ul> <p>The factory setting is 0 (six frames).</p> <p>This command only applies when the modem connects using V.42bis data compression or V.42 error control. If the modem is configured for Direct mode, MNP mode, Buffer mode, or Synchronous operation, this command is invalid.</p> <p>This command does not have a front panel equivalent.</p>	
S90	<p>DTE Rate = VF. Register allows the DTE's data rate to be equal to the VF (telephone line) data rate. If Enabled, the data rate between the DTE and modem is the same as the modem's VF data rate. As a result, when the modem is in Data mode, the speed of the data passed between the modem and DTE occurs at the VF data rate.</p> <p>Register has the following values:</p> <ul style="list-style-type: none"> <li>0 = Disable</li> <li>1 = Enable</li> </ul> <p>The factory setting is Disable.</p>	Configure\Edit\ DTE Interface
S91	<p>Cellular Enhancement. Register allows the modem to use non-standard techniques to enhance V.42 operation for cellular applications. It is still compatible, however, with modems which do not have the cellular enhancement implemented or enabled.</p> <p>Register has the following values:</p> <ul style="list-style-type: none"> <li>0 = Disable</li> <li>1 = Enable</li> </ul> <p>The factory setting is Disable.</p>	Configure\Edit\ V42/MNP/Buffer

**Table 5-4  
(12 of 13)  
391x Series S-Registers**

<b>S-Register</b>	<b>Description</b>	<b>DCP LCD Command Sequence</b>
S92	<p>V.29 Train On Data. When enabled, the modem receiver can train based upon the incoming data or a training sequence from the distant modem. This function is necessary for a remote (tributary) modem in a V.29 multipoint network and is recommended for a control modem as well.</p> <p>Register has the following values:            0 = Disable            1 = Enable</p> <p>The factory setting is Disable.</p>	Configure\Edit\ Leased
S93	<p>V.29 Retrain. When enabled, the modem transmits a training sequence whenever it receives one. This configuration option should normally be disabled for control modems.</p> <p>Register has the following values:            0 = Enable            1 = Disable</p> <p>The factory setting is Enable.</p>	Configure\Edit\ Leased
S94	<p>V29 Link Configuration. Selects point-to-point or multipoint operation.</p> <p>Register has the following values:            0 = PointToPoint            1 = Multipoint</p> <p>The factory setting is PointToPoint.</p>	Configure\Edit\ Leased
S95	<p>Trellis Multipoint (TMp) Train Time. Defines the length of time energy is sent from the tributary modem to the control modem. More severe line conditions require longer time selections.</p> <p>Register has the following values:            0 = 10 milliseconds            1 = 20 milliseconds            2 = 50 milliseconds            3 = 100 milliseconds            4 = 200 milliseconds            5 = 300 milliseconds</p> <p>The factory setting is 0 (10 milliseconds).</p>	Configure\Edit\ Leased
S96	<p>Trellis Multipoint (TMp) Tx Preemphasis. Provides amplification for frequencies above the carrier frequency to compensate for high frequency line attenuation.</p> <p>Register has the following values:            0 = Enable            1 = Disable</p> <p>The factory setting is Enable.</p>	Configure\Edit\ Leased

**Table 5-4**  
**(13 of 13)**  
**391x Series S-Registers**

<b>S-Register</b>	<b>Description</b>	<b>DCP LCD Command Sequence</b>
S97	<p>Reduced Asynchronous Buffer Size. Register limits the modem's buffer size to a maximum of 20 characters.</p> <p>Register has the following values:            0 = Disable            1 = Enable</p> <p>The factory setting is Disable.</p>	Configure/Edit\ V42/MNP/Buffer
S98	<p>Special Standby. Supports automatic dial standby when a third modem is used for dial backup.</p> <p>Register has the following values:            0 = Disable            1 = Enable</p> <p>The factory setting is Disable.</p>	Configure/Edit\ Leased

---

# Dial Access Security **6**

Chapter 6, *Dial Access Security*, is not available for viewing online because it contains security-sensitive information. Dial Access Security information is available in the *COMSPHERE 3900 Series Modems Models 3910 and 3911 Point-To-Point/Multipoint Installation and Operation Manual*, Document No. 3910-A2-GN32-30.

To order product documentation contact your sales representative.

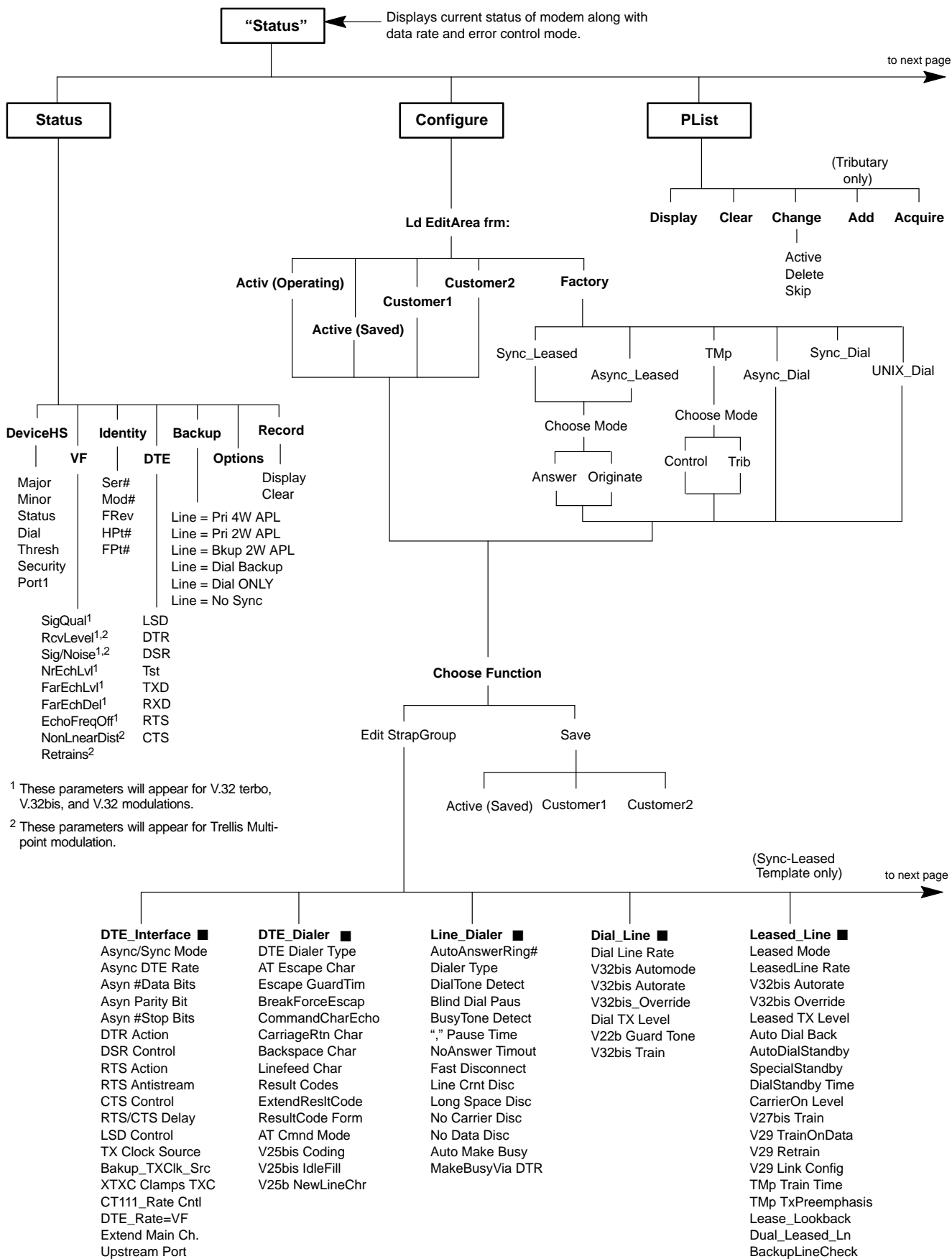
---

# Menu Tree **A**

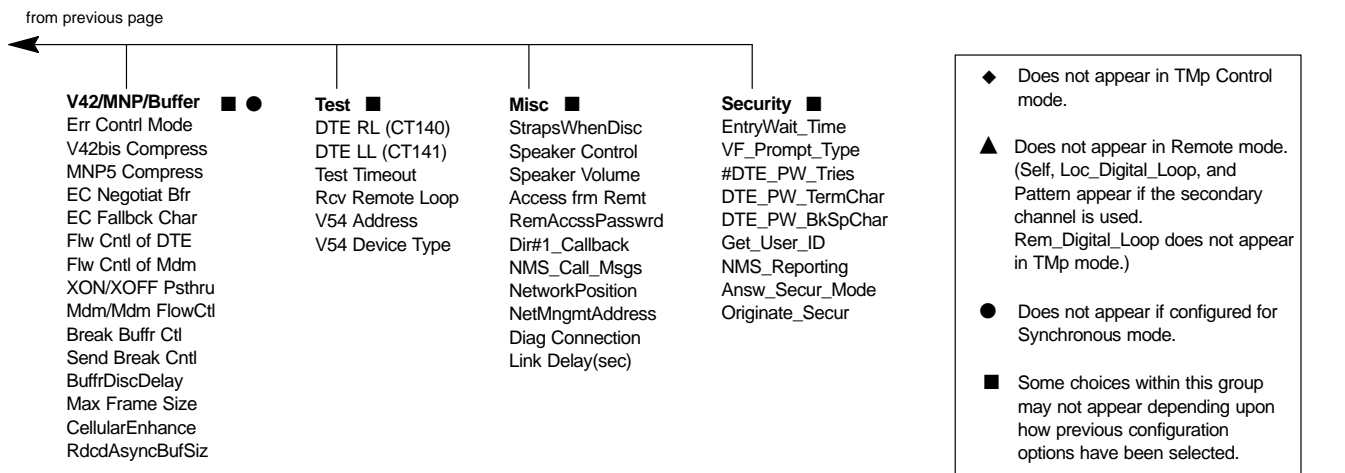
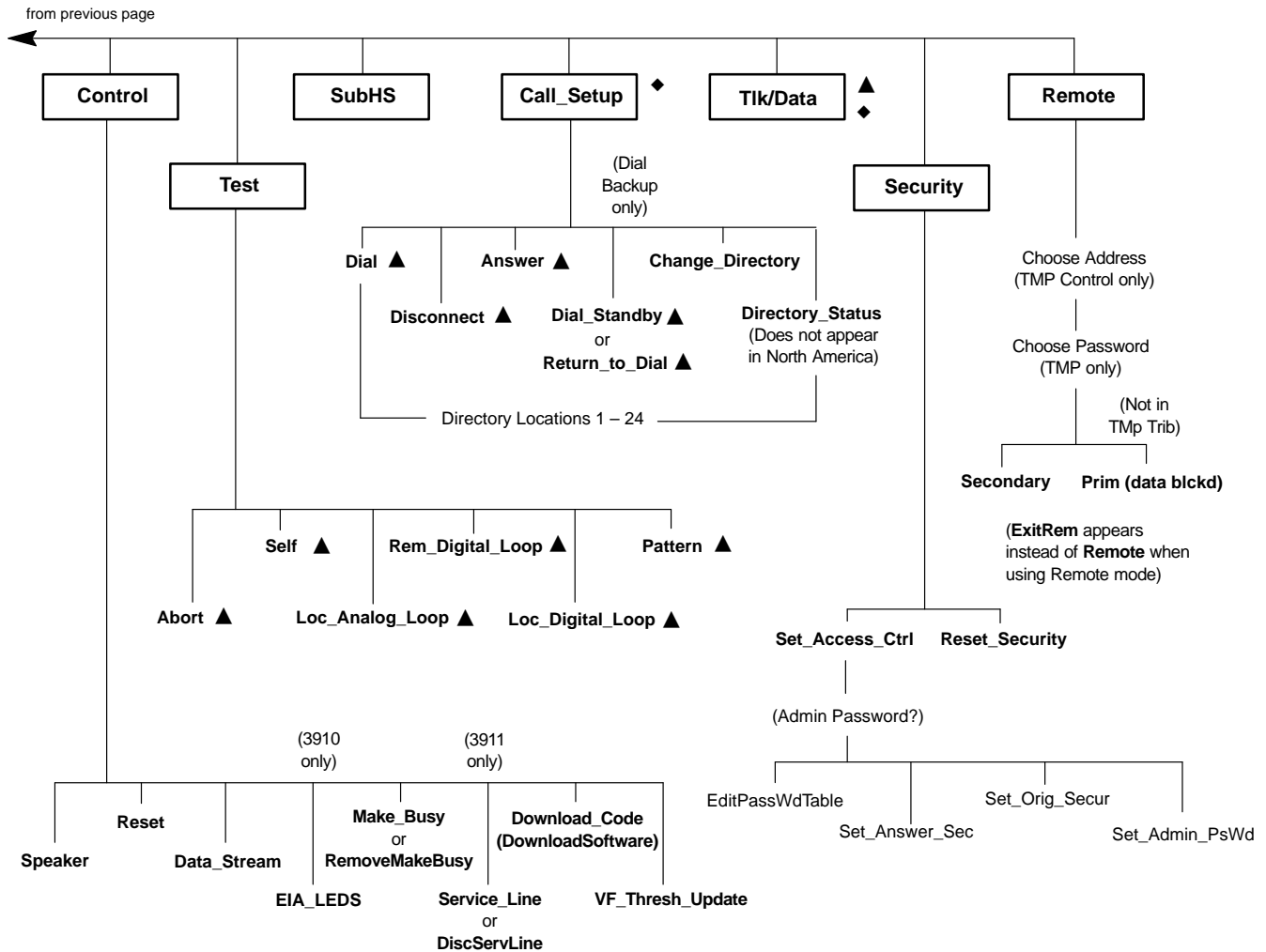
Overview ..... A-1

## Overview

Pages A-2 and A-3 provide a menu tree for the 391x Series modems.







---

# Troubleshooting **B**

Overview ..... B-1

## Overview

This appendix points out basic problems that can occur when operating a 391x Series modem. Use Tables B-1 through B-6 to check out these problems. If you are having data communication difficulties, such as periodic character loss, random errors, or constant format errors, use the loopback tests described in the *Test* section of Chapter 4. With these tests you can usually isolate the fault in your system by using the process of elimination. If problems continue to occur, contact your service representative.

**Table B-1**  
**Modem Health**

Symptom	Action
The modem did not pass the power-up self-test.	Contact your service representative.
The power LED does not light or the LCD does not display information.	Make sure the modem's ON/OFF switch is in the ON position. Make sure the power supply is connected to the dc power receptacle on the modem. If the Power LED and/or LCD do not operate, contact your service representative.
A problem is suspected after the power-up self-test.	Perform a self-test via the modem's DCP or type AT&T9 if using AT commands. Perform a local analog loopback with a Pattern test. If the modem consistently registers errors, contact your service representative. If the modem passes the above tests and a problem still exists, then the problem is probably not with your modem.

**Table B-2  
Leased-Line Operation**

<b>Symptom</b>	<b>Action</b>
The modems do not train-up on leased lines.	<p>Verify that the correct cabling is used for your application. Refer to Chapter 2, <i>Modem Installation</i>.</p> <p>Verify that one modem is configured for Answer mode and the other is configured for Originate mode. (For Tmp operation one modem must be configured as a control modem and the other as a tributary modem.)</p> <p>Verify that both modems are using the same modulation scheme.</p> <p>Verify that both modems are configured for the appropriate leased-line mode. For example, if you have a 4-wire leased line, then the modems must be configured for 4-wire operation.</p>

**Table B-3  
Dial Backup Operation**

<b>Symptom</b>	<b>Action</b>
The dial backup line is present, but the modems cannot connect.	<p>Verify that the correct telephone number for the remote modem is stored in directory location 1.</p> <p>Verify that both modems have the Auto Dial Backup configuration option set to Enable. Refer to <i>Leased Line</i> in Chapter 4.</p> <p>Call the answering modem with a handset and verify that the modem's answer tone is transmitted.</p>
The modem does not switch back to leased-line operation.	Verify that the Auto Dial Standby configuration option is enabled. Refer to <i>Leased Line</i> in Chapter 4.

**Table B-4**  
**Modem — DTE Connection**

<b>Symptom</b>	<b>Action</b>
<p>The modem does not accept or echo back AT commands.</p>	<p>Verify that the cable between the Async port of the DTE and the modem is a standard RS-232 cable. (Null modem cables, also known as crossover cables, do not work in this application.)</p> <p>Verify that the Command Character Echo configuration option is enabled. Refer to <i>DTE Dialer</i> in Chapter 4.</p> <p>Verify that the DTE Dialer Type configuration option is set to AT. Refer to <i>DTE Dialer</i> in Chapter 4.</p> <p>Verify that the Result Codes configuration option is enabled. Refer to <i>DTE Dialer</i> in Chapter 4.</p> <p>Reload the Async Dial factory configuration area to guarantee that all configuration options are returned to their proper setting.</p> <p>Make sure that all AT commands are terminated with a carriage return.</p> <p>Verify that the Carriage Return Character configuration option matches what is used by the DTE. Refer to <i>DTE Dialer</i> in Chapter 4.</p> <p>Verify that the DTE has a valid character format. Valid format consists of 8 data bits with no parity or 7 data bits with even, odd, mark or space parity.</p> <p>Verify that the DTE's data rate is supported by the modem. Refer to the Async DTE Rate configuration option in the <i>DTE Interface</i> section of Chapter 4.</p> <p>If using a PC, verify that the modem is attached to the correct communications port.</p>

**Table B-5**  
**(1 of 2)**  
**Modem — VF Connection**

Symptom	Action
The modem does not receive a dial tone.	<p>Attach a telephone directly to the telephone line to verify that a dial tone exists.</p> <p>Make sure the VF line is connected to the modem's rear jack labeled DIAL.</p>
The modem does not go off-hook and answer an incoming call.	<p>Verify that the Auto Answer Ring Count configuration option is set to a value other than 0 (disable). Refer to <i>Line Dialer</i> in Chapter 4.</p> <p>Verify that the DTE is providing DTR to the modem.</p> <p>If the DTE does not provide DTR to the modem, verify that the modem's DTR Action configuration option is set for Ignore. Refer to <i>DTE Interface</i> in Chapter 4.</p> <p>Verify that all cables are attached to the correct connectors on the rear of the modem.</p>
The modem goes off-hook, answers, but does not connect.	<p>Perform a Local Analog Loopback test and verify that data entered at the DTE is echoed back to the DTE.</p> <p>Verify that the originating modem is compatible with your receiving modem.</p> <p>Verify that the originating modem recognizes your modem's answer tone.</p> <p>Verify that the originating modem supports your modem's modulation schemes. The 391x Series modem recognizes CCITT V.32bis, V.32, V.22bis, V.22, V.21, Bell 212A, and Bell 103J. The 391x Series modem does not support other vendors' proprietary modulation schemes.</p> <p>Force your modem to operate at the same modulation scheme as the originating modem to see if they connect.</p>
The Originate Mode does not function properly.	<p>Verify that the modem's DTE Dialer Type configuration option is set to the correct setting: either AT, DTR Dialing, V.25bis Async, V.25bis Bisync, or V.25bis HDLC. Refer to <i>DTE Dialer</i> in Chapter 4.</p>
The modem does not go off-hook and begin dialing.	<p>If using AT Dialing, refer to the Table B-2, Modem—DTE Connection.</p> <p>If using DTR Dialing, verify the telephone number stored in directory location 1, and verify that the DTE is raising DTR from Off to ON to initiate a dial.</p> <p>If using V.25bis Async, verify that the correct character format is set to 7 data bits with even parity and 1 stop bit, and the carriage return and line feed are used as command terminators.</p> <p>If using V.25bis Bisync, verify that the correct character format uses two synchronous control characters and a start-of-text control character before the text block, and an end-of-text control character after the text block.</p> <p>If using V.25bis HDLC, verify that the character format uses flag, address, and control characters before the text block and a frame sequence check and flag after the text block.</p>

**Table B-5  
(2 of 2)  
Modem — VF Connection**

Symptom	Action
The modem dials but does not connect.	<p>If the modem is operating behind a PBX, determine if a 9 and comma are needed before the telephone number.</p> <p>Verify whether Tone or Pulse dialing is needed.</p> <p>Verify that both modems are configured the same in regard to Error Control. Try calling in Buffer mode.</p> <p>If both modems use V.32bis or V.32 modulation, try setting the modem's V.32bis Train configuration option to Long.</p>
Intermittent disconnects, high error rates, or excessive retransmissions occur.	Perform an End-to-End test. Refer to <i>Pattern</i> located in the <i>Test Branch</i> section of Chapter 3.
The modem establishes and then disconnects the call.	<p>You may have a poor VF connection. Try dialing again.</p> <p>The remote modem may have encountered an error control (EC) disconnect. If the modems cannot negotiate EC, then a disconnect occurs.</p> <p>The remote modem may be in a forced Error Control mode (disconnect if there is no error control). Reconfigure your modem to V.42/MNP or Buffer and try again.</p> <p>Check the LCD to determine the reason for the disconnect.</p> <p>Perform a Local Analog Loopback test.</p>
High error rates occur when running a local loopback or self-test.	Incoming rings can cause data errors during a loopback test. Abort the test, disconnect the modular VF cord, and restart the test.

**Table B-6  
Online Operation**

Symptom	Action
The data is scrambled.	Verify that the character format (data bits, parity, and stop bits) is set to the same value in both modems.
Data is missing during a transfer.	<p>Verify that you are using the same method of flow control for both the modem and the DTE.</p> <p>If using XON/XOFF flow control, verify that the modem's parity matches the DTE's parity.</p>

---

# Pin Assignments **C**

Overview ..... C-1  
EIA-232-D Pin Assignments ..... C-2  
VF Connector Pin Assignments ..... C-3  
Auxiliary Cables Not Supplied ..... C-4

## Overview

This appendix lists EIA-232-D and VF TELCO pin assignments and provides information about auxiliary cables which are not supplied.

## EIA-232-D Pin Assignments

Table C-1 lists the EIA-232-D pin assignments for the modem.

**Table C-1**  
**EIA-232-D Pin Assignments**

Pin	Name	EIA Circuit	CCITT	Signal Source	Circuit Function
1	—	AA	101	—	Shield
2	TXD	BA	103	DTE	Transmit Data
3	RXD	BB	104	DCE	Receive Data
4	RTS	CA	105	DTE	Request-to-Send
5	CTS	CB	106	DCE	Clear-to-Send
6	DSR	CC	107	DCE	Data Set Ready
7	SG	AB	102	—	Signal Ground
8	LSD	CF	109	DCE	Line Signal Detect
9	+12V	—	—	—	Reserved for test purposes (may be used to drive one RS-232 load)
10	-12V	—	—	—	Reserved for test purposes (may be used to drive one RS-232 load)
11	—	—	—	—	Unassigned
12	CT112	CI	112	DCE	Data Signal Rate Select
13	—	—	—	—	Reserved for future function
14	—	—	—	—	Reserved for future function
15	TXC	DB	114	DCE	Transmit Clock
16	—	—	—	—	Reserved for future function
17	RXC	DD	115	DCE	Receive Clock
18	CT141	LL	141	DTE	Local Loopback
20	DTR	CD	108	DTE	Data Terminal Ready
21	CT140	RL	140	DTE	Remote Loopback
22	RI	CE	125	DCE	Ring Indicator
23	CT111	CH	111	DTE	Data Rate Selector
24	XTXC	DA	113	DTE	External Clock
25	TEST	TM	142	DCE	Test Mode

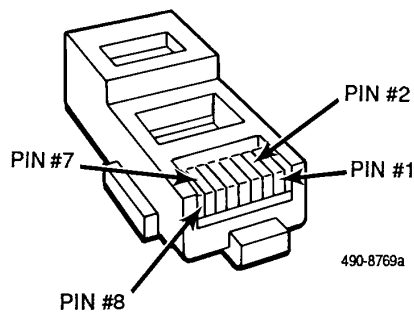


## VF Connector Pin Assignments

Table C-2 lists the connector pin assignments for Model 3910 modular jacks as well as the pin assignments for the TELCO jacks. (See Figure C-1.)

**Table C-2**  
**VF Connector Pin Assignments**

Pin	Leased	Dial	Type of Telco Jack		
			RJ11	JM8	6-Pin Leased
1	4-Wire: TX 2-Wire: TX/RX			Ring 1	
2	4-Wire: TX 2-Wire: TX/RX			Tip 1	
3					
4		Ring	Ring		Ring
5		Tip	Tip		Tip
6					
7	4-Wire: RX			Tip	
8	4-Wire: RX			Ring	



**Figure C-1. VF Pin Orientation**

## Auxiliary Cables Not Supplied

To add an external telephone to your modem, use an external “Y” cable to connect the phone line to both the modem and the telephone (Figure C-2).

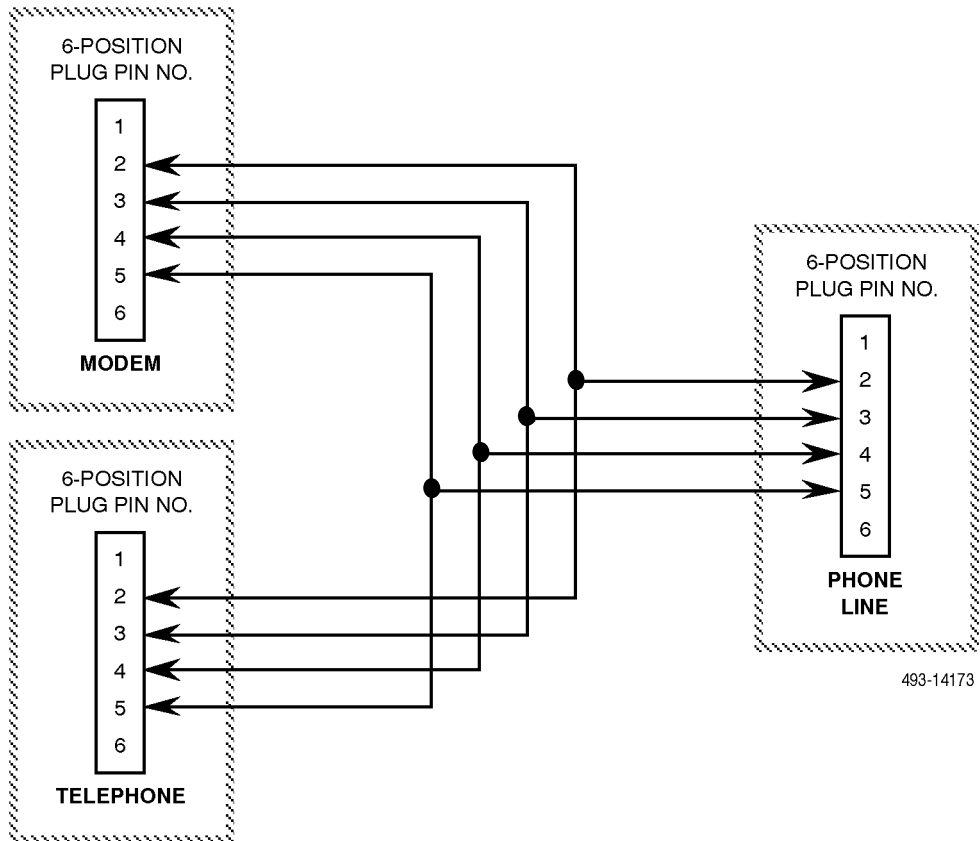


Figure C-2. Wiring Diagram — “Y” Cable for External Telephone

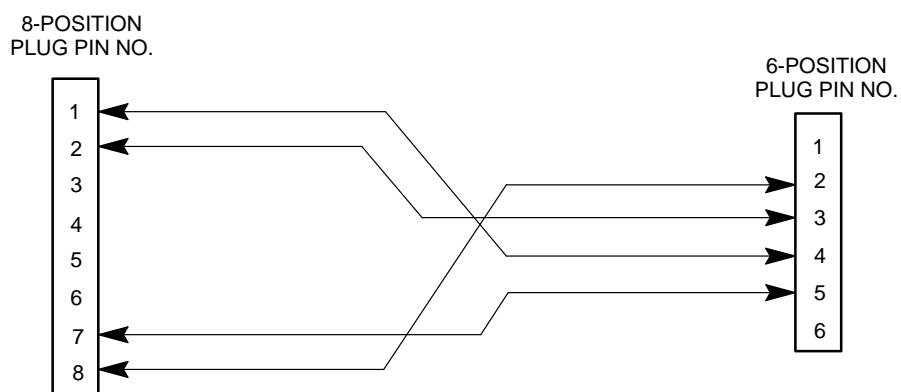
For 2-wire leased-line connections to a JM8 network interface, use an 8-position to 6-position crossover cable (Figure C-3) according to the following FCC requirements:

*“The RJ series of jacks should not be used for connecting data equipment to nonswitched private line networks — specifically, the service equivalents of the pre-divestiture Series 3002 (Category II, Tariff #260) service. There is a substantial difference in transmit levels permitted in the private line service and those permitted in the public switched network. The industry standard is now an 8-pin keyed modular jack known as the USOC JM8 (Bellcore Technical Reference: TR-EOP-000242, Issue 1, released May 1985.) When ordering the installation of the USOC JM8, specify the appropriate wiring options:*

- 2-wire operations
- 4-wire operations w/o TEK leads
- 4-wire operations with TEK leads

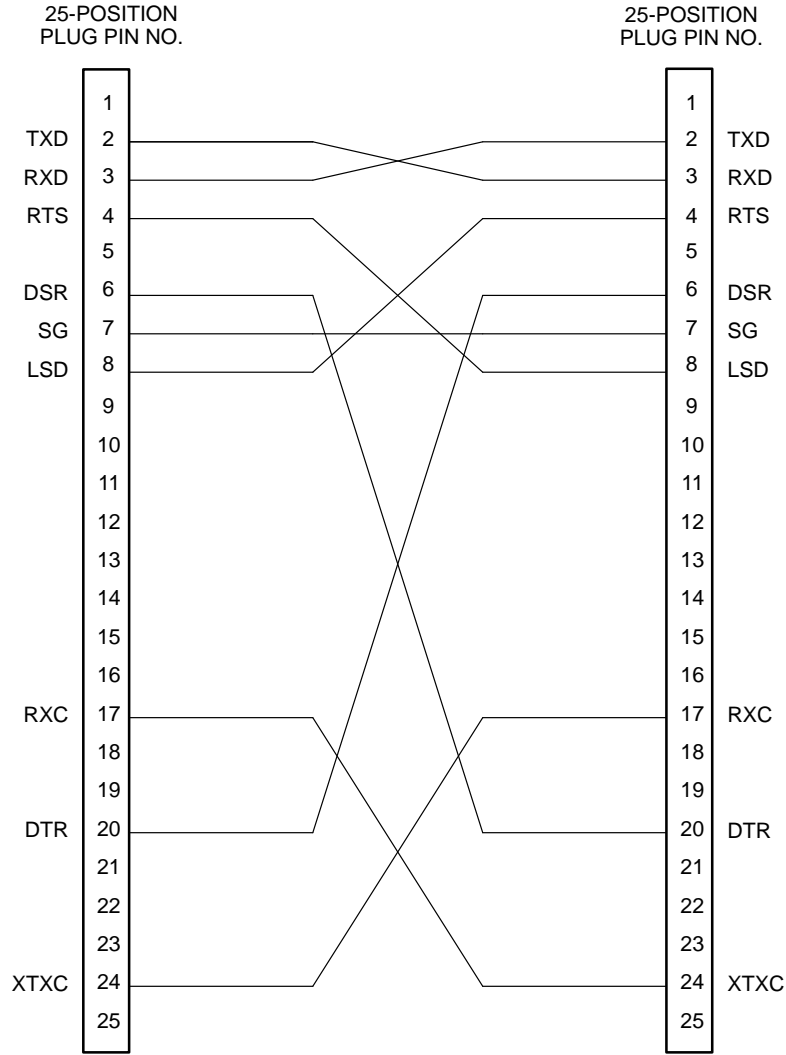
*TEK leads are for loopback purposes.*

*A 50-pin version is being considered for multiple line connections.”*



**Figure C-3. Wiring Diagram — 8-Position to 6-Position Crossover Cable**

To connect a Model 3910 port to another modem's EIA-232-D interface, use a 25-pin crossover cable (Figure C-4).



**Figure C-4. Wiring Diagram — 25-Pin Crossover Cable**

---

# CCITT V.25bis Dialing Commands and Responses **D**

Overview .....	D-1
Call Request Commands .....	D-2
Call Request with Number Provided (CRN) .....	D-2
Call Request with Stored Memory Address Provided (CRS) .....	D-2
Call Response .....	D-2
Call Failure Indication (CFI) .....	D-2
Call Connecting (CNX) .....	D-3
Delayed Call Indicator .....	D-3
Call Answer Commands .....	D-3
Incoming Call (INC) .....	D-3
Disregard Incoming Call (DIC) .....	D-3
Connect Incoming Call (CIC) .....	D-4
Program Normal (PRN) .....	D-4
Request List of Delayed Numbers (RLD) .....	D-4
Request List of Forbidden Numbers (RLF) .....	D-4
Request List of Stored Numbers (RLN) .....	D-5
List Delayed Numbers Response (LSD) .....	D-5
List Forbiddent Numbers Response (LSF) .....	D-5
List Stored Number Response (LSN) .....	D-5
Command Response .....	D-6
Valid (VAL) .....	D-6
Invalid (INV) .....	D-6

## Overview

This appendix describes V.25bis dialing commands and responses. CCITT V.25bis is an international dialing protocol that permits direct and stored number dialing using DTEs in either Asynchronous, Bisynchronous, or HDLC operating mode. The 391x Series modems support V.25bis request and answer commands. As commands are entered from the DTE, the 391x Series modems issue a response to the DTE which indicates if the call failed or connected, or if the command is valid or invalid.

The following sections discuss those V.25bis commands supported by the 391x Series modems and the response to those commands. Tables D-1 and D-2 list the V.25bis commands and response messages.

### NOTE

The 391x Series modem must be configured for V.25bis dialing. Refer to DTE Dialer Type configuration option in Chapter 4, *DCP Configuration*.

## Call Request Commands

Call Request commands are issued from the DTE to the modem and are responsible for initiating dial calls. Call Request commands include Call Request with Number Provided (CRN) and Call Request with Stored Memory Address Provided (CRS).

### Call Request with Number Provided (CRN)

The CRN command dials the telephone number entered from the DTE. CRN is similar to the ATD command.

The CRN command format is:

**CRN***n*

**Where:** *n* is the telephone number to be dialed.

### Call Request with Stored Memory Address Provided (CRS)

The CRS command dials the telephone number stored in the request directory location. CRS is similar to the ATDS command.

The CRS command format is:

**CRS***x*

**Where:** *x* is directory location 1–24.

The modem responds to the command with either a VAL (valid) or INV (invalid) response followed by a call progress report such as connect (CNX) or failure (CFI).

## Call Response

A Call Response indicates if the command was accepted by the modem. Call Response includes Call Failure Indication (CFI) and Call Connecting (CNX).

### Call Failure Indication (CFI)

The CFI response is issued to the DTE if the modem fails a CRN or CRS command. CFI is similar to the AT result codes BUSY, NO ANSWER, NO CARRIER, NO DIALTONE, and ERROR.

The CFI response format is:

**CFI***xx*

**Where:** *xx* is

**ET** is Engaged tone.  
**NS** is Number not stored.  
**CB** is Local DCE busy.  
**RT** is Time-out on ring tone.  
**AB** is Abort call on time-out.  
**NT** is Answer tone not detected.  
**FC** is Forbidden call.

**ET** is similar to the Call Failure Messages Busy Signal and Trunk Busy and the result code BUSY.

**NS** is similar to the Common Operational Message Invalid Number and the result code ERROR.

**CB** is similar to the Call Failure Messages Dial Line in Use and No Dial-Test and the result code ERROR.

**RT** is similar to the Call Failure Message No Answer Tone and the result code NO CARRIER.

**AB** is similar to the Call Failure Messages No Dial Tone and No Dial-DTR and the result code NO DIALTONE and ERROR.

**NT** is similar to the Call Failure Message No Quiet Answer and the result code NO ANSWER.

## Call Connecting (CNX)

The CNX response informs the DTE that the modem has connected to the remote modem. CNX is similar to the AT result code CONNECT.

The CNX response format is CNX.

## Delayed Call Indicator

The DLC response is issued to the DTE if the modem is not currently allowed to call the number. DLC is similar to the AT result code DELAYED.

The DLC response format is:

DLC*n*

*Where:* *n* is the delay (in minutes) before the number can be called.

## Call Answer Commands

Call Answer commands disable or enable the modem's AutoAnswer function. These commands are issued from the DTE. Call Answer commands include Incoming Call (INC), Disregard Incoming Call (DIC) and Connect Incoming Call (CIC).

### Incoming Call (INC)

The INC response informs the DTE that the modem has detected a ring tone. At this point, the DTE can issue the DIC command to disable the modem from answering the call. INC is similar to the AT result code RING.

### Disregard Incoming Call (DIC)

The DIC command prevents the modem from answering an incoming call. This command is only valid once the DTE receives an incoming call (INC) response from the modem. A DIC must be issued within 5 seconds after receiving an INC.

The DIC command format is DIC.

If DIC is issued within 5 seconds, the modem sends the VAL response to the DTE. If DIC is issued after 5 seconds, INV is returned.

## Connect Incoming Call (CIC)

The CIC command forces the modem to cancel any DIC commands and answer an incoming call. This command is only valid when the DTE issues a DIC command. CIC must be issued within 10 seconds after sending a DIC. CIC is similar to the ATA command.

The CIC command format is CIC.

If CIC is issued within 10 seconds, the modem sends the VAL response to the DTE. If CIC is issued after 10 seconds, INV is returned.

## Program Normal (PRN)

The Program Normal (PRN) command allows the DTE to enter and store a telephone number to a specific directory location. PRN is similar to the AT&Z command.

The PRN command format is:

PRNx;n

*Where:*  $x$  is the directory location 1–24;  $n$  is the telephone number.

## Request List of Delayed Numbers (RLD)

The Request List of Delayed Numbers (RLD) command displays telephone numbers that are currently delayed as a result of failed call attempts. All the numbers currently delayed are displayed, irrespective of whether they belong to a directory location.

The RLD command format is RLD.

## Request List of Forbidden Numbers (RLF)

The Request List of Forbidden Numbers (RLF) command displays telephone numbers that are forbidden as a result of failed call attempts. All the numbers forbidden are displayed, irrespective of whether they belong to a directory location.

The RLF command format is RLF.



## Request List of Stored Numbers (RLN)

The Request List of Stored Numbers (RLN) command displays telephone numbers stored in the modem's directory location. If the RLN command is entered without specifying a directory location, then all directory locations and telephone numbers appear. If a directory location is entered, then only that telephone number appears.

The RLN command format is:

RLN

which displays all directory locations,

or

RLNx

*Where:*  $x$  is a directory location.

## List Delayed Numbers Response (LSD)

LSD is a response to an LSD command issued by DTE.

LSDx;n;d

*Where:*  $x$  is a sequence number (not a directory location).

$n$  is the telephone number.

$d$  is the delay in minutes

## List Forbidden Numbers Response (LSF)

The LSF response format is :

LSFx;n

*Where:*  $x$  is a sequence number (not a directory location).

$n$  is the telephone number.

## List Stored Numbers Response (LSN)

LSN is a response to an RLN command issued by the DTE. If a directory location is specified, then the telephone number for that location appears. If no directory location is specified, then all telephone numbers stored in memory appear.

The LSN response format is:

LSNx;n

## Command Response

A Command Response indicates that the command entered was a valid or invalid entry. Command Response includes Valid (VAL) and Invalid (INV).

### Valid (VAL)

The VAL response indicates that the modem has accepted the V.25bis command issued by the DTE. VAL is similar to the AT result code OK.

### Invalid (INV)

The INV response indicates that the modem has received an incorrect V.25bis command from the DTE. INV is similar to the AT result code ERROR.

The INV response format is:

INVxx

**Where:** xx is

**CU** command unknown.

**MS** message syntax error.

**PS** parameter syntax error.

**PV** parameter value error.

Table D-1 lists V.25bis commands supported by the 391x Series modems.

**Table D-1  
V.25bis Commands**

<b>V.25bis Command</b>	<b>Description</b>	<b>AT Command/ S-Register Equivalent</b>
<b>Call Request Commands</b>		
CRN	Call Request with Number Provided	ATD
CRS	Call Request with Memory Address	ATDS
<b>Call Answer Commands</b>		
INC	Incoming Call Indication	RING
DIC	Disregard Incoming Call	NONE
CIC	Connect Incoming Call	ATA
<b>Program Command</b>		
PRN	Program Normal	AT&Z
<b>List Request</b>		
RLD	Request to List Delayed Numbers	NONE
RLF	Request to List Forbidden Numbers	NONE
RLN	Request to List Stored Numbers	NONE
<b>List Response</b>		
LSD	List Delayed Numbers	NONE
LSF	List Forbidden Numbers	NONE
LSN	List Stored Numbers	NONE

Table D-2 lists V.25bis response messages supported by the 391x Series modems.

**Table D-2**  
**V.25bis Response Messages**

<b>V.25bis Command</b>	<b>Description</b>	<b>AT Command/ Result Code Equivalent</b>
<b>Call Response</b>		
CFI	Call Failure Indication	BUSY, NO ANSWER, NO CARRIER, NO DIAL TONE, ERROR
CNX	Call Connecting Indication	CONNECT
<b>Command Response</b>		
VAL	Valid Command	OK
INV	Invalid Command	ERROR

---

# ASCII Character Table

# E

Overview ..... E-1

## Overview

Table E-1 in this appendix provides the ASCII character table.

**Table E-1  
(1 of 4)  
ASCII Characters**

Hexadecimal ASCII Value	Decimal ASCII Value	Control Character	Key
00	000	NUL	CTRL-@
01	001	SCH	CTRL-A
02	002	STX	CTRL-B
03	003	EXT	CTRL-C
04	004	EOT	CTRL-D
05	005	ENQ	CTRL-E
06	006	ACK	CTRL-F
07	007	BEL	CTRL-G
08	008	BS	CTRL-H
09	009	HT	CTRL-I
0A	010	LF	CTRL-J
0B	011	VT	CTRL-K
0C	012	FF	CTRL-L
0D	013	CR	CTRL-M
0E	014	SO	CTRL-N
0F	015	SI	CTRL-O
10	016	DLE	CTRL-P
11	017	DC1	CTRL-Q
12	018	DC2	CTRL-R
13	019	DC3	CTRL-S
14	020	DC4	CTRL-T
15	021	NAK	CTRL-U
16	022	SYN	CTRL-V

**Table E-1**  
**(2 of 4)**  
**ASCII Characters**

Hexadecimal ASCII Value	Decimal ASCII Value	Control Character	Key
17	023	ETB	CTRL-W
18	024	CAN	CTRL-X
19	025	EM	CTRL-Y
1A	026	SUM	CTRL-Z
1B	027	ESC	CTRL-[
1C	028	FS	CTRL-/
1D	029	GS	CTRL-]
1E	030	RS	CTRL- Ax
1F	031	US	CTRL-_ spacebar
20	032		spacebar
21	033		!
22	034		"
23	035		#
24	036		\$
25	037		%
26	038		&
27	039		'
28	040		(
29	041		)
2A	042		*
2B	043		+
2C	044		,
2D	045		-
2E	046		.
2F	047		/
30	048		0
31	049		1
32	050		2
33	051		3
34	052		4
35	053		5
36	054		6
37	055		7
38	056		8
39	057		9
3A	058		:

**Table E-1**  
**(3 of 4)**  
**ASCII Characters**

<b>Hexadecimal ASCII Value</b>	<b>Decimal ASCII Value</b>	<b>Control Character</b>	<b>Key</b>
3B	059		;
3C	060		<
3D	061		=
3E	062		>
3F	063		?
40	064		@
41	065		A
42	066		B
43	067		C
44	068		D
45	069		E
46	070		F
47	071		G
48	072		H
49	073		I
4A	074		J
4B	075		K
4C	076		L
4D	077		M
4E	078		N
4F	079		)
50	080		P
51	081		Q
52	082		R
53	083		S
54	084		T
55	085		U
56	086		V
57	087		W
58	088		X
59	089		Y
5A	090		Z
5B	091		[
5C	092		\
5D	093		]
5E	094		^

**Table E-1**  
**(4 of 4)**  
**ASCII Characters**

<b>Hexadecimal ASCII Value</b>	<b>Decimal ASCII Value</b>	<b>Control Character</b>	<b>Key</b>
5F	095		-
60	096		(
61	097		a
62	098		b
63	099		c
64	100		d
65	101		e
66	102		f
67	103		g
68	104		h
69	105		i
6A	106		j
6B	107		k
6C	108		l
6D	109		m
6E	110		n
6F	111		o
70	112		p
71	113		q
72	114		r
73	115		s
74	116		t
75	117		u
76	118		v
77	119		w
78	120		x
79	121		y
7A	122		z
7B	123		{
7C	124		
7D	125		}
7E	126		-
7F	127		delete



---

# Default Configuration Options **F**

Overview ..... F-1

## Overview

Table F-1 in this appendix lists all default configuration options for the factory preset configurations. An N/A indicates that the value for this configuration option does not appear on the LCD when that factory default configuration is selected.

**Table F-1  
(1 of 7)**

**Factory Default Configuration Options**

<b>Configuration Option</b>	<b>Sync Leased Default Settings</b>	<b>Async Leased Default Settings</b>	<b>TMp Default Settings</b>	<b>Async Dial Default Settings</b>	<b>UNIX Dial Default Settings</b>	<b>Sync Dial Default Settings</b>
<b>DTE Interface</b>						
Async/Sync Mode	Sync	Async	Sync	Async	Async	Sync
Async DTE Rate	N/A	19,200 bps	N/A	19,200 bps	19,200 bps	N/A
Async # Data Bits	N/A	8	N/A	8	8	N/A
Async Parity Bit	N/A	None	N/A	None	None	N/A
Async # Stop Bits	N/A	1	N/A	1	1	N/A
DTR Action <sup>1</sup>	Ignore	Ignore	Ignore	Ignore	Ignore	Standard RS232
DSR Control	Standard RS232	Forced On	Standard RS232	Forced On	Forced On	Standard RS232
RTS Action	Standard RS232	Ignore	N/A (Trib) or Ignore (Control)	Ignore	Ignore	Standard RS232
RTS Antistream	N/A	N/A	10 sec (Trib) or N/A (Control)	N/A	N/A	N/A
CTS Control	Standard RS232	Forced On	Standard RS232	Forced On	Wink When Disc	Standard RS232
RTS/CTS Delay	0 msec	0 msec	0 msec	0 msec	0 msec	0 msec
LSD Control	Standard RS232	Standard RS232	Standard RS232	Standard RS232	Wink When Disc	Standard RS232
TX Clock Source	Internal	N/A	RXC Loop (Trib) or Internal (Control)	N/A	N/A	Internal
Backup TX Clock Source	N/A	N/A	N/A	N/A	N/A	N/A
XTXC Clamps TXC	N/A	N/A	N/A	N/A	N/A	N/A
CT111 Rate Control	Disable	Disable	Disable	Disable	Disable	Disable
DTE Rate = VF	N/A	Disable	N/A	Disable	Disable	N/A
Extend Main Channel	Disable	Disable	Disable	Disable	Disable	Disable
Upstream Port	Port1	Port1	Port1	Port1	Port1	Port1
<sup>1</sup> This configuration option is country dependent.						

**Table F-1  
(2 of 7)  
Factory Default Configuration Options**

<b>Configuration Option</b>	<b>Sync Leased Default Settings</b>	<b>Async Leased Default Settings</b>	<b>TMP Default Settings</b>	<b>Async Dial Default Settings</b>	<b>UNIX Dial Default Settings</b>	<b>Sync Dial Default Settings</b>
<b>DTE Dialer</b>						
DTE Dialer Type	Disable	AT	Disable	AT	AT	Disable
AT Escape Character	N/A	043 ASCII	N/A	043 ASCII	043 ASCII	N/A
Escape Guard Time	N/A	1 sec	N/A	1 sec	1 sec	N/A
Break Forces Escape	N/A	Disable	N/A	Disable	Disable	N/A
Command Character Echo	N/A	Enable	N/A	Enable	Enable	N/A
Carriage Return Character	N/A	013 ASCII	N/A	013 ASCII	013 ASCII	N/A
Backspace Character	N/A	008 ASCII	N/A	008 ASCII	008 ASCII	N/A
Linefeed Character	N/A	010 ASCII	N/A	010 ASCII	010 ASCII	N/A
Result Codes	N/A	Enable	N/A	Enable	Enable In Originate	N/A
Extended Result Codes	N/A	Enable	N/A	Enable	Enable	N/A
Result Codes Format	N/A	Words	N/A	Words	Words	N/A
AT Command Mode	N/A	Normal	N/A	Normal	Normal	N/A
V.25bis Coding	N/A	N/A	N/A	N/A	N/A	N/A
V.25bis Idle Fill	N/A	N/A	N/A	N/A	N/A	N/A
V.25bis New Line Character	N/A	N/A	N/A	N/A	N/A	N/A

**Table F-1**  
**(3 of 7)**  
**Factory Default Configuration Options**

Configuration Option	Sync Leased Default Settings	Async Leased Default Settings	TMP Default Settings	Async Dial Default Settings	UNIX Dial Default Settings	Sync Dial Default Settings
<b>Line Dialer</b>						
Auto-Answer Ring Count <sup>1</sup>	1	1	1	1	1	1
Dialer Type	Tone	Tone	Tone	Tone	Tone	Tone
Dial Tone Detect	Enable	Enable	Enable	Enable	Enable	Enable
Blind Dial Pause	N/A	N/A	N/A	N/A	N/A	N/A
Busy Tone Detect	Enable	Enable	Enable	Enable	Enable	Enable
“,” Pause Time	2 sec	2 sec	2 sec	2 sec	2 sec	2 sec
No Answer Timeout <sup>1</sup>	45 sec	45 sec	45 sec	45 sec	45 sec	45 sec
Fast Disconnect	Disable	Disable	Disable	Disable	Disable	Enable
Line Current Disconnect <sup>1,2</sup>	Enable (>8 msec)	Enable (>8 msec)	Enable (>8 msec)	Enable (>8 msec)	Enable (>8 msec)	Enable (>8 msec)
Long Space Disconnect	Enable	Enable	Enable	Enable	Enable	Disable
No Carrier Disconnect <sup>1</sup>	2 sec	2 sec	2 sec	2 sec	2 sec	2 sec
No Data Disconnect <sup>1</sup>	Disable	Disable	Disable	Disable	Disable	Disable
Auto Make Busy (3911 only)	Disable	Disable	Disable	Disable	Disable	Disable
Make Busy via DTR	Disable	Disable	Disable	Disable	Disable	Disable
<b>Dial Line</b>						
Dial Line Rate	19200 (V32t)	19200 (V32t)	19200 (V32t)	19200 (V32t)	19200 (V32t)	19200 (V32t)
V.32bis Automode	Enable	Enable	Enable	Enable	Enable	Enable
V.32bis Autorate	Enable	Enable	Enable	Enable	Enable	Enable
V.32bis Override	Disable	Disable	N/A	Disable	Disable	Disable
Dial Transmit Level <sup>1,3</sup>	Permissive (-9 dBm)	Permissive (-9 dBm)	Permissive (-9 dBm)	Permissive (-9 dBm)	Permissive (-9 dBm)	Permissive (-9 dBm)
V.22bis Guard Tone <sup>1</sup>	Disable	Disable	Disable	Disable	Disable	Disable
V.32bis Train	Long	Long	Long	Long	Long	Long

<sup>1</sup> This configuration option is country dependent.

<sup>2</sup> This configuration option does not appear on Models 3910-A1-401 and 3911-B1-001.

<sup>3</sup> Except in North America, this configuration option is not changed by loading factory default configuration options.

**Table F-1  
(4 of 7)  
Factory Default Configuration Options**

Configuration Option	Sync Leased Default Settings	Async Leased Default Settings	TMp Default Settings	Async Dial Default Settings	UNIX Dial Default Settings	Sync Dial Default Settings
<b>Leased Line</b>						
Leased Mode	4-wire LL Answer (Sync Leased Answ) or 4-wire LL Originate (Sync Leased Orig)	4-wire LL Answer (Async Leased Answ) or 4-wire LL Originate (Async Leased Orig)	4-wire LL Originate (TMp Tributary) or 4-wire LL Answer (TMp Control)	N/A	N/A	N/A
Leased Line Rate	19200 (V32t)	19200 (V32t)	19200 (TMp) (TMp Control) or 14400 (TMp) (TMp Tributary)	N/A	N/A	N/A
V.32bis Autorate	Enable	Enable	N/A	N/A	N/A	N/A
V.32bis Override	Disable	Disable	N/A	N/A	N/A	N/A
Leased Transmit Level <sup>1,3</sup>	0 dBm	0 dBm	0 dBm	N/A	N/A	N/A
Auto Dial Backup	Disable	Disable	Disable	N/A	N/A	N/A
Auto Dial Standby	Disable	Disable	Disable	N/A	N/A	N/A
Special Standby	Disable	Disable	Disable	N/A	N/A	N/A
Dial Standby Time	10 min	10 min	10 min	N/A	N/A	N/A
Carrier On Level <sup>1</sup>	-43 dBm	-43 dBm	-26 dBm (TMp Control) or -43 dBm (TMp Tributary)	N/A	N/A	N/A
V.27bis Train	N/A	N/A	N/A	N/A	N/A	N/A
V.29 Train on Data	N/A	N/A	N/A	N/A	N/A	N/A
V.29 Retrain	N/A	N/A	N/A	N/A	N/A	N/A
V.29 Link Configuration	N/A	N/A	N/A	N/A	N/A	N/A
TMp Train Time	N/A	N/A	50	N/A	N/A	N/A
TMp Tx Preemphasis	N/A	N/A	Enable	N/A	N/A	N/A
Lease Lookback	Disable	Disable	Disable	N/A	N/A	N/A
Dual Leased Line	Disable	Disable	Disable	N/A	N/A	N/A
Backup Line Check	Disable	Disable	Disable	N/A	N/A	N/A
<sup>1</sup> This configuration option is country dependent. <sup>3</sup> Except in North America, this configuration option is not changed by loading factory default configuration options.						

**Table F-1**  
**(5 of 7)**  
**Factory Default Configuration Options**

Configuration Option	Sync Leased Default Settings	Async Leased Default Settings	TMP Default Settings	Async Dial Default Settings	UNIX Dial Default Settings	Sync Dial Default Settings
<b>V.42/MNP/Buffer</b>						
Error Control Mode	N/A (Direct)	V.42/MNP or Buffer	N/A (Direct)	V.42/MNP or Buffer	V.42/MNP or Buffer	N/A (Direct)
V.42bis Data Compression	N/A	Enable	N/A	Enable	Enable	N/A
MNP5 Compression	N/A	Enable	N/A	Enable	Enable	N/A
EC Negotiate Buffer	N/A	Disable	N/A	Disable	Disable	N/A
EC Fallback Character	N/A	N/A	N/A	N/A	N/A	N/A
Flow Control of DTE	N/A	CTS_to_DTE	N/A	CTS_to_DTE	CTS_to_DTE	N/A
Flow Control of Modem	N/A	RTS_to_Modem	N/A	RTS_to_Modem	RTS_to_Modem	N/A
XON/XOFF Passthrough	N/A	N/A	N/A	N/A	N/A	N/A
Modem-to-Modem Flow Control	N/A	Disable	N/A	Disable	Disable	N/A
Break Buffer Control	N/A	Keep Data	N/A	Keep Data	Keep Data	N/A
Send Break Control	N/A	Data First	N/A	Data First	Data First	N/A
Buffer Disconnect Delay	N/A	10 seconds	N/A	10 seconds	10 seconds	N/A
Maximum Frame Size	N/A	256	N/A	256	256	N/A
Cellular Enhancement	N/A	Disable	N/A	Disable	Disable	N/A
Reduced Async Buffer Size	N/A	Disable	N/A	Disable	Disable	N/A
<b>Test</b>						
DTE RL (CT140)	Disable	Disable	Disable	Disable	Disable	Disable
DTE LL (CT141)	Disable	Disable	Disable	Disable	Disable	Disable
Test Timeout	Disable	Disable	Disable	Disable	Disable	Disable
Receive Remote Loopback	Enable	Enable	Disable	Enable	Enable	Enable
V.54 Address	Disable	Disable	Disable	Disable	Disable	Disable
V.54 Device Type	N/A	N/A	N/A	N/A	N/A	N/A

**Table F-1  
(6 of 7)  
Factory Default Configuration Options**

Configuration Option	Sync Leased Default Settings	Async Leased Default Settings	TMp Default Settings	Async Dial Default Settings	UNIX Dial Default Settings	Sync Dial Default Settings
<b>Misc</b>						
Straps When Disconnected	No Change	No Change	No Change	No Change	No Change	No Change
Speaker Control	On Until Carrier	On Until Carrier	On Until Carrier	On Until Carrier	On Until Carrier	On Until Carrier
Speaker Volume	Medium	Medium	Medium	Medium	Medium	Medium
Access from Remote <sup>2,4</sup>	Enable	Enable	Enable	Enable	Enable	Enable
Remote Access Password <sup>2,4</sup>	00000000	00000000	00000000	00000000	00000000	00000000
Directory Location No. 1 Callback	Disable	Disable	Disable	Disable	Disable	Disable
NMS Call Messages <sup>2,4</sup>	Call Connect & Progress	Call Connect & Progress	Call Connect & Progress	Call Connect & Progress	Call Connect & Progress	Call Connect & Progress
Network Position Identification	Tributary (3910) or Control (3911)	N/A	Tributary (TMp Trib) or Control (TMp Control)	N/A	N/A	N/A
Network Management Address <sup>2,4</sup>	256	256	256	256	256	256
Diagnostic Connection	Modem(DC)	Modem(DC)	Modem(DC), NMS(CC) for TMp Control, or Disable for TMp Trib	Modem(DC)	Modem(DC)	Modem(DC)
Link Delay(seconds)	0	0	0	0	0	0
<sup>2</sup> This configuration option does not appear on Models 3910-A1-401 and 3911-B1-001. <sup>4</sup> This configuration option is not changed by loading factory default configuration options.						

**Table F-1  
(7 of 7)  
Factory Default Configuration Options**

<b>Configuration Option</b>	<b>Sync Leased Default Settings</b>	<b>Async Leased Default Settings</b>	<b>TMp Default Settings</b>	<b>Async Dial Default Settings</b>	<b>UNIX Dial Default Settings</b>	<b>Sync Dial Default Settings</b>
<b>Security</b>						
Entry Wait Time	20 sec	20 sec	20 sec	20 sec	20 sec	20 sec
VF Prompt Type	2nd Dial Tone	2nd Dial Tone	2nd Dial Tone	2nd Dial Tone	2nd Dial Tone	2nd Dial Tone
DTE Password Tries	1	1	1	1	1	1
DTE Password Termination Character	013 ASCII	013 ASCII	013 ASCII	013 ASCII	013 ASCII	013 ASCII
DTE Password Backspace Character	008 ASCII	008 ASCII	008 ASCII	008 ASCII	008 ASCII	008 ASCII
Get User ID	Disable	Disable	Disable	Disable	Disable	Disable
NMS Reporting <sup>2,4</sup>	000	000	000	000	000	000
Answer Security Mode <sup>2,4</sup>	No Answer Security	No Answer Security	No Answer Security	No Answer Security	No Answer Security	No Answer Security
Originate Security Mode <sup>2,4</sup>	No Originate Security	No Originate Security	No Originate Security	No Originate Security	No Originate Security	No Originate Security
<sup>2</sup> This configuration option does not appear on Models 3910-A1-401 and 3911-B1-001. <sup>4</sup> This configuration option is not changed by loading factory default configuration options.						



---

# Sample Configuration **G**

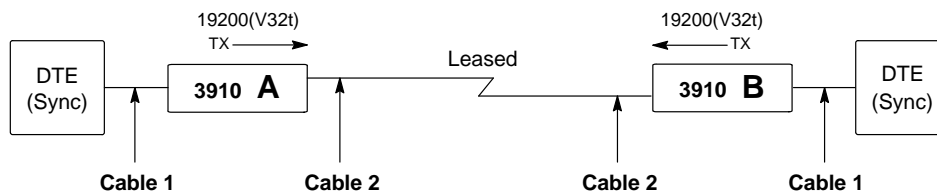
Overview .....	G-1
Point-to-Point .....	G-2
Configuration Options .....	G-2
Cables .....	G-2
Multipoint .....	G-3
Configuration Options .....	G-3
Cables .....	G-3
Point-to-Point with Automatic Dial Backup .....	G-4
Configuration Options .....	G-4
Cables .....	G-4
Point-to-Point with Network Management .....	G-5
Configuration Options .....	G-5
Cables .....	G-5
Carrier with Network Management .....	G-6
Configuration Options .....	G-6
Cables .....	G-6
Extended Multipoint .....	G-7
Configuration Options .....	G-8
Cables .....	G-8
Extended Diagnostics .....	G-9
Configuration Options .....	G-9
Cables .....	G-10
Adapter .....	G-10

## Overview

This appendix provides diagrams of sample configurations for the 391x Series modems. Following each diagram, the appropriate configuration options and cables are listed.

## Point-to-Point

Figure G-1 shows a sample configuration for point-to-point applications.



**Figure G-1. Sample Configuration — Point-to-Point**

### Configuration Options

**3910 A** Use Sync Leased (Answer) default configuration options.

**3910 B** Use Sync Leased (Originate) default configuration options.

### Cables

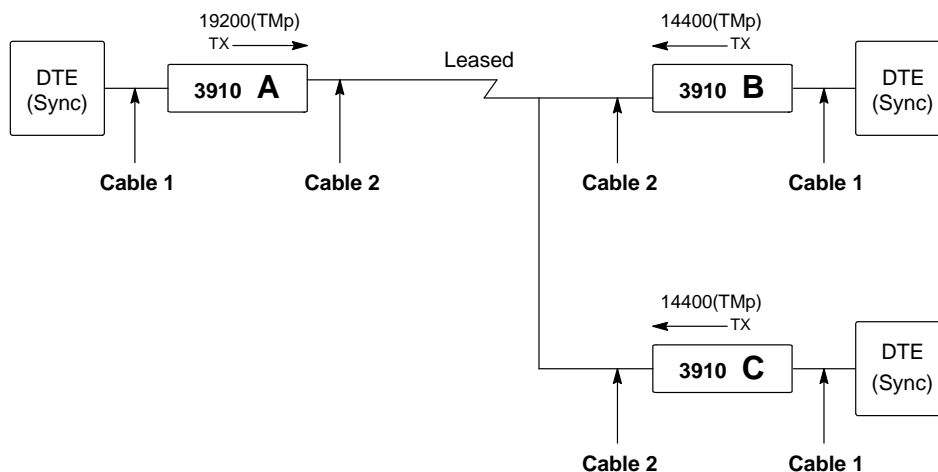
**Cable 1** Use a standard, customer-supplied, EIA-232-D/V.24 cable with a DB-25-P (plug) connector at one end to attach to the modem. Attach this to the connector labeled **DTE1**.

**Cable 2** Use part number 125-0053-1431 (an 8-position, 8-wire modular cord that is supplied with the modem). Attach this to the connector labeled **LEASED**.

## Multipoint

Figure G-2 shows a sample configuration for multipoint applications.

TMp control modems can accept mixed inbound rates from tributary modems. For example, one inbound link may be configured for 14.4 kbps while another link experiencing line impairments may be configured for 9.6 kbps. The following control/tributary rate combinations are allowed: control at 19.2 kbps, tributaries at 14.4 or 9.6 kbps; control at 14.4 kbps, tributaries at 14.4 or 9.6 kbps; control at 9.6 kbps, tributaries at 9.6 or 7.2 kbps; control at 7.2 kbps, tributaries at 7.2 or 4.8 kbps; control at 4.8 kbps, tributaries at 4.8 or 2.4 kbps; control at 2.4 kbps, tributaries at 2.4 kbps. Tributary rates will never exceed control rates. If tributary and control rates are equal, reducing the control rate will automatically reduce the tributary rate.



**Figure G-2. Sample Configuration — Multipoint**

### Configuration Options

- 3910 A** Use TMp (Control) default configuration options.
- 3910 B** Use TMp (Trib) default configuration options.
- 3910 C** Use TMp (Trib) default configuration options.

### Cables

- Cable 1** Use a standard, customer-supplied, EIA-232-D/V.24 cable with a DB-25-P (plug) connector at one end to attach to the modem. Attach this to the connector labeled **DTE1**.
- Cable 2** Use part number 125-0053-1431 (an 8-position, 8-wire modular cord that is supplied with the modem). Attach this to the connector labeled **LEASED**.

## Point-to-Point with Automatic Dial Backup

Figure G-3 shows a sample configuration for point-to-point applications with automatic dial backup.

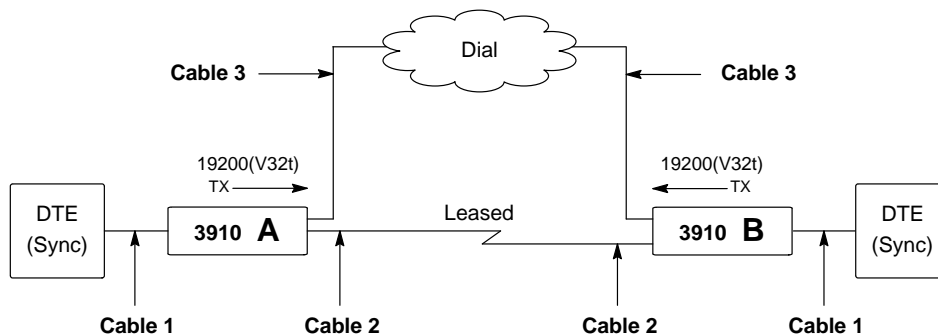


Figure G-3. Sample Configuration — Point-to-Point with Automatic Dial Backup

### Configuration Options

- 3910 A** Use Sync Leased (Answer) default configuration options with the following exception:
- |                       |                |
|-----------------------|----------------|
| <b>Auto Dial Back</b> | Set to Enable. |
|-----------------------|----------------|
- 3910 B** Use Sync Leased (Originate) default configuration options with the following exception:
- |                       |                |
|-----------------------|----------------|
| <b>Auto Dial Back</b> | Set to Enable. |
|-----------------------|----------------|

### Cables

- Cable 1** Use a standard, customer-supplied, EIA-232-D/V.24 cable with a DB-25-P (plug) connector at one end to attach to the modem. Attach this to the connector labeled **DTE1**.
- Cable 2** Use part number 125-0053-1431 (an 8-position, 8-wire modular cord that is supplied with the modem). Attach this to the connector labeled **LEASED**.
- Cable 3** Use part number 125-0067-0031 (a 6-position, 4-wire modular cord that is supplied with the modem). Attach this to the connector labeled **DIAL**.

## Point-to-Point with Network Management

Figure G-4 shows a sample configuration for point-to-point applications with network management.

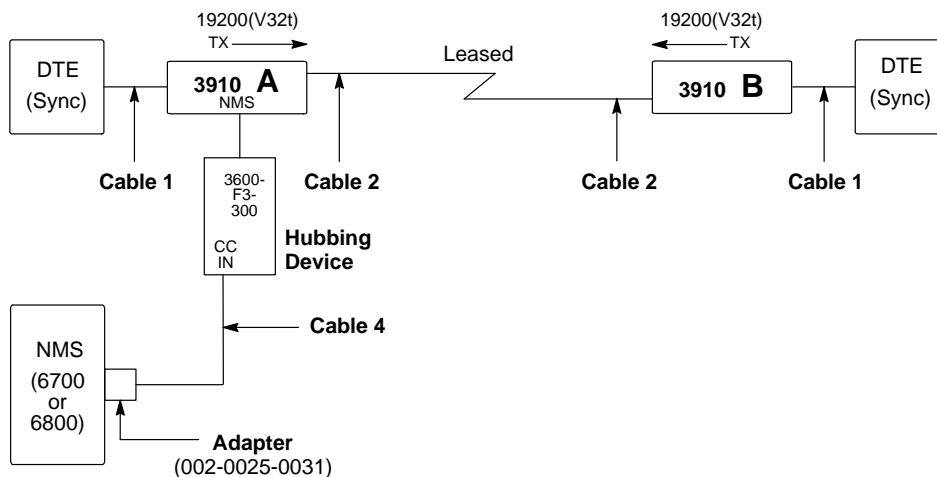


Figure G-4. Sample Configuration — Point-to-Point with Network Management

### Configuration Options

- 3910 A** Use Sync Leased (Answer) default configuration options.
- 3910 B** Use Sync Leased (Originate) default configuration options.

### Cables

- Cable 1** Use a standard, customer-supplied, EIA-232-D/V.24 cable with a DB-25-P (plug) connector at one end to attach to the modem. Attach this to the connector labeled **DTE1**.
- Cable 2** Use part number 125-0053-1431 (an 8-position, 8-wire modular cord that is supplied with the modem). Attach this to the connector labeled **LEASED**.
- Cable 4** Use part number 835-1224-1011 (10 feet), part number 125-0040-0031 (12 feet), part number 835-1224-2511 (25 feet), part number 835-1224-5011 (50 feet), or an equivalent pin-to-pin 6-position, 6-wire modular cord. The maximum cable length is 50 feet.

## Carrier with Network Management

Figure G-5 shows a sample configuration for COMSPHERE 3000 Series Carrier applications with network management.

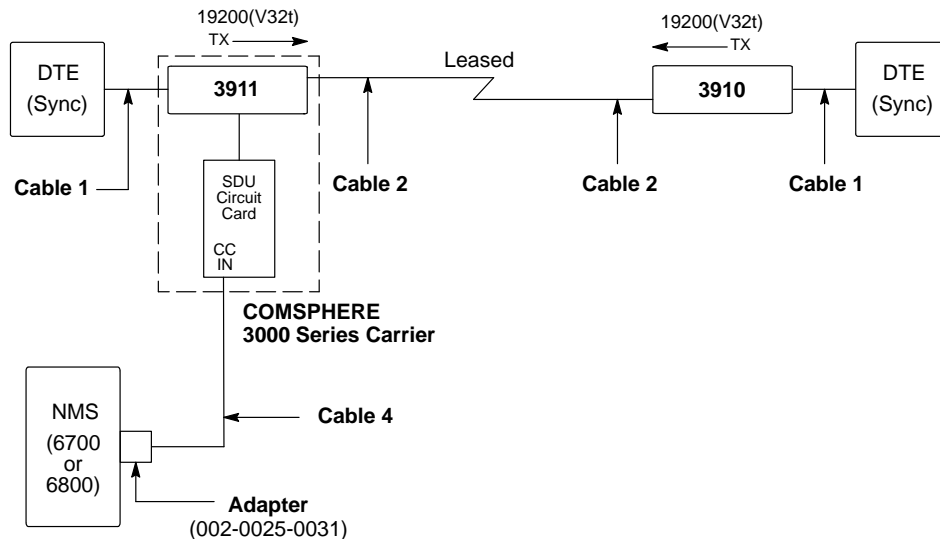


Figure G-5. Sample Configuration — Carrier with Network Management

### Configuration Options

- 3911** Use Sync Leased (Answer) default configuration options.
- 3910** Use Sync Leased (Originate) default configuration options.

### Cables

- Cable 1** Use a standard, customer-supplied, EIA-232-D/V.24 cable with a DB-25-P (plug) connector at one end to attach to the modem. Attach this to the connector labeled **DTE1**.
- Cable 2** Use part number 125-0053-1431 (an 8-position, 8-wire modular cord that is supplied with the modem). Attach this to the connector labeled **LEASED**.
- Cable 4** Use part number 835-1224-1011 (10 feet), part number 125-0040-0031 (12 feet), part number 835-1224-2511 (25 feet), part number 835-1224-5011 (50 feet), or an equivalent pin-to-pin 6-position, 6-wire modular cord. The maximum cable length is 50 feet.

# Extended Multipoint

Figure G-6 shows a sample configuration for extended multipoint applications.

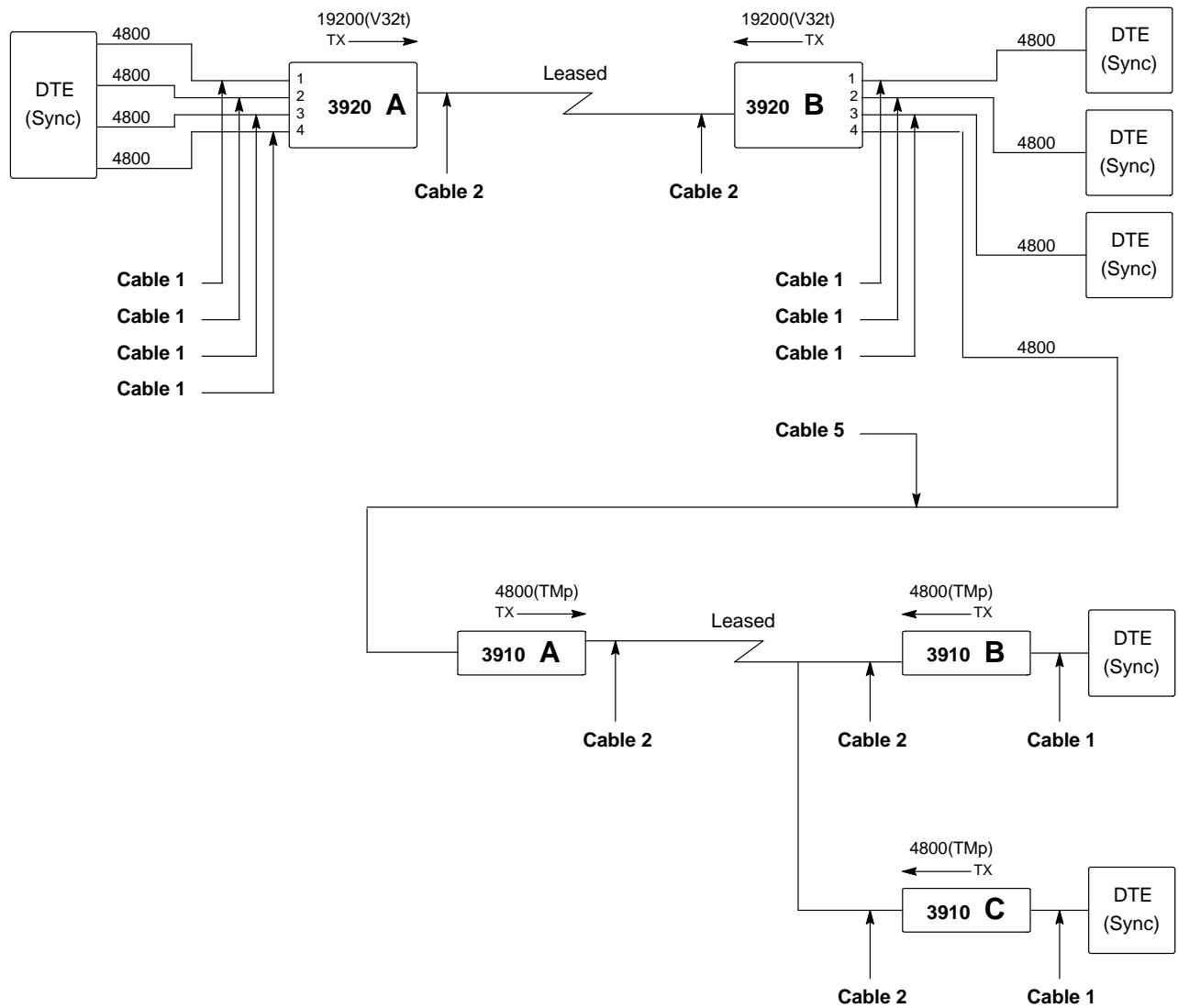


Figure G-6. Sample Configuration — Extended Multipoint

## Configuration Options

- 3920 A** Use Sync Leased (Answer) default configuration options with the following exception:
- Rate at 19.2K** Set ports 1, 2, 3, and 4 to 4800.
- 3920 B** Use Sync Leased (Originate) default configuration options with the following exceptions:
- TX Clock Source** Set to RXC\_Loop.
  - Rate at 19.2K** Set ports 1, 2, 3, and 4 to 4800.
  - Port TXC Source** Set port 4 to External.
- 3910 A** Use TMp (Control) default configuration options with the following exceptions:
- TX Clock Source** Set to External.
  - LeasedLine Rate** Set to 4800(TMp).
- 3910 B** Use TMp (Trib) default configuration options with the following exceptions:
- TX Clock Source** Set to RXC\_Loop.
  - LeasedLine Rate** Set to 4800(TMp).
- 3910 C** Use TMp (Trib) default configuration options with the following exceptions:
- TX Clock Source** Set to RXC\_Loop.
  - LeasedLine Rate** Set to 4800(TMp).

## Cables

- Cable 1** Use a standard, customer-supplied, EIA-232-D/V.24 cable with a DB-25-P (plug) connector at one end to attach to the modem. Attach this to the connector labeled **DTE1, 2, 3, or 4**.
- Cable 2** Use part number 125-0053-1431 (an 8-position, 8-wire modular cord that is supplied with the modem). Attach this to the connector labeled **LEASED**.
- Cable 5** Use part number 818-2759-0111 or an equivalent customer-supplied, EIA-232-D/V.24 crossover cable with DB-25-P (plug) connectors on both ends to attach to the modems. (See Appendix C for pin assignments.)



## Extended Diagnostics

Figure G-7 shows a sample configuration for extended diagnostics.

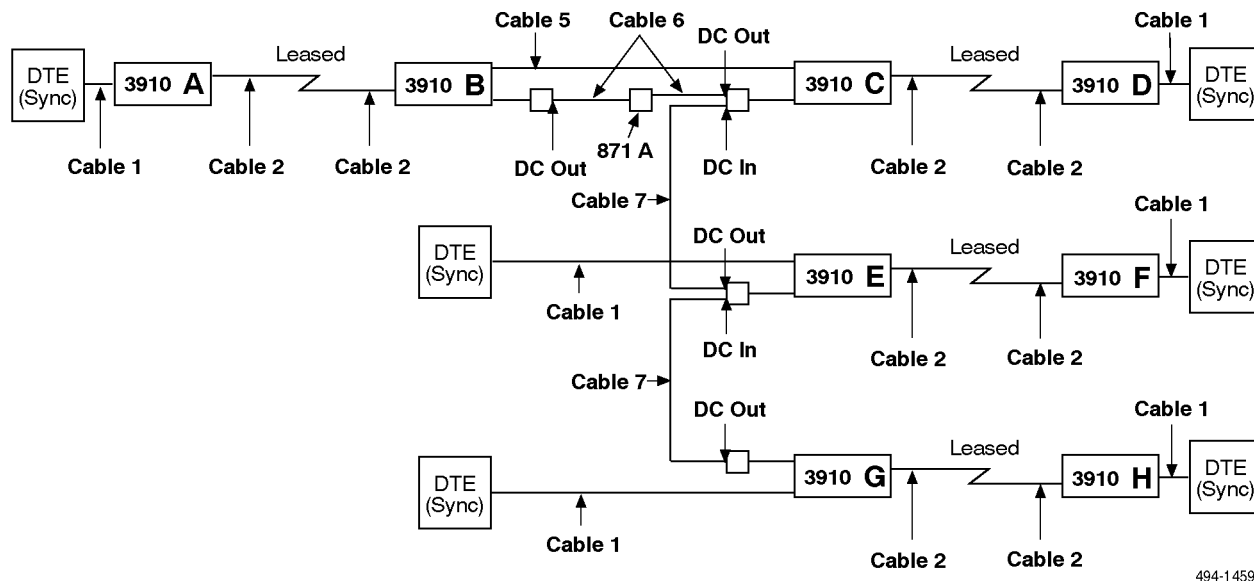


Figure G-7. Sample Configuration — Extended Diagnostics

### Configuration Options

- 3910 A** Use Sync Leased (Answer) default configuration options with the following exception:
- Network position** Set to Control.
- 3910 B** Use Sync Leased (Originate) default configuration options with the following exception:
- TX Clock Source** Set to External.
  - Diagnostic Connection** Set to Modem (DC).
- 3910 C** Use Sync Leased (Answer) default configuration options with the following exceptions:
- TX Clock Source** Set to External.
  - Extended Channel** Set to Enable.
  - Upstream Port #** Set to Port 1.
  - Diagnostic Connection** Set to Modem (DC).
  - Network Position** Set to Continue.

**3910 D,F,H** Use Sync Leased (Answer) default configuration options with the following exceptions:

**TX Clock Source** Set to RXC\_Loop.

**3910 E,G** Use Sync Leased (Answer) default configuration options with the following exceptions:

**Diagnostic Connection** Set to Modem (DC).

**Network Position** Set to Control.

## Cables

**Cable 1** Use a standard, customer-supplied, EIA-232-D/V.24 cable with a DB-25-P (plug) connector at one end to attach to the modem. Attach this to the connector labeled **DTE1, 2, 3, or 4**.

**Cable 2** Use part number 125-0053-1431 (an 8-position, 8-wire modular cord that is supplied with the modem). Attach this to the connector labeled **LEASED**.

**Cable 5** Use part number 818-2759-0111 or an equivalent customer-supplied, EIA-232-D/V.24 crossover cable with DB-25-P (plug) connectors on both ends to attach to the modems. (See Appendix C for pin assignments.)

**Cable 6** Use part number 125-0040-0031 (a 6-position, 6-wire modular cord). Attach this to the CCIN/DCOUT port of the 3600 Hubbing device.

**Cable 7** Use part number 125-0053-1431 (an 8-position, 8-wire modular cord). Attach this to the CCIN/DCOUT port of one 3600 Hubbing device and to the CCOUT/DCIN port of the second device.

## Adapter

**871A** Use part number 002-0026-0031 (Feature number 4400-F1-590).

---

# Equipment List **H**

<b>Equipment</b>	<b>Feature/ Part Number</b>
Model 3910	3910-A1-XXX
Model 3911	3911-B1-XXX
6-position, 4-wire modular cord, 7-foot length	125-0067-0031
8-position, 8-wire modular cord, 14-foot length	125-0053-1431
Universal Power Supply	327-0074-XXXX
3600 Hubbing Device	3600-F3-300
EIA-323-D/V.24 Crossover Cable	818-2759-0111
6 position, 6-wire modular cord	125-0040-0031
8 position, 8-wire modular cord	125-0053-1431
871A Adapter	002-0026-0031

---

# Glossary

<b>Active (Operating)</b>	A configuration area containing configuration options currently in use by the modem. Anytime a power cycle occurs or a reset is performed or a save is issued using the DCP, this area is updated with the contents of Active (Saved).
<b>Active (Saved)</b>	A nonvolatile configuration area containing the most recently saved configuration options.
<b>ADp</b>	Advanced Diagnostic protocol. An enhanced diagnostic communication protocol used with the 6800 Series NMS and with certain DCP diagnostic functions.
<b>analog loop</b>	See local analog loop.
<b>analog signal</b>	A signal, such as a voice, that varies continuously.
<b>Answer mode</b>	The modem is in a state where it is ready to receive an incoming call.
<b>ASCII</b>	This code (American Standard Code for Information Interchange) is a 7-bit code which establishes compatibility between data services. ASCII is the standard for data transmission over telephone lines. The ASCII code consists of 32 control characters (nondisplayed) and 96 displayed characters. Refer to Appendix E.
<b>asynchronous transmission</b>	A data transmission that is synchronized by a transmission start bit at the beginning of a character (five to eight bits) and one or more stop bits at the end.
<b>AT command set</b>	A group of commands, issued from an asynchronous DTE, that allow control of the modem while in Command mode. All commands must begin with the characters AT and end with a carriage return.
<b>AT prefix</b>	A prefix issued before every AT command (except A/ and +++) which identifies the DTE's data rate, parity, and character length.
<b>autobaud</b>	The modem automatically determines the asynchronous DTE data rate when using AT commands.
<b>automatic answer</b>	A capability to respond to a call received over a dial line.

<b>automatic dial backup</b>	When leased-line operation fails, this function forces the modem to dial the telephone number stored in directory location 1.
<b>automatic dial standby</b>	When operating in Dial Backup mode, this function forces the modem to periodically check the quality of the leased line. If the leased line is found to be at normal operating condition, the modem disconnects from the dial network and continues normal operation over the leased-line network.
<b>automatic rate control</b>	Modems adjust their signaling rate based on current line conditions.
<b>backbone network</b>	The primary route from a control modem to its first tributary when the communications network contains extended control modems.
<b>backplane</b>	A common bus at the rear of the COMSPHERE 3000 Series Carrier connecting each circuit card slot to the SDCP and/or SDU. It also distributes low-voltage ac power to each slot.
<b>baud</b>	A unit of signaling speed that is equal to the number of symbols per second. This is not necessarily the same as bits per second, although the terms are frequently interchanged.
<b>Bisync</b>	Binary Synchronous Communications. An IBM® communications protocol that has become an industry standard. It uses a defined set of control characters and control-character sequences for synchronized transmission of binary-coded data between stations in a data communications system.
<b>bit</b>	A contraction of binary digit. A bit, which is the smallest unit of information, represents the choice between a one or a zero (sometimes called mark or space).
<b>bps</b>	Bits per second. Indicates the speed at which bits are transmitted across a data connection.
<b>broadcast</b>	A method of transmission. The simultaneous transmission to two or more communicating devices.
<b>buffer</b>	A storage device used to compensate for differences in the data flow rate when transmitting data from one device to another.
<b>byte</b>	A sequence of successive bits (usually eight) handled as a unit in data transmission.
<b>carrier</b>	The rack mounting that contains 17 slots: 1 control slot for an SDU and 16 modem slots. See data carrier.
<b>carrier-mount</b>	A modem that is designed for installation in a COMSPHERE® 3000 Series Carrier and used at central-site operations.

---

<b>CCITT</b>	An advisory committee (Consultative Committee on International Telephone and Telegraph) established by the United Nations to recommend communications standards and policies.
<b>CCITT V.22</b>	A standard for modems operating full-duplex over dial networks at 1200 bps.
<b>CCITT V.22bis</b>	A standard for modems operating full-duplex over leased lines or dial networks at 2400 bps.
<b>CCITT V.27bis</b>	A standard for modems operating over leased lines at 2400 or 4800 bps.
<b>CCITT V.29</b>	A standard for modems operating over leased lines at 4800, 7200, or 9600 bps.
<b>CCITT V.32</b>	A standard for modems operating full-duplex with asynchronous or synchronous data over leased lines or dial networks at 4800 or 9600 bps.
<b>CCITT V.32bis</b>	A standard for modems operating full-duplex with asynchronous or synchronous data over leased lines or dial networks at 4800, 7200, 9600, 12000, or 14400 bps.
<b>CCITT V.42</b>	CCITT standard for error control protocol.
<b>CCITT V.42bis</b>	CCITT standard for data compression.
<b>CCITT V.54</b>	CCITT standard for local and remote diagnostic loopback tests.
<b>channel</b>	A path for electrical transmission between two or more points. Also called a circuit, line, link, path, or facility.
<b>character</b>	A letter, figure, number, punctuation, or other symbol.
<b>character echo</b>	A way to check the accuracy of data transmission by sending to the monitor (displaying) all the characters being transmitted.
<b>circuit pack lock</b>	A screw lock tab installed over a circuit card's latch release tab to prevent the unit from being removed without a tool. It is used on SDUs, modems, and filler panels.
<b>Command mode</b>	One of two modem operating modes. When in Command mode, the modem accepts commands instead of transmitting or receiving data.
<b>configuration area</b>	One of five areas within the Configure branch containing modem settings. Configuration areas include Active (Operating), Active (Saved), Customer 1, Customer 2, and Factory.
<b>configuration option</b>	Modem software that sets specific operating parameters for the modem. Sometimes referred to as straps.
<b>connector</b>	An outlet on equipment and cables that provides a connection.

<b>constant carrier mode</b>	The modem transmits a carrier signal constantly, regardless of RTS.
<b>Control Channel (CC)</b>	The diagnostic interface between an NMS and a network device.
<b>control modem</b>	A control modem polls downstream tributary modems across the analog channel.
<b>controlled carrier mode</b>	The modem's transmitter turns on and off in response to RTS. This mode is used by multipoint tributary modems.
<b>Customer 1</b>	A user-defined configuration area containing customized configuration options for a specific application.
<b>Customer 2</b>	A user-defined configuration area containing customized configuration options for a specific application.
<b>data carrier</b>	A continuous frequency signal that can be modulated by another signal that contains information to be transmitted.
<b>data compression</b>	The elimination of empty fields, redundancies, and gaps in order to reduce storage capacity needs and the amount of data to be transmitted. Anything that is eliminated is restored after the data is received.
<b>Data mode</b>	One of two modem operating modes. When in Data mode, the modem transmits and receives data instead of accepting commands.
<b>DB-25 connector</b>	A 25-pin connector that is used to connect a cable which enables communication between two devices.
<b>dBm</b>	A decibel referenced to one milliwatt. This unit measures relative signal power.
<b>DCE</b>	The equipment (Data Communications Equipment or Data Circuit Terminating Equipment) that provides the functions required to establish, maintain, and end a connection. This equipment also provides the signal conversion required for communication between the DTE and the telephone line.
<b>DCP</b>	Diagnostic Control Panel. The face of the modem that continuously provides status information about the modem's operation and allows an operator to manage its operation. This is a generic term used for both the standalone and carrier-mounted models. See SDCP.
<b>demodulation</b>	The process of recovering data from a modulated carrier wave.
<b>DevHS</b>	Device Health and Status. A detailed account of device alarms.
<b>Diagnostic Channel (DC)</b>	The diagnostic interface between two network devices, used to extend the NMS diagnostics to downstream devices.

---

<b>dial command modifiers</b>	A modifier used in the dial string that instructs the modem how to process a dialed telephone number.
<b>dial line</b>	A communications circuit that is established by a switched circuit connection in the dial network.
<b>dial network</b>	See PSTN.
<b>Dial Standby</b>	A function available when the modem is operating in Dial Backup mode, allowing the modem to switch back to lease-line operation while still maintaining the dial-line connection.
<b>dial string</b>	A series of characters that consists of numbers and modifiers used to dial a telephone number.
<b>digital signal</b>	A discrete signal. Compare with analog signal.
<b>directory location</b>	Nonvolatile memory that stores up to ten telephone numbers. Each directory location can have up to 40 characters entered.
<b>DOC</b>	Canadian Department of Communication.
<b>download</b>	A process that transfers modem firmware from a locally attached PC to a modem or allows the cloning of firmware from a local modem to a remote modem.
<b>downstream modem</b>	A device connected “farther” from the host computer.
<b>DTE</b>	The equipment (Data Terminal Equipment), such as a computer or terminal, that provides data in the form of digital signals.
<b>edit area</b>	A temporary work area used to view and change configuration options from the DCP. The edit area can be loaded from one of five configuration option areas, Active (Operating), Active (Saved), Customer 1, Customer 2, or Factory.
<b>EIA</b>	Electronic Industries Association. This organization provides standards for the data communications industry.
<b>EIA-232-D</b>	An Electronic Industries Association’s standard defining the 25-position interface between data terminal equipment and data communications equipment.
<b>EIA RS-366-A</b>	An Electronic Industries Association’s standard defining the 25-position interface between data terminal equipment and data communications automatic calling equipment.
<b>error control</b>	An algorithm used to correct data transmission errors.
<b>escape sequence</b>	Default setting is +++. This sequence lets you switch your modem from Data mode to Command mode.
<b>extended circuit</b>	See extended network.



<b>extended network</b>	The extension of a circuit where the tributary DCE is connected to a downstream (extended) control DCE.
<b>extended result codes</b>	An asynchronous message (in either numbers or words) that includes VF data rate and error control information the modem sends to the DTE after executing or trying to execute a command.
<b>fallback</b>	Retraining at a lower rate or speed.
<b>FCC</b>	Federal Communications Commission. Board of Commissioners that regulates all interstate and foreign electrical communication systems that originate from the United States.
<b>Forward Error Correction (FEC)</b>	A method of error control for data transmission where the receiving device can detect and correct a character or block of code containing a predetermined number of erroneous bits.
<b>Front-End Processor (FEP)</b>	A communications computer associated with a host computer that manages the routing of data through the network.
<b>full-duplex</b>	Simultaneous, two-way communications.
<b>function key</b>	Any one of three keys on the DCP that allows you to select or increment an LCD entry. Function keys are labeled F1, F2, and F3.
<b>half-duplex</b>	Two-way data communications allowed in only one direction at a time.
<b>handshaking</b>	The exchange of predetermined codes and signals (tones) to establish a connection between two modems.
<b>HDLC</b>	High-Level Data Link Control. A communications protocol defined by the International Standards Organization (ISO).
<b>host</b>	A computer attached to a network that shares its information and devices with the rest of the network.
<b>Hz</b>	A unit of frequency (Hertz) that equals one cycle per second.
<b>idle</b>	A state in which the modem's operating parameters can be modified or commands can be issued to the modem using either AT commands or the DCP.
<b>JM8</b>	A jack used for leased-line networks. Pins 1 and 2 are the transmit pair and Pins 7 and 8 are the receive pair.
<b>keypad</b>	A set of seven keys surrounding the DCP's LCD. These keys are used to select configuration options and to maneuver through the DCP menu.
<b>LCD</b>	Liquid Crystal Display. A thin sandwich of two sealed glass plates containing liquid crystal material. When voltage is applied, the amount of light able to pass through the glass plates is altered so that messages may be "written" on the display.

---

<b>leased line</b>	A private telephone line connection exclusively for the user. No dialing is necessary.
<b>LED</b>	Light Emitting Diode. A light or status indicator on the DCP that glows in response to the presence of a certain condition (e.g., an alarm).
<b>Link</b>	The physical connection between one location and another used for data transmission. See Channel.
<b>local analog loopback</b>	The modem's transmit VF signal is looped to its receiver.
<b>long space disconnect</b>	A disconnect can occur if the modem receives an extended space from a remote modem; for example, when a remote modem is commanded to disconnect, it transmits a continuous space to the local modem before disconnecting.
<b>loopback test</b>	Any test that verifies a device's integrity by connecting the device's output to the device's input, then checking the received signal for errors.
<b>menu tree</b>	The structure containing the menu hierarchy starting at a Top-Level menu and extending down to various modem functions.
<b>mixed inbound rates</b>	In a multipoint network, several different data rates from tributary modems' transmitters communicating with one control modem.
<b>MNP</b>	This protocol (Microcom Networking Protocol) detects and corrects data errors caused by telephone line noise and signal distortion. MNP5 includes data compression.
<b>modem</b>	(Modulator/DEModulator). A device that transforms signals from digital to analog form and vice versa.
<b>modulation</b>	The process of varying some characteristics (usually amplitude, frequency, and/or phase) of a carrier wave to form data transmissions.
<b>multiplexer (mux)</b>	A device that enables the simultaneous transmission of multiple independent data streams into a single high-speed data stream.
<b>multipoint line</b>	A circuit connecting one control modem with one or more tributary modems.
<b>network</b>	A communications circuit.
<b>network management address</b>	The customer-assigned diagnostic address of a modem.
<b>NIM</b>	Network Interface Module. The interface provided, up to two per carrier, for the public switched telephone network (PSTN).
<b>non-linear distortion</b>	VF line distortion which is usually associated with pulse-code modulation (PCM) compandor noise on the phone line.

<b>NMS</b>	Network Management System. A set of diagnostic and configuration management tools for a data communication network, consisting of software programs and dedicated computer hardware.
<b>off-hook</b>	A telephone or modem is being used.
<b>on-hook</b>	A telephone or modem is not being used.
<b>Originate mode</b>	The modem is in a state where it is ready to transmit a call. In a dial network, it is the modem that makes the call. In a leased-line network, it is one of two sides of the network that is selected to be the originating modem.
<b>parity</b>	A way of checking data accuracy by counting the number of bits that have a value of one.
<b>PBX</b>	Telephone switching equipment (Private Branch Exchange) dedicated to one customer. A PBX connects private telephones to each other and to the public dial network.
<b>permissive interface</b>	A dial modem operating mode characterized by a fixed output power level of -9 dBm.
<b>phase jitter</b>	A rapid or repeated shifting of the relative phase of a signal resulting in unwanted distortion.
<b>physical address</b>	The diagnostic address of a control modem derived from its location in the carrier: its carrier and slot number.
<b>point-to-point line</b>	A line or circuit connecting two stations.
<b>poll list</b>	A list containing the network management addresses of downstream modems.
<b>power-up self-test</b>	A test that checks most hardware components when the modem is powered-on.
<b>product code</b>	A three-digit code indicating the modem's highest VF data rate.
<b>protocol</b>	The rules for timing, format, error control, and flow control during data transmission.
<b>PSTN</b>	Public Switched Telephone Network. A network shared among many users who can use telephones to establish connections between two points. Also known as dial network.
<b>Quick Configuration display</b>	An informative display screen available from the modem's Top-Level display. It provides such information as network position (control or tributary), network management address, DTE mode (Asynchronous or Synchronous), Line mode (Leased Answer, Leased Originate, or Dial), and the modulation scheme used by the modem.

---

<b>register</b>	A part of the modem's memory that contains values that determine the modem's operating characteristics.
<b>Remote</b>	A branch of the Top-Level menu that permits access to the DCP of another modem.
<b>remote loopback</b>	A test that sends a signal to the remote modem to test the local modem, the remote modem, and the circuit between them.
<b>result code</b>	An asynchronous message (in either numbers or words) that the modem sends to the DTE after executing or trying to execute a command.
<b>Return to Dial</b>	A function available when in Dial Backup mode that allows the modem to switch to dial-line operation when currently on leased lines.
<b>RJ11</b>	A type of 6-position jack normally used with permissive dial networks and telephone sets.
<b>RJ21</b>	A type of 50-position jack normally used with permissive dial networks providing the appropriate conductors for up to eight telephone lines.
<b>SDCP</b>	Shared Diagnostic Control Panel. An optional user interface that attaches to the front of a COMSPHERE 3000 Series Carrier. Its functionality is very similar to that of the DCP. Installed in one COMSPHERE 3000 Series Carrier, it controls and monitors modems in all the carriers in the cabinet. A single SDCP can control up to 8 carriers, with a total of 128 modems.
<b>SDU</b>	Shared Diagnostic Unit. A circuit card that plugs into a dedicated slot in the COMSPHERE 3000 Series Carrier to provide the SDCP and network management interfaces to the modems in the carrier. It translates the network management protocol to the devices in the carrier and routes incoming messages to the appropriate slots.
<b>secondary channel</b>	A data transmission channel with a lower signaling rate than the primary channel. It is mostly used for modem diagnostics.
<b>Select key</b>	An SDCP key that allows the selection of a specific card slot in the COMSPHERE 3000 Series Carrier.
<b>serial transmission</b>	A way of transmitting data in which bits are sent sequentially one at a time.
<b>S-Registers</b>	Registers that contain information affecting the modem parameters. All S-Registers must be preceded by the AT prefix.
<b>SubHS</b>	Sub-Network Health and Status. A display of alarm occurrences in downstream modems.
<b>synchronous transmission</b>	Data transmission that is synchronized by timing signals. Characters are sent at a fixed rate. This type of transmission is more efficient than asynchronous transmission.

<b>Time Division Multiplexer (TDM)</b>	A device that enables the simultaneous transmission of multiple independent data streams into a single high-speed data stream by simultaneously sampling the independent data streams and combining these samples to form the high-speed stream.
<b>TMp</b>	Trellis Multipoint. Paradyne's proprietary high speed, fast poll multipoint modulation scheme.
<b>Top-Level menu</b>	The very top of the menu tree that displays modem status and all Top-Level menu branches.
<b>training</b>	A process where two modems try to establish a connection over the VF line.
<b>trellis-coded modulation</b>	A modulation scheme developed by Paradyne which uses Forward Error Correction for multipoint and high-speed point-to-point applications.
<b>tributary modem</b>	Tributary modems in a network receive data from the control modem, as well as from the network management system in the network.
<b>UL</b>	Underwriter's Laboratories, Inc.
<b>UNIX Dial</b>	A factory preset configuration area containing the configuration options most often used in a UNIX® dial network.
<b>USOC</b>	Universal Service Ordering Codes.
<b>upstream modem</b>	A device connected "closer" to the host computer.
<b>V.32 terbo</b>	A modulation that adds the 19,200 bps and 16,800 bps data rates to the V.32bis data rates. It is a Paradyne proprietary modulation, not a CCITT standard.
<b>VF</b>	Voice Frequency. The part of the audio frequency range used to transmit voice sound (usually 300 Hz to 3400 Hz). This band is used by the modem for its modulated signal.
<b>XOFF</b>	A character that tells the DTE or modem to stop transmitting data.
<b>XON</b>	A character that tells the DTE or modem to start or resume transmitting data.

---

# Index

## A

- Abort (test), 3-46–3-47
- ac power requirements, 1-9
- Active (Operating) configurations, 4-1
- Active (Saved) configurations, 4-1
- address, network management, 3-26, 4-50
- analog loopback test, 3-48–3-49
- answer access security, 6-2–6-4
- answering a call
  - auto-answer, 3-63, 4-25
  - manual answer, 3-57, 3-64, 4-25
- approvals, 1-8
- ASCII characters table, E-1–E-4
- asynchronous character format, 4-10, 4-11
- asynchronous operation, 2-6, 4-1, 4-10
- AT commands
  - command list, 5-4–5-14
  - configuration option, 4-20
  - operating modes, 5-1
  - result codes, 5-3–5-4
  - using commands, 2-7–2-8, 4-2, 4-3, 5-1–5-2
- automatic rate control, 4-35

## B

- backup
  - dial, 2-4, 3-35, 3-54, 3-57–3-59, B-2
  - leased, 1-2, 2-4, 3-54
  - status, 3-21
- Bell
  - 103J, 4-30
  - 212A, 4-30
- Bisync, 4-20, D-1
- busy control, 3-34

**C**

- cables, 2-4, 2-5, H-1
- Call Setup branch, 3-8, 3-54-3-62
- Canadian government requirements, 1-7
- Clone Remote, 3-36-3-42
- compatibility, 1-8
- COMSPHERE 3000 Series Carrier
  - Model 3911 installation and removal, 2-9-2-12
  - network interface module (NIM), 2-2, 3-35
  - service line, 3-35
- configuration options
  - defaults, 2-6-2-8, 4-1, F-2-F-7
  - quick display, 3-14
  - tables
    - Dial Line, 4-30-4-32
    - DTE Dialer, 4-19-4-24
    - DTE Interface, 4-9-4-19
    - Leased Line, 4-33-4-38
    - Line Dialer, 4-25-4-29
    - Misc, 4-48-4-51
    - Security, 6-13-6-16
    - Test, 4-46-4-47
    - V.42/MNP/Buffer, 4-38-4-46
- Configure branch, 3-8, 3-25, 4-1, 4-4-4-8
- Control branch, 3-8, 3-30-3-45
- Customer 1 configurations, 4-1
- Customer 2 configurations, 4-1
- Customer Support, 1-6

**D**

- data compression, 4-40
- data rates. *See* rates
- DATAKIT, 4-16, 4-20
- default configuration options, 2-6-2-8, 4-1, F-2-F-7
- diagnostic control panel (DCP)
  - configurations. *See* configuration options
  - description, 1-3-1-5, 3-2-3-3
  - menu tree, 3-8, A-1-A-3
  - messages, 3-9-3-14, 3-23-3-24
  - operation, 2-6-2-7, 3-6-3-8, 4-5-4-8, 6-7
  - status indicators (LEDs), 3-4-3-6
- diagnostic tests. *See* Test branch
- dial
  - access security. *See* Security
  - answering a call
    - auto-answer, 3-63, 4-25
    - manual answer, 3-57, 3-64, 4-25
  - backup, 2-4, 3-35, 3-54, 3-57-3-59, B-2
  - command modifiers, 3-61, 5-5, 5-6
  - DCP controlled, 3-54-3-62
  - manual dial. *See* Talk/Data
  - network connection, 2-4, B-4-B-5
  - stored telephone number, 3-59-3-62, 5-12

Dial Line configuration options group, 4-30–4-32  
digital loopback, 3-49–3-51  
dimensions, 1-9  
directory, telephone number, 3-59–3-62  
disconnecting a call, 3-56–3-57  
Download Software, 3-35–3-42  
DTE  
    connection, 2-4, B-3  
    status, 3-4–3-6, 3-21  
DTE Dialer configuration options group, 4-19–4-24  
DTE Interface configuration options group, 4-9–4-19  
dual leased-line operation. *See* backup, leased

## E

EIA LEDs, 3-33  
EIA-232-D  
    cable connection, 2-4, B-3  
    pin assignments, C-2  
    status, 3-4–3-6, 3-21  
end-to-end pattern test, 3-52  
environment, 1-9  
equipment  
    customer supplied, 2-2  
    list, 2-1–2-2, H-1  
    return, 1-6  
error control, 4-39  
escape character ( + + + ), 4-21, 5-2, 5-15

## F

faceplate, 1-4, 3-3  
factory default configurations, 2-6–2-8, 4-1, F-2–F-7  
features, 1-1–1-2  
firmware part number (FPt #), 3-20  
firmware revision level (FRev), 3-20  
firmware upgrades/download, 3-35–3-42  
flow control, 4-42, 4-43  
front panel. *See* diagnostic control panel  
function keys, 3-6, 3-8, 4-8

## G

government requirements  
    Canada, 1-7  
    United States, 1-5–1-6



**H**

- handshaking sequence, 3-63, 3-64
- hang up, 3-56–3-57
- hardware part number (HPt #), 3-20
- HDLC, 4-20, D-1
- Health and Status definitions, 3-23–3-24

**I**

- Identity, 3-20
- indicators
  - definitions, 3-7
  - status (LEDs), 3-4–3-6
- installation
  - Model 3910, 2-2–2-12
  - Model 3911, 2-9–2-11

**K**

- keypad, 3-7–3-8

**L**

- LCD (liquid crystal display)
  - description, 3-2, 3-6–3-7
  - menu structure, 3-8
  - messages, 3-9–3-14, 3-23–3-24
- leased backup operation. *See* backup, leased
- Leased Line configuration options group, 4-33–4-38
- leased-line connection, 2-4
- leased-line operation, 4-33–4-38, B-2
- LEDs, status indicators, 3-4–3-6
- line connection
  - dial, 2-4
  - leased, 2-4
- Line Dialer configuration options group, 4-25–4-29
- Load Number (LN), 1-7
- loopback
  - local analog, 3-48–3-49
  - local digital, 3-50–3-51
  - remote digital, 3-49–3-50

## M

- Make Busy, 3-34
- manual dial. *See* Talk/Data
- menu
  - structure, 3-8
    - quick configuration display, 3-14
  - tree, A-1–A-3
- messages
  - LCD, 3-9–3-14, 3-23–3-24
  - result codes, 5-3–5-4
- Misc configuration options group, 4-48–4-51
- mixed inbound rates, 1-2, 4-34, G-3
- model number (Mod #), 3-20
- modifiers, dial string, 3-61, 5-5, 5-6
- modulation schemes
  - dial line, 1-8, 4-30, 5-17
  - leased line, 1-8, 4-34, 5-18
- multipoint operation, 1-2

## N

- network interface module (NIM), 2-2, 3-35
- network management address, 3-26, 4-50
- network management system connection, 2-5

## O

- operating modes
  - AT commands, 5-1
  - Talk/Data, 3-8, 3-62–3-64
- operational messages, 3-9–3-14
- Options, Status branch, 3-23–3-24
- options, strap. *See* configuration options
- originate access security, 6-2, 6-16–6-17

## P

- part numbers, 3-20, H-1
- passwords
  - administrative, 6-5–6-6
  - remote access, 3-65, 3-67, 3-68, 4-5–4-8, 4-49
  - security, 6-2–6-4, 6-16–6-17
- pattern test, 3-51–3-53
- phone. *See* telephone, external
- phone numbers. *See* telephone numbers
- pin assignments, C-2
- PList (Poll List) branch, 3-8, 3-25–3-30
- power consumption, 1-9
- power supply connection, 2-5
- power-up self-test, 2-5
- public switched telephone network (PSTN). *See* dial

## R

- rates
  - automatic control, 4-35
  - dial line, 1-10, 4-30, 5-17
  - leased line, 1-10, 4-34, 5-18
- rear connector plate, 1-4
- rear panel connectors, 1-4–1-5, 2-3, C-2
- Record, Status branch, 3-24–3-25
- Remote
  - access password, 3-65, 3-67, 3-68, 4-5–4-8, 4-49
  - branch, 3-8, 3-65–3-68
- remote digital loopback test, 3-49–3-50
- requirements
  - ac power, 1-9
  - government, 1-5–1-7
- reset control, 3-31–3-32
- result codes
  - enable/disable, 4-22, 5-7
  - extended, 4-23, 5-8
  - list, 5-3–5-4
  - numeric or word, 4-23, 5-7
- Return Material Authorization, 1-6
- ringer equivalence number (REN), 1-5
- RMA number, 1-6

## S

- S-Register list, 5-14–5-28
- Security
  - access messages, 3-13
  - branch, 3-8, 6-4–6-13
  - configuration options, 6-13–6-16
  - database tables, 6-2, 6-3, 6-18–6-19
  - passwords, 6-2–6-4, 6-16–6-17
- Select key, 2-10, 2-11, 3-7, 3-8
- self-test, 3-47–3-48
- self-test, 2-5
- serial number (Ser #), 3-20
- service line, 3-35
- shared diagnostic control panel (SDCP), 1-5, 3-3
- soft straps. *See* configuration options
- software download, 3-35–3-42
- speaker, 1-3, 3-31
- specifications, technical, 1-8–1-10
- Status branch, 3-8, 3-15–3-25
- status indicators
  - definitions, 3-7
  - LEDs, 3-4–3-6
- straps. *See* configuration options
- SubHS (Sub-Network Health and Status) branch, 3-8, 3-53–3-54
- synchronous operation, 2-6, 4-1, 4-10

**T**

- Talk/Data
  - branch, 3-8, 3-62-3-64
  - telephone, external, 3-62, C-4
- technical specifications, 1-8-1-10
- telephone, external, 3-62, C-4
- telephone numbers
  - display, 3-56
  - storage, 3-60
- Test branch, 3-8, 3-46-3-53
  - Abort, 3-46-3-47
  - Local Analog Loopback, 3-48-3-49
  - Local Digital Loopback, 3-50-3-51
  - Pattern, 3-51-3-53
  - Remote Digital Loopback, 3-49-3-50
  - Self, 3-47-3-48
- Test configuration options group, 4-46-4-47
- TMP default configurations. *See* default configuration options
- top-level menu messages, 3-9-3-14
- Trellis Multipoint (TMp), 3-9, 3-10, 3-14, 3-15, 3-19, 3-20, 3-38, 3-66, 3-67
- Troubleshooting, B-1-B-5

**U**

- United States government requirements, 1-5-1-6
- UNIX dial, 2-6, 4-1, 4-10

**V**

- V.25bis dialing commands and response, D-1-D-8
- V.42bis data compression, 4-40
- V.42 error control, 4-39
- V.42/MNP/Buffer configuration options group, 4-38-4-46
- VF
  - connection, 2-4, B-4-B-5
  - interface requirements, 1-9
  - pin assignments, C-3
  - status, 3-19-3-20
- VF Thresholds Update, 3-42-3-45

**W**

- weight, 1-9