



Gas cooker

Owners handbook
and
Installation Instructions

Introduction

This gas cooker has been designed and manufactured to all the necessary British Standards. This cooker carries the C.E. mark.

It is important that you understand how to use and care for the cooker properly before you use it for the first time.

We have written this booklet with your safety in mind. Read the booklet thoroughly before you use the cooker. Keep the booklet in a safe place so that anyone who uses the cooker can read it. Pass the booklet on with the cooker if you give or sell it to someone else.

For your safety

The cooker is designed to cook food and you must not use it for any other purpose.

Keep children, babies and toddlers away from the cooker at all times.

The installation instructions tell you how and where it can be fitted. If the cooker is already installed you must make sure that all instructions have been followed. If you are in any doubt ask a registered person. More details on installation on page 27.

We have included several drawings to show the right and wrong way of doing things.

The right way will have a smiling face by it.



A sad face shows something is wrong.



Important: Make sure you remove the sales stickers before you use this cooker.

Contents	Page
Lighting the cooker	4
The grill	7
The hotplate	9
The ovens	12
Oven cooking chart - main oven	14
- second oven	17
Slow cooking	20
Care and cleaning	22
Installing the cooker	27
General information	29
What is wrong and why?	31
Servicing	33
Installation instructions	34
Technical Data	35
Safety requirements/ventilation	36
Location of appliance/installation	37
Testing	39

Lighting the cooker

The system works by means of a battery. Details on how to replace the battery are given on page 29.

Hotplate

To light:

- 1 Push in the control knob and turn to the large flame symbol (highest setting), and press the ignition button immediately. When the burner has lit release the button.

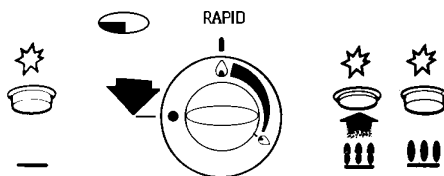

Warning: If the ignition button is not pressed immediately a build up of gas may cause the flame to spread.

Grill/second oven

The grill and the second oven are operated by the same control so you cannot use them both at the same time.

Grill

To light:

- 1 Push in the control knob and turn it to the right to the large flame symbol (highest setting), and press the ignition button immediately. When the burner has lit release the button.

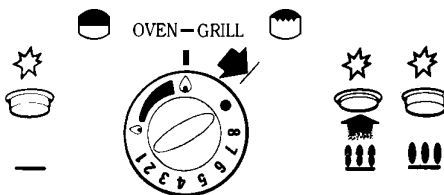

- 2 Leave the grill door open when you are using the grill.

Warning: If the ignition button is not pressed immediately a build up of gas may cause the flame to spread from the grill cavity.

Second oven

To light:

- 1 Open the oven door.
- 2 Push in the control knob and turn it to the left to gas mark 1, and press the ignition button immediately. When the burner has lit release the button. There will only be small flames at first.

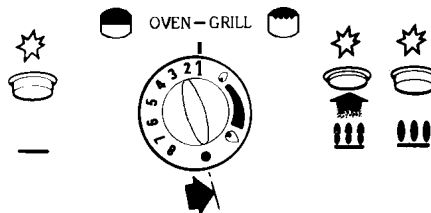

- 3 Now turn the control knob to the gas mark you want.
- 4 Wait until the burner is showing large flames.
- 5 Close the oven door.

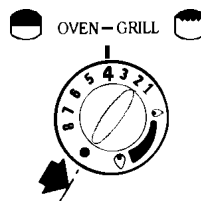

Important: Remember to remove the grill pan handle before you use the second oven.

Main oven

To light:

- 1 Open the oven door.
- 2 Push in the control knob and turn it to gas mark 9, and press the ignition button immediately. When the burner has lit release the button. There will only be small flames at first.

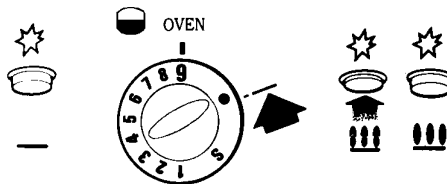

- 3 Now turn the control knob to the gas mark you want.
- 4 Wait until the burner is showing large flames.
- 5 Close the oven door.

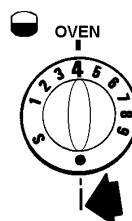

To turn off any burner

- 1 Push in the control knob and turn it to the off position. This is shown by a large dot.

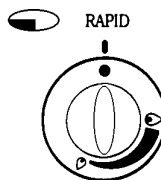
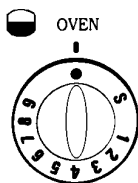

For your safety

When you are lighting any burner check that it has lit before you leave the cooker.

When you are turning off a burner, do not leave the cooker until the flame has gone out.

The grill

The grill is a high-speed grill. The instructions below tell you how to vary the heat setting and how to change the height of the trivet to suit the food you are cooking. You should remember to turn the food regularly.

You should not use the grill to keep food warm as it will continue to cook the food.

For your safety

You must keep the grill door open when the grill burner is lit.

Accessible parts may be hot when the grill is used. Young children should be kept away.

Heat control

The grill control has two heat settings.

The control knob turns to the right from 'OFF' to 'HIGH' and then to 'LOW'. Use the high setting for fast cooking such as toast. Use the low setting to cook thicker food such as chicken after you have browned it on the high setting.

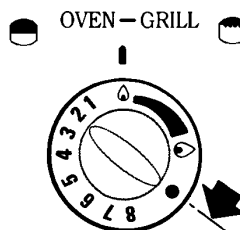

Cooking positions

You can put the grill shelf in either of the two positions.

Most food should be cooked on the grid in the grill pan. You can turn the grid over to suit different thicknesses of food.

You can place some dishes straight on to the grill shelf. This is useful when you are browning the top of food such as cauliflower cheese.

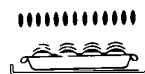
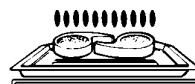

General

The shelf in the grill/second oven is different from the shelves in the main oven. It is important that you do not swap them over. Only use the shelf with the solid metal plate underneath it in the grill/second oven.

The grill pan handle can be removed. To put the handle on to the pan you should put the chrome bracket over the cut out in the pan and then slide the handle on to the left as far as the bump on the pan.

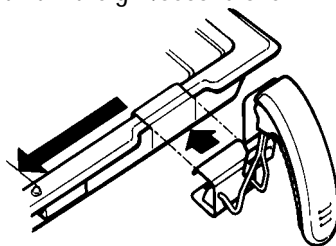

When you are not using the grill you should remove the handle and store the pan on the shelf in the grill. Turn the grill burner off before you store the pan. Remember that the pan will get hot when you are using the main oven.

You can use the grill compartment to warm plates when you are using the main oven.

Preheating

You don't usually need to preheat the grill. You may wish to preheat it for a couple of minutes when you are cooking steak or browning food.

Putting food on the grid

Place food such as toast, tea-cakes and muffins towards the centre of the grid.

Place food which needs a gentle heat, such as tomatoes and mushrooms towards the edge of the grid.

Arrange meat, meat products and fish to suit their thickness and how you like them cooked.

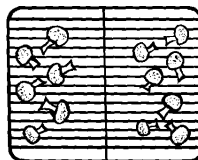
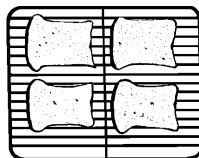

The hotplate

Heat control

The hotplate control knobs turn to the left from 'OFF' to 'HIGH' and then to 'LOW'. You can adjust the heat by turning the control between the highest and lowest settings. These are shown as a large and a small flame symbol.

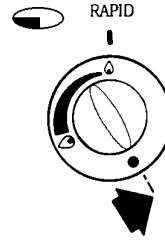

Burner sizes

The hotplate has three burner sizes to suit different types of cooking:

Largest burner (Rapid) - use a large pan for food such as chips.

Medium burners (Normal) - use for everyday cooking.

Small burner (Simmer) - use for simmering food such as soups and stews.

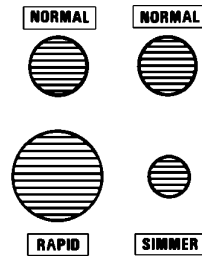



The largest pan which you should use on any burner is 230mm (9"). The base of the smallest pan should not measure less than 100mm (4").







For your safety







- 1 Take care to avoid burns and scalds when you are reaching across the hotplate.

- 2  Use pans with flat bases. They are more stable than pans which are warped. 

- 3  Do not use pans with very heavy handles which cause the pan to tip. 

- 4  Put pans on the centre of the burners. 

- 5  Position pan handles so they cannot be accidentally knocked. 

- 6  Take extra care when you are deep fat frying. Do not cover the pan with a lid. 

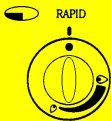

Do not leave a pan unattended. If the pan catches fire, leave it where it is and turn off all controls.





Place a damp cloth or a fitting lid over the pan to smother the flames.

Never put water on the fire.



Leave the pan to cool for 30 minutes.

- 7  If you are using a Wok we recommend it has a flat base as it will stand stable on the pan supports. If you use a round based Wok with a collar support, the collar must be of the open wire work type. A closed collar will affect the performance of the burner. Before you use the Wok make sure that the collar is stable on the pan supports. Always follow the instructions that come with the Wok.  



Helpful hints



- 1  Keep flames under the base of pans. If the flames lick round the sides of the pans you are wasting gas.



- 2  Only heat the amount of liquid you need. Do not overfill pans.



- 3  Cover pans with a lid whenever possible. The food will heat up more quickly and there will be less steam in the kitchen.



- 4  Try cooking more than one vegetable in the same pan, for example potatoes and carrots.

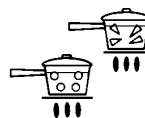

- 5  Cut vegetables into smaller pieces. This way they will cook more quickly.



- 6 A pressure cooker will save time and energy.

The ovens

Before you use the oven you should wipe it out with a damp cloth to remove any dust.

Heat zones

Main Oven - There are zones of heat within the oven. The temperature in the middle is the gas mark you have chosen. The top of the oven is slightly hotter and the lower shelf slightly cooler. The base of the oven is quite a lot cooler. You can make use of these heat zones when you are cooking foods requiring different temperatures all at the same time.

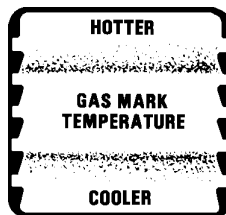

If you are cooking more than one tray of similar items, for example cakes or biscuits, swap the trays around during cooking. Or you could remove the top tray when the food is cooked and move the lower tray to the higher shelf to finish cooking.

Second Oven - You should turn food round during the cooking time.

Preheating

You do not need to preheat the main or second oven for casseroles and so on.

Preheat the oven for baking or when you are cooking sensitive food such as Yorkshire puddings, soufflés and yeast mixtures.

When you are cooking or reheating frozen or chilled food read the instructions on the packaging. When you are using the second oven to cook or reheat convenience food you should preheat the oven to gas mark 8.

When you need to preheat the oven, we recommend you do so for 20 minutes.

Oven shelves

You can slot the oven shelves into any of five positions in the main oven and any of two positions in the second oven. Positions are counted from the top downwards.

The shelf in the grill/second oven is different from the shelves in the main oven. Only use the shelf with the solid metal plate underneath it in the grill/second oven. The plate may glow red when you are using the oven. This will not affect the cooking performance.

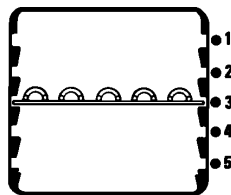

Most second oven cooking should be carried out using the shelf provided in shelf position 2. However, when cooking a small joint or a deep cake you can use the shelf on the base of the second oven to allow enough air to circulate around the food.

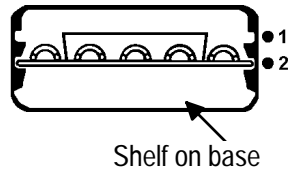



Baking trays and dishes



For your safety

Never place cooking dishes, trays and so on over the oven burners. This will damage the cooker as well as the ovenware and possibly the floor covering underneath the cooker.







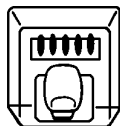
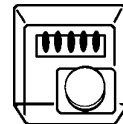

Leave a gap of 13mm (½") between all dishes and the sides of the oven so the heat can circulate properly.

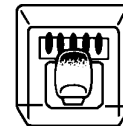

Do not push dishes too far back as food will burn if it overhangs the burner flames.



For the best results from your main oven we recommend that you use a baking tray which is 310mm (12") square. If you use a tray or tin which is larger than this, you may need to turn it around during cooking.

The size of tray which should be used in the second oven should measure no more than 310mm x 230mm (12" x 9"). Position the longest side parallel with the door.

Place single dishes on the centre of the shelf. You may need to turn large items around during cooking. Turn all food round in the second oven.

Condensation

Condensation may form on the cooker. This is quite normal and nothing to worry about.

The condensation forms when heat and moisture are present, for example during cooking. Whenever possible try to make sure that food which contains a lot of moisture for example casseroles are covered. If you do notice any condensation, wipe it up straight away.

Food	Gas mark	Shelf position	Approximate cooking time
Poultry:			
Chicken	5	4	20 mins. per ½kg (1 lb) and 20 mins.
Turkey below 4.5kg (10lbs)	4	4	25 mins. per ½kg (1 lb) and 25 mins.
over 4.5kg (10lbs)	4	4 or 5	15 mins. per ½kg (1 lb) and 15 mins.
Duck and duckling	5	4	25 mins. per ½kg (1 lb).
Stuffed poultry	Cook as above but calculate weight including stuffing.		
Thoroughly thaw frozen joints before cooking them.			
The times given above are for open roasting. If you cover the food with foil or a lid allow an extra 5 minutes cooking time for each ½kg (1 lb).			
Yorkshire pudding	7	2	25 - 35 mins.
- large	7	2	15 - 25 mins.
- individual			
Cakes:			
Christmas cake (8")	2	4	4-5 hours
Rich fruit, 180mm (7")	2	4	2¼-2½ hours
205mm (8")	2	4	2½-2¾ hours
Madeira, 180mm (7")	4	4	1 hour
Small cakes	5	2 & 4	15 - 25 mins.
Scones	7	2 & 4	10 - 20 mins.
Victoria sandwich			
180mm (7")	4	2 & 4	20 - 30 mins.
205mm (8")	4	2 & 4	20 - 35 mins.

Food	Gas mark	Shelf position	Approximate cooking time
Pastries:			
Plate tart (shortcrust)	6	2	25 - 35 mins.
Fruit pie (shortcrust)	6	2	25 - 35 mins.
Mince pies (flan pastry)	5	2 & 4	15 - 25 mins.
Puddings:			
Milk puddings	2	3	2 hrs. approx.
Baked sponge pudding	4	4	45 - 60 mins.
Baked custard	3	4	50 - 60 mins.
Yeast mixtures:			
Bread 0.45kg (1lb loaves)	8 *	3	30 - 40 mins.
0.90kg (2lb loaves)	8 *	3	30 - 40 mins.
Rolls and buns	8 *	2	10 - 20 mins.

* When baking bread cook at Gas Mark 8 for 10 minutes before reducing to Gas Mark 6 for the remainder of the cook time.
Note: You must soak dried beans then boil them in an open pan for 15 minutes before you add them to any dish.

Oven cooking chart - Second oven

These instructions are for cooking in the oven after it has been pre-heated for 20 minutes.

The recommended shelf positions give the best results.

Put the dishes centrally on the shelf and turn food round during the cooking time.

You can change the gas marks and cooking times to suit your own tastes.

It is important to check that food is piping hot before serving.

If you are using both ovens at the same time you may need to adjust the cooking times.

Food	Gas mark	Shelf position	Approximate cooking time
Roasting meat:	5	Shelf on base	Rare: 20 mins. per ½kg (1 lb) and 30 mins. Medium: 25 mins. per ½kg (1 lb) and 25 mins. Well Done: 30 mins. per ½kg (1 lb) and 30 mins.
		Shelf on base	Medium: 25 mins. per ½kg (1 lb) and 25 mins. Well Done: 30 mins. per ½kg (1 lb) and 30 mins.
		Shelf on base	Medium: 30 mins. per ½kg (1 lb) and 30 mins. Well Done: 35 mins. per ½kg (1 lb) and 35 mins.
Lamb	5	Shelf on base	Medium: 25 mins. per ½kg (1 lb) and 25 mins. Well Done: 30 mins. per ½kg (1 lb) and 30 mins.
Pork and Veal	5	Shelf on base	Medium: 30 mins. per ½kg (1 lb) and 30 mins. Well Done: 35 mins. per ½kg (1 lb) and 35 mins.

Thoroughly thaw frozen joints before cooking them.

Food	Gas mark	Shelf position	Approximate cooking time
Poultry:			
Chicken	5	Shelf on	20 mins. per ½kg (1 lb) and 20 mins.
Duck and duckling	5	base	25 mins. per ½kg (1 lb)
Stuffed poultry	Cook as above but calculate weight including stuffing.		
Thoroughly thaw frozen joints before cooking them.			
The times given above are for open roasting. If you cover with foil or a lid allow an extra 5 minutes cooking time for each ½kg (1lb)			
Yorkshire pudding - individual	7	2	20 - 30 mins.
Cakes:			
Christmas cake (7")	2	Shelf	4 - 4½ hours
Rich fruit, 180mm (7")	2	on	2¼ - 2¾ hours
Madeira, 180mm (7")	4	base	1 hour
Small cakes	5	2	15 - 25 mins.
Scones	7	2	8 - 12 mins.
Victoria sandwich 180mm (7")	4	2	20 - 30 mins.
Pastries:			
Plate tart (shortcrust)	6	2	25 - 35 mins. To help pastry brown on the underside
Fruit pie (shortcrust)	6	2	25 - 35 mins. cook on a metal plate, or if plates are
Mince pies (flan pastry)	5	2	15 - 25 mins. flat and have no rim underneath, place on baking tray.

Food	Gas mark	Shelf position	Approximate cooking time
Puddings:			
Milk pudding	2	2	2 hrs. approx.
Baked sponge pudding	3	2	45 - 60 mins.
Baked custard	3	2	50 - 60 mins.

Note: You must soak dried beans then boil them in an open pan for 15 minutes before you add them to any dish.

Soups, casseroles and stews

- Do not cook casseroles over 3 kg (6lb).
- Bring to the boil on the hotplate then cook on slow cook.
- Cook in the middle of the oven or above.

Vegetables

- Cut into small pieces.
- Dried beans must be pre-soaked then boiled in an open pan for 15 minutes before adding to any dish.
- Place vegetables under meat in casseroles.
- Cook for 30 minutes at gas mark 6, then reduce to the slow cook setting.

Milk puddings

- Cover the cereal with boiling water and leave it to stand for 30 minutes.
- Drain and make the pudding in the usual way.
- Cook for 30 minutes at gas mark 6, then reduce to the slow cook setting.

General points for slow cooking

Frozen foods

Thaw thoroughly before cooking.

Thickening

Toss meat in flour for casseroles. Blend cornflour with water and add it at the end of cooking.

Flavouring

Flavours are held in the food because there is little evaporation. Adjust flavouring at the end of the cooking time.

Liquid

Use slightly less liquid as there is little evaporation during cooking.

Milk and milk products, for example cream

Add these towards the end of cooking to prevent them from curdling.

Reheating

Cool left over food quickly and then put it in the fridge.

Do not reheat food using the slow cook setting. Reheat food in the usual way or in a microwave.

Only reheat food once.

Care and cleaning

For your safety

For hygiene and safety reasons you must keep this gas cooker clean. A build up of fat or other foodstuff could cause a fire.

Try to mop up spills and splashes as soon as they happen.

But be careful as parts of the appliance will be hot.

Do not use any polishes, caustic cleaners, abrasives, washing soda or soap powder except those recommended in this booklet.

Please note: If we recommend you use hot soapy water we mean hot water with washing up liquid in it and not any other cleaning product.

If you own a dishwasher please read the operating instructions for the machine before you wash any part of your cooker.



Clean your cooker regularly using a cloth that has been wrung out in hot soapy water. Rinse and polish it dry using a soft cloth.

When you remove parts of your cooker for cleaning do not plunge them into water whilst they are very hot as this may damage the finish of the parts.

The hotplate

Clean the hotplate top using a mild abrasive such as 'Jif'. Take care not to damage the spark electrodes. If the spark electrodes are damaged the burners will not light.

You can remove the pan supports, burner caps and burner crowns to clean them. Again take care not to damage the spark electrodes.

If any food spills do occur during cooking you can place the pan on another burner to finish cooking. Then you can remove the dirty parts and clean them before the spill 'burns on'.

You can wash the removable parts in very hot soapy water. You may use mild abrasives. Make sure that the electrode and the hole and slots in the crown are not blocked with food or cleaning materials.

Clean the burner crowns by soaking them in very hot soapy water. You can remove any stubborn stains by scouring with a soap filled pad such as 'Brillo'. If you look after the burner crowns in this way they will stay reasonably clean. However the surface will dull with time.



Aluminium based saucepans can leave shiny metal marks on the pan supports. Clean the pan supports regularly to remove the marks using a mild abrasive like 'Jif' with a soft scourer. For more stubborn marks you can use a soap filled pad such as 'Brillo'. After cleaning the cooker parts, dry them thoroughly before you put them back.

When replacing hotplate burner parts

1. Crown to body (Do not try to force the crown on to the body). Make sure that the hole in the crown is centrally over the electrode. Check that the two longer location pegs sit in the slots in the body. When the crown is in the position let it fall freely on to the body. Check that the crown can be moved slightly from side to side.
2. Cap to crown. Place cap centrally on the top of crown (enamel side up). Move sideways and front to back to check the cap is properly fitted.
3. Check for ignition

If a burner will not light then you need to check the crown and cap positions.

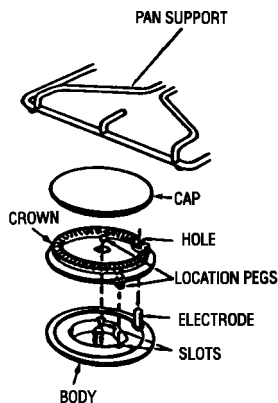

The grill and second oven

Clean the grill and oven frequently using hot soapy water.

After use you can soak the pan for a few minutes and then clean it using mild abrasives or a soap filled pad such as 'Brillo'.

Clean the shelf using hot soapy water. Mild abrasives can be used if necessary. The heat in the oven will change the colour of the solid plate on the shelf. You must not remove the solid plate from the shelf. You can soak the shelf for a few minutes in hot soapy water to make cleaning easier.

The main oven

The top, sides and back of your oven are coated in a special material which helps to keep itself clean.

Follow these simple rules to maintain the appearance of the special finish.



- 1  Do not overfill dishes or they will boil over.

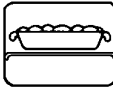

- 2  Do not put dishes too high in the oven. If you do they may stick to the oven roof.

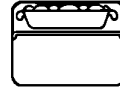

- 3  Cover your roasting tins with foil. This will prevent fat splashing.



- 4  Use a roasting tin which is just large enough for the meat and potatoes. This will help to reduce fat splashing.



- 5  Dry any vegetables that you are going to roast. If they are wet there will be more fat splashing.



- 6 Follow the oven cleaning cycle regularly.

Oven cleaning cycle

Please note: The oven cleaning cycle can only be used in the main oven.

You need to follow the cycle to keep the inside of the oven in good condition. The type of cooking you do will affect how often you need to follow the cycle.

If you do a lot of roasting and very little other baking you should follow the cleaning cycle once a week. If you do very little roasting you will only need to follow the cleaning cycle every 2-3 weeks.

To carry out a cleaning cycle:

1. Remove the oven shelves.
2. Set the oven to mark 5 for at least 30 minutes.
3. Turn the temperature up to mark 7 for 2 hours or until the oven is presentably clean. Some staining will remain.

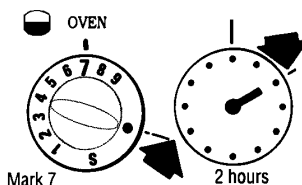
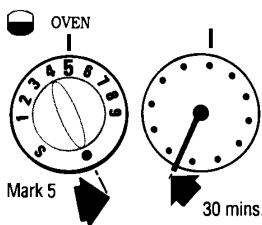

Do not use any cleaning agents or scrapers on the inside of the oven. Do not wash the special finish.



General

Clean the base of the oven, the oven shelves and the oven doors while they are still slightly warm. This way you can easily remove any splashes and spills. Wipe the base with a cloth that has been wrung out in hot soapy water. You may use mild abrasives.

Cleaning between the outer and inner door glass

You can remove the glass from the main oven door if you need to.

To remove the outer glass

- 1 Open the oven door so you can get at the two cross head screws on the top of the door.
- 2 Loosen these screws using a pozidrive screwdriver.
- 3 You should hold the door glass securely in place with one hand, whilst removing the screws completely, with the other hand. If you do not do this, the door glass could fall forward.
- 4 Using both hands, gently tilt the top of the door glass towards you. Lift it slightly to disengage the locators at the bottom of the door.

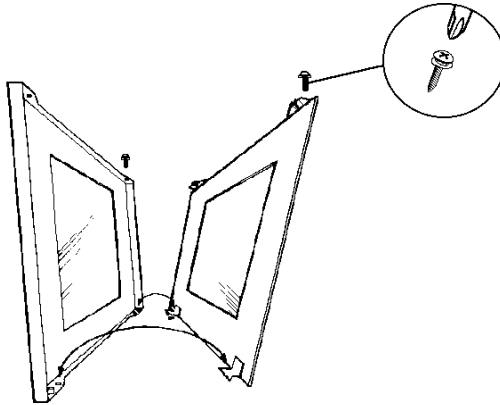

- 5 Clean the outer and inner glass using hot soapy water and mild abrasives such as 'Jif'. DO NOT try to clean the aluminium foil which is inside the door. The foil is there to keep the door cool, if it is damaged it will not work.
- 6 Replace the glass by holding it in both hands and gently placing the locators into the holes of the brackets at the bottom of the door and make sure the screw location holes line up.
- 7 Hold the glass in place with one hand and replace the cross head screws into the location holes, with the other hand.
- 8 Tighten the screws using a pozidrive screwdriver. Close the door.

Installing the cooker

For your safety

This cooker must be installed and serviced by a competent person as stated in the Gas Safety (Installation & Use) regulations current editions.

It is important that the cooker is suitable for your gas supply. Your installer should check the data badge.

Ensure that a stability bracket is fitted.

Location

For your safety

The use of a gas cooking appliance results in the production of heat and moisture in the room in which it is installed. Ensure that the kitchen is well ventilated: keep natural ventilation holes open or install a mechanical ventilation device (mechanical extractor hood).

Prolonged intensive use of the appliance may call for additional ventilation, for example opening of a window, or more effective ventilation, for example increasing the level of mechanical ventilation where present.

For further details see page 36.

Positioning

The diagram shows how close to the cooker cupboards, shelves, curtains and so on can be fitted. Refer to the diagram and carefully read the instructions to make sure your cooker is fitted safely. If you are in doubt your installer will give you advice.

- Do not fit any materials which may catch fire for example wood or curtains behind the cooker.
- Base units which are higher than the hotplate must be 100mm away.
- If a cooker hood is fitted refer to the cooker hood installation instructions.
- We recommend that cabinets fitted next to or above the cooker meet British Standards. Your installer will give you advice if you are not sure.

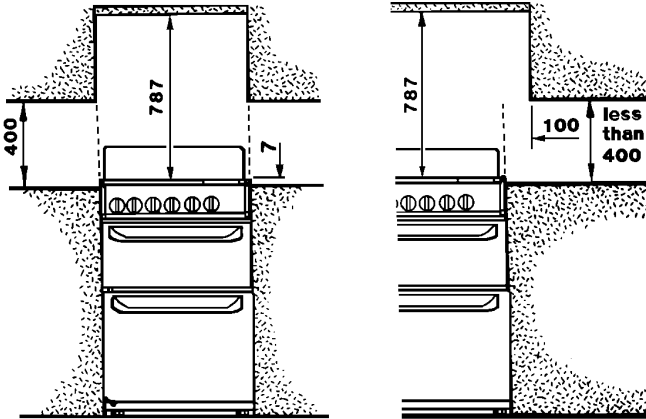

All dimensions in mm

Cooker dimensions

Height to hotplate:	902mm - 920mm (adjusted by four screw feet)
Width:	498mm
Depth:	603mm (to front door panel)

General information

For your safety

Do not block any of the cooker vents.

Never line any part of the cooker with aluminium foil.

Don't let items which can catch fire or electric mains leads such as kettle flexes trail over any part of the cooker.

Moving your cooker

You may damage some soft or badly fitted floor coverings when you move the cooker. The floor covering under the cooker should be securely fixed so it does not ruck up when you move the cooker across it. Alternatively you could remove the floor covering.

To move the cooker open the grill door. Raise the cooker off its front feet by lifting from inside the grill. Pull the cooker forward. When you replace the cooker push it back to the stop and make sure there is the same gap at each rear corner.

The battery

The battery for the ignition will usually last for many months. If the ignition system doesn't work you probably need to replace the battery.

The battery is at the base of the cooker on the left-hand side of the front. You can see it through the slots between the oven and the plinth.

When you need to replace the battery, open the main oven door, turn the battery holder clockwise about its pivot point. The battery you need is AA size.

When you fit the new battery, make sure the positive end (marked with a + sign) is next to the (+) sign on the battery holder. Return the battery holder to its original position by turning it anti-clockwise.

You can light the burners with a match until you have time to change the battery.

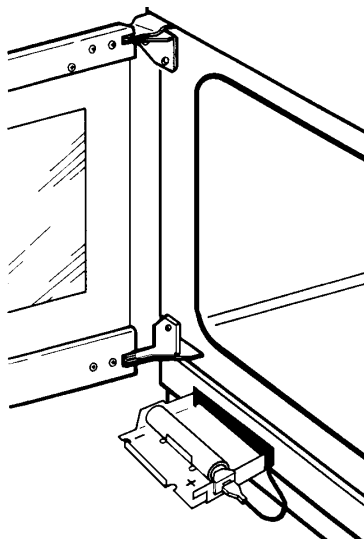

For your safety

Do not try to disconnect the cooker from the gas supply if the supply pipe does not have a bayonet connection, as described in the installation instruction. If this is the case contact the person who installed the cooker.

Reversing the oven door

You can turn the oven door around so that it opens on the other side. Your supplier can arrange this.

What is wrong and why?

We strongly recommend that you carry out the following checks on your cooker before calling a Service Engineer.

Problem

The oven, grill or hotplate will not light.

Check

- If you cannot hear any sparking or if the sparking is slow when you press the ignition button it may not be strong enough to light the cooker. You will probably need to replace the battery. For instructions on how to do this see page 29. You can light the burners with a match until you have time to change the battery.
- Check that there is not a problem with your gas supply. You can do this by making sure that other gas appliances such as your central heating or gas fire are working.
- If only the hotplate burners will not light, make sure that the burner parts have been replaced correctly. See instructions on page 23.

Problem

Food is cooking too quickly or too slowly.

Check

- Check that you are using the recommended gas marks and shelf positions. See page 14. Be prepared to adjust the gas mark up or down to achieve the results you want.

Problem

The oven is not cooking evenly.

Check

- Check that the cooker is installed properly and is level.
- Check that you are using the recommended temperatures and shelf positions.
- Check that you are using the correct size baking trays.
- If you are cooking a large item be prepared to turn it round during cooking.
- All food in the second oven should be turned round.

Problem

Having difficulty cleaning any part of the cooker.

Check

- Check that you are following the instructions for care and cleaning (see page 22).

Servicing

For your safety

Maintenance work must only be done by a competent person. Do not try to repair the cooker yourself. This could be dangerous. It is dangerous to alter or modify the product in any way.

We recommend that your cooker has an annual gas safety check carried out by our approved service organisation.

Before you call a service engineer check through the 'What is wrong and why?' information on pages 31 and 32. If you still feel there is a problem you should contact Parkinson Cowan on 0870 5929929 Your call will be routed to the Service Centre covering your postcode area.

Parkinson Cowan will arrange for the cooker to be serviced.

Customers in Ireland should telephone (10) 4565666.

You can get service and spares from Parkinson Cowan. If you don't use manufacturers original spares the normal product approval of the cooker may not be valid.

When you report a problem try to describe the nature of the fault. Always give your cookers full name and serial number which you can see when the door is opened.

Make a note of this information in this space:

Name:

Serial Number:

The Gas Consumers' Council

The Gas Consumers' Council (GCC) is an independent organisation which protects the interests of gas users. If you need advice, you will find the telephone number in your local telephone directory under Gas

INSTALLATION INSTRUCTIONS

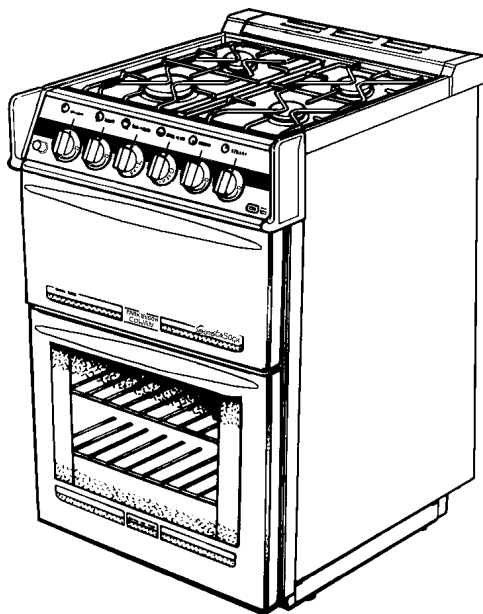

Serial number at the front.
Data badge on top rear of
panel.

For your safety

Natural Gas and L.P. Gas versions of this appliance are available. Check that this model is suitable for the type of supply available. In the interest of safety this appliance must be installed and/or serviced by a competent person, as stated in the Gas Safety (Installation and Use) Regulations Current Editions.

TECHNICAL DATA

DIMENSIONS

	<i>Height</i>	<i>Width</i>	<i>Depth</i>
Height to hotplate	907mm (nominal)	500mm (nominal)	603 mm (to front of door panel)
Space for fixing at hotplate level		2mm minimum clearance	
Minimum space above hotplate	787mm (If a cooker hood is fitted refer to thecookerhood installation instructions).		
Space for fixing above hotplate level	See important note "Location of Appliance", page 37.		
Weight of appliance	48.4kg.		
Minimum distance from rear wall	5mm (spacer given by pressed spacer on vent panel).		

CONNECTIONS

Gas	Rear left hand side of appliance at hotplate level. Rc½ (½" B.S.P. female).
Electric	None

IGNITION

Spark generator	APCO 7BG 6893
Battery	1.5 Volt AA size

GRILL

	<i>Natural Gas</i>	<i>L.P. Gas</i>
Heat Input	3.3kW (11263 Btu/h)	3.0kW (215g/h)
Injector Marking	138	88

HOTPLATE

	<i>Natural Gas</i>			
	<i>R.H.F.</i>	<i>R.H.R.</i>	<i>L.H.R.</i>	<i>L.H.F</i>
Heat Input	1.0kW (3412 Btu/h)	2.0kW (6824 Btu/h)	2.0kW (6824 Btu/h)	2.8kW (9554 Btu/h)
Injector Marking	079	104	104	130
	<i>L.P.Gas</i>			
Heat Input1	1.0kW (71.8 g/h)	2.0kW (143.7 g/h)	2.0kW (143.7 g/h)	2.7kW (194.0 g/h)
Injector Marking	051	072	072	083

MAIN OVEN

Heat Input	<i>Natural Gas</i>	<i>L.P. Gas</i>
Injector Marking	2.4kW (8189Btu/h)	2.4kW (172.4 g/h)
Flame Supervision Device	108	78
Thermostat	Diamond'H' GSD 1100158/28	Diamond 'H' GSD-100-30
Marking	Diamond'H' 1100158/B2	Diamond'H' 1100156/B2
	69	78

SECOND OVEN

Heat Input	<i>Natural Gas</i>	<i>L. P. Gas</i>
Injector Marking	2.4kW (8189 Btu/h)	2.4kW (172.4g/h)
Flame Supervision Device	108	78
Dual Control	Diamond 'H' GSD 100/31	Diamond 'H' Ref GSD-100/34
Dual Control By-pass	Sourdillon 60112/982	Sourdillon 60525/982
	Fixed Internal	Fixed Internal

GENERAL

Ignition	H. T. Spark
Spark Gap	3-4mm

IMPORTANT - SAFETY REQUIREMENTS

This appliance must be installed in accordance with the Gas Safety (Installation and Use) Regulations Current Editions and the I.E.E. Wiring Regulations. Detailed recommendations are contained in the following British Standard Codes of Practice - BS.6172, BS.5440: Part 2 and B.S.6891. All British Standards must be 'Current Editions'.

PROVISION FOR VENTILATION

This appliance is not connected to a combustion products evacuation device. It shall be installed and connected in accordance with the current installation regulations. Particular attention shall be given to the relevant requirements regarding ventilation.

The room containing the appliance should have an air supply in accordance with BS. 5440: Part 2 Current Edition. All rooms require an openable window or equivalent and some rooms will require a permanent vent as well. For room volumes up to 5m³ an air vent of 100cm² is required: for room volumes between 5m³ and 10m³ an air vent of 50cm² is required. If the room has a door that opens directly to the outside, no air vent is required. For room volumes that exceed 11m³ no air vent is required. If there are other fuel burning appliances in the same room, BS.5440: Part 2 Current Edition should be consulted to determine the requisite air vent requirements.

Prolonged intensive use of the appliance may call for additional ventilation, for example opening a window, or more effective ventilation, for example increasing the level of mechanical ventilation where present.

LOCATION OF APPLIANCE

This appliance must not be installed in a bed-sitting room of volume less than 20m^3 or in a bathroom or shower room. It is essential that the appliance is positioned as stated below (see Fig. 1) i.e. shelves, wall cabinets and cooker hoods must be fitted a minimum of 787mm directly above the top of hotplate and 400mm above the hotplate when fitted in line with the outside of the appliance. If the units are intended to be fitted adjacent to the appliance but less than 400mm above the hotplate, then a minimum space of 100mm must be maintained between the sides of the unit and the appliance (see Fig.2). Curtains must not be fitted immediately behind the appliance or within 150mm of the sides of the hotplate. If fitted next to or between two base units a minimum space of 1mm must be left between each unit and the sides of the appliance. The hotplate must be set to minimum of 7mm above the adjacent units. (Note: The levelling feet fitted to the appliance will achieve a nominal height of 907mm $-5+13\text{mm}$). Base units not meeting the above conditions must be a minimum of 100mm away from the hotplate. L.P.G. cookers MUST NOT be installed below ground level, i.e. in a basement.

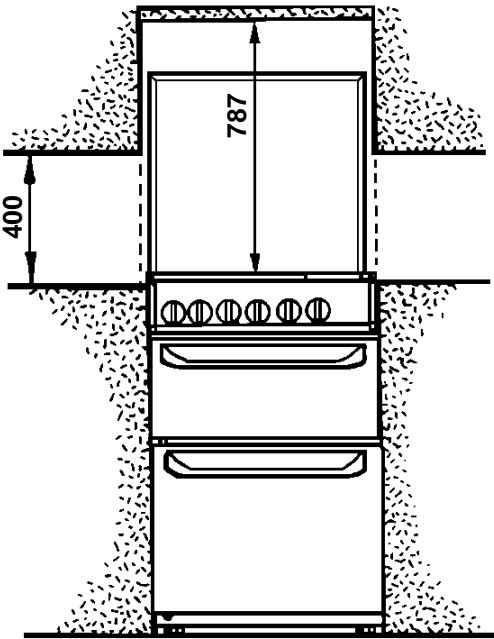

Fig.1a

All dimensions in mm

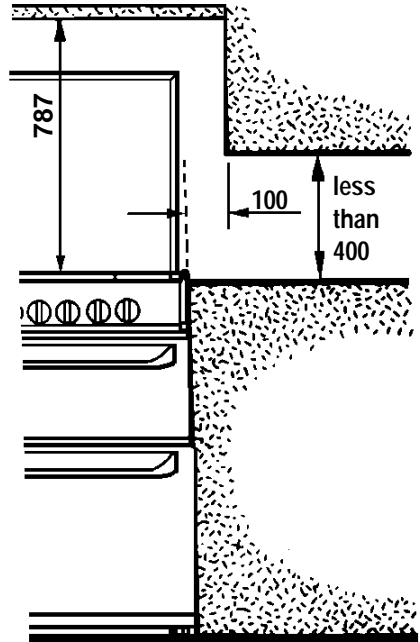

Fig.1b

INSTALLATION

1. PARTS REQUIRED

The loose hotplate parts and battery are packed in the polystyrene fitment on top of the hotplate.

2. LEVELLING THE APPLIANCE

Adjustable levelling feet at the front and at the rear are provided on the base of the appliance.

Adjustment to suit floor conditions is obtained by rotating in or out the hexagonal feet from the underside of the appliance.

A spirit level should be placed on one of the oven shelves to confirm that the appliance is correctly levelled.

3. FITTING THE STABILITY BRACKET

It is recommended that if the appliance is to be installed with a flexible supply pipe a stability bracket (SK.4729.A) is fitted and is available from your supplier (see Important Safety Requirements, Page 36). These instructions should be read in conjunction with the leaflet packed with the stability bracket.

1. Place the appliance in its intended position and level appliance.
2. Mark off 250mm from the left hand side of the appliance as shown in dimension 'A', Fig 3a. This is the centre line of the fixing bracket.
3. Draw a line 100mm from the front edge of the levelling feet (see Fig 3a) and remove appliance from its position. Mark off dimension 'B' (see Fig 3a) back from this line on the centre line of the bracket to locate the front edge of the lower bracket. Fix lower bracket (with two fixing holes) to the floor then measure the height from floor level to engagement edge on back of appliance, dimension 'C' of Fig. 3b.
4. Assemble upper bracket to lower bracket so that underside of bracket is dimension 'C' +3mm above floor level. (see Fig. 3b).

Reposition appliance and check that top bracket engages into appliance back as shown in Fig. 3b.

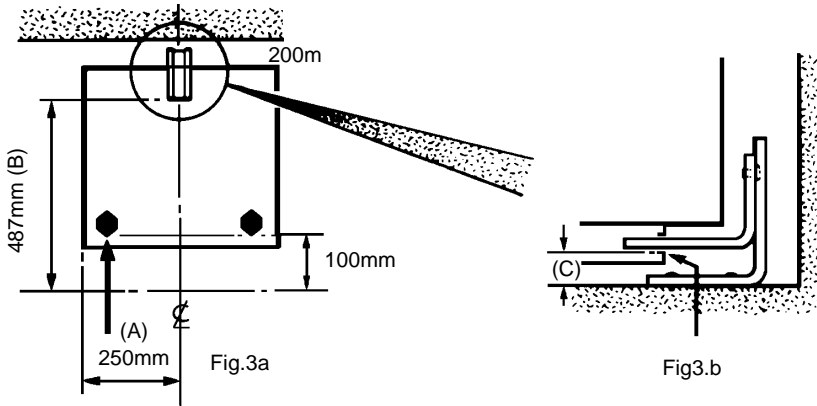

4. CONNECTING TO GAS

This appliance is designed to be installed with an appliance flexible connection only. Supply piping should not be less than R³/8. Connection is made to the Rc ½ (½" B.S.P.) female threaded entry pipe located just below the hotplate level on the rear left hand side of the appliance. **NOTE: ONLY LIQUID SEALANTS TO BE USED WHEN INLET GAS PIPE IS FITTED TO RESET VALVE I.E.: DO NOT USE P.T.F.E. SEALANT TAPE.**

Check for gas soundness after connecting the gas supply.

The gas bayonet connector must be fitted in the shaded area indicated in Fig. 4. Take into account that it must be possible to pull the appliance forward sufficiently. The hose must not get caught on the stability bracket.

IMPORTANT: FLEXIBLE TUBING USED MUST COMPLY WITH BS. 669 CURRENT EDITION. L.P.G. FLEXIBLE CONNECTIONS MUST BE OF A TYPE SUITABLE FOR L.P.G. AND CAPABLE OF OPERATION UP TO 50 mbar AND TO CARRY A RED STRIPE, BAND OR LABEL.

5. FITTING THE BATTERY

1. The battery is located on the left hand side of the front plinth and can be viewed through a slot in the bottom left hand corner of the front frame(Fig 5.)
2. To gain access to the battery, open the main oven door, rotate the battery holder clockwise.
3. Fit the battery AA size ensuring the positive, + terminal is on the right hand side as shown in the diagram. Return the battery to original position by turning it anti-clockwise.

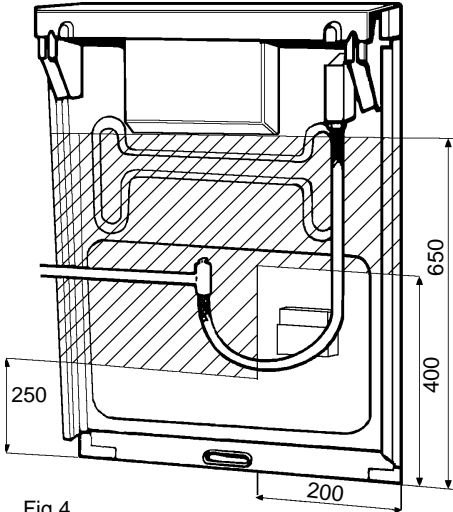
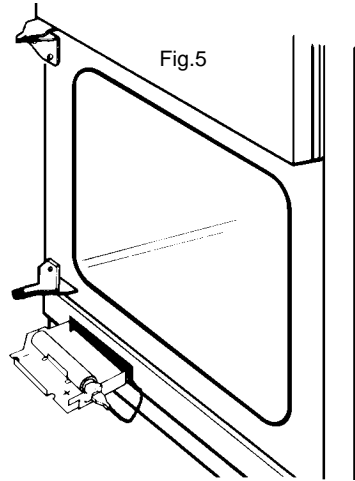

Fig.4



6. PRESSURE TESTING

1. The oven injector is used as a pressure test point.
Remove the oven furniture. Remove oven burner box retaining clips (one spring clip from each side) and remove box front cover. Replace one clip back into the right hand side of the burner box. Remove oven burner by removing the spring clip from the right hand side of the oven burner and slide burner off injector. whilst easing it forward and taking care not to strain the F.S.D. phial.
Connect the pressure gauge to the oven injector.
2. Check the supply pressure by turning the thermostat on and one hotplate tap full on and light the appropriate burner. The pressure should be either:-
 - (i) For Natural Gas 20mbar
 - (ii) For LP.Gas The pressure must be set to 28 mbar for use on butane or 37 mbar for use on propane.
3. Turn off the taps, disconnect the pressure gauge and replace oven burner and cover, ensuring that the F.S.D. phial is correctly located into the bracket on the burner
4. Check operation of oven.

7. CHECKING THE GRILL

Place the grill pan containing the trivet into the grill compartment. Light the grill burner by turning the grill tap full on and pressing the ignition button on the fascia panel. As soon as the burner is lit the button can be released.

8. CHECKING THE HOTPLATE

Fit the burner crowns and caps ensuring that they are correctly seated. Fit the pan supports. Check each of the hotplate burners in turn by turning the hotplate tap to it's full on position and pressing the ignition button. As soon as the burners are lit the button can be released.

9. CHECKING THE MAIN OVEN

1. Turn the oven thermostat knob to Mk 9 and press the ignition button. As soon as the burner is alight the button can be released.
2. There should now be a low gas rate to the burner, which is the F.S.D. by pass rate.
3. When the F.S.D. phial has heated up it opens the F.S.D. valve which allows the main gas supply to the oven burner.
4. Set the oven control to Mk 2, close the oven door and check that after about 10 minutes the flame size has reduced.
5. Turn off the control and check that the oven flames go out.

10. CHECKING THE SECOND OVEN

1. Turn the second oven thermostat control knob anticlockwise to Mk8 and press the ignition button. As soon as the burner is alight the button can be released.
2. When the oven burner lights up there should be a low gas rate at first to the oven burner which is the F.S.D. by-pass rate.
3. When the F.S.D. phial has heated up it opens the F.S.D. valve and the main gas stream flows to the burner.
4. Set the oven control to Mk. 2, close the oven door and check that after approx. 10 minutes the flame size has reduced.
5. Turn off the control knob and check that the oven flames go out.

GENERAL NOTE

Instruct the user on how to use the appliance and its ignition system. Refer the user to the wording in the inside cover which gives advice on the safe operation of the appliance.

SONATA 50 GX

SONATA 50 GX

SONATA 50GX/2 - 311397106

Contents Check List

The loose contents of this pack include:-

No. OFF	DESCRIPTION
2	Oven shelves
1	P.C. Guarantee card
1	Hotplate operation card
1	Grill pan trivet (small wire)
1	Grill pan (small) DIP
1	Detachable grill pan handle
1	Meat tin (enamel)
1	Grill / second oven shelf
4	Burner crowns
4	Burner caps
2	Pan supports
1	Battery

This handbook was correct on the date it was printed. But this handbook will be replaced if the specification or appearance change as the cooker is improved.

<i>Description</i>	<i>No. Off</i>	<i>Maker's Part Number</i>
Burner Cap - Rapid	1	354000610
Burner Cap - Normal	2	354000609
Burner Cap - Simmer	1	354000608
Burner Crown - Rapid - N.G.	1	359039100
Burner Crown - Rapid - L.P.G.	1	337000302
Burner Crown - Normal	2	337000402
Burner Crown - Simmer	1	337000502
Pan Support	2	359033202

NOTE : Failure to use manufacturers original spares could negate normal BSI approval of the product

Parkinson Cowan

Customer Care

P.O. Box 47, Newbury, Berkshire RG14 5XL

Telephone: 01635 525542

Fax: 01635 42970

Drawing No. 311397106