



# *A7N8X-VM*

User Manual

# Motherboard

**E1192**

**First Edition**

**April 2003**

**Copyright © 2003 ASUSTeK COMPUTER INC. All Rights Reserved.**

No part of this manual, including the products and software described in it, may be reproduced, transmitted, transcribed, stored in a retrieval system, or translated into any language in any form or by any means, except documentation kept by the purchaser for backup purposes, without the express written permission of ASUSTeK COMPUTER INC. ("ASUS").

Product warranty or service will not be extended if: (1) the product is repaired, modified or altered, unless such repair, modification or alteration is authorized in writing by ASUS; or (2) the serial number of the product is defaced or missing.

ASUS PROVIDES THIS MANUAL "AS IS" WITHOUT WARRANTY OF ANY KIND, EITHER EXPRESS OR IMPLIED, INCLUDING BUT NOT LIMITED TO THE IMPLIED WARRANTIES OR CONDITIONS OF MERCHANTABILITY OR FITNESS FOR A PARTICULAR PURPOSE. IN NO EVENT SHALL ASUS, ITS DIRECTORS, OFFICERS, EMPLOYEES OR AGENTS BE LIABLE FOR ANY INDIRECT, SPECIAL, INCIDENTAL, OR CONSEQUENTIAL DAMAGES (INCLUDING DAMAGES FOR LOSS OF PROFITS, LOSS OF BUSINESS, LOSS OF USE OR DATA, INTERRUPTION OF BUSINESS AND THE LIKE), EVEN IF ASUS HAS BEEN ADVISED OF THE POSSIBILITY OF SUCH DAMAGES ARISING FROM ANY DEFECT OR ERROR IN THIS MANUAL OR PRODUCT.

SPECIFICATIONS AND INFORMATION CONTAINED IN THIS MANUAL ARE FURNISHED FOR INFORMATIONAL USE ONLY, AND ARE SUBJECT TO CHANGE AT ANY TIME WITHOUT NOTICE, AND SHOULD NOT BE CONSTRUED AS A COMMITMENT BY ASUS. ASUS ASSUMES NO RESPONSIBILITY OR LIABILITY FOR ANY ERRORS OR INACCURACIES THAT MAY APPEAR IN THIS MANUAL, INCLUDING THE PRODUCTS AND SOFTWARE DESCRIBED IN IT.

Products and corporate names appearing in this manual may or may not be registered trademarks or copyrights of their respective companies, and are used only for identification or explanation and to the owners' benefit, without intent to infringe.

# Contents

Contents .....	iii
Notices .....	v
Federal Communications Commission Statement .....	v
Canadian Department of Communications Statement .....	v
Safety information .....	vi
About this guide .....	vii
Conventions used in this guide .....	vii
Where to find more information .....	vii
ASUS contact information .....	vii
Specifications summary .....	ix
<b>Chapter 1 - Motherboard Info .....</b>	<b>1-1</b>
1.1 Welcome .....	1-2
1.2 Package contents .....	1-2
1.3 Special Features .....	1-3
1.4 Motherboard components .....	1-4
1.5 Motherboard layout .....	1-7
1.6 Before you proceed .....	1-8
1.7 Central Processing Unit (CPU) .....	1-8
1.8 System memory .....	1-9
1.9 Expansion Slots .....	1-9
1.9.1 Configuring an expansion card .....	1-9
1.9.2 Standard Interrupt Assignments .....	1-10
1.9.3 AGP Slot .....	1-10
1.9.4 CNR Slot .....	1-11
1.9.5 PCI Slot .....	1-11
1.10 Jumpers .....	1-12
1.11 Connectors .....	1-14
<b>Chapter 2 - BIOS Information .....</b>	<b>2-1</b>
2.1 Managing and updating your BIOS .....	2-2
2.1.1 Using AFUDOS utility to update the BIOS .....	2-2

# Contents

2.2 BIOS Setup Program .....	2-3
2.2.1 BIOS menu bar .....	2-3
2.2.2 Legend bar .....	2-4
2.3 Main Menu .....	2-5
2.3.1 Primary and Secondary Master/Slave .....	2-6
2.3.2 System Information .....	2-7
2.4 Advanced Menu .....	2-8
2.4.1 Chipset .....	2-8
2.4.2 Onboard Devices Configuration .....	2-9
2.4.3 PCI PnP .....	2-11
2.5 Power Menu .....	2-12
2.5.1 Power-up control .....	2-13
2.5.2 Hardware Monitor .....	2-14
2.6 Boot Menu .....	2-15
2.6.1 Boot Settings Configuration .....	2-15
2.6.2 Security .....	2-17
2.7 Exit Menu .....	2-18
<b>Chapter 3 - Software support .....</b>	<b>3-1</b>
3.1 Installing an operating system .....	3-2
3.2 Support CD Information .....	3-2
3.2.1 Running the support CD .....	3-2
3.2.2 Drivers menu .....	3-3
3.2.3 Utilities menu .....	3-3

# Notices

## Federal Communications Commission Statement

This device complies with FCC Rules Part 15. Operation is subject to the following two conditions:

- This device may not cause harmful interference, and
- This device must accept any interference received including interference that may cause undesired operation.

This equipment has been tested and found to comply with the limits for a Class B digital device, pursuant to Part 15 of the FCC Rules. These limits are designed to provide reasonable protection against harmful interference in a residential installation. This equipment generates, uses and can radiate radio frequency energy and, if not installed and used in accordance with manufacturer's instructions, may cause harmful interference to radio communications. However, there is no guarantee that interference will not occur in a particular installation. If this equipment does cause harmful interference to radio or television reception, which can be determined by turning the equipment off and on, the user is encouraged to try to correct the interference by one or more of the following measures:

- Reorient or relocate the receiving antenna.
- Increase the separation between the equipment and receiver.
- Connect the equipment to an outlet on a circuit different from that to which the receiver is connected.
- Consult the dealer or an experienced radio/TV technician for help.



---

The use of shielded cables for connection of the monitor to the graphics card is required to assure compliance with FCC regulations. Changes or modifications to this unit not expressly approved by the party responsible for compliance could void the user's authority to operate this equipment.

---

## Canadian Department of Communications Statement

This digital apparatus does not exceed the Class B limits for radio noise emissions from digital apparatus set out in the Radio Interference Regulations of the Canadian Department of Communications.

**This class B digital apparatus complies with Canadian ICES-003.**

# Safety information

## Electrical safety

- To prevent electrical shock hazard, disconnect the power cable from the electrical outlet before relocating the system.
- When adding or removing devices to or from the system, ensure that the power cables for the devices are unplugged before the signal cables are connected. If possible, disconnect all power cables from the existing system before you add a device.
- Before connecting or removing signal cables from the motherboard, ensure that all power cables are unplugged.
- Seek professional assistance before using an adapter or extension cord. These devices could interrupt the grounding circuit.
- Make sure that your power supply is set to the correct voltage in your area. If you are not sure about the voltage of the electrical outlet you are using, contact your local power company.
- If the power supply is broken, do not try to fix it by yourself. Contact a qualified service technician or your retailer.

## Operation safety

- Before installing the motherboard and adding devices on it, carefully read all the manuals that came with the package.
- Before using the product, make sure all cables are correctly connected and the power cables are not damaged. If you detect any damage, contact your dealer immediately.
- To avoid short circuits, keep paper clips, screws, and staples away from connectors, slots, sockets and circuitry.
- Avoid dust, humidity, and temperature extremes. Do not place the product in any area where it may become wet.
- Place the product on a stable surface.
- If you encounter technical problems with the product, contact a qualified service technician or your retailer.

## Conventions used in this guide

To make sure that you perform certain tasks properly, take note of the following symbols used throughout this manual.



**WARNING/DANGER:** Information to prevent injury to yourself when trying to complete a task.



**CAUTION:** Information to prevent damage to the components when trying to complete a task.



**IMPORTANT:** Information that you **MUST** follow to complete a task.



**NOTE:** Tips and additional information to aid in completing a task.

## Where to find more information

Refer to the following sources for additional information and for product and software updates.

### 1. ASUS Websites

The ASUS websites worldwide provide updated information on ASUS hardware and software products. The ASUS websites are listed in the ASUS Contact Information on page viii.

### 2. Optional Documentation

Your product package may include optional documentation, such as warranty flyers, that may have been added by your dealer. These documents are not part of the standard package.

# ASUS contact information

## ASUSTeK COMPUTER INC. (Asia-Pacific)

Address: 150 Li-Te Road, Peitou, Taipei, Taiwan 112  
General Tel: +886-2-2894-3447  
General Fax: +886-2-2894-3449  
General Email: info@asus.com.tw

### *Technical Support*

MB/Others (Tel): +886-2-2890-7121 (English)  
Notebook (Tel): +886-2-2890-7122 (English)  
Desktop/Server (Tel): +886-2-2890-7123 (English)  
Support Fax: +886-2-2890-7698  
Web Site: www.asus.com.tw

## ASUS COMPUTER INTERNATIONAL (America)

Address: 44370 Nobel Drive, Fremont, CA 94538, USA  
General Fax: +1-510-608-4555  
General Email: tmd1@asus.com

### *Technical Support*

Support Fax: +1-510-608-4555  
General Support: +1-510-739-3777  
Web Site: www.asus.com  
Support Email: tsd@asus.com

## ASUS COMPUTER GmbH (Germany and Austria)

Address: Harkortstr. 25, 40880 Ratingen, BRD, Germany  
General Fax: +49-2102-442066  
General Email: sales@asuscom.de (for marketing requests only)

### *Technical Support*

Support Hotline: MB/Others: +49-2102-9599-0  
Notebook (Tel): +49-2102-9599-10  
Support Fax: +49-2102-9599-11  
Support (Email): www.asuscom.de/de/support (for online support)  
Web Site: www.asuscom.de



# A7N8X-VM specifications summary

CPU	Socket A Type 462 for AMD Athlon™/Athlon™ XP 3000+ 333/266 MHz FSB Support
Chipset	NVIDIA® nForce2 IGP North bridge controller NVIDIA® nForce2 MCP2 (MCP2-T optional) South bridge
Front Side Bus (FSB)	333/266 Mhz
Memory	2 x 184-pin DDR DIMM Sockets Maximum 2 GB unbuffered PC2700/2100 non-ECC DDR RAM memory.
Expansion slots	3 x PCI 1 x AGP 8X (1.5V only) 1 x CNR
IDE	2 x UltraATA 133/100/66/33
Graphics	Integrated nForce 2 with TV-out Supports UMA Mode
Audio	Realtek ALC650 6CH Audio CODEC linked w/ South Bridge
LAN	Realtek 8201BL PHY 10/100 Mbps
IEEE 1394 (optional)	Agere FW802C PHY supports up to 400Mbps data transfers
Hardware Monitoring	Super I/O integrated monitoring of CPU/chassis fan rotation and MB/CPU temperature
Special Features	S/PDIF in/out support
Back Panel I/O Ports	1 x Parallel 1 x Serial 1 x PS/2 Keyboard 1 x PS/2 Mouse 1 x RJ45 port 1 x Audio I/O 1 x VGA port 2 x USB 2.0/1.1
Internal I/O Connectors	2 x USB connectors support additional 4 USB 2.0/1.1 ports CPU/chassis FAN connectors Chassis intrusion connector 20-pin ATX power connector PANEL connector CD / AUX connectors S/PDIF in/out connector 2 x IEEE 1394 connectors (optional) GAME/MIDI connector TV out connector Serial connector Front panel audio connector

(continued on the next page)

# A7N8X-VM specifications summary

BIOS features	4Mb Flash EEPROM, AMI BIOS, ACPI 2.0, DMI, Green, PnP, TCAV, SMBIOS 2.3
Industry standard	PCI 2.2, USB 2.0/1.1
Manageability	DMI 2.0, WOL, WOR, WO_USB, WO_KB/MS, SM Bus
Support CD contents	Device drivers ASUS PC Probe ASUS Update ASUS Screen Saver E-Color 3Deep Direct X Adobe Acrobat Reader Trend Micro™ PC-cillin 2002 anti-virus software
Accessories	User Guide ASUS A7N8X-VM series support CD 40-pin ribbon cable for UltraATA 133/100/66/33 IDE drives FDD cable I/O shield
Form Factor	Micro-ATX form factor: 9.6 in x 9.6 in

\* Specifications are subject to change without notice.

# ***Chapter 1***

This chapter describes the features of the A7N8X-VM motherboard. It includes brief descriptions of the motherboard components, and illustrations of the layout, jumper settings, and connectors.

## **Product introduction**

# 1.1 Welcome!

**Thank you for buying the ASUS® A7N8X-VM motherboard!**

The ASUS A7N8X-VM motherboard is loaded with the most advanced technologies to deliver maximum performance for socket A processors. This motherboard is packed with value-added features for guaranteed consumer satisfaction. The following sections provide technical information about the motherboard important for future upgrades or system reconfiguration.

Before you start installing the motherboard and hardware devices on it, check the items in your package with the list below.

# 1.2 Package contents

Check your ASUS A7N8X-VM package for the following items.

- ✓ ASUS A7N8X-VM motherboard  
Micro-ATX form factor: 9.6 in x 9.6 in
- ✓ ASUS A7N8X-VM series support CD
- ✓ 40-pin 80-conductor ribbon cable for UltraATA/133/100/66/33 IDE drives
- ✓ Ribbon cable for a 3.5-inch floppy drive
- ✓ Bag of extra jumper caps
- ✓ I/O shield
- ✓ User's Manual

## 1.3 Special features

### Latest processor technology

The motherboard supports the latest AMD Athlon™/Athlon™ XP 3000+ processors via a surface mounted 462-pin socket. With up to 333Mhz front side bus frequency, you can be assured of an efficient and reliable computing performance.

### USB 2.0 technology



The motherboard supports the new Universal Serial Bus (USB) 2.0 specification, extending the connection speed from 12 Mbps on USB 1.1 to a fast 480 Mbps on USB 2.0. The higher bandwidth of USB 2.0 allows connection of devices such as high resolution video conferencing cameras, next generation scanners and printers, and fast storage units. USB 2.0 is backward compatible with USB 1.1.

### IEEE 1394 support (optional)



Two 6-to-10 pin internal 1394 connectors support a multiplicity of connections for IEEE 1394 devices such as DV camcorders, digital cameras and other consumer electronics with 1394 support. The IEEE 1394 interface provides high speed and flexible PC connectivity of up to 400Mbps transfer rates.

### 6-channel digital audio

The Realtek ALC650 Audio CODEC provides 6-channel audio playback for 5.1 surround sound, over 90dB dynamic range.

# 1.4 Motherboard components

Before you install the motherboard, learn about its major components and available features to facilitate the installation and future upgrades. Refer to the succeeding pages for the component descriptions.

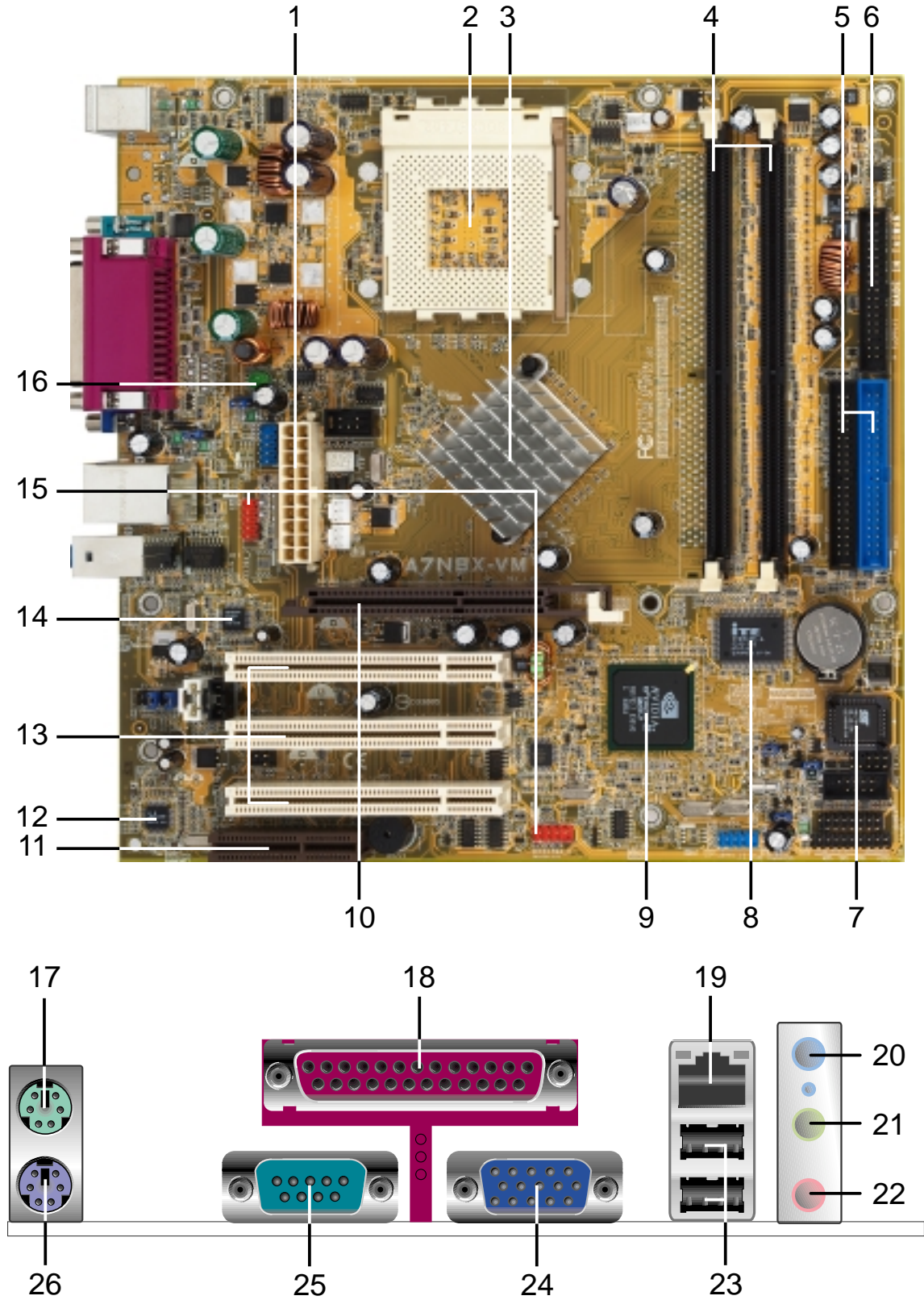

- 1 ATX power connector.** This standard 20-pin connector connects to an ATX 12V power supply. The power supply must have at least 1A on the +5V standby lead (+5VSB).
- 2 CPU Socket.** Socket 462 (Socket A) Zero Insertion Force (ZIF) socket for the AMD Athlon™/Athlon XP™ 3000+ processors.
- 3 NorthBridge Controller.** The NVIDIA® nForce2™ IGP North Bridge controller chipset. The controller supports a 64/128bit DDR memory controller and up to 2 GB of 333/266/200MHz DDR memory.
- 4 DDR DIMM Sockets.** Equipped with two Double Data Rate Dual Inline Memory Module (DDR DIMM) sockets to support up to 2GB of DDR DRAM, the newest memory standard with the highest bandwidth and lowest latency currently available. This memory technology supplies data transfer rates up to 5.4GB/s for 333MHz DDR SDRAM.
- 5 IDE Connectors.** These dual-channel bus master IDE connectors support up to four Ultra ATA133/100/66/33, PIO Modes 0-4 IDE devices. Both the primary(blue) and secondary(black) connectors are slotted to prevent incorrect insertion of the IDE ribbon cable.
- 6 Floppy Disk connector.** This connector connects the provided ribbon cable for the floppy disk drive. One side of the connector is slotted to prevent incorrect insertion of the floppy disk cable.
- 7 Flash EEPROM.** This 4Mb ISA chip contains the programmable BIOS program.
- 8 Super I/O chipset.** ITE IT8712F-A offers support for a variety of I/O functions. Provides two high-speed UART compatible serial ports and one parallel port with EPP and ECP capabilities. UART2 can also be directed from COM2 to the Infrared Module for wireless connections. The Super I/O controller supports a floppy disk drive, PS/2 keyboard, and PS/2 mouse.
- 9 South bridge controller.** Features the brand new NVIDIA® MCP2 (MCP2-T optional) integrated peripheral South Bridge controller operates at 800MB/sec to communicate with the North Bridge for maximum bandwidth required for PCI, USB and support for Fast Ethernet devices. The controller supports standard UltraATA 133/100/66/33 and separate data paths for each IDE channel are built-in for up to two IDE devices. The controller supports six USB ports, one LAN port and is PCI rev2.2 compliant.
- 10 AGP Slot.** This Accelerated Graphics Port (AGP) slot only supports 1.5V AGP 8X/4X mode graphics cards for 3D graphical applications.
- 11 CNR slot.** The Communications and Networking Riser (CNR) slot supports interface cards that integrates audio, modem, and network functionality.

- 12 Audio CODEC.** The Realtek ALC650 6-channel Audio CODEC is an AC'97 compliant audio CODEC designed for PC multimedia systems.
- 13 PCI slots.** These 32-bit PCI 2.2 expansion slots support bus master PCI cards like SCSI or LAN cards with 133MB/s maximum output.
- 14 LAN chip.** The Realtek 8201BL PHY Fast Ethernet controller allows connection to a Local Area Network (LAN) through a network hub.
- 15 IEEE 1394 connectors (optional).** The two internal 10-to-6-pin (orange) IEEE 1394 connectors are for serial connector cables that connect to the 1394 module in front/rear panels.
- 16 Onboard LED.** This onboard LED lights up if there is a standby power on the motherboard. This LED acts as a reminder to turn off the system power before plugging or unplugging devices.
- 17 PS/2 mouse port.** This green 6-pin connector is for a PS/2 mouse.
- 18 Parallel port.** This 25-pin port connects a parallel printer, a scanner, or other devices.
- 19 RJ-45 port.** Using the NVMAC<sup>®</sup> in the Southbridge controller and Realtek 8201BL PHY Fast Ethernet controller, this port allows connection to a Local Area Network (LAN) through a network hub.
- 20 Line In jack.** This Line In (light blue) jack connects a tape player or other audio sources.
- 21 Line Out jack.** This Line Out (lime) jack connects a headphone or a speaker.
- 22 Microphone jack.** This Mic (pink) jack connects a microphone.
- 23 USB 2.0/1.1 ports.** These two 4-pin Universal Serial Bus 2.0/1.1 ports are available for connecting USB devices such as a mouse and PDA.
- 24 VGA port.** This 15-pin VGA port connects to a VGA monitor.
- 25 Serial port.** This port connects to your serial mouse and other serial devices.
- 26 PS/2 keyboard port.** This purple 6-pin connector is for a PS/2 keyboard.



# 1.5 Motherboard layout

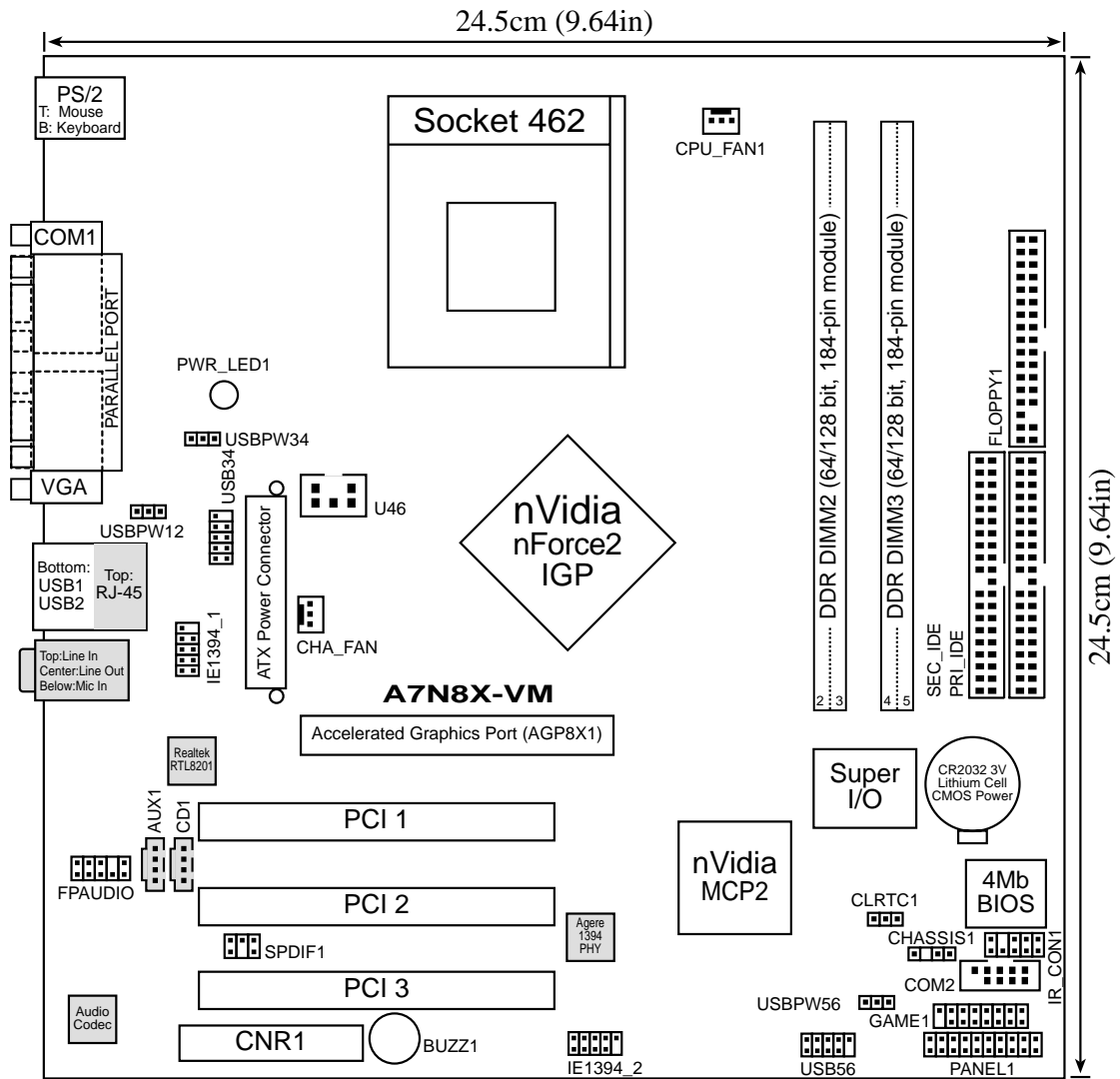

## 1.6 Before you proceed

Take note of the following precautions before you install motherboard components or change any motherboard settings.



1. Unplug the power cord from the wall socket before touching any component.
2. Use a grounded wrist strap or touch a safely grounded object or to a metal object, such as the power supply case, before handling components to avoid damaging them due to static electricity.
3. Hold components by the edges to avoid touching the ICs on them.
4. Whenever you uninstall any component, place it on a grounded antistatic pad or in the bag that came with the component.
5. **Before you install or remove any component, ensure that the ATX power supply is switched off or the power cord is detached from the power supply.** Failure to do so may cause severe damage to the motherboard, peripherals, and/or components.

## 1.7 Central Processing Unit (CPU)

The motherboard provides a Socket A (462) for CPU installation. AMD processors offer gigahertz speeds to support all the latest computing platforms and applications. The A7N8X-VM supports Athlon™ XP processors with “QuantiSpeed” data processing, large data caches, 3D enhancements and 333/266Mhz bus speeds.

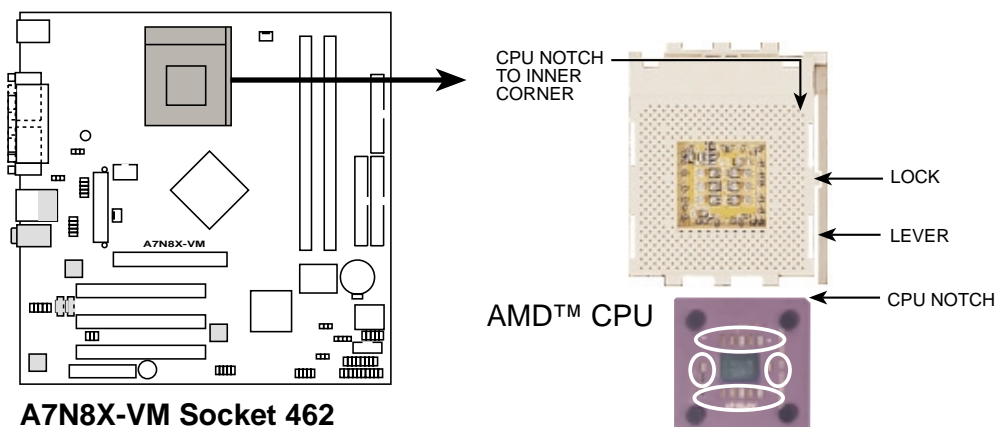

Each AMD CPU has a “marked” corner. This corner is usually indicated with a notch, and/or a golden square or triangle. Refer to this indicator while orienting the CPU. A fan and heatsink should be attached to the CPU to prevent overheating.

## 1.8 System memory

The motherboard has two Double Data Rate (DDR) DIMM sockets that supports up to 2GB non-ECC PC2700/2100 DDR DIMMs.

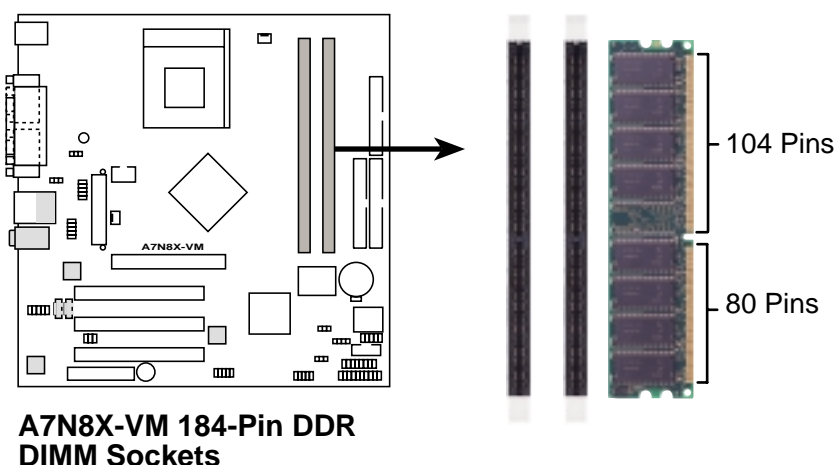

---

A DDR DIMM is keyed with a notch so that it fits in only one direction. DO NOT force a DIMM into a socket to avoid damaging the DIMM.

---

### 1.8.1 Installing a DIMM

1. Unlock a DIMM socket by pressing the retaining clips outward.
2. Align a DIMM on the socket. Make sure the notches on the DIMM exactly match the notches in the socket.
3. Firmly insert the DIMM into the socket until the retaining clips lock into place.

## 1.9 Expansion slots

The A7N8X-VM motherboard has three (3) PCI, one (1) Accelerated Graphics Port (AGP) and one (1) Communications and Networking Riser (CNR) expansion slots. The following sub-sections describe the slots and the expansion cards that they support.

### 1.9.1 Configuring an expansion card

Some expansion cards need an IRQ to operate. Generally, an IRQ must be exclusively assigned to one function at a time. In a standard design configuration, 16 IRQs are available but most are already in use.

Normally, 6 IRQs are free for expansion cards. Sometimes IRQs are “shared” by more than one function; in this case, IRQ assignments are swapped automatically or adjusted through the BIOS firmware.

## 1.9.2 Standard Interrupt Assignments

IRQ	Standard Function
0	System Timer
1	Keyboard Controller
2	Programmable Interrupt Controller
3*	USB Universal Host Controller
4*	Communications Port (COM1)
5*	Onboard Audio
6	Standard Floppy Disk Controller
7*	Printer Port (LPT1)
8	System CMOS/Real Time Clock
9*	Onboard LAN
10*	USB Universal Host Controller
11*	Onboard VGA
12*	PS/2 Compatible Mouse Port
13	Numeric Data Processor
14*	Ultra ATA Controller
15*	Secondary Ultra ATA Controller

\*These IRQs are usually available for ISA or PCI devices.

### IRQ assignments for this motherboard

	A	B	C	D	E	F	G
PCI slot 1	used	–	–	–	–	–	–
PCI slot 2	–	–	–	used	–	–	–
PCI slot 3	–	–	used	–	–	–	–
AGP slot	–	used	–	–	–	–	–

## 1.9.3 AGP slot

This motherboard has an Accelerated Graphics Port (AGP) slot that supports +1.5V AGP 8X cards. Note the notches on the card golden fingers to ensure that they fit the AGP slot on your motherboard.

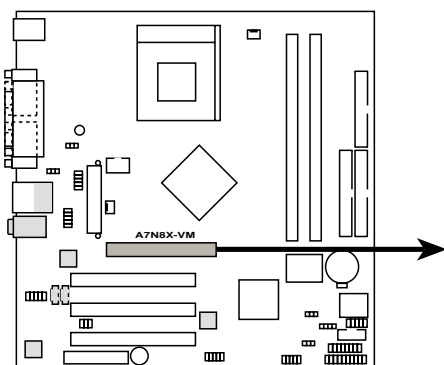

**A7N8X-VM Accelerated Graphics Port (AGP8X)**

AGP Card without Retention Notch



## 1.9.4 CNR slot

The Communications and Networking Riser (CNR) slot supports interface cards that integrates audio, modem, and network functionality.

The CNR specification supports interfaces including:

- Audio Codec '97 (AC '97) - for audio and/or modem functions
- Local Area Network (LAN) - for networking functions
- Universal Serial Bus (USB) - for functions implemented in the USB interface, and technologies such as broadband, DSL, and wireless
- System Management Bus (SMB) - for Plug-n-Play functionality
- Power - to provide the signals required for power management, and the main power supplies to operate the CNR circuitry

The CNR is tagged to replace the current Audio Modem Riser (AMR) slot because of its flexibility and added features. Also, the CNR slot does not take up the motherboard space for one PCI slot because it is a shared slot; rather, it provides you more options.

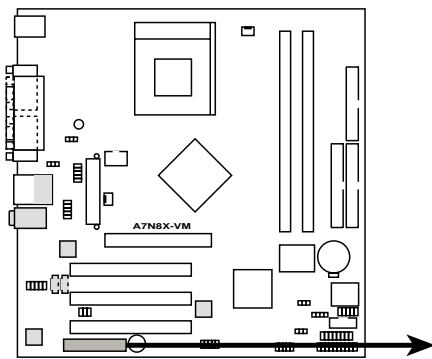

**A7N8X-VM Communication & Networking Riser Slot**



## 1.9.5 PCI slots

Three 32-bit PCI slots are available on this motherboard. The slots support PCI cards such as LAN card, SCSI card, USB card, and other cards that comply with PCI specifications.

# 1.10 Jumpers

This section describes and illustrates the jumpers on the motherboard.

## 1. USB device wake-up (3-pin USBPW12,USBPW34,USBPW56)

Set these jumpers to +5V to wake up the computer from S1 sleep mode (CPU stopped, DRAM refreshed, system running in low power mode) using the connected USB devices. Set to +5VSB to wake up from S3 sleep mode (no power to CPU, DRAM in slow refresh, power supply in reduced power mode). Both jumpers are set to pins 1-2 (+5V) by default because not all computers have the appropriate power supply to support this feature.

The USBPW12 jumper is for the rear USB port. USBPW34 and USBPW56 are for the internal USB header that you can connect to front USB ports.



This feature requires a power supply that can provide at least 2A on the +5VSB lead when these jumpers are set to +5VSB. Otherwise, the system does not power up.

The total current consumed must NOT exceed the power supply capability (+5VSB) whether under normal condition or in sleep mode.

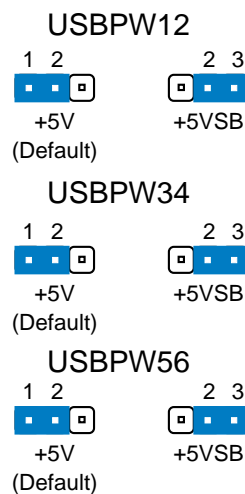
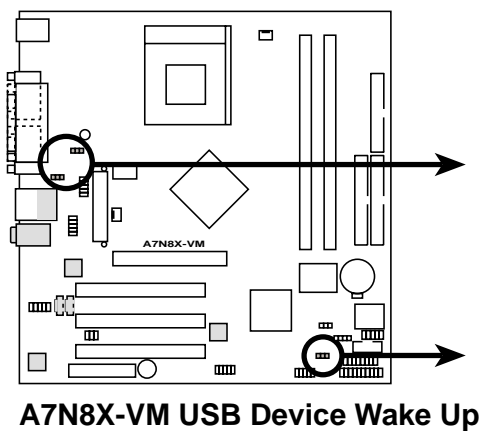

## 2. Clear RTC RAM (CLRTC1)

This jumper clears the Real Time Clock (RTC) RAM of date, time and system setup parameters in CMOS. The RAM data in CMOS is powered by the onboard button cell battery.

To erase the RTC RAM:

1. Turn OFF the computer and unplug the power cord.
2. Remove the battery.
3. Move the jumper caps from [1-2] to [2-3] momentarily. Replace the jumper cap to the original position, [1-2].
4. Re-install the battery.
5. Plug the power cord and turn ON the computer.
6. Hold down the <Del> key during the boot process and enter BIOS setup to re-enter data.

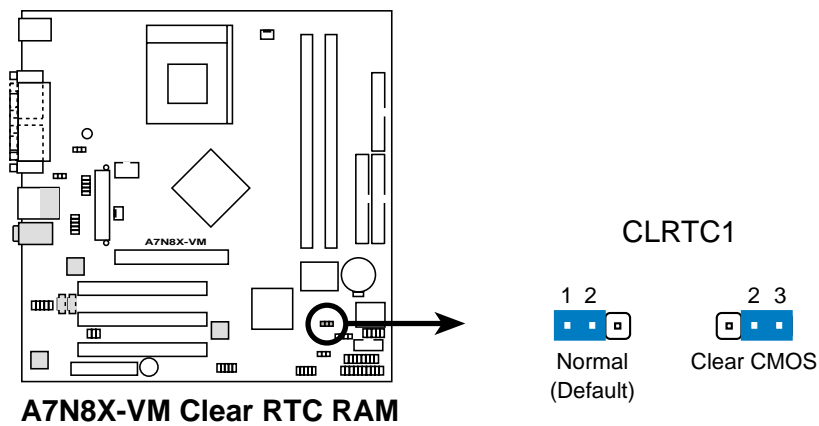

# 1.11 Connectors

This section describes and illustrates the connectors on the motherboard.

## 1. IDE connectors (40-1 pin PRI\_IDE, SEC\_IDE)

This connector supports the provided UltraATA/133/100/66/33 IDE hard disk ribbon cable. Connect the cable's blue connector to the primary (recommended) or secondary IDE connector, then connect the gray connector to the UltraATA/133/100/66/33 slave device (hard disk drive) and the black connector to the UltraATA/133/100/66/33 master device. It is recommended that you connect non-UltraATA/133/100/66/33 devices to the secondary IDE connector. If you install two hard disks, you must configure the second drive as a slave device by setting its jumper accordingly. Refer to the hard disk documentation for the jumper settings. BIOS supports specific device bootup. If you have more than two UltraATA/133/100/66/33 devices, purchase another UltraATA/133/100/66/33 cable. You may configure two hard disks to be both master devices with two ribbon cables – one for the primary IDE connector and another for the secondary IDE connector.



Pin 20 on each IDE connector is removed to match the covered hole on the UltraATA cable connector. This prevents incorrect orientation when you connect the cables.

For UltraATA/133/100/66/33IDE devices, use an 80-conductor IDE cable.

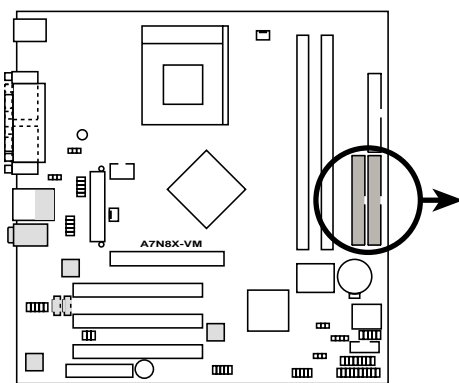

**A7N8X-VM IDE Connectors**

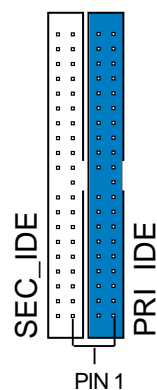

**NOTE:** Orient the red markings (usually zigzag) on the IDE ribbon cable to PIN 1.



## 2. Floppy disk drive connector (34-1 pin FLOPPY1)

This connector supports the provided floppy drive ribbon cable. After connecting one end to the motherboard, connect the other end to the floppy drive. (Pin 5 is removed to prevent incorrect insertion when using ribbon cables with pin 5 plug.)

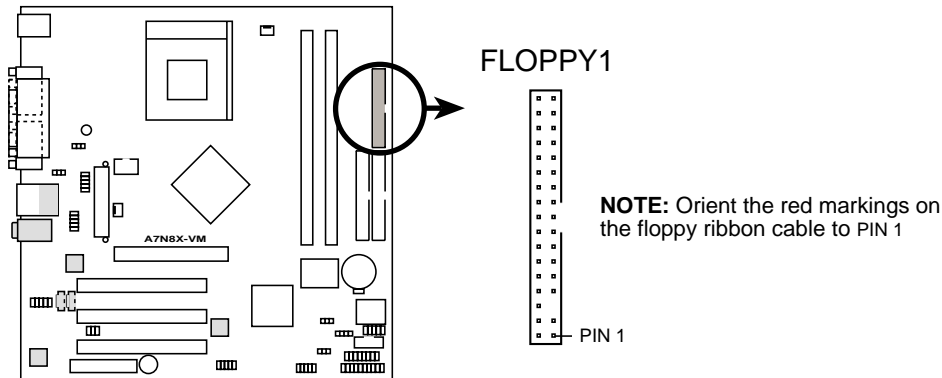

**A7N8X-VM Floppy Disk Drive Connector**

## 3. ATX power connectors (20-pin ATXPWR1)

These connectors connect to an ATX 12V power supply. The plugs from the power supply are designed to fit these connectors in only one orientation. Find the proper orientation and push down firmly until the connectors completely fit.

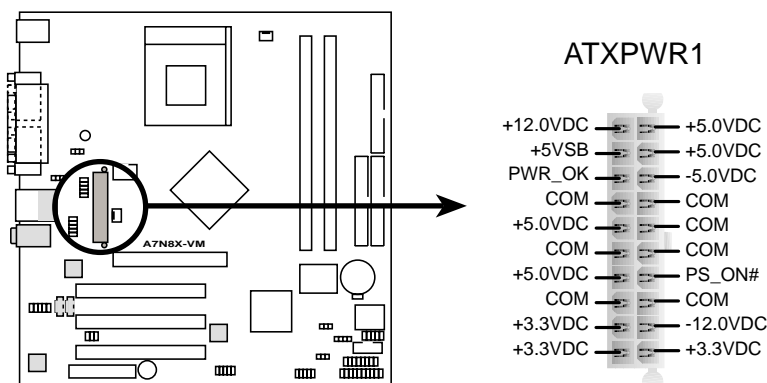

**A7N8X-VM ATX Power Connector**



If you will need to replace the power supply in the future, make sure that your new ATX 12V power supply can provide 8A on the +12V lead and at least 1A on the +5-volt standby lead (+5VSB). The minimum recommended wattage is 230W, or 300W for a fully configured system. The system may become unstable and may experience difficulty powering up if the power supply is inadequate.

#### 4. USB headers (10-1 pin USB34, USB56)

If the USB 2.0 port connectors on the back panel are inadequate, two USB headers are available for four additional USB port connectors. Connect a 2-port USB connector set to a USB header and mount the USB bracket to an open slot in the chassis.

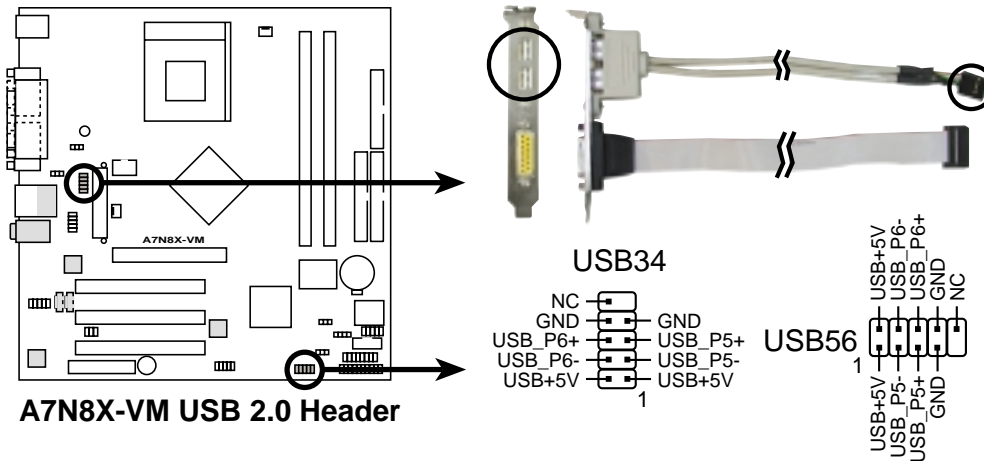

#### 5. GAME/MIDI connector (16-1 pin GAME1)

This connector supports a GAME/MIDI module. If your package came with the optional USB 2.0/GAME module, connect the GAME/MIDI cable to this connector. The GAME/MIDI port on the module connects a joystick or a game pad for playing games, and MIDI devices for playing or editing audio files.

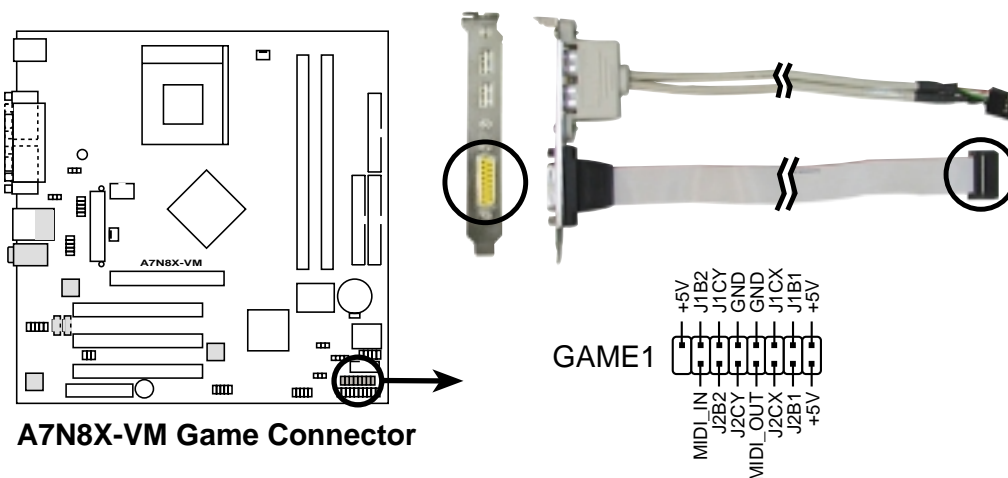

## 6. CPU and Chassis Fan Connectors (3-pin CPU\_FAN1, CHA\_FAN)

The fan connectors support cooling fans of 350mA~740mA (8.88W max.) or a total of 1A~2.22A (26.64W max.) at +12V. Connect the fan cables to the fan connectors on the motherboard, making sure that the black wire of each cable matches the ground pin of the connector.

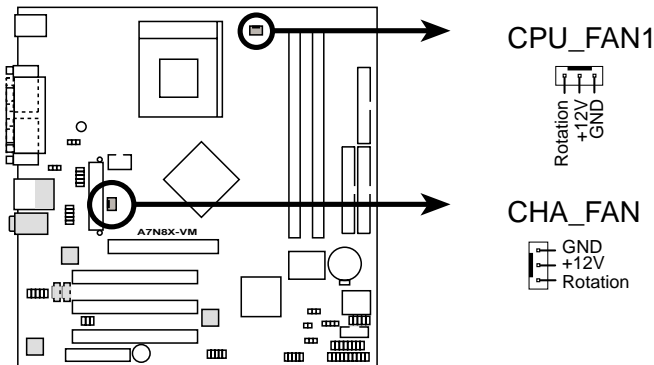

**A7N8X-VM 12-Volt Fan Connectors**



Do not forget to connect the fan cables to the fan connectors. Lack of sufficient air flow within the system may damage the motherboard components. These are not jumpers! **DO NOT** place jumper caps on the fan connectors!

## 7. Chassis intrusion connector (4-1 pin CHASSIS1)

This lead is for a chassis designed with intrusion detection feature. This requires an external detection mechanism such as a chassis intrusion sensor or microswitch. When you remove any chassis component, the sensor triggers and sends a high-level signal to this lead to record a chassis intrusion event.

By default, the pins labeled “Chassis Signal” and “Ground” are shorted with a jumper cap. If you wish to use the chassis intrusion detection feature, remove the jumper cap from the pins.

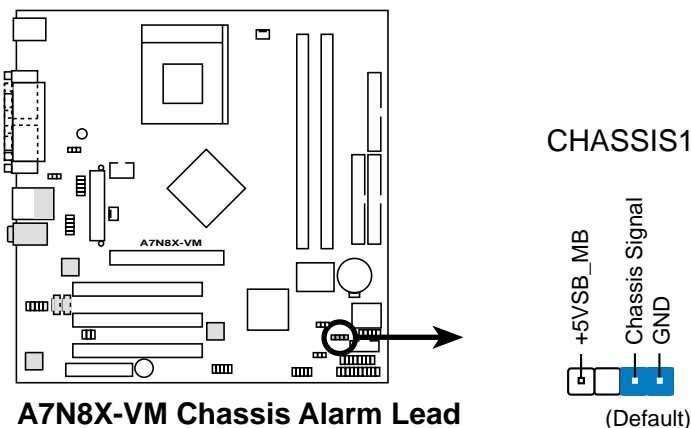

**A7N8X-VM Chassis Alarm Lead**

**CHASSIS1**

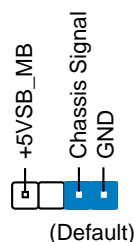

## 8. Front panel audio connectors (10-1 pin FPAUDIO)

This is an interface for front panel audio cable that allows convenient connection and control of audio devices.

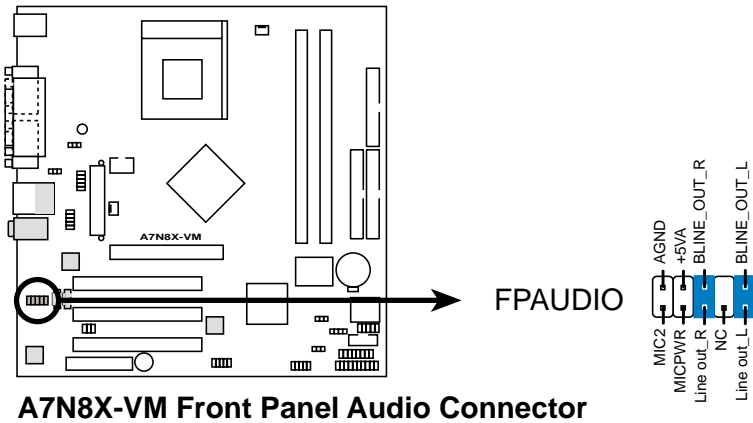

## 9. OnBoard LED

The green Light Emitting Diode (LED) lights-ON if there is standby power and lights-OFF when the power is turned off.

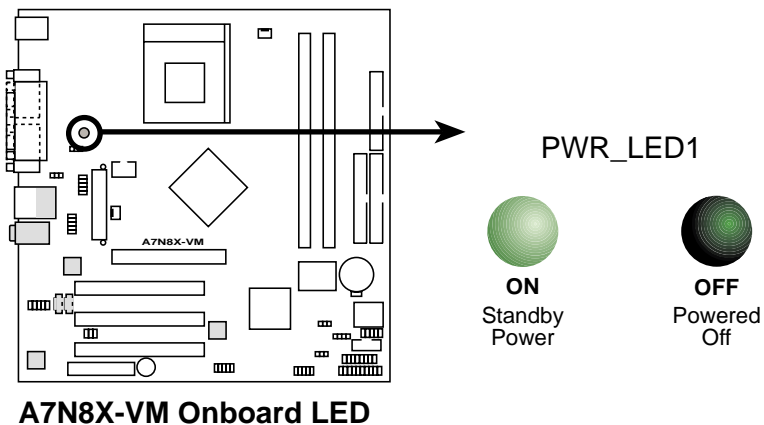

## 10. Internal audio connectors (4 pin CD1, AUX1)

These connectors allow you to receive stereo audio input from sound sources such as a CD-ROM, TV tuner, MPEG card or modem.

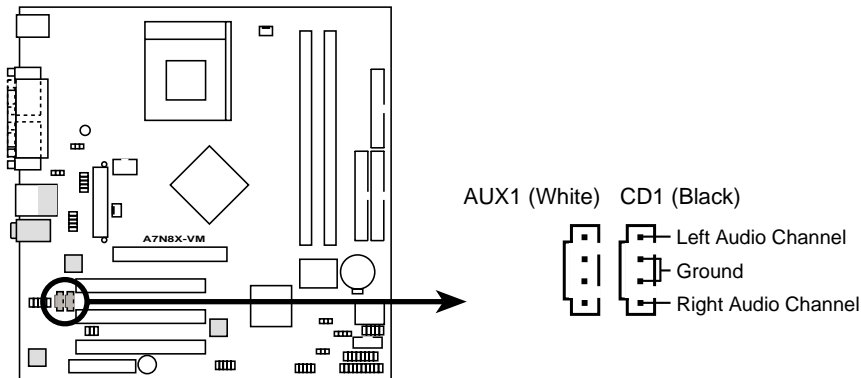

**A7N8X-VM Internal Audio Connectors**

## 11. Digital Audio Connector (6-1 pin SPDIF1)

This connector is for optional S/PDIF audio module that allows digital instead of analog sound input and output.

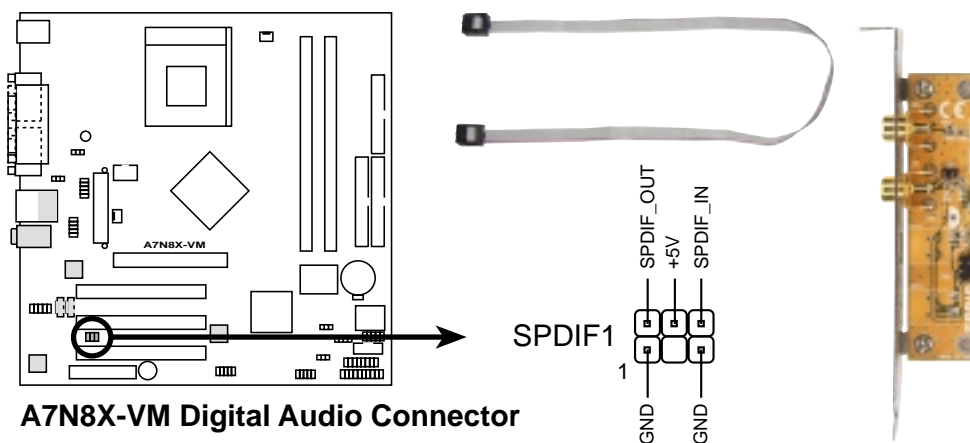

**A7N8X-VM Digital Audio Connector**



When you input sound for S/PDIF IN, the LINE\_OUT will output the sound. Mute LINE\_OUT to impede sound output from S/PDIF IN.

## 12. Infrared Module connector (10-1 pin IR\_CON1)

These connectors support an optional wireless transmitting and receiving infrared module. The module mounts to a small opening on the system chassis that support this feature. You must also configure the UART2 Use As parameter in BIOS to set UART2 for use with IR.

Use the ten pins as shown in Back View and connect a ribbon cable from the module to the motherboard SIR connector according to the pin definitions.

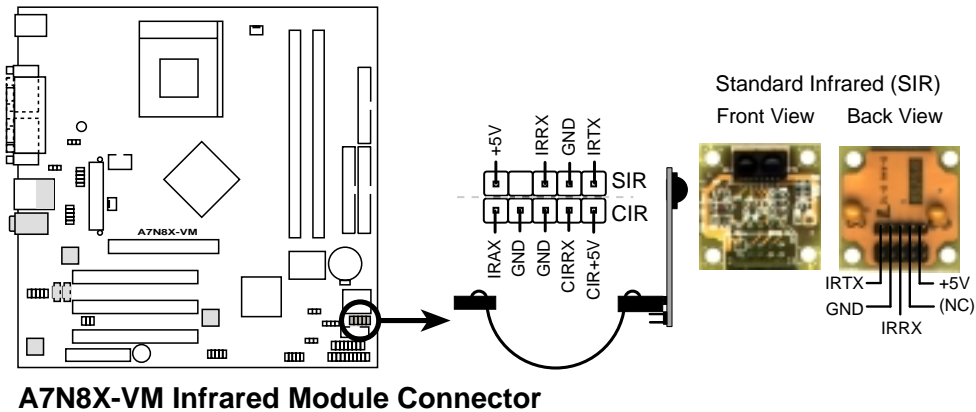

## 13. TV out connector (6-1 pin U46)

This 6-1 pin connector connects to the front panel daughter card with the audio tv-out port.

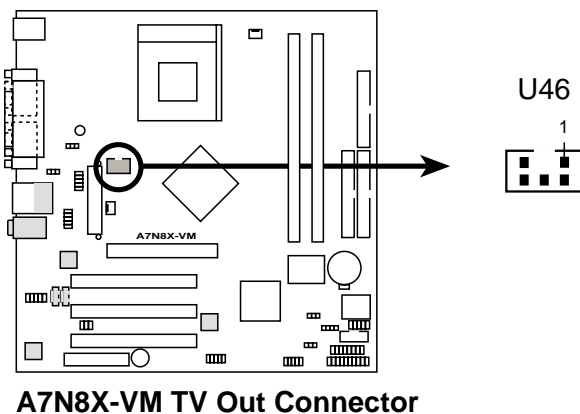

#### 14. Serial Port 2 connector (10-1 pin COM2)

This connector accommodates a second serial port using an optional serial port bracket. Connect the bracket cable to this connector then install the bracket into a slot opening at the back of the system chassis.

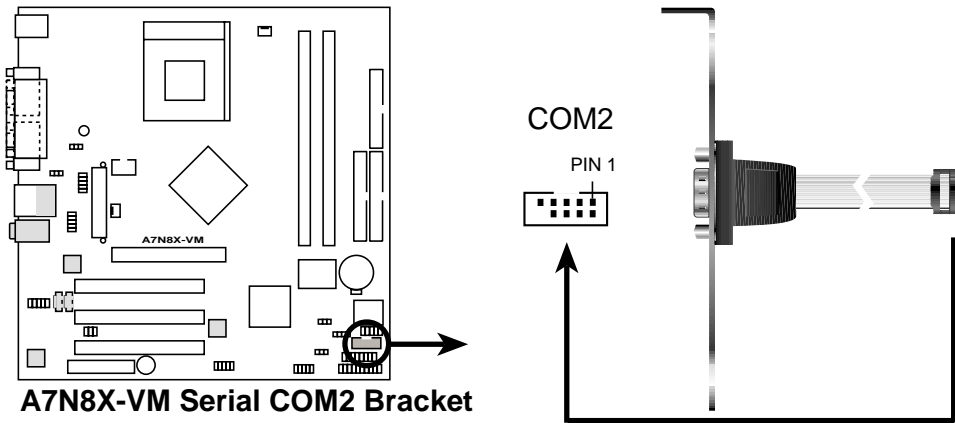

#### 15. Optional IEEE 1394 connectors (10-1 pin IE1394\_1; IE1394\_2)

These connectors are for the bundled 10-to-6-pin 1394 serial connector cables that connect to the 1394 module. Attach the 10-1 pin cable plugs to these connectors, and the 6-pin cable plugs to the 1394 module. You may also connect a 1394-compliant internal hard disk to these connectors.

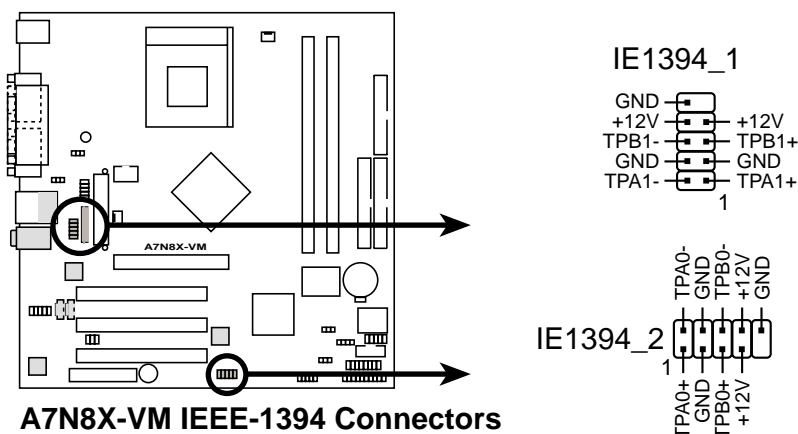

## 16. System panel connector (20-pin PANEL1)

This connector accommodates several system front panel functions.

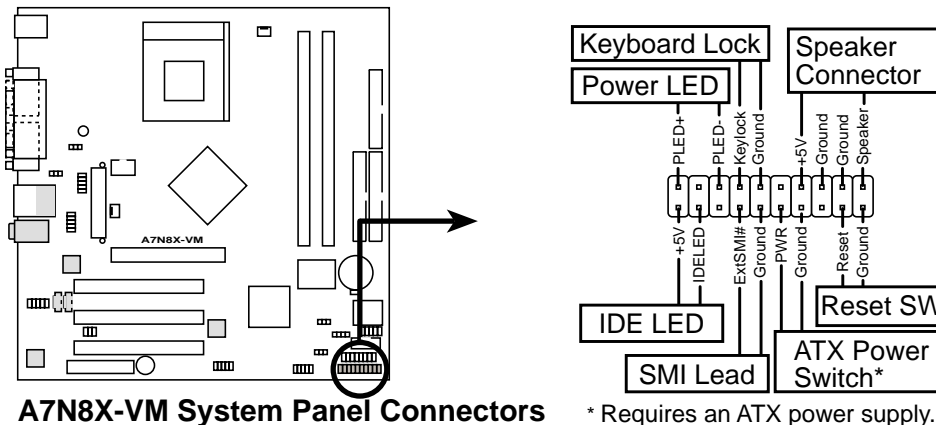

- **System Power LED Lead (3-1 pin PLED)**

This 3-1 pin connector connects to the system power LED. The LED lights up when you turn on the system power.

- **Keyboard Lock Lead (2-1 pin KEYLOCK)**

This 2-1 pin connector connects to the case-mounted switch to allow the use of the keyboard lock feature.

- **System Warning Speaker Lead (4-pin SPEAKER)**

This 4-pin connector connects to the case-mounted speaker and allows you to hear system beeps and warnings.

- **System Management Interrupt Lead (2-pin SMI)**

This 2-pin connector permits switching to suspend mode, or “Green” mode, in which system activity is instantly decreased to save power and to expand the life of certain system components.

- **Reset Switch (2-pin RESET)**

This 2-pin connector connects to the case-mounted reset switch for rebooting the system without turning off the power switch.

- **ATX Power Switch / Soft-Off Switch Lead (2-pin PWR)**

This connector connects a switch that controls the system power. Pressing the power switch turns the system between ON and SLEEP, or ON and SOFT OFF, depending on the BIOS or OS settings. Pressing the power switch while in the ON mode for more than 4 seconds turns the system OFF.

- **Hard Disk Activity Lead (2-pin IDE LED)**

This connector supplies power to the hard disk activity LED. The read or write activities of any device connected to the primary or secondary IDE connector cause this LED to light up.



# ***Chapter 2***

This chapter tells how to change system settings through the BIOS Setup Menus. Detailed descriptions of the BIOS parameters are also provided.

## **BIOS information**

## 2.1 Managing and Updating your BIOS



It is recommended that you save a copy of the motherboard's **original BIOS** to a bootable floppy disk in case you need to reinstall the original BIOS later.



The BIOS information in the above screen is for reference only. What you see on your screen may not be exactly the same as shown.

### 2.1.1 Using AFUDOS to update the BIOS

#### Updating the BIOS



Update the BIOS only if you are sure that the new BIOS revision will solve your problems. Careless updating may result to more problems with the motherboard!

1. Download an updated ASUS BIOS file from the Internet (WWW or FTP) (see ASUS CONTACT INFORMATION on page x for details) and save to the boot floppy disk you created earlier.
2. Boot from the floppy disk.
3. At the "A:\>" prompt, type **AFUDOS /i<ROM filename>** and then press <Enter>.
4. The utility starts to program the new BIOS information into the Flash ROM. Several tasks are performed and when the programming is done, the message "Done" appears at the end of each task.

```
C:\AFUDOS>afudos /ia7n8x000.rom
AMI Firmware Update Utility - Version 1.10
Copyright (C)2002 American Megatrends, Inc. All rights reserved.

Reading file.....done
Erasing flash.....done
Writing flash.....0x0008CC00 (9%)
```

5. After all tasks are performed, AFUDOS utility automatically exits to DOS.

```
C:\AFUDOS>afudos /ia7n8x000.rom
AMI Firmware Update Utility - Version 1.10
Copyright (C)2002 American Megatrends, Inc. All rights reserved.

Reading file.....done
Erasing flash.....done
Writing flash.....done
Verifying flash....done
```



DO NOT turn off the system while updating the BIOS. This may cause boot problems. Just repeat the process, and if the problem persists, load the original BIOS file you saved to the boot disk. If the Flash Memory Writer utility is not able to successfully update a complete BIOS file, call the ASUS service center for support.

## 2.2 BIOS Setup program

Use the BIOS Setup program when you are installing a motherboard, reconfiguring your system, or prompted to “Run Setup”. This section explains how to configure your system using this utility.

Even if you are not prompted to use the Setup program, you may want to change the configuration of your computer in the future. For example, you may want to enable the security password feature or make changes to the power management settings. This requires you to reconfigure your system using the BIOS Setup program so that the computer can recognize these changes and record them in the CMOS RAM of the EEPROM.

The EEPROM on the motherboard stores the Setup utility. When you start up the computer, the system provides you with the opportunity to run this program. Press <Delete> during the Power-On Self Test (POST) to enter the Setup utility, otherwise, POST continues with its test routines.

The Setup program is designed to make it as easy to use as possible. It is a menu-driven program, which means you can scroll through the various sub-menus and make your selections among the predetermined choices.



---

Because the BIOS software is constantly being updated, the following BIOS setup screens and descriptions are for reference purposes only, and may not exactly match what you see on your screen.

---

### 2.2.1 BIOS menu bar

The top of the screen has a menu bar with the following selections:

- |                 |  |
|-----------------|--|
| <b>MAIN</b>     | Use this menu to make changes to the basic system configuration.                                   |
| <b>ADVANCED</b> | Use this menu to enable and make changes to the advanced features.                                 |
| <b>POWER</b>    | Use this menu to configure and enable Power Management features.                                   |
| <b>BOOT</b>     | Use this menu to configure the default system device used to locate and load the Operating System. |
| <b>EXIT</b>     | Use this menu to exit the current menu or to exit the Setup program.                               |

To access the menu bar items, press the right or left arrow key on the keyboard until the desired item is highlighted.

## 2.2.2 Legend bar

At the bottom of the Setup screen is a legend bar. The keys in the legend bar allow you to navigate through the various setup menus. The following table lists the keys found in the legend bar with their corresponding functions.

<b>Navigation Key(s)</b>	<b>Function Description</b>
<b>&lt;F1&gt; or &lt;Alt + H&gt;</b>	Displays the General Help screen from anywhere in the BIOS Setup
<b>&lt;Esc&gt;</b>	Jumps to the Exit menu or returns to the main menu from a sub-menu
<b>Left or Right arrow</b>	Selects the menu item to the left or right
<b>Up or Down arrow</b>	Moves the highlight up or down between fields
<b>- (minus key)</b>	Scrolls backward through the values for the highlighted field
<b>+ (plus key) or spacebar</b>	Scrolls forward through the values for the highlighted field
<b>&lt;Enter&gt;</b>	Brings up a selection menu for the highlighted field
<b>&lt;Home&gt; or &lt;PgUp&gt;</b>	Moves the cursor to the first field
<b>&lt;End&gt; or &lt;PgDn&gt;</b>	Moves the cursor to the last field
<b>&lt;F5&gt;</b>	Resets the current screen to its Setup Defaults
<b>&lt;F10&gt;</b>	Saves changes and exits Setup

### General help

In addition to the Item Specific Help window, the BIOS setup program also provides a General Help screen. You may launch this screen from any menu by simply pressing <F1> or the <Alt> + <H> combination. The General Help screen lists the legend keys and their corresponding functions.

### Saving changes and exiting the Setup program

See “2.7 Exit Menu” for detailed information on saving changes and exiting the setup program.

When a scroll bar appears to the right of a help window, it indicates that there is more information to be displayed that will not fit in the window. Use <PgUp> and <PgDn> or the up and down arrow keys to scroll through the entire help document. Press <Home> to display the first page, press <End> to go to the last page. To exit the help window, press <Enter> or <Esc>.

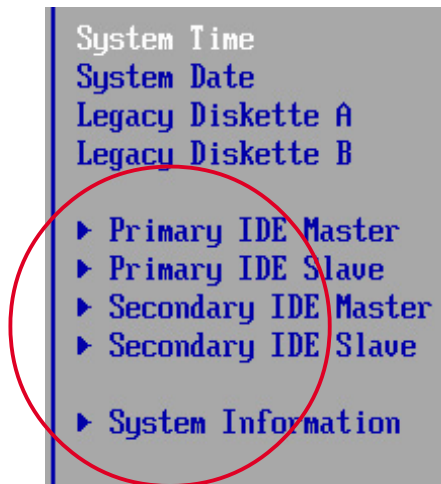

## Sub-menu

Note that a right pointer symbol (as shown on the left) appears to the left of certain fields. This pointer indicates that you can display a sub-menu from this field. A sub-menu contains additional options for a field parameter. To display a sub-menu, move the highlight to the field and press <Enter>. The sub-menu appears. Use the legend keys to enter values and move from field to field within a sub-menu as you would within a menu. Use the <Esc> key to return to the main menu. Take some time to familiarize yourself with the legend keys and their

corresponding functions. Practice navigating through the various menus and sub-menus. If you accidentally make unwanted changes to any of the fields, use the set default hot key <F5> to load the Setup default values. While moving around through the Setup program, note that explanations appear in the Item Specific Help window located to the right of each menu. This window displays the help text for the currently highlighted field.

## 2.3 Main Menu

When you enter the Setup program, the following screen appears.

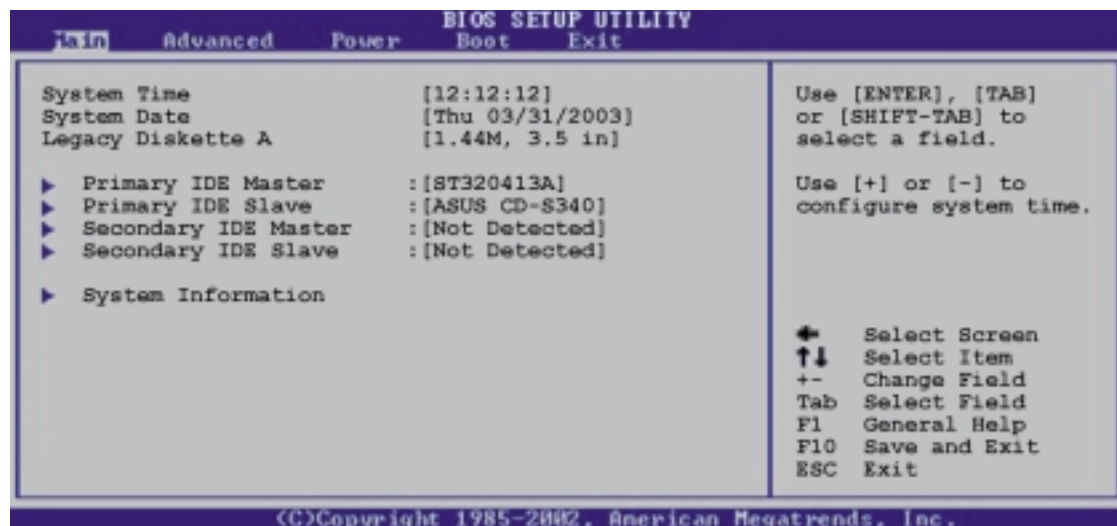

### System Time [XX:XX:XX]

Sets the system to the time that you specify (usually the current time). The format is hour, minute, second. Valid values for hour, minute and second are Hour: (00 to 23), Minute: (00 to 59), Second: (00 to 59). Use the <Tab> or <Shift> + <Tab> keys to move between the hour, minute, and second fields.

## System Date [XX/XX/XXXX]

Sets the system to the date that you specify (usually the current date). The format is month, day, year. Valid values for month, day, and year are Month: (1 to 12), Day: (1 to 31), Year: (up to 2099). Use the <Tab> or <Shift> + <Tab> keys to move between the month, day, and year fields.

## Legacy Diskette A [1.44M, 3.5 in.]

Sets the type of floppy drive installed. Configuration options: [Disabled] [360K, 5.25 in.] [1.2M , 5.25 in.] [720K , 3.5 in.] [1.44M, 3.5 in.] [2.88M, 3.5 in.]

## 2.3.1 Primary and Secondary IDE Master/Slave

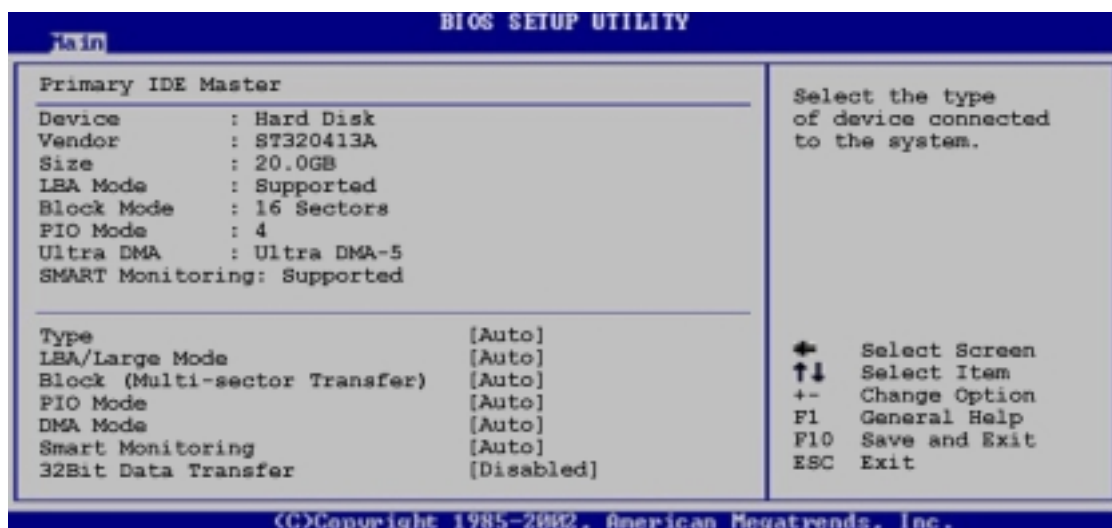

### Type [Auto]

Select [Auto] to automatically detect an IDE hard disk drive. If automatic detection is successful, Setup automatically fills in the correct values for the remaining fields on this sub-menu. Configuration options: [Not Installed] [Auto] [CDROM] [ARMD]



Before attempting to configure a hard disk drive, make sure you have the correct configuration information supplied by the drive manufacturer.

### LBA/Large Mode [Auto]

This field configures the LBA mode. Select [Auto] to enable LBA mode if the device supports it and the device is not already formatted with LBA Mode disabled. [Disabled] disables the LBA mode.

## Block (Multi-Sector Transfer) [Auto]

This field configures the Multi-Sector Transfer Block. Select [Auto] to enable the data to transfer from and to the device occurs multiple sectors at a time if the device supports it. When [Disabled], the data transfer from and to the device occurs one sector at a time.

## PIO Mode [Auto]

This option lets you set a PIO (Programmed Input/Output) mode for the IDE device. Modes 0 through 4 provide successive increase in performance.

Configuration options: [0] [1] [2] [3] [4]

## Ultra DMA Mode [Auto]

This field enables you to select the DMA mode. Configuration options: [Auto] [SWDMA0] [SWDMA1] [SWDMA2] [MWDMA0] [MWDMA1] [MWDMA2] [UDMA0] [UDMA1] [UDMA2] [UDMA3] [UDMA4]

## SMART Monitoring [Auto]

This field allows you to enable or disable the S.M.A.R.T. (Self-Monitoring, Analysis and Reporting Technology) system that utilizes internal hard disk drive monitoring technology. This parameter is normally disabled because the resources used in the SMART monitoring feature may decrease system performance. Configuration options: [Disabled] [Enabled] [Auto]

## 32-bit DataTransfer Mode [Disabled]

This field enables you enable or disable 32-bit data transfer mode. Configuration option: [Disabled] [Enabled]

## 2.3.2 System Information

This option displays detailed information about the BIOS, processor and system memory. The values for these fields are automatically detected. Refer to the screen capture below for details.



## 2.4 Advanced Menu



### 2.4.1 Chipset

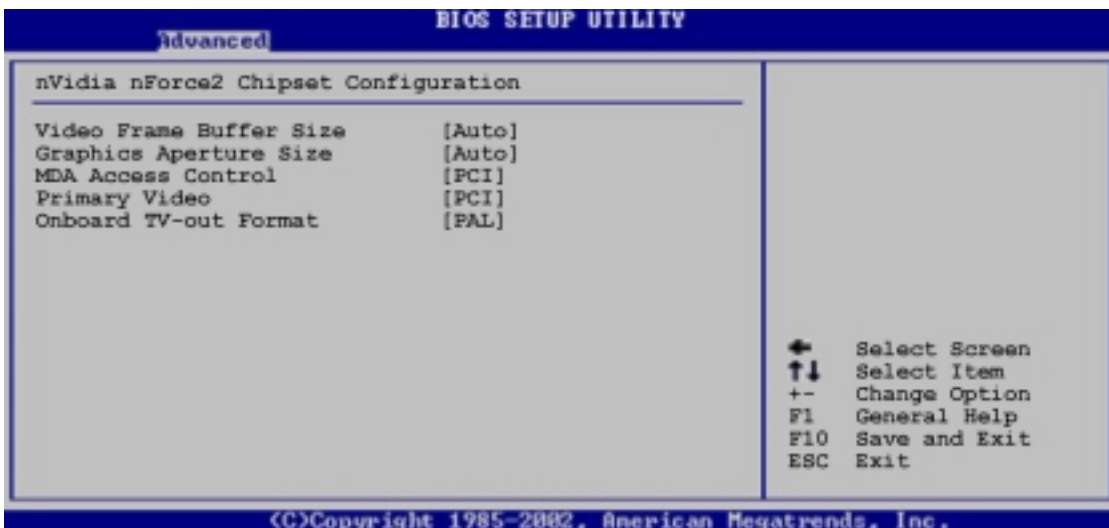

#### Video Frame Buffer Size [Auto]

This field sets the size of the video frame buffer. The settings on this field is valid only for motherboard models with onboard VGA controller.

Configuration options: [Auto] [8MB] [16MB] [32MB] [64MB] [128MB]

#### Graphics Aperture Size [Auto]

This feature allows you to select the size of mapped memory for AGP graphic data.

Configuration options: [32MB] [64MB] [128MB] [256MB] [512MB] [Disabled]



The [512MB] configuration option is available only when you use AGP 8X graphics card.



## MDA Access Control [PCI]

This field selects the MDA Access cycles direction. Configuration options: [AGP] [PCI]

## Primary Video [PCI]

This will switch the PCI Bus scanning order while searching for a video card. This allows the user to select the type of Primary VGA in case of multiple video controllers. Configuration options: [PCI] [AGP/Onboard]

## Onboard TV-out format [PAL]

This field sets the onboard TV-out format. Configuration options: [PAL] [NTSC]

## 2.4.2 Onboard Devices Configuration

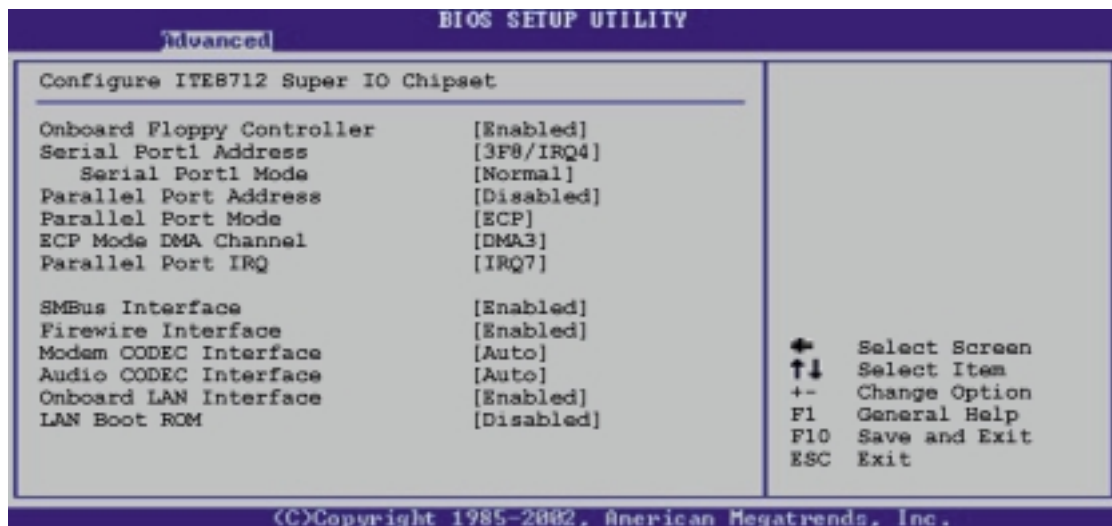

### Onboard Floppy Controller [Enabled]

This field allows you to enable or disable the onboard floppy controller. Configuration options: [Enabled] [Disabled]

### Serial Port1 Address [3F8/IRQ4]

This field allows you to set the address for the onboard serial connector. Configuration options: [3F8/IRQ4] [2F8/IRQ3] [3E8/IRQ4] [2E8/IRQ3]

### Serial Port1 Mode [Normal]

This field allows you to set the serial port mode. Configuration options: [Normal] [IrDA] [ASK IR]

### Parallel Port Address [Disabled]

This field allows the BIOS to select the Parallel Port Base Address. Configuration options: [Disabled] [378] [278] [3BC]

### **Parallel Port Mode [Disabled]**

This field allows the BIOS to select the Parallel Port Mode. Configuration options: [Normal] [EPP] [ECP] [EPP+ECP]

### **ECP Mode [DMA3]**

This field allows the BIOS to select the Parallel Port ECP DMA. Configuration options: [DMA0] [DMA1] [DMA3]

### **Parallel Port IRQ [IRQ7]**

This field allows the BIOS to select the Parallel Port IRQ. Configuration options: [IRQ5] [IRQ7]

### **SMBUS Interface [Enabled]**

This field allows you to enable or disable the SMBus interface. Configuration options: [Disabled] [Enabled]

### **Firewire Interface [Enabled]**

This field allows you to enable or disable the Firewire interface. Configuration options: [Disabled] [Enabled]

### **Modem CODEC Interface [Auto]**

This field allows you to disable or set to automatic the modem CODEC interface. Configuration options: [Disabled] [Auto]

### **Audio CODEC Interface [Auto]**

This field allows you to disable or set to automatic the AUDIO CODEC interface. Configuration options: [Disabled] [Auto]

### **Onboard LAN [Enabled]**

This field allows you to disable or set to automatic the onboard LAN interface. Configuration options: [Enabled] [Disabled]

### **LAN Boot ROM [Disabled]**

This field allows you to disable or set to automatic the onboard boot ROM interface. Configuration options: [Disabled] [Auto]

## 2.4.3 PCIPnP



### Plug and Play O/S [No]

This field configures the Plug and Play O/S feature. If set to [No] the BIOS configures all the devices attached to the system. If set to [Yes], the operating system configures Plug and Play (PnP) devices not required for boot if the system has a Plug and Play operating system feature. Configuration options: [No] [Yes]

### PCI Latency Timer [64]

Leave this field to the default setting [32] for best performance and stability. Configuration options: [32] [64] [96] [128] [160] [192] [224] [248]

### Allocate IRQ to PCI VGA [Yes]

Select [Yes] to automatically assign IRQ to PCI VGA card if card requests IRQ. If set to [No], no IRQ is assigned even the card requests an IRQ.

### Palette Snooping [Disabled]

This field enables or disables the Palette Snooping feature. Set to [Enabled] and the PCI devices will detect that an ISA graphics device is installed in the system so the device will function correctly. Configuration options: [Disabled] [Enabled]

## PCI IDE BusMaster [Disabled]

This field allows the BIOS, when [Enabled], to use PCI busmastering for reading and writing to IDE drives. Configuration options: [Disabled] [Enabled]

## Offboard PCI/ISA IDE Card [Auto]

This field allows the setting of the proper slot of installed PCI IDE cards. Some PCI IDE cards require this to be set to the PCI slot number that is holding the card. Configuration options: [Auto] [PCI Slot1] [PCI Slot2] [PCI Slot3] [PCI Slot4] [PCI Slot5] [PCI Slot6]

## IRQ3, IRQ4, IRQ5, IRQ7, IRQ9, IRQ10, IRQ11, IRQ14, IRQ15 [Available]

This field specifies if the IRQ is reserved or available for use by Legacy ISA devices. Configuration options: [Available] [Reserved]

## DMA Channel 0, 1, 3, 5, 6, 7 [Available]

This field specifies if the DMA Channel is reserved or available for use by Legacy ISA devices. Configuration options: [Available] [Reserved]

## Reserved Memory Size [Disabled]

This field specifies the reserved memory block for use of legacy ISA devices. Configuration options: [Disabled] [16k] [32k] [64k]

## 2.5 Power Menu

The Power menu allows you to reduce power consumption. This feature turns off the video display and shuts down the hard disk after a period of inactivity.

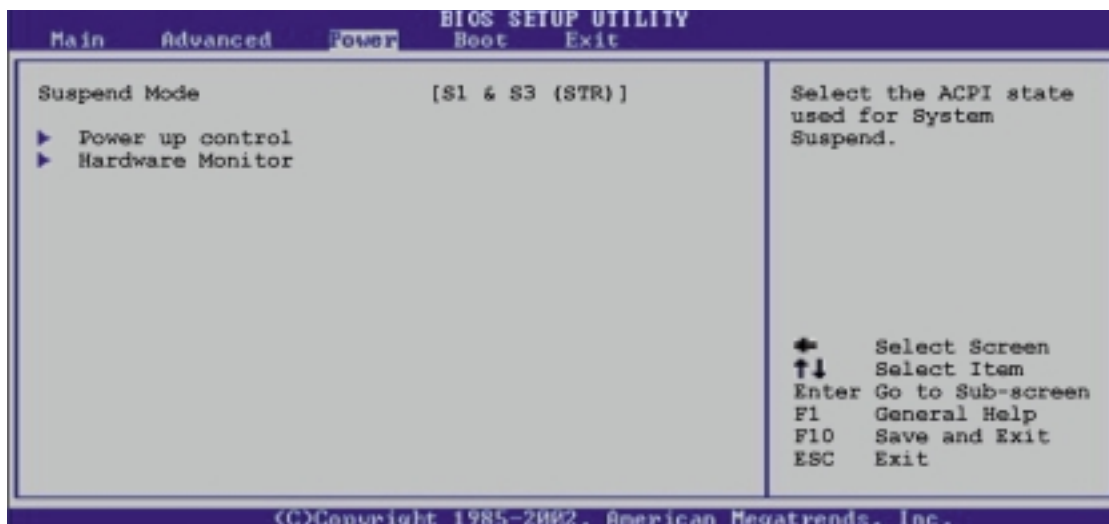

### Suspend Mode [S1 & S3 (STR)]

This field allows the BIOS to select the ACPI state used for System Suspend. Configuration options: [S1 & S3 (STR)] [S1 (POS) only]

## 2.5.1 Power Up Control

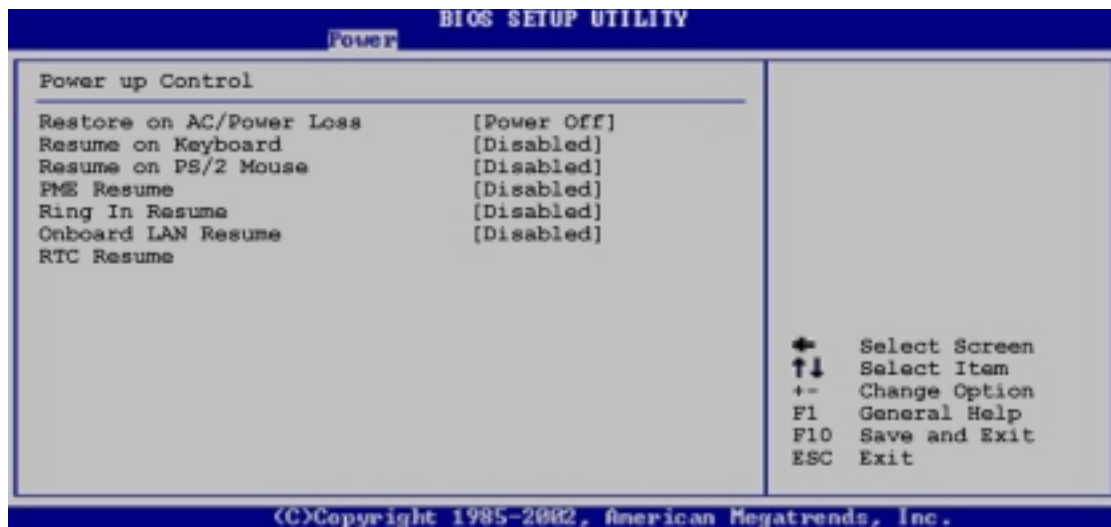

### Restore on AC Power Loss [Power Off]

When set to Power Off, the system goes into off state after an AC power loss. When set to Power On, the system goes on after an AC power loss. When set to Last State, the system goes into either off or on state whatever was the system state before the AC power loss. Configuration options: [Power Off] [Power On] [Last State]

### Resume on Keyboard [Disabled]

This parameter allows you to use the keyboard keys to turn on the system. This feature requires an ATX power supply that provides at least 1A on the +5VSB lead. Configuration options: [Disabled] [Enabled]

### Resume on PS/2 Mouse [Disabled]

This parameter allows you to use the PS/2 mouse to turn on the system. This feature requires an ATX power supply that provides at least 1A on the +5VSB lead. Configuration options: [Disabled] [Enabled]

### PME Resume [Disabled]

This parameter enables or disables PME to generate a wake event. This feature requires an ATX power supply that provides at least 1A on the +5VSB lead. Configuration options: [Disabled] [Enabled]

### Ring In Resume [Disabled]

This parameter enables or disables RI to generate a wake event. This feature requires an ATX power supply that provides at least 1A on the +5VSB lead. Configuration options: [Disabled] [Enabled]

## Onboard LAN Resume [Disabled]

This parameter enables or disables the onboard LAN to generate a wake event. This feature requires an ATX power supply that provides at least 1A on the +5VSB lead. Configuration options: [Disabled] [Enabled]

## RTC Resume [Disabled]

This parameter enables or disables RTC to generate a wake event. This feature requires an ATX power supply that provides at least 1A on the +5VSB lead. Configuration options: [Disabled] [Enabled]

## 2.5.2 Hardware Monitor

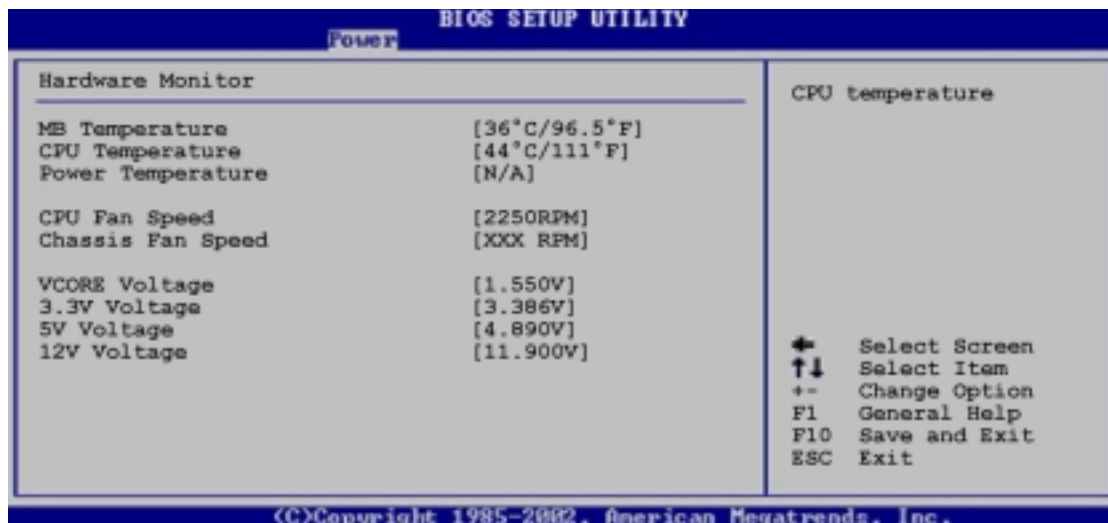

### MB Temperature [xxxC/xxxF]

### CPU Temperature [xxxC/xxxF]

### Power Temperature [xxxC/xxxF]

The onboard hardware monitor automatically detects and displays the motherboard, CPU, and power temperatures

### CPU Fan Speed [xxxxRPM] or [Disabled]

### Chassis Fan Speed [xxxxRPM] or [Disabled]

The onboard hardware monitor automatically detects and displays the CPU, chassis, and power fan speeds in rotations per minute (RPM). If any of the fans is not connected to the motherboard, that field shows 0RPM.

### VCORE Voltage, 3.3V Voltage, 5V Voltage, 12V Voltage

The onboard hardware monitor automatically detects the voltage output through the onboard voltage regulators.

## 2.6 Boot Menu



### 1st, 2nd, 3rd Boot Device

This field specifies the boot sequence from the available devices. Additional plug-in boot devices installed appear in sequence after the list of current boot devices. Configuration fields include FLOPPY DRIVE, IDE Hard Drive, ATAPI CD-ROM, and Other Boot Device.

### 2.6.1 Boot Settings Configuration



#### Quick Boot [Enabled]

This field allows BIOS to skip certain tests while booting. This will decrease the time needed to boot the system. Configuration options: [Disabled] [Enabled]

#### Quiet Boot [Disabled]

When [Enabled], the normal POST messages are displayed and displays only OEM Logo instead of POST messages. Configuration options: [Disabled] [Enabled]

### **AddOn ROM Display Mode [Force BIOS]**

This field sets the display mode for option ROM. Configuration options: [Force BIOS] [Keep Current]

### **Bootup Num-Lock [On]**

This field selects the power-on state for the NumLock key. Configuration options: [Off] [On]

### **PS/2 Mouse Support [Enabled]**

This sets the PS/2 mouse support. Configuration options: [Disabled] [Enabled]

### **Typematic Rate [Fast]**

This field configures the typematic rate of the keyboard. Configuration options: [Slow] [Fast]

### **System Keyboard [Present]**

This allows you to enable or disable all the keyboards attached to the system. Configuration options: [Absent] [Present]

### **Parity Check [Disabled]**

This field enables or disables the memory or parity error checking feature. Configuration options: [Disabled] [Enabled]

### **Boot to OS/2 [No]**

This field sets compatibility mode to OS/2 operating system. Configuration options: [No] [Yes]

### **Wait for 'F1' If Error [Enabled]**

This field sets whether to wait for F1 key to be pressed if an error occurs. Configuration options: [Disabled] [Enabled]

### **Hit 'Del' Message Display [Disabled]**

This field toggles the display of "Press DEL to run Setup". Configuration options: [Disabled] [Enabled]

### **Interrupt 19 Capture [Disabled]**

When [Enabled], it allows option ROMs to trap interrupt 19. This is required by some PCI cards that provide a ROM based setup utility. Configuration options: [Disabled] [Enabled]



## 2.6.2 Security

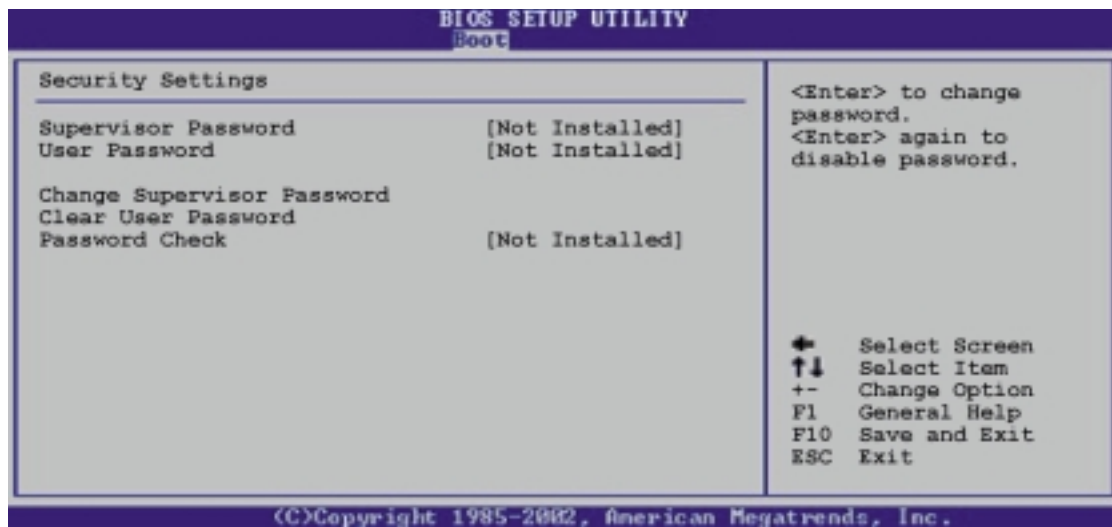

### Change Supervisor Password / User Password

These fields allow you to set passwords. To set a password, highlight the appropriate field and press <Enter>. A pop-up window will appear; Type in a password then press <Enter>. You can type up to eight alphanumeric characters. Symbols and other characters are ignored. To confirm the password, type the password again and press <Enter>. The password is now set. This password allows full access to the BIOS Setup menus. To clear the password, highlight this field and press <Enter>. The same dialog box as above appears. Press <Enter>. The password is cleared.



Make a copy of the original BIOS on a bootable floppy disk before setting passwords. You will need to upload the BIOS file in case you erase the CMOS RAM in the future.

#### A note about passwords

The BIOS Setup program allows you to specify passwords in the Boot menu. The passwords control access to the BIOS during system startup. Passwords are not case sensitive, meaning, passwords typed in either uppercase or lowercase letters are accepted. The BIOS Setup program allows you to specify two different passwords: a Supervisor password and a User password. If you did not set a Supervisor password, anyone can access the BIOS Setup program. If you did, the Supervisor password is required to enter the BIOS Setup program and to gain full access to the configuration fields.

#### Forgot the password?

If you forget your password, you can clear it by erasing the CMOS Real Time Clock (RTC) RAM. The RAM data containing the password information is powered by the onboard button cell battery. If you need to erase the CMOS RAM, unplug the all the power cables and remove the button cell battery. Re-install the battery after about 2 seconds, then power up the system. Refer to section "Managing and updating your BIOS" on how to update the BIOS.

## 2.7 Exit Menu

When you have made all of your selections from the various menus in the Setup program, save your changes and exit Setup. Select Exit from the menu bar to display the following menu.



Pressing <Esc> does not immediately exit this menu. Select one of the options from this menu or <F10> from the legend bar to exit.

### Exit & Save Changes

Once you are finished making your selections, choose this option from the Exit menu to ensure the values you selected are saved to the CMOS RAM. The CMOS RAM is sustained by an onboard backup battery and stays on even when the PC is turned off. When you select this option, a confirmation window appears. Select [Yes] to save changes and exit.



If you attempt to exit the Setup program without saving your changes, the program prompts you with a message asking if you want to save your changes before exiting. Pressing <Enter> saves the changes while exiting.

### Exit and Discard Changes

Select this option only if you do not want to save the changes that you made to the Setup program. If you made changes to fields other than system date, system time, and password, the BIOS asks for a confirmation before exiting.

## **Discard Changes**

This option allows you to discard the selections you made and restore the previously saved values. After selecting this option, a confirmation appears. Select [Yes] to discard any changes and load the previously saved values.

## **Load Setup Defaults**

This option allows you to load the default values for each of the parameters on the Setup menus. When you select this option or if you press <F5>, a confirmation window appears. Select [Yes] to load default values. Select Exit Saving Changes or make other changes before saving the values to the non-volatile RAM.



# ***Chapter 3***

This chapter describes the contents of the support CD that comes with the motherboard package.

## **Software support**

## 3.1 Installing an operating system

This motherboard supports Windows 98SE/ME/NT/2000/XP as well as Linux Red Hat, SuSE, TurboLinux and Caldera operating systems (OS). Always install the latest OS version and corresponding updates so you can maximize the features of your hardware.



Because motherboard settings and hardware options vary, use the setup procedures presented in this chapter for general reference only. Refer to your OS documentation for more information.

## 3.2 Support CD information

The support CD that came with the motherboard contains useful software and several utility drivers that enhance the motherboard features.



The contents of the support CD are subject to change at any time without notice. Visit the ASUS website for updates.

### 3.2.1 Running the support CD

To begin using the support CD, simply insert the CD into your CD-ROM drive. The CD automatically displays the **Drivers** menu if Autorun is enabled in your computer.

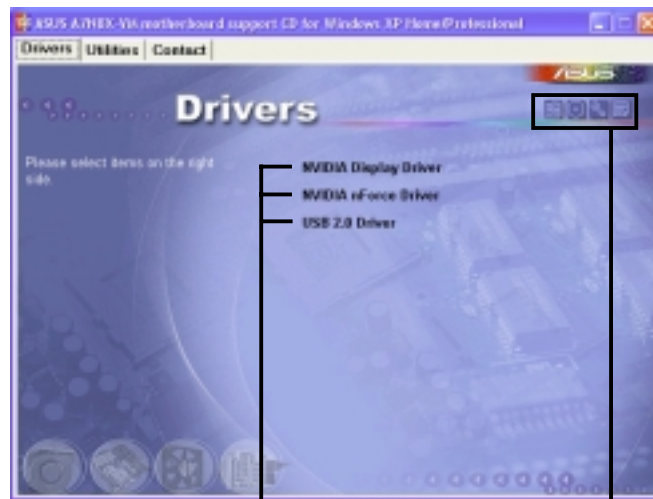

Click an item to install

Click an icon to display more information



If **Autorun** is NOT enabled in your computer, browse the contents of the support CD to locate the file **ASSETUP.EXE** from the **BIN** folder. Double-click the **ASSETUP.EXE** to run the CD.

## 3.2.2 Drivers menu

The drivers menu shows the available device drivers if the system detects installed devices. Install the necessary drivers to activate the devices.



Screen display and driver options may not be the same for other operating system versions.

## 3.2.3 Utilities menu

The Utilities menu shows the applications and other software that the motherboard supports.



### ASUS PC Probe

This convenient utility continuously monitors your computer systems vital components such as fan rotations, CPU temperature, and system voltages, and alerts you on any detected problems. This utility helps you keep your computer at a healthy operating condition.

### Using ASUS PC Probe

#### Monitoring

#### Monitor Summary

Shows a summary of the items being monitored.



### Temperature Monitor

Shows the PC temperature (for supported processors only).

Temperature Warning threshold adjustment  
(Move the slider up to increase the threshold level or down to decrease the threshold level)



### Fan Monitor

Shows the PC fan rotation.

Fan Warning threshold adjustment  
(Move the slider up to increase the threshold level or down to decrease the threshold level)



### Voltage Monitor

Shows the PC voltages.

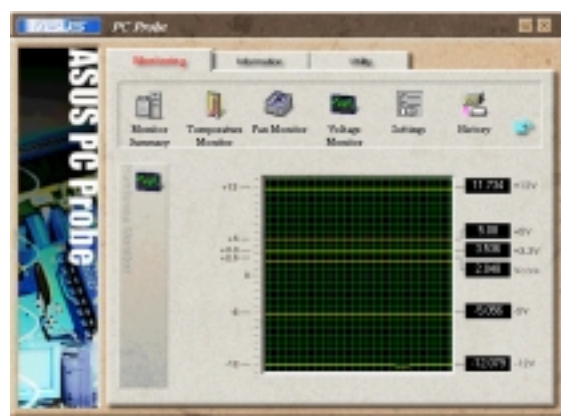

### Settings

Lets you set threshold levels and polling intervals or refresh times of the PC's temperature, fan rotation, and voltages.



**CPU Cooling System Setup**  
Lets you select when to enable software CPU cooling. When **When CPU Overheated** is selected, the CPU cooling system is enabled whenever the CPU temperature reaches the threshold value.

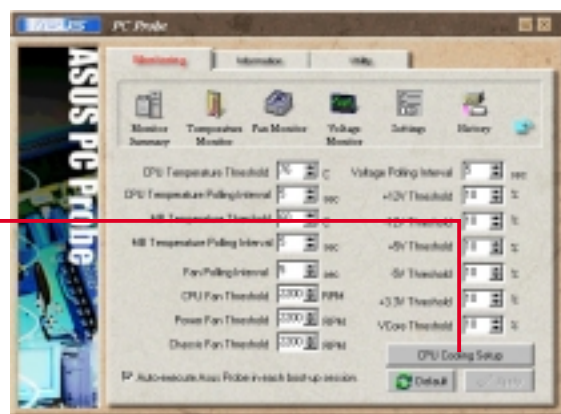



## History

Lets you record the monitoring activity of a certain component of your PC for future reference.

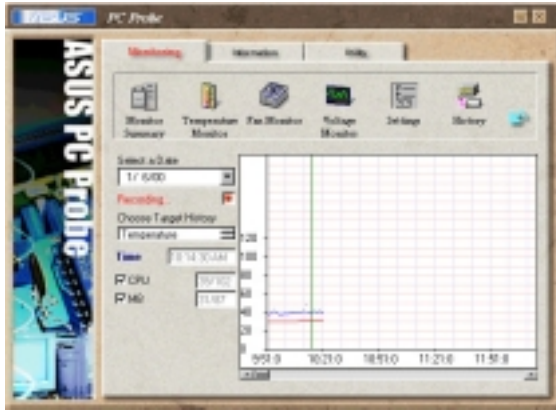

## Fan Control

Lets you enable/disable Smart Fan Control. Smart Fan Control adjusts the fan speed automatically based on the current CPU temperature and predefined threshold.



## Hard Drives

Shows the used and free space of the PC's hard disk drives and the file allocation table or file system used.



## Information

### Memory

Shows the PC memory load, memory usage, and paging file usage.



## Device Summary

Shows a summary of devices present in your PC.



## DMI Explorer

Shows information pertinent to the PC, such as CPU type, CPU speed, and internal/external frequencies, and memory size.



## Utility

Lets you run programs outside of the ASUS Probe modules. To run a program, click **Execute Program**.

**NOTE:** This feature is currently unavailable.



## ASUS PC Probe Task Bar Icon

Right clicking the PC Probe icon brings up a menu to open or exit ASUS PC Probe and pause or resume all system monitoring.



When the ASUS PC Probe senses a problem with your PC, portions of the ASUS PC Probe icon change to red, the PC speaker beeps, and the ASUS PC Probe monitor appears.

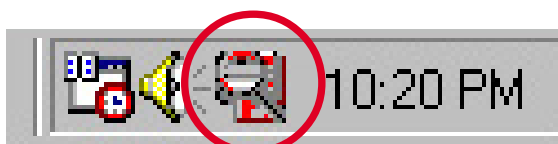

## ASUS Update

The ASUS Update is a utility that allows you to update the motherboard BIOS and drivers. This utility requires an Internet connection either through a network or an Internet Service Provider (ISP).

Follow these steps to use the ASUS Update.

1. Launch the utility from your Windows Start menu:  
**Programs/AsusUpdate Vx.xx.xx/  
AsusUpdate**  
The ASUS Update initial screen appears.



2. Select your desired update method, then click Next.

3. If you selected updating/downloading from the Internet, select the ASUS FTP site nearest you to avoid network traffic, or choose Auto Select. Click Next.



4. From the FTP site, select the BIOS version that you wish to download. Click Next.
5. Follow the instructions on the succeeding screens to complete the update process.

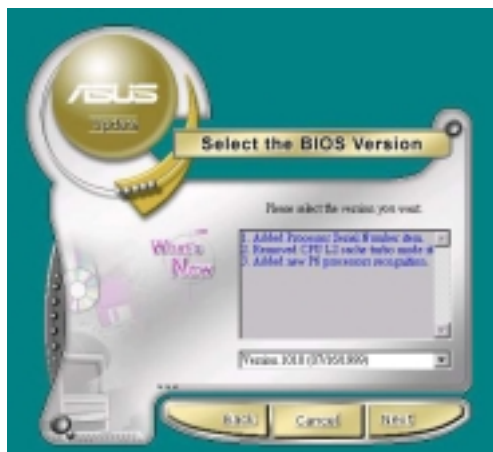

If you selected the option to update the BIOS from a file, a window pops up prompting you to locate the file. Select the file, click Save, then follow the screen instructions to complete the update process.

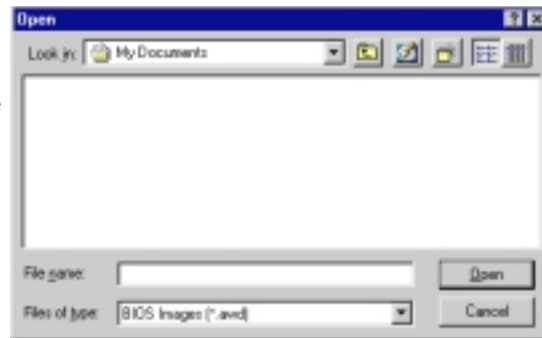

## ASUS MyLogo2™

The ASUS MyLogo2™ is automatically installed when you install the ASUS Update utility from the software menu. See page 3-7 for installation of ASUS Update.



Before using ASUS MyLogo2 feature, use the AFLASH utility to make a copy of your original BIOS file, or obtain the latest BIOS version from the ASUS website.

Follow these steps to use ASUS MyLogo2.

1. Launch the ASUS Update utility. See page 3-7 “ASUS Update”.
2. When prompted for the BIOS update method, select the option “Update BIOS from a file.”
3. Specify the location of the BIOS file, such as from a floppy disk. Click Next.



4. From the selection that appears, choose a logo image. Click Next.



If you wish, you may create your own boot logo image in GIF, JPG, or BMP file formats.





5. When you click on an image, it displays larger on the MyLogo2 screen.



MyLogo2 may not support too complex images. If you encounter any problems on complex images, try using a simpler image. You may also use a photo editing software to shrink the complex image, lay it over a one-color 640x480 pixel background, and save the image with the background. When you use the image, it will appear smaller and centered on the screen.

6. The next screen prompts you to flash the original BIOS to update it with the new boot logo. Click Flash to update the BIOS.
7. When finished, click Exit, then reboot your computer. Your system boots with the new boot logo.



Instead of starting from ASUS Update, you may also launch ASUS MyLogo2 directly from the Windows Start menu to change your BIOS boot logo. After you have modified the BIOS file with the new logo, use the ASUS Update utility to upload the new BIOS.

## **Microsoft Direct X Driver**

This item installs the Microsoft Direct X 8.1 driver.

## **PC-CILLIN 2002**

This item installs the PC-cillin 2002 anti-virus program. View the PC-cillin online help for detailed information.

## **Adobe Acrobat Reader**

This item installs the Adobe Acrobat Reader. The Acrobat Reader software is for viewing files saved in Portable Document Format (PDF).

## **ASUS Screen Saver**

This item installs the ASUS screen saver.

## **E-Color 3Deep**

This item installs the 3Deep software. 3Deep is the first application that gives online gamers the competitive edge in multi-player skirmishes. This application removes dark washed-out graphics to deliver true vibrant colors.



