

Overview

The Octaire Distribution Matrix is a fixed system consisting of a single video or audio enclosure or multiple video enclosures with or without audio in a fixed input/output range. Because the Octaire is available in various fixed sizes, the illustrations in this guide may differ from the model(s) you purchased. The *Octaire Instruction Manual* contains complete documentation for this product (including individual signal specifications); see the *AMX AutoPatch CD* or visit www.amx.com.

General Specifications

Specifications	
Approvals	CE, UL, cUL
AC Power	100 to 240 VAC single phase (50 to 60 Hz) 3.3 A @ 115 VAC max.; 1.6 A @ 230 VAC max.
Power Consumption (max.)	260 Watts per enclosure
Power Consumption (typical)	120 Watts per enclosure, fully loaded
Thermal Dissipation (max.)	887 BTU/hr.
Thermal Dissipation (typical)	409 BTU/hr., fully loaded enclosure
Operational Temperature	32° to 113° F (0° to 45° C)
Humidity	0 to 90% non-condensing
Enclosure Dimensions	12 in. (30.5 cm) depth 18.9 in. (48 cm) width with mounting ears 17.4 in. (44.2 cm) width without mounting ears 6.95 in. (17.65 cm) height, 4 RU
Weight	Approximately 20 lbs. (9.07 kg) per loaded enclosure Approximately 24 lbs. (10.89 kg) packaged for shipping

Installation

ESD Warning: Avoid ESD (Electrostatic Discharge) damage to sensitive components; be sure you and the enclosure(s) are properly grounded before touching any internal materials.

Rack Mounting – standard EIA 19 in. (48.26 cm) rack

To rack mount an Octaire enclosure:

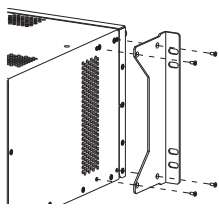

FIG. 1 Attach rack ears

1. Attach rack ears (4 screws each); see FIG. 1.
2. Place the Octaire in the rack, leaving a minimum of one empty rack unit above and below (required); three empty rack units are recommended.
3. Secure enclosure to rack with screws.

Tip: When placing in the rack, keep in mind the optimal viewing angle for a control panel is eye level.

Linking Multiple Enclosures (if applicable)

For multi-enclosure systems, use the link cables provided. Link from the bottom Link port (RJ-45) on one enclosure to the top Link port on next enclosure in a daisy chain. Check the signal type label on the rear of each enclosure (see the Note on FIG. 3).

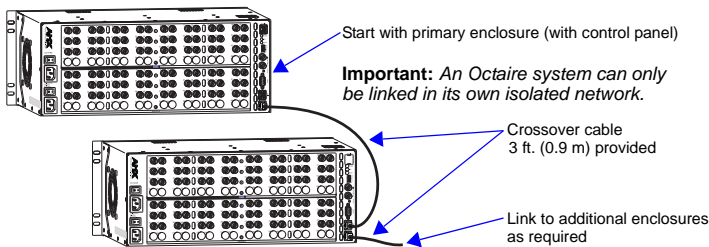

FIG. 2 Use Link ports to link enclosures with cable provided

Attaching Input & Output Cables/Wires

For testing, attach the input and output connectors for the first source and the first destination. Each system comes with a **Connector Guide** and “Signal Color-Band” kit. Multiple BNC connectors are required for all video signals except composite (FIG. 3).

Video Connectors – BNC

All video connectors are BNC. Octaire systems with video contain one or more of the following types of video enclosures:

- 1 or 2 standard video enclosures – support composite or Y/c signals.
- 3 ultra-wideband enclosures – support three-component or the R, G, and B components of an RGBHV signal.
- 2 digital sync enclosures – support the H/V sync part of an RGBHV signal.

Note: A label above the power receptacles on video enclosures indicates the signal type: STD = standard video, UWB = ultra-wideband video, and SYNC = HV sync.

Y/c signals, 3-component signals (Y/Pb/Pr or RGB), and RGBHV signals require a BNC connection on each video enclosure. The example in FIG. 3 shows three BNC cable connectors attached to corresponding connectors on three enclosures for routing a 3-component signal through Input 1. The first enclosure has a control panel.

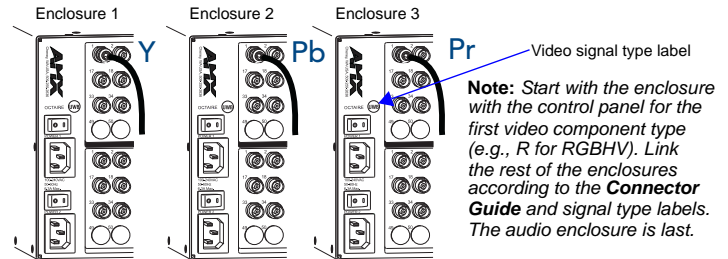

FIG. 3 Multiple BNC connectors are required for all video signals except composite

Stereo Audio Connectors – 5-Term

Stereo audio connections use 5-position terminal blocks; they can be wired for balanced (differential) audio or unbalanced (single-ended) audio (FIG. 4).

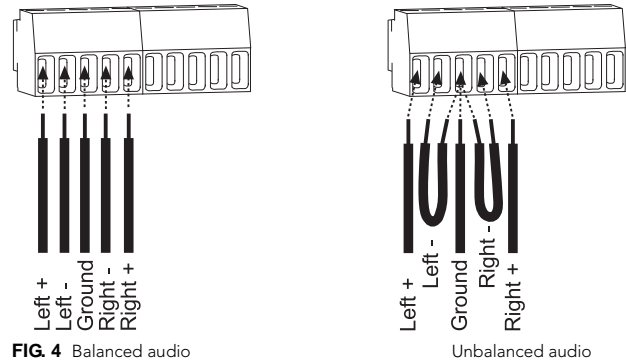

FIG. 4 Balanced audio

Unbalanced audio

Note: When using a shielded twisted-pair cable, connect the shield (ground) at one end only (recommend receiving end) to minimize low frequency noise (FIG. 5).

Source and destination devices will require either balanced (differential) or unbalanced (single-ended) connections. More than one of the options shown in FIG. 5 can be used in the same system.

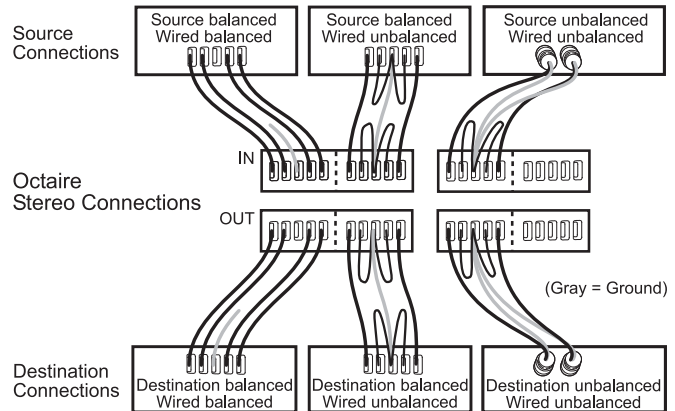

FIG. 5 Options for source-to-Octaire-to-destination 5-Term wiring

Applying Power & Control Startup

Important: We recommend attaching all power cords to one or two surge protectors (top outlets together and bottom ones together) and/or an AC line conditioner(s).

When power is applied, the Power indicator on the front of the panel illuminates green to indicate the redundant power supplies are both working. If only one power supply is working, the Power indicator illuminates red (check power connections and switches).

To apply power:

1. Attach power cords (FIG. 6, top of next page) and plug into power source (turn on power source if necessary). Press the “I” side of both power switches on the enclosure(s).
The Power Indicator on the front of the enclosure illuminates a constant green.
2. Apply power to the source and destination devices.

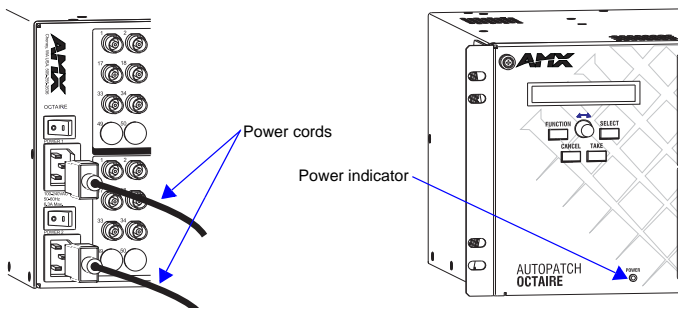

FIG. 6 Plug power cords into power receptacles

- Execute a test switch using the control panel (directions below).

Executing a Test Switch with the Control Panel

The primary enclosure in an Octaire system has a control panel on the front.

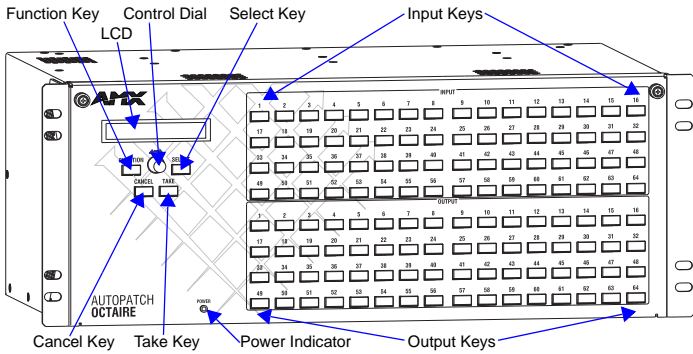

FIG. 7 Front view of Octaire enclosure with control panel

Control Panel Keys & Dial

- Function Key** – accesses start of Function menu at anytime during operation.
- Select Key** – enters selections.
- Cancel Key** – cancels an incomplete operation.
- Take Key** – must be pressed to complete an operation.
- Control Dial** – scrolls through the Function menu (starts with Change for switching). Menu loops back to the first item after scrolling past the last item.

To execute a test switch:

- Press the Function Key.
- From the Function menu, press the Select Key to select Change. The available Input and Output Keys turn blue.
- Press Input Key 1. Input Key 1 flashes white.
- Press Output Key 1. Output Key 1 illuminates white.
- Press the Take Key to execute the switch. Both keys turn blue.

After the test switch, attach the remaining source and destination devices.

Establishing Serial Control (if applicable)

The Octaire can be controlled by attaching an external control device/system (e.g., a PC) to the serial port (DB-9), which supports AMX AutoPatch BCS (Basic Control Structure) protocol.

To establish external serial control from RS-232 serial port:

- Plug the null modem cable (see FIG. 8 for pinout) into the serial port (DB-9) on the primary enclosure (the one with the control panel).

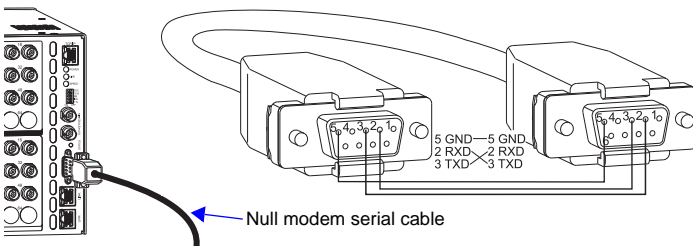

FIG. 8 Attach null modem serial cable (use pinout provided)

- Plug the other cable end into the serial port on the serial controller/device (PC).
- Open serial communication software and set the port settings on the PC to match the Octaire communication settings (baud rate = 9600, data bits = 8, stop bit = 1, parity and flow control = none).
- Execute a test switch – enter the BCS command `CL0 I101T` into a terminal emulation program (e.g., HyperTerminal) to route Input 1 to Output 1 on the ALL level. When `CL0 I101T` appears, the switch is successful.

Establishing TCP/IP Control (if applicable)

TCP/IP control can be established to access the APWeb Server (which delivers HTML pages and Java applets) to allow for remote control and diagnostics using APWeb and PC-based Internet browsing software.

Requirements

- PC** – Windows XP Professional®, Windows 2000®, or Windows NT®; web browser (e.g., Internet Explorer or Firefox); JRE v1.4.x or greater (Java plug-in for APWeb's XBar Controller).
- Cable for PC** – connect the Octaire directly to a network card in the PC* with a crossover (RJ-45) cable wired to TIA/EIA specification TIA/EIA-568-A.

* The TCP/IP port can be connected to a LAN; however, the cable requirements are different. For details, contact your network administrator and see "APWeb – Initial Setup by Network Admin" in the *Octaire Instruction Manual*.

To connect the Octaire system to a PC network card:

- Insert one end of the crossover (RJ-45) cable (see "Requirements" above) into a NIC card on the PC.
- Insert the other end of the cable into the TCP/IP port on the enclosure.

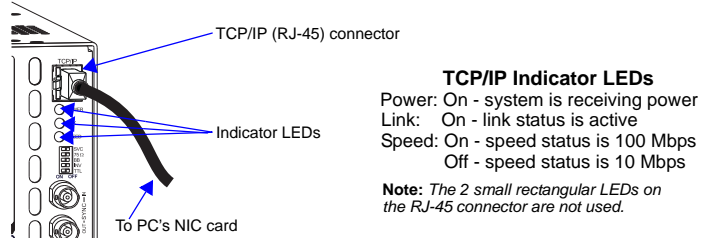

FIG. 9 TCP/IP (RJ-45) connector

- Apply power according to the directions on the previous page (lower right).
- Check the indicator LEDs.
- Allow 20 to 60 seconds for discovery, then test the connection (see following).

To test the TCP/IP connection:

- Launch a browser on your PC.
- Type <http://192.168.0.251> (the default APWeb IP address) in the address bar of the browser and press Enter. The PC *must* be on the same subnet (192.168.0.x); for details, see the *Octaire Instruction Manual*. The Enter Network Password dialog box opens. If the dialog box does not open, do a search for "APWeb troubleshooting" in the *Octaire Instruction Manual.pdf*.
- Enter the case-sensitive default user name **none** / password **none**.*
Or
Enter the case-sensitive default admin user name **super** / password **super**.**
Click OK.
APWeb opens.
- Execute a test switch – click the Controller link to open the XBar Controller; click the blue crosspoint for Input 1 and Output 1 (the crosspoint turns red as the switch is routed).

For setup and operation details, see the *Octaire Instruction Manual*.

* The default user name and password provide access to a limited set of server pages for executing switches and macros.

** The admin user name and password provide access to the full set of server pages, including pages for diagnostics, administration, and security.

Additional Information

Control Options

- NetLinX® Compatible** – supports Device Discovery; for specific control programming information, contact your AMX representative.
- APControl 3.0** (PC based) – see the *AMX AutoPatch CD* (included).

Important: Device Discovery functionality (beacon response) will only function properly if the NetLinX master is connected to the RS-232 control port on the primary enclosure (the one with the control panel).

The Octaire Instruction Manual

See instruction manual on *AMX AutoPatch CD* or at www.amx.com for following:

- Additional control panel functions, e.g., verifying signals, adjusting audio, and creating and executing global presets.
- Using the custom label kit (included in shipment) for the control panel.

The Octaire Connector Guide / Vertical Interval Sync (VIS) Guide

This double-sided guide (included in shipment) provides important information for cabling and linking enclosures and for connecting and enabling vertical interval sync.

Reference Document for the Octaire

The "BCS Protocol Instruction Manual" is on the *AMX AutoPatch CD* and at www.amx.com.

