

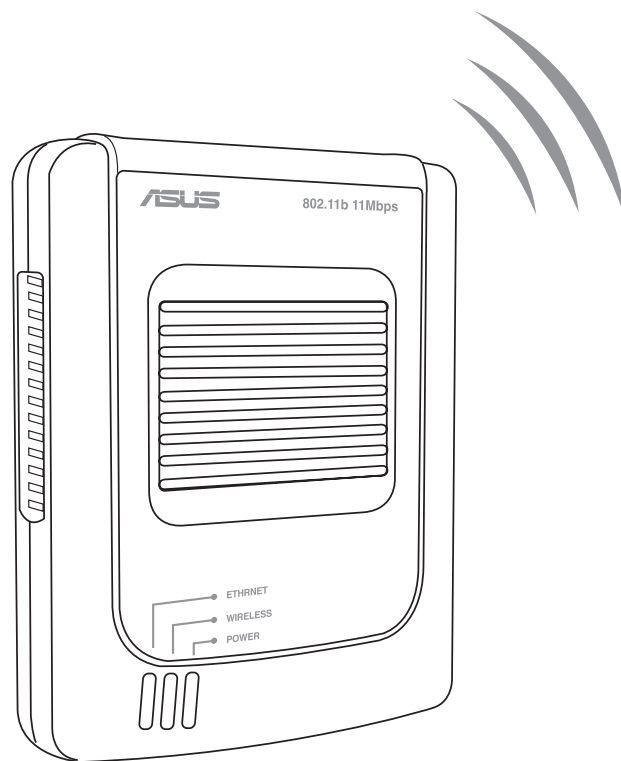

# Pocket Wireless Access Point (WL-330)



## User Guide

---

**E1499**

**Revised Edition V2  
December 2003**

**Copyright © 2003 ASUSTeK COMPUTER INC. All Rights Reserved.**

No part of this manual, including the products and software described in it, may be reproduced, transmitted, transcribed, stored in a retrieval system, or translated into any language in any form or by any means, except documentation kept by the purchaser for backup purposes, without the express written permission of ASUSTeK COMPUTER INC. ("ASUS").

Product warranty or service will not be extended if: (1) the product is repaired, modified or altered, unless such repair, modification or alteration is authorized in writing by ASUS; or (2) the serial number of the product is defaced or missing.

ASUS PROVIDES THIS MANUAL "AS IS" WITHOUT WARRANTY OF ANY KIND, EITHER EXPRESS OR IMPLIED, INCLUDING BUT NOT LIMITED TO THE IMPLIED WARRANTIES OR CONDITIONS OF MERCHANTABILITY OR FITNESS FOR A PARTICULAR PURPOSE. IN NO EVENT SHALL ASUS, ITS DIRECTORS, OFFICERS, EMPLOYEES OR AGENTS BE LIABLE FOR ANY INDIRECT, SPECIAL, INCIDENTAL, OR CONSEQUENTIAL DAMAGES (INCLUDING DAMAGES FOR LOSS OF PROFITS, LOSS OF BUSINESS, LOSS OF USE OR DATA, INTERRUPTION OF BUSINESS AND THE LIKE), EVEN IF ASUS HAS BEEN ADVISED OF THE POSSIBILITY OF SUCH DAMAGES ARISING FROM ANY DEFECT OR ERROR IN THIS MANUAL OR PRODUCT.

SPECIFICATIONS AND INFORMATION CONTAINED IN THIS MANUAL ARE FURNISHED FOR INFORMATIONAL USE ONLY, AND ARE SUBJECT TO CHANGE AT ANY TIME WITHOUT NOTICE, AND SHOULD NOT BE CONSTRUED AS A COMMITMENT BY ASUS. ASUS ASSUMES NO RESPONSIBILITY OR LIABILITY FOR ANY ERRORS OR INACCURACIES THAT MAY APPEAR IN THIS MANUAL, INCLUDING THE PRODUCTS AND SOFTWARE DESCRIBED IN IT.

Products and corporate names appearing in this manual may or may not be registered trademarks or copyrights of their respective companies, and are used only for identification or explanation and to the owners' benefit, without intent to infringe.

Notices .....	iv
Safety statements .....	v
About this guide .....	vii
WL-330 specification summary .....	viii

## Chapter 1: Product introduction

1.1	Welcome .....	1-2
1.2	Package contents .....	1-2
1.3	Features .....	1-3
	1.3.1 Top view .....	1-3
	1.3.2 Bottom view .....	1-4
	1.3.3 Rear view .....	1-4
1.4	LED indicators .....	1-5
1.5	Network setup .....	1-6
	1.5.1 Access Point mode .....	1-6
	1.5.2 Ethernet adapter mode .....	1-7

## Chapter 2: Installation

2.1	System requirements .....	2-2
2.2	Installing the ASUS Pocket Wireless AP .....	2-2
	2.2.1 Before you proceed .....	2-2
	2.2.2 Installation procedures .....	2-3
2.3	Placement .....	2-5
2.4	Operating range .....	2-6
	2.4.1 Range .....	2-6
	2.4.2 Site Surveys .....	2-6
2.5	Roaming information .....	2-6

# Contents

---

## Chapter 3: Configuration

3.1	Installing the utilities .....	3-2
3.2	Using the Setup Wizard utility .....	3-3
3.2.1	Launching the Setup Wizard utility .....	3-3
3.2.2	Access Point (AP) mode .....	3-4
3.2.3	Ethernet adapter mode .....	3-6
3.2	Device Discovery .....	3-12
3.3	Web Configuration utility .....	3-13
3.4	Launching the Web Configuration utility .....	3-15
3.5	Access Point mode .....	3-16
3.5.1	Simple Setup .....	3-16
3.5.2	Access Control .....	3-19
3.5.3	Firmware Upgrade .....	3-23
3.5.4	Restoring the default values .....	3-25
3.6	Ethernet adapter mode .....	3-26
3.6.1	Simple Setup .....	3-26
3.6.2	Site Survey .....	3-30
3.6.3	Firmware Upgrade .....	3-36
3.6.4	Restoring the default values .....	3-36
3.7	Firmware Restoration .....	3-37

## Chapter 4: Simple setup

4.1	Using the device in a local network .....	4-2
4.2	Replacing the desktop PCs or notebooks Ethernet cables ....	4-2
4.3	Replacing the Ethernet cables of other devices .....	4-3
4.4	Connecting to another AP as an adapter or wireless bridge ...	4-4

## Chapter 5: Troubleshooting

Troubleshooting .....	5-1
-----------------------	-----

## Federal Communications Commission Statement

This device complies with FCC Rules Part 15. Operation is subject to the following two conditions:

- This device may not cause harmful interference, and
- This device must accept any interference received, including interference that may cause undesired operation.

This equipment has been tested and found to comply with the limits for a class B digital device, pursuant to Part 15 of the Federal Communications Commission (FCC) rules. These limits are designed to provide reasonable protection against harmful interference in a residential installation. This equipment generates, uses, and can radiate radio frequency energy and, if not installed and used in accordance with the instructions, may cause harmful interference to radio communications. However, there is no guarantee that interference will not occur in a particular installation. If this equipment does cause harmful interference to radio or television reception, which can be determined by turning the equipment off and on, the user is encouraged to try to correct the interference by one or more of the following measures:

- Reorient or relocate the receiving antenna.
- Increase the separation between the equipment and receiver.
- Connect the equipment into an outlet on a circuit different from that to which the receiver is connected.
- Consult the dealer or an experienced radio/TV technician for help.



---

**CAUTION!** You are cautioned that changes or modifications not expressly approved by the party responsible for compliance could void your authority to operate the equipment.

---

Reprinted from the Code of Federal Regulations #47, part 15.193, 1993.  
Washington DC: Office of the Federal Register, National Archives and  
Records Administration, U.S. Government Printing Office.

# Safety statements

---

## Regulatory Information/Disclaimers

Installation and use of this Wireless LAN device must be in strict accordance with the instructions included in the user documentation provided with the product. Any changes or modifications (including the antennas) made to this device that are not expressly approved by the manufacturer may void the user's authority to operate the equipment. The manufacturer is not responsible for any radio or television interference caused by unauthorized modification of this device, or the substitution of the connecting cables and equipment other than manufacturer specified. It is the responsibility of the user to correct any interference caused by such unauthorized modification, substitution or attachment. Manufacturer and its authorized resellers or distributors will assume no liability for any damage or violation of government regulations arising from failing to comply with these guidelines.



---

**CAUTION!** To maintain compliance with FCC's RF exposure guidelines, this equipment should be installed and operated with minimum distance [20cm] between the radiator and your body. Use on the supplied antenna. Unauthorized antenna, modification, or attachments could damage the transmitter and may violate FCC regulations.

---

## Safety Information

In order to maintain compliance with the FCC RF exposure guidelines, this equipment should be installed and operated with minimum distance **[20cm]** between the radiator and your body. Use only with supplied antenna.

Unauthorized antenna, modification, or attachments could damage the transmitter and may violate FCC regulations.



---

**CAUTION!** Any changes or modifications not expressly approved in this manual could void your authorization to use this device.

---

## MPE Statement

Your device contains a low power transmitter. When device is transmitted it sends out Radio Frequency (RF) signal.

### **Caution Statement of the FCC Radio Frequency Exposure**

This Wireless LAN radio device has been evaluated under FCC Bulletin OET 65C and found compliant to the requirements as set forth in CFR 47 Sections 2.1091, 2.1093, and 15.247(b)(4) addressing RF Exposure from radio frequency devices. The radiation output power of this Wireless LAN device is far below the FCC radio frequency exposure limits. Nevertheless, this device shall be used in such a manner that the potential for human contact during normal operation – as a mobile or portable device but use in a body-worn way is strictly prohibit. When using this device, a certain separation distance between antenna and nearby persons has to be kept to ensure RF exposure compliance. In order to comply with the RF exposure limits established in the ANSI C95.1 standards, the distance between the antennas and the user should not be less than [20cm].

### **RF Exposure**

The antenna(s) used for this transmitter must not be co-located or operating in conjunction with any other antenna or transmitter.

# About this guide

---

This user guide contains the information you need to install and configure your ASUS Pocket Wireless Access Point (AP).

## How this guide is organized

This guide contains the following parts:

- **Chapter 1: Product introduction**  
This chapter describes the physical features of the ASUS Pocket Wireless AP. It also presents the package contents, LED indicators, and recommended network settings.
- **Chapter 2: Hardware installation**  
This chapter provides information on how to install the ASUS Pocket Wireless AP.
- **Chapter 3: Configuration**  
This chapter describes the utilities for configuring the ASUS Pocket Wireless AP.
- **Chapter 4: Simple Setup**  
This chapter provides step-by-step instructions on how to setup your ASUS Pocket Wireless AP.
- **Chapter 5: Troubleshooting**  
The Appendix contains a troubleshooting guide for solving common problems you may encounter when using the ASUS Pocket Wireless AP.

## Conventions used in this guide

To make sure that you perform certain tasks properly, take note of the following symbols used throughout this guide.



**WARNING:** Information to prevent injury to yourself when trying to complete a task.



**CAUTION:** Information to prevent damage to the components when trying to complete a task.



**IMPORTANT:** Information that you **MUST** follow to complete a task.



**NOTE:** Tips and additional information to aid in completing a task.



# ASUS contact information

---

## **ASUSTeK COMPUTER INC. (Asia-Pacific)**

Address 150 Li-Te Road, Peitou, Taipei, Taiwan 112  
Telephone +886-2-2894-3447  
Web site [www.asus.com.tw](http://www.asus.com.tw)

### *Technical Support*

Telephone  
(MB/Component) +886-2-2890-7121 (English)  
(Notebook) +886-2-2890-7122 (English)  
(Server/PC) +886-2-2890-7123 (English)  
(Networking) +886-2-2890-7902 (English)  
Support fax +886-2-2890-7698

## **ASUS COMPUTER INTERNATIONAL (America)**

Address 44370 Nobel Drive, Fremont, CA 94538, USA  
Fax +1-510-608-4555  
E-mail [tmd1@asus.com](mailto:tmd1@asus.com)  
Web site [usa.asus.com](http://usa.asus.com)

### *Technical Support*

Telephone  
(General) +1-502-995-0883  
(Notebook) +1-510-739-3777  
Support fax +1-502-933-8713  
Support e-mail [tsd@asus.com](mailto:tsd@asus.com)

## **ASUS COMPUTER GmbH (Germany and Austria)**

Address Harkort Str. 25, D-40880 Ratingen, Germany  
Telephone +49-2102-95990  
Fax +49-2102-959911  
Online contact [www.asuscom.de/sales](http://www.asuscom.de/sales)

### *Technical Support*

Telephone +49-2102-95990  
Fax +49-2102-959911  
Online support [www.asuscom.de/support](http://www.asuscom.de/support)  
Web site [www.asuscom.de/news](http://www.asuscom.de/news)

## **ASUS COMPUTER (Middle East and North Africa)**

Address P.O. Box 64133, Dubai, U.A.E.  
Telephone +9714-283-1774  
Fax +9714-283-1775  
Web site [www.ASUSarabia.com](http://www.ASUSarabia.com)

---

## WL-330 specification summary\*

---

<b>Standard</b>	IEEE 802.11b
<b>Technology</b>	Direct Sequence Spread Spectrum (DSSS)
<b>Data Transfer Rate</b>	11Mbps (with automatic fallback to 5.5, 2 and 1Mbps)
<b>Network Types</b>	Supports Infrastructure and Ad-hoc networks
<b>Frequency Band</b>	2.4 GHz ~ 2.5 GHz
<b>Security</b>	64-bit/128-bit configurable WEP encryption
<b>Operating Distance</b>	Indoors: 100 ft (30 m) @ 11Mbps Outdoors: 1000 ft (300 m) @ 11Mbps
<b>Supported OS</b>	Windows® 98SE/ME/2000/XP
<b>Antenna</b>	Internal antenna

*\*Specifications are subject to change without notice.*

# Chapter 1

This chapter describes the physical features of the ASUS Pocket Wireless Access Point. It also presents the package contents, LED indicators, and recommended network settings.

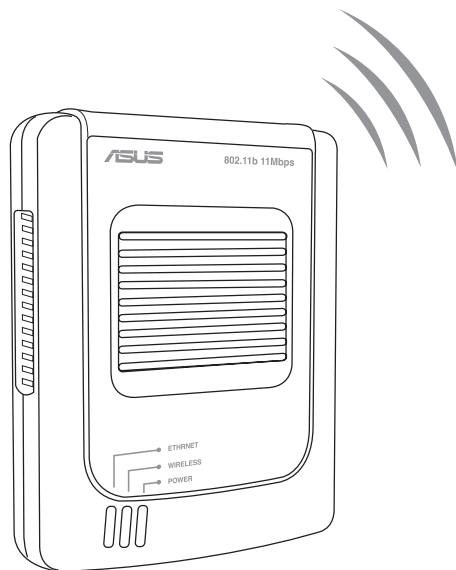

## ▶ *Product introduction*

# Product introduction

---

## 1.1 Welcome!

Thank you for choosing the ASUS Pocket Wireless Access Point!

The ASUS Pocket Wireless AP is an easy-to-install wireless access point and Ethernet adapter in one. Conforming to IEEE 802.11b standard for wireless local area network (WLAN), the ASUS Pocket Wireless AP is capable of up to 11Mbps data transmission rate on the 2.4GHz to 2.5GHz band.

The ASUS Pocket Wireless AP also features the latest wireless technology developed by ASUS to keep you ahead in the world of wireless computing.

## 1.2 Package contents

Check the following items in your ASUS Pocket Wireless AP package. Contact your retailer if any item is damaged or missing.

- ✓ ASUS Pocket Wireless AP (WL-330)
- ✓ Universal power adapter and plug (100V ~ 240V)
- ✓ USB adapter and plug
- ✓ RJ-45 connector and cable
- ✓ Support CD
- ✓ Quick Start Guide
- ✓ Soft case



---

Unless otherwise specified, the term “device” in this User Guide refers to the ASUS Pocket Wireless AP.

---

## 1.3 Features

The ASUS Pocket Wireless AP employs the Direct Sequence Spread Spectrum (DSSS) technology to transmit and receive signals through radio waves on the 2.4 GHz band.

Here are other ASUS Pocket Wireless AP features:

- Reliable data transfer rates of up to 11Mbps with automatic fallback to 5.5, 2, and 1Mbps
- Secure data transmission via Wired Equivalent Privacy (WEP) encryption
- Operating distance of up to 100 ft (30 m) indoors and 1000 ft (300m) outdoors\*
- Dual power mode (DC or USB bus-powered)
- Equipped with a mounting hook and magnetic ring for desktop or wall installation
- Supports Infrastructure and Ad-hoc network types
- Windows® 98SE/ME/2000/XP compatible



---

The ASUS Pocket Wireless AP operating distance may be shorter if there are walls, barriers, or interferences in the home layout or operating environment.

---

### 1.3.1 Top view

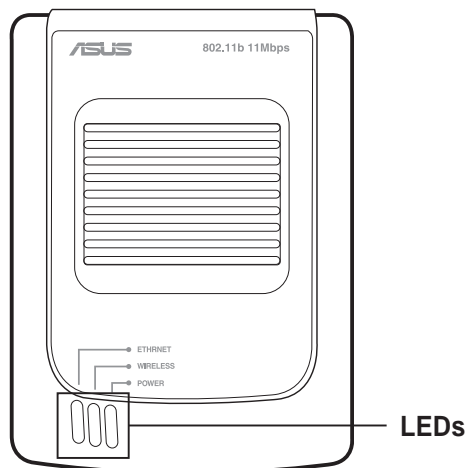

**LEDs.** The ASUS Pocket Wireless AP comes with three LED indicators. Refer to section 1.4 “LED indicators” for details.

# Product introduction

---

## 1.3.2 Bottom view

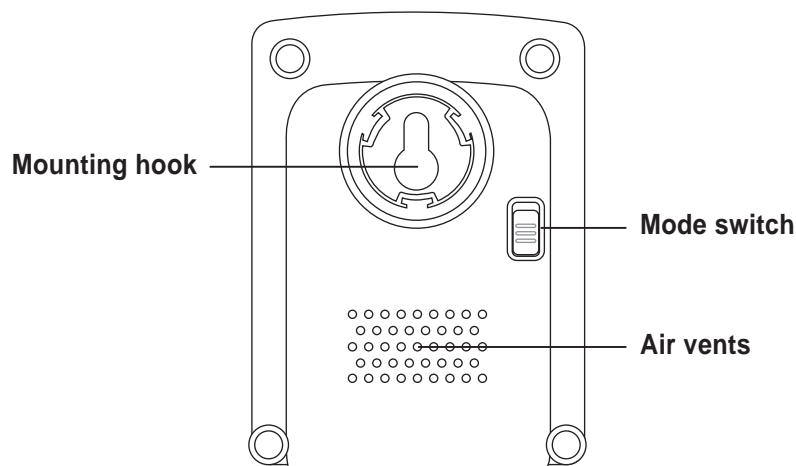

**Mounting hook.** Use the mounting hook to install the device on concrete or wooden surfaces using a roundhead screw.

**Air vents.** These vents provide ideal ventilation to the device.

**Mode switch.** Allows you to switch from AP mode to Ethernet adapter mode, or vice versa.

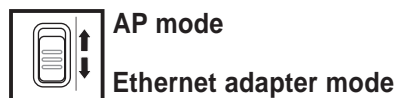

## 1.3.3 Rear view

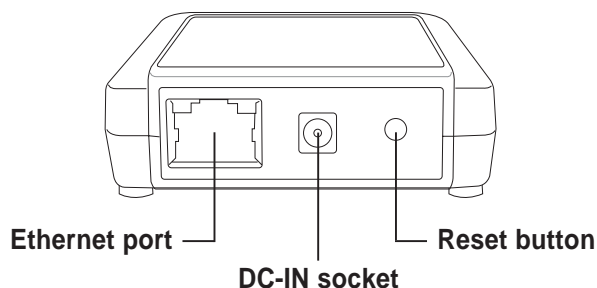

**Ethernet port.** This port connects the supplied RJ-45 plug and cable.

**DC IN socket.** This socket connects the power adapter plug.

**Reset button.** Press this button for more than five seconds (in AP or Ethernet mode) to load the default values. In Ethernet adapter mode, press this button for less than five seconds to connect to the first saved wireless connection in the profile table. See page 3-15 for the reset button function in Ethernet mode.

## 1.4 LED indicators

The ASUS Pocket Wireless AP comes with a Power, Wireless, and Ethernet LED indicators. Refer to the table below for LED indications.

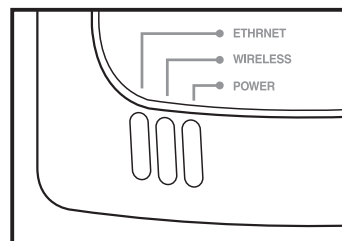

<b>LED</b>	<b>Status</b>	<b>Mode*</b>	<b>Indication</b>
<b>Power</b>	<b>On</b>	<b>AP/EA</b>	The device is on and ready.
	<b>Off</b>	<b>AP/EA</b>	The device is off or performing boot sequence.
	<b>Blinking</b>	<b>AP/EA</b>	Firmware upgrade failed.
<b>Wireless</b>	<b>On</b>	<b>AP</b> <b>EA</b>	The device is on and ready. The device is associated with an AP or other wireless device.
	<b>Off</b>	<b>AP</b> <b>EA</b>	The device is off. The device is not associated with an AP or other wireless device.
	<b>Blinking</b>	<b>AP/EA</b>	The device is transmitting or receiving data.
<b>Ethernet</b>	<b>On</b>	<b>AP/EA</b>	The device is connected to an Ethernet network.
	<b>Off</b>	<b>AP/EA</b>	The device is off or not connected to an Ethernet network.

\*Modes:

AP - Access point

EA - Ethernet adapter

# Product introduction

---

## 1.5 Network setup

The ASUS Pocket Wireless AP may be configured as an Access Point (AP) or wireless Ethernet adapter. In AP mode, the device acts as the central link between computers in a wireless network. In Ethernet adapter mode, the device connects to:

1. Other wireless device/s (Ad-hoc network type), or
2. Access point (Infrastructure network type)



---

Determine your network settings before installing the ASUS Pocket Wireless AP to avail all its features. The following network settings are recommended.

---

### 1.5.1 Access Point mode

In Access Point mode the ASUS Pocket Wireless AP allows wireless clients to connect to a wired or wireless LAN.

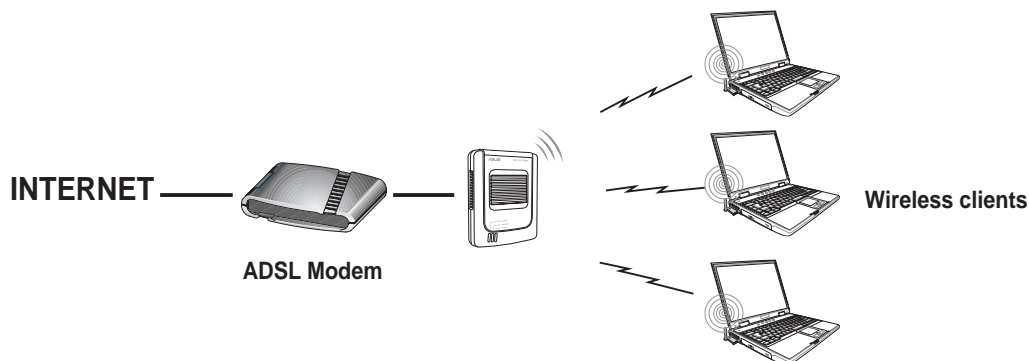



## 1.5.2 Ethernet adapter mode

### Ad-hoc network type

In an Ad-hoc network type, the ASUS Pocket Wireless AP connects to another ASUS Pocket Wireless AP or other wireless devices. No access point (AP) is present.

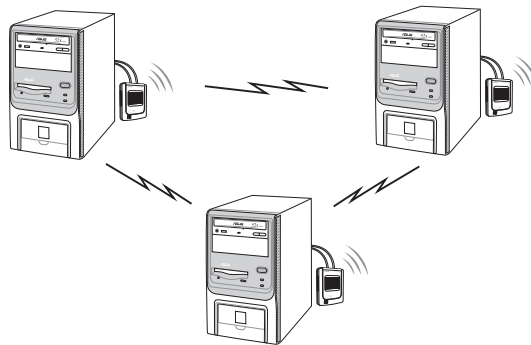

### Infrastructure network type

In an Infrastructure network type, each computer with an ASUS Pocket Wireless AP connects to an access point that provides a central link for communication among the computers.

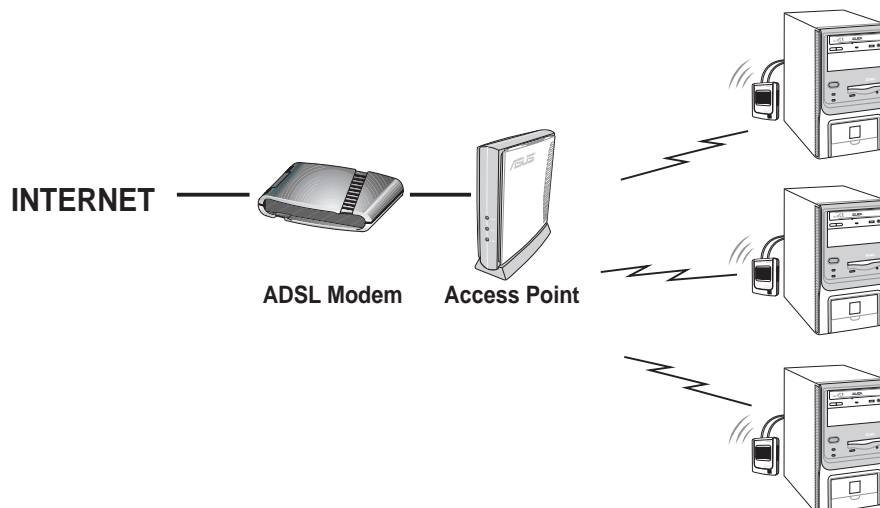

# Product introduction

---

## Single IP bridge environment

In a single IP bridge environment, the device connects to an access point using a single IP address.

In this setup, the MAC cloning feature may be enabled to support certain applications and devices, such as Xbox and PlayStation® game consoles, that use the MAC address to communicate with other devices. MAC cloning allows the ASUS Pocket Wireless AP to communicate with other devices in a wireless network using the MAC address of the host computer instead of its own.



## Multiple IP bridge environment

In a multiple IP bridge environment, the ASUS Pocket Wireless AP connects two or more wired devices to a wireless network from a hub or a switch.

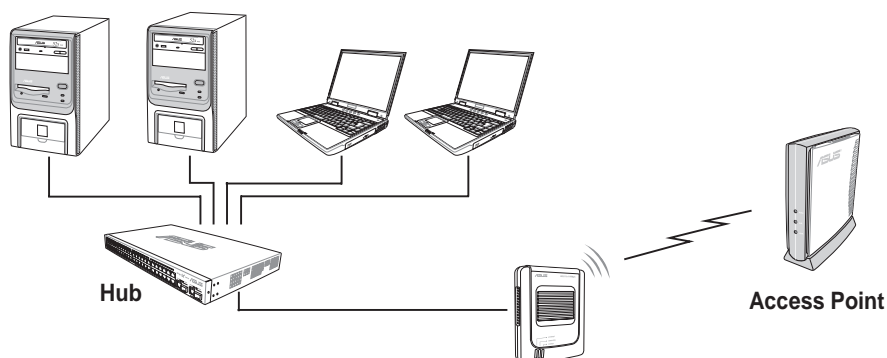

---

You must disable the MAC cloning feature when you set the device in Ethernet adapter mode under this environment. Enabling MAC cloning under this environment results to undefined and incorrect bridge behavior.

---

# Chapter 2

This chapter provides information on how to install the ASUS Pocket AP.

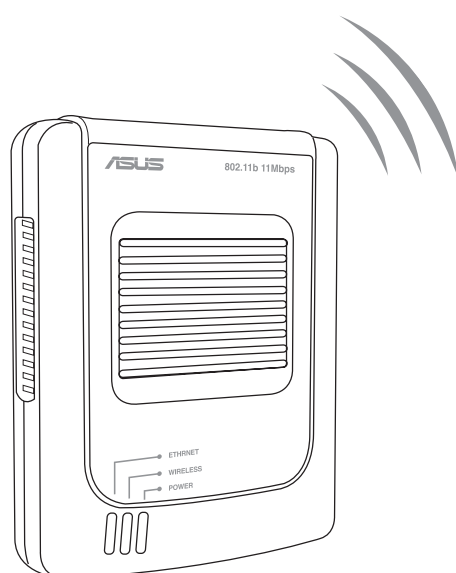

## ▶ *Installation*

# Installation

---

## 2.1 System requirements

Before installing the ASUS Pocket Wireless AP, make sure that your system meets the following requirements:

- An Ethernet (10Base-T or 100Base-TX) adapter for wired client
- At least one 802.11b (11Mbps) wireless adapter for wireless mobile client
- TCP/IP and an Internet browser installed

## 2.2 Installing the ASUS Pocket Wireless AP

### 2.2.1 Before you proceed

Take note of the following guidelines before installing the ASUS Pocket Wireless AP.

- The length of the Ethernet cable that connects the device to the network must not exceed 100 meters.
- Place the device on a flat, stable surface as far from the ground as possible
- Keep the device clear from metal obstructions and away from direct sunlight.
- Keep the device away from transformers, heavy-duty motors, fluorescent lights, microwave ovens, refrigerators, and other industrial equipment to prevent signal loss.
- Install the device in a central area to provide ideal coverage for all wireless mobile devices.



---

Install this device at least 20 centimeters from any person to insure that the product is operated in accordance with the RF Guidelines for Human Exposure which have been adopted by the Federal Communications Commission.

---

## 2.2.2 Installation procedures

Follow these instructions to install the ASUS Pocket Wireless AP.

### Access point mode (DC power)

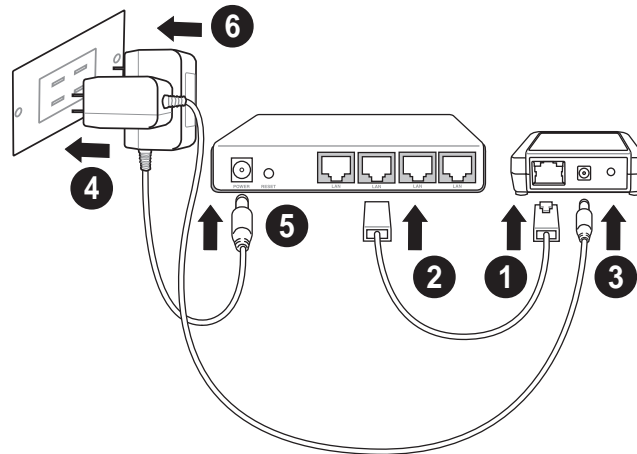

1. Connect one end of the RJ-45 cable to the Ethernet port of the device.
2. Connect the other end of the RJ-45 cable to the 10Base-T port of a network hub, switch, router, or wall patch panel.
3. Insert the universal power adapter plug to the DC-IN socket of the device.
4. Connect the universal power adapter to a wall socket.
5. Insert the power plug to the DC-IN socket of the network hub, switch, or router.
6. Plug the power adapter of the network hub, switch, or router to a wall socket.



Use only the power adapter and plug that came with the ASUS Pocket Wireless AP package. Using other power adapter and plug may damage the device.

# Installation

---

## *Ethernet adapter mode (USB bus power)*

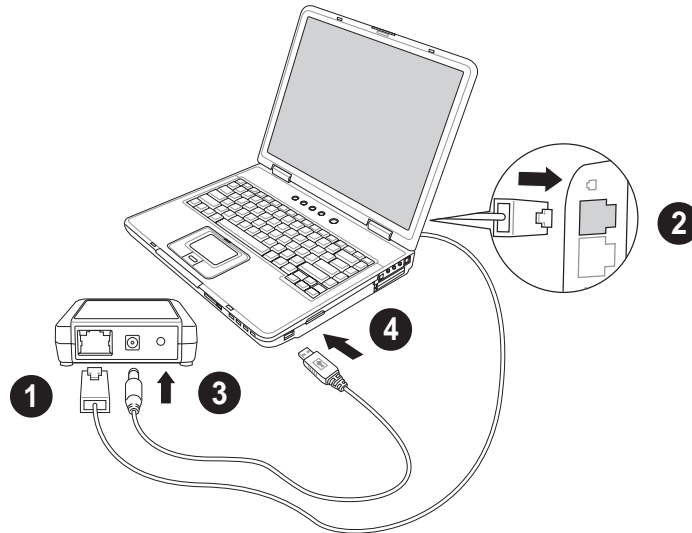

1. Connect one end of the RJ-45 cable to the Ethernet port of the device.
2. Connect the other end of the RJ-45 cable to the Ethernet port of your PC or notebook.
3. Insert the USB cable plug to the DC-IN socket of the device.
4. Insert the other end of the USB cable to any available USB port in your PC or notebook.

After installation, check the Power and Ethernet LEDs. These LEDs light up to indicate that the device is on and has physical connection to an Ethernet network. Refer to the LED indications on page 1-5.

## 2.3 Mounting

Aside from desktop placement, you may install the ASUS Pocket Wireless AP vertically on a concrete or wooden wall using the mounting hooks at the bottom of the and a mounting screw.

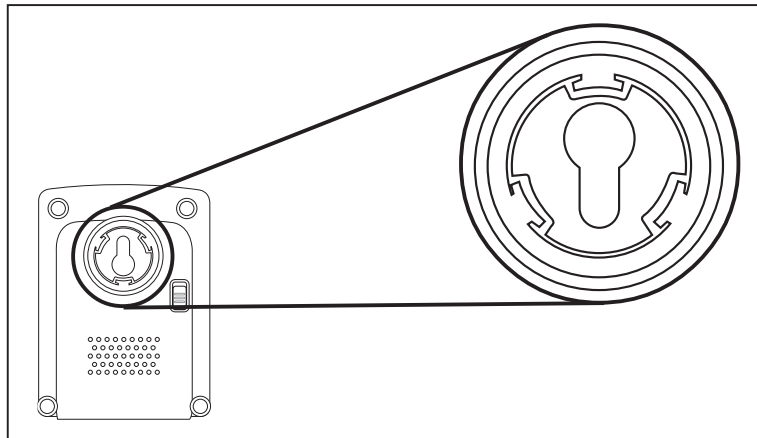

To mount the ASUS Pocket Wireless AP on a concrete or wooden wall:

1. Locate the mounting hook at the bottom of the device.
2. Select an ideal location for the device following the guidelines in section 2.2.1.
3. Tighten a round head screw on the concrete or wooden wall until only 1/4" is showing.
4. Latch the device into the screw.



---

Adjust the screw if you cannot latch the device or if the screw is too loose.

---

# Installation

---

## 2.4 Operating range

### 2.4.1 Range

The ASUS Pocket Wireless AP range is dependent on the operating environment. Every home or office layout varies in obstacles, barriers, or wall types which may reflect or absorb radio signals. For example, two 802.11b radios in an open space may achieve an operating distance of up to 1000 meters, while the same two units may only achieve up to 300 meters of range when used indoors.

By default, the device automatically adjusts the data rate to maintain a usable radio connection. Therefore, a client that is close to the device may operate at higher speeds while a client that is on the fringe of coverage may operate at lower speeds. You can configure the data rates that the device uses. If you limit the range of data rates available to the ASUS Pocket AP, you may reduce the effective wireless range of the WLAN coverage.

### 2.4.2 Site survey

A site survey (utility provided with the ASUS Pocket Wireless AP) analyzes the installation environment and provides users with recommendations for equipment and its placement. The optimum placement differ depending on the device design and specifications.

## 2.5 Roaming information

If there are several ASUS Pocket Wireless APs operating on a network, then a wireless mobile client may seamlessly roam from one ASUS Pocket Wireless AP to another.

Each ASUS Pocket Wireless AP creates its own wireless cell or coverage area known as a Basic Service Set (BSS). Any wireless mobile client can communicate with a particular ASUS AP if it is within that AP's coverage area.



If the cells of multiple ASUS Pocket APs overlap, then the wireless mobile client may switch from one ASUS Pocket Wireless AP to another. During the transfer from one ASUS AP to another, the wireless mobile client maintains an uninterrupted connection to the network. This is called “roaming.”

Multiple ASUS Pocket APs connected to a common Ethernet network form an Extended Service Set (ESS). All members of an Extended Service Set are configured with an ID, known as the SSID or ESSID. Wireless mobile clients must be configured with the same SSID as the ASUS Pocket APs on the network since it can only roam between ASUS Pocket APs sharing the same SSID.

## Important notes on roaming

- An ASUS WLAN card can only roam between APs of the same type.
- All ASUS Pocket Wireless APs must have the same SSID.
- All computers with ASUS WLAN cards must have the same SSID as the Access Points to enable roaming.
- If WEP encryption is enabled, all ASUS APs and client adapters must use the same encryption level and WEP key(s) to establish connection.
- ASUS Pocket Wireless AP's cells must overlap to provide an uninterrupted connection for a roaming client.
- ASUS Pocket Wireless APs that use the same channel should be installed away from each other to reduce potential interference.
- We strongly recommended that you perform a site survey using the ASUS Pocket Wireless AP utility to determine the best location for each device.



# Chapter 3

This chapter describes the ASUS Pocket Wireless AP configuration using the utilities available from the support CD.

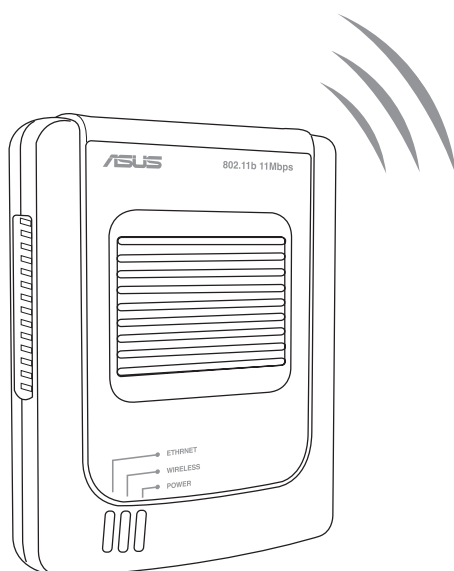

## ► *Configuration*

# Configuration

---

## 3.1 Installing the utilities

The support CD contains the utilities for configuring the ASUS Pocket Wireless AP.

To install the device utilities in your computer:

1. Insert the support CD to the optical drive.
2. Click “**Install ASUS WLAN AP Utilities**” when the ASUS Wireless Access Point WL-330 installation window appears.
3. The device utilities are copied into your computer.

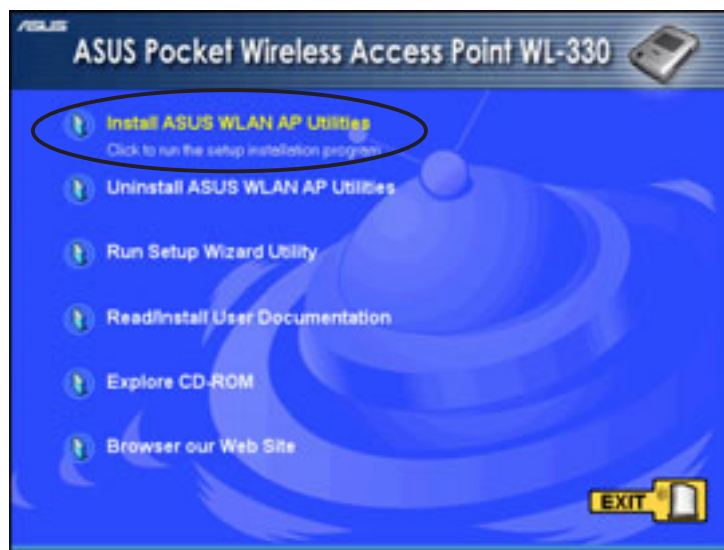

If Autorun is NOT enabled in your computer, browse the contents of the support CD and double click the Setup.exe file to run the CD.

---

### Other support CD options

**Uninstall ASUS WLAN Card Utilities/Driver.** Click this option to uninstall the ASUS Pocket Wireless AP utilities from your system.

**Run Setup Wizard Utility.** Click this option to run the Setup Wizard utility.

**Read/Install User Documentation.** Click to view the installation and quick setup guides in PDF format.

**Explore this CD.** Click this option to explore the support CD contents.

**Browse our Web Site.** Click this option to visit the ASUS website.

Click **EXIT** to close the installation window.

## 3.2 Using the Setup Wizard utility

The Setup Wizard utility allows easy configuration of the ASUS Pocket Wireless AP settings in both access point and Ethernet adapter modes. You may launch the Setup Wizard utility directly from the support CD or from the Windows® desktop.

### 3.2.1 Launching the Setup Wizard utility

To launch the Setup Wizard utility from the support CD:

1. Insert the support CD to the optical drive.
2. Click the **Run Setup Wizard Utility** option from the installation window.
3. The Setup Wizard utility window appears.

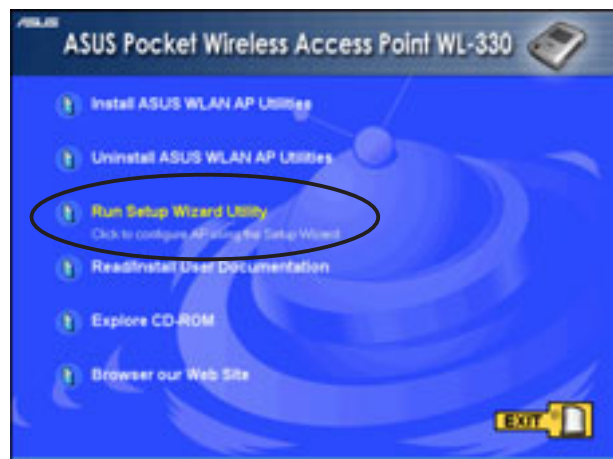

To launch the Setup Wizard from the Windows® desktop:

1. Install the device utilities following the steps in section 3.1.
2. From the Windows® desktop, click **Start > All Programs > ASUS Utility > Wireless AP WL-330 > Setup Wizard**.
3. The Setup Wizard utility window appears.

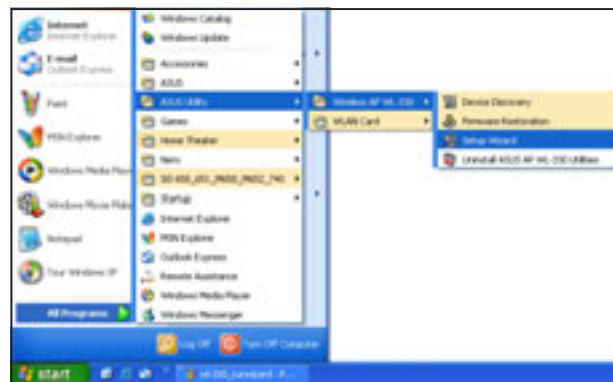

# Configuration

## 3.2.2 Access Point (AP) mode

By default, the ASUS Pocket Wireless AP is set to access point (AP) mode. The Setup Wizard auto-detects and displays the device SSID, channel, encryption, MAC, and IP addresses. Click **Configure** to change these settings.

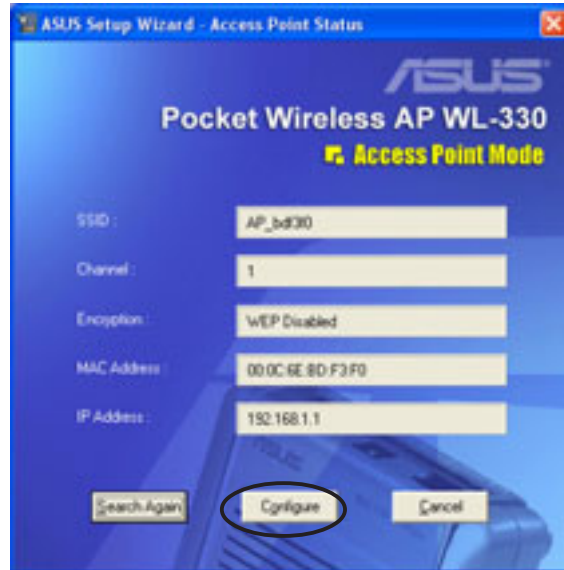

### Basic tab

**Network Name (SSID).** This field allows you to set the ASUS Pocket Wireless AP SSID. The SSID is an identification string of up to 32 ASCII characters that differentiate the device from other manufacturers.



A wireless client must have the same SSID with the ASUS Pocket Wireless AP to establish connection.

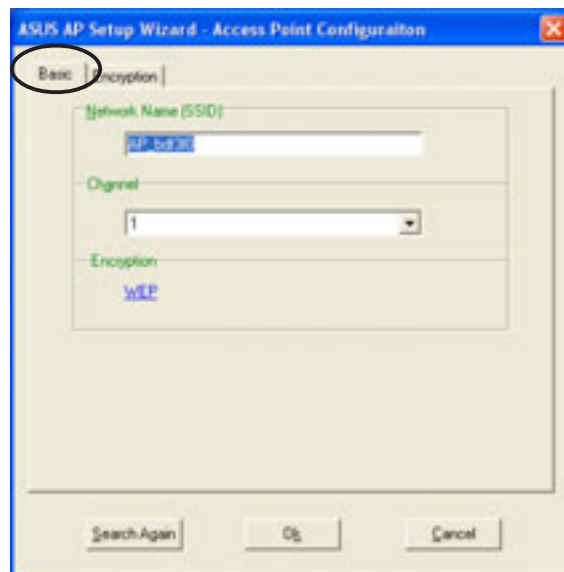

**Channel.** Select a radio channel the ASUS Pocket Wireless AP uses in communicating with other wireless device(s). IEEE 802.11b devices are direct sequence spread spectrum devices that spread a radio signal over a range of frequencies. A channel is a range of frequencies used by a direct sequence device.

Click the **Encryption** tab to configure the device WEP encryption settings.

## Encryption tab

The Encryption tab allows you to enable or disable the Wired Equivalent Privacy (WEP) encryption. WEP encryption secures data transmission between devices in a wireless network.

**Authentication Method.** This option allows you to select the Authentication method for WEP encryption.

*Open System or Shared Key* - When selected, the AP accepts connection requests from any wireless device within its operating range.

*Shared Key* - In Shared Key method, wireless device(s) must have the same WEP encryption as that of the AP to establish connection.

**Key Format** allows you to set a hexadecimal digit or ASCII character WEP key.

**Key Length** allows you to choose a 64-bit or a 128-bit WEP key. A 64-bit encryption contains 10 hexadecimal digits or 5 ASCII characters. A 128-bit encryption contains 26 hexadecimal digits or 13 ASCII characters.

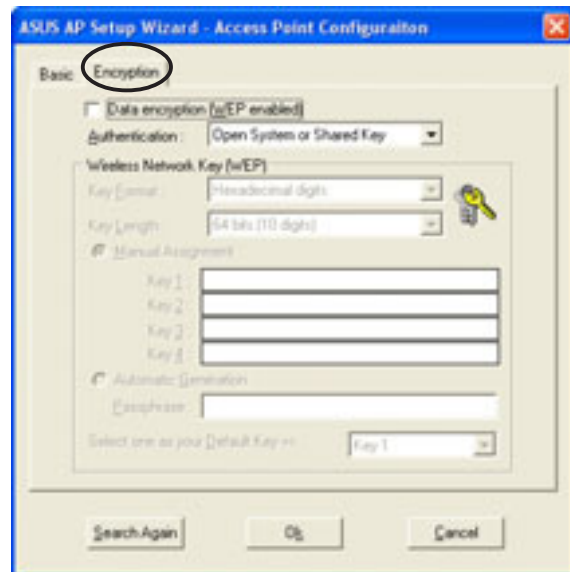

- 64-bit and 40-bit WEP keys use the same encryption method and can interoperate on wireless networks. This lower level of WEP encryption uses a 40-bit (10 hexadecimal digits assigned by the user) secret key and a 24-bit Initialization Vector assigned by the wireless LAN adapter. 104-bit and 128-bit WEP keys use the same encryption method.
- All wireless clients in a network must have identical WEP keys with the access point to establish connection.
- Keep a record of the WEP encryption keys.

# Configuration

---

## Two ways to assign WEP keys

**Manual Assignment.** For a 64-bit encryption, enter 10 hexadecimal digits (0~9, a~f, A~F) or 5 ASCII characters in each of the four WEP keys. For 128-bit encryption enter 26 hexadecimal digits (0~9, a~f, A~F) or 13 ASCII characters in each of the four WEP keys.

**Automatic Generation.** Type a combination of up to 64 letters, numbers, or symbols in the Passphrase field. The Setup Wizard utility uses an algorithm to generate four WEP keys based on the typed combination.

**Default Key.** This field allows you to specify the default WEP encryption key. Click **OK** when finished.

### 3.2.3 Ethernet adapter mode

The Setup Wizard utility also allows you to configure the Ethernet adapter settings of the ASUS Pocket Wireless AP.

To change the Ethernet adapter settings:

1. Switch the ASUS Pocket Wireless AP to Ethernet adapter mode using the mode switch on the bottom of the device.
2. From the Windows® desktop, click **Start > All Programs > ASUS Utility > Wireless AP WL-330 > Setup Wizard.**



---

The SSID and WEP encryption keys of the ASUS Pocket Wireless AP must be the same with that of the AP or wireless client to establish connection.

---



# Configuration

3. The **Ethernet Adapter Status** window appears and displays the auto-detected Ethernet adapter settings including the association state, network type, SSID, encryption, MAC, and IP addresses.

Click the **Configure** button if the device is not associated with any wireless network or if you want to connect to another wireless network or client.

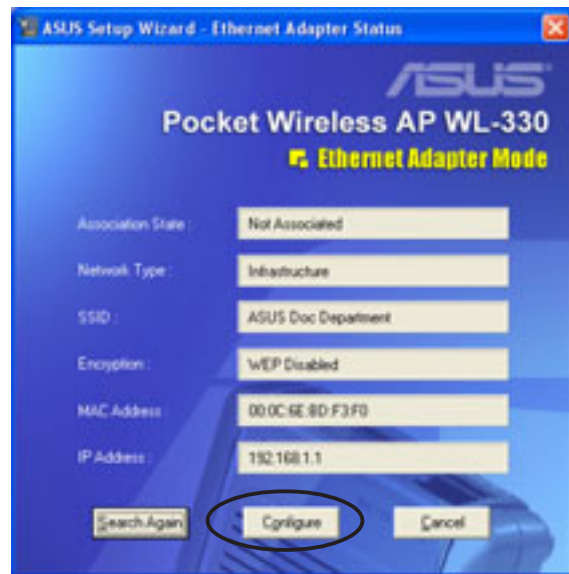

## Connecting to another AP or wireless client

To connect to another AP or wireless client:

1. Select a wireless network from the **Available Networks** list, then click **Configure**.

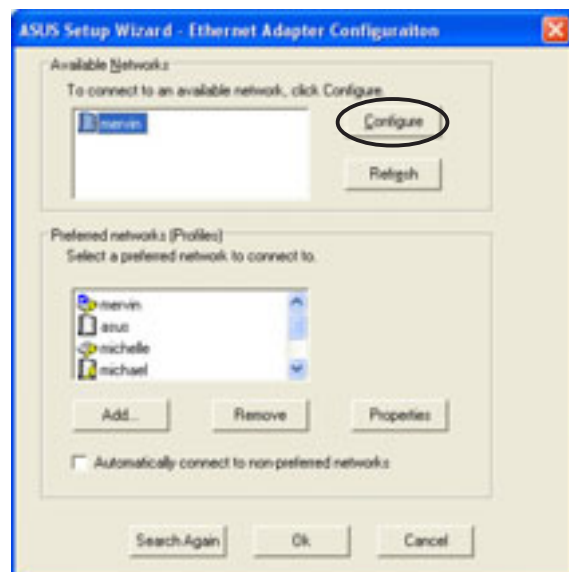





The available networks are indicated by icons for easy identification. Refer to the table in the next page for icon indications.





# Configuration

## Table of Icon Indications

### Infrastructure mode

Icon	Indications
	The device is not connected to this access point.
	The device is not connected to this WEP-encrypted access point.
	The device is connected to this access point.
	The device is not connected to this WEP-encrypted access point.

### Ad-hoc mode

Icon	Indications
	The device is not connected to this wireless client.
	The device is not connected to this WEP-encrypted wireless client.
	The device is connected to this wireless client.
	The device is connected to this WEP-encrypted wireless client.



If you are trying to connect to an AP (Infrastructure), make sure the MAC address of the ASUS Pocket Wireless AP is included in the AP authorization table.

2. Enter the SSID in the **Network Name** field.
3. Select the network channel.
4. Select the network type. Choose **Infrastructure** if you wish to connect to an AP. Select **Ad Hoc** if you wish to connect to another wireless device.

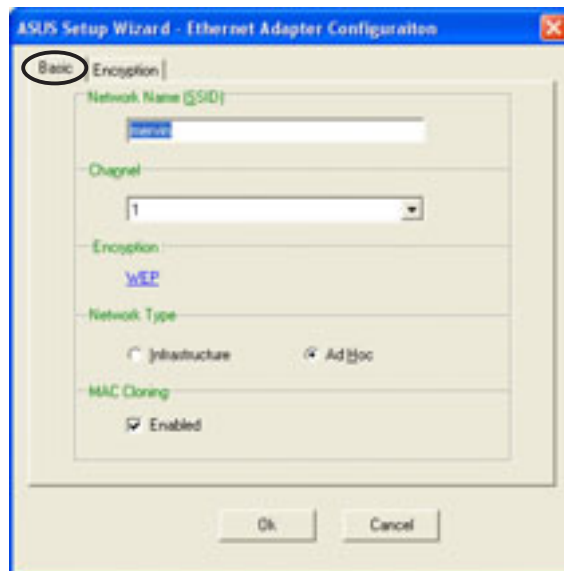

# Configuration

5. Enable or disable **MAC cloning**. MAC cloning allows the ASUS Pocket Wireless AP to use the MAC address of the host computer in communicating with other wireless device. Refer to page 3-27 for details on MAC cloning.
6. Click the **Encryption** tab or the **WEP** link to configure the device WEP encryption settings.

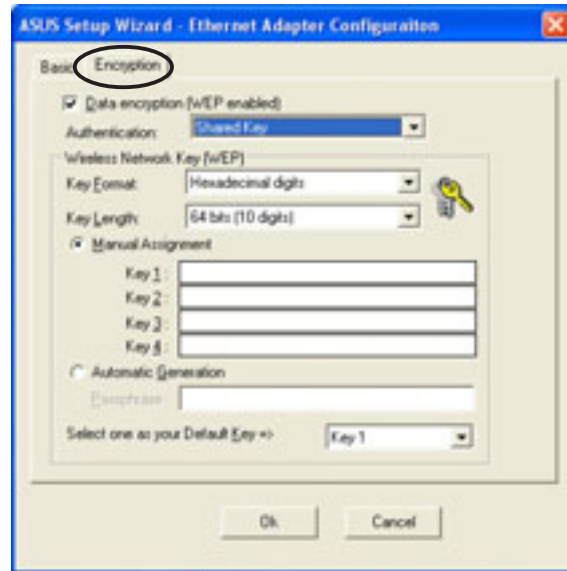

Change the device WEP encryption settings only when your selected network has an enabled WEP encryption.

7. Obtain the WEP encryption keys from the network administrator.
8. Check the **Data encryption** option.
9. Select the **Shared Key** or **Open System or Shared Key** method from the **Authentication** drop-down menu.
10. Select the WEP encryption key format and key length. Refer to page 3-5 for details.
11. Enter the WEP keys in the **Key 1 ~ 4** fields.
12. Click **OK** when done.

# Configuration

---

## Managing wireless networks

The **Preferred networks** field allows you to save, configure and manage multiple wireless networks. The ASUS Pocket Wireless AP automatically connects to a wireless network with the strongest link quality in the preferred network list.

To configure a preferred network:

1. Select a network from the **Preferred networks** list, then click the **Properties** button.
2. The **Basic** tab window appears. Configure the wireless network following the instructions on page 3-8 and 3-9.
3. Click **OK** when finished.

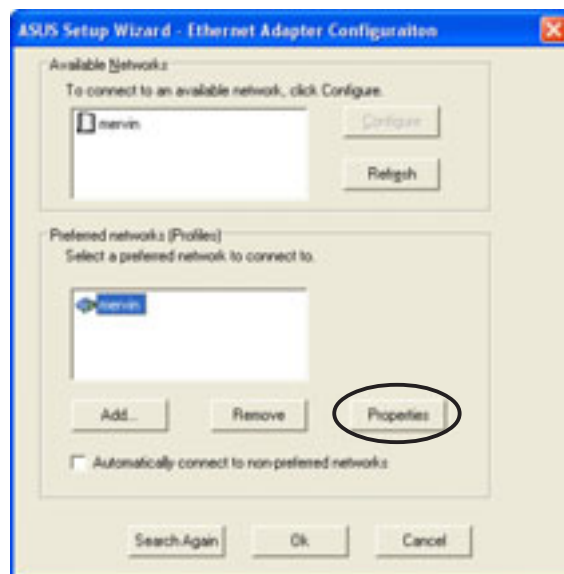

To add a preferred network:

1. Click the **Add** button.
2. The **Basic** tab window appears. Configure the preferred network following the instructions on page 3-8 and 3-9.
3. Click **OK** when finished.
4. The preferred network is added to the preferred network list.

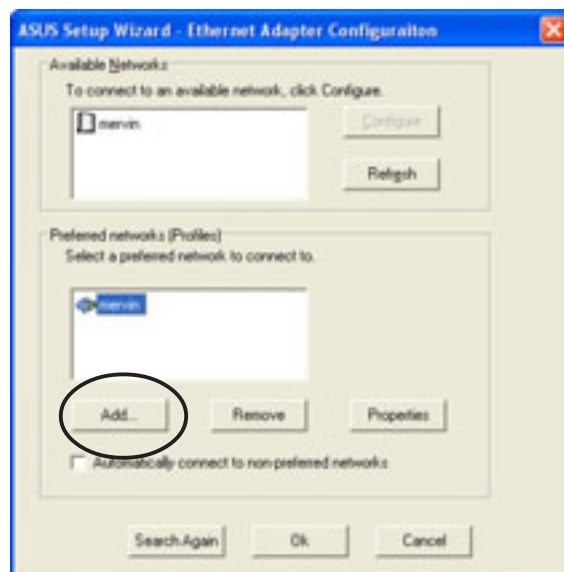

# Configuration

To remove a network from the preferred network list:

1. Select the network, then click the **Remove** button.
2. Click **OK** to confirm.

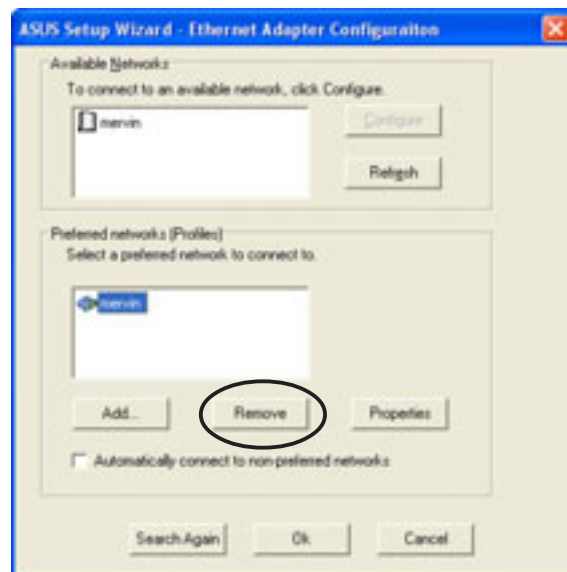

- You may also view the preferred network list in the Profiles table of the Web Configuration utility. See page 3-31 for details.
- Check the **Automatically connect to non-preferred networks** option if you wish to establish connection with other AP or wireless client not listed in the preferred networks list.

# Configuration

---

## 3.2 Device Discovery

The Device Discovery utility searches and identifies the ASUS WLAN products connected to your computer.

To launch the Device Discovery from the Windows® desktop:

1. Click **Start > All Programs > ASUS Utility > Wireless AP WL-330 > Device Discovery**.

2. The Device Discovery window appears.

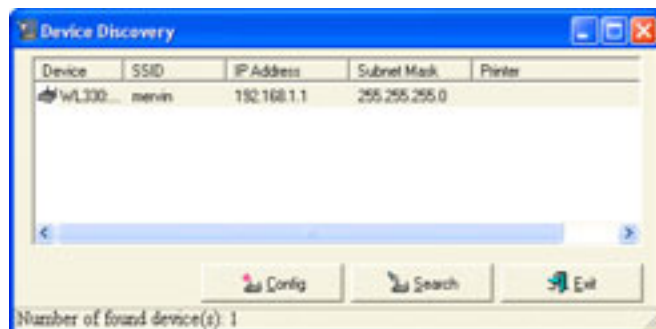

3. Click **Search** to scan for wireless LAN devices connected to your computer. The Device Discovery auto-detects the device(s) and displays the SSID, IP Address, Subnet mask, and Printer.

4. Click **Config** to open the Web Configuration utility. See the next section for details.

5. Click **Exit** to close the utility.



---

The Device Discovery window also appears when you launch the Setup Wizard utility after switching the device mode (from AP to Ethernet adapter or vice versa). Do any of the following to configure the device.

- Click the **Config** button to launch the Web Configuration utility, or
  - Click **Exit**, then re-launch the Setup Wizard utility.
-

## 3.3 Web Configuration utility

The Web Configuration utility allows you to configure the ASUS Pocket Wireless AP using a web browser on your computer. The following sections provide information on how to launch and use this utility.

### Adjusting the TCP/IP settings

By default, the IP address of the ASUS Pocket Wireless AP is 192.168.1.1, and the Subnet Mask is 255.255.255.0. To access the configuration utility, assign a different IP address to the network adapter where the ASUS Pocket Wireless AP is connected.

To adjust the TCP/IP settings of the network adapter:

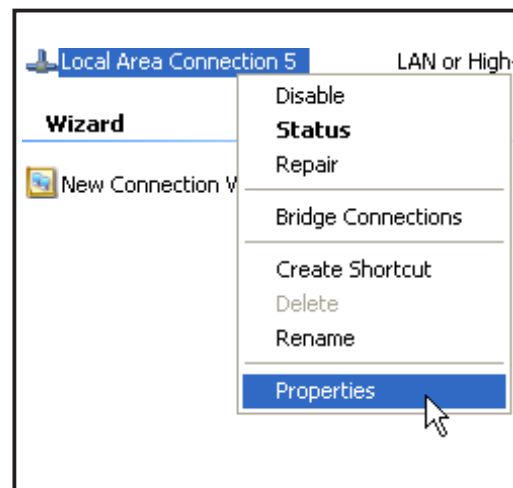
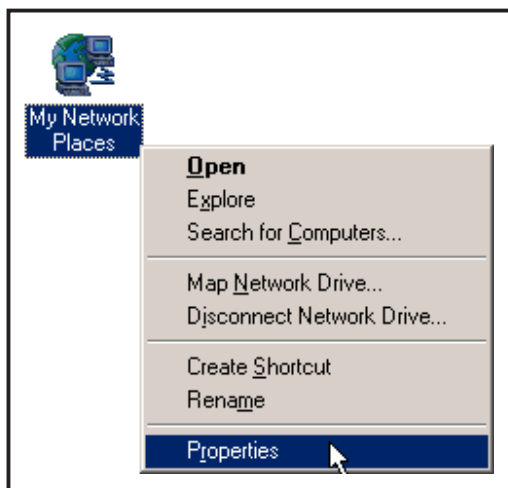

1. Right-click the **My Network Places** icon in the Windows® desktop, then select **Properties** from the pop-up menu. The **Network and Dial-up Connections** window appears.
2. Right-click the network adapter used by the the ASUS Pocket Wireless AP, then select **Properties** from the pop-up menu. The **Local Area Connection Properties** window appears.

# Configuration



3. Double-click the **Internet Protocol (TCP/IP)** item to display the **Internet Protocol (TCP/IP) Properties** window.



4. Check the **Use the following IP address** option, then enter the IP address for the network adapter. The **IP address** must be **192.168.1.X**. (**X** can be any number between 2 and 254 that is not used by another device.)



Changing the TCP/IP settings may require system reboot. Switch on the device immediately after rebooting.

5. Set the **Subnet Mask** to 255.255.255.0. Click **OK** when finished.



## 3.4 Launching the Web Configuration utility

To launch the Web Configuration utility:

1. Open a web browser.
2. Disable your web proxy, if you are using one.
3. Type `http://192.168.1.1` on the address bar, then press <Enter>.
4. The configuration utility home page appears.

The screenshot shows the ASUS Web Configuration utility interface. At the top, there is a navigation bar with three tabs: "Simple Setup" (selected), "Access Control", and "Firmware Upgrade". Below the navigation bar, the "Wireless Interface" section is highlighted in yellow. It contains the following fields and options:

- SSID: [Associated Stations](#) (with a link icon) | AP\_123456
- Response to Broadcast SSID requests
- Channel: Channel 1 (dropdown menu)
- Basic Rate Set:  1  2  5.5  11 Mbps
- Preamble: Long (dropdown menu)
- Authentication Method: Open System or Shared Key (dropdown menu)
- Encryption(WEP): None (dropdown menu)
- Pass Phrase: [Redacted]
- WEP Key 1 (10 or 26 hex digits): [Redacted]
- WEP Key 2 (10 or 26 hex digits): [Redacted]
- WEP Key 3 (10 or 26 hex digits): [Redacted]
- WEP Key 4 (10 or 26 hex digits): [Redacted]
- Default Key: [Redacted]

Below the Wireless Interface section, the "Ethernet Interface" section is also highlighted in yellow. It contains the following fields and options:

- Enable DHCP:
- Use the following IP Setting:
- Ip Address: 192.168.1.1
- Subnet Mask: 255.255.255.0
- Default Gateway: [Empty]

Setting Status: **Please Enter Valid Data.**

At the bottom of the form, there are two buttons: "Restore" and "Launch".

Below the buttons, there is a legend:

- Restore: Clear the above settings and restore the settings in effect.
- Launch: Confirm all settings and launch WL330 immediately.

The window displays the default values of the ASUS Pocket Wireless AP. If you wish to load the default values after changing these settings, press the reset button for more than five seconds. Refresh your browser to display the default values.

# Configuration

---

## 3.5 Access Point mode

### 3.5.1 Simple Setup

The **Simple Setup** page allows you to configure the ASUS Pocket Wireless AP configuration in access point mode.

#### Wireless Interface

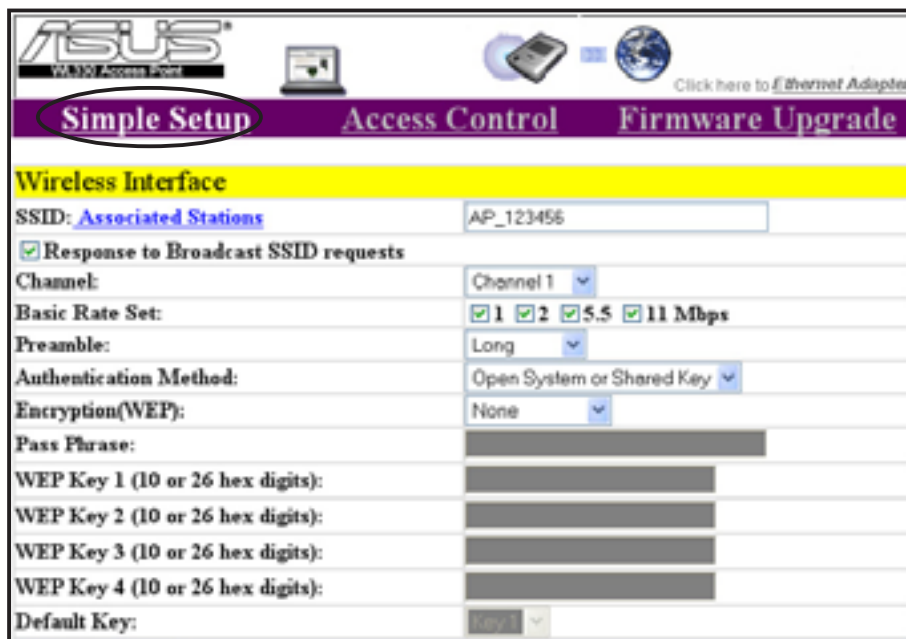

The screenshot shows the ASUS Wireless Interface configuration page. At the top, there is a navigation bar with three tabs: "Simple Setup" (which is selected and circled in red), "Access Control", and "Firmware Upgrade". Below the navigation bar, the "Wireless Interface" section is highlighted in yellow. The configuration fields are as follows:

SSID: <a href="#">Associated Stations</a>	AP_123456
<input checked="" type="checkbox"/> Response to Broadcast SSID requests	
Channel:	Channel 1
Basic Rate Set:	<input checked="" type="checkbox"/> 1 <input checked="" type="checkbox"/> 2 <input checked="" type="checkbox"/> 5.5 <input checked="" type="checkbox"/> 11 Mbps
Preamble:	Long
Authentication Method:	Open System or Shared Key
Encryption(WEP):	None
Pass Phrase:	[Redacted]
WEP Key 1 (10 or 26 hex digits):	[Redacted]
WEP Key 2 (10 or 26 hex digits):	[Redacted]
WEP Key 3 (10 or 26 hex digits):	[Redacted]
WEP Key 4 (10 or 26 hex digits):	[Redacted]
Default Key:	[Redacted]

**SSID (Service Set Identifier).** This field displays the SSID of the device.

Enabling the **Response to Broadcast SSID requests** option allows the device to broadcast its SSID in a wireless network. This allows other wireless devices to scan and establish communication with the device. Unchecking this option hides the SSID to prevent other wireless devices from recognizing and connecting to the device.

Click the **Associated Stations** link (beside the SSID) to displays the list of wireless device(s) associated with the ASUS Pocket Wireless AP. The list includes the wireless device(s) MAC address and connection status.



Click **Back** to return to the **Simple Setup** page.

**Channel.** Allows you to specify the channel the device uses to communicate with other wireless device(s) in the network.

The 802.11b specification supports up to 14 overlapping channels for radio communication. If several ASUS Pocket Wireless APs are operating in the same area, assign a non-overlapping channel to each device to avoid interference. Refer to page 3-24 for channel information.

**Basic Rate Set.** This option allows you to specify the data transmission rate. Select from 11, 5.5, 2 and 1 Mbps data transfer rate.

**Preamble.** Allows you to set the preamble mode for a 2.4GHz/11Mb network to Long, Short, or Auto. The default preamble mode is Long.

**Authentication Method.** The Authentication Method field allows you to enable or disable the Wired Equivalent Privacy (WEP) encryption. Refer to page 3-5 for details.

**Encryption.** This option allows you to specify a 64-bit or a 128-bit WEP key. A 64-bit encryption contains 10 hexadecimal digits or 5 ASCII characters. A 128-bit encryption contains 26 hexadecimal digits or 13 ASCII characters.



- 64-bit and 40-bit WEP keys use the same encryption method and can interoperate on wireless networks. This lower level of WEP encryption uses a 40-bit (10 hexadecimal digits assigned by the user) secret key and a 24-bit Initialization Vector assigned by the device. 104-bit and 128-bit WEP keys use the same encryption method.
- All wireless clients in a network must have identical WEP keys with the access point to establish connection. Keep a record of the WEP encryption keys.

# Configuration

---

**Pass Phrase.** Type a combination of up to 64 letters, numbers, or symbols in the Pass Phrase field. The Wireless Settings utility uses an algorithm to generate four WEP keys based on the typed combination.



This option allows you to use WEP keys without having to remember or write them down. The WEP keys generated using the Pass Phrase is compatible with other ASUS WLAN products. The Pass Phrase option is not as secure as manual assignment.

---

**Default Key.** This option allows you to select the default WEP key.

Click **Launch** after configuration to save your settings. Click **Restore** to load the default values.

## Ethernet Interface

The **Ethernet Interface** allows you to configure the network settings of the ASUS Pocket Wireless AP.

Ethernet Interface	
<input type="radio"/> Enable DHCP:	
<input checked="" type="radio"/> Use the following IP Setting:	
Ip Address:	192.168.1.1
Subnet Mask:	255.255.255.0
Default Gateway:	
Setting Status: Please Enter Valid Data.	
<input type="button" value="Restore"/>	<input type="button" value="Launch"/>
Restore: Clear the above settings and restore the settings in effect.	
Launch: Confirm all settings and launch WL330 immediately.	

**Enable DHCP.** When selected, the Dynamic Host Configuration Protocol (DHCP) server automatically assigns the IP address, Subnet Mask, and Default Gateway for the ASUS Pocket Wireless AP.

**Use the following IP setting.** Allows you to manually enter the IP address, Subnet Mask, and Default Gateway of the device.

Click **Launch** after configuring the network settings of the ASUS Pocket Wireless AP to save your settings. Click **Restore** to load the default values.

## 3.5.2 Access Control

The **Access Control** page allows you to control connection requests from other devices or enable the Wireless Distribution System (WDS) feature of the ASUS Pocket Wireless AP.

### MAC Access Control

Check **Accept association requests from any station** to accept all connection requests from other wireless devices. Disabling this option enables the **MAC Address** table.

The Media Access Control (MAC) is the hardware address a device in a network. Enter the MAC address(es) of wireless device(s) allowed to associate with the ASUS Pocket Wireless AP in the table.

Click **Launch** when done.

ASUS Wireless Access Point

Simple Setup **Access Control** Firmware Upgrade

MAC Access Control Wireless Distribution System

**MAC Access Control**

Accept association requests from any station

Stations allowed to be associated:

Number	MAC Address
1	00 00 00 00 00 00
2	00 00 00 00 00 00
3	00 00 00 00 00 00
4	00 00 00 00 00 00
5	00 00 00 00 00 00
6	00 00 00 00 00 00
7	00 00 00 00 00 00
8	00 00 00 00 00 00
9	00 00 00 00 00 00
10	00 00 00 00 00 00
11	00 00 00 00 00 00
12	00 00 00 00 00 00

Restore Launch

**Restore:** Clear the above settings and restore the settings in effect.  
**Launch:** Confirm all settings and launch WL330 immediately.

# Configuration

## Wireless Distribution System

The Wireless Distribution System allows your ASUS Pocket Wireless AP to communicate simultaneously with wireless clients (AP mode) and with other APs (wireless bridge mode) in your location. The WDS is a cost-effective and easy way of integrating multiple wireless networks.

Number	MAC Address
1	00:0C:6E:69:52:E9
2	00:00:00:00:00:00
3	00:00:00:00:00:00
4	00:00:00:00:00:00
5	00:00:00:00:00:00
6	00:00:00:00:00:00

**AP Mode.** The AP mode allows you to select the device mode in a WDS environment. Select an AP mode from the drop-down menu. Refer to the next section for details on the AP modes.

Access Point only  
Access Point only  
Hybrid-Active (connects to APs in the list)  
Hybrid-Passive (waits for anonymous connection)

**Channel.** Select the channel you wish to use in communicating with other APs in your location. All APs in a wireless bridge mode must specify the same channel to establish connection.

**WDS APs allowed to be connected.** This table allows you to specify the MAC address(s) of a device(s) allowed to connect to the ASUS Pocket Wireless AP. The table is activated only when the AP Mode is set to **Hybrid-Active**.

Click **Launch** after configuration to save your settings. Click **Restore** to load the default values.

## AP Modes

### Access Point Only

The ASUS Pocket Wireless AP is set to Access Point Only mode by default. In this mode, the device only performs as an AP that connects wireless clients to a wired Ethernet network. The picture below illustrates the device in Access Point Only mode.

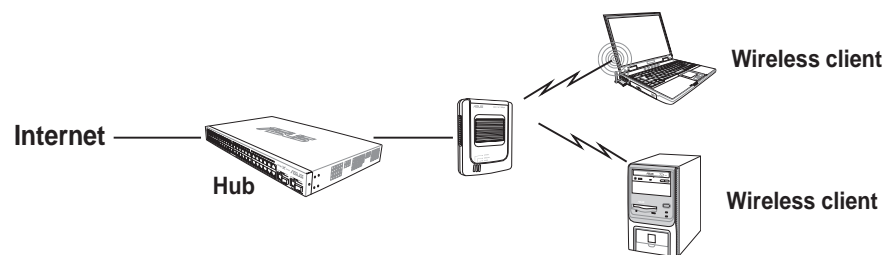

### Hybrid-Active

When set to Hybrid-Active mode, the ASUS Pocket Wireless AP actively connects to all APs specified in the MAC address list upon startup to form a **wireless bridge** while maintaining connection with the wireless clients in its own network. The MAC address list is enabled when the AP mode is set to Hybrid-Active.

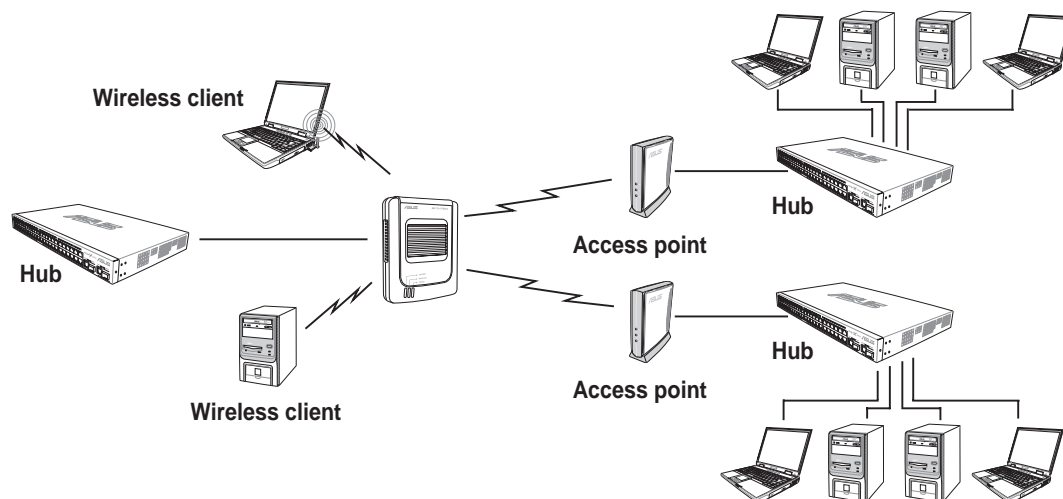

### Hybrid-Passive

The ASUS Pocket Wireless AP performs the same function in Hybrid-Passive mode. However, in this mode, the device waits for anonymous connection requests from other APs to form a wireless bridge. The MAC address list is disabled when you select this mode.

# Configuration

---

## WDS setup

To setup a Wireless Distribution System network:

1. Set the AP mode to **Hybrid-Active**.
2. Enter the MAC address(es) of the target AP(s) you wish to bridge with the ASUS Pocket Wireless AP in the MAC address list.
3. Specify the channel to be used. All target AP(s) must specify the same channel to establish connection to the ASUS Pocket Wireless AP.
4. Click **Launch**.

In a typical WDS network, the ASUS Pocket Wireless AP serves as a central link to all connected APs (functioning as wireless bridge). The APs communicate with each other using the central AP, while maintaining network connections to their respective wireless clients.

In this setup, WB4 and WB5 may communicate using point-to-point connection but WB5 may not communicate with the ASUS Pocket Wireless AP, WB1, WB2, and WB3 since multipoint-to-point connection is not supported.

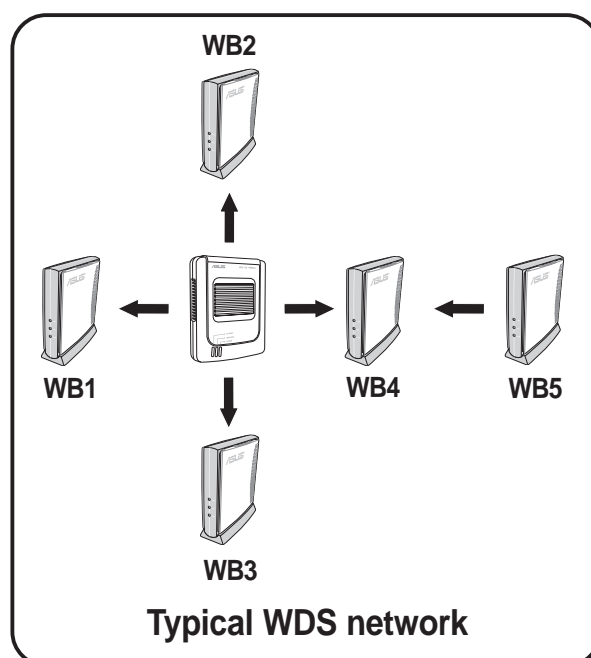



## 3.5.3 Firmware Upgrade

The **Firmware Upgrade** page displays the product ID, firmware version, and regulation domain. This page also allows you to restore or update the ASUS Pocket Wireless AP firmware when it becomes outdated or corrupted.



The Power LED blinks continuously when the firmware is corrupted or when the firmware upgrade fails.

To restore or update the device firmware:

1. Download the latest firmware file from the ASUS website ([www.asus.com](http://www.asus.com)).
2. Open the **Firmware Upgrade** window, then click **Browse**.
3. Select the updated firmware file when the **Choose file** window appears, then click **Open**.
4. Click the **Upgrade** button.

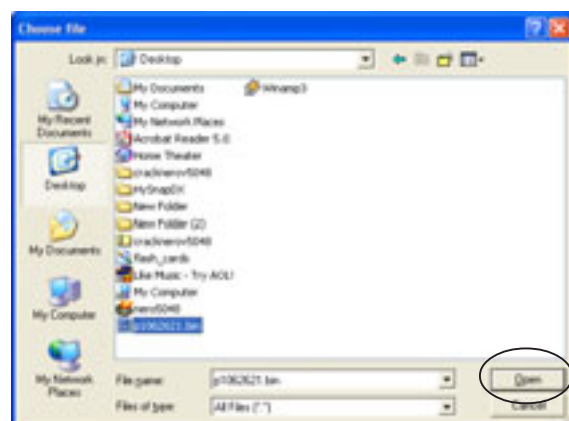

5. The browser displays this message after the firmware is successfully updated.



# Configuration

6. The browser displays this message when firmware updating fails.

Try updating the firmware again using the instructions in this section.



## Regulation Domain

IEEE 802.11b networks are regulated worldwide since these networks use the 2.4GHz ~ 2.5GHz ISM (Instrumentation, Scientific, and Medical) Band. The ASUS Pocket Wireless AP is shipped with a default regulation domain allowed in your country/location.

The FCC (US) and ETSI (Europe) specify operation from 2.4 GHz to 2.4835 GHz. For Japan, operation is specified as 2.4 GHz to 2.497 GHz. For each supported regulatory domain, all channels marked with “Yes” are supported. The channel center frequencies and CH ID numbers are shown below.

**Table 1: DSSS PHY frequency channel plan**

CH ID	Frequency	Regulatory Domains		
		X'10' FCC	X'30' ETSI	X'40' MKK
1	2412 MHz	Yes	Yes	Yes
2	2417 MHz	Yes	Yes	Yes
3	2422 MHz	Yes	Yes	Yes
4	2427 MHz	Yes	Yes	Yes
5	2432 MHz	Yes	Yes	Yes
6	2437 MHz	Yes	Yes	Yes
7	2442 MHz	Yes	Yes	Yes
8	2447 MHz	Yes	Yes	Yes
9	2452 MHz	Yes	Yes	Yes
10	2457 MHz	Yes	Yes	Yes
11	2462 MHz	Yes	Yes	Yes
12	2467 MHz	–	Yes	Yes
13	2472 MHz	–	Yes	Yes
14	2484 MHz	–	–	Yes

In a multiple cell network topology, overlapping and/or adjacent cells using different channels can operate simultaneously without interference if the distance between the center frequencies is at least 30 MHz. Channel 14 is specifically designated for operation in Japan.

**Table 2: Regulating bodies and allowed channels**

Country	Regulating body	Allowed channels
Unites States	FCC	1-11
Europe	ETSI	1-13
Japan	MKK	1-14

Use only the allowed channels when you set the ASUS Pocket Wireless AP in access point mode.

### 3.5.4 Restoring the default values

The following are the default values of the ASUS Pocket Wireless AP (AP mode). You may restore these values by pressing the reset button for more than five seconds.

Parameter	Default value
<i>Wireless Interface</i>	
SSID .....	AP_123456
Response to broadcast SSID requests .....	Enabled
Channel .....	1
Basic Rate Set .....	1, 2, 5.5, 11 Mbps
Preamble .....	Long
Authentication Method .....	Open System or Shared Key
Encryption .....	None
<i>Ethernet Interface</i>	
Get IP Address from DHCP Server .....	No
IP Address .....	192.168.1.1
Subnet Mask .....	255.255.255.0
Default Gateway .....	Blank
<i>Access Control</i>	
Accept association requests from any station .....	Enabled

# Configuration

## 3.6 Ethernet adapter mode

Click the link in the home page to configure the ASUS Pocket Wireless AP Ethernet adapter settings.



You must switch the device to Ethernet adapter mode using the mode switch before changing any Ethernet adapter setting. Any changes made in the Ethernet adapter configuration takes effect after switching the device in Ethernet adapter mode.

### 3.6.1 Simple Setup

The **Simple Setup** page allows you to configure the wireless and Ethernet properties of the ASUS Pocket Wireless AP.

#### Wireless Interface

The screenshot shows the configuration interface for the ASUS Pocket Wireless AP. At the top, there are navigation tabs: 'Simple Setup' (selected), 'Site Survey', and 'Firmware Upgrade'. Below the tabs is the 'Wireless Interface' section, which is highlighted in yellow. The settings are as follows:

SSID: (Enter "any" for joining the nearest AP)	ANY
Operating Mode:	<input checked="" type="radio"/> Infrastructure Mode <input type="radio"/> Ad-Hoc Mode
Channel:	Automatic
Transmission Rate:	Automatic
Preamble:	Long
Authentication Method:	Open System
Encryption(WEP):	None
Pass Phrase:	[Redacted]
WEP Key 1 (10 or 26 hex digits):	[Redacted]
WEP Key 2 (10 or 26 hex digits):	[Redacted]
WEP Key 3 (10 or 26 hex digits):	[Redacted]
WEP Key 4 (10 or 26 hex digits):	[Redacted]
Default Key:	[Redacted]
MAC Cloning:	<input checked="" type="checkbox"/> Enable
<b>Button Scan Mode</b>	
<input checked="" type="checkbox"/> Enable Button Scanning:	
Scan Mode:	Find the connection with the strongest link quality
Specified Profile:	Profile 1
Setting Status: <b>Please Enter Valid Data.</b>	
<input type="button" value="Restore"/> <input type="button" value="Launch"/>	
Restore:	Clear the above settings and restore the settings in effect.
Launch:	Confirm all settings and launch WL330 immediately.

**SSID (Service Set Identifier).** This field allows you to enter the SSID of the AP you wish to connect to. Enter "ANY" to connect to any available AP.

**Operating Mode.** This field allows you to select the operating mode for the Ethernet adapter. In **Infrastructure** operating mode, the ASUS Pocket Wireless AP connects to an available AP. In **Ad-hoc** operating mode, the ASUS Pocket Wireless AP connects to other wireless devices in a wireless network. Select **Ad-hoc** when there is no available AP in your area.

**Channel.** Select the channel used by the AP (Infrastructure) or the wireless device (Ad-hoc) to establish connection.

**Transmission Rate.** This field allows you to adjust the data transmission rate between the ASUS Pocket Wireless AP and the AP or other wireless device.

**Preamble.** Allows you to set the preamble mode for a 2.4GHz/11Mb network to Long, Short, or Auto. The default preamble mode is **Long**.

**Authentication Method.** The Authentication Method field allows you to enable or disable the Wired Equivalent Privacy (WEP) encryption. WEP encryption secures wireless data transmission between the ASUS Pocket Wireless AP and other devices in the wireless network. See page 3-5 for details.

**Encryption.** This option allows you to specify a 64-bit or a 128-bit WEP key. A 64-bit encryption contains 10 hexadecimal digits or 5 ASCII characters. A 128-bit encryption contains 26 hexadecimal digits or 13 ASCII characters. See page 3-5 for details.

**Pass Phrase.** Type a combination of up to 64 letters, numbers, or symbols in the Pass Phrase field. The ASUS Pocket Wireless AP utility uses an algorithm to generate four WEP keys based on the typed combination.

**Default Key.** This option allows you to select the default WEP key.

**MAC cloning.** MAC cloning allows the ASUS Pocket Wireless AP to use the MAC address of the host computer in communicating with other wireless devices. MAC cloning supports certain applications and devices such as Xbox and PlayStation® game consoles. MAC cloning is enabled by default.

# Configuration

---

## Button Scan Mode

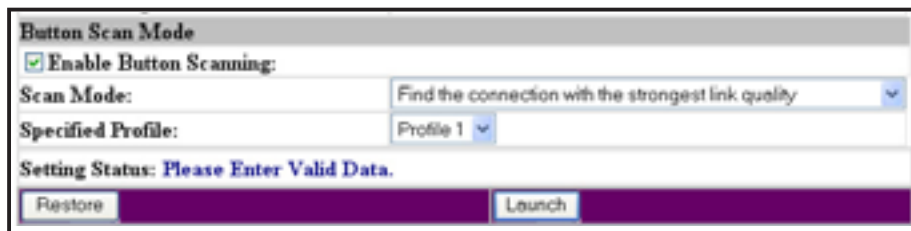

**Button Scan Mode.** The Button Scan Mode allows you to use the reset button to connect to an access point (Infrastructure mode) or wireless device (Ad-hoc mode) saved in the Profile Table of the configuration utility or in your location.

Save the profile of the wireless connection using the **Site Survey** window. See the next page for details.



You must save at least one wireless connection profile before using the Button Scan Mode.

---

**Scan Mode.** This field allows you to select the scan mode for button scanning. Click the arrow to display available options.

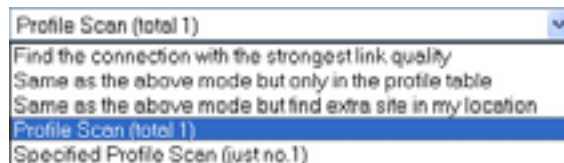

*Find the connection with the strongest link quality-* When the reset button is pressed for less than five seconds, the ASUS Pocket Wireless AP connects to an AP or wireless device with the strongest link quality.

*Same as the above mode but only in the profile table -* When the reset button is pressed for less than five seconds, the ASUS Pocket Wireless AP searches for an AP or wireless device in the Profile Table, then connects to the one with the strongest link quality.

*Same as the above mode but find extra site in my location-* When the reset button is pressed for less than five seconds, the ASUS Pocket Wireless AP searches for an AP or wireless device in the Profile Table and in your location, then connects to the one with the strongest link quality.

*Profile Scan (total x)-* This mode allows you to connect to a saved wireless network by their sequence in the Profile Table. Press the reset button once to connect to the first wireless connection in the Profile Table. Press again to connect to the second wireless connection, and so on.

## Configuration

---

For example, if you have three saved profiles in the profile table, the ASUS Pocket AP automatically connects to the first profile. Press the reset button to connect to the second saved profile. Press the reset button again to connect to the third saved profile.

*Specified profile scan (just no. x)*- When the reset button is pressed for less than five seconds, the ASUS Pocket Wireless AP automatically connects to the specified profile. The saved profiles are numbered from 1 ~ x. You must select the profile number using the Specified Profile field.



---

When using the Alphabet Scan, the AP or wireless device you wish to connect to must have a disabled WEP encryption and available SSID.

---

**Specified Profile.** This field allows you to select a saved wireless network in the Profile Table. The ASUS Pocket Wireless AP automatically connects to the selected profile when **Scan Mode** is set to **Specified profile scan**.

Click **Launch** when done. Click **Restore** to load the default values.



---

You may also press the reset button of the ASUS Pocket Wireless AP for more than five seconds to load the default values.

---

# Configuration

## 3.6.2 Site Survey

The screenshot displays the configuration interface for the ASUS WL330 Wireless Access Point. At the top, there are navigation tabs for 'Simple Setup', 'Site Survey' (which is selected), and 'Firmware Upgrade'. Below the tabs, the 'Station Status' section shows connection details: Connected SSID: ANY, Operating Mode: Infrastructure, Association: Associated on Channel 6, and WEP Key: Open System : No WEP Key Lock. A 'Save' button is located below this section. The 'Site Survey' section contains a table of detected wireless networks:

No	BSSID	SSID	CH	RSSI	Type
1	00:0d:18:9f:44:3f		6	32	AP
2	00:0c:6e:a1:81:0e	DOA_5125	1	30	AP
3	00:0d:18:9f:43:1f		7	22	AP
4	00:0d:18:9f:43:2d	ASUS	6	11	AP
5	00:0c:6e:b4d:99	AP_000017	1	5	AP
6	00:0c:6e:b4d:96	MIS-QTR-one	9	1	AP

Below the table, there is a 'Select a Site to join:' dropdown menu with '1' selected and a 'Join' button. At the bottom, there are buttons for 'Restore' and 'Launch'. A legend at the very bottom explains the functions: 'Save' saves the current available connection to profile immediately; 'Join' joins a site immediately; 'Restore' clears the above settings and returns the settings in effect; 'Launch' scans all sites near WL330 immediately.

### Station Status

The Station Status field displays various connection information including the SSID and WEP key information of the AP or wireless device the ASUS Pocket Wireless AP is connected to. This field also displays the operating mode and association state of the ASUS Pocket Wireless AP.

Click the **Save** button to save the connection and open the **Profile Table** page.



## Profile Table

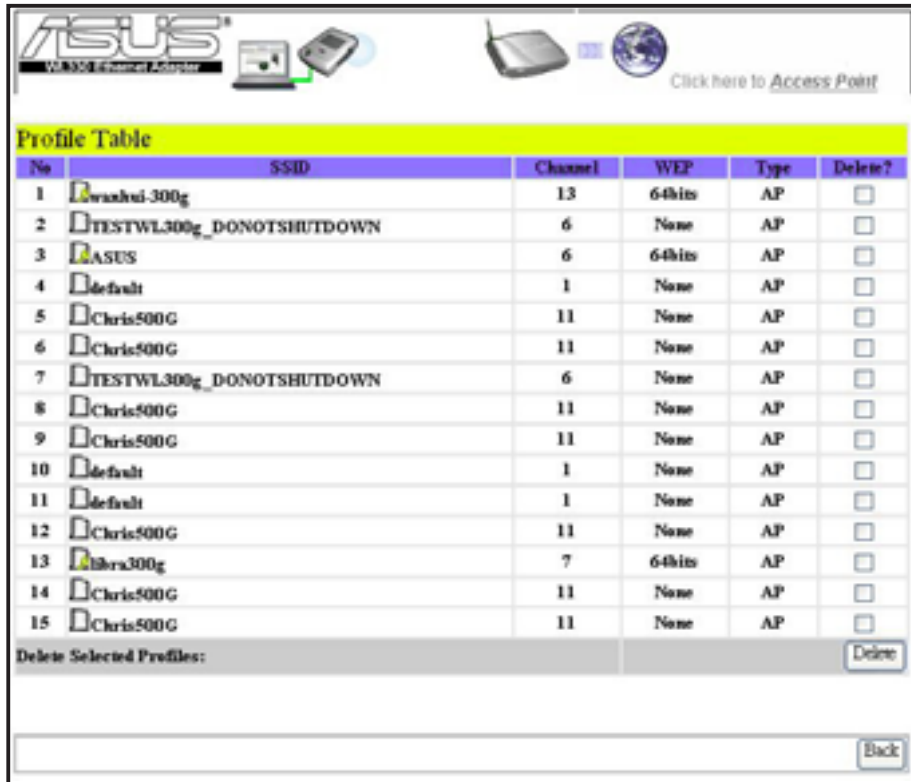

The screenshot shows the ASUS Wireless Access Point configuration interface. At the top, there is the ASUS logo and the text "WL330 Wireless Access Point". Below the logo, there are icons for a laptop, a mobile phone, and a wireless access point. A link "Click here to Access Point" is visible. The main content is a table titled "Profile Table" with the following columns: No, SSID, Channel, WEP, Type, and Delete?. The table contains 15 rows of profile information. Below the table, there is a "Delete Selected Profiles:" label and a "Delete" button. At the bottom right, there is a "Back" button.

No	SSID	Channel	WEP	Type	Delete?
1	wanhui_300g	13	64bits	AP	<input type="checkbox"/>
2	TESTWL300g_DONOTSHUTDOWN	6	None	AP	<input type="checkbox"/>
3	ASUS	6	64bits	AP	<input type="checkbox"/>
4	default	1	None	AP	<input type="checkbox"/>
5	Chris500G	11	None	AP	<input type="checkbox"/>
6	Chris500G	11	None	AP	<input type="checkbox"/>
7	TESTWL300g_DONOTSHUTDOWN	6	None	AP	<input type="checkbox"/>
8	Chris500G	11	None	AP	<input type="checkbox"/>
9	Chris500G	11	None	AP	<input type="checkbox"/>
10	default	1	None	AP	<input type="checkbox"/>
11	default	1	None	AP	<input type="checkbox"/>
12	Chris500G	11	None	AP	<input type="checkbox"/>
13	libra300g	7	64bits	AP	<input type="checkbox"/>
14	Chris500G	11	None	AP	<input type="checkbox"/>
15	Chris500G	11	None	AP	<input type="checkbox"/>

The **Profile Table** displays the saved wireless connections including their SSID, channel, WEP encryption, and network type. An icon marks a saved connection to indicate whether the ASUS Pocket Wireless AP is connected or not. Refer to page 3-8 for icon indications.

# Configuration

## Deleting a saved wireless connection

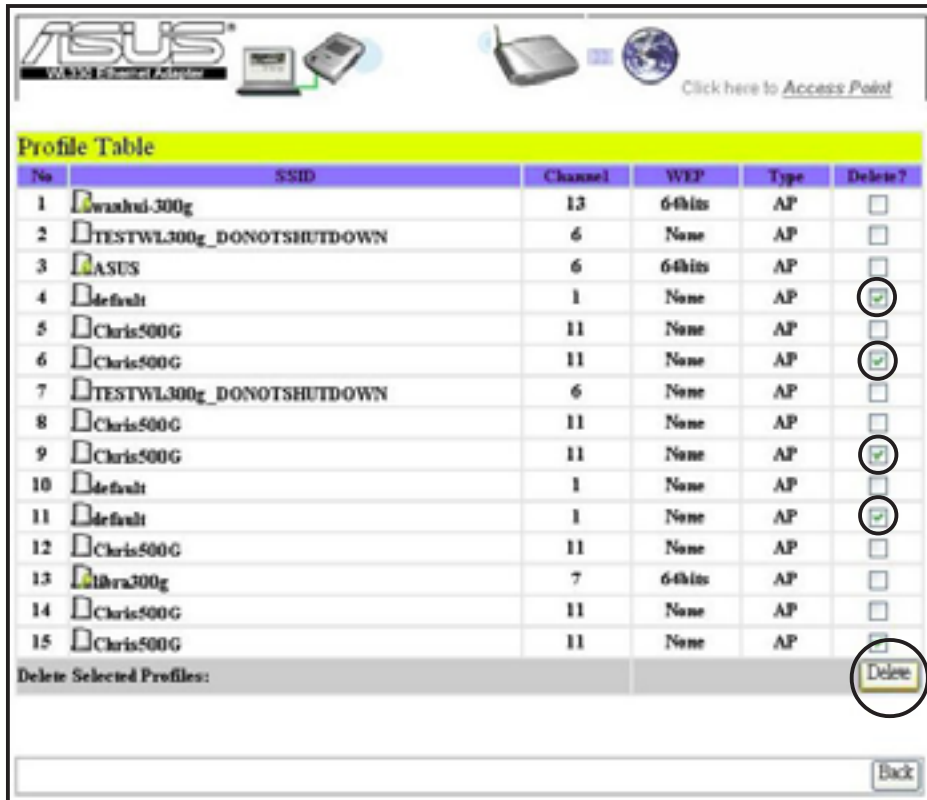

To delete a saved wireless connection:

1. Check the **Delete** box of the wireless connection you wish to delete.
2. Click the **Delete** button.
3. The browser refreshes to display the remaining available wireless connections in the Profile Table.

## Site Survey

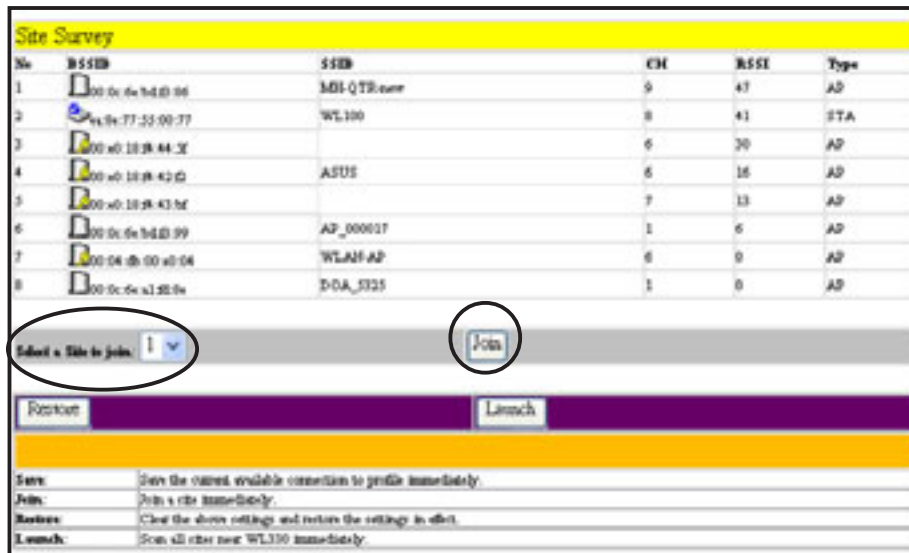

The **Site Survey** field allows you to join a wireless connection. Select the wireless connection you want to join in the drop-down menu, then click the **Join** button. The wireless connections BSSID are marked with icons for easy identification. Refer to the table on page 3-8 for icon indications. The Site Survey column headings are defined below.

**BSSID.** The Basic Service Set Identifier (BSSID) is the IEEE MAC address of the wireless connection.

**SSID.** SSID refers to the service set identifier of the wireless connection.

**CH.** The direct sequence channel used by the wireless connection.

**RSSI.** Received Signal Strength Indicator (RSSI) is a measurement of connection strength in dBm.

**Type.** Tells whether a wireless connection is in access point (AP) or station (STA) mode.

# Configuration

---

## Joining a wireless connection with a hidden SSID

1. Select a wireless connection with hidden SSID from the **Site Survey** field, then click **Join**. The following page appears.

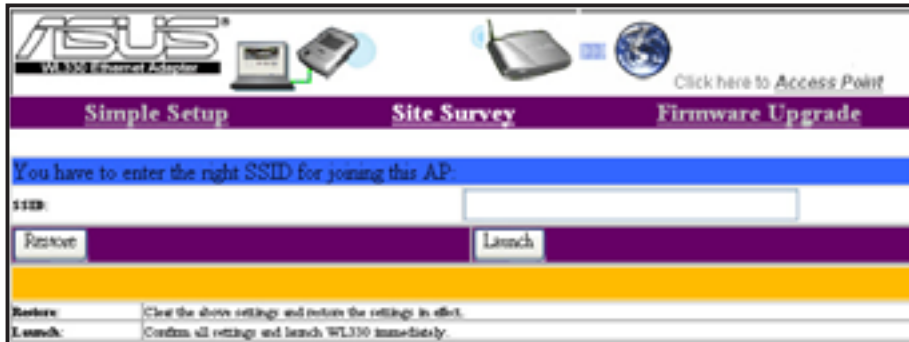

The screenshot shows the ASUS WL330 configuration interface. At the top, there is a navigation bar with three tabs: "Simple Setup", "Site Survey", and "Firmware Upgrade". Below the navigation bar, a blue banner reads "You have to enter the right SSID for joining this AP:". Underneath, there is a text input field labeled "SSID" and a "Launch" button. At the bottom, there are two buttons: "Restart" and "Launch". A small text box at the bottom left explains the "Restart" and "Launch" buttons.

2. Obtain the correct SSID of the wireless connection from your network administrator.
3. Enter the SSID you have obtained in the SSID field, then click **Launch**.

## Joining a wireless connection with WEP encryption

1. Select a WEP-encrypted wireless connection from the **Site Survey** field, then click **Join**. The following page appears.



The screenshot shows the ASUS WL330 configuration interface for WEP encryption. At the top, there is a navigation bar with three tabs: "Simple Setup", "Site Survey", and "Firmware Upgrade". Below the navigation bar, a blue banner reads "You have to enter the right WEP Key for joining this AP:". Underneath, there are several fields: "Authentication Method" (set to "Open System or Shared Key"), "Encryption(WEP)" (set to "None"), "Pass Phrase" (a text input field), and four "WEP Key" fields (WEP Key 1, WEP Key 2, WEP Key 3, WEP Key 4), each with a text input field. At the bottom, there are two buttons: "Restart" and "Launch". A small text box at the bottom left explains the "Restart" and "Launch" buttons.

2. Obtain the correct WEP keys of the wireless connection from your network administrator.
3. Enter the WEP keys you have obtained in the WEP key fields, then click **Launch**.

## Joining a wireless connection with a hidden SSID and enabled WEP encryption

1. The following page appears if you selected a wireless connection with a hidden SSID and enabled WEP encryption from the **Site Survey** field.

The screenshot shows the ASUS WL330 Firmware Administrator interface. At the top, there are three tabs: "Simple Setup", "Site Survey", and "Firmware Upgrade". The "Site Survey" tab is selected. Below the tabs, there is a blue banner with the text: "You have to enter Both the right SSID and WEP Key for joining this AP." The main configuration area includes the following fields:

- SSID: [Empty text box]
- Authentication Method: [Open System or Shared Key]
- Encryption(WEP): [None]
- Pass Phrase: [Masked]
- WEP Key 1 (10 or 26 hex digits): [Masked]
- WEP Key 2 (10 or 26 hex digits): [Masked]
- WEP Key 3 (10 or 26 hex digits): [Masked]
- WEP Key 4 (10 or 26 hex digits): [Masked]
- Default Key: [Dropdown menu]

At the bottom of the configuration area, there are two buttons: "Previous" and "Launch". Below the buttons, there is a yellow bar. At the very bottom, there are two small text boxes:

- Refresh: Clear the above settings and restore the settings in effect.
- Launch: Confirm all settings and launch WL330 immediately.

2. Obtain the correct SSID and WEP keys of the wireless connection from your network administrator.
3. Enter the SSID and WEP keys you have obtained in the SSID and WEP key fields, then click **Launch**.

# Configuration

---

## 3.6.3 Firmware Upgrade

The **Firmware Upgrade** page displays the product ID, firmware version, and regulation domain. This page also allows you to restore or update the ASUS Pocket Wireless AP firmware when it becomes outdated or corrupted. Refer to page 3-23 for details.

## 3.6.4 Restoring the default values

The following are the default values of the ASUS Pocket Wireless AP (Ethernet adapter mode). You may restore these values by pressing the reset button more than five seconds.

Parameter	Default value
<i>Wireless Interface</i>	
SSID .....	ANY
Operating Mode .....	Infrastructure Mode
Channel .....	1
Transmission Rate .....	Automatic
Preamble .....	Long
Authentication Method .....	Open System or Shared Key
Encryption .....	None
MAC cloning .....	Enabled
<i>Button Scan Mode</i>	
Button Scanning .....	Enabled
Scan Mode .....	Find the connection with the ..... strongest link quality
Specified Profile .....	Profile 1

## 3.7 Firmware Restoration

The **Firmware Restoration** utility is a rescue tool for an ASUS Pocket Wireless AP that failed during a previous firmware upload. This utility is available in the support CD that came with the ASUS Pocket Wireless AP package.

A failed firmware upgrade causes the ASUS Pocket Wireless AP to enter a failure mode. Use the Firmware Restoration utility to find and upload a new firmware for the ASUS Pocket Wireless AP.

To restore the ASUS Pocket Wireless AP firmware using the Firmware Restoration utility:

1. Launch the Firmware Restoration utility from the Windows® desktop by clicking **Start > All Programs > ASUS Utility > Wireless AP WL-330 > Firmware Restoration**.
2. The **Firmware Restoration** window appears.
3. Click the **Browse** button to locate the firmware file.
4. After the firmware file is selected, click the **Upload** button to begin restoration.

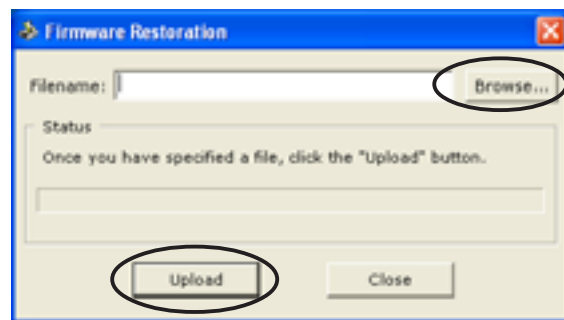

The restoration process takes about 3 to 4 minutes. During restoration, the Power, and Wireless LEDs remain lit, while the Ethernet LED flashes slowly.



If you have problems uploading a firmware while using a network hub, try connecting your computer directly to the LAN port.





# Chapter 4

This chapter provides step-by-step instructions on how to setup your ASUS Pocket Wireless AP.

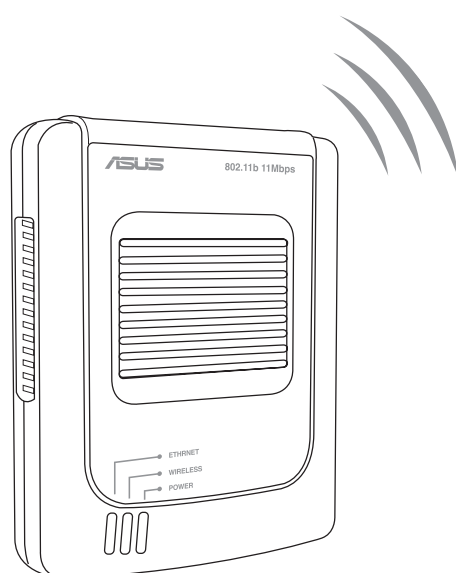

## ▶ *Simple Setup*

## Simple setup

---

This simple setup guide provides instructions on how to use your ASUS Pocket Wireless AP in various operating modes and conditions.

### 4.1 Using the device in a local network

In a local network, you may use the ASUS Pocket Wireless AP to connect a WLAN-enabled desktop PC or notebook with or without a DHCP server.

To connect a WLAN-enabled desktop PC or notebook to the ASUS Pocket Wireless AP:

1. Switch the device to AP mode using the mode switch. (Default SSID: AP\_XXXXXX)
2. Turn on the ASUS Pocket Wireless AP, then connect one end of the RJ-45 cable to the Ethernet port of the device and the other end to the Ethernet port of the local network
3. Use the WLAN adapter software in your desktop PC or notebook to perform a Site Survey. Make sure the desktop PC or notebook WLAN adapter is set to Infrastructure mode.
4. Establish connection with the ASUS Pocket Wireless AP.
5. Set the IP configuration of the desktop PC or notebook to establish connection to the local network.
6. Check your connection.



---

Use the Web Configuration utility only if you need to change the device SSID or WEP encryption settings.

---

### 4.2 Replacing the desktop PCs or notebooks Ethernet cables

Follow these instructions to replace your desktop PC or notebook cable connection to an ADSL or cable modem with the ASUS Pocket Wireless AP.

1. Switch the device to AP mode using the mode switch. (Default SSID: AP\_XXXXXX)
2. Turn on the ASUS Pocket Wireless AP, then connect one end of the RJ-45 cable to the Ethernet port of the device and the other end to the Ethernet port of the ADSL or cable modem.

3. Use the WLAN adapter software in your desktop PC or notebook to perform a Site Survey. Make sure the desktop PC or notebook WLAN adapter is set to Infrastructure mode.
4. Establish connection with the ASUS Pocket Wireless AP.
5. Set the IP configuration of the desktop PC or notebook to establish connection to the Internet.
6. Check your connection.

### 4.3 Replacing the Ethernet cables of other devices

Follow these instructions to replace your Xbox, PlayStation® 2, SETUP-box, or network printer Ethernet cable connection with the ASUS Pocket Wireless AP.

1. Switch the device to Ethernet adapter mode using the mode switch. (Default SSID: ANY)
2. Place the ASUS Pocket Wireless AP nearest the AP you wish to connect, then turn on the device.
3. Connect one end of the RJ-45 cable to the Ethernet port of the device and the other end to the Ethernet port of the Xbox, Playstation, SETUP-box, or network printer.



---

If you failed to connect to an AP, press the reset button of the ASUS Pocket Wireless AP for more than 5 seconds to load the default settings of the Button Scan mode.

---

4. Set the IP configuration of the Xbox, Playstation, SETUP-box, or network printer to establish connection.
5. Check your connection.

## Simple setup

---

### 4.4 Connecting to another AP as an adapter or wireless bridge

Follow these instructions to set your ASUS Pocket Wireless LAN AP as a WLAN adapter to access another AP with disabled WEP encryption and valid SSID.

1. Switch the device to Ethernet adapter mode using the mode switch. (Default SSID: ANY in an Infrastructure network)
2. Place the ASUS Pocket Wireless AP nearest the AP you wish to connect, then turn on the device.



---

If you failed to connect to an AP, press the reset button of the device to load the Button Scan mode default settings.

---

3. Connect one end of the RJ-45 cable to the Ethernet port of the device and the other end to the Ethernet port of your desktop PC or notebook.
4. Set the IP configuration of the desktop PC or notebook to establish connection to the local network.
5. Check your connection.

# Chapter 5

This chapter contains a troubleshooting guide for solving common problems you may encounter when using the ASUS Pocket Wireless AP.

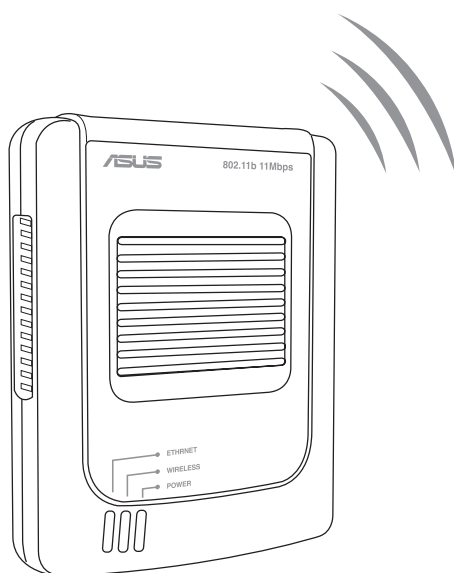

## ▶ *Troubleshooting*

# Troubleshooting

---

This troubleshooting guide provides solutions to some common problems that you may encounter while installing and/or using ASUS Pocket Wireless AP. These problems require simple troubleshooting that you can perform by yourself. Contact the ASUS Technical Support if you encounter problems not mentioned in this section.

Problem	Action
<b>The ASUS Pocket Wireless AP does not power up.</b>	<ul style="list-style-type: none"><li>• Use a test meter to measure the voltage output of the power source through the power plug.</li><li>• Check if the power plug is properly connected to the device.</li></ul>
<b>Other devices cannot communicate with the ASUS Pocket Wireless AP through a wired network connection.</b>	<ul style="list-style-type: none"><li>• Verify your network configuration to ensure that there is no IP address duplication. Turn off the device in question, then ping the assigned IP address of the device. Make sure no other device responds to that address.</li><li>• Check if the cables have the proper pin outs and connectors. You may also use another LAN cable.</li><li>• Make sure the hub, switch, or computer connected to the ASUS Pocket Wireless AP supports 10Mbps speed.  Do this by check the ASUS Pocket Wireless AP and the Hub LEDs. When you connect the ASUS Pocket Wireless AP to a 10/100 Mbps hub, both the Hub LED and the ASUS Pocket Wireless AP Ethernet LEDs should light up.</li></ul>

Problem	Action
<p data-bbox="264 954 756 1077"><b>My ASUS WLAN card can not associate with the ASUS Pocket Wireless AP.</b></p>	<p data-bbox="836 454 1342 887">When you connect the ASUS Pocket Wireless AP to a pure 10/100 Mbps hub, the Hub LED turns off while the ASUS Pocket Wireless AP Ethernet LED lights up. The ASUS Pocket Wireless AP LEDs indicate that the connection is good or bad. Observe the hub LED if you are not sure if the hub is 10/100Mbps or pure 10/1000 Mbps.</p> <ul data-bbox="807 954 1342 1906" style="list-style-type: none"><li>• Make sure your WLAN card has the same specifications as the WLAN Access Point (IEEE 802.11b).</li><li>• Minimize the distance between the devices. The ASUS WLAN card may be out of range of the ASUS Pocket Wireless AP.</li><li>• Check if the ASUS Pocket Wireless AP and the ASUS WLAN card have the same SSID.</li><li>• When WEP encryption is enabled, check if the ASUS Pocket Wireless AP and the ASUS WLAN card have the same Encryption settings.</li><li>• Check if the ASUS Pocket Wireless AP Wireless and Ethernet LEDs are on and not blinking.</li><li>• When the Access Control table is enabled, check if the MAC address of the ASUS WLAN card is included in the Access Control table.</li></ul>

# Troubleshooting

Problem	Action
<p><b>The throughput seems slow.</b></p>	<ul style="list-style-type: none"><li>• Check if the ASUS Pocket Wireless AP is in “Access Point” mode.</li><li>• Check if the ASUS Pocket Wireless AP and ASUS WLAN card have the same preamble mode.</li></ul> <p>Avoid placing the device behind a metal object. Clear obstacles between the AP and the device. Try moving the client closer to the ASUS Pocket Wireless AP and check if the throughput increases. Consider adding a second ASUS Pocket Wireless AP to implement roaming.</p> <p>You may also check if:</p> <ul style="list-style-type: none"><li>• The connectors and cabling are properly installed.</li><li>• Network traffic does not exceed 37% of the total bandwidth.</li><li>• Wired network does not exceed 10 broadcast messages per second.</li><li>• Your wired network topology and configuration are correct.</li></ul>
<p><b>I can not access the ASUS Pocket Wireless AP web configuration page.</b></p>	<p>To access the ASUS Pocket Wireless AP web configuration page, your computer must have the same subnet as that of the ASUS Pocket Wireless AP.</p> <p>Adjust your network if your computer’s subnet does not match that of the ASUS Pocket Wireless AP.</p>



Problem	Action
	<p>The default subnet of the ASUS Pocket Wireless AP is “192.168.1.1”.</p> <p>In special cases, when the ASUS Pocket Wireless AP joins an AP network with the same IP address, reset the ASUS Pocket Wireless AP to access the web configuration page.</p>
<b>Where can I get a firmware file to upgrade the ASUS Pocket Wireless AP?</b>	<p>You may download the latest firmware file from the ASUS website (<a href="http://www.asus.com">www.asus.com</a>).</p> <p>Use the Firmware Upgrade page in the configuration utility to update the ASUS Pocket Wireless AP firmware.</p>
<b>The ASUS Pocket Wireless AP Power LED continuously blinks for more than a minute.</b>	<p>Turn off the ASUS Pocket Wireless AP. Turn the device again and observe if the Power LED stops blinking.</p> <p>If the blinking stops, you may have pressed the reset button when you previously turned on the device.</p> <p>If the blinking continues, you need to restore the ASUS Pocket Wireless AP firmware. Use the Firmware Restoration utility to restore or update the ASUS Pocket Wireless AP firmware.</p>

## Troubleshooting

---

Problem	Action
<p><b>The ASUS Pocket Wireless AP reboots more than twice when you switch to Ethernet adapter mode.</b></p>	<p>The ASUS Pocket Wireless AP, when set to Ethernet adapter mode implements the Auto-Search feature. This feature searches the wireless connection with maximum power everytime you turn on the ASUS Pocket Wireless AP.</p> <p>If the ASUS Pocket Wireless AP finds a more powerful wireless connection, it automatically replaces the current connection, then connects to the new wireless connection. The ASUS Pocket Wireless AP then reboots.</p> <p>After rebooting, the ASUS Pocket Wireless AP again searches the wireless connection with the maximum power.</p> <p>If the wireless connection with the maximum power is the same with the current settings, the ASUS Pocket Wireless AP stops the search and reboot process.</p>
<p><b>A wireless client wants to connect to the ASUS Pocket Wireless AP but can not get the correct IP from the DHCP server. (The ASUS Pocket Wireless AP has an enabled DHCP.)</b></p>	<p>Make sure the DHCP server is working properly. Some DHCP servers can only assign one IP address at a time. In this case, assign a fixed IP address to your ASUS Pocket Wireless AP.</p>