

# *PLA-4xx Series*

*Powerline Ethernet Adapter Series (PLA-400/400 v2/401/401 v2/  
402 v2/470/470 v2)*

## ***User's Guide***

Version 3.0.5  
1/2008  
Edition 2





# About This User's Guide

## Intended Audience

This manual is intended for people who want to configure the PLA-400, PLA-400 v2, PLA-401, PLA401 v2, PLA402 v2, PLA-470 and PLA470 v2 using the PLA-4xx Series Configuration Utility version 3.0.5(AG). You should have your basic Internet access or home network already set up.

## Related Documentation

- Quick Start Guide  
The Quick Start Guide is designed to help you get up and running right away. It contains information on making your hardware connections.
- Supporting Disk  
Refer to the included CD for support documents.
- ZyXEL Web Site  
Please refer to [www.zyxel.com](http://www.zyxel.com) for additional support documentation and product certifications.

## User Guide Feedback

Help us help you. Send all User Guide-related comments, questions or suggestions for improvement to the following address, or use e-mail instead. Thank you!

The Technical Writing Team,  
ZyXEL Communications Corp.,  
6 Innovation Road II,  
Science-Based Industrial Park,  
Hsinchu, 300, Taiwan.

E-mail: [techwriters@zyxel.com.tw](mailto:techwriters@zyxel.com.tw)

# Document Conventions

## Warnings and Notes

These are how warnings and notes are shown in this User's Guide.



---

Warnings tell you about things that could harm you or your device.

---



---

Notes tell you other important information (for example, other things you may need to configure or helpful tips) or recommendations.

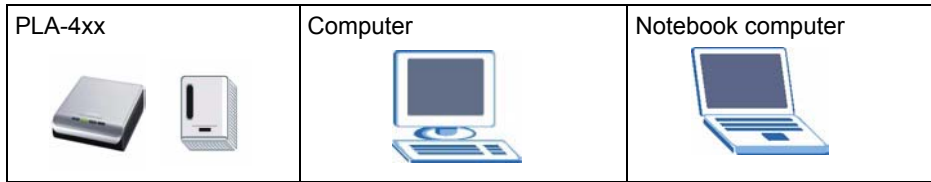
---

## Syntax Conventions

- The PLA-400, PLA-400 v2, PLA-401, PLA401 v2, PLA402 v2, PLA-470 and PLA470 v2 may be referred to as the “PLA-4xx”, the “ZyXEL device”, the “device” or the “powerline adapter” in this User's Guide.
- The PLA-4xx Series Configuration Utility version 3.0.5(AG) may be referred to as the “configuration utility” or the “utility” in this User's Guide.
- Product labels, screen names, field labels and field choices are all in **bold** font.
- A key stroke is denoted by square brackets and uppercase text, for example, [ENTER] means the “enter” or “return” key on your keyboard.
- “Enter” means for you to type one or more characters and then press the [ENTER] key. “Select” or “choose” means for you to use one of the predefined choices.
- A right angle bracket ( > ) within a screen name denotes a mouse click. For example, **Maintenance > Log > Log Setting** means you first click **Maintenance** in the navigation panel, then the **Log** sub menu and finally the **Log Setting** tab to get to that screen.
- Units of measurement may denote the “metric” value or the “scientific” value. For example, “k” for kilo may denote “1000” or “1024”, “M” for mega may denote “1000000” or “1048576” and so on.
- “e.g.,” is a shorthand for “for instance”, and “i.e.,” means “that is” or “in other words”.

### Icons Used in Figures

Figures in this User's Guide may use the following generic icons. The PLA-4xx icons used may not be an exact representation of your device.



# Safety Warnings



---

For your safety, be sure to read and follow all warning notices and instructions.

---

- Do NOT use this product near water, for example, in a wet basement or near a swimming pool.
- Do NOT expose your device to dampness, dust or corrosive liquids.
- Do NOT store things on the device.
- Do NOT install, use, or service this device during a thunderstorm. There is a remote risk of electric shock from lightning.
- Connect ONLY suitable accessories to the device.
- Do NOT open the device or unit. Opening or removing covers can expose you to dangerous high voltage points or other risks. ONLY qualified service personnel should service or disassemble this device. Please contact your vendor for further information. **For devices that use any external cables or cords [e.g., not for wireless cards]**
- Make sure to connect the cables to the correct ports.
- Place connecting cables carefully so that no one will step on them or stumble over them.
- Always disconnect all cables from this device before servicing or disassembling.
- Use ONLY an appropriate power adapter or cord for your device.
- Connect the power adapter or cord to the right supply voltage (for example, 110V AC in North America or 230V AC in Europe).
- Do NOT allow anything to rest on the power adapter or cord and do NOT place the product where anyone can walk on the power adapter or cord.
- Do NOT use the device if the power adapter or cord is damaged as it might cause electrocution.
- If the power adapter or cord is damaged, remove it from the power outlet.
- Do NOT attempt to repair the power adapter or cord. Contact your local vendor to order a new one.
- Do not use the device outside, and make sure all the connections are indoors. There is a remote risk of electric shock from lightning.
- Do NOT obstruct the device ventilation slots, as insufficient airflow may harm your device.
- If you wall mount your device, make sure that no electrical lines, gas or water pipes will be damaged.

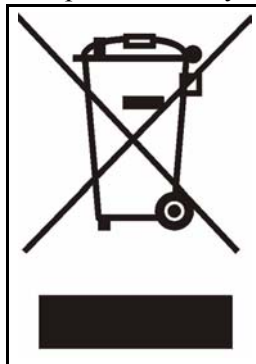
PLA-401 v2 models only:

- This power unit is intended to be correctly orientated in a vertical or floor mount position.

PLA-402 v2 models only:

- Make sure that the cable system is grounded so as to provide some protection against voltage surges.

This product is recyclable. Dispose of it properly.







# Table of Contents

<b>About This User's Guide .....</b>	<b>3</b>
<b>Document Conventions.....</b>	<b>4</b>
<b>Safety Warnings.....</b>	<b>6</b>
<b>Table of Contents.....</b>	<b>9</b>
<b>List of Tables.....</b>	<b>13</b>
<b>List of Figures .....</b>	<b>15</b>
<b>Part I: Introduction.....</b>	<b>17</b>
<b>Chapter 1</b>	
<b>Introducing the PLA-4xx .....</b>	<b>19</b>
1.1 Overview .....	19
1.2 Expand Your Network with the PLA-4xx .....	19
1.3 Coaxial Cable Networks with the PLA402 v2 .....	20
1.4 Ways to Manage the PLA-4xx .....	20
1.5 Security .....	21
1.5.1 Passwords .....	21
1.5.2 Setting Up Security .....	21
1.6 Multiple Networks .....	22
<b>Chapter 2</b>	
<b>Installing the Utility.....</b>	<b>23</b>
2.1 Overview of the Installation Process .....	23
2.2 Installing the Utility .....	23
<b>Part II: Managing the PLA-4xx .....</b>	<b>29</b>
<b>Chapter 3</b>	
<b>Firmware Tools.....</b>	<b>31</b>
3.1 Firmware Detection Tool .....	31
3.1.1 Firmware Detection Issues .....	31
3.1.2 Firmware Detection Procedure .....	32

3.2 Firmware Upgrade Tool .....	34
<b>Chapter 4</b>	
<b>The ENCRYPT Button .....</b>	<b>37</b>
4.1 ENCRYPT Button Overview .....	37
4.2 Set Up a HomePlug AV Network with ENCRYPT .....	37
4.3 Setting Up Multiple Networks .....	39
4.4 ENCRYPT Button Behavior .....	41
<b>Chapter 5</b>	
<b>The Configuration Utility .....</b>	<b>43</b>
5.1 Overview .....	43
5.1.1 Powerline Network Security .....	44
5.1.2 Device Access Key (DAK) .....	44
5.2 Starting the Configuration Utility .....	44
5.3 Configuration Screen .....	45
5.4 Firmware Screen .....	46
5.5 Network Info Screen .....	47
5.6 Advanced Screen .....	48
5.7 About Screen .....	51
<b>Chapter 6</b>	
<b>Powerline Network Setup Tutorial .....</b>	<b>53</b>
6.1 Overview .....	53
6.1.1 Important Terms .....	54
6.1.2 Accessing Your Powerline Adapter .....	54
6.1.3 Adding a Powerline Adapter .....	55
6.1.4 Setting Up a New Network with a New Adapter .....	57
6.1.5 Splitting a Network into Two Networks .....	58
6.2 Troubleshooting .....	61
<b>Chapter 7</b>	
<b>LEDs and Troubleshooting .....</b>	<b>63</b>
7.1 LEDs .....	63
7.1.1 PLA-401/PLA401 v2 .....	63
7.1.2 PLA-400/400 v2/402 v2 .....	65
7.1.3 PLA-470/PLA470 v2 .....	66
7.2 Power and Light Problems .....	68
7.3 Configuration Utility Problems .....	70
7.4 Powerline Problems .....	70
7.5 ENCRYPT Button Problems .....	71

**Part III: Appendices and Index..... 73**

Appendix A Product Specifications..... 75

Appendix B Legal Information ..... 81

Appendix C Customer Support..... 85

**Index..... 91**



# List of Tables

Table 1 Password Summary .....	21
Table 2 Firmware Detection Tool: Result Screen .....	33
Table 3 Time <b>ENCRYPT</b> Button is Pressed and Action .....	41
Table 4 Configuration Screen .....	45
Table 5 Network Info Screen .....	48
Table 6 Priority Settings .....	49
Table 7 Advanced Screen .....	51
Table 8 About Screen .....	51
Table 9 PLA-401 Lights .....	63
Table 10 PLA-401 v2 Lights .....	64
Table 11 PLA-400 Lights .....	65
Table 12 PLA-400 v2/402 v2 Lights .....	65
Table 13 PLA-470 Lights .....	67
Table 14 PLA470 v2 Lights .....	67
Table 15 Hardware Specifications .....	75
Table 16 Firmware Specifications .....	76
Table 17 Performance .....	77
Table 18 Standards Supported .....	77
Table 19 RJ-45 Connector Pin Assignments .....	79



# List of Figures

Figure 1 Expand Your Network with the PLA-4xx .....	19
Figure 2 Expand Your Network with the PLA402 v2 over Coaxial Cable Wiring .....	20
Figure 3 .NET Framework Installation Prompt .....	24
Figure 4 Microsoft's Agreement .....	24
Figure 5 .NET Framework Installation Process .....	25
Figure 6 Microsoft's Agreement .....	25
Figure 7 InstallShield Wizard Start Screen .....	25
Figure 8 Customer Information Input .....	26
Figure 9 Install Destination Folder .....	26
Figure 10 Restart Screen .....	27
Figure 11 Firmware Detection With an Early Firmware Local Device .....	32
Figure 12 Firmware Detection With a Latest Firmware Local Device .....	32
Figure 13 Firmware Detection Tool: Start .....	33
Figure 14 Firmware Detection Tool: Result .....	33
Figure 15 Firmware Upgrade Tool: Start .....	34
Figure 16 Firmware Upgrade Tool: Upgrading .....	35
Figure 17 Firmware Upgrade Tool: Finish .....	35
Figure 18 ENCRYPT Connection Procedure .....	38
Figure 19 Adding More Powerline Adapters to Your Network .....	39
Figure 20 One Existing Powerline Network .....	39
Figure 21 Two Separate Powerline Networks .....	40
Figure 22 Example Network Setup .....	43
Figure 23 PLA-4xx Series Configuration Utility Icon .....	44
Figure 24 Configuration Screen .....	45
Figure 25 Firmware Screen .....	47
Figure 26 Network Info Screen .....	47
Figure 27 Priority Settings .....	50
Figure 28 Advanced Screen .....	50
Figure 29 About Screen .....	51
Figure 30 Plug Your Powerline Adapter into a Power Socket .....	54
Figure 31 Connect Your Powerline Adapter to a Computer .....	54
Figure 32 Click on the PLA-4xx Series Configuration Utility Icon .....	55
Figure 33 Add a Printer to Your Powerline Network .....	55
Figure 34 Adding a New Adapter .....	56
Figure 35 Adding an Adapter to an Existing Network .....	56
Figure 36 Network Name Pop-up .....	56
Figure 37 Add New Adapters to Make a Second Network .....	57
Figure 38 Making a New Network with the New Adapter .....	58

Figure 39 Local/Remote Adapters on a Powerline Network ..... 59

Figure 40 Adding an Adapter to Your New Network ..... 59

Figure 41 Incorrect DAK or No DAK ..... 60

Figure 42 Correct DAK ..... 60

Figure 43 An Adapter on Your New Network ..... 60

Figure 44 Adapters on a New Powerline Network ..... 61

Figure 45 PLA-401 Lights ..... 63

Figure 46 PLA-400/400 v2/ 402 v2 Lights ..... 65

Figure 47 PLA-470 and PLA-470 v2 Lights ..... 66

Figure 48 Wall-mounting Example ..... 78

Figure 49 RJ-45 Connector Pins ..... 79



---

# PART I

# Introduction

---

Introducing the PLA-4xx (19)

Installing the Utility (23)



# Introducing the PLA-4xx

## 1.1 Overview

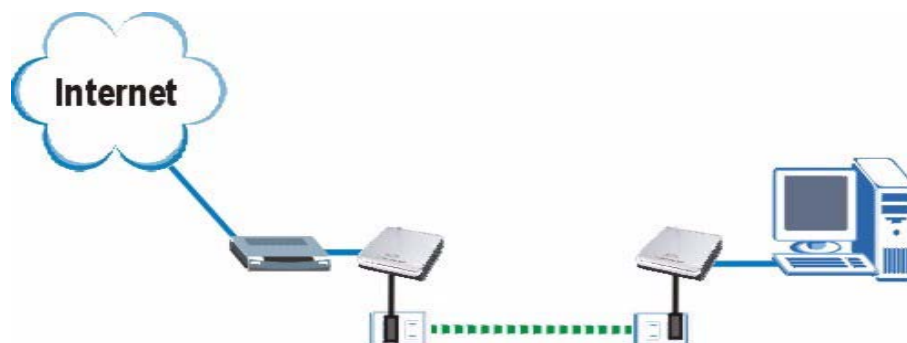
This chapter introduces the main applications and features of the PLA-4xx HomePlug AV compliant powerline adapter. See [Appendix A on page 75](#) for detailed product specifications.

In this User's Guide the electrical wiring network and coaxial cable network are both referred to as "HomePlug AV". The HomePlug AV standard specifies how network devices communicate using standard electrical wiring.

## 1.2 Expand Your Network with the PLA-4xx

The PLA-4xx plugs into an ordinary power outlet to easily extend a cable or DSL broadband connection or existing Ethernet (LAN) network to any other electrical outlet in any room of a house, all without the need for any new cabling. Devices can securely communicate with each other at high data transfer rates. (See [Appendix A on page 75](#) for speeds currently supported by the PLA-4xx.) The PLA-4xx uses 128-bit Advanced Encryption Standard (AES) to ensure safe transfer of information.

**Figure 1** Expand Your Network with the PLA-4xx



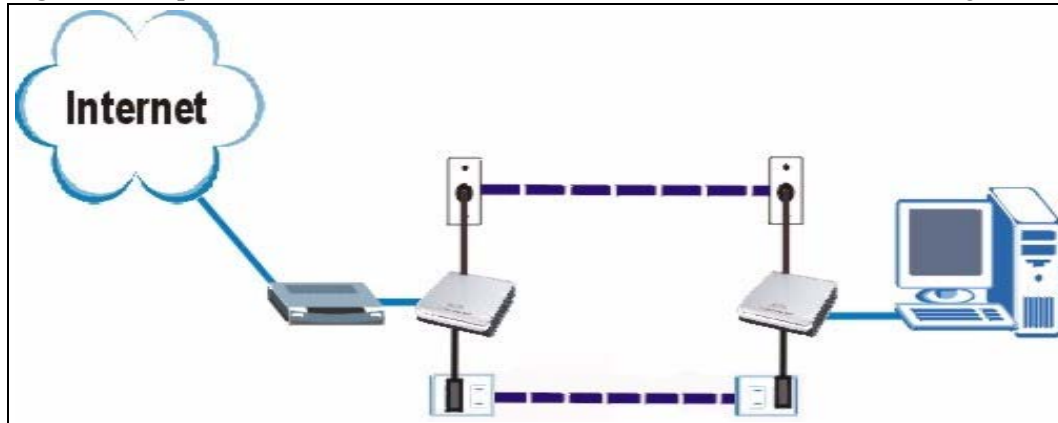
Connect your PLA-4xx to an Internet gateway such as a modem and plug it into an ordinary power outlet in your home. Plug a second PLA-4xx into another power outlet and connect a computer to the PLA-4xx for Internet access. Your network can be further expanded by plugging additional PLA-4xxs into other outlets in your home and connecting other computers or network devices (for example, a printer) to them.

Refer to your Quick Start Guide for hardware connection information. Refer to [Appendix A on page 75](#) for wall mounting instructions.

## 1.3 Coaxial Cable Networks with the PLA402 v2

The PLA402 v2 allows you to be more flexible in expanding your network by adding the coaxial cable capability.

**Figure 2** Expand Your Network with the PLA402 v2 over Coaxial Cable Wiring



As well as being able to connect your PLA402 v2 to a power outlet, you also have the option of connecting to a coaxial cable outlet. Connect other powerline adapters in your powerline network to coaxial cable outlets on the same line. Then set up your network with additional devices such as a computer or printer the same way you would set up a powerline network on an electrical circuit.

A coaxial connection has a far greater range than a powerline connection. This enables you to set up networks for large areas.

If you are setting up a coaxial connection in a room with only one coaxial outlet you can use a coaxial splitter to connect more than one device. For example, if you want to connect a TV and a PLA402 v2 to a single outlet you could use a coaxial splitter.

## 1.4 Ways to Manage the PLA-4xx

Use the **ENCRYPT** button to add powerline devices to your powerline network if they have this button. See [Chapter 4 on page 37](#) for instructions on using the **ENCRYPT** feature.

Use the **PLA-4xx Series Configuration Utility** (or utility, for short) to manage the PLA-4xx. See [Section 2.2 on page 23](#) for instructions on installing the utility.

Use the firmware detection and firmware upgrade tools to upgrade to the latest firmware. Because the latest PLA-4xxs are only compatible with other powerline devices with the latest HomePlug AV firmware, as well as the latest version Utility, these tools are available to help you upgrade. You can download both of these tools from the ZyXEL website ([www.zyxel.com.tw](http://www.zyxel.com.tw)). See [Chapter 3 on page 31](#) for information in using these tools.



This User's Guide describes the latest version utility. This utility is only compatible with a PLA-4xx which has the latest firmware installed. If you don't already have them, download the latest firmware and utility from the ZyXEL website.

## 1.5 Security

Since your powerline network may extend outside your premises, it is important to set up security on your PLA-4xx.

### 1.5.1 Passwords

You use two types of passwords in the HomePlug AV powerline network. The following table describes the differences between the passwords.

**Table 1** Password Summary

PASSWORD	DESCRIPTION
Network Name	All powerline adapters that follow the HomePlug AV standard are shipped with the same powerline network name "HomePlugAV". Change the network name via the <b>PLA-4xx Series Configuration Utility</b> to create a private network. See <a href="#">Section 5.3 on page 45</a> .
DAK (Data Access Key) Password	In order to manage the powerline adapters on your powerline network you must enter the adapters' DAK password in the <b>PLA-4xx Series Configuration Utility</b> . This password is printed on the powerline adapter itself. You don't need to add the password for the powerline adapter directly connected to the computer running the configuration utility (local powerline adapter), you only have to add the remote powerline adapters' passwords (those on your circuit, but not directly connected to your computer).

### 1.5.2 Setting Up Security

The ENCRYPT feature automatically sets up security on your powerline network. Use this feature if your powerline devices have the **ENCRYPT** button.

If your devices do not have the **ENCRYPT** button, use the **PLA-4xx Series Configuration Utility** to set up security on the PLA-4xx. Although the PLA-4xx is a "plug-and-play" network expanding solution there are several reasons for enabling security on the powerline network in your home.

- 1 It's easy and only requires you to change a network name.
- 2 It's a good idea to ensure privacy of your communication. When you use the PLA-4xx and other powerline adapters, the electrical wiring in your home becomes an extension of your Ethernet network. Your network traffic flows freely within the electrical circuit of your home and is bounded in most cases by a power meter.

Without security (encryption) your information is accessible to anyone using a powerline adapter on the same electrical circuit. In some cases, a circuit can be shared by more than one household.

To prevent compromising your network security, you can create a private network. A private network uses a secret password (**Network Name**) to make sure that only permitted powerline adapters can communicate in your network. See [Section 5.3 on page 45](#) for information on setting up a private network.



---

Buildings and even streets may share a coaxial cable connection. If your powerline network uses a coaxial cable, the network will probably extend outside your premises. In this case make your network more secure with a private network name.

---

- 3 You may need to change the **Network Name** to create multiple powerline networks. See the next section for more information on how to set up a multiple network.

## 1.6 Multiple Networks

Multiple powerline networks can coexist on a single powerline circuit. You might want to implement multiple powerline networks in a small office environment where you have two separate Ethernet networks.

- 1 Connect one powerline adapter to a router or switch on the first Ethernet network and assign a **Network Name** (for example “Password1”) to this powerline adapter. Add additional powerline adapters to your network by plugging them into your powerline outlets and assigning them “Password1”. This completes the configuration of your first powerline network.
- 2 Connect another powerline adapter to a router or switch on the second Ethernet network and assign a different **Network Name** (for example “Password2”) to this powerline adapter. Again, add additional powerline adapters and assign them “Password2”.  
You now have two private networks on your powerline circuit. Information is not shared between the two networks as only powerline adapters with the same **Network Name** can communicate with each other.

# Installing the Utility

This chapter guides you through the installation of the configuration utility for your PLA-4xx.

## 2.1 Overview of the Installation Process

The installation of the configuration utility does the following:

- 1 Checks for and installs Microsoft's .NET Framework version 1.1 software on your computer. This software is necessary for the installation of the **PLA-4xx Series Configuration Utility**. If you already have .NET Framework version 1.1 installed on your computer this step will be skipped.
- 2 Installs ZyXEL's **PLA-4xx Series Configuration Utility**. This utility allows you to manage the network name (See [Section 5.3 on page 45](#) for more information) or view the devices recognized on your powerline network.



---

At the time of writing the **utility** is only compatible on Microsoft Windows XP and Microsoft Windows Vista (32-bit version) operating systems.

---



---

This User's Guide describes the latest version utility. This utility is only compatible with a PLA-4xx which has the latest firmware installed. If you don't already have them, download the latest firmware and utility from the ZyXEL website.

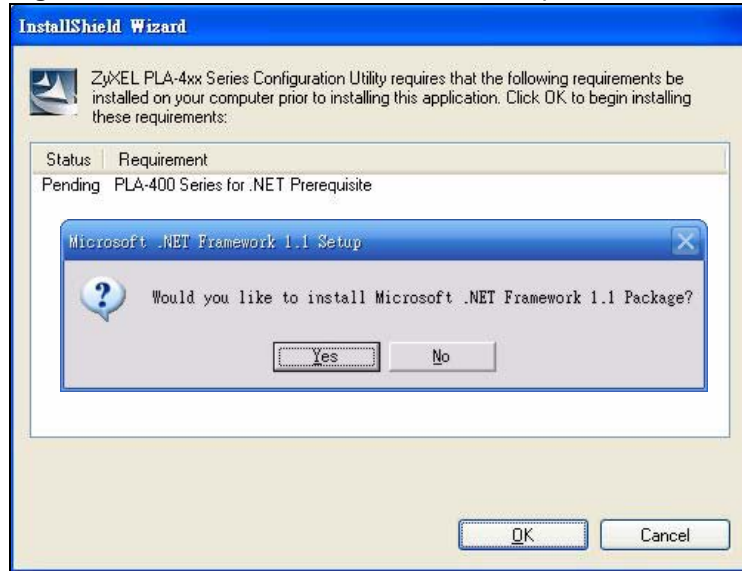
---

## 2.2 Installing the Utility

Follow the steps below to install .NET Framework version 1.1 and the **PLA-4xx Series Configuration Utility** on your computer.

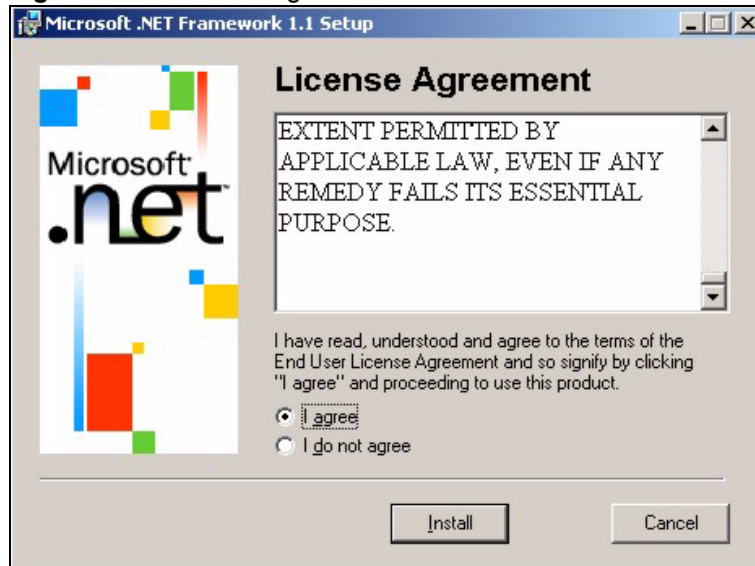
- 1 Insert the included CD-ROM into your computer's CD-ROM drive. The Setup utility runs automatically. Alternatively this can also be done manually by double clicking the **setup.exe** file on the CD. A prompt appears asking you to install the .NET Framework version 1.1. Click **Yes** to continue with the installation.

**Figure 3** .NET Framework Installation Prompt



2 Review Microsoft's **License Agreement**, select **I agree** and click **Install** to proceed.

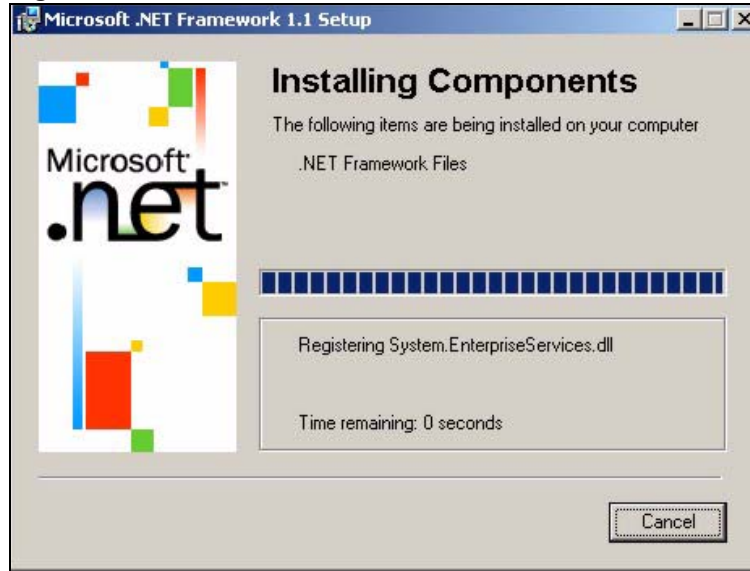
**Figure 4** Microsoft's Agreement



3 The next screen allows you to see the progress of the installation.

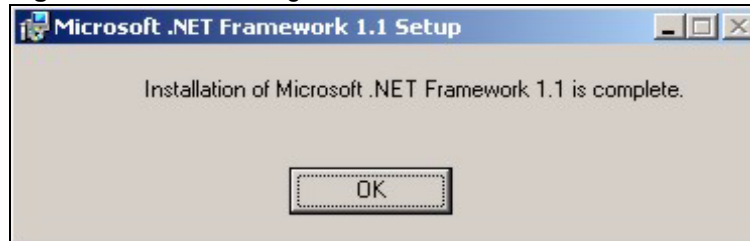


Figure 5 .NET Framework Installation Process



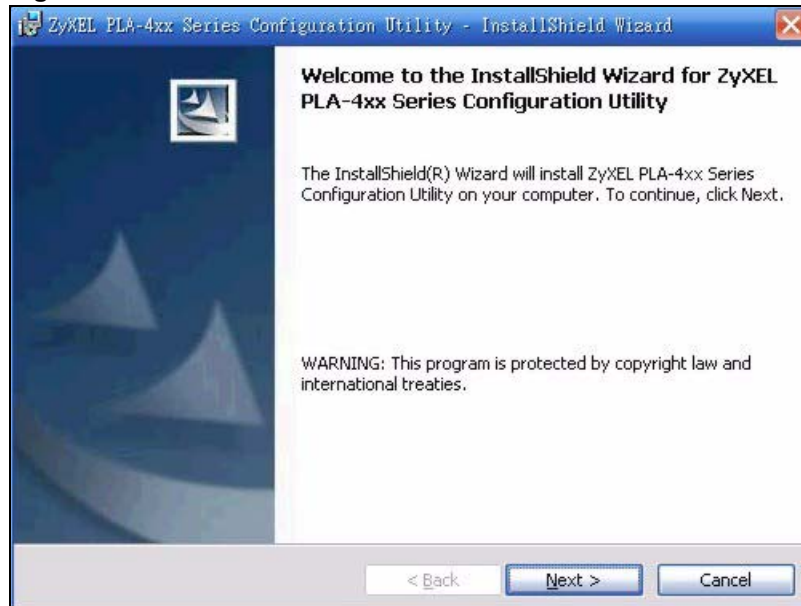
- 4 Click **OK** to complete the installation process.

Figure 6 Microsoft's Agreement



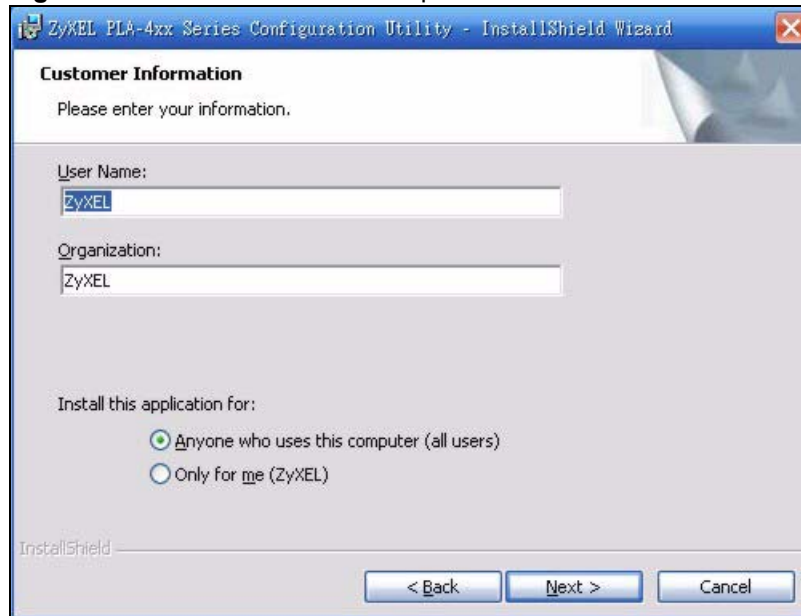
- 5 The Setup utility runs automatically. Click **Yes** or **Next** to continue through the initial screen. Click **Cancel** only if you want to abort the installation.

Figure 7 InstallShield Wizard Start Screen



- 6 Fill in the **User Name** and **Company Name** fields (optional). If you want the utility to be only available to the currently logged in user, select **Only for me(...)**. Otherwise, click **Next** to continue and allow all users to use the configuration utility.

**Figure 8** Customer Information Input

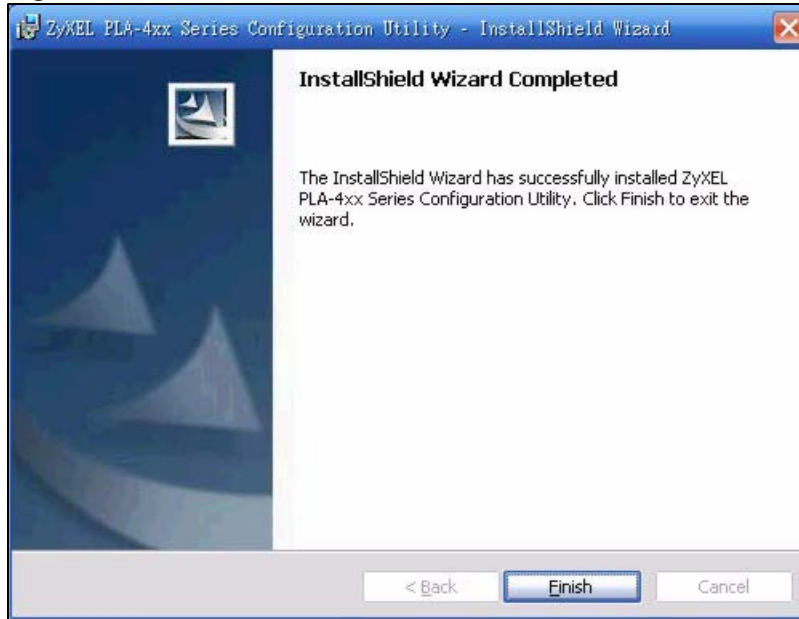


- 7 Click **Next** to install the utility to the default folder, or click **Change** to specify a different location on your computer.

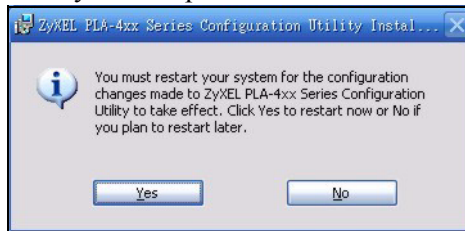
**Figure 9** Install Destination Folder



- 8 When the installation is finished, a screen appears to confirm the **InstallShield Wizard** has successfully installed the **PLA-4xx Series Configuration Utility** to your computer. Click **Finish** to exit the wizard.

**Figure 10** Restart Screen

- 9 The following pop-up appears. Click **Yes** to restart your computer, or click **No** to restart your computer later.



---

If you select “No, I will restart my computer later”, you will not be able to launch the utility until after a restart of your computer.

---



---

# PART II

## Managing the PLA- 4xx

---

Firmware Tools (31)  
The ENCRYPT Button (37)  
The Configuration Utility (43)  
Powerline Network Setup Tutorial (53)  
LEDs and Troubleshooting (63)



# Firmware Tools

Use the **Firmware Detection Tool** and **Firmware Upgrade Tool** to ensure you have the latest firmware (version 3.0.5 or later) on your PLA-4xx(s).

You need to upgrade all your PLA-4xxs to the latest firmware to ensure they can connect with each other and they are compatible with the latest version Utility.

Use the **Firmware Detection Tool** to detect the firmware version of powerline devices on your network. If your firmware is early version (earlier than 3.0.5), then upgrade your firmware using the **Firmware Upgrade Tool**.



---

Run the tools or the Utility one at a time, as only one of these applications can access the PLA-4xx connected to your computer at any time.

---

## 3.1 Firmware Detection Tool

Use the **Firmware Detection Tool** to detect the firmware on devices on your powerline network.

### 3.1.1 Firmware Detection Issues

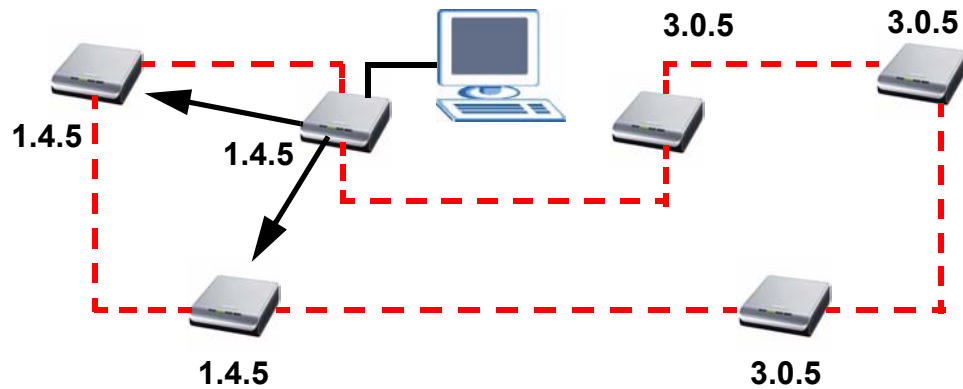


---

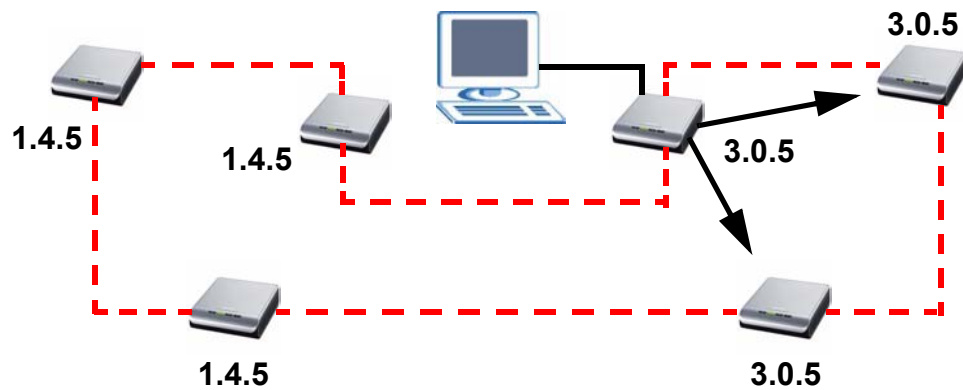
The powerline device directly connected to your computer (the local device) is only compatible with other powerline devices which have the same firmware. So if your local device is running the latest firmware, the detection tool will not be able to detect devices with older firmware. Use a local device with early version firmware to allow the detection tool to detect any powerline devices with early version firmware.

---

This diagram shows the **Firmware Detection Tool** detecting the firmware on early firmware devices only, as the local device has early firmware.

**Figure 11** Firmware Detection With an Early Firmware Local Device

This diagram shows the **Firmware Detection Tool** detecting the firmware on latest firmware devices only, as the local device has the latest firmware.

**Figure 12** Firmware Detection With a Latest Firmware Local Device

### 3.1.2 Firmware Detection Procedure

Follow these instructions to run the **Firmware Detection Tool**.

- 1 Close the **Utility** and **Firmware Upgrade Tool** if either of them are open.
- 2 Double click on the **Firmware Detection Tool** to run the file.
- 3 Click **Next** to begin the firmware detection process.



**Figure 13** Firmware Detection Tool: Start

The Tool shows the firmware version(s) of devices it has detected on your powerline network.

**Figure 14** Firmware Detection Tool: Result

The following table describes the labels in this screen.

**Table 2** Firmware Detection Tool: Result Screen

LABEL	DESCRIPTION
Site	This field displays <ul style="list-style-type: none"> <li><b>Local</b>, if it is identifying the powerline adapter directly connected to the computer running the configuration utility.</li> <li><b>Remote</b>, if it is a powerline adapter in your powerline network but not directly connected to the computer running the configuration utility.</li> </ul>
MAC Address	This shows the MAC address of the powerline adapter. You can find the MAC address of your PLA-4xx displayed on a sticker on the bottom of your device.

**Table 2** Firmware Detection Tool: Result Screen (continued)

LABEL	DESCRIPTION
Firmware Version	This is the firmware version of your device. In the example firmware version given in the screen, <b>1-4-1454</b> , the firmware version is shown by the numbers <b>145</b> , meaning this is firmware version 1.4.5. If your device's firmware is earlier than 3.0.5, please use the <b>Firmware Upgrade Tool</b> to upgrade your firmware.
Company	You can upgrade your device if this field displays <b>ZyXEL</b> . If <b>Other</b> displays then you cannot use the <b>Firmware Upgrade Tool</b> .

## 3.2 Firmware Upgrade Tool

Use the firmware upgrade tool to upgrade firmware earlier than version 3.0.5 to the latest version firmware on the powerline device directly connected to your computer. This is necessary as devices with ZyXEL's early version firmware are not compatible with the latest Utility or with devices running ZyXEL's latest version firmware.

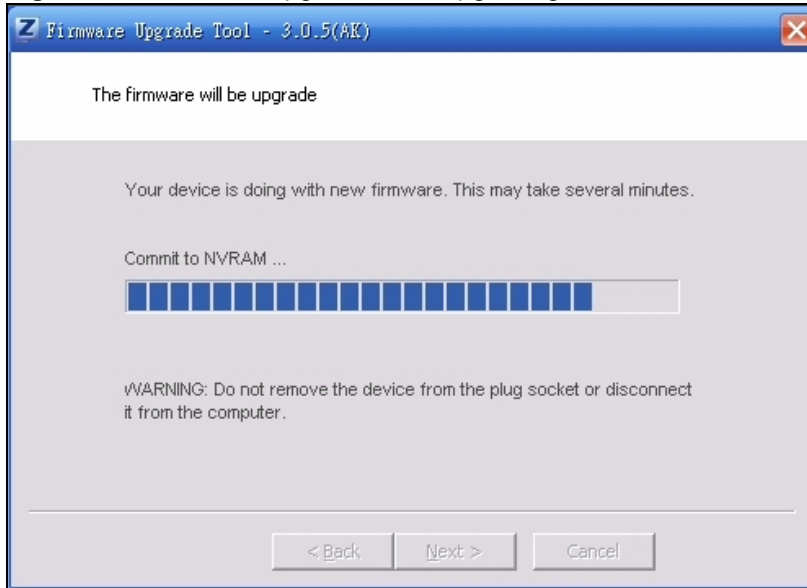


The firmware is included in the Tool. You do not need to download the firmware separately.

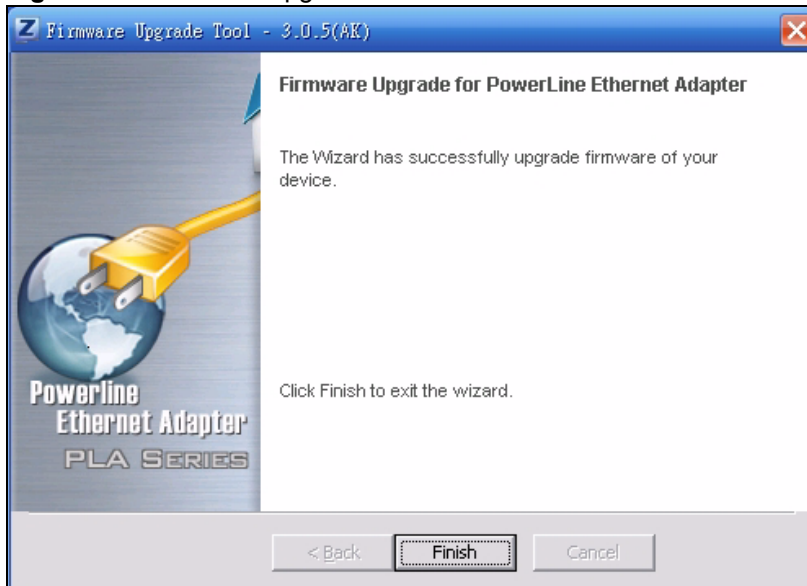
- 1 Connect the powerline device to be upgraded to your computer.
- 2 Close the Utility and **Firmware Detection Tool** if either of them are open.
- 3 Double click on the **Firmware Upgrade Tool** to run the file.
- 4 Click **Next** to begin the firmware upgrade process.

**Figure 15** Firmware Upgrade Tool: Start

- 5 Wait several minutes while the firmware is upgraded.

**Figure 16** Firmware Upgrade Tool: Upgrading

- 6 If your firmware is successfully upgraded, the following screen appears. Click **Finish** to close the Tool.

**Figure 17** Firmware Upgrade Tool: Finish

- 7 To check your firmware is successfully upgraded, run the **Firmware Detection Utility** again and check your firmware version.
- 8 Repeat this upgrade process for each powerline device you need to upgrade.



# The ENCRYPT Button

Use the **ENCRYPT** button to automatically set up a secure powerline connection between your powerline devices.

## 4.1 ENCRYPT Button Overview

The **ENCRYPT** button allows you to set up a secure powerline connection with other HomePlug AV compliant powerline devices which also support the **ENCRYPT** feature. No other powerline setting changes are required to connect.

You can use the **ENCRYPT** button to:

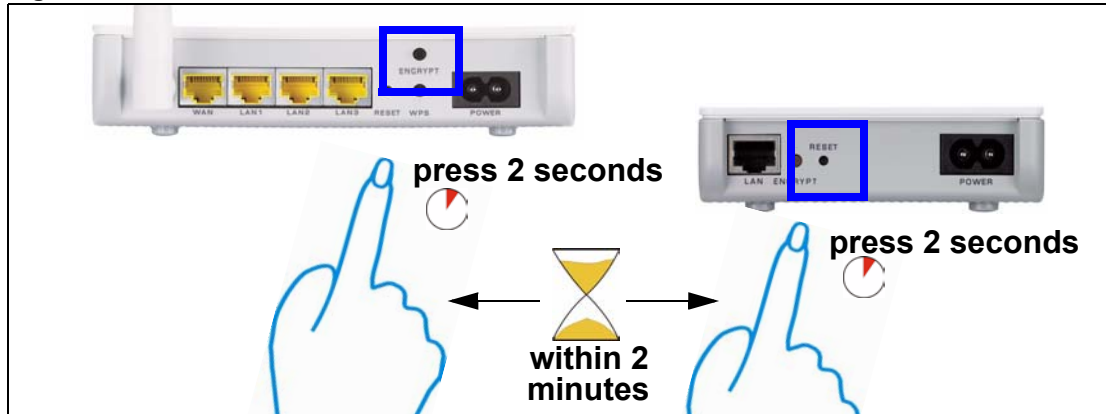
- set up a new powerline network
- separate an existing powerline network into multiple networks

## 4.2 Set Up a HomePlug AV Network with ENCRYPT

You can connect a number of devices on a powerline network, but you can use the **ENCRYPT** button on only two devices at a time. The PLA-4xx and PLA-400 v2 are shown below as examples.

- 1** Place a powerline device close to another powerline device so you have time to set up each one. After you set up the first powerline device, you have 120 seconds to set up the second powerline device.
- 2** You can disconnect them from your computer or modem (or other networking equipment) if you need to move them close to each other, but the powerline devices need to be plugged into power outlets.
- 3** Press the **ENCRYPT** button at the rear of your powerline device for more than 10 seconds until the power (⏻) light flashes. This resets the network name to a random value and removes your device from any network it may belong to.
- 4** Press the **ENCRYPT** button at the rear of your powerline device for 1~2 seconds. The power (⏻) light will blink as the powerline device tries to set up a connection.

Figure 18 ENCRYPT Connection Procedure



- 5 Repeat step 4 in this section for the other powerline device you wish to connect. This must be done within 120 seconds of pressing the **ENCRYPT** button on the PLA-4xx.
- 6 Check the lights on the two powerline devices. The power (⏻) and HomePlug (🏠) lights should be blinking while the devices are connecting. Several times all lights blink simultaneously and the HomePlug (🏠) light also shows red. Wait for about one minute while your powerline devices connect.

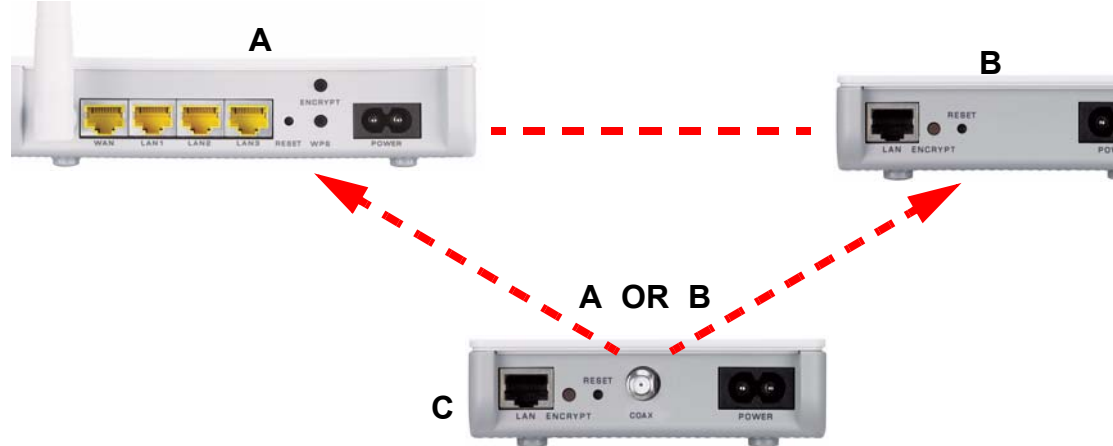


If the power (⏻) light does not blink when you press **ENCRYPT**, you have probably pressed the **ENCRYPT** button for too long. Try again, pressing the **ENCRYPT** button for 1~ 2 seconds.



If the HomePlug (🏠) lights on both powerline devices do not light up, the powerline devices are not connected. Repeat steps 4 and 5 in this section. If that doesn't work, see the Troubleshooting in Section 7.5 on page 71 for suggestions.

- 7 To add more powerline devices to your network, press the **ENCRYPT** button on device C (shown below) for more than 10 seconds until the power (⏻) light flashes.
- 8 Then repeat steps 4 and 5 in this section using any powerline device (A or B) you have connected using **ENCRYPT** and the powerline device you want to connect (C). You must use the **ENCRYPT** button on both devices.

**Figure 19** Adding More Powerline Adapters to Your Network

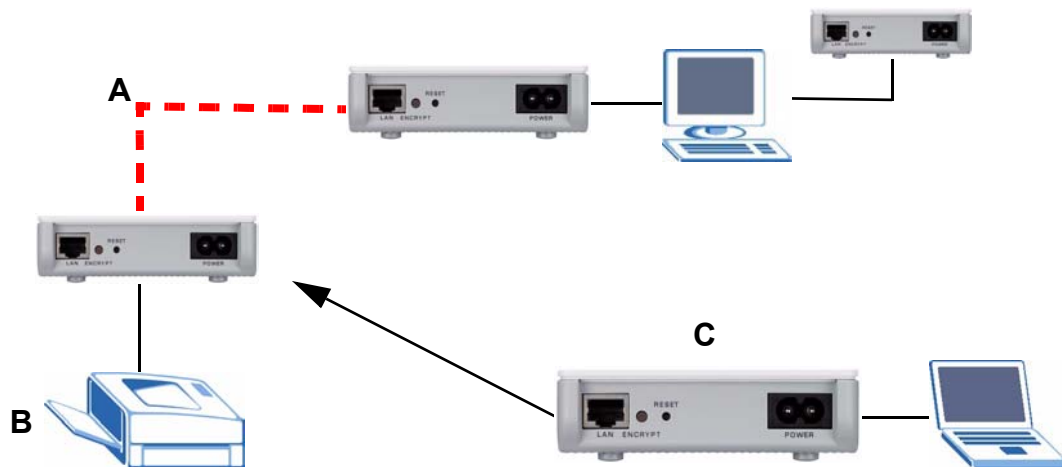
- 9 If you disconnected your computer or modem (or any other networking product connected to your powerline device) in step 1 of this section, you can now reconnect them.

This sets up your powerline network between your powerline devices.

### 4.3 Setting Up Multiple Networks

You can use the **ENCRYPT** button to set up multiple powerline networks using your existing powerline network.

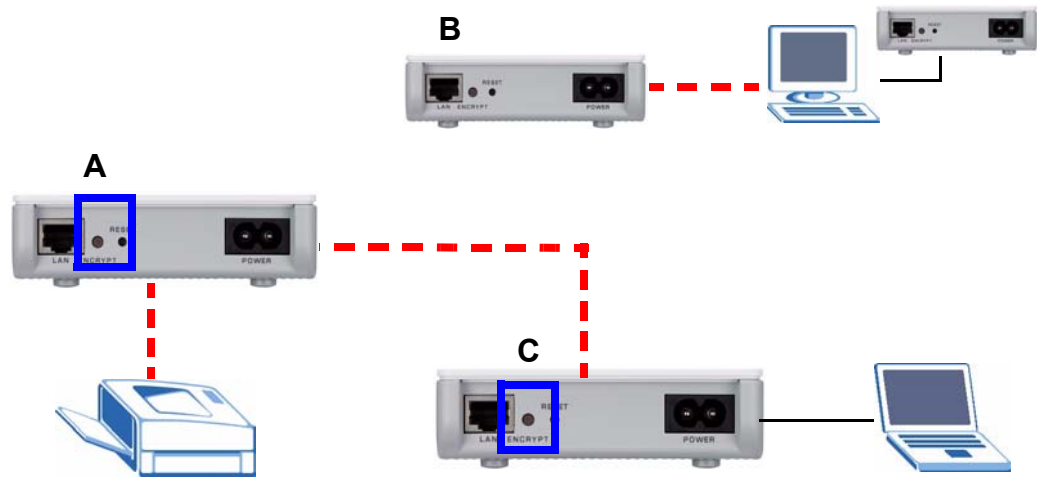
For example, you have already set up a powerline network in your home (A) which accesses a printer (B). Now you want a separate powerline network connection from your laptop to your printer (C).

**Figure 20** One Existing Powerline Network

- 1 Click the **ENCRYPT** button on (A) for more than 10 seconds until the power (⏻) light flashes. This disconnects (A) from (B).

- 2 Click the **ENCRYPT** button on (A) and (C) for 1~2 seconds and within two minutes of each other.
- 3 Wait for about one minute while (A) and (C) connect.
- 4 Check the LEDs on both (A) and (C). When the power (🔌) and HomePlug (🏠) lights stop blinking and the power (🔌) light shines steadily, the devices are connected.

**Figure 21** Two Separate Powerline Networks



Congratulations. You now have two separate powerline networks as shown above.



---

If the HomePlug (🏠) lights on both powerline devices do not light up, the powerline devices are not connected. Repeat the connection process, making certain you press the **ENCRYPT** buttons for the correct time and within two minutes of each other. If that does not work see Section 7.5 on page 71 for suggestions.

---



## 4.4 ENCRYPT Button Behavior

The following table summarizes the actions that occur when the **ENCRYPT** button is pressed for specific lengths of time.

**Table 3** Time **ENCRYPT** Button is Pressed and Action

TIME	ACTION	POWER LIGHT BEHAVIOR	HOMEPLUG LIGHT BEHAVIOR
less than 3 seconds	The device joins a network. It shares the same network name as other devices on the network.	The power (⏻) light blinks until the device is connected. This may take a minute.	The HomePlug (🏠) light turns on if your device is connected to another powerline device or a powerline network.
more than 10 seconds	The device leaves any network it is associated with and its network name assumes a random value.	The power (⏻) light blinks several times and then shines steadily.	The HomePlug (🏠) light blinks red one time and then turns off when it disconnects from the powerline network.

See Troubleshooting in [Chapter 7 on page 71](#) for suggestions on problems with the **ENCRYPT** button and the lights.



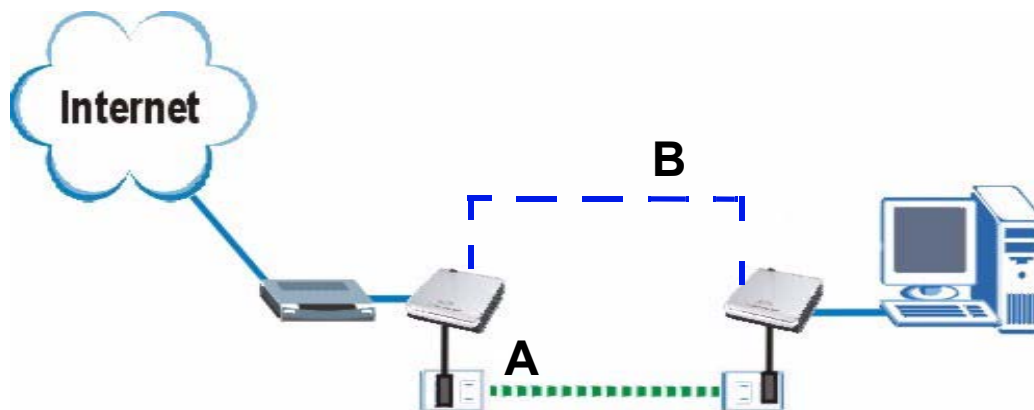
# The Configuration Utility

This chapter shows you how to use the Configuration Utility (or Utility) to secure, manage and set up Quality of Service (QoS) on your powerline network.

## 5.1 Overview

The PLA-4xx is designed as a plug-and-play network expanding solution. This means that once you complete your hardware connections, the PLA-4xxs in your network (without additional configuration) are able to communicate with each other by sending and receiving information over your home's electrical wiring (**A**). For the PLA402 v2 models you have the option to use coaxial cables (**B**) to expand your network.

**Figure 22** Example Network Setup



All HomePlug AV compliant powerline adapters within range can join your network. The range varies depending on the quality of your home's wiring. In the case of coaxial cable this can extend beyond the boundary of your home (for example your neighbor's house or apartment).



See [Section 5.1.1 on page 44](#) for more information on enhancing your powerline network security.

### 5.1.1 Powerline Network Security

When the PLA-4xxs communicate with each other, they use encryption to protect the information that is sent in the powerline network. Encryption is like a secret code. If you do not know the secret code, you cannot understand the message. The HomePlug AV standard uses 128-bit AES (Advanced Encryption Standard) to safely transmit data between powerline adapters.

For the powerline adapters to communicate with each other they all need to use the same network name. This network name allows the powerline adapters to understand the encrypted information sent in the powerline network.

By default the PLA-4xxs are all configured with the network name **HomePlugAV**, this allows you to simply plug the devices in and not worry about setting up security. If you want to enhance the security on your powerline network, you can change the network name on the powerline adapters you want to allow to communicate in your powerline network.

### 5.1.2 Device Access Key (DAK)

In order to manage the powerline adapters on your powerline network you must enter the adapters' password in the **PLA-4xx Series Configuration Utility**. This password is called the DAK (Device Access Key) password. This password is printed on the powerline adapter itself.

You don't need to enter the DAK password for the powerline adapter directly connected to the computer running the utility (local powerline adapter), you only have to add the remote powerline adapters' passwords (those in your powerline network, but not directly connected to your computer).

## 5.2 Starting the Configuration Utility

To launch the **PLA-4xx Series Configuration Utility** simply double click on the configuration icon on your desktop.

**Figure 23** PLA-4xx Series Configuration Utility Icon



Alternatively, start the utility by browsing to it from the start menu. Click **Start > Programs > ZyXEL PLA-4xx Series Configuration > PLA-4xx Series Configuration Utility**.



---


Close the **Firmware Upgrade Tool** and **Firmware Detection Tool** if either of them are open for the Utility to work properly.

---

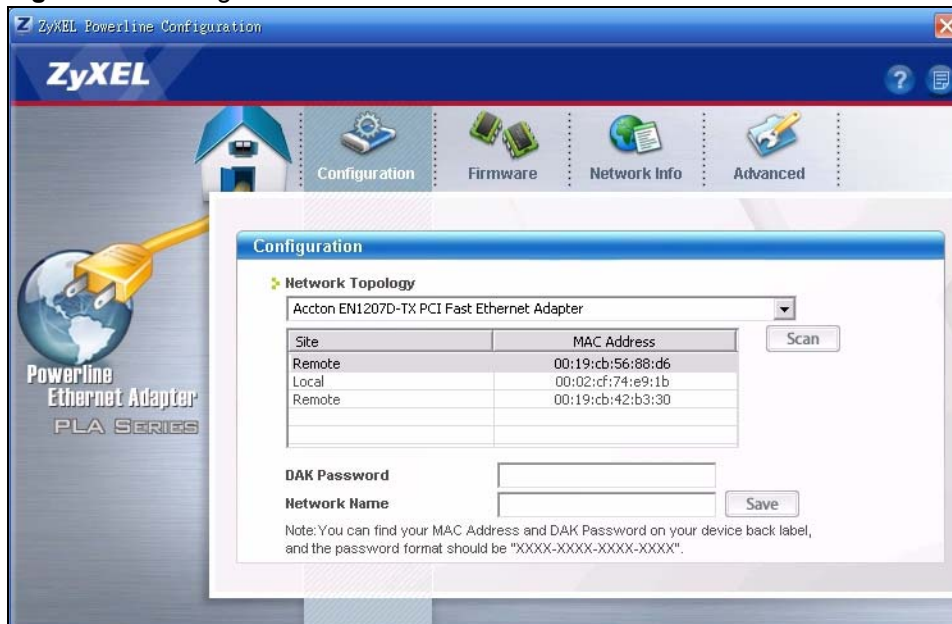
## 5.3 Configuration Screen

Use the **Configuration** screen to see which devices are recognized by your powerline network, to configure your PLA-4xx and to set up a secure powerline network by changing the powerline network name. This screen opens up when you launch the utility.



Use the  icon to view online help information in each screen of the **utility**.

**Figure 24** Configuration Screen



The following table describes the labels in this screen.

**Table 4** Configuration Screen

LABEL	DESCRIPTION
Network Topology	Use this to select which powerline network information is displayed. Different powerline networks are identified by the Ethernet interface (network card) connected directly to the PLA-4xx. Typically there is only one connection, however, if your computer has two network cards and both are connected to a powerline device then you have two powerline networks.
The fields described below are used to identify the powerline adapters recognized on the powerline network. The configuration utility automatically updates this information every 10 seconds. Click <b>Scan</b> to refresh the information in these fields (immediately).	
<b>Note:</b> Only devices which share the same network name are displayed in this table.	
Site	This field displays <ul style="list-style-type: none"> <li><b>Local</b>, if it is identifying the powerline adapter directly connected to the computer running the configuration utility.</li> <li><b>Remote</b>, if it is a powerline adapter in your powerline network but not directly connected to the computer running the configuration utility.</li> </ul>

**Table 4** Configuration Screen (continued)

LABEL	DESCRIPTION
MAC Address	This is a read-only field which shows the MAC address of the powerline adapter you are configuring. You can find the MAC address of your PLA-4xx displayed on a sticker on the bottom of your device.
DAK Password	<p>DAK (Device Access Key) password is used to verify that you are authorized to perform changes on a remote device. You can find the DAK password printed on a sticker on the bottom of your PLA-4xx.</p> <p>Select the remote powerline adapter you want to manage by clicking the MAC address which corresponds to it in the <b>MAC Address</b> column. Enter the <b>DAK Password</b> value and click <b>Save</b>.</p> <p>Note: You must enter the DAK Password value exactly as it is printed on the label (all caps and with dashes "-").</p>
Network Name	<p>The default network name (sometimes called a network password or network membership key (NMK)) of the PLA-4xx is "<b>HomePlugAV</b>". HomePlug compatible devices use the same network name to recognize and communicate with each other over the powerline network. If you change the network name of one device on the network, it will no longer be recognized as part of that network.</p> <p>If you change the network name, make sure you change the network name for all of the powerline adapters that you want to be part of your powerline network.</p> <p>The network name can be from 8 to 64 characters in length, using "A"~"Z", "a"~"z", "0"~"9"; spaces are not allowed.</p>
Save	<p>Click this to apply your changes. The new <b>Network Name</b> is applied to the selected powerline adapter.</p> <p>Note: You must enter the correct DAK password for the selected powerline adapter before you can make changes to it.</p>

## 5.4 Firmware Screen




---

To upgrade to the latest firmware, use the firmware upgrade tool available from the ZyXEL website ([www.zyxel.com](http://www.zyxel.com)), or from the CD included with your PLA-4xx. Make sure you also upgrade the PLA-4xx Series Configuration Utility if you do so, as older version utilities are not compatible with PLA-4xxs using the latest firmware.

---

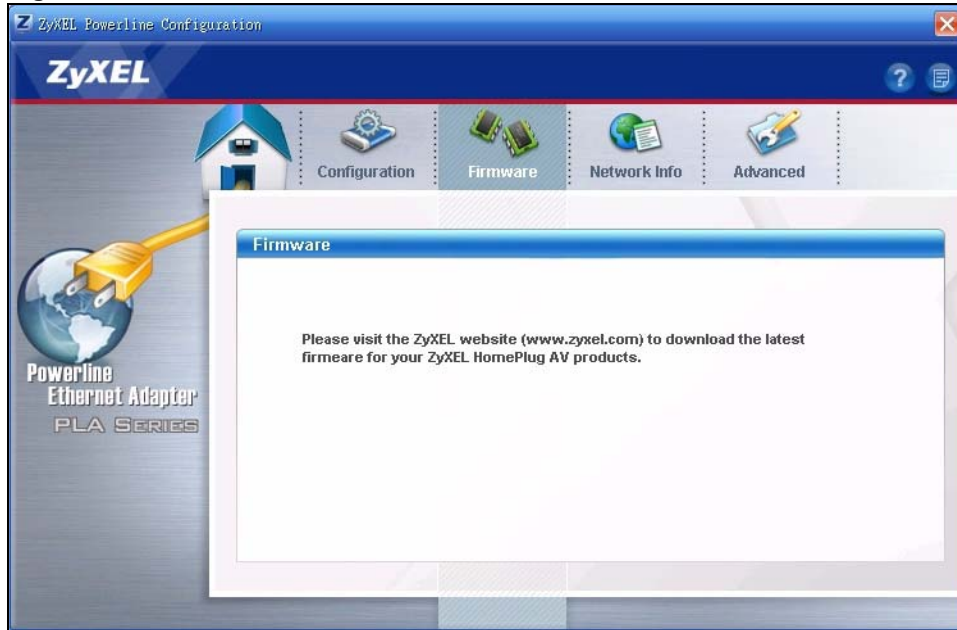



---

Be sure to upload the correct model firmware as uploading the wrong model firmware may damage your device.

---

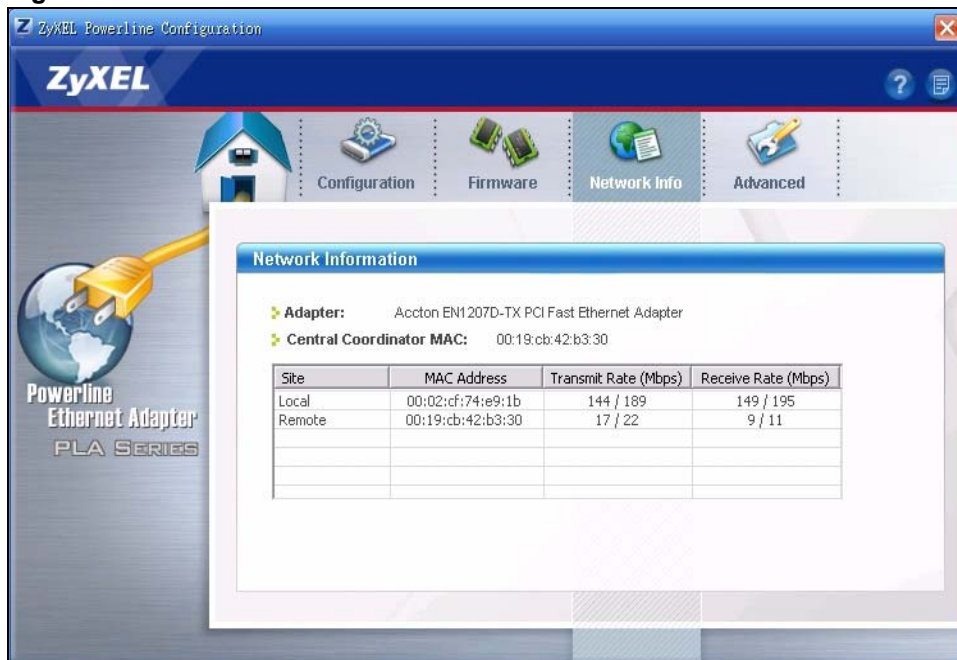
Figure 25 Firmware Screen



## 5.5 Network Info Screen

Use the **Network Info** screen to see the rates at which a specific PLA-4xx is communicating with other powerline adapters on your powerline network.

Figure 26 Network Info Screen



The following table describes the labels in this screen.

**Table 5** Network Info Screen

LABEL	DESCRIPTION
Adapter	This field identifies which powerline network information is displayed. Different powerline networks are identified by the Ethernet interface (network card) connected directly to the PLA-4xx. Typically there is only one connection, however, if your computer has two network cards and both are connected to a PLA-4xx, then you have two powerline networks.
Central Coordinator MAC	The Central Coordinator of the powerline network is the powerline adapter which keeps track of which devices are part of the network as well as synchronizes communication within the powerline network. If the Central Coordinator is removed from the powerline network then another powerline adapter takes its place. This field displays the MAC address of the PLA-4xx which is the Central Coordinator of the powerline network. The powerline adapters in your powerline network automatically select the Central Coordinator.
<p>The information provided in the following table reflects transmission rate information about the powerline adapters which communicate in your powerline network.</p> <p>The powerline adapters listed in this table are all the powerline adapters in your powerline network except the powerline adapter selected in the <b>Configuration</b> page of the configuration utility. In other words, if the <b>Local</b> powerline adapter is selected in the <b>Configuration</b> screen, then this table will display the rates of transmission from the powerline adapter connected to the computer running the configuration utility to all the <b>Remote</b> powerline adapters.</p>	
Site	This field displays: <ul style="list-style-type: none"> <li>• <b>Local</b>, if it is the PLA-4xx directly connected to the computer running the configuration utility.</li> <li>• <b>Remote</b>, if it is a PLA-4xx in your powerline network but not directly connected to the computer running the configuration utility.</li> </ul>
MAC Address	This field displays the MAC address of your powerline adapter. The MAC address of your powerline adapter can be found by looking at the label on your device. It consists of six pairs of hexadecimal characters (hexadecimal characters are "0-9" and "a-f"). In the case of the PLA-4xx, this label is on the bottom of the device.
Transmit Rate (Mbps)	This field displays how fast information is sent from the powerline adapter selected in the <b>Configuration</b> screen to this powerline adapter. The rate is given in the following format: "application data transmission rate / raw data transmission rate". Application data reflects more accurately how fast devices are transmitting application relevant traffic (for example Internet Protocol (IP) traffic). Raw data refers to the whole payload of the packets transmitted across the powerline network.
Receive Rate (Mbps)	This field displays how fast information is received from the powerline adapter selected in the <b>Configuration</b> screen to this powerline adapter. The rate is given in the following format: "application data transmission rate / raw data transmission rate". Application data reflects more accurately how fast devices are transmitting application relevant traffic (for example Internet Protocol (IP) traffic). Raw data refers to the whole payload of the packets transmitted across the powerline network.

## 5.6 Advanced Screen



This feature is only available with the latest version utility. Go to the ZyXEL website to download the latest utility and firmware for your ZyXEL HomePlug AV adapter.



You can configure the powerline adapters on your network to give priority to network traffic depending on its importance. When you set the priority of a powerline adapter, you set how quickly messages FROM your powerline adapter are sent in your powerline network. Transmissions TO your powerline adapter do not receive any priority.

For example, if you have a file server on your home network to deliver music and movie files to computers in your home, you should set the priority of the powerline adapter connected to this server to **Medium**. If video traffic is delivered too slowly, quality problems may occur.

On the other hand, a powerline adapter attached to a printer should have a low priority setting since the slow delivery of messages will not affect the print job.

Similarly, if you want to prioritize any downloads from the Internet, set the priority on the powerline adapter attached to your Internet gateway to **High**.

Allocate priority settings based on application type as follows.

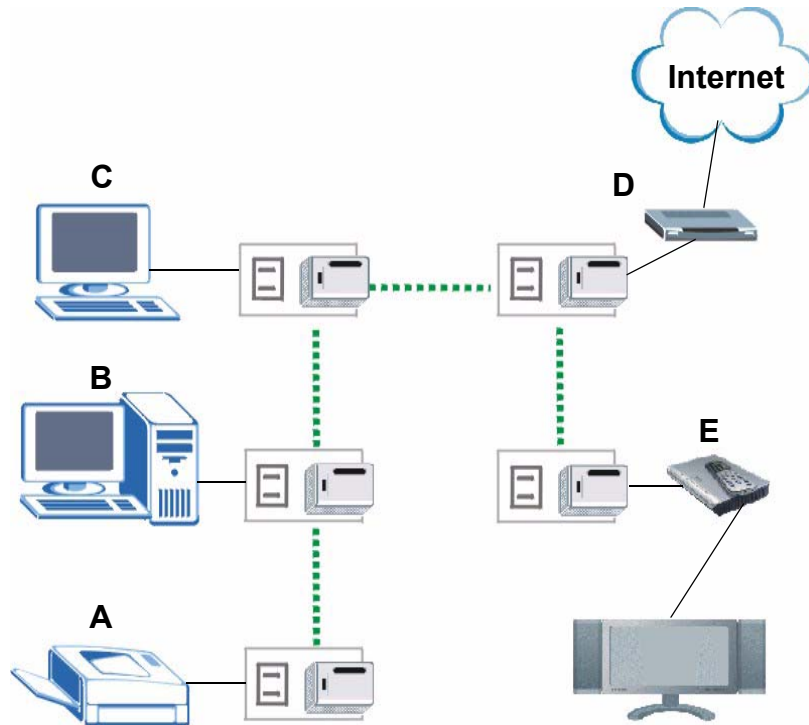
**Table 6** Priority Settings

PRIORITY LEVEL	APPLICATION
High	Voice Application
Medium	Video and Audio Applications
Normal	Data Applications
Low	Data Applications

The figure below shows an example powerline home network connected to the Internet.

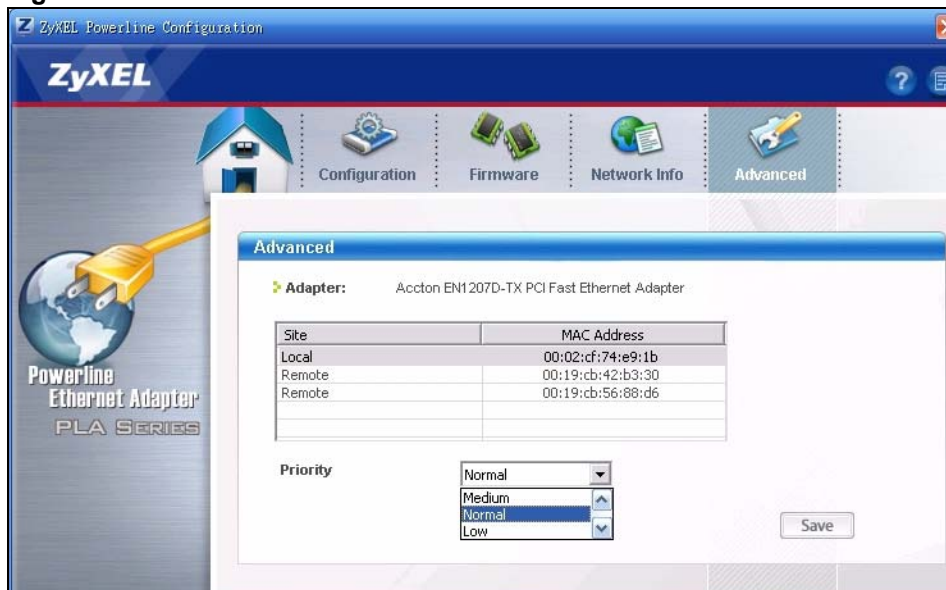
- Device A is a printer and does not handle traffic with high importance, so the powerline adapter connected to it can be set to low priority.
- Device B is a file server, delivering audio or movie files to other users on the network. The powerline adapter attached to it should have a medium setting.
- Device C, a home computer which connects to the Internet, can receive a normal priority setting as it usually sends simple requests for data. For example, when you surf the Internet, your computer sends requests to open web pages.
- Device D is a modem attached to the Internet. It should receive a high priority setting if you want faster downloading through your network.
- Although device E receives audio or movie files, it does not send a lot of traffic, so the powerline adaptor attached to it can be set to a low priority.

Figure 27 Priority Settings



Use this screen to configure priority settings for traffic from the powerline adapters on your network.

Figure 28 Advanced Screen




The following table describes the labels in this screen.

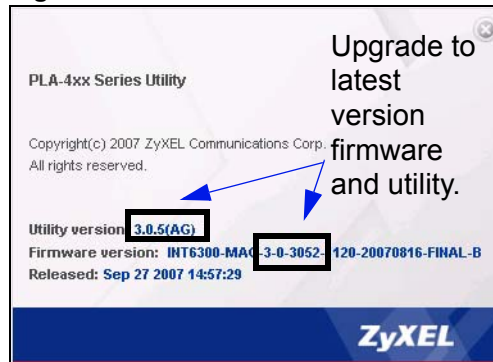
**Table 7** Advanced Screen

LABEL	DESCRIPTION
Adapter	This field identifies which powerline network information is displayed. Different powerline networks are identified by the Ethernet interface (network card) on your computer which is connected directly to a powerline adapter. Typically there is only one connection. However, if your computer has two network cards and both are connected to a powerline adapter, then you have two powerline networks.
Site	This field displays: <ul style="list-style-type: none"> <li>• <b>Local</b>, if it is the PLA-4xx directly connected to the computer running the configuration utility.</li> <li>• <b>Remote</b>, if it is a powerline adapter in your powerline network but not directly connected to the computer running the configuration utility.</li> </ul>
MAC Address	This is a read-only field which shows the MAC address of the powerline adapter you are configuring. You can find the MAC address of your PLA-4xx displayed on a sticker on the bottom of your device.
Priority	Select a priority setting from the drop-down box for traffic FROM your selected device. The options, in order of importance, are <b>High</b> , <b>Medium</b> , <b>Normal</b> and <b>Low</b> .
Save	Click this to apply your changes. The new <b>Priority</b> setting is applied to the selected powerline adapter.

## 5.7 About Screen

Use the **About** screen to view information regarding the configuration utility and firmware version of the PLA-4xx you are connected to. Click the  icon in the top right corner of the utility to view the **About** screen.

**Figure 29** About Screen




The following table describes the labels in this screen.

**Table 8** About Screen

LABEL	DESCRIPTION
Utility version:	This field displays the software version of the configuration utility.
Firmware version	This field displays the firmware version of the device you selected in the <b>Device Selection</b> field of the <b>Configuration</b> screen. In the example firmware version given in the screen, <b>3-0-3052</b> , the firmware version is shown by the numbers <b>305</b> , meaning this is firmware version 3.0.5. If your device's firmware is earlier than 3.0.5, please use the <b>Firmware Upgrade Tool</b> to upgrade your firmware.

**Table 8** About Screen (continued)

LABEL	DESCRIPTION
Released	This field displays the date when the firmware was released.
Close	Click the  button in upper right corner to close the <b>About</b> window.

# Powerline Network Setup Tutorial

Use this tutorial to expand your existing powerline network.

## 6.1 Overview

After setting up your first home powerline network (instructions for that are in the Quick Start Guide for your ZyXEL powerline adapter) you may want to extend the network or create a new one by adding additional powerline adapters. This tutorial shows you the following.

- How to start up your new powerline adapter. You need to do this before you can begin the next sections.
- How to make your existing powerline network bigger by adding new powerline adapters.
- How to make a new network separate from your existing network with new powerline adapters.
- How to make a new, separate powerline network with the powerline adapters you have.

The tutorial uses the **PLA-4xx Series Configuration Utility** to set up your powerline adapter.

If you haven't already installed the utility, see [Chapter 2 on page 23](#) for instructions. If you do not have the CD with the utility, the utility software is also available for download at [www.zyxel.com](http://www.zyxel.com). Navigate to the powerline products section of the ZyXEL website to find this software. Follow the instructions provided by the software to install it on your computer.

See the product specifications in the User's Guide for a list of hardware and software compatible with the utility.



---

The PLA-4xx in this tutorial is an example only. Your powerline adapter may be different.

---

## 6.1.1 Important Terms

Network Name	The network name allows a powerline adapter to connect with other powerline adapters that have the same network name. It provides security for your powerline network. The network name uses English letters or numbers, from 8 to 64 characters long, with no spaces allowed.
DAK Password	DAK = Device Access Key. The DAK Password lets you access the powerline adapter. You can find the DAK Password on a label on your powerline device.

## 6.1.2 Accessing Your Powerline Adapter

- 1 Attach the power cord that came in the package to your powerline adapter.
- 2 Plug the power cord of the powerline adapter you want to add to your network into a power socket and, if needed, switch the power socket on.

**Figure 30** Plug Your Powerline Adapter into a Power Socket



- 3 Connect the powerline adapter to your computer.
- 4 Use a LAN or Ethernet cable (shown below) to connect the LAN or Ethernet port on your adapter to the same kind of port on your computer.

**Figure 31** Connect Your Powerline Adapter to a Computer



- 5 Open the **PLA-4xx Series Configuration Utility** on your computer. Go to **Start > (All) Programs > ZyXEL PLA-4xx Series Configuration > PLA-4xx Series Configuration Utility**, or click on the icon on your desktop shown below.

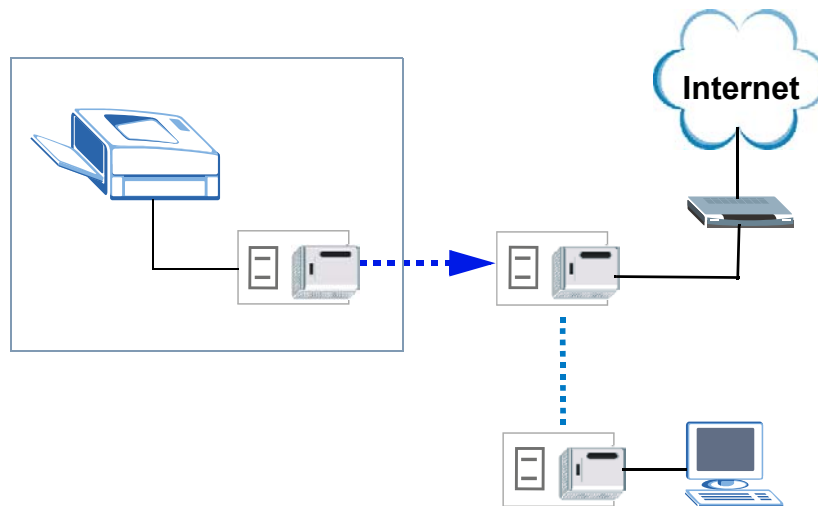
**Figure 32** Click on the PLA-4xx Series Configuration Utility Icon

- 6 You are now ready to extend your powerline network or set up a second network.
- See [Section 6.1.3 on page 55](#) to add a new powerline adapter to your network.
  - See [Section 6.1.4 on page 57](#) to set up a second network with your new adapters.
  - See [Section 6.1.5 on page 58](#) to set up a second network with your existing adapters.

### 6.1.3 Adding a Powerline Adapter

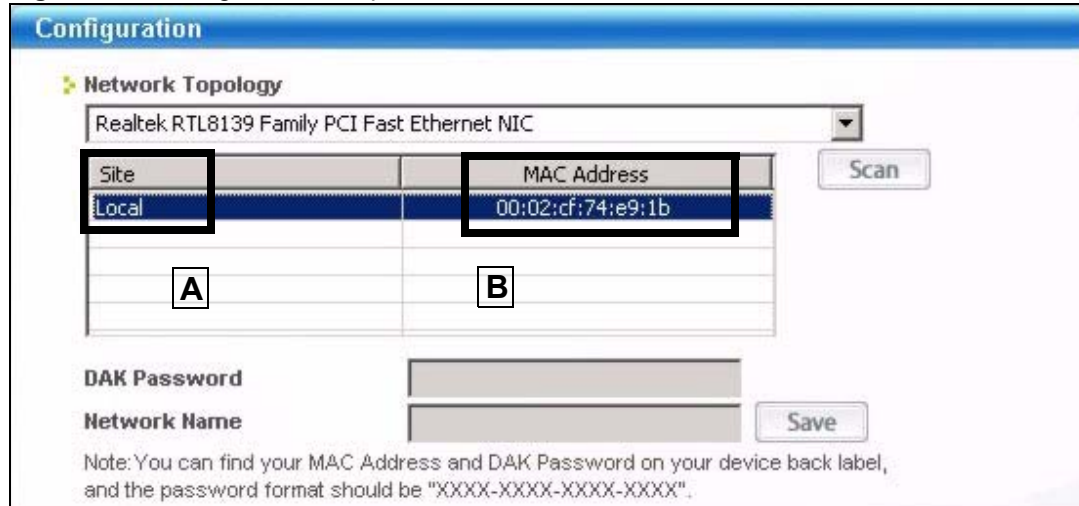
This section shows you how to add a new powerline adapter to expand your existing network.

The figure below shows the family computer with Internet access on a powerline network. Expand the network by adding a new powerline adapter connected to a printer.

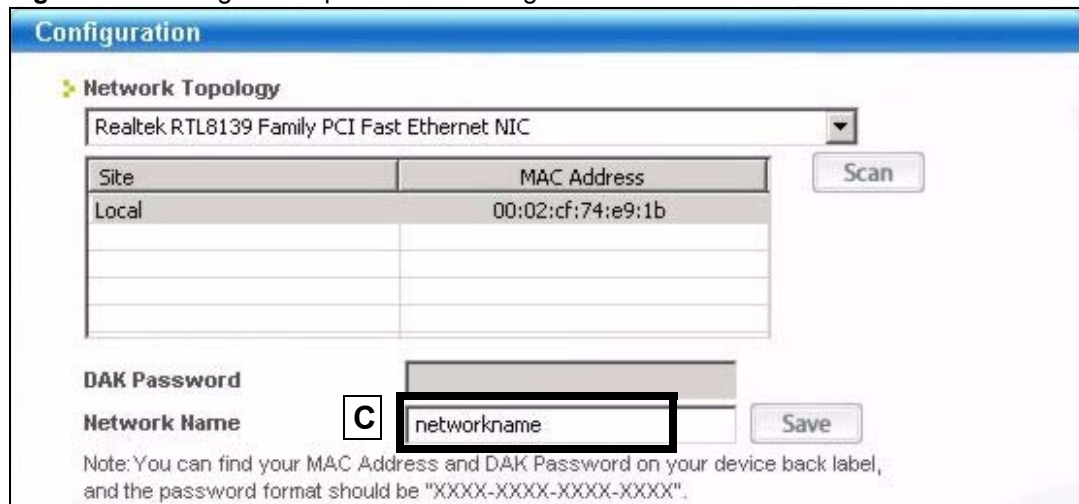
**Figure 33** Add a Printer to Your Powerline Network

You do not need to know the network name of the new adapter to add it to your network.

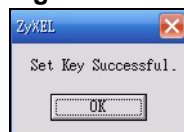
- 1 Connect your computer to the powerline adapter you want to add to your network and open the **PLA-4xx Series Configuration Utility** (see [Section 6.1.2 on page 54](#)).
- 2 The utility should open to the configuration tab. On this screen in the **Site** column your new powerline adapter should appear as **Local (A)**. Check the **Local** adapter's MAC address (**B**). It should match the MAC address listed on the label on the back of your powerline adapter.

**Figure 34** Adding a New Adapter

- 3 Select your adapter by selecting **Local** and type the network name for your existing network in the **Network Name** field (C).

**Figure 35** Adding an Adapter to an Existing Network

- 4 Click **Save** and click **OK** on the pop-up.

**Figure 36** Network Name Pop-up

- 5 Your new adapter will now have the same **Network Name** as your existing network and so has now joined your existing network.
- 6 Connect the adapter to the device you want to add to the network, for example, your Internet refrigerator in the kitchen.
- 7 Plug the adapter's power cord into a power outlet and, if required, switch the power outlet on.
- 8 Repeat this procedure for all additional powerline adapters that you want to add to your existing or new powerline network.

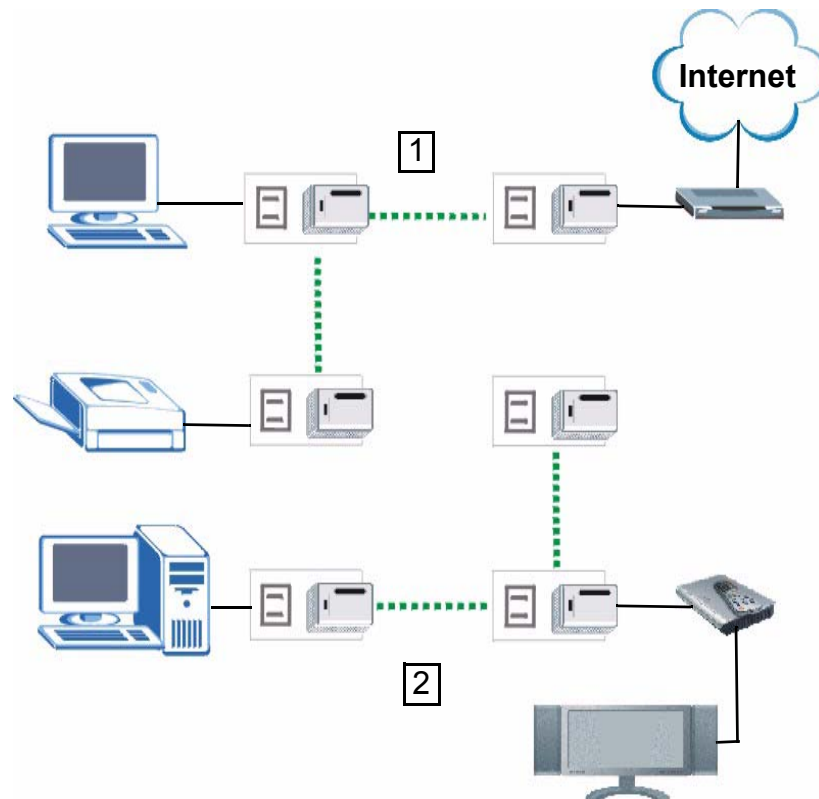


## 6.1.4 Setting Up a New Network with a New Adapter

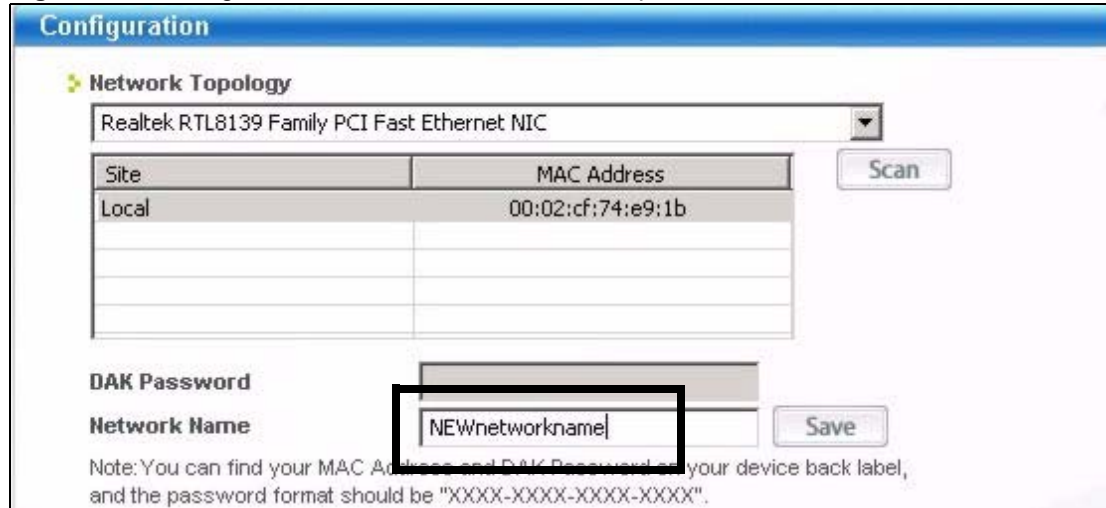
This section shows you how to use your new powerline adapters to set up a new powerline network separate to your existing network.

The figure below shows two powerline networks in a house. The first network (1) shows the home computer connected to a printer and access to the Internet. The second network (2) has no Internet access but with a media adapter such as the ZyXEL DMA-1100P you can use your TV to watch movies and play games which are stored on a computer.

**Figure 37** Add New Adapters to Make a Second Network



- 1 Connect your new powerline adapter and open the configuration utility as shown in [Section 6.1.4 on page 57](#). The screen shown below appears.
- 2 Type a **Network Name** that is different from the **Network Name** for your existing network. Make sure you use the same new **Network Name** for all new adapters you want to add to your new network.

**Figure 38** Making a New Network with the New Adapter

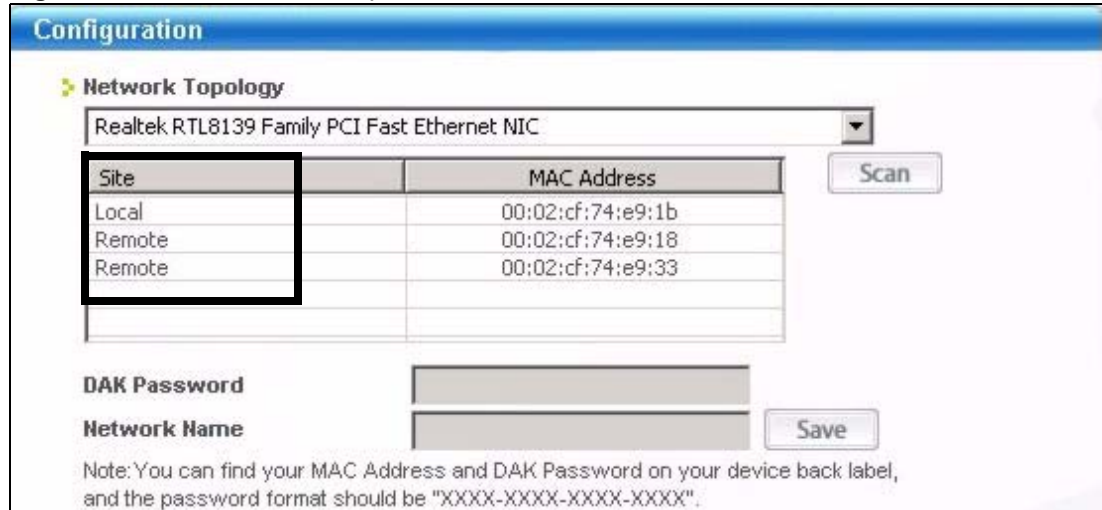
- 3 After you have set up a new network, you are ready to connect each powerline adapter on your new network to devices, for example, a computer or a games console.

### 6.1.5 Splitting a Network into Two Networks

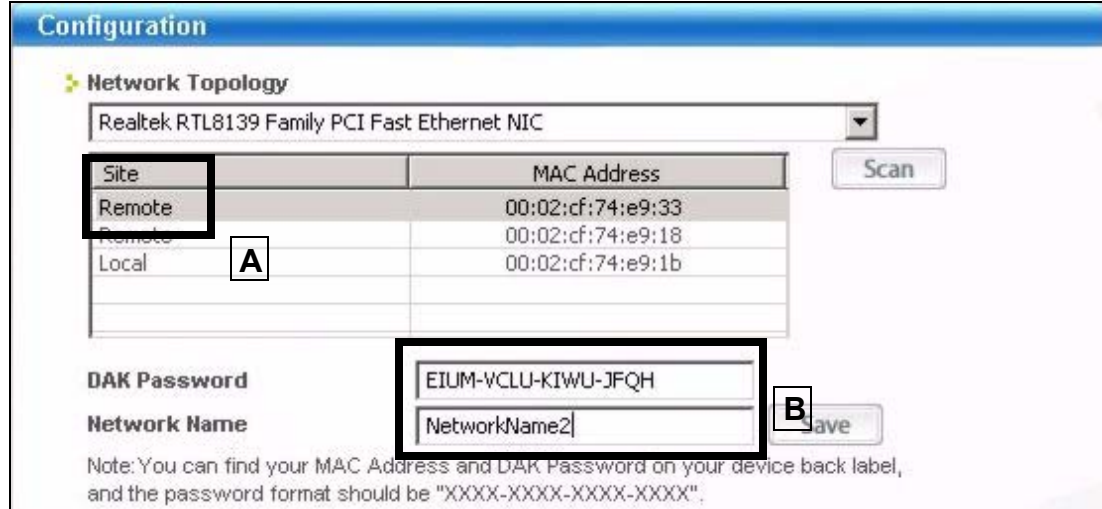
This section shows you how to split your existing network into two networks. This is useful if you want to set up a second powerline network in your home, for example, in your study connecting a laptop and printer. See [Figure 37 on page 57](#) for an example.

To set up your existing powerline network you had to set each powerline adapter with the same network name. To move some of these adapters to a new network, you need to give them a new network name.

- 1 Connect a powerline adapter to your computer and open the **PLA-4xx Series Configuration Utility** (see [Section 6.1.2 on page 54](#)).
- 2 The utility should open to the configuration tab as shown below. A list of powerline adapters on your network displays. These adapters all have the same network name as the adapter you are connected to. The adapter you are connected to will appear as **Local** in this table. All others are listed as **Remote**.

**Figure 39** Local/Remote Adapters on a Powerline Network

- 3** To set up a new powerline network, type the **DAK Password** and change the **Network Name** on all powerline adapters you wish to add to your network.
- Look for the **DAK Password** on a label on your powerline adapter. The **DAK Password** lets you access the adapter.
  - Select the **Remote** adapter you want to add (**A**) and type the **DAK Password** in the **DAK Password** field (**B**).
  - Then type the new network name in the **Network Name** field.

**Figure 40** Adding an Adapter to Your New Network

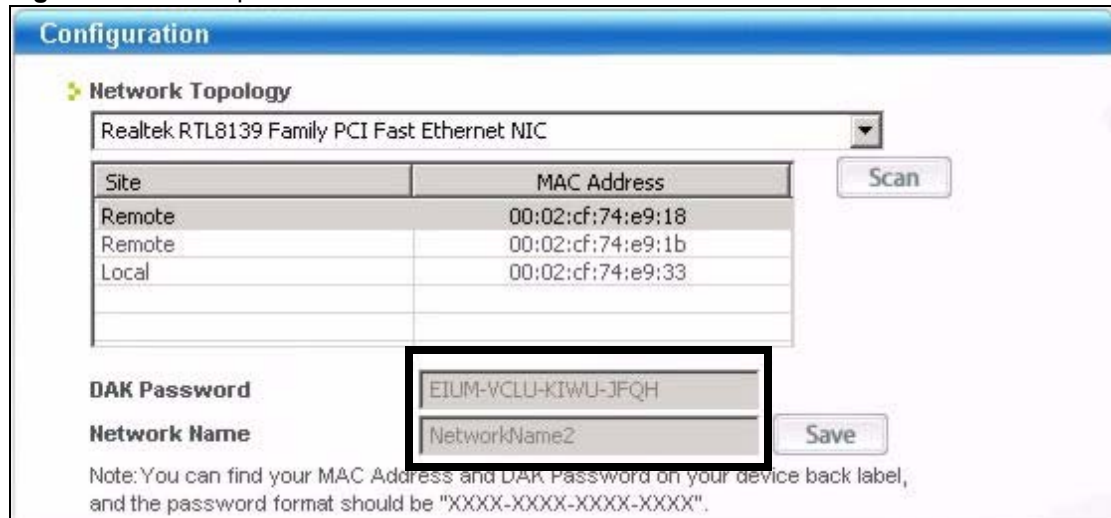
- 4** Click **Save**.
- If you do not type the **DAK password** or type it incorrectly either of the following pop-ups appear. Click **OK** and type the **DAK Password** correctly in the **DAK Password** field.

**Figure 41** Incorrect DAK or No DAK

- If you have correctly entered the **DAK Password**, click **OK** on the pop-up.

**Figure 42** Correct DAK

- 5 The settings for the adapter will now grey out and the adapter will disappear from the table after a few minutes.

**Figure 43** An Adapter on Your New Network

- 6 Go back to step 3 in this section to set the same, new **Network Name** for all remote adapters you want to add to your new network.
- 7 Check you have added the adapters correctly by changing the **network name** for the local adapter. All adapters with the new **Network Name** now appear in the list of adapters on your network. These adapters are now part of your new network.

**Figure 44** Adapters on a New Powerline Network

The screenshot shows a 'Configuration' window with a 'Network Topology' section. A dropdown menu is set to 'Realtek RTL8139 Family PCI Fast Ethernet NIC'. Below it is a table with two columns: 'Site' and 'MAC Address'. The table contains three rows: 'Remote' with MAC '00:02:cf:74:e9:1b', 'Remote' with MAC '00:02:cf:74:e9:1a', and 'Local' with MAC '00:02:cf:74:e9:33'. To the right of the table is a 'Scan' button. Below the table are fields for 'DAK Password' (containing 'EIUM-VCLU-KIWU-JFQH') and 'Network Name' (containing 'NetworkName2'), with a 'Save' button to the right. A note at the bottom states: 'Note: You can find your MAC Address and DAK Password on your device back label, and the password format should be "XXXX-XXXX-XXXX-XXXX".'

Site	MAC Address
Remote	00:02:cf:74:e9:1b
Remote	00:02:cf:74:e9:1a
Local	00:02:cf:74:e9:33

- If you want to access any of your new powerline networks using the **PLA-4xx Series Configuration Utility**, change the **Network Name** on your local adapter to the network name for the network you want to access. The adapters on that network will then display in the adapter table, allowing you to select and configure each one.

## 6.2 Troubleshooting

The HomePlug (🏠) LED (light) should light up on your adapter when it successfully connects to other adapters on your network. If it does not, try the following measures.

- Make sure the adapter is plugged in to a power socket and the power socket is turned on.
- Check you have entered the correct network name for your network.
- Check your powerline adapter is connected to the same electrical circuit as other powerline adapters on your network.



# LEDs and Troubleshooting

This chapter describes the behavior of the LEDs (lights) and offers some suggestions to solve problems you might encounter.

## 7.1 LEDs

The following sections describes the lights on the PLA-400, PLA-400 v2 and PLA402 v2, the PLA-401, PLA401 v2 and the PLA-470.

### 7.1.1 PLA-401/PLA401 v2


The following figure is the front panel of the PLA-401. Use the lights to determine if the PLA-4xx is behaving normally or if there are some problems on your powerline network.



**Figure 45** PLA-401 Lights



The following table describes the behavior of the lights on the PLA-401.




**Table 9** PLA-401 Lights

LIGHT	ICON	STATUS	DESCRIPTION
POWER		On	The PLA-401 is on and receiving power.
		Off	The PLA-401 is not receiving power.

LIGHT	ICON	STATUS	DESCRIPTION
HomePlug		On	The PLA-401 detects another powerline adapter.
		Blinking	The PLA-401 is communicating with another powerline adapter.
		Off	The PLA-401 is not detecting another powerline adapter.
ETHERNET		On	The ETHERNET port is on and ready and the PLA-401 detects a device connected to it.
		Blinking	The PLA-401 is communicating with a router, modem, switch or a computer connected to it.
		Off	The PLA-401 does not detect any devices connected to its ETHERNET port.

The following table describes the behavior of the lights on the PLA-401 v2.

**Table 10** PLA-401 v2 Lights

LIGHTS	ICON	COLOR	STATUS	DESCRIPTION
POWER		Green	On	The PLA-401 v2 is on and receiving power. It also indicates a successful connection using the <b>ENCRYPT</b> button.
			Blinking	The PLA-401 v2 is starting up. It also indicates the PLA-400 v2 is trying to connect with another device using the ENCRYPT function. Blinking at the same time as the HomePlug light indicates an unsuccessful connection if you have used the <b>ENCRYPT</b> button.
			Off	The PLA-401 v2 is not receiving power.
HomePlug		Green	On	The PLA-401 v2 detects another powerline adapter. The data transfer rate is greater than 40 Mbps.
		Amber		The PLA-401 v2 detects another powerline adapter. The data transfer rate is between 10~40 Mbps.
		Red		The PLA-401 v2 detects another powerline adapter. The data transfer rate is between 0~10 Mbps.
		Green/ Amber/ Red	Blinking	The PLA-401 v2 is communicating with another powerline adapter. Data is being transmitted and/or received. Blinking at the same time as the POWER light indicates an unsuccessful connection if you have used the <b>ENCRYPT</b> button.
			Off	The HomePlug port does not detect another powerline adapter.
ETHERNET		Green	On	The ETHERNET port is on and ready and the PLA-401 v2 detects a device connected to it.
			Blinking	The PLA-401 v2 is communicating with a networking device connected to it.
			Off	The PLA-401 v2 does not detect any devices connected to its ETHERNET port.



## 7.1.2 PLA-400/400 v2/402 v2




The following figure is the front panel of the PLA-400, PLA-400 v2 and PLA402 v2. Use the lights to determine if your PLA-4xx is behaving normally or if there are some problems on your powerline network.

**Figure 46** PLA-400/400 v2/ 402 v2 Lights




The following table describes the behavior of the lights on the PLA-400.

**Table 11** PLA-400 Lights



LIGHTS	ICON	STATUS	DESCRIPTION
POWER		On	The PLA-400 is on and receiving power.
		Off	The PLA-400 is not receiving power.
HomePlug		On	The PLA-400 detects another powerline adapter.
		Blinking	The PLA-400 is communicating with another powerline adapter.
		Off	The PLA-400 is not detecting another powerline adapter.
ETHERNET		On	The ETHERNET port is on and ready and the PLA-400/402 v2 detects a device connected to it.
		Blinking	The PLA-400 is communicating with a router, modem, switch or a computer connected to it.
		Off	The PLA-400 does not detect any devices connected to its ETHERNET port.

The following table describes the behavior of the lights on the PLA-400 v2.

**Table 12** PLA-400 v2/402 v2 Lights

LIGHTS	ICON	COLOR	STATUS	DESCRIPTION
POWER		Green	On	The PLA-400 v2/402 v2 is on and receiving power. It also indicates a successful connection using the <b>ENCRYPT</b> button.
			Blinking	The PLA-400 v2/402 v2 is starting up. It also indicates the PLA-400 v2 is trying to connect with another device using the ENCRYPT function. Blinking at the same time as the HomePlug light indicates an unsuccessful connection if you have used the <b>ENCRYPT</b> button.
			Off	The PLA-400 v2/402 v2 is not receiving power.

**Table 12** PLA-400 v2/402 v2 Lights (continued)

LIGHTS	ICON	COLOR	STATUS	DESCRIPTION
HomePlug		Green	On	The PLA-400 v2/402 v2 detects another powerline adapter. The data transfer rate is greater than 40 Mbps.
		Amber		The PLA-400 v2/402 v2 detects another powerline adapter. The data transfer rate is between 10~40 Mbps.
		Red		The PLA-400 v2/402 v2 detects another powerline adapter. The data transfer rate is between 0~10 Mbps.
		Green/ Amber/ Red	Blinking	The PLA-400 v2/402 v2 is communicating with another powerline adapter. Data is being transmitted and/or received. Blinking at the same time as the POWER light indicates an unsuccessful connection if you have used the <b>ENCRYPT</b> button.
			Off	The HomePlug port does not detect another powerline adapter.
ETHERNET		Green	On	The ETHERNET port is on and ready and the PLA-400 v2/402 v2 detects a device connected to it.
			Blinking	The PLA-400 v2/402 v2 is communicating with a networking device connected to it.
			Off	The PLA-400 v2/402 v2 does not detect any devices connected to its ETHERNET port.




### 7.1.3 PLA-470/PLA470 v2

The following figure is the front panel of the PLA-470 and PLA-470 v2. Use the lights to determine if the PLA-470 or PLA470 v2 is behaving normally or if there are some problems on your powerline network.

**Figure 47** PLA-470 and PLA-470 v2 Lights


The following table describes the behavior of the lights on the PLA-470.

**Table 13** PLA-470 Lights



LIGHTS	ICON	COLOR	STATUS	DESCRIPTION
POWER		Green	On	The PLA-470 is on and receiving power. It also indicates a successful connection using the <b>ENCRYPT</b> button.
			Blinking	The PLA-470 is starting up. It also indicates the PLA-470 is trying to connect with another device using the ENCRYPT function. Blinking at the same time as the HomePlug light indicates an unsuccessful connection if you have used the <b>ENCRYPT</b> button.
			Off	The PLA-470 is not receiving power.
HomePlug		Green	On	The PLA-470 detects another powerline adapter. .
			Blinking	The PLA-470 is communicating with another powerline adapter. Data is being transmitted and/or received. Blinking at the same time as the POWER light indicates an unsuccessful connection if you have used the <b>ENCRYPT</b> button.
			Off	The HomePlug port does not detect another powerline adapter.
ETHERNET		Green	On	The ETHERNET port is on and ready and the PLA-470 detects a device connected to it.
			Blinking	The PLA-470 is communicating with a router, modem, switch or a computer connected to it.
			Off	The PLA-470 does not detect any devices connected to its ETHERNET port.

The following table describes the behavior of the lights on the PLA470 v2.

**Table 14** PLA470 v2 Lights

LIGHTS	ICON	COLOR	STATUS	DESCRIPTION
POWER		Green	On	The PLA470 v2 is on and receiving power. It also indicates a successful connection using the <b>ENCRYPT</b> button.
			Blinking	The PLA470 v2 is starting up. It also indicates the PLA470 v2 is trying to connect with another device using the ENCRYPT function. Blinking at the same time as the HomePlug light indicates an unsuccessful connection if you have used the <b>ENCRYPT</b> button.
			Off	The PLA470 v2 is not receiving power.

**Table 14** PLA470 v2 Lights (continued)

LIGHTS	ICON	COLOR	STATUS	DESCRIPTION
HomePlug		Green	On	The PLA470 v2 detects another powerline adapter. The data transfer rate is greater than 40 Mbps.
		Amber		The PLA470 v2 detects another powerline adapter. The data transfer rate is between 10~40 Mbps.
		Red		The PLA470 v2 detects another powerline adapter. The data transfer rate is between 0~10 Mbps.
		Green/ Amber/ Red	Blinking	The PLA470 v2 is communicating with another powerline adapter. Data is being transmitted and/or received. Blinking at the same time as the POWER light indicates an unsuccessful connection if you have used the <b>ENCRYPT</b> button.
			Off	The HomePlug port does not detect another powerline adapter.
ETHERNET		Green	On	The ETHERNET port is on and ready and the PLA470 v2 detects a device connected to it.
			Blinking	The PLA470 v2 is communicating with a router, modem, switch or a computer connected to it.
			Off	The PLA470 v2 does not detect any devices connected to its ETHERNET port.

## 7.2 Power and Light Problems



The PLA-4xx does not turn on. None of the lights turn on.

- 1 Make sure you are using the power cord included with the PLA-4xx.
- 2 Make sure the power cord is connected to the PLA-4xx and plugged in to an appropriate power source. Make sure the power source is turned on.
- 3 Disconnect and re-connect the power cord to the PLA-4xx.
- 4 Remove the powerline adapter from the outlet. Then connect an electrical device that you know works into the same power outlet. This checks the status of the power outlet.
- 5 If the problem continues, contact the vendor.



The ETHERNET light does not turn on.

- 1 Check the hardware connections. See the Quick Start Guide.
- 2 Inspect your cables for damage. Contact the vendor to replace any damaged cables.
- 3 Check the Ethernet adapter on your computer and make sure it's enabled and working properly.


- 4 If the PLA-4xx is connected to an Ethernet switch or router, make sure the device is working correctly, and that the LAN network is working and configured correctly as well.



---

### The HomePlug light does not turn on.

---

- 1 Check all PLA-4xxs on your network have the latest firmware installed. PLA-4xxs with the latest firmware cannot communicate with PLA-4xxs using earlier versions of the firmware. Go to [Section 5.4 on page 46](#) for instructions on installing the latest firmware.
- 2 Use the **PLA-4xx Series Configuration Utility** to detect all other HomePlug devices on your powerline network. Make sure that the network name (sometimes called the network password) is the same on all of your powerline adapters. See [Section 5.3 on page 45](#) for instructions on checking the network name.
- 3 Check the DAK password and MAC address for all powerline adapters are typed correctly in the utility. See [Section 5.3 on page 45](#) for instructions on checking the DAK and MAC address.
- 4 Make sure that all your powerline adapters are HomePlug AV compliant. Check the package it came in or ask your vendor. This PLA-4xx can not detect earlier versions of HomePlug powerline adapters such as HomePlug 1.0 or 1.0.1. (Although they can coexist on the same electrical wiring without interfering with each other.)
- 5 Make sure that the powerline adapters on your network are all on the same electrical wiring. Connect another powerline adapter into an outlet close to your PLA-4xx's power outlet. They are probably now on the same electrical wiring. Check the HomePlug  light. If it now lights up your powerline adapter was probably previously on separate electrical wiring. Ask an electrician for more information on the electrical wiring in your building.
- 6 If your powerline network is using coaxial cable, check all powerline adapters are on the same coaxial cable.
- 7 If your powerline network is using electrical wiring (not coaxial cable), check you do not have a power meter between powerline adapters. Powerline signals cannot pass this.



---

### The POWER and HomePlug light blink at the same time.

---

- You have pressed the ENCRYPT button for more than three seconds. Try setting up a connection again, this time pressing the ENCRYPT buttons on both devices for less than three seconds.

## 7.3 Configuration Utility Problems



---

The PLA-4xx Series Configuration Utility displays an error during installation.

---

- Make sure your computer is using Windows XP or Windows Vista (32-bit) operating system. At the time of writing, this is the only compatible operating system for the configuration utility.



---

The PLA-4xx Series Configuration Utility does not display all or any of my devices.

---

- Inspect the LEDs on your PLA-4xx and make sure that the ETHERNET and HomePlug LEDs are on or blinking. See [Section 7.2 on page 68](#) for troubleshooting LED related problems.
- Check all ZyxEL HomePlug AV devices on your network have the latest firmware installed. The latest utility cannot communicate with PLA-4xxs using earlier versions of the firmware. Go to [Section 5.4 on page 46](#) for instructions on installing the latest firmware.
- Check you are using the latest version utility. Earlier version utilities cannot communicate with PLA-4xxs using the latest firmware. If you do not have the latest utility, download it from the ZyXEL website.
- If the device is not a ZyXEL device, then the DAK and Network Name will be greyed out.
- If you are running another tool such as the **Firmware Detection Tool** or **Firmware Upgrade Tool**, the Utility will not detect your local device.

## 7.4 Powerline Problems



---

The signal on my powerline network is weak.

---

- 1 Your powerline adapters may be connected to electrical surge protectors. Connect them to standard power outlets.
- 2 Your powerline adapters may be located close to large appliances such as refrigerators or air-conditioners that cause interference with the powerline signal. Move the adapters further away from such appliances to reduce interference.
- 3 Your powerline adapters may be placed close to electrical devices such as electrical insect-killers which produce radio waves. These may interfere with the powerline signals. Move the adapters further away from such electrical devices.
- 4 Your wiring may be old and/or low quality or with a long wiring path.

## 7.5 ENCRYPT Button Problems

This section applies only to PLA-4xxs with the **ENCRYPT** button.



The HomePlug light is already on, but I haven't pressed the **ENCRYPT** button yet.

Your device has already connected to another powerline device. Press the **ENCRYPT** button for more than 10 seconds to release the connection.



The **POWER** light does not blink when I press the **ENCRYPT** button.

- Check the device is on.
- Press the **ENCRYPT** button again, making certain you have pressed the button for more than one second and less than three seconds.
- The **POWER** light on some powerline devices do not blink as part of the **ENCRYPT** process. Check your powerline device is a PLA-4xx.



The **POWER** light blinks two times quickly then pauses, before repeating.

The **ENCRYPT** process has failed. Press the **ENCRYPT** button on both devices for more than 10 seconds, then try to reconnect.



The **POWER** lights on both devices blink when I press the **ENCRYPT** buttons, but the HomePlug light does not turn on.

- Ensure you have pressed the **ENCRYPT** button on **both** devices.
- Wait for about a minute while the devices set up a connection.
- If that does not work, try again with both devices connected to a power strip next to each other. If they now connect, then the devices were not on the same electrical circuit before.



The **POWER** lights on both devices blink, then many lights blink and the HomePlug light blinks red.

Do not worry, the connection process is proceeding normally.



---

The POWER lights on both devices finished blinking, but only one device's HomePlug light is on.

---

One device may have connected to a third powerline device. To check device A is connected to device B and not another device, disconnect device B from its power source. Device A's HomePlug (🏠) light will turn off if the connection is with Device B. Press the **ENCRYPT** button on **both** devices for more than 10 seconds, then try to reconnect, pressing the **ENCRYPT** button for less than 3 seconds on both devices.



---

I pressed the ENCRYPT button for more than 10 seconds, but the HomePlug light is still on.

---

The HomePlug light is on, indicating it is still connected to another powerline device. Try again, pressing the **ENCRYPT** button for more than 10 seconds.



---

# PART III

## Appendices and Index

---

Product Specifications (75)

Customer Support (85)

Legal Information (81)

Index (91)



# Product Specifications

The following tables summarize the PLA-4xx's hardware and firmware features.

**Table 15** Hardware Specifications

Dimensions (W x D x H)	<p><b>PLA-400/400 v2/402 v2</b> 112 (L) mm x 106 (D) mm x 28.5 (H) mm</p> <p><b>PLA-470</b> 162 (L) mm x 118 (D) mm x 40 (H) mm</p> <p><b>PLA470 v2</b> 162 (L) mm x 118 (D) mm x 35 (H) mm</p> <p><b>PLA-401/PLA401 v2</b> 97 mm (L) x 45 (H) mm x 70 (W) mm</p>
Power Input	<p><b>PLA-400/401 v2</b> 100 - 240 VAC, 50/60 Hz, 0.12 A</p> <p><b>PLA-400 v2/402 v2</b> 100 - 240 VAC, 50/60 Hz, 0.13 A</p> <p><b>PLA401/470/470 v2</b> 100 - 240 VAC, 50/60 Hz, 0.2 A</p>
Ethernet Port	<p>Auto-negotiating: 10 Mbps or 100 Mbps in either half-duplex or full-duplex mode.</p> <p>Auto-crossover: Use either crossover or straight-through Ethernet cables.</p>
RESET	<p>Pressing this button in for less than 3 seconds resets the device to factory default settings. Network Name becomes <b>HomePlugAV</b>.</p> <p>Pressing this button in for more than 10 seconds resets the firmware to the previous version.</p>
ENCRYPT	<p>Pressing this button in for less than 3 seconds begins the connection setup process.</p> <p>Pressing this button in for more than 10 seconds resets the network name to a random value.</p>
Coaxial Port	<b>PLA 402 v2 only</b>
Operation Environment	<p><b>PLA-400/401/400 v2/470/470 v2</b> Temperature: 0° C ~ 45° C Humidity: 5% ~ 95% Noncondensing</p> <p><b>PLA401 v2/PLA402 v2</b> Temperature: 0° C ~ 45° C Humidity: 10% ~ 85% Noncondensing</p>
Storage Environment	<p><b>PLA-400/401/400 v2/470/470 v2</b> Temperature: -10° C ~ 70° C Humidity: 10% ~ 85% Noncondensing</p> <p><b>PLA401 v2/PLA402 v2</b> Temperature: - 20° C ~ 60° C Humidity: 10% ~ 90% Noncondensing</p>

**Table 15** Hardware Specifications

Cabling Type	<p><b>PLA-400/400 v2/401/401 v2/402/470/470 v2</b> 1 x Power Cord</p> <p><b>PLA-400/400 v2/401/401 v2/402</b> 1 x LAN UTP Category 5 or Better</p> <p><b>PLA-402 v2</b> 1 x Coaxial Cable (RG6 or RG59 cable with 75 ohm impedance preferred but others are compatible. RG6 cables are common for CATV. F-Type Male connector required.)</p> <p><b>PLA-470</b> 4 x LAN UTP Category 5 or Better</p>
Network Interface	<p><b>PLA-400/400 v2/401/401 v2/402 v2/470/470 v2</b> 1 x 200 Mbps Powerline port compliant with HomePlug AV standard</p> <p><b>PLA-400/400 v2/401/401 v2/402 v2</b> 1 x 10/100M BASE-T Ethernet port with Auto MDI/MDIX</p> <p><b>PLA-470/470 v2</b> 4 x 10/100 M Base-T Ethernet Ports with Auto MDI/MDIX</p> <p><b>PLA-402 v2</b> 1 x Coaxial Cable Port</p>
Distance between the centers of the holes on the device's back.	<p><b>PLA-400/400 v2/401/401 v2/402 v2</b> 74 mm</p> <p><b>PLA-470/470 v2</b> 115mm</p> <p><b>PLA-401/401 v2</b> Not applicable</p>
Recommended type of screws for wall-mounting	<p><b>PLA-400/400 v2/402 v2/470/470 v2</b> M3 Tap Screw</p> <p><b>PLA-401/401 v2</b> Not applicable</p>

**Table 16** Firmware Specifications

FEATURE	DESCRIPTION
Powerline Functionality	<p>The HomePlug AV standard specifies how network devices communicate using standard electrical wiring.</p> <p>It supports a data transfer rate of up to 200Mbps.</p> <p>Data is encrypted using 128-bit AES (Advanced Encryption Standard).</p> <p>HomePlug AV compatible devices co-exist with HomePlug 1.0 devices but do not detect each other.</p> <p>The range of a HomePlug AV Powerline network is 300 meters/984 feet in optimal conditions.</p> <p>HomePlug AV is compatible with all OSs.</p> <p>The maximum number of devices connected (bridged) to single powerline adapter is 64.</p> <p>The maximum number of powerline devices on a single network is 64.</p> <p>The maximum number of powerline networks on a single electrical circuit is 4.</p> <p>HomePlug AV devices using version 3.0.5 firmware cannot communicate with earlier version firmware.</p>
Coaxial Functionality	The range of a HomePlug AV Coaxial network is 800 meters/2624 feet in optimal conditions.
Encryption	128-bit AES Encryption

**Table 16** Firmware Specifications

FEATURE	DESCRIPTION
Frequency Band	1.8 MHz ~ 30 MHz
Certifications	FCC, CE, CUL, UL, HomePlug AV, RoHS, C-Tick
Device Management	Use the PLA-4xx Series Configuration Utility version 3.0.5(AG) to easily configure the PLA-4xx.  Note: The PLA-4xx Series Configuration Utility version 3.0.5(AG) is only compatible with <b>PLA-4xxs</b> with the latest firmware installed.
Network Name	Change the powerline network name to only allow the powerline adapters you specify to join your network.
Firmware Upgrade	Download new firmware (when available) from the ZyXEL website and use the configuration utility to install it.  Note: You do not need the configuration utility to install the latest firmware. Follow the instructions in <a href="#">Section 5.4 on page 46</a> for installing the latest firmware.  Note: Only install firmware for your specific model!

**Table 17** Performance

FEATURE	DESCRIPTION
Throughput over PHYSical Transport Medium (PHY)	Supports up to 200 Mbps in half duplex mode
Throughput over UDP	Supports up to 150 Mbps over in-house power/coaxial lines (LAN port limits to 100 Mbps)
Number of devices in one powerline network	Supports up to 64 devices in 4 network groups

The following list, which is not exhaustive, illustrates the standards supported in the PLA-4xx.

**Table 18** Standards Supported

STANDARD	DESCRIPTION
HomePlug AV	Designed for transmitting audio/video on a home powerline network.
RFC 868	Time Protocol.
RFC 1112	IGMP v1
RFC 1157	SNMPv1: Simple Network Management Protocol version 1
RFC 1901	SNMP v2c Simple Network Management Protocol version 2c
RFC 2236	Internet Group Management Protocol, Version 2.

## Wall-mounting Instructions

Complete the following steps to hang your PLA-400/400 v2/401/401 v2/402 v2/470/470 v2 on a wall.



See [Table 15 on page 75](#) for the size of screws to use and how far apart to place them.

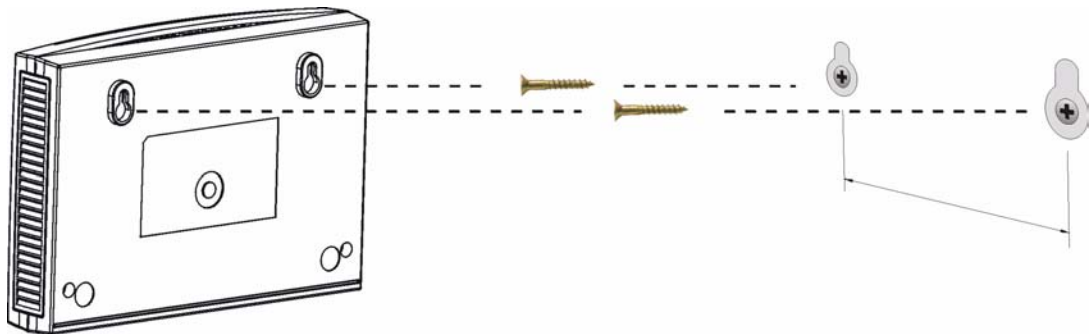
- 1 Select a high position on a sturdy wall that is free of obstructions.
- 2 Drill two holes for the screws. The distance between the centers of the holes is listed in the product specifications appendix.



Be careful to avoid damaging pipes or cables located inside the wall when drilling holes for the screws.

- 3 Do not insert the screws all the way into the wall. Leave a small gap of about 0.5 cm between the heads of the screws and the wall.
- 4 Make sure the screws are snugly fastened to the wall. They need to hold the weight of the PLA-4xx with the connection cables.
- 5 Align the holes on the back of the PLA-4xx with the screws on the wall. Hang the PLA-4xx on the screws.

**Figure 48** Wall-mounting Example



## Cable Pin Assignments

### RJ-45 Connector Pin Assignments

Figure 49 RJ-45 Connector Pins

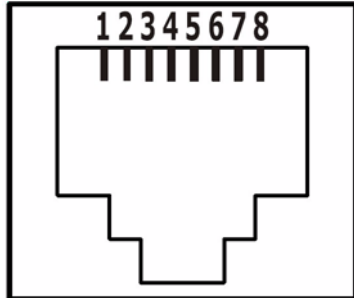


Table 19 RJ-45 Connector Pin Assignments

PIN NO	RJ-45 SIGNAL ASSIGNMENT
1	RxD +
2	RxD -
3	TxD +
4	Not connected
5	Not connected
6	TxD -
7	Not connected
8	Not connected





# Legal Information

## Copyright

Copyright © 2008 by ZyXEL Communications Corporation.

The contents of this publication may not be reproduced in any part or as a whole, transcribed, stored in a retrieval system, translated into any language, or transmitted in any form or by any means, electronic, mechanical, magnetic, optical, chemical, photocopying, manual, or otherwise, without the prior written permission of ZyXEL Communications Corporation.

Published by ZyXEL Communications Corporation. All rights reserved.

## Disclaimer

ZyXEL does not assume any liability arising out of the application or use of any products, or software described herein. Neither does it convey any license under its patent rights nor the patent rights of others. ZyXEL further reserves the right to make changes in any products described herein without notice. This publication is subject to change without notice.

## Trademarks

ZyNOS (ZyXEL Network Operating System) is a registered trademark of ZyXEL Communications, Inc. Other trademarks mentioned in this publication are used for identification purposes only and may be properties of their respective owners.

## Certifications

### Federal Communications Commission (FCC) Interference Statement

The device complies with Part 15 of FCC rules. Operation is subject to the following two conditions:

- This device may not cause harmful interference.
- This device must accept any interference received, including interference that may cause undesired operations.

This device has been tested and found to comply with the limits for a Class B digital device pursuant to Part 15 of the FCC Rules. These limits are designed to provide reasonable protection against harmful interference in a residential installation. This device generates, uses, and can radiate radio frequency energy, and if not installed and used in accordance with the instructions, may cause harmful interference to radio communications. However, there is no guarantee that interference will not occur in a particular installation.

If this device does cause harmful interference to radio/television reception, which can be determined by turning the device off and on, the user is encouraged to try to correct the interference by one or more of the following measures:

- 1 Reorient or relocate the receiving antenna.
- 2 Increase the separation between the equipment and the receiver.
- 3 Connect the equipment into an outlet on a circuit different from that to which the receiver is connected.
- 4 Consult the dealer or an experienced radio/TV technician for help.

### **CE-Konformität**

Das Produkt entspricht den grundlegenden Anforderungen der Richtlinie 1999/5/EG (R&TTE) sowie den übrigen einschlägigen Bestimmungen des FTEG und ist zum Betrieb in der EU und Schweiz vorgesehen. Das Produkt ist eine Einrichtung der Klasse A. Diese Einrichtung kann im Wohnbereich Funkstörungen verursachen; in diesem Fall kann vom Betreiber verlangt werden, angemessene Massnahmen durchzuführen.

### **Conformité CE**

Le produit satisfait aux exigences techniques de la directive 1999/5/CE (R&TTE) et est conçu pour être utilisé au sein de la Communauté européenne et en Suisse. Le produit fait partie de la classe A, ce qui signifie que son exploitation peut entraîner des bruits parasites dans les zones d'habitation; le cas échéant, l'exploitant peut être tenu de prendre des mesures appropriées pour remédier au dérangement.

### **Conformità CE**

Questo prodotto soddisfa le richieste tecniche della direttiva 1999/5/EG (R&TTE) ed è previsto per il funzionamento nella UE e in Svizzera. Il prodotto è dispositivo della classe A. Questo dispositivo può causare nel settore abitativo dei radiodisturbi.

In questo caso può essere richiesto al gestore di prendere opportune misure.

### **Notices**

Changes or modifications not expressly approved by the party responsible for compliance could void the user's authority to operate the equipment.

This Class B digital apparatus complies with Canadian ICES-003.

Cet appareil numérique de la classe B est conforme à la norme NMB-003 du Canada.

### **Viewing Certifications**

- 1 Go to <http://www.zyxel.com>.
- 2 Select your product on the ZyXEL home page to go to that product's page.
- 3 Select the certification you wish to view from this page.

## ZyXEL Limited Warranty

ZyXEL warrants to the original end user (purchaser) that this product is free from any defects in materials or workmanship for a period of up to two years from the date of purchase. During the warranty period, and upon proof of purchase, should the product have indications of failure due to faulty workmanship and/or materials, ZyXEL will, at its discretion, repair or replace the defective products or components without charge for either parts or labor, and to whatever extent it shall deem necessary to restore the product or components to proper operating condition. Any replacement will consist of a new or re-manufactured functionally equivalent product of equal or higher value, and will be solely at the discretion of ZyXEL. This warranty shall not apply if the product has been modified, misused, tampered with, damaged by an act of God, or subjected to abnormal working conditions.

### Note

Repair or replacement, as provided under this warranty, is the exclusive remedy of the purchaser. This warranty is in lieu of all other warranties, express or implied, including any implied warranty of merchantability or fitness for a particular use or purpose. ZyXEL shall in no event be held liable for indirect or consequential damages of any kind to the purchaser.

To obtain the services of this warranty, contact ZyXEL's Service Center for your Return Material Authorization number (RMA). Products must be returned Postage Prepaid. It is recommended that the unit be insured when shipped. Any returned products without proof of purchase or those with an out-dated warranty will be repaired or replaced (at the discretion of ZyXEL) and the customer will be billed for parts and labor. All repaired or replaced products will be shipped by ZyXEL to the corresponding return address, Postage Paid. This warranty gives you specific legal rights, and you may also have other rights that vary from country to country.

### Registration

Register your product online to receive e-mail notices of firmware upgrades and information at [www.zyxel.com](http://www.zyxel.com) for global products, or at [www.us.zyxel.com](http://www.us.zyxel.com) for North American products.



# Customer Support

Please have the following information ready when you contact customer support.

## Required Information

- Product model and serial number.
- Warranty Information.
- Date that you received your device.
- Brief description of the problem and the steps you took to solve it.

“+” is the (prefix) number you dial to make an international telephone call.

## Corporate Headquarters (Worldwide)

- Support E-mail: [support@zyxel.com.tw](mailto:support@zyxel.com.tw)
- Sales E-mail: [sales@zyxel.com.tw](mailto:sales@zyxel.com.tw)
- Telephone: +886-3-578-3942
- Fax: +886-3-578-2439
- Web: [www.zyxel.com](http://www.zyxel.com), [www.europe.zyxel.com](http://www.europe.zyxel.com)
- FTP: [ftp.zyxel.com](ftp://ftp.zyxel.com), [ftp.europe.zyxel.com](ftp://ftp.europe.zyxel.com)
- Regular Mail: ZyXEL Communications Corp., 6 Innovation Road II, Science Park, Hsinchu 300, Taiwan

## Costa Rica

- Support E-mail: [soporte@zyxel.co.cr](mailto:soporte@zyxel.co.cr)
- Sales E-mail: [sales@zyxel.co.cr](mailto:sales@zyxel.co.cr)
- Telephone: +506-2017878
- Fax: +506-2015098
- Web: [www.zyxel.co.cr](http://www.zyxel.co.cr)
- FTP: [ftp.zyxel.co.cr](ftp://ftp.zyxel.co.cr)
- Regular Mail: ZyXEL Costa Rica, Plaza Roble Escazú, Etapa El Patio, Tercer Piso, San José, Costa Rica

## Czech Republic

- E-mail: [info@cz.zyxel.com](mailto:info@cz.zyxel.com)
- Telephone: +420-241-091-350
- Fax: +420-241-091-359
- Web: [www.zyxel.cz](http://www.zyxel.cz)

- Regular Mail: ZyXEL Communications, Czech s.r.o., Modranská 621, 143 01 Praha 4 - Modrany, Česká Republika

### **Denmark**

- Support E-mail: support@zyxel.dk
- Sales E-mail: sales@zyxel.dk
- Telephone: +45-39-55-07-00
- Fax: +45-39-55-07-07
- Web: www.zyxel.dk
- Regular Mail: ZyXEL Communications A/S, Columbusvej, 2860 Soeborg, Denmark

### **Finland**

- Support E-mail: support@zyxel.fi
- Sales E-mail: sales@zyxel.fi
- Telephone: +358-9-4780-8411
- Fax: +358-9-4780-8448
- Web: www.zyxel.fi
- Regular Mail: ZyXEL Communications Oy, Malminkaari 10, 00700 Helsinki, Finland

### **France**

- E-mail: info@zyxel.fr
- Telephone: +33-4-72-52-97-97
- Fax: +33-4-72-52-19-20
- Web: www.zyxel.fr
- Regular Mail: ZyXEL France, 1 rue des Vergers, Bat. 1 / C, 69760 Limonest, France

### **Germany**

- Support E-mail: support@zyxel.de
- Sales E-mail: sales@zyxel.de
- Telephone: +49-2405-6909-69
- Fax: +49-2405-6909-99
- Web: www.zyxel.de
- Regular Mail: ZyXEL Deutschland GmbH., Adenauerstr. 20/A2 D-52146, Wuerselen, Germany

### **Hungary**

- Support E-mail: support@zyxel.hu
- Sales E-mail: info@zyxel.hu
- Telephone: +36-1-3361649
- Fax: +36-1-3259100
- Web: www.zyxel.hu
- Regular Mail: ZyXEL Hungary, 48, Zoldlomb Str., H-1025, Budapest, Hungary

**India**

- Support E-mail: [support@zyxel.in](mailto:support@zyxel.in)
- Sales E-mail: [sales@zyxel.in](mailto:sales@zyxel.in)
- Telephone: +91-11-30888144 to +91-11-30888153
- Fax: +91-11-30888149, +91-11-26810715
- Web: <http://www.zyxel.in>
- Regular Mail: India - ZyXEL Technology India Pvt Ltd., II-Floor, F2/9 Okhla Phase -1, New Delhi 110020, India

**Japan**

- Support E-mail: [support@zyxel.co.jp](mailto:support@zyxel.co.jp)
- Sales E-mail: [zyp@zyxel.co.jp](mailto:zyp@zyxel.co.jp)
- Telephone: +81-3-6847-3700
- Fax: +81-3-6847-3705
- Web: [www.zyxel.co.jp](http://www.zyxel.co.jp)
- Regular Mail: ZyXEL Japan, 3F, Office T&U, 1-10-10 Higashi-Gotanda, Shinagawa-ku, Tokyo 141-0022, Japan

**Kazakhstan**

- Support: <http://zyxel.kz/support>
- Sales E-mail: [sales@zyxel.kz](mailto:sales@zyxel.kz)
- Telephone: +7-3272-590-698
- Fax: +7-3272-590-689
- Web: [www.zyxel.kz](http://www.zyxel.kz)
- Regular Mail: ZyXEL Kazakhstan, 43 Dostyk Ave., Office 414, Dostyk Business Centre, 050010 Almaty, Republic of Kazakhstan

**Malaysia**

- Support E-mail: [support@zyxel.com.my](mailto:support@zyxel.com.my)
- Sales E-mail: [sales@zyxel.com.my](mailto:sales@zyxel.com.my)
- Telephone: +603-8076-9933
- Fax: +603-8076-9833
- Web: <http://www.zyxel.com.my>
- Regular Mail: ZyXEL Malaysia Sdn Bhd., 1-02 & 1-03, Jalan Kenari 17F, Bandar Puchong Jaya, 47100 Puchong, Selangor Darul Ehsan, Malaysia

**North America**

- Support E-mail: [support@zyxel.com](mailto:support@zyxel.com)
- Support Telephone: +1-800-978-7222
- Sales E-mail: [sales@zyxel.com](mailto:sales@zyxel.com)
- Sales Telephone: +1-714-632-0882
- Fax: +1-714-632-0858
- Web: [www.zyxel.com](http://www.zyxel.com)

- Regular Mail: ZyXEL Communications Inc., 1130 N. Miller St., Anaheim, CA 92806-2001, U.S.A.

### **Norway**

- Support E-mail: [support@zyxel.no](mailto:support@zyxel.no)
- Sales E-mail: [sales@zyxel.no](mailto:sales@zyxel.no)
- Telephone: +47-22-80-61-80
- Fax: +47-22-80-61-81
- Web: [www.zyxel.no](http://www.zyxel.no)
- Regular Mail: ZyXEL Communications A/S, Nils Hansens vei 13, 0667 Oslo, Norway

### **Poland**

- E-mail: [info@pl.zyxel.com](mailto:info@pl.zyxel.com)
- Telephone: +48-22-333 8250
- Fax: +48-22-333 8251
- Web: [www.pl.zyxel.com](http://www.pl.zyxel.com)
- Regular Mail: ZyXEL Communications, ul. Okrzei 1A, 03-715 Warszawa, Poland

### **Russia**

- Support: <http://zyxel.ru/support>
- Sales E-mail: [sales@zyxel.ru](mailto:sales@zyxel.ru)
- Telephone: +7-095-542-89-29
- Fax: +7-095-542-89-25
- Web: [www.zyxel.ru](http://www.zyxel.ru)
- Regular Mail: ZyXEL Russia, Ostrovityanova 37a Str., Moscow 117279, Russia

### **Singapore**

- Support E-mail: [support@zyxel.com.sg](mailto:support@zyxel.com.sg)
- Sales E-mail: [sales@zyxel.com.sg](mailto:sales@zyxel.com.sg)
- Telephone: +65-6899-6678
- Fax: +65-6899-8887
- Web: <http://www.zyxel.com.sg>
- Regular Mail: ZyXEL Singapore Pte Ltd., No. 2 International Business Park, The Strategy #03-28, Singapore 609930

### **Spain**

- Support E-mail: [support@zyxel.es](mailto:support@zyxel.es)
- Sales E-mail: [sales@zyxel.es](mailto:sales@zyxel.es)
- Telephone: +34-902-195-420
- Fax: +34-913-005-345
- Web: [www.zyxel.es](http://www.zyxel.es)
- Regular Mail: ZyXEL Communications, Arte, 21 5ª planta, 28033 Madrid, Spain



**Sweden**

- Support E-mail: support@zyxel.se
- Sales E-mail: sales@zyxel.se
- Telephone: +46-31-744-7700
- Fax: +46-31-744-7701
- Web: www.zyxel.se
- Regular Mail: ZyXEL Communications A/S, Sjöporten 4, 41764 Göteborg, Sweden

**Thailand**

- Support E-mail: support@zyxel.co.th
- Sales E-mail: sales@zyxel.co.th
- Telephone: +662-831-5315
- Fax: +662-831-5395
- Web: http://www.zyxel.co.th
- Regular Mail: ZyXEL Thailand Co., Ltd., 1/1 Moo 2, Ratchaphruk Road, Bangrak-Noi, Muang, Nonthaburi 11000, Thailand.

**Ukraine**

- Support E-mail: support@ua.zyxel.com
- Sales E-mail: sales@ua.zyxel.com
- Telephone: +380-44-247-69-78
- Fax: +380-44-494-49-32
- Web: www.ua.zyxel.com
- Regular Mail: ZyXEL Ukraine, 13, Pimonenko Str., Kiev 04050, Ukraine

**United Kingdom**

- Support E-mail: support@zyxel.co.uk
- Sales E-mail: sales@zyxel.co.uk
- Telephone: +44-1344-303044, 08707-555779 (UK only)
- Fax: +44-1344-303034
- Web: www.zyxel.co.uk
- FTP: ftp.zyxel.co.uk
- Regular Mail: ZyXEL Communications UK Ltd., 11 The Courtyard, Eastern Road, Bracknell, Berkshire RG12 2XB, United Kingdom (UK)



# Index

## Symbols

.NET Framework [23](#)

## A

about screen [51](#)  
Advanced Encryption Standard, see AES [19](#)  
AES [21](#), [43](#)  
AES (Advanced Encryption Standard) [19](#)  
applications [19](#)

## C

cabling type [76](#)  
CE [77](#)  
certifications [77](#), [81](#)  
    notices [82](#)  
    viewing [82](#)  
coaxial cable [20](#)  
configuration screen [45](#)  
connections overview [19](#)  
contact information [85](#)  
copyright [81](#)  
customer support [85](#)

## D

DAK [33](#), [44](#), [45](#)  
DAK (Data Access Password) [21](#)  
Data Access Password, see DAK [21](#)  
dimensions [75](#)  
disclaimer [81](#)

## E

electrical and cable wiring [43](#)

electrical circuit boundaries [43](#)  
encryption [19](#), [43](#), [76](#)  
ETHN LED [63](#)

## F

FCC [77](#)  
FCC interference statement [81](#)  
firmware [46](#)  
frequency band [77](#)

## H

HomePlug AV standard [19](#)  
humidity, operation and storage [75](#)

## I

installation  
    overview [23](#)  
    procedure [23](#)  
    requirements [23](#)  
InstallShield wizard [25](#)  
introduction [19](#)

## L

LED [63](#)  
    ETHN [63](#)  
    LINK [63](#)  
    PWR [63](#)  
LINK LED [63](#)  
local vs. remote adapter [33](#), [45](#)

**M**

MAC address [33, 45](#)  
management  
  multiple networks [22](#)  
  overview [43](#)  
managing the device  
  using the web configurator. See web configurator.  
multiple networks [22](#)

**N**

network example [43](#)  
network information [47](#)  
network ports [76](#)

**P**

Parameter Information Block, see PIB [46](#)  
passwords [33, 44, 45, 46](#)  
  types of [21](#)  
PIB (Parameter Information Block) [46](#)  
plug-and-play [43](#)  
power specification [75](#)  
priority settings [48](#)  
  application type [49](#)  
  priority levels [51](#)  
private network [21](#)  
problems and solutions [63](#)  
product registration [83](#)  
PWR LED [63](#)

**R**

receive rate [47](#)  
registration  
  customer information [26](#)  
  product [83](#)  
  user name [26](#)  
related documentation [3](#)

**S**

safety warnings [6](#)  
screws [78](#)  
security [21, 22, 44](#)  
  passwords [21](#)  
starting the utility [44](#)  
syntax conventions [4](#)

**T**

temperature, operation and storage [75](#)  
trademarks [81](#)  
transfer rates [19](#)  
transmit rate [47](#)  
troubleshooting [63](#)

**U**

utility  
  launching [44](#)

**W**

warranty [83](#)  
  note [83](#)  
web configurator [20](#)