

User Manual

Tektronix

AD007

GPIB-LAN Adapter

071-0245-03

Copyright © Tektronix, Inc. All rights reserved. Licensed software products are owned by Tektronix or its suppliers and are protected by United States copyright laws and international treaty provisions.

Use, duplication, or disclosure by the Government is subject to restrictions as set forth in subparagraph (c)(1)(ii) of the Rights in Technical Data and Computer Software clause at DFARS 252.227-7013, or subparagraphs (c)(1) and (2) of the Commercial Computer Software - Restricted Rights clause at FAR 52.227-19, as applicable.

Tektronix products are covered by U.S. and foreign patents, issued and pending. Information in this publication supercedes that in all previously published material. Specifications and price change privileges reserved.

Tektronix, Inc., P.O. Box 500, Beaverton, OR 97077

TEKTRONIX and TEK are registered trademarks of Tektronix, Inc.

WaveStar is a trademark of Tektronix, Inc.

WARRANTY

Tektronix warrants that the products that it manufactures and sells will be free from defects in materials and workmanship for a period of one (1) year from the date of purchase from an authorized Tektronix distributor. If any such product proves defective during this warranty period, Tektronix, at its option, either will repair the defective product without charge for parts and labor, or will provide a replacement in exchange for the defective product. Batteries are excluded from this warranty.

In order to obtain service under this warranty, Customer must notify Tektronix of the defect before the expiration of the warranty period and make suitable arrangements for the performance of service. Customer shall be responsible for packaging and shipping the defective product to the service center designated by Tektronix, shipping charges prepaid, and with a copy of customer proof of purchase. Tektronix shall pay for the return of the product to Customer if the shipment is to a location within the country in which the Tektronix service center is located. Customer shall be responsible for paying all shipping charges, duties, taxes, and any other charges for products returned to any other locations.

This warranty shall not apply to any defect, failure or damage caused by improper use or improper or inadequate maintenance and care. Tektronix shall not be obligated to furnish service under this warranty a) to repair damage resulting from attempts by personnel other than Tektronix representatives to install, repair or service the product; b) to repair damage resulting from improper use or connection to incompatible equipment; c) to repair any damage or malfunction caused by the use of non-Tektronix supplies; or d) to service a product that has been modified or integrated with other products when the effect of such modification or integration increases the time or difficulty of servicing the product.

THIS WARRANTY IS GIVEN BY TEKTRONIX WITH RESPECT TO THE LISTED PRODUCTS IN LIEU OF ANY OTHER WARRANTIES, EXPRESS OR IMPLIED. TEKTRONIX AND ITS VENDORS DISCLAIM ANY IMPLIED WARRANTIES OF MERCHANTABILITY OR FITNESS FOR A PARTICULAR PURPOSE. TEKTRONIX' RESPONSIBILITY TO REPAIR OR REPLACE DEFECTIVE PRODUCTS IS THE SOLE AND EXCLUSIVE REMEDY PROVIDED TO THE CUSTOMER FOR BREACH OF THIS WARRANTY. TEKTRONIX AND ITS VENDORS WILL NOT BE LIABLE FOR ANY INDIRECT, SPECIAL, INCIDENTAL, OR CONSEQUENTIAL DAMAGES IRRESPECTIVE OF WHETHER TEKTRONIX OR THE VENDOR HAS ADVANCE NOTICE OF THE POSSIBILITY OF SUCH DAMAGES.

Table of Contents

General Safety Summary	vii
Preface	ix
Related Manuals and Information	ix
Contacting Tektronix	x
Getting Started	1
Product Description	1
Features	1
Applications	1
WaveStar for Oscilloscopes	2
Tektronix VISA and VISA Configuration Utility	2
System Requirements	3
Network Protocols	3
Accessories	4
External Features	5
Power On Self Test	5
Quick Setup	7
Setting up a DHCP/BOOTP Server	8
Setting up DNS	9
Installing the Adapter on the Network	10
Contacting the Network Administrator	10
A Note on Configuring the Network	12
Before You Proceed	13
Setup Procedure 1 - Complete Factory Reset, Set DHCP On	14
Setup Procedure 2 - Stand-Alone Operation	15
Setup Procedure 3 - No DHCP Server, Static IP Setup and Operation	18
Setup Procedure 4 - DHCP Server, Dynamic IP Setup or Operation	21
Setup Procedure 5 - DHCP Server and Static IP	25
Accessing the Web Page Interface	26
Password Protection	26
Connecting the GPIB	27
Installation Options	29

Installing TekVISA Software	29
Configuring TekVISA Resources	30
Verifying Network Access to the Adapter	32
Web Browser	32
Network Ping	32
Operating Basics	33
Home	34
Adapter Information	35
Adapter Password	35
Reboot Adapter	35
Network Setup	36
Host Configuration	36
Networking	36
Name Service	37
Time Protocol	37
GPIOB Communications	38
GPIOB Devices	38
Talk/Listen	38
Network Connections	38
Printer Setup	39
Printer Setup	39
Print Status	40
Statistics	41
Network Statistics	41
GPIOB Statistics	41
System Log	41
Reset	41
Help	42
Support	42
Reference	43
Interpreting the Status Indicators	44
Power On	45
Normal Operation	46
Confirming a Hardware/Firmware Failure	47
Resetting the Adapter	48
Bypass DHCP/BOOTP and Reset to Last Configuration ..	49
Reset the Password and Read the IP Address	50
Reset to the Factory Defaults	51

Appendix A: Specifications	55
Appendix B: Power Cord Options	59
Appendix C: Network Protocols	61
Appendix D: Troubleshooting	63
Power On and Status	63
Network and Print Configuration	65
GPIB	67
Glossary	69
Index	73

List of Figures

Figure 1: AD007 GPIB-LAN Adapter, RJ-45 cable, and power supply	4
Figure 2: External features	5
Figure 3: Location of Status Indicators	6
Figure 4: Network information card	10
Figure 5: Ethernet hardware address	11
Figure 6: Decoding the adapter IP address	23
Figure 7: Typical GPIB Network Configuration	27
Figure 8: Connecting to the GPIB	28
Figure 9: AD007 GPIB-LAN Adapter home page	34
Figure 10: Status Indicators	44
Figure 11: RESET button	48

List of Tables

Table 1: Power on Self Test	6
Table 2: AD007 status indicators for power on	45
Table 3: AD007 status indicators during normal operation	46
Table 4: Using the RESET button	49
Table 5: Binary-to-decimal conversion chart for IP address	50
Table 6: Factory default settings	52
Table 7: General specifications	55
Table 8: AD007 certifications and compliances	55
Table 9: Power supply certifications and compliances	57
Table 10: Power cord identification	59
Table 11: IP and Ethernet protocols	61
Table 12: Power on and status problems	63
Table 13: Network and print problems	65
Table 14: GPIB problems	67

General Safety Summary

Review the following safety precautions to avoid injury and prevent damage to this product or any products connected to it. To avoid potential hazards, use this product only as specified.

Only qualified personnel should perform service procedures.

To Avoid Fire or Personal Injury

Observe All Terminal Ratings. To avoid fire or shock hazard, observe all ratings and markings on the product. Consult the product manual for further ratings information before making connections to the product.

Use Proper AC Adapter. Use only the AC adapter specified for this product.

Do Not Operate Without Covers. Do not operate this product with covers or panels removed.

Avoid Exposed Circuitry. Do not touch exposed connections and components when power is present.

Do Not Operate With Suspected Failures. If you suspect there is damage to this product, have it inspected by qualified service personnel.

Do Not Operate in Wet/Damp Conditions.

Do Not Operate in an Explosive Atmosphere.

Keep Product Surfaces Clean and Dry.

Safety Terms and Symbols

Terms in This Manual. These terms may appear in this manual:



WARNING. *Warning statements identify conditions or practices that could result in injury or loss of life.*



CAUTION. *Caution statements identify conditions or practices that could result in damage to this product or other property.*

Terms on the Product. These terms may appear on the product:

DANGER indicates an injury hazard immediately accessible as you read the marking.

WARNING indicates an injury hazard not immediately accessible as you read the marking.

CAUTION indicates a hazard to property including the product.

Symbols on the Product. These symbols may appear on the product:



CAUTION
Refer to Manual



Double
Insulated



Protective Ground
(Earth) Terminal



Not suitable for
connection to
the public telecom-
munications network

Preface

This manual contains information about installing and configuring the AD007 GPIB-LAN Adapter. This manual is also in Acrobat format on the CD-ROM disc.

- *Getting Started* describes the AD007 adapter and how to install the adapter on 10/100Base-T Ethernet.
- *Operating Basics* contains information on how to use the web pages in the adapter to monitor, reconfigure, or test the flow of communications through the adapter, and how to set up a network printer.
- *Reference* provides special diagnostic and setup procedures.
- *Appendices* contains specifications, applicable network protocols, and troubleshooting information.
- A *Glossary* and *Index* appear at the end of the manual.

Related Manuals and Information

Refer to the following manuals for information regarding related products, manuals, and programming specifications.

- The *Read This First* guide (071-0246-XX) contains information to give to your network administrator for setting up the adapter on the network.
- The *WaveStar User Manual* (071-0220-XX) is also in Acrobat PDF format on the CD-ROM disc.

General information and specifications for Virtual Instrument Software Architecture (VISA) is available from the web site of the VXIplug&play Systems Alliance at:

<http://www.vxipnp.org>

Contacting Tektronix

Phone	1-800-833-9200*
Address	Tektronix, Inc. Department or name (if known) 14200 SW Karl Braun Drive P.O. Box 500 Beaverton, OR 97077 USA
Web site	www.tektronix.com
Sales support	1-800-833-9200, select option 1*
Service support	1-800-833-9200, select option 2*
Technical support	Email: techsupport@tektronix.com 1-800-833-9200, select option 3* 6:00 a.m. - 5:00 p.m. Pacific time

* **This phone number is toll free in North America. After office hours, please leave a voice mail message. Outside North America, contact a Tektronix sales office or distributor; see the Tektronix web site for a list of offices.**

Getting Started

This section contains an overview of the AD007 GPIB-LAN Adapter and provides instructions on how to install the adapter and the accompanying software.

Product Description

The AD007 adapter allows GPIB devices to talk or listen to networked computers and peripherals through a 10/100BaseT Ethernet connection.

Features

- GPIB (IEEE 488.2) and 10/100BaseT Ethernet (IEEE 802.3) compatible
- Easy setup with DHCP/BOOTP server
- LED status indicators for power, LAN, and GPIB connections
- Web page interface for configuration and statistics
- Virtual Instrument Software Architecture (TekVISA) software with language interface libraries for programmers using Microsoft Visual Basic or Microsoft Visual C/C++
- Configuration utility for setting up additional VISA resources
- Software installation allowed on any number of PCs
- Free firmware updates over the Internet with the AD007 Update Utility

Applications

- Print directly from GPIB devices to a network printer
- Control up to 14 GPIB devices over an Ethernet connection
- Capture waveforms with optional WaveStar for Oscilloscopes software from Tektronix

WaveStar for Oscilloscopes

The AD007 adapter together with the optional WaveStar for Oscilloscopes software provides a complete solution for users with Tektronix TDS Series oscilloscopes with GPIB interfaces. The software provides a powerful, easy-to-use interface for controlling instruments, displaying data and waveforms, and sending print jobs to any local or network printer. See *System Requirements* on page 3 for information on what systems can run WaveStar for Oscilloscopes.

A free 30-day demo of WaveStar for Oscilloscopes is included on the Tektronix Software Solutions installation CD.

Tektronix VISA and VISA Configuration Utility

The Virtual Instrument Software Architecture (VISA) standard, developed by the VXIplug&play Systems Alliance, provides a common Input/Output (I/O) library for software developers so that software from different vendors can run on the same platform.

Except for direct GPIB-to-network printing, all applications that communicate over the network to the AD007 adapter must use the Tektronix version of VISA (TekVISA). See the AD007 section in the *Tektronix Software Solutions Installation manual* (Tektronix part number 071-1140-01) for instructions on loading TekVISA on your PC.

The TekVISA software includes a utility to help you configure the Virtual Instrument Software Architecture (VISA) resources. The TekVISA Resource Manager Configuration utility allows you to add or remove remote hosts (such as one or more AD007 adapters). For more information about using the configuration utility, see page 30.

System Requirements

See the AD007 section in the *Tektronix Software Solutions Installation manual* (Tektronix part number 071-1140-01) for system requirements.

Network Protocols

Firmware in the AD007 adapter supports the following network protocols:

- BOOTP
- DHCP
- LPD
- DNS
- HTTP
- FTP
- Time Protocol

Accessories

Figure 1 shows the AD007 GPIB-LAN Adapter, RJ-45 UTP cable, and universal power supply (100 - 240 VAC). Use the part numbers when ordering replacements.

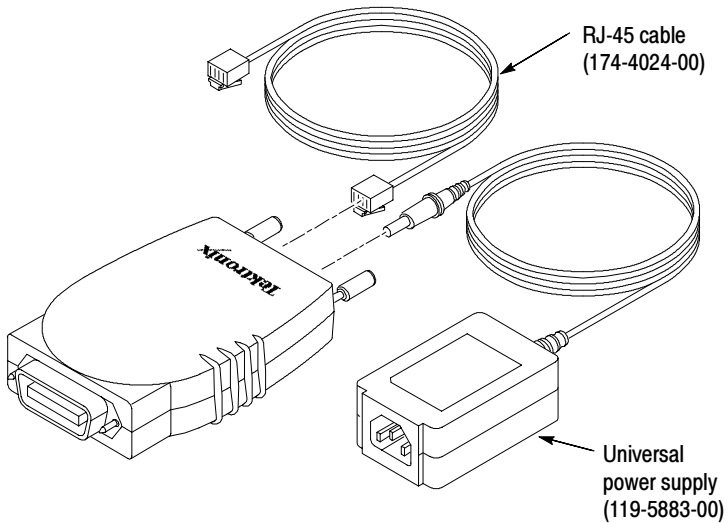

Figure 1: AD007 GPIB-LAN Adapter, RJ-45 cable, and power supply

Also included (but not shown) are the following accessories:

- Power cord (varies with power cord option, see Table 10 on page 59)
- GPIB connector hardware (129-1502-00)
- CD-ROM disc
- *AD007 Read This First* instructions
- *AD007 User Manual* (071-0245-XX)
- Registration form and mailing envelopes

External Features

Figure 2 shows the external features of the AD007 GPIB-LAN Adapter

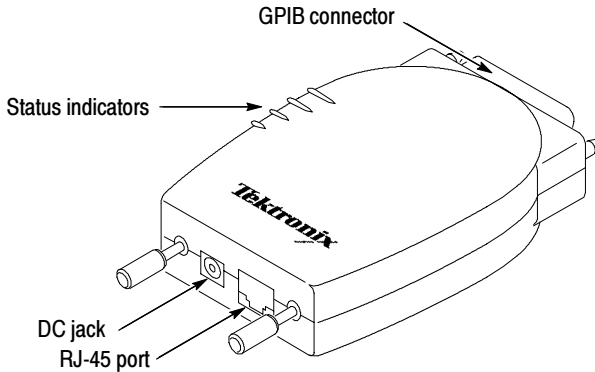

Figure 2: External features

Power On Self Test

NOTE. Do not connect the adapter to the network or GPIB at this time.

1. Connect the power supply to the DC jack of the AD007 adapter.
2. Plug the power supply into a 100 to 240 VAC ($\pm 10\%$) power source with the appropriate line cord.
3. During the 30-second power on routine which follows, the status indicators blink amber to indicate a self test in progress.

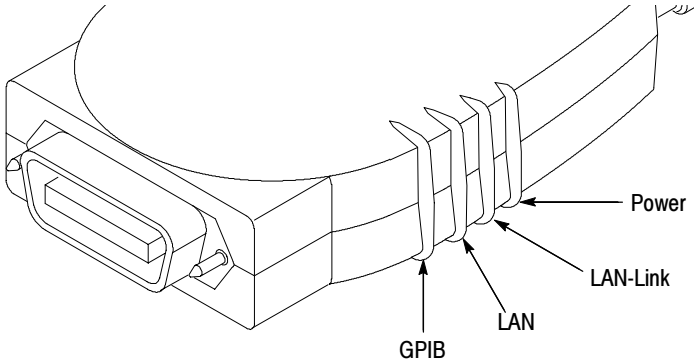

Figure 3: Location of Status Indicators

4. As the self test runs, the states shown in Table 1 apply.

Table 1: Power on Self Test

GPIB	LAN	LAN-Link	POWER
----- (30 second self-test, indicators blink amber) -----			
----- (Self test pass, indicators momentarily blink green) -----			
Off	Off	Red RJ-45 cable not connected No IP address loaded	Green

5. If the adapter indicates any other conditions, refer to Table 2 on page 45 for a complete list of the status indicators.
6. To repeat the power on self test, simply unplug the DC connection, wait a couple of seconds, and reconnect.

Quick Setup

If the following conditions apply, you can go directly to the appropriate setup procedure to install the adapter:

1. You have followed the instructions in the *Read This First* guide and communicated the Ethernet hardware address of your adapter to your network administrator.
2. Your network administrator has returned the card to you with an IP address. (This means that the network administrator has prepared the network by assigning a static IP address that is mapped to the Ethernet Hardware address of the adapter.)

Note the information from the Network Information Card and proceed as follows:

- If there is a DHCP/BOOTP server that is configured to allocate a static IP address, go to page 25.
- If the DHCP/BOOTP server only allocates a dynamic IP address (whether or not the administrator has assigned a fixed IP address), go to page 21.
- If there is no DHCP/BOOTP server and the network administrator has assigned a static IP address to the adapter, go to page 18.
- If you want to set up the adapter on a stand alone PC, go to page 15.
- If the adapter was previously configured on another network and you wish to reset it to factory defaults and turn DHCP on, go to page 14.
- If you wish to know more about DHCP/BOOTP servers and installing the adapter on a network, continue reading on to the next section.

Setting up a DHCP/BOOTP Server

The purpose of a DHCP (Dynamic Host Configuration Protocol) or BOOTP (Boot Protocol) server is to issue IP addresses to devices or clients on the network that request them. Once the IP addresses are properly assigned, the network servers can then allow other communications to take place.

A DHCP or BOOTP server can also provide all the other network parameters to the AD007 adapter including time servers, DNS, gateway, netmask, and so on.

When the server receives a DHCP/BOOTP request from the AD007 adapter, it recognizes the hardware Ethernet address of the adapter, maps the Ethernet address to an IP address, and then offers this IP address back to the adapter.

The factory default settings of the AD007 Adapter enable the DHCP/BOOTP request. This greatly simplifies the initial operation, but requires some network configuration.

The process for configuring the DHCP or BOOTP server varies from system to system. Adding the AD007 to the server's list of clients is usually just a matter of making an entry in a file or using a manager utility.

There are two ways that the server can be configured to give the AD007 adapter an IP address:

- **Static.** The server assigns the same IP address each time the adapter makes a DHCP/BOOTP request
- **Dynamic.** The server offers a different IP address each time the adapter makes a DHCP/BOOTP request

If possible, use the static configuration. This makes it easier to access the AD007 adapter with a known IP address. If DNS is set up, however, you can access the AD007 by using the host name instead and it is not as important to have a static IP address.

In addition to the IP address, the server can offer the AD007 adapter additional network information. The additional information is not necessary for simple communication with the AD007, but may permit automatic configuration of network settings that would otherwise have to be manually configured. For a list of these network settings, see *Network Setup* on page 36.

To find out how to configure your server for DHCP, contact your network administrator or consult the server manual.

Setting up DNS

DNS (Domain Name Service) allows you to access your AD007 adapter via a host name rather than an IP address. It is not necessary to use DNS, but a host name is more meaningful and easier to remember than an IP address. DNS simply associates a host name to an IP address. Once this association is made, DNS converts the requested host name to an IP address and forwards the request to the device at the IP address. This process is invisible to the end user.

Like DHCP servers, there are many different DNS servers and configuring each type is unique. Contact your network administrator to set up this service.

Installing the Adapter on the Network

Use the procedures in this section to install the AD007 GPIB-LAN Adapter on a network.

Contacting the Network Administrator

Please contact your local network administrator or network services before connecting the AD007 adapter. For your convenience, use the network information card included in the *Read This First* guide, or make two photocopies of the form shown in Figure 4.

Network Information Card AD007 GPIB-LAN Adapter	
Ethernet Hardware Address _____ : _____ : _____ : _____ : _____ : _____ (User: copy address from the label on the back of the AD007 adapter)	
Internet (IP) Address _____ . _____ . _____ . _____ Host Name _____ (Network Administrator: for ease of set up, a static IP address is preferred)	
Does network support DHCP or BOOTP? Yes <input type="checkbox"/> No <input type="checkbox"/>	
If no, please note: Subnet mask _____ . _____ . _____ . _____ Router address _____ . _____ . _____ . _____ (Enter these numbers on network setup page of the adapter, refer to user manual)	
Network drop (subnet) number and/or physical location _____ (assigned by network technician)	
Comments _____ _____ _____ (Network Administrator: Keep one copy and give one copy to the user.)	

Figure 4: Network information card

To contact your network administrator or network services, do these steps:

1. Find the Ethernet hardware address on the back of the AD007 adapter (Figure 5) and copy it onto the card. Each AD007 adapter has a unique Ethernet hardware address.

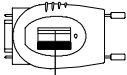
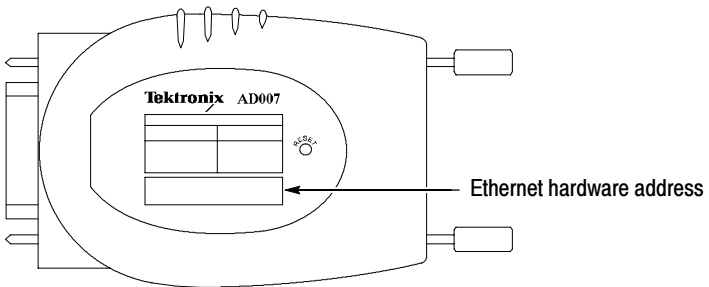

Figure 5: Ethernet hardware address

2. Give both copies of the card to the network administrator who will assign an IP Address and fill out any other necessary information.
3. For ease of setup, request that the Network Administrator assign a *static* IP address. The Ethernet hardware address should be mapped to this static IP address. If there is a DHCP/BOOTP server, it should serve the same (static) IP address each time it is requested.
4. If for some reason you cannot get a static IP address assigned, use a *dynamic* IP address that is allocated by the DHCP/BOOTP server. However, note that additional setup time is required if the server allocates a different IP address to the adapter and you do not have DNS.

The network administrator should retain one copy of the card and the user should retain the other.

A Note on Configuring the Network

To establish communications with the AD007 GPIB-LAN Adapter over the Ethernet, the network administrator must perform the following tasks:

- Identify the Ethernet hardware address of the adapter
- Assign an IP address, subnet mask, default router for the adapter on the network
- Configure the DHCP or BOOTP server

NOTE. *A network technician should determine the network subnet that the AD007 adapter connects to. (This is the connection point for the RJ-45 cable.) It is not unusual for several drops at a particular location to be on different network subnets, so it is important to have the one that is designated for the adapter.*

At power on, the AD007 adapter performs a self test and initiates DHCP/BOOTP. The DHCP/BOOTP server then communicates with the AD007 adapter to give it the proper network settings. For more information about setting up a DHCP/BOOTP server, see page 8.

If there is no DHCP/BOOTP server, you can use the reset button to bypass the DHCP/BOOTP request and manually set the network parameters.

For more detailed information about the applicable network protocols, see *Appendix C: Network Protocols* on page 61.

Before You Proceed

Before you proceed with the rest of the installation, make sure you can answer yes to the following questions:

- Does the network administrator have the Ethernet Hardware address of the AD007 adapter?
- Do you have the IP address and/or host name that the network administrator has assigned to the AD007 adapter?
- Do you have a DHCP/BOOTP server that has been set up to serve a static IP address -or- do you have the IP address, subnet mask, and default router address that the network administrator has assigned for manually configuring the AD007 adapter?
- Do you know where the assigned network connection is?

NOTE. *If you answered “no” to any of the previous questions, contact your local network administrator or network services before continuing.*

Setup Procedure 1 - Complete Factory Reset, Set DHCP On

If the following conditions are true, you may want to completely reset the adapter to the factory default settings.

- The adapter has been used before and is configured with unknown settings.
- DHCP is off and the adapter does not request an IP address from the network.
- You are *not* able to access the web pages of the adapter because the adapter is configured with unknown settings.
- You want to turn DHCP on.

To reset to the factory default settings (and turn DHCP on), do these steps:

1. Power the AD007 adapter off.
2. Use a small tool or end of a paper clip to push in and hold the reset button.
3. Power on the AD007 adapter and hold the reset button in until all status indicators go to a steady amber (approximately 30 seconds), then release the button. The AD007 adapter automatically reboots with the factory defaults.
4. For a complete list of the factory default settings, see Table 6 on page 52.

Setup Procedure 2 - Stand-Alone Operation

If the following conditions are true, you can manually set up the adapter to work with a stand-alone PC.

- You want to set up the adapter apart from a network.
- The stand-alone PC does not have the appropriate settings and connections to access the web pages on the adapter.

NOTE. Stand-alone operation requires a PC 10/100BaseT Ethernet card and an Ethernet hub, crossover cable, or crossover adapter. (The crossover cable or adapter is specifically designed for connecting two nodes without a hub.)

To set the IP address in the adapter, do these steps:

1. Disconnect any cable that is currently connected to the adapter.
2. Power on the adapter and wait for the self test to complete. After the self test is complete, the following states apply:

GPIB	LAN	LAN-Link	POWER
----- (30 second self-test, lights blink amber) -----			
----- (Self test pass, indicators momentarily blink green) -----			
Off	Off	Red	Green

3. Locate the reset button on the bottom of the adapter. (For the location of the reset button, see Figure 11 on page 48.)
4. Using a small tool or end of a paper clip, momentarily push in the reset button. This action loads the last known IP address. (For a new adapter, the last known address is the factory default IP address of 192.168.1.1.)

5. When the LAN-Link indicator turns from red to off, the AD007 adapter has successfully loaded the IP address:

GPIB	LAN	LAN-Link	POWER
Off	Off	Off	Green

NOTE. *If your Internet web browser is configured to use the dialup adapter, go into the Internet configuration dialog and change the browser to use the local network. For more information, refer to the documentation for your particular system.*

6. In Windows, open the Network Properties window by right-clicking on the Network icon in the Control Panel. (In Windows NT, select the Protocols tab.)
7. If TCP/IP is not listed as one of the protocols, you must install it from the Windows installation CD-ROM disc.
8. Highlight the TCP/IP and click on Properties. This opens the TCP/IP properties dialog box.
9. Click on all the tabs and write down all the settings. This allows you to restore them later if necessary.
10. Set the IP address of the PC to work with the currently configured settings of the adapter, or use the following settings that will work with the factory default settings of the AD007 adapter. (You may have to click on Specify an IP address.)
 - a. Assign the PC an IP address with the first three numbers that are the same as the current AD007 IP address. (For example, the IP address 192.168.1.2 is acceptable if you are using the factory default 192.168.1.1 address of the adapter).
 - b. Assign the numbers for the subnet mask. (For example, assign the subnet mask 255.255.255.0 if you are using the factory default settings).

- c. If you are using the factory default settings to access the adapter, the PC settings are now as follows:

IP address: 192.168.1.2

Subnet Mask: 255.255.255.0

11. For Windows, while you have this box open, click on the DNS configuration tab and click on Disable DNS.
12. Click on the WINS tab and disable WINS.
13. Reboot the PC for these changes to take affect.

NOTE. *After you change the network settings on your PC, you will no longer have access to your network files until you restore the network settings on your PC. Remember to reboot your PC for any changed settings to take affect.*

14. Connect the RJ-45 connector of the AD007 adapter to the Ethernet port of the PC with a crossover cable or use an Ethernet hub.
15. The LAN-Link light should now turn from off to green:

GPIB	LAN	LAN-Link	POWER
Off	Off	Green	Green

16. Using a web browser, enter the adapter's currently configured IP address. For example, if your current configured IP address is 192.168.1.1, you would enter the following:

`http://192.168.1.1`

17. If you are prompted for a user name and password, you can ignore the user name and enter the password. The factory default password is ad007 (lowercase a, lowercase d, zero, zero, 7).
18. On the network configuration web page of the adapter, enter the correct IP address, subnet mask, and router (gateway) address.

19. Turn DHCP off or on as necessary for the new configuration.
20. Click on Submit. The new IP address is now in nonvolatile memory.
21. Power off the adapter.
22. Connect the adapter to the proper network drop or Ethernet port.
23. Power on the adapter to boot up the adapter with the new settings.

Setup Procedure 3 - No DHCP Server, Static IP Setup and Operation

If the following conditions are true, you must manually set up the adapter on the network with a static IP address.

- The network administrator verifies that you *do not* have a DHCP/BOOTP server on your network.
- The network administrator has prepared the network for the adapter by assigning a static IP address and mapping it to the Ethernet Hardware address of the adapter.

To set the assigned IP address in the adapter, do these steps:

1. Connect one end of the RJ-45 cable to the RJ-45 connector on the back of the AD007 adapter. Push the connector in until it clicks.
2. Connect the other end of the RJ-45 cable to the network drop assigned by the network technician.
3. Power on the adapter. The following states apply:

GPIB	LAN	LAN-Link	POWER
----- (30 second self-test, lights blink amber) -----			
----- (Self test pass, indicators momentarily blink green) -----			
Off	Green/Amber/Off	Amber	Green

Status: The adapter is requesting an IP address from the network, but is not receiving one because there is no DHCP server.

4. Locate the reset button on the bottom of the adapter. (For the location of the reset button, see Figure 11 on page 48.)
5. Using a small tool or end of a paper clip, momentarily push in the reset button. This action bypasses the DHCP address request and loads the last known IP address. (For a new adapter, the last known address is the factory default IP address of 192.168.1.1.)
6. When the LAN-Link indicator turns from amber to green, the AD007 adapter has successfully loaded the IP address.

NOTE. *A static setup on the network requires that you are connected through an Ethernet Hub to the same sub-network as the adapter.*

7. Connect the RJ-45 adapter to the proper network outlet (sub-network).

NOTE. *If your Internet web browser is configured to use the dialup adapter, go into the Internet configuration dialog and change the browser to use the local network. For more information, refer to the documentation for your particular system.*

8. In Windows, open the Network Properties window by right-clicking on the Network icon in the Control Panel. (In Windows NT, select the Protocols tab.)
9. If TCP/IP is not listed as one of the protocols, you must install it from the Windows OS CD-ROM disc.
10. Highlight the TCP/IP and click on Properties. This opens the TCP/IP properties dialog box.
11. Click on all the tabs and write down all the settings. This allows you to restore them later.
12. Set the IP address of the PC to work with the currently configured settings of the adapter, or use the following settings that will work with the factory default settings of the AD007 adapter. (You may have to click on Specify an IP address.)

- a. Assign the PC an IP address with the first three numbers that are the same as the current AD007 IP address. (For example, the IP address 192.168.1.2 is acceptable if you are using the factory default 192.168.1.1 address of the adapter).
- b. Assign the numbers for the subnet mask. (For example, assign the subnet mask 255.255.255.0 if you are using the factory default settings).
- c. If you are using the factory default settings to access the adapter, the PC settings are now as follows:

IP address: 192.168.1.2

Subnet Mask: 255.255.255.0

13. For Windows, while you have this box open, click on the DNS configuration tab and click on Disable DNS.
14. Click on the WINS tab and disable WINS.
15. Reboot the PC for these changes to take affect.

NOTE. *After you change the network settings on your PC, you will no longer have access to your network files until you restore the network settings on your PC. Remember to reboot your PC for any changed settings to take affect.*

16. Using a web browser, enter the adapter's currently configured IP address. For example, if your adapter's IP address is configured to 192.168.1.1, you would enter the following:

`http://192.168.1.1`

17. If you are prompted for a user name and password, you can ignore the user name and enter the password. The factory default password is ad007 (lowercase a, lowercase d, zero, zero, 7).
18. On the network configuration web page of the adapter, enter the correct IP address, subnet mask, and router (gateway) address.

19. Click on Submit. The new IP address is now in nonvolatile memory.
20. Power off the adapter.
21. Power on the adapter to boot up the adapter with the new settings.
22. Restore the previous network settings on your PC and reboot your PC.
23. To verify that the network installation is complete, perform the procedure to access the web page interface on page 26.
24. After you have verified access to the web pages, continue with the rest of the procedures in the *Getting Started* section.

Setup Procedure 4 - DHCP Server, Dynamic IP Setup or Operation

If the following conditions are true, the network has automatically configured the network settings of your adapter, but you must determine the IP address allocated by the server in order to use or manually reconfigure the adapter.

- The network administrator verifies that you have a DHCP/BOOTP server on your network.
- The network administrator has indicated that the DHCP/BOOTP server is configured to allocate a dynamic IP address to the Ethernet hardware address of your adapter.
- The network administrator has *not* assigned you a static IP address - or - you must determine the dynamically allocated IP address in order to access and set the static IP address of your adapter.
- One end of the RJ-45 cable is connected to the RJ-45 connector on the back of the AD007 adapter. Push the connector in until it clicks.
- The other end of the RJ-45 cable is connected to the network drop assigned by the network technician.
- After the 30-second power on routine, the following states apply.

GPIB	LAN	LAN-Link	POWER
----- (30 second self-test, lights blink amber) -----			
----- (Self test pass, indicators momentarily blink green) -----			
Off	Green/Amber/Off	Green (unknown IP address acquired)	Green

To read and decode the IP address, do these steps:

1. Photocopy the chart on page 23. Get a pencil and prepare to fill out the chart.
2. Locate the reset button on the bottom of the adapter. (For the location of the reset button, see Figure 11 on page 48.)
3. Make sure status indicators are in the states listed above.
4. Using a small tool or end of a paper clip, momentarily push in the reset button. This initiates the adapter to display the IP address.
5. Mark a 1 for each red indicator in the appropriate spaces (leave spaces for green indicators blank). When the indicators are all amber, the value is a decimal point separator. Leading zeros are ignored in each field.
6. Repeat the test as necessary by pressing the reset button again.
7. After you have written the binary values down, convert the binary values to decimal and write the decimal values in the spaces provided.

- 9.** Open the location of the AD007 adapter using the IP address that you decoded:
`http://AD007 IP address/`
- 10.** Go to the Network Setup page
- 11.** If you are prompted for a user name and password, you can ignore the user name and enter the password. The factory default password is ad007 (lowercase a, lowercase d, zero, zero, 7).
- 12.** Enter the static IP address assigned by your network administrator.
- 13.** Set DHCP off.
- 14.** Click on Submit.
- 15.** Reboot your adapter by disconnecting and reconnecting the power, or go to the Home page and click on Reboot.
- 16.** To verify that the network installation is complete, perform the procedure to access the web page interface on page 26.
- 17.** After you have verified access to the web pages, continue on with the rest of the procedures in the *Getting Started* section.

Setup Procedure 5 - DHCP Server and Static IP

If the following conditions are true, the network has automatically configured the network settings of your adapter.

- The network administrator verifies that you have a DHCP/BOOTP server on your network.
- The network administrator has assigned you a static IP address.
- The network administrator has indicated that the DHCP/BOOTP server is configured to serve the static IP address to the Ethernet hardware address of your adapter.
- One end of the RJ-45 cable is connected to the RJ-45 connector on the back of the AD007 adapter. Push the connector in until it clicks.
- The other end of the RJ-45 cable is connected to the network drop assigned by the network technician.
- After the 30-second power on routine, the following states apply.

GPIB	LAN	LAN-Link	POWER
----- (30 second self-test, lights blink amber) -----			
----- (Self test pass, indicators momentarily blink green) -----			
Off	Green/Amber/Off	Green (IP address is known)	Green

- You are able to access the web pages of the adapter using the IP address assigned by your network administrator.

(The procedure to access the web page interface and continue on with the rest of the installation is on page 26.)

Accessing the Web Page Interface

The AD007 adapter has a built-in web server with online forms that allow you to test the network connection, configure a printer, and make various network or GPIB settings. Use the following procedure to access the web pages:

1. Start the web browser on your computer.
2. Open the location of the AD007 adapter assigned by your network administrator:
`http://AD007 host name or IP address/`
3. Use the settings on your browser to save or bookmark this location.

If you successfully access the Home web page, the network portion of the installation is now complete. For more information about the web page interface, see *Operating Basics* on page 33.

If you only access a diagnostic web page, there is a problem with the firmware in the adapter. See the AD007 section in the *Tektronix Software Solutions Installation manual* (Tektronix part number 071-1140-01) for instructions on updating the AD007 firmware.

NOTE. *If you cannot access any web page of the adapter, contact your network administrator or network technician.*

Do not change any parameters on the Network Setup without contacting your network administrator. A password protection utility is available on the Home page to protect these settings. See page 35.

Password Protection

The settings on the web pages are password protected. If you try to make changes to the settings, the browser will prompt you for a user name and password. By default, the user name is ignored and the password is **ad007** (lowercase a, lowercase d, zero, zero, 7). To set a new password, see page 35. To reset the password to the default setting, see *Resetting the Adapter* on page 48.

Connecting the GPIB

Observe these rules when you set up the AD007 GPIB-LAN Adapter with a GPIB system:

- Connect only one AD007 GPIB-LAN Adapter on a given GPIB.
- Each device on the bus needs a unique device address. No two devices can share the same device address.
- Do not connect more than 15 devices to any one bus.
- Connect one device for every 2 m (6 ft) of cable used.
- Do not use more than 20 m (65 ft) of cable to connect devices to a bus.
- Turn on at least two-thirds of the devices on the GPIB system while you use the system.
- Configure the devices on the system as shown in Figure 7. Do not use loop or parallel configurations.

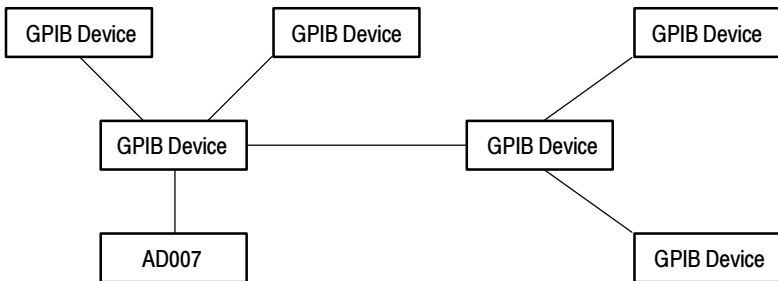

Figure 7: Typical GPIB Network Configuration

To connect the AD007 GPIB-LAN Adapter to the GPIB, do these steps:

1. Connect the GPIB port of the adapter to the GPIB port(s) or connector(s) for the instrument(s) that you wish to control. If necessary, use the GPIB connector hardware provided. (See Figure 8.)

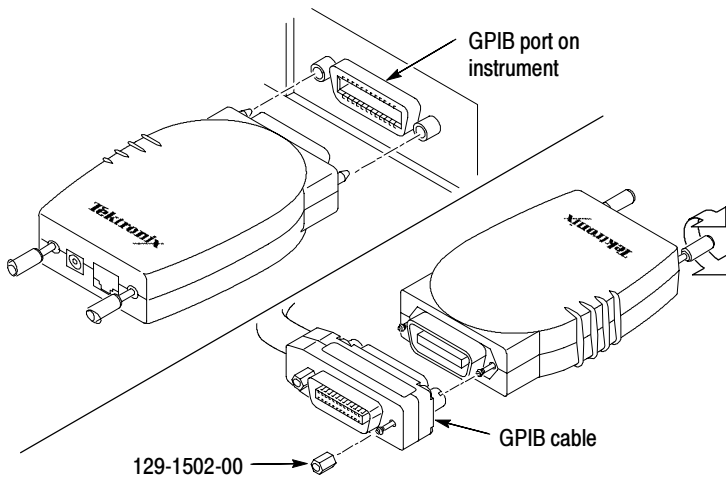

Figure 8: Connecting to the GPIB

2. Turn on all devices connected to the GPIB. Wait for all power on routines to finish.
3. Access the web page on the AD007 adapter.
4. Click GPIB Communications.
5. Click Poll to refresh the list of active talk/listen instruments.
6. Verify that the devices on the bus are listed.
7. If you change which devices are active on the bus or device parameters, click Poll to rediscover the active addresses on the GPIB.

8. Another way to test the connection is to enter the query `*idn?` or similar query in the GPIB Communications web page and click Send. The Response field should indicate an appropriate response.

Installation Options

After the AD007 GPIB-LAN Adapter is set up on the network and connected to the GPIB you may proceed with either one, or both, of the following installation options:

- Enable direct GPIB-to-network printing. Proceed to *Operating Basics* section that begins on page 33 and access the Printer Setup web page.
- Enable full GPIB-LAN communication. Proceed to the next section, *Installing TekVISA Software*.

Installing TekVISA Software

Except for direct GPIB-to-network printing, all applications that communicate over the network to the AD007 adapter must use the Tektronix version of VISA (TekVISA). See the AD007 section in the *Tektronix Software Solutions Installation manual* (Tektronix part number 071-1140-01) for instructions on installing the TekVISA software. You can install TekVISA on any number of PCs.

NOTE. *If you have installed Tektronix WaveStar for Oscilloscopes, then you do not need to install TekVISA separately; TekVISA is automatically installed when WaveStar for Oscilloscopes is installed.*

NOTE. *Do not install the TekVISA software if you do not want to overwrite your present VISA. The program detects any previous versions of VISA and overwrites them with TekVISA.*

Configuring TekVISA Resources

Run the TekVISA Resource Manager Configuration program to configure TekVISA preferences, locate, and add instruments.

1. Right-mouse click on the yellow VISA icon in the Taskbar notification area to display a pop-up menu. This icon was installed as part of the TekVISA installation. If this icon is not present, select **Start > Programs > TekVISA > TekVISA Configuration** and wait for the icon to appear in the Taskbar notification area.
2. Select **Preferences** to display the TekVISA Resource Manager Preferences dialog. Use the dialog to specify which communication ports and how often you want TekVISA to search for instruments. The search preferences have different settings depending on whether TekVISA is installed on a Windows-based oscilloscope or a PC. Pressing the Default Preferences button on the Preferences dialog will set the configuration utility to automatically search for instruments on RS-232, LAN and GPIB ports.

Once the appropriate selections are made on this dialog, select **OK** to close the Preferences dialog.

3. From the yellow TekVISA icon pop-up menu, select **Refresh** to refresh connected instrument information.
4. From the yellow TekVISA icon pop-up menu, select **Configure...** to display the TekVISA Resource Manager Configuration dialog. Wait until the message **Status: Ready** is displayed in the lower left corner.
5. Check that the instrument you want to communicate with is listed in the TekVISA Resources field. If the LAN-connected instrument with which you want to communicate is not listed, do the following steps to add an instrument to the Remote Host List:

NOTE. *If you are attempting to communicate with a Tektronix Windows-based oscilloscope, make sure the VXI-11 server is running on the oscilloscope before doing the following procedure.*

- a. Select the **Add** button in the Remote Host List area. This opens the Add Remote Host dialog.
- b. Enter the IP address or location name (some instruments use the VXI-11 server to define a name) in the Host Name field.
- c. Select **OK**. The dialog closes, returns to the main TekVISA window, and adds the IP address or location name to the Remote Host field.
- d. Select the **Find** button. The utility attempts to locate the specified remote host address and lists it in the TekVISA Resources field. It may take the program a few moments to locate instruments, depending on network speed and load.
- e. Repeat steps **a** through **d** to continue adding instrument addresses.
- f. Select the **X** button in the upper-right corner to save your changes and exit the TekVISA Resource Manager Configuration utility program.

NOTE. *The TekVISA Resource Manager Configuration program must be able to locate and register an instrument before you can set up communications with connected instruments.*

*If the TekVISA Configuration utility cannot locate an instrument, verify that the AD007 is correctly configured: Refer to Appendix D: Troubleshooting, and work with your system administrator to resolve the problem. Also see the TekVISA Release Notes (**Start > Programs > TekVISA > Release Notes**) and the online help file (**Start > Programs > TekVISA > TekVISA Resource Manager Help**) for TekVISA-specific information.*

Verifying Network Access to the Adapter

Once the AD007 adapter is configured on the network or configured in a stand-alone setup, you should be able to browse to, or ping, the IP address of the adapter.

Web Browser

Using a web browser, go to the currently configured IP address of the adapter (i.e. `http://IP_address`). For the factory default address, this entry would be

```
http://192.168.1.1
```

Network Ping

If you are unable to use the web browser, do these steps to ping the IP address:

1. Open a DOS window and type the currently-configured IP address of the adapter (i.e. `ping IP_address`). For the factory default address, this entry is

```
ping 192.168.1.1
```

If the DNS is configured, you should also be able to ping the host name:

```
ping hostname
```

2. You should see a series of replies or an indication that the link is valid. If the IP ping succeeded and the host name ping failed, there is a problem with the DNS configuration. Contact your network administrator.
3. If you were able to ping the AD007 adapter, you should also be able to access the web pages with a web browser. If not, contact your network administrator.



Operating Basics

This section contains information on how to use the web pages in the adapter to monitor, reconfigure, or test the flow of communications through the adapter, and how to set up a printer.

The adapter contains the following web pages:

- Home
- Network Setup
- GPIB Communications
- Print Setup
- Statistics
- Help
- Support

Home

The home page reports general information about the particular AD007 adapter that you are accessing, allows you to set the password, and provides links to the other web pages on the adapter.

To access the home page of the adapter, use the following procedure:

1. Start the web browser on your computer.
2. Open the location of the AD007 adapter assigned by the network administrator:
`http://ad007hostname` or IP address
3. From the home page of the adapter, click on the links to view the other pages on the adapter.

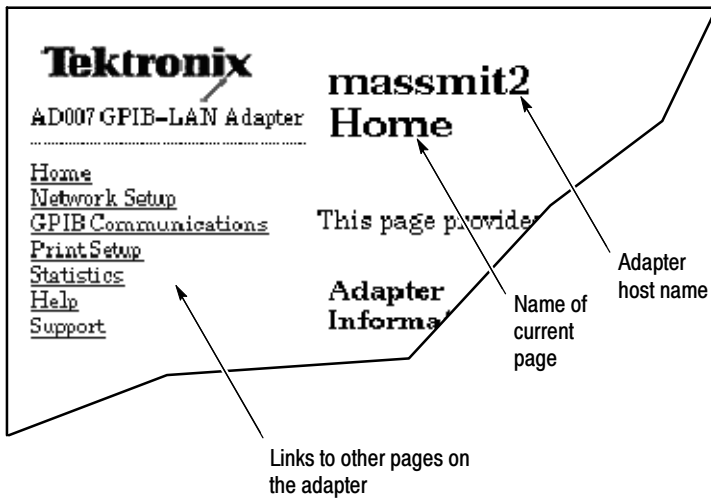

Figure 9: AD007 GPIB-LAN Adapter home page

Adapter Information

Adapter Information displays the following general information about the AD007 adapter you are currently accessing.

- Host name
- IP address
- Ethernet address
- Firmware revision number and last update
- BootROM revision number and last update
- Time (if the time server is configured)

Adapter Password

Adapter Password prevents unauthorized changes to the adapter and allows a firmware upgrade to proceed. By default, both the user name and password are set to ad007 (lowercase a, lowercase d, zero, zero, 7). To reset the password to the default setting, see *Resetting the Adapter* on page 48.

To set a new password, do these steps:

1. Enter the old password.
2. Enter the new password twice, once in each box provided.
3. Click Submit.

Reboot Adapter

To reboot the adapter remotely and perform all power up functions, click on Reboot.

Network Setup

At power on, the AD007 automatically configures its entire Network Setup from a Dynamic Host Configuration Protocol (DHCP) or Boot Protocol (BOOTP) server. If you do not have a server that supports DHCP/BOOTP, you may have to access the Network Setup page to examine and change one or more of the following network settings.

Host Configuration

If your server does not support the DHCP/BOOTP protocols, do these steps to bypass the protocols:

1. If you have access to the web pages, go to the Network Setup page and select DHCP Off.
2. If you do not have access to the web pages, momentarily press the reset button during power on to bypass the DHCP/BOOTP request and reset to the last configuration. (For the location of the reset button, see Figure 11 on page 48.)

Networking

To allow the adapter to talk to other hosts on the local network, enter the appropriate IP numbers for Adapter IP Address and Subnet Mask.

To allow the adapter to talk to hosts on other networks, enter the appropriate IP number for Router Address.

Name Service

If the Domain Name Service (DNS) parameters are correctly configured, you can set the Time Server and Print Server to domain names instead of numeric IP addresses.

To configure DNS, do these steps:

1. Set the Adapter Host name to the network host name of the AD007.
2. Set the DNS Domain to the domain name of the AD007.
3. Enter the IP address of at least one DNS server host. When listing more than one DNS server, use a space or comma between each IP address.

Time Protocol

Time Protocol, if set, synchronizes the AD007 to the current Universal Coordinated Time supplied by the time server during boot. If DNS is correctly configured for a time server, enter the IP address or domain name of at least one time server.

GPIB Communications

The GPIB communications page allows you to monitor and test communications to various devices on the GPIB.

GPIB Devices

General Purpose Interface Bus (IEEE 488) provides a means for several devices to communicate data through a parallel communications bus. Each device on the bus has a device address.

To identify what devices are present on the bus, click Poll.

Talk/Listen

A GPIB bus may contain only one controller device; all other devices are talkers, listeners, or talker/listeners. AD007 serves as a controller device any time an active GPIB control session is open.

To send a command string to the specific address of a device on the bus, do these steps:

1. Click Poll to identify what devices are on the GPIB.
2. Select the specific address of the device from the pull-down menu of polled addresses.
3. Enter the command in the box provided.
4. Click Send.

Network Connections

A network client control application can leave control sessions alive on the AD007 adapter. The adapter cannot automatically clear inactive connections. To clear all active and inactive network control sessions, select VXI-11 Reset.

Printer Setup

The Print Setup page allows you to establish or change the connection to a network printer.

- Printer setup
- Print status

Printer Setup

Under Printer Setup, enabling the Print Redirection feature allows GPIB hard copy to go directly to a network printer. If Print Redirection is on and there are no open GPIB device control sessions, the AD007 will intercept all traffic on the GPIB bus and send it as a print job to a networked printer. The AD007 adapter uses the LPD print server protocol (RFC1179). To enable this feature, select Print Redirection On.

NOTE. *To avoid GPIB conflicts, make sure that only one device at a time is in the hardcopy mode (EOI high). Do not leave instruments in the hard copy mode after the print job is finished.*

To connect to a network printer, do these steps:

1. Verify that your print server supports LPD network printing.
2. Identify the server name or IP address of your LPD print server.
3. Identify the print queue of the desired print device.
4. Identify print format supported by the printer (e.g. Postscript, Laserjet, Deskjet).

5. Set the hardcopy format of your GPIB equipment to the corresponding format.
6. Use the forms on the web page to enter the required settings (Print Redirection must be on) and click Submit.
7. Verify operation with the Test Print button. The adapter will send a test page to the network printer. If the printer understands how to print plain text, it will print the test page.

Print Status

If the print server allows you to examine the print queue or cancel print jobs, you can perform the following operations:

- To examine the status and contents of the print queue, click Refresh.
- To cancel a print job, enter the Job Number and click Cancel.

Statistics

The Statistics page allows you to view the activity of the network and GPIB communications interfaces and to view a system log of data.

Network Statistics

The Network Statistics shows the following counts:

- Tx - packets transmitted successfully
- Rx - packets received successfully
- Collisions - collisions detected
- Tx Errors - packets transmitted with error
- Rx Errors - packets received with error

GPIB Statistics

The GPIB Statistics shows the following counts:

- Rx - data received
- Rx Errors - data received with errors
- Tx - data transmitted
- Tx Errors - data transmitted with errors
- Cmd - commands sent
- Cmd Errors - errors resulting from commands
- Print - print data received
- Print Errors - print data with errors

System Log

To identify more technical system issues, view the System Log

Reset

To reset the statistics to zero, click Reset.

Help

This page contains a summary of helpful information about the adapter web pages.

Support

This page contains the same information found under *Contacting Tektronix* in the preface to this manual along with active links to the Tektronix Home page and the e-mail address for customer support.



Reference

This section provides these special diagnostic and setup procedures for the AD007 GPIB-LAN Adapter:

- Interpreting the Status Indicators, page 44
- Confirming a Hardware/Firmware Failure, page 47
- Resetting the Adapter, page 48

Interpreting the Status Indicators

The status indicators on the AD007 adapter report the progress and condition of power on self tests, network boot, and the normal traffic to and from the network and GPIB. To determine the operating state of the adapter, see Tables 2 and 3 to interpret the blinking patterns and colors of the indicators.

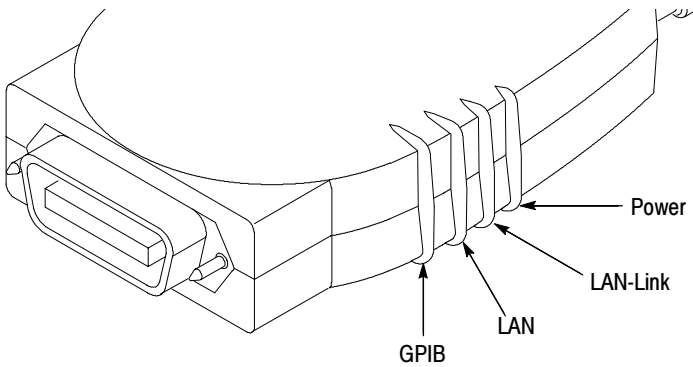

Figure 10: Status Indicators

Power On

Table 2 shows the sequence of status indications for power on. To perform or repeat the power on sequence, unplug the power to the adapter, wait a couple of seconds, then connect the power again.

Table 2: AD007 status indicators for power on

Power on status	GPIB	LAN	L-Link	Power
1. Off or power failure	Ø	Ø	Ø	Ø
2. Self testing (hardware)	G/A	G/A	G/A	G/A
3. Self test failure	R/Ø	R/Ø	R/Ø	A
	A	A	A	A
4. Self test pass	G/Ø	G/Ø	G/Ø	G
5. LAN Discovery loop (DHCP/BOOTP request) <i>Note: By default, the DHCP/BOOTP request continues to loop until serviced. To exit the loop, momentarily press the reset button. The adapter will load the last configuration from memory.</i>	Ø	Ø↔G/A	A	G
6. LAN OK	Ø	Ø↔G/A	G	G

G = Green R = Red A = Amber Ø = Off/Idle

G/A = Toggles between green and amber

Ø↔G/A = for LAN and GPIB, G indicates sending data, A indicates receiving data, Ø indicates idle

Normal Operation

Table 3 shows the possible status indications during normal operation.

Table 3: AD007 status indicators during normal operation

Operating and idle states	GPIB	LAN	L-Link	Power
Disconnected from the LAN with no IP address	∅	∅	R	G
Disconnected from the LAN after getting IP address	∅	∅	∅	G
Idle	∅	G/∅	G	G
LAN collision	∅↔G/A	∅↔G/A	G/A	G
GPIB spooling to AD007	A	∅↔G/A	G	G
AD007 printing to LAN printer	∅↔G/A	A	G	G
VXI-11 traffic	∅↔G/A	∅↔G/A	G	G

G = Green R = Red A = Amber ∅ = Off/Idle

G/A = Toggles between green and amber

∅↔G/A = for LAN and GPIB, G indicates sending data, A indicates receiving data, ∅ indicates idle

Confirming a Hardware/Firmware Failure

Defective hardware or firmware can cause the adapter to indicate a self-test failure as follows:

- No indicators light during power on
- The indicators light and remain amber
- The LAN-Link, LAN, and GPIB indicators blink red after the self-test at power on.

To confirm a hardware or firmware failure, do these steps:

1. Supply power to the AD007 adapter.
2. If no indicators light, check power connections at the following components:
 - a. line source to power cord
 - b. power cord to power supply
 - c. power supply to the DC input jack on the back of the AD007 adapter
3. If indicators light, wait 30 seconds for the self-test to complete. Blinking indicators at the beginning of power on indicate that the hardware self-test is in progress.
4. To indicate a successful self test, the LAN-Link, LAN, and GPIB indicators simultaneously blink green before automatically starting the LAN discovery (DHCP/BOOTP request) loop. See Table 2.
5. To indicate a hardware failure in the adapter, the adapter will indicate one or more of the following
 - a. The LAN-Link, LAN, and GPIB indicators simultaneously blink red *after* the 30-second self test is complete.
 - b. All indicators light and remain amber.
 - c. The LAN-Link, LAN, and GPIB indicators *do not* simultaneously blink green before beginning the LAN discovery.

If you experience a hardware or firmware failure, contact your local Tektronix Service Center. See the numbers under *Contacting Tektronix* on page x.

Resetting the Adapter

Because the adapter stores the current configuration settings in nonvolatile memory (flash ROM), it may be necessary to use the reset button to bypass the normal power on routine. The reset button is located inside a small recess on the bottom of the AD007 adapter. See Figure 11.

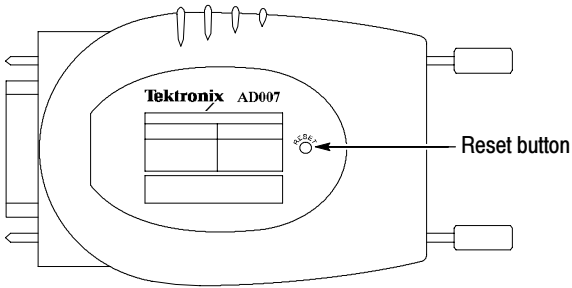

Figure 11: RESET button

Table 4 summarizes the results of using the reset button and actions necessary to achieve each result. Detailed procedures follow the table.

Table 4: Using the RESET button

Desired Result	When to push the RESET button	How long to hold the RESET button in
Bypass DHCP/BOOTP request and reset to last configuration	During LAN discovery loop (DHCP/BOOTP request) when LAN-Link is amber	momentarily
Reset only the password to factory default (ad007) Read the binary code of the adapter IP address on the status indicators	During normal operation	momentarily
Reset entire configuration to factory defaults	During normal operation or from power on	Until all indicators are steady amber (~ 10 seconds)

Bypass DHCP/BOOTP and Reset to Last Configuration

To bypass DHCP/BOOTP and reset to the last configuration, do these steps:

1. Power off the AD007 adapter and wait a few seconds.
2. Power on the AD007 adapter and wait until the adapter tries to discover the LAN (the LAN light begins to blink green/amber after the self test).
3. Using a small tool or end of a paper clip, momentarily push in the reset button. This bypasses the LAN discovery (DHCP request).
4. When the LAN-Link indicator turns from amber to green, the AD007 adapter has successfully loaded the last configuration.

Reset the Password and Read the IP Address

With the adapter in the normal mode, press the RESET button momentarily. The password resets to ad007 and begins to display the IP address of the adapter. Each flash indicates the binary code of the digits of the IP address left to right. (Leading zeros in each field of the address are ignored.)

xxx.xxx.xxx.xxx

Refer to Table 5 to decode the binary value of each decimal in the IP address.

Table 5: Binary-to-decimal conversion chart for IP address

GPIB	LAN	LAN-Link	Power	Value of IP address
Green	Green	Green	Green	0
Green	Green	Green	Red	1
Green	Green	Red	Green	2
Green	Green	Red	Red	3
Green	Red	Green	Green	4
Green	Red	Green	Red	5
Green	Red	Red	Green	6
Green	Red	Red	Red	7
Red	Green	Green	Green	8
Red	Green	Green	Red	9
Amber	Amber	Amber	Amber	.

Reset to the Factory Defaults

The procedure to reset to factory defaults overrides current settings and sets the adapter to known settings. This makes it possible to access the adapter from the known settings or to turn DHCP on. You may reset to Factory defaults either at power on or during normal operation.

NOTE. *If you are not using DHCP, use the factory default settings only if you are sure they do not conflict with other settings on the network. If the settings conflict, use the procedure for stand-alone operation to access the adapter.*

To reset at power on, do these steps:

1. Power the AD007 adapter off.
2. Use a small tool or end of a paper clip to push in and hold the reset button.
3. Power on the AD007 adapter and hold the reset button in until all status indicators go to a steady amber (approximately 30 seconds), then release the button. The AD007 adapter automatically reboots with the factory defaults.

Table 6: Factory default settings

Page	Name	Setting
Home	Host name	ad007
	Password	ad007
Network Setup	DHCP	On
	IP address	192.168.1.1
	Subnet mask	255.255.255.0
	Router (Gateway)	<empty>
	DNS Domain	<empty>
	DNS Servers	<empty>
	Time Servers	<empty>
Printer Setup	Print Redirection	Off
	Print Server	lphost
	Print Queue	lp

To reset during normal operation, do these steps:

1. Check that the self tests are complete (POWER and LAN-Link are Green).
2. If the adapter is looping on the DHCP/BOOTP request, momentarily press the reset button to bypass the request and begin normal operation.

3. Using a web browser, enter the factory default IP address:

`http://192.168.1.1`

If you cannot access this address, you may need to reset to the factory default settings at power on.

4. On the network configuration web page of the adapter, enter the correct IP address, subnet mask, and router (gateway) address.

The following settings are the most important:

- IP address: 192.168.1.1
 - Subnet mask: 255.255.255.0
5. Turn DHCP off if there is no DHCP/BOOTP server.
 6. Click Submit. The new information is now in nonvolatile memory.
 7. Power off the adapter.
 8. Power on the adapter to boot up the adapter with the new settings.

Appendix A: Specifications

All specifications listed in Table 7 are warranted unless marked as typical.

Table 7: General specifications

AD007 input voltage and current	5 VDC, 300 mA typical
Power supply output	5 VDC, use only the power supply provided
DC connector polarity	Center terminal, + Outer ring, -

Tables 8 through 9 list the certifications and compliances for the AD007 adapter and standard accessory power supply.

Table 8: AD007 certifications and compliances

EC Declaration of Conformity - EMC	<p>Meets intent of Directive 89/336/EEC for Electromagnetic Compatibility. Compliance was demonstrated to the following specifications as listed in the Official Journal of the European Union:</p> <p>EN 55011 Class A Radiated and Conducted Emissions</p> <p>EN 1000-3-2 AC Power Line Harmonic Emissions</p> <p>EN 50082-1 Immunity:</p> <p>IEC 1000-4-2 Electrostatic Discharge Immunity</p> <p>IEC 1000-4-3 RF Electromagnetic Field Immunity</p> <p>IEC 1000-4-4 Electrical Fast Transient/Burst Immunity</p> <p>IEC 1000-4-5 Power Line Surge Immunity</p> <p>IEC 1000-4-6 RF Conducted Immunity</p> <p>IEC 1000-4-11 Line Dropout/Dips Immunity</p>
------------------------------------	---

Table 8: AD007 certifications and compliances (cont.)

<p>Australia/New Zealand Declaration of Conformity - EMC</p>	<p>Complies with EMC provision of Radiocommunications Act per the following standard(s):</p> <p>AN/NZS 2064.1/2 Industrial, Scientific, and Medical Equipment:1992</p>
<p>FCC Compliance</p>	<p>Emissions comply with FCC Code of Federal Regulations 47, Part 15, Subpart B, Class A Limits.</p>
<p>Pollution Degree</p>	<p>A measure of the contaminates that could occur in the environment around and within a product. Typically the internal environment inside a product is considered to be the same as the external. Products should be used only in the environment for which they are rated.</p> <p>Pollution Degree 1 No pollution or only dry, nonconductive pollution occurs. Products in this category are generally encapsulated, hermetically sealed, or located in clean rooms.</p> <p>Pollution Degree 2 Normally only dry, nonconductive pollution occurs. Occasionally a temporary conductivity that is caused by condensation must be expected. This location is a typical office/home environment. Temporary condensation occurs only when the product is out of service.</p>

Table 9: Power supply certifications and compliances

EC Declaration of Conformity - Low Voltage	<p>Compliance was demonstrated to the following specification as listed in the Official Journal of the European Union:</p> <p>Low Voltage Directive 73/23/EEC, amended by 93/69/EEC</p> <p>EN 60950/A3:1995 Safety of information technology equipment, including electrical business equipment.</p>
U.S. Nationally Recognized Testing Laboratory Listing	UL1950/3rd edition
Canadian Certification	CAN/CSA C22.2 No. 950
Additional Compliance	<p>Dentori (T mark)</p> <p>IEC 60950</p>
Installation (Overvoltage) Category	<p>Terminals on this product may have different installation (overvoltage) category designations. The installation categories are:</p> <p>CAT II Local-level mains (wall sockets). Equipment at this level includes appliances, portable tools, and similar products. Equipment is usually cord-connected.</p> <p>CAT I Secondary (signal level) or battery operated circuits of electronic equipment.</p>

Table 9: Power supply certifications and compliances (cont.)

Pollution Degree	<p>A measure of the contaminates that could occur in the environment around and within a product. Typically the internal environment inside a product is considered to be the same as the external. Products should be used only in the environment for which they are rated.</p> <p>Pollution Degree 1 No pollution or only dry, nonconductive pollution occurs. Products in this category are generally encapsulated, hermetically sealed, or located in clean rooms.</p> <p>Pollution Degree 2 Normally only dry, nonconductive pollution occurs. Occasionally a temporary conductivity that is caused by condensation must be expected. This location is a typical office/home environment. Temporary condensation occurs only when the product is out of service.</p>
Safety Certification Compliance	
Temperature, operating	+5 to +45° C
Altitude (maximum operating)	2000 meters
Equipment Type	Test and measuring
Safety Class	Class 1 (as defined in IEC 1010-1, Annex H) – grounded product
Overvoltage Category	Overvoltage Category II (as defined in IEC 1010-1, Annex J)
Pollution Degree	Pollution Degree 2 (as defined in IEC 1010-1). Note: Rated for indoor use only.

Appendix B: Power Cord Options

The power cords in Table 10 may be ordered as options at the time of purchase or they may be ordered separately.

Table 10: Power cord identification

Plug configuration	Normal usage	Option number and part number
	North America 125 V/15 A Plug NEMA 5-15P	Standard (161-0230-01)
	Europe 230 V	A1 (161-0104-06)
	United Kingdom 230 V	A2 (161-0104-07)
	Australia 230 V	A3 (161-0104-05)
	Switzerland 230 V	A5 (161-0167-00)

Table 10: Power cord identification (cont.)

Plug configuration	Normal usage	Option number and part number
Not shown	Japan 100 V	A6 (161-0298-00 with 3-2 wire adapter 013-0310-00)
Not shown	China 250 V	A10 (161-0306-00)

Appendix C: Network Protocols

The AD007 GPIB-LAN Adapter uses the network IP and Ethernet protocols listed in Table 11.

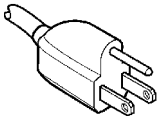
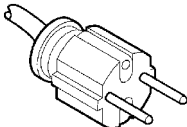
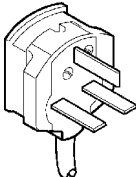
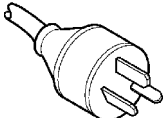
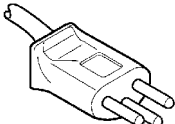
Table 11: IP and Ethernet protocols

Name	RFC	Role	When	Purpose
ARP	826	Peer	As needed	Maps IP address to Ethernet address
BOOTP	951	Client	Power-up	AD007 requests IP configuration information
DHCP	2131, 2132	Client	Power-up lease renew	AD007 requests IP configuration information
DNS	1035	Client	As needed	AD007 resolves DNS names to IP addresses
TIME	868	Client	Power-up	AD007 requests current time
FTP	959	Server	Upgrade	Downloads new firmware into AD007
HTTP	1945 2068	Server	User setup	Web pages/forms for AD007 configuration
ICMP	792	Server	As needed	AD007 answers ECHO requests (ping)
LPD	1179	Client	Printing	AD007 transmits print jobs to other LPDs
RPC	1831, 1832, 1833	Server	User	Controls GPIB instruments using VXI-11

A definition of each of these protocols appears in the glossary at the end of the manual.

Appendix D: Troubleshooting

If you experience communication problems to and from the adapter, use the information in this section to help identify the nature of the problem before calling for service.

Power On and Status

The power on and status indicators can help identify problems with the hardware, firmware, physical connections, or network settings. See Table 12 for a list of possible problems.

Table 12: Power on and status problems

Symptom	Possible cause(s)	Corrective action(s)
No indicators light	No AC power connection to the power supply No DC power from the power supply	Recheck connections to DC input, AC adapter, and AC power
	Defective AC adapter Power supply failure in AD007 adapter	Contact service and return defective module(s)
POWER indicator is green, LAN-Link indicator is red, LAN indicator is off, GPIB indicator is off	No network connection	Check for missing or loose LAN connection Check LAN connection for traffic
POWER, GPIB, LAN, and LAN LINK indicators are all amber	Hardware Failure	Contact service and return defective adapter

Table 12: Power on and status problems (cont.)

Symptom	Possible cause(s)	Corrective action(s)
POWER indicator is green, GPIB, LAN, and LAN LINK indicators simultaneously blink red	Hardware or Firmware Failure	<p>Try to reboot the adapter by disconnecting and reconnecting the power to the adapter</p> <p>If rebooting the adapter does not correct the problem, Contact Tektronix service and return defective adapter</p>
POWER indicator is green, LAN-LINK indicator is amber	No service to DHCP/BOOTP request	<p>Check that DHCP/BOOTP server exists</p> <p>Check DHCP server on LAN for requests from this AD007's Ethernet address</p> <p>Bypass DHCP/BOOTP by momentarily pressing the Reset button</p>

For a complete list of power up and status indications, See *Interpreting the Status Indicators* on 44.

Network and Print Configuration

Use the list of symptoms in Table 13 to help diagnose problems with the network and print configuration.

Table 13: Network and print problems

Symptom	Possible cause(s)	Corrective action(s)
No access to web pages in the adapter	Improper network installation Missing or improper set up of network addresses: -Ethernet address -IP address -Subnet mask -Default router (gateway)	Check network installation or contact network administrator. Check that the LAN network is set up for the Ethernet hardware address of AD007 adapter (from label on back)
Can only access diagnostic web page	Problem with AD007 adapter firmware	Reload firmware using the Update program, see <i>Tektronix Software Solutions Installation Manual</i> (Tektronix part number 071-1140-01) that came with the TSS CD (also located in the Documents directory on the TSS CD)
No password	Unknown or forgotten password	Reset the password to the factory default (ad007), see page 50
Slow web page response to network printing	Server not responding	Check server Check print server address and queue name
No print server status, print job list, or failure in cancelling jobs	Print server does not implement these requests	Use print server that has support for these requests

Table 13: Network and print problems (cont.)

Symptom	Possible cause(s)	Corrective action(s)
Nothing prints Prints garbage	AD007 print configuration is not set correctly	<p>Check print redirection is on in the AD007 Print Setup web page</p> <p>Check that the instrument is directing the print to the GPIB port</p> <p>Check server address and queue name</p> <p>Attempt test print</p> <p>Check that no more than one device on the GPIB is in the hard copy mode</p>
	Print format unrecognized by printer	In the GPIB instrument, select a print format which matches the capability of the printer
	Print server discards data from unknown IP address	Configure the print server to accept connections from the AD007
	Print server does not support LPD connections	Use a different print server which supports LPD
Test print does not work, but direct (from instrument) print does	Printer does not support text printing	Select a different print server address queue which supports ASCII text printing
Direct print from a device on the GPIB does not work	<p>Print redirection is not on</p> <p>Device is not in the hard copy mode</p> <p>More than one device on the GPIB is in the hard copy mode</p>	<p>Check print redirection is on in the AD007 Print Setup web page</p> <p>Check that no more than one device on the GPIB is in the hard copy mode</p>

GPIB

Problems with setting up devices on the GPIB appear in Table 14.

Table 14: GPIB problems

Symptom	Possible cause(s)	Corrective action(s)
Cannot send commands to one or more devices on the GPIB	Intermittent or missing GPIB connection	Verify or test GPIB connection(s)
	Power to GPIB device not on	Verify all GPIB devices are turned on and operating properly
	VISA not configured	Use configuration utility
Slow response to GPIB poll on <i>GPIB Communications</i> web page	No instruments on the GPIB bus or instruments not turned on. Poll timeout is about 60 seconds	Connect instruments to the GPIB and power them on
No password	Unknown or forgotten password	Reset the password to the factory default (ad007), see page 50

Glossary

10/100BaseT

Ethernet (IEEE 802.3) architecture that uses twisted-pair cabling.

ARP

Address Resolution Protocol. Internet protocol used to map the IP address to the Ethernet hardware address.

BOOTP

Boot Protocol. Protocol that enables a network client to automatically discover its networking parameters on power up from a BOOTP server.

DHCP

Dynamic Host Configuration Protocol. Protocol that enables a net client to automatically discover its networking parameters on power up from a DHCP server and refresh those parameters periodically.

DNS

Domain Name Service. A protocol that maps Internet hostnames (e.g. www.tek.com) to IP addresses.

Ethernet address

The unique, six-byte address assigned by the product manufacturer that distinguishes each talk/listen device on the LAN. The address consists of hexadecimal numbers separated by colons (hh:hh:hh:hh:hh:hh).

FTP

File Transfer Protocol. Enables a client host to send or receive files to and/or from an FTP server host.

GPIB

General Purpose Interface Bus (IEEE-488).

HTTP

Hyper Text Transfer Protocol. Protocol for requesting data files from a World Wide Web server.

ICMP

Internet Control Message Protocol. Protocol for status messages from a router (gateway) indicating errors or unusual conditions.

IP address

Internet Protocol address. The address assigned by the network administrator to a talk/listen device that distinguishes it from the other devices on the LAN.

LAN

Local Area Network.

LPD

Line Printer Daemon. Protocol which enables print files to be sent to print servers and (if implemented by server) get status of the remote print queue, examine print jobs, and cancel print jobs.

protocol

An evolving set of rules that governs the format and transmission of data in a network.

RFC

Request for Comments. Working notes on evolving Internet research and development available from the Defense Data Network (DDN) NIC at SRI International.

RPC

Remote Procedure Call. Protocol to transmit procedure call data across a network to a server and return to the calling client. Used in the AD007 adapter to implement VXI-11 function calls.

TCP/IP

Transmission Control Protocol/Internet Protocol. An Internet protocol for two-way stream data transfer between programs on two Internet hosts.

Time Protocol

Enables an Internet host to request the current time of day from a time server host.

VISA

Virtual Instrument Software Architecture. Provides a common Input/Output (I/O) library for software developers so that software from different vendors can run on the same platform.

VXI-11

Protocol for instrument control over a network interface.

Index

Numbers

10BaseT, 1

A

accessories, 4
ARP, 61

B

BOOTP, 3, 8, 12, 49, 61

C

configuring TekVISA, 30
contacting Tektronix, x

D

DHCP, 3, 8, 12, 49, 61
 server, 8
DNS, 3, 9, 61

E

Ethernet, hardware address, 11
external features, location of, 5

F

factory defaults, resetting, 51

FTP, 3, 61

G

GPIB, 1
 network configuration, 27

H

hardware failure, 47
HTTP, 3, 61

I

ICMP, 61
installation
 GPIB, 27–32
 network, 10
 TekVISA, 29
IP address, assigning, 11

L

LPD, 3, 61

N

network
 administrator, 10
 information card, 10
 installation, 10, 12
 protocols, 61

server(s), 12
verifying access to, 32

P

password, 26
 resetting factory default, 48
 setting new, 35
phone number, Tektronix, x
power cords, 59
power supply, shown, 4
printing, GPIB, 29
product support, contacting, x
protocols, 3, 61

Q

quick setup, 7

R

rebooting, 35
requirements, system, 3
RESET button
 bypassing DHCP/BOOTP, 49
 last configuration, 49
 shown, 48
Reset button, functions, 49
RJ-45, shown, 4
RPC, 61

S

safety, vii
self test, power on, 5
server, DHCP/BOOTP, 8, 12
service support, contact information, x

specifications, 55
status indicators
 at power on, 45
 during normal operation, 46
 shown, 6, 44

T

technical support, contacting, x
Tektronix, contacting, x
TekVISA configuration, 30
Time Protocol, 3, 61
troubleshooting, 63

U

URL, Tektronix, x
user name, 26, 35

V

VISA
 configuration, 30

W

WaveStar for Oscilloscopes, 2
web page, diagnostic, 26
web page interface
 accessing, 26, 34
 GPIB communications page, 38
 Help page, 42
 Home page, 34
 Network Setup page, 36
 Printer Setup page, 39
 Statistics page, 41
 Support page, 42
web site address, Tektronix, x