

SUPER 

SUPER P4SCT  
SUPER P4SCT+  
SUPER P4SCT+II

USER'S MANUAL

Revision 1.0c

---

The information in this User's Manual has been carefully reviewed and is believed to be accurate. The vendor assumes no responsibility for any inaccuracies that may be contained in this document, makes no commitment to update or to keep current the information in this manual, or to notify any person or organization of the updates. **Please Note: For the most up-to-date version of this manual, please see our web site at [www.supermicro.com](http://www.supermicro.com).**

SUPERMICRO COMPUTER reserves the right to make changes to the product described in this manual at any time and without notice. This product, including software, if any, and documentation may not, in whole or in part, be copied, photocopied, reproduced, translated or reduced to any medium or machine without prior written consent.

IN NO EVENT WILL SUPERMICRO COMPUTER BE LIABLE FOR DIRECT, INDIRECT, SPECIAL, INCIDENTAL, OR CONSEQUENTIAL DAMAGES ARISING FROM THE USE OR INABILITY TO USE THIS PRODUCT OR DOCUMENTATION, EVEN IF ADVISED OF THE POSSIBILITY OF SUCH DAMAGES. IN PARTICULAR, THE VENDOR SHALL NOT HAVE LIABILITY FOR ANY HARDWARE, SOFTWARE, OR DATA STORED OR USED WITH THE PRODUCT, INCLUDING THE COSTS OF REPAIRING, REPLACING, INTEGRATING, INSTALLING OR RECOVERING SUCH HARDWARE, SOFTWARE, OR DATA.

Any disputes arising between manufacturer and customer shall be governed by the laws of Santa Clara County in the State of California, USA. The State of California, County of Santa Clara shall be the exclusive venue for the resolution of any such disputes. Supermicro's total liability for all claims will not exceed the price paid for the hardware product.

---

Manual Revision: Rev. 1.0c

Date: Dec. 6, 2005

Unless you request and receive written permission from SUPER MICRO COMPUTER, you may not copy any part of this document.

Information in this document is subject to change without notice. Other products and companies referred to herein are trademarks or registered trademarks of their respective companies or mark holders.

Copyright © 2005 by SUPER MICRO COMPUTER INC.  
All rights reserved.

**Printed in the United States of America**

---

# Preface

## About This Manual

This manual is written for system integrators, PC technicians and knowledgeable PC users. It provides information for the installation and use of the SUPER P4SCT/P4SCT+/P4SCT+II motherboard. The P4SCT/P4SCT+/P4SCT+II supports single Intel Pentium® 4 processors or Celeron processors up to 3.40 GHz (with Hyper Threading) at a system bus speed of 800/533/400 MHz.(\*see the note below). Pentium 4/Celeron processors are housed in a 478-pin micro PGA (Plastic Grid Array) package. Please refer to the motherboard specifications pages on our web site ([http://www.supermicro.com/Product\\_page/product-m.htm](http://www.supermicro.com/Product_page/product-m.htm)) for updates on supported processors. This product is intended to be professionally installed.

(\*Note: The above CPUs must be utilizing 0.09 or 0.13 Micron Manufacturing Technology.)

## Manual Organization

**Chapter 1** includes a checklist of what should be included in your mainboard box, describes the features, specifications and performance of the P4SCT/P4SCT+/P4SCT+II mainboard and provides detailed information about the chipset.

**Chapter 2** begins with instructions on handling static-sensitive devices. Read this chapter when installing the processor and DDR memory modules and when mounting the mainboard in the chassis. Also refer to this chapter to connect the floppy and hard disk drives, the IDE interfaces, the parallel and serial ports, the mouse and keyboard and the twisted wires for the power supply, the reset button, the keylock/power LED and the speaker.

If you encounter any problems, see **Chapter 3**, which describes troubleshooting procedures for the video, the memory and the setup configuration stored in CMOS. For quick reference, a general FAQ (Frequently Asked Questions) section is provided. Instructions are also included for contacting technical support. In addition, you can visit our web site at [www.supermicro.com/techsupport.htm](http://www.supermicro.com/techsupport.htm) for more detailed information.

**Chapter 4** includes an introduction to BIOS and provides detailed information on running the CMOS Setup utility.

**Appendix A** provides BIOS POST Messages.

**Appendix B** lists BIOS POST Codes.

**Appendix C** lists Software Drivers and the OS Installation Instructions.

---

---

## Table of Contents

### Preface

About This Manual .....	iii
Manual Organization .....	iii

### Chapter 1: Introduction

1-1 Overview .....	1-1
Checklist .....	1-1
Contacting Supermicro .....	1-2
Super P4SCT/P4SCT+/P4SCT+II Image .....	1-4
Super P4SCT/P4SCT+/P4SCT+II Layout .....	1-5
SUPER P4SCT/P4SCT+/P4SCT+II Quick Reference .....	1-5
Canterwood Chipset: System Block Diagram .....	1-6
Motherboard Features .....	1-7
1-2 Chipset Overview .....	1-9
1-3 PC Health Monitoring .....	1-11
1-4 Power Configuration Settings .....	1-12
1-5 Power Supply .....	1-13
1-6 Super I/O .....	1-14

### Chapter 2: Installation

2-1 Static-Sensitive Devices .....	2-1
2-2 Processor and Heatsink Installation .....	2-2
2-3 Mounting the Motherboard in the Chassis .....	2-4
2-4 Installing DDR Memory .....	2-4
2-5 I/O Port/Front Control Panel Connector Locations .....	2-6
2-6 Connecting Cables .....	2-7
Power Supply Connectors .....	2-7
PW_ON Connector .....	2-7
Reset Connector .....	2-8
Overheat LED (OH) .....	2-8
GLAN1 LED .....	2-9
GLAN2 LED .....	2-9
IDE/SATA LED .....	2-10
Power_LED Connector .....	2-10
NMI Button .....	2-11
Speaker Connector .....	2-11
IR Connector .....	2-11

Serial Ports .....	2-12
Fan Headers .....	2-12
Chassis Intrusion .....	2-13
Wake-On-LAN .....	2-13
Ethernet Ports: GLAN1 and GLAN1 .....	2-14
VGA Connector .....	2-14
SMB Header .....	2-14
ATX PS/2 Keyboard/Mouse Ports .....	2-15
Universal Serial Bus (USB) .....	2-15
Wake-On-Ring .....	2-16
Keylock Enable/Disable .....	2-16
Intel's SATA LED .....	2-17
Marvell's SATA LED .....	2-17
Standby Power LED .....	2-17
2-7 Jumper Settings .....	2-18
Explanation of Jumpers .....	2-18
CMOS Clear .....	2-18
Marvel's SATA Enable .....	2-19
USB (1/2) Wake-Up .....	2-19
Watch Dog Enable/Disable .....	2-20
Keyboard Wake-Up .....	2-21
GLAN2 Enable/Disable .....	2-21
VGA Enable/Disable .....	2-22
Front Side Bus Speed .....	2-22
2-8 Parallel Port, Floppy/Hard Drive and AGP Connections .....	2-23
Parallel Port Connector .....	2-23
Floppy Connector .....	2-24
IDE Connectors .....	2-24
AGP Pro Connector .....	2-25

## Chapter 3: Troubleshooting

3-1 Troubleshooting Procedures .....	3-1
Before Power On .....	3-1
No Power .....	3-1
No Video .....	3-1
Memory Errors .....	3-2
Losing the System's Setup Configuration .....	3-2
3-2 Technical Support Procedures .....	3-2
3-3 Frequently Asked Questions .....	3-3
3-4 Returning Merchandise for Service .....	3-5

**Chapter 4: BIOS**

4-1	Introduction .....	4-1
4-2	Running Setup .....	4-2
4-3	Main BIOS Setup .....	4-2
4-4	Advanced BIOS Setup .....	4-4
	4-4.1 Advanced BIOS Features .....	4-4
	4-4.2 Advanced Chipset Control .....	4-5
	4-4.3 I/O Device Configuration .....	4-7
	4-4.4 PnP Configuration .....	4-9
	4-4.5 Console Redirection .....	4-10
	4-4.6 Hardware Monitors .....	4-11
	4-4.7 Processor & Clock Options .....	4-12
4-5	Security .....	4-13
4-6	Boot .....	4-14
4-7	Exit .....	4-15

**Appendices:**

Appendix A:	BIOS POST Messages .....	A-1
Appendix B:	BIOS POST Codes .....	B-1
Appendix C:	Software Installation Instructions .....	C-1

# Chapter 1

## Introduction

### 1-1 Overview

#### Checklist

Congratulations on purchasing your computer motherboard from an acknowledged leader in the industry. Supermicro boards are designed with the utmost attention to detail to provide you with the highest standards in quality and performance.

Please check that the following items have all been included with your motherboard. If anything listed here is damaged or missing, contact your retailer.

#### All Included with Retail Box Only

- One (1) Supermicro Mainboard
- One (1) User's/BIOS Manual
- One (1) IDE cable (CBL-036)
- One (1) ATX floppy cable with 3 heads (CBL-022)
- One (1) 9-Pin serial port DKT cable (CBL-010)
- One (1) CPU Retention Kit (SKT-109)
- One (1) Supermicro CD ROM drivers and software

#### For the P4SCT:

- Two (2) SATA cables (CBL-044)
- One (1) I/O shield (CSE-PT2)

#### For the P4SCT+/P4SCT+II:

- Six (6) SATA cables (CBL-044)
- One (1) I/O shield (CSE-PT7)

## Contacting Supermicro

### Headquarters

Address: SuperMicro Computer, Inc.  
980 Rock Ave.  
San Jose, CA 95131 U.S.A.

Tel: +1 (408) 503-8000

Fax: +1 (408) 503-8008

Email: [marketing@supermicro.com](mailto:marketing@supermicro.com) (General Information)  
[support@supermicro.com](mailto:support@supermicro.com) (Technical Support)

Web Site: [www.supermicro.com](http://www.supermicro.com)

### Europe

Address: SuperMicro Computer B.V.  
Het Sterrenbeeld 28, 5215 ML  
's-Hertogenbosch, The Netherlands

Tel: +31 (0) 73-6400390

Fax: +31 (0) 73-6416525

Email: [sales@supermicro.nl](mailto:sales@supermicro.nl) (General Information)  
[support@supermicro.nl](mailto:support@supermicro.nl) (Technical Support)  
[rma@supermicro.nl](mailto:rma@supermicro.nl) (Customer Support)

### Asia-Pacific

Address: SuperMicro, Taiwan  
4F, No. 232-1 Liancheng Road  
Chung-Ho 235, Taipei Hsien, Taiwan, R.O.C.

Tel: +886-(2) 8226-3990

Fax: +886-(2) 8226-3991

Web Site: [www.supermicro.com.tw](http://www.supermicro.com.tw)

#### Technical Support:

Email: [support@supermicro.com.tw](mailto:support@supermicro.com.tw)

Tel: 886-2-8226-3990, ext.132 or 139



## SUPER P4SCT

Figure 1-1. SUPER P4SCT Image



- (1. \*Please see Notes on the next page for the differences between the P4SCT, the P4SCT+ and the P4SCT+II.
2. \*All graphics and pictures shown in this manual were based upon the latest PCB revision available at the time of publishing of this manual. The motherboard you've received may or may not look exactly the same as the graphics shown in this manual.)

Figure 1-4. SUPER P4SCT/P4SCT+/P4SCT+II Motherboard Layout

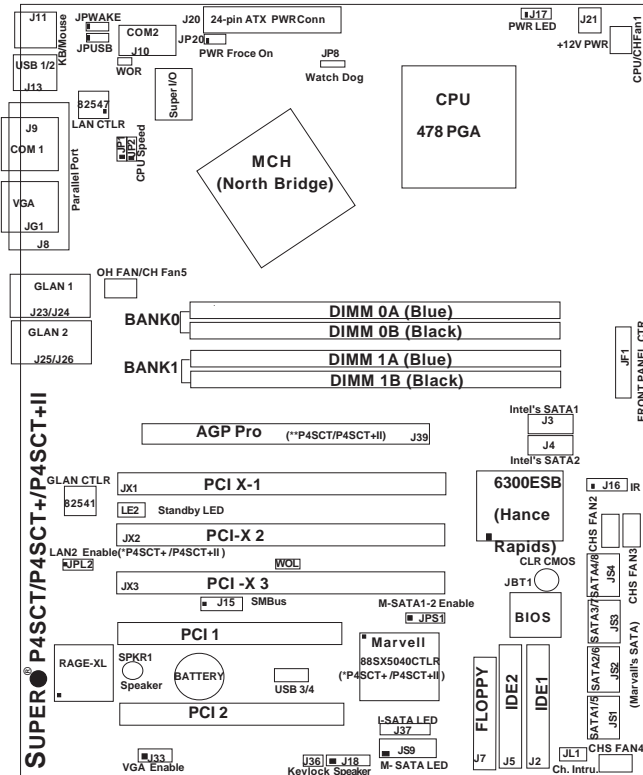

- Notes:
- \*Jumpers not indicated are for test purposes only.
  - \*See Chapter 2 for detailed information on jumpers, I/O ports and JF1 front panel connections.
  - \* "■" indicates the location of Pin 1.
  - Use the Green Slot for ZCRChannel RAID. The blue slot is used to identify 2-way memory interleave.

The differences between the P4SCT, the P4SCT+ and the P4SCT+II:

- 1)P4SCT: One GLAN, AGP, two Intel's SATA ports, Chipset:Canterwood (875P)
- 2)P4SCT+: No AGP, two GLAN Connectors, Intel's SATA Controller w/two SATA ports, Marvell's SATA Controller w/four SATA ports, Chipset: Canterwood-ES (E7210).
- 3) P4SCT+II: One AGP, two GLAN Connectors, Intel's SATA Controller w/two SATA ports, Marvell's SATA Controller w/four SATA ports, Chipset: Canterwood (875P).

---

## P4SCT/P4SCT+/P4SCT+II Quick Reference

<b><u>Jumpers</u></b>	<b><u>Description</u></b>	<b><u>Default Setting</u></b>
J18	Speaker	Pins 3-4 (In.Buzzer)
J33	VGA Enable/Disable	Pins 1-2 (Enabled)
J36	Keylock Header	Open(Disabled)
JBT1	CMOS Clear	See Section 2-7
JP1,JP2	CPU Clock Speed	Pins 1-2 (Auto)
JP8	Watch Dog Reset	Pins 1-2 (WD Reset)
JP20	Power Force On	Open (Disabled)
JPL2 (P4SCT+/SCT+II)	GLAN2	Pins 1-2 (Enabled)
JPS1 (P4SCT+/SCT+II)	Marvell's SATA Enable	Pins 1-2 (Enabled)
JPUSB	USB1/2 Wake Up	Pins 1-2 (VCC5)
JPWAKE	KB Wake Up	Pins 1-2 (VCC5)

<b><u>Connectors</u></b>	<b><u>Description</u></b>
DIMM0A/0B/1A/1B	Memory (DIMM) Slots (1 through 4)
Fans 1-5	CPU/CH Fan1, CH Fan 2, 3, 4, OH Fan/CH Fan 5
GLAN1/2(GbLAN)	LAN1:J23,J24, LAN2:J25,J26(LAN2:P4SCT+/SCT+II)
J2, J5	IDE Ports (J2: IDE1, J5:IDE2)
J3, J4	Intel's Serial ATA Connectors 1/2
J7	Floppy Disk Drive Connector
J8	Parallel Printer Port
J9,J10	COM1(J9), COM2(J10)
J11	Keyboard/Mouse Connector
J15	System Management Bus
J16	Infrared
J17	Power LED
J20	ATX Power Connector
J21	+12V Power Connector
J36	Keylock Connector
J37	Intel's SATA LED Header
JF1	Front Control Panel
JG1	VGA Header
JL1	Chassis Intrusion Header
JP17	Power LED
JS1-4	Marvell's SATA1-8 Connectors (P4SCT+/SCT+II)
JS9	Marvell's SATA1-4 LED Header (P4SCT+/SCT+II)
JX1-3	PCI-X Slots 1-3
USB 1/2 (J12,13)	Back Panel Universal Serial Ports 1/2
USB 3/4	Front Panel Universal Serial Ports 3/4
WOL	Wake-On-LAN
WOR	Wake-On-Ring Header

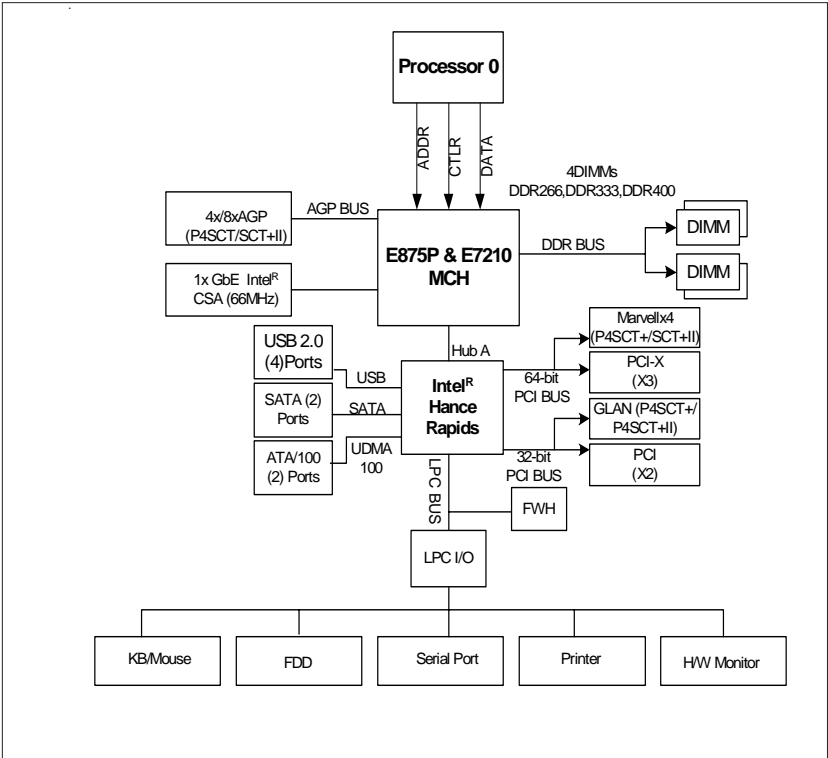

**Figure 1-6.**  
**P4SCT/P4SCT+/P4SCT+II System Block Diagram: (with the 6300ESB Hance Rapids Chipset)**

**Note:** This is a general block diagram and may not exactly represent the features on your motherboard. See the following pages for the actual specifications of the motherboard.

---

## Motherboard Features

### **CPU** ♦ *Latest CPU technology!*

- Single Pentium® 4 478-pin PGA processors or Intel Celeron processors up to up to 3.40 GHz (at a 800/533/400 MHz FSB) w/HyperThreading.
- Intel Pentium 4/Celeron processors (\*use 0.09 or 0.13 Micron Manufacturing Technology CPUs)

**Note:** Refer to the motherboard specifications pages on our web site ([http://www.supermicro.com/Product\\_page/product-m.htm](http://www.supermicro.com/Product_page/product-m.htm)) for updates on supported processors.

### **Memory** ♦ *Latest memory technology!*

- Dual Channel DDR up to 4 GB ECC, non-ECC, unbuffered DDR-400/333/266 SDRAM in 2 Banks 4 DIMMs (\*For Dual-Channel operation, identical pair(s) of memory modules must be populated in DIMM0A, DIMM1A and/or DIMM0B, DIMM1B.). (\*See Section 2-4 for more details)
- *Intel Performance Acceleration Technology!*

(\***Note:** The Canterwood chip supports non-ECC or ECC memory. If ECC memory is installed, the ECC bits need to be initialized via BIOS before normal operation. For a 4 GB-Memory and 2.4-GHz P4 system, it will take about 65 seconds for all the ECC bits to be initialized before any video displays. Since ECC initialization takes time, the Watch Dog Timer Select needs to be set to a time longer than what the ECC initialization will take.)

### **Chipset** ♦ *Latest Intel chipset technology!*

- Intel 875P Canterwood (\*P4SCT/P4SCT+II)
- Intel E7210 Canterwood ES (\*P4SCT+)

### **Expansion Slots**

- Three 64-bit, 66 MHz PCI-X slots (3.3 V)
- Two 32-bit, 33 MHz PCI slots (5 V)

### **BIOS**

- 8 Mb Firmware Hub AwardBIOS® Flash BIOS
- APM 1.2, DMI 2.3, PCI 2.3, ACPI 1.0, Plug and Play (PnP)

### **PC Health Monitoring**

- Eight onboard voltage monitors for CPU core, +3.3V, +3.3V standby, +5V, +5V standby, Vbat (battery voltage) and ±12V
- Fan status monitor with firmware/software on/off control
- Supero Doctor III, Watch Dog, NMI
- Environmental temperature monitoring and control
- Power-up mode control for recovery from AC power loss
- System overheat LED and control
- System resource alert
- Hardware BIOS virus protection
- Auto-switching voltage regulator for the CPU core

### **ACPI Features**

- Microsoft OnNow
- Slow blinking LED for suspend state indicator
- BIOS support for USB keyboard
- Main switch override mechanism
- Internal/external modem ring-on

### **Onboard I/O**

- 2 ATA100/66 EIDE Channels for a total of 4 IDE devices backward compatible
- Intel 6300ESB (Hance Rapids) SATA Controller with support of 2 On-chip SATA ports
- Marvell 88SX5040 SATA Controller with support of 4 SATA ports (\*P4SCT+/P4SCT+II only)
- 1 floppy port interface (up to 2.88 MB)
- 2 Fast UART 16550 compatible serial ports/headers
- Intel 82541 and 82547 (\*82541:P4SCT+/P4SCT+II only) Gigabit Ethernet Controllers
- 1 EPP (Enhanced Parallel Port) and ECP (Extended Capabilities Port) supported parallel port
- PS/2 mouse and PS/2 keyboard ports
- Up to 4 USB (Universal Serial Bus) 2.0 ports for a speed of up to 480Mbps ◆ *Latest USB 2.0 technology!*
- 1 infrared port
- 1 VGA Connector

### **Other**

- Hyper-threading enabled
- Wake-on-LAN (WOL)
- Wake-on-Ring (WOR)
- Multiple CPU clock frequency ratio selections (set in BIOS)
- Suspend-to-RAM
- CPU Thermal Trip support for Processor Protection

### **CD Utilities**

- BIOS flash upgrade utility
- Drivers and software for Intel Canterwood(\*P4SCT/P4SCT+II), Canterwood-ES(\*P4SCT+) chipset utilities

### **Dimensions**

- ATX form factor, 12" x 9.5" (305 x 241.3 mm)

## 1-2 Chipset Overview: Intel's Canterwood(875P) and Canterwood ES (E7210)

Intel's Canterwood Chipset (875P) and Canterwood ES (E7210) contains the following main components: Canterwood Memory Controller Hub (MCH) and the I/O Controller Hub (6300ESB-Hance Rapids ICH). These two components are interconnected via Hub Interface.

### Memory Controller Hub (MCH)

The Canterwood Memory Controller Hub (MCH) is designed to support Intel PGA 478-pin Processors. The function of the Canterwood MCH is to arbitrate the flow of data transfer between system bus (FSB), system memory, and Hub Interface. The Canterwood MCH supports 800 MHz FSB, 400/333 Memory Interface, 533 MHz FSB, 333/266 Memory Interface, and 400 MHz FSB 266 MHz Memory Interface.

### System Memory Interface

The Canterwood Memory Controller (MCH) supports two 64-bit wide DDR data channels with bandwidth up to 6.4 GB/s (DDR400) in dual channel mode. It supports 128-Mb, 256-Mb, 512-Mb, x8, X16 DDR. Maximum system memory supports up to 4.0 GB for Dual-Channel. ECC/Non ECC unbuffered DDR DIMMs are supported, but it does not support registered, mixed-mode DIMMs.

### Hance Rapids (6300ESB) ICH System Features

In addition to providing the I/O subsystem with access to the rest of the system, the 6300ESB (Hance Rapids) I/O Controller Hub (Hance Rapids ICH) integrates many I/O functions.

The 6300ESB (Hance Rapids) integrates: 2-channel Ultra ATA/100 Bus Master IDE Controller, two Serial ATA (SATA) Host Controllers, SMBus 2.0 Controller, LPC/Flash BIOS Interface, PCI-X (66MHz) 1.0 Interface, PCI 2.2 Interface and System Management Controller.

### \*Notes:

**Intel 875P Canterwood (\*P4SCT/P4SCT+II)**

**Intel E7210 Canterwood ES (\*P4SCT+)**

## **Marvell's 88SX5041 Host Controller (\*For the P4SCT+/P4SCT+II only)**

The Marvell 88SX5080 device is a PCI/PCI-X to Serial ATA (SATA) host controller with expansion ROM interface. Based upon the SATA interface specification, the 88SX5080 device provides solutions for designs based on chipsets that do not integrate a SATA host controller. With the expansion ROM interface, the 88SX5080 device enables the 88SX5080 add-in cards to boot from the host controller.

### **Serial ATA(SATA) Interface**

- 4-port 1.5 Gbps SATA
- Compliant with SATA rev. 1.0 specifications
- Compliant with ATA-6 specifications
- Up to 32 Outstanding commands
- Supports device 48-bit addressing
- Supports SATA Power Saving Mode
- Enhanced-DMA (EDMA) per SATA port
- Automatic command execution without host intervention
- With Hot-swap capability

### **64-bit PCI/PCI-X Interface**

- PCI 2.2 Compliant 32/64-bit bus, up to 66 MHz
- PCI-X Rev. 1.0 Compliant 32/64-bit bus, up to 66 MHz
- Supports 64-bit addressing via Dual Address Cycle (DAC) Transactions
- Compliant with PCI Power Management (PMG)

### **Features**

- Supports up to two outstanding delayed read transactions (PCI 2.2)
- Supports up to four split transactions (PCI-X)
- Supports UP TO 4 MB expansion ROM for add-in cards
- Serial EPROM initialization interface



## 1-3 PC Health Monitoring

This section describes the PC health monitoring features of the SUPER P4SCT/P4SCT+/P4SCT+II. The motherboard has an onboard System Hardware Monitor chip that supports PC health monitoring.

### **Eight Onboard Voltage Monitors for the CPU Core, +3.3V, +3.3V standby, +5V, +5V standby, Vbat and ±12V**

The onboard voltage monitor will scan these voltages continuously. Once a voltage becomes unstable, it will give a warning or send an error message to the screen, using Supermicro's Monitoring Software-Supero Doctor.

### **Fan Status Monitor with Firmware/Software On/Off Control**

The PC health monitor can check the RPM status of the cooling fans. The onboard 3-pin fans are controlled by the power management functions.

### **Environmental Temperature Control**

The P4SCT/P4SCT+/P4SCT+II has a CPU "thermal trip" feature. A thermal control sensor monitors the CPU temperature in real time and will send a signal to shut down the system whenever the CPU temperature exceeds a certain threshold. This works to protect the CPU from being damaged by overheating.

### **CPU Overheat LED and Control**

This feature is available when the user enables the CPU overheat warning function in the BIOS. This allows the user to define an overheat temperature. When this temperature is exceeded, the CPU thermal trip feature will activate and shut down the system.

### **Hardware BIOS Virus Protection**

The system BIOS is protected by hardware so that no virus can infect the BIOS area. The user can only change the BIOS content through the flash utility provided by Supermicro. This feature can prevent viruses from infecting the BIOS area and destroying valuable data.

### **Auto-Switching Voltage Regulator for the CPU Core**

The 4-phase-switching voltage regulator for the CPU core can support up to 60A current and auto-sense voltage IDs ranging from 1.1V to 1.85V. This will allow the regulator to run cooler and thus make the system more stable.

## 1-4 Power Configuration Settings

This section describes features of your motherboard that deal with power and power settings.

### **Microsoft OnNow**

The OnNow design initiative is a comprehensive, system-wide approach to system and device power control. OnNow is a term for a PC that is always on but appears to be off and responds immediately to user or other requests.

### **Slow Blinking LED for Suspend-State Indicator**

When the CPU goes into a suspend state, the chassis power LED will start blinking to indicate that the CPU is in suspend mode. When the user presses any key, the CPU will wake-up and the LED will automatically stop blinking and remain on.

### **BIOS Support for USB Keyboard**

If the USB keyboard is the only keyboard in the system, it keyboard will function like a normal keyboard during system boot-up.

### **Main Switch Override Mechanism**

When an ATX power supply is used, the power button can function as a system suspend button. When the user depresses the power button, the system will enter a SoftOff state. The monitor will be suspended and the hard drive will spin down. Depressing the power button again will cause the whole system to wake-up. During the SoftOff state, the ATX power supply provides power to keep the required circuitry in the system alive. In case the system malfunctions and you want to turn off the power, just depress and hold the power button for 4 seconds. The power will turn off and no power will be provided to the motherboard.

### **Wake-On-Ring (WOR) Header**

Wake-up events can be triggered by a device such as the external modem ringing when the system is in the SoftOff state. Note that external modem ring-on can only be used with an ATX 2.01 (or above) compliant power supply.

## Wake-On-LAN (WOR) Header

Wake-On-LAN is defined as the ability of a management application to remotely power up a computer that is powered off. Remote PC setup, updates and asset tracking can occur after hours and on weekends so that daily LAN traffic is kept to a minimum and users are not interrupted. The motherboards have a 3-pin header (WOL) to connect to the 3-pin header on a Network Interface Card (NIC) that has WOL capability. Note that Wake-On-Lan can only be used with an ATX 2.01 (or above) compliant power supply.

## 1-5 Power Supply

As with all computer products, a stable power source is necessary for proper and reliable operation. It is even more important for processors that have high CPU clock rates of 1.0 GHz and faster.

The SUPER P4SCT/P4SCT+/P4SCT+II accommodates 12V ATX power supplies. Although most power supplies generally meet the specifications required by the CPU, some are inadequate. Your power supply must supply 1 amp of 5V standby voltage.

It is strongly recommended that you use a high quality power supply that meets 12V ATX power supply Specification 1.1 or above. Additionally, in areas where noisy power transmission is present, you may choose to install a line filter to shield the computer from noise. It is recommended that you also install a power surge protector to help avoid problems caused by power surges.

It also provides two high-speed, 16550 compatible serial communication ports (UARTs), one of which supports serial infrared communication. Each UART includes a 16-byte send/receive FIFO, a programmable baud rate generator, complete modem control capability and a processor interrupt system. Both UARTs provide legacy speed with baud rate of up to 115.2 Kbps as well as an advanced speed with baud rates of 250 K, 500 K, or 1.0 Mb/s, which support higher speed modems.

The Super I/O provides functions that comply with ACPI (Advanced Configuration and Power Interface), which includes support of legacy and ACPI power management through a SMI or SCI function pin. It also features auto power management to reduce power consumption.

The IRQs, DMAs and I/O space resources of the Super I/O can be flexibly adjusted to meet ISA PnP requirements, which support ACPI and APM (Advanced Power Management).

**(\*Warning: Do not use a wrong type of onboard CMOS battery or install the CMOS battery upside down to avoid possible explosion.)**

---

## 1-6 Super I/O

The disk drive adapter functions of the Super I/O chip include a floppy disk drive controller that is compatible with industry standard 82077/765, a data separator, write pre-compensation circuitry, decode logic, data rate selection, a clock generator, drive interface control logic and interrupt and DMA logic. The wide range of functions integrated onto the Super I/O greatly reduces the number of components required for interfacing with floppy disk drives. The Super I/O supports four 360 K, 720 K, 1.2 M, 1.44 M or 2.88 M disk drives and data transfer rates of 250 Kb/s, 500 Kb/s or 1.0 Mb/s.

## Chapter 2 Installation

### 2-1 Static-Sensitive Devices

Electric Static Discharge (ESD) can damage electronic components. To prevent damage to your system board, it is important to handle it very carefully. The following measures are generally sufficient to protect your equipment from ESD.

#### Precautions

- Use a grounded wrist strap designed to prevent static discharge.
- Touch a grounded metal object before removing the board from the anti-static bag.
- Handle the board by its edges only; do not touch its components, peripheral chips, memory modules or gold contacts.
- When handling chips or modules, avoid touching their pins.
- Put the motherboard and peripherals back into their antistatic bags when not in use.
- For grounding purposes, make sure your computer chassis provides excellent conductivity between the power supply, the case, the mounting fasteners and the motherboard.

**(\*Warning: Do not use a wrong type of on board CMOS battery or install the battery upside down to avoid possible explosion.)**

#### Unpacking

The motherboard is shipped in antistatic packaging to avoid static damage. When unpacking the board, make sure the person handling it is static protected.

#### Installation Procedures

Follow the procedures as listed below for full installation of the motherboard into a chassis:

1. Install the processor and the heatsink to the motherboard.
2. Install the motherboard in the chassis.
3. Install the memory and add-on cards.
4. Finally, connect the cables and install the drivers.

## 2-2 Processor and Heatsink Fan Installation



*When handling the processor package, avoid placing direct pressure on the label area of the fan.*

**IMPORTANT:** Always connect the power cord last and always remove it before adding, removing or changing any hardware components. Make sure that you install the processor into the CPU socket before you install the CPU heatsink.

### Installation of the Processor and Heatsink

1. Locate the following components, which are included in the shipping package.

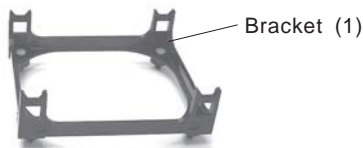

If you buy a boxed Intel Pentium 4 478 processor, it should include a heatsink, fan and retention mechanism. If you buy a processor separately, use only a Supermicro or Intel certified heatsink and fan.

2. Insert the white pegs into the black anchors. Do not force the white pegs all the way in - about 1/3 of the white pegs should be inside the black anchors. (These are for chassis that do not have four CPU retention holes.)



Bracket in position

3. Place a retention bracket in the proper position and secure it by pressing two pegs into the retention holes until you hear a \*click\*. The clicking sound indicates that the peg is locked and secured.

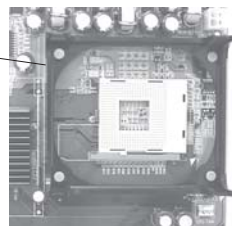

4. Secure the other retention bracket into position by repeating Step 3.

5. Lift the lever on the CPU socket.

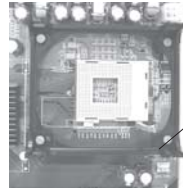

Socket Lever

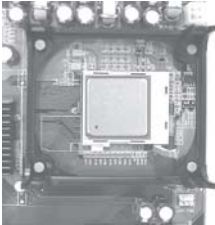

6. Install the CPU in the socket. Make sure that Pin 1 of the CPU is seated on Pin 1 of the socket (both corners are marked with a triangle).

7. Press the lever down until you hear it \*click\* into the locked position.

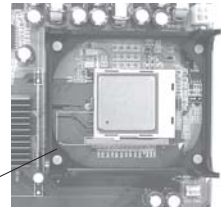

Socket lever in locked position

8. Apply the proper amount of thermal compound to the CPU die.

9. Place the heatsink on top of the CPU and press firmly downward - do not twist or slide the heatsink to seat thermal compound.

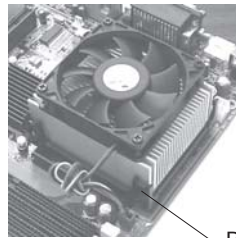

Retainer clip attachment point

10. Secure the heat sink by locking the retention clips into their proper position.

11. Connect the CPU fan cable to the CPU Fan header on the motherboard.

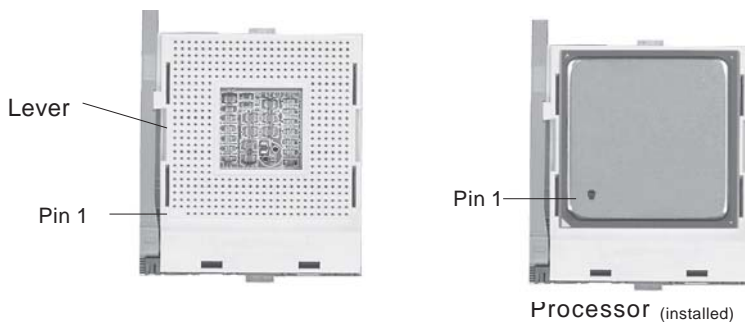

**Figure 2-1. 478-pin mPGA Socket: Empty and with Processor Installed**

## 2-3 Mounting the Motherboard in the Chassis

All motherboards have standard mounting holes to fit different types of chassis. Make sure the location of all the mounting holes for both the motherboard and the chassis match. Although a chassis may have both plastic and metal mounting fasteners, metal ones are highly recommended because they ground the motherboard to the chassis. Make sure the metal standoffs click in or are screwed in tightly. Then use a screwdriver to secure the motherboard onto the motherboard tray. (\*Note: Some components are very close to the mounting holes. All precautionary measures shall be taken to prevent damage done to these components when installing the motherboard into the chassis.)

## 2-4 Installing DDR Memory

---

### **CAUTION**

Exercise extreme care when installing or removing memory modules to prevent any possible damage.

---

### **Memory Module Installation (See Figure 2-2)**

1. Insert each DDR memory module vertically into its slot. Pay attention to the notch along the bottom of the module to prevent inserting the module incorrectly. (See support information below.)
2. Gently press down on the memory module until it snaps into place.



## Support

The P4SCT/P4SCT+/P4SCT+II supports Dual channel, ECC/non-ECC, unbuffered DDR-400/333/266 SDRAM. (Populate DIMM0A, DIMM1A and/ or DIMM0B, DIMM1B with memory modules of the same size/same type will result in the dual channel, two-way interleaved memory which is faster than the single channel memory.)

(\*Note: The Canterwood chip supports non-ECC or ECC memory. If ECC memory is installed, the ECC bits need to be initialized via BIOS before normal operation. For a 4 GB-Memory and 2.4-GHz P4 system, it will take about 65 seconds for all the ECC bits to be initialized before any video displays. Since ECC initialization takes time, the Watch Dog Timer Select needs to be set to a time longer than what the ECC initialization will take.)

Memory Speeds			
Host Clock (MHz)	FSB (MHz)	DRAM DATA RATE (MT/s)	Shown during POST
100	400	266	DDR266
		333	DDR266
		400	DDR266
133	533	266	DDR266
		333	DDR333
		400	DDR333
200	800	266	DDR266
		333	DDR320 (*Note)
		400	DDR400

(\*Note: The BIOS will display 320 due to the limitation of Intel's chipset).

**Figure 2-2. Side and Top Views of DDR Module Installation into Slot**

### To Install:

Insert module vertically and press down until it snaps into place. Pay attention to the notch.

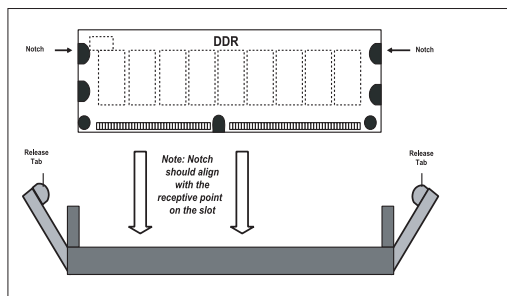

### To Remove:

Use your thumbs gently to push each release tab outward to release the DIMM from the slot.

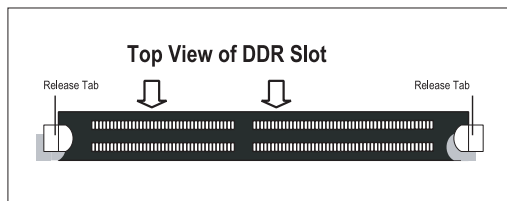

## 2-5 I/O Port/Control Panel Connector Locations

The I/O ports are color coded in conformance with the PC99 specification to make setting up your system easier. See Figure 2-3 below for the colors and locations of the various IO ports.

**Figure 2-3. I/O Port Locations and Definitions**

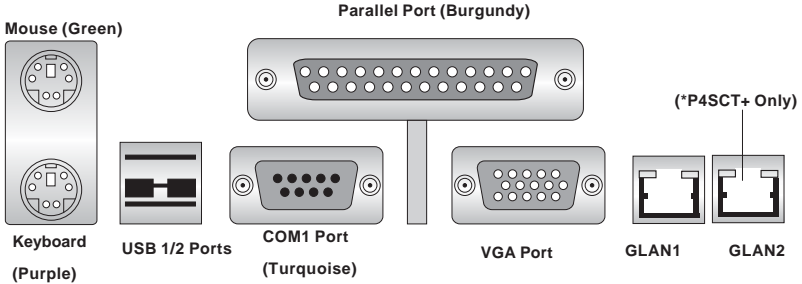

### Front Control Panel

JF1 contains header pins for various front control panel connectors. See Figure 2-4 for the pin definitions of the various connectors including the speaker. Refer to Section 2-6 for details.

**Figure 2-4. Front Control Panel Connectors**

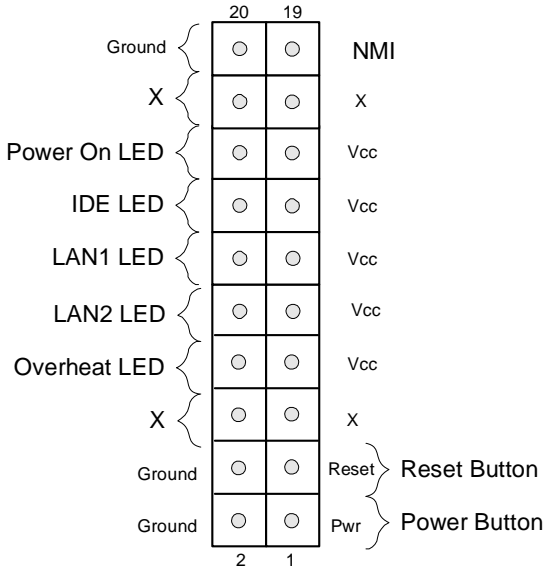

## 2-6 Connecting Cables

### Power Supply Connectors

The primary power supply connector (J20) on the P4SCT/P4SCT+/P4SCT+II meets the SSI (Superset ATX) 24-pin specification. Refer to the table on the right for the pin definitions of the ATX 20-pin power connector. You must also connect the 4-pin (J21) processor power connector to your power supply. Refer to the table below right for the J21 (12V) connector. (\*You must use J21 for CPU Power.)

### PW\_ON Connector

The PW\_ON connector is located on pins 1 and 2 of JF1.

ATX Power Supply 24-pin Connector  
Pin Definitions (J20)

Pin Number	Definition	Pin Number	Definition
13	+3.3V	1	+3.3V
14	-12V	2	+3.3V
15	COM	3	COM
16	PS_ON#	4	+5V
17	COM	5	COM
18	COM	6	+5V
19	COM	7	COM
20	Res(NC)	8	PWR_OK
21	+5V	9	5VSB
22	+5V	10	+12V
23	+5V	11	+12V
24	COM	12	+3.3V

+12V 4-pin  
Connector  
(J21)

**Required  
Connection**

Pins #	Definition
1 & 2	Ground
3 & 4	+12 V

PW\_ON  
Pin Definitions  
(JF1)

Pin Number	Definition
1	PW_ON
2	+3V

### A. 24-pin PWR Connector

### B. 4-pin PWR Connector

### C. PWR On Connector

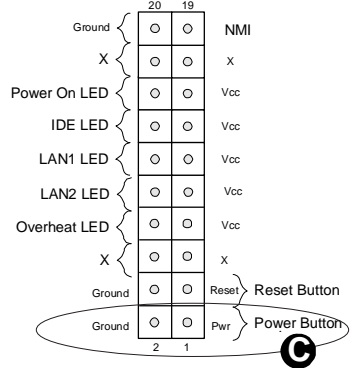
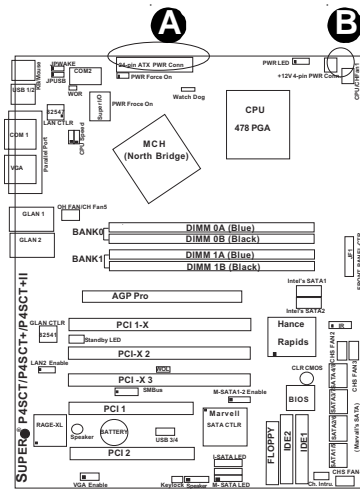

### Reset Connector

The reset connector is located on pins 3 and 4 of JF1. This connector attaches to the reset switch on the computer chassis. See the table on the right for pin definitions.

#### Reset Pin Definitions (JF1)

Pin Number	Definition
3	Reset
4	Ground

### Overheat LED (OH)

Connect an LED to the OH connection on pins 7 and 8 of JF1 to provide advanced warning of chassis overheating. Refer to the table on the right for pin definitions.

#### Overheat (OH) LED Pin Definitions (JF1)

Pin Number	Definition
7	Vcc
8	GND

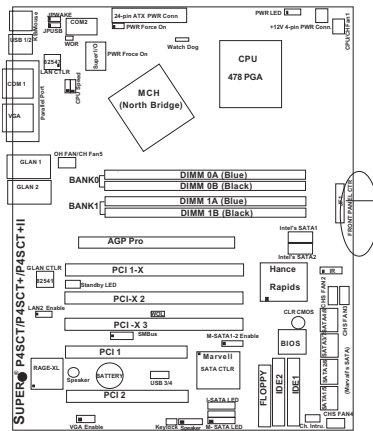

#### A. Reset Button

#### B. Overheat Button

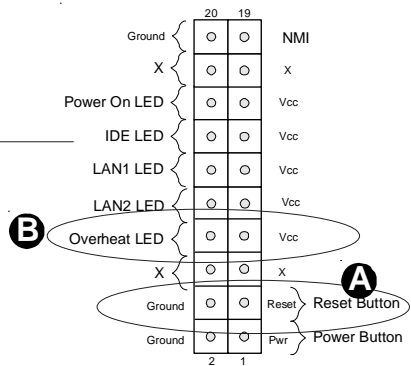

### GLAN1 LED

The GLAN1 (Gigabit LAN) LED connection is located on pins 11 and 12 of JF1. Attach the LAN1 LED cable to display Gigabit LAN 1 activity. Refer to the table on the right for pin definitions.

#### GLAN1 LED Pin Definitions (JF1)

Pin Number	Definition
11	Vcc
12	GND

### GLAN2 LED(\*P4SCT+/ P4SCT+II Only)

The GLAN2 LED connection is located on pins 9 and 10 of JF1. Attach the GLAN2 LED cable to display Gigabit LAN 2 activity. Refer to the table on the right for pin definitions.

#### GLAN2 LED (\*P4SCT+/ P4SCT+II) Pin Definitions (JF1)

Pin Number	Definition
9	Vcc
10	GND

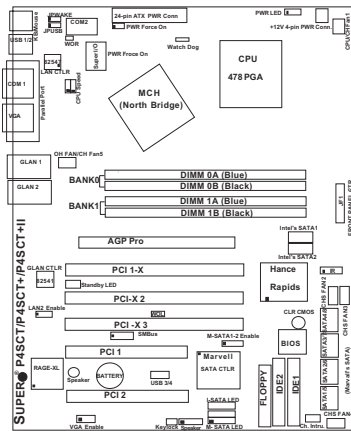

#### A. GLAN1 LED

#### B. GLAN2 LED

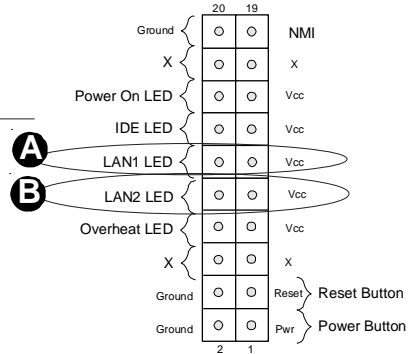

**\*IDE LED** (\*See the note below)

The IDE LED is located on pins 13, 14 of JF1. This connects to the hard drive LED to display all IDE and SATA activities. See the table on the right for pin definitions.

(\*Note: This LED is for all IDE and SATA devices)

**Power\_LED Connector**

The Power LED connector is located on pins 15, 16 of JF1. (\*Use J17 for a 3-pin connector.) This connection is used to provide LED indication of power being supplied to the system. See the table on the right for pin definitions.

**IDE Pin Definition**

Pin Number	Definition
7	+5V
8	HD Active

**J17**

**Pin Definitions**

Pin Number	Definition
1	+5V
2	Key
3	Ground

**Power\_LED Pin Definitions (JF1)**

Pin Number	Definition
15	+5V
16	Ground

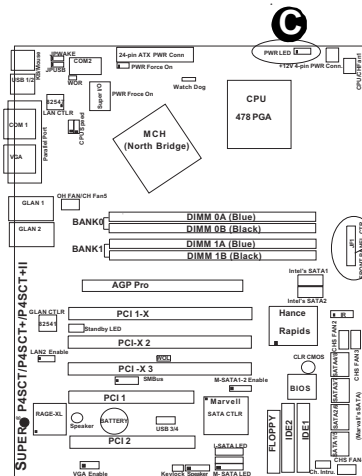

**A. IDE LED**

**B. PWR On LED**

**C. PWR LED Connector**

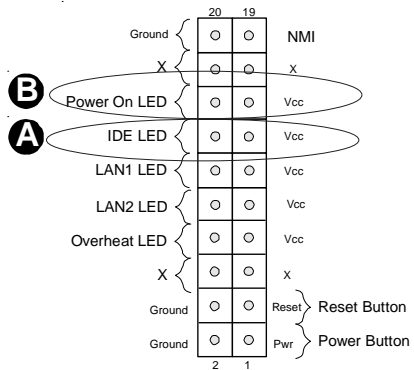

### NMI Button

The non-maskable interrupt button header is located on pins 19 and 20 of JF1. Refer to the table on the right for pin definitions.

**NMI Button Pin Definitions (JF1)**

Pin Number	Definition
19	Ground
20	Control

### Speaker Connector

The speaker connector is located on J18. See the table on the right for pin definitions.

**Speaker: Pin Definition**

Function	Pin Definition
Pins 1, 4	External Speaker
Pins 3, 4	Internal Speaker

### IR Connector

The infrared connector is located on J16. See the table on the right for pin definitions. See the Technical Support section of our web page for information on the infrared devices you can connect to the system.

**Infrared Pin Definitions (J16)**

Pin Number	Definition
1	+5V
2	CIRRX
3	IRRX
4	Ground
5	IRTX
6	NC

**A. NMI Button**

**B. Speaker Connector**

**C. IR Connector**

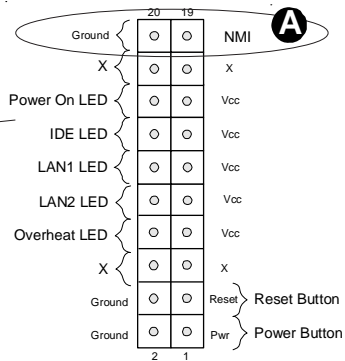
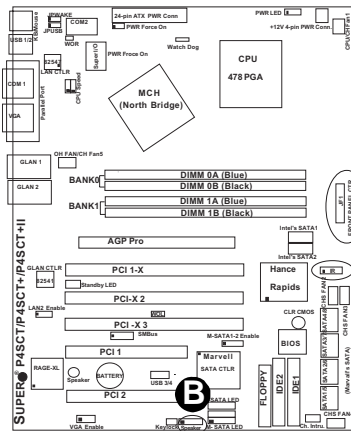

### Serial Ports

Two serial ports are included on the motherboard: COM1(J9) is a port located beside the mouse/keyboard ports and COM2(J10) is a header located on the motherboard near J20 (Power Connector). See the table on the right for pin definitions.

\*NC indicates no connection.

**Serial Port Pin Definitions (COM1, COM2)**

Pin Number	Definition	Pin Number	Definition
1	CD	6	DSR
2	RD	7	RTS
3	TD	8	CTS
4	DTR	9	RI
5	Ground	10	NC

**Note:** Pin 10 is included on the header but not on the port.

### Fan Headers

There are six fan headers on the P4SCT/P4SCT+/P4SCT+II, which are designated CPU/Chassis Fan1, CH Fan 2, CH Fan 3, CH Fan 4, and Over Heat Fan/CH Fan 5. (Chassis Fan 4 and Chassis Fan 5 are not monitored by BIOS.) Connect the fan on your CPU heatsink to the CPU/CH Fan1 header. See the table on the right for pin definitions.

**Fan Header Pin Definitions (CPU, Chassis and Overheat)**

Pin Number	Definition
1	Ground (black)
2	+12V (red)
3	Tachometer

Caution: These fan headers are DC power.

- A. CPU/CH Fan 1**
- B. CH Fan 2**
- C. CH Fan 3**
- D. CH Fan 4**
- E. OH/CH Fan 5**
- F. COM Port 1**
- G. COM Port 2**

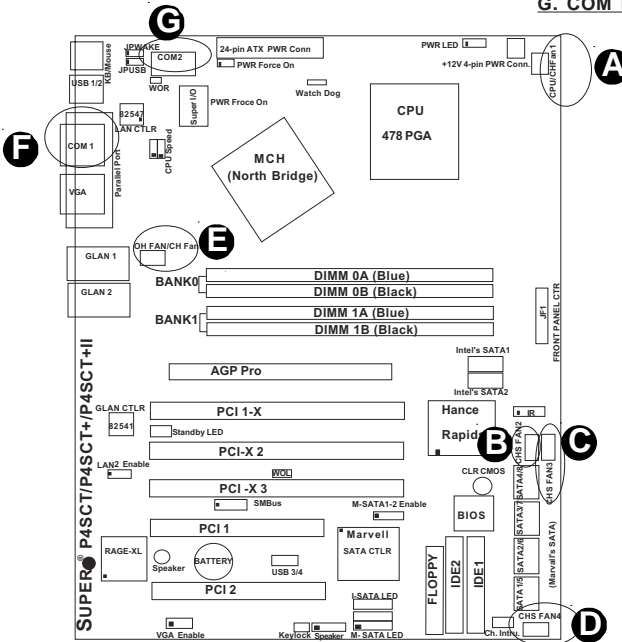



## Chassis Intrusion

The Chassis Intrusion header is designated JL1. See the board layout in Chapter 1 for the location of JL1 and the table on the right for pin definitions.

**Chassis Intrusion  
Pin Definitions (JL1)**

Pin Number	Definition
1	Intrusion Input
2	Ground

## Wake-On-LAN

The Wake-On-LAN header is designated WOL on the motherboard. See the table on the right for pin definitions. You must enable the LAN Wake-Up setting in BIOS to use this function. (You must also have a LAN card with a Wake-On-LAN connector and cable to use this feature.)

**Wake-On-LAN Pin  
Definitions (WOL)**

Pin Number	Definition
1	+5V Standby
2	Ground
3	Wake-up

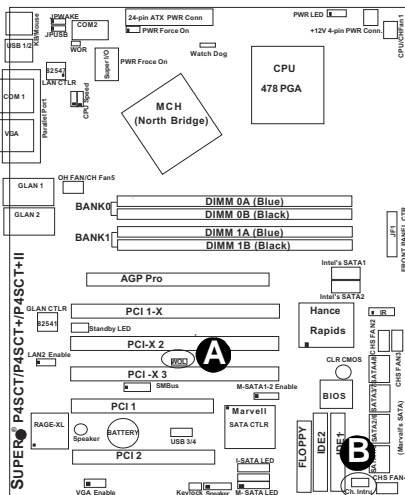

### A. Wake-On-LAN

### B. Chassis Intrusion

## Ethernet Ports GLAN1 and GLAN2 (\*P4SCT/P4SCT+II only)



Two Ethernet ports (designated GLAN1 and GLAN2) are located beside the VGA port on the IO backplane. These ports accept RJ45 type cables.

## VGA Connector

A VGA connector (JG1) is located next to the GLAN1 on the IO backplane. Refer to the board layout below for the location.

## SMB Header

A System Management Bus header is located at J15. Connect the appropriate cable here to utilize SMB on your system.

**SMB Header  
Pin Definitions (J15)**

Pin Number	Definition
1	Data
2	Ground
3	Clock
4	No Connection

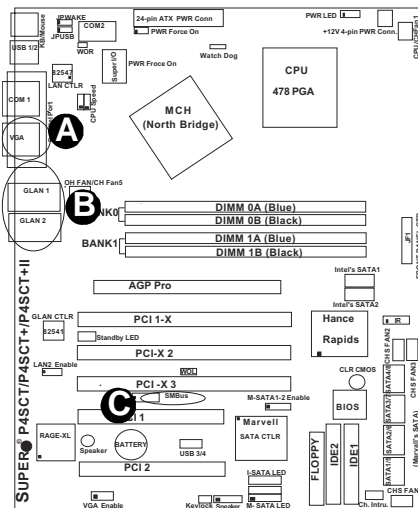

- A. VGA Header**
- B. GLAN1 & GLAN2**
- C. SMB Header**

## ATX PS/2 Keyboard and PS/2 Mouse Ports

The ATX PS/2 keyboard and the PS/2 mouse are located on J11. See the table on the right for pin definitions. (The mouse port is above the keyboard port. See the table on the right for pin definitions.

**PS/2 Keyboard and Mouse Port Pin Definitions (J11)**

Pin Number	Definition
1	Data
2	NC
3	Ground
4	VCC
5	Clock
6	NC

## Universal Serial Bus (USB)

There are two Universal Serial Bus Connectors (USB 1/2: J12/J13) located on the I/O panel and additional two USB headers are located on the motherboard. These ports, labeled USB3/4, can be used to provide front side chassis access (cables not included). See the tables on the right (below) for pin definitions.

**USB Pin Definition**

**USB 1/2 (J12/J13)**

Pin#	Definition
1	+5V
2	PO-
3	PO+
4	Ground

**USB 3/4**

Pin Number	Definition	Pin Number	Definition
1	+5V	2	+5V
3	PO-	4	PO-
5	PO+	6	PO+
7	Ground	8	Ground
		10	Ground

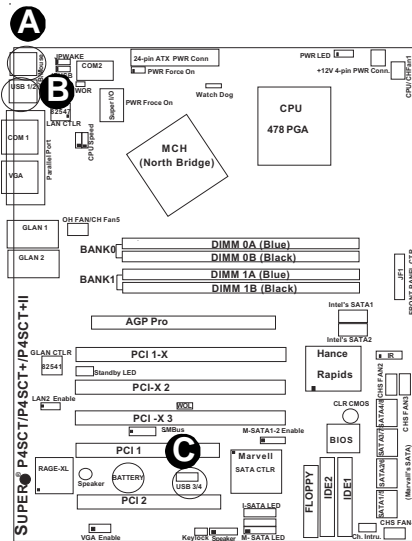

**A. Keyboard/Mouse**

**B. USB 1/2**

**C. USB 3/4**

## Wake-On-Ring

The Wake-On-Ring header is designated WOR. This function allows your computer to receive and be "awakened" by an incoming call when in the suspend state. See the table on the right for pin definitions. You must also have a WOR card and cable to use WOR.

**Wake-On-Ring Pin Definitions (WOR)**

Pin Number	Definition
1	Ground
2	Wake-up

## Keylock Enable/Disable

The Keylock header is located on J36. Close Pin 1 and Pin 2 of J36 to enable the function of Keylock. The default setting is "Open". See the table on the right for pin definitions.

**Keylock Enabled/Disabled (J36) Pin Definitions**

Pin Definitions	Function
1 & 2 (closed)	Enabled
1 & 2 (Open)	Disabled

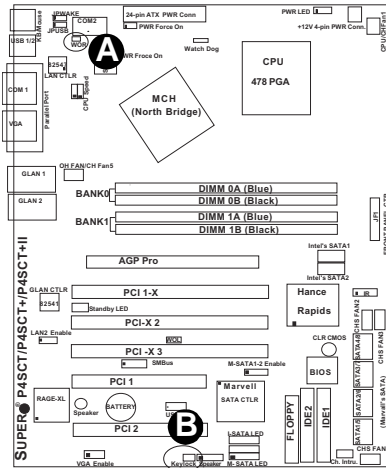

**A. Wake-On Ring**

**B. Keylock Enable**

## Intel's SATA LED

The header for Intel's SATA LED is located on J37. This header will display all Intel's SATA activities. See the table on the right for pin definitions.

**Intel's SATA LED Pin Definitions (J37)**

Pin Number	Definition
1	(I-)SATA1
2	(I-)SATA2
3	NC
4	NC
5	NC

## Marvell's SATA LED (\*P4SCT+/ P4SCT+II Only)

The header for Marvell's SATA LED is located on JS9. This header will display all Marvell's SATA activities. See the table on the right for pin definitions.

**Marvell's SATA Pin Definitions (JS9)**

Pin Number	Definition	Pin Number	Definition
1	(M-)SATA1	6	NC
2	(M-)SATA2	7	NC
3	(M-)SATA3	8	NC
4	(M-)SATA4	9	NC
5	(M-)SATA LED Comm	10	Key

## Standby Power LED

The Standby Power LED Indicator is located on LE2. When the Standby PWR LED is on, it indicates the system standby power is on.

### A. Standby PWR LED

### B. Intel SATA LED

### C. Marvell SATA LED

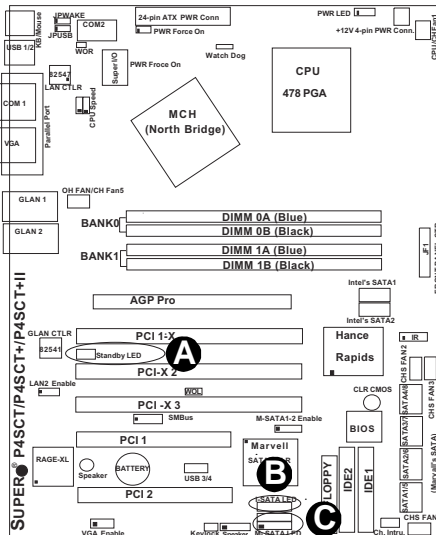

## 2-7 Jumper Settings

### Explanation of Jumpers

To modify the operation of the motherboard, jumpers can be used to choose between optional settings. Jumpers create shorts between two pins to change the function of the connector. Pin 1 is identified with a square solder pad on the printed circuit board. See the motherboard layout pages for jumper locations.

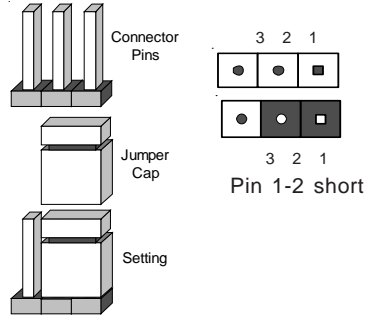

**Note:** On a two-pin jumper, "Closed" means the jumper is on both pins and "Open" means the jumper is either on only one pin or completely removed.

### CMOS Clear

JBT1 is not actually a jumper but consists of two contact pads. To clear the contents of CMOS, short these pads together by touching them both with a metal conductor such as the head of a small screwdriver. **Note:** for ATX power supplies, you must completely shut down the system and remove the AC power cord before clearing CMOS.

#### A. Clear CMOS

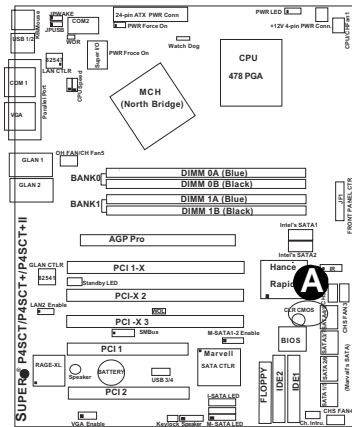

### Marvell's SATA Enable (\*P4SCT+/P4SCT+II Only)

JPS1 is used to enable or disable Marvell's Serial ATA Controller. See the table on right for pin definitions. Intel's Serial ATA Controller is enabled or disabled via the BIOS.

Marvell's SATA Enable Jumper Settings (JPS1)  
(P4SCT+/P4SCT+II Only)

Jumper	
Position	Definition
1-2	Enabled
2-3	Disabled

### USB Wake-Up (\*USB1/2 Only)

Use JPUSB1 to enable or disable USB Wake-Up, which allows you to wakeup the system by depressing a key on the keyboard or by clicking the mouse when either is connected to the USB1 or USB2 port. Enable the jumper a to allow the system to be woken up from S1 and S3 in Windows OS. See the table on the right for jumper settings.

USB Wake-Up Jumper Settings (JPUSB1)

Jumper	
Position	Definition
1-2	VCC5V
2-3	VCC5V Standby

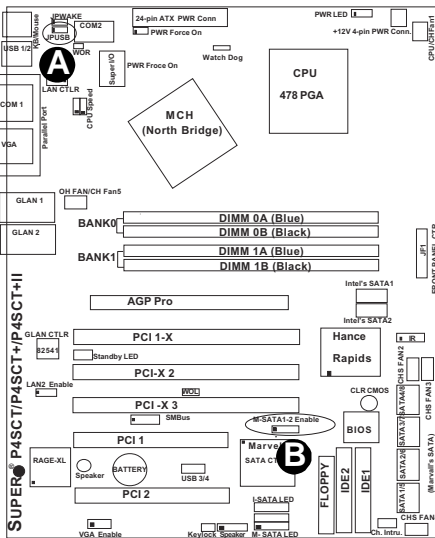

- A. USB Wake-Up**
- B. Marvell SATA Enable**

## Watch Dog Enable/Disable

JP8 enables the Watch Dog function. Watch Dog is a system monitor that can reboot the system when a software application is "hung up". Pins 1-2 will cause WD to reset the system if an application is "hung up". Pins 2-3 will generate a non-maskable interrupt signal for the application that is "hung up". See the table on the right for jumper settings. Watch Dog can also be enabled via BIOS. (\*Note, when enabled, the user needs to write his own application software in order to disable the Watch Dog Timer.)

### Watch Dog Jumper Settings (JP8)

Jumper Position	Definition
Pins 1-2	WD to Reset
Pins 2-3	WD to NMI
Open	Disabled

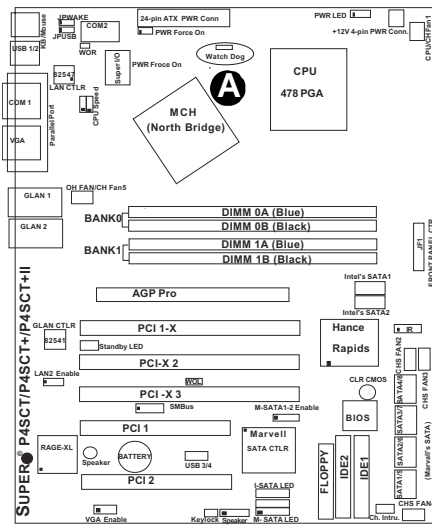

**A. Watch Dog Enable**



## Keyboard Wake-Up

The JPWAKE jumper is used to allow the system to be woken up by depressing a key on the keyboard from S1 or S3 in Windows OS. See the table on the right for jumper settings. Your power supply must meet ATX specification 2.01 or higher and supply 720 mA of standby power to use this feature.

Keyboard Wake-Up  
Jumper Settings (JPWAKE)

Jumper Position	Definition
1-2	VCC5V
2-3	VCC5V Standby

## GLAN2 Enable/Disable (\*P4SCT+/P4SCT+ only)

Change the setting of jumper JPL2 to enable or disable the onboard LAN on the motherboard. See the table on the right for jumper settings. The default setting is Enabled. (For LAN1, please change the setting in the BIOS.)

LAN  
Enable/Disable  
Jumper Settings  
(JPL2-\*P4SCT+)

Jumper Position	Definition
Pins 1-2	Enabled
Pins 2-3	Disabled

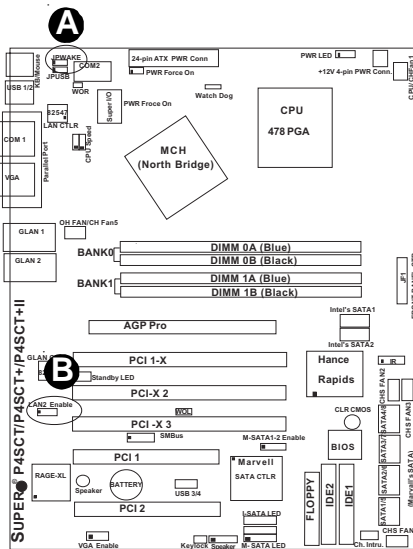

### A. Keyboard Wake-UP Enable

### B. GLAN Enable

### VGA Enable/Disable

J33 allows you to enable or disable the VGA port. The default position is on pins 1 and 2 to enable VGA. See the table on the right for jumper settings.

VGA Enable/Disable Jumper Settings (J33)

Jumper Position	Definition
1-2	Enabled
2-3	Disabled

### Front Side Bus Speed

JP1, JP2 are used to set the system (front side) bus speed for the processors. It is best to keep this jumper set to Auto. This jumper is used together with the CPU Clock setting in BIOS. See the table on the right for jumper settings.

	JP1	JP2
Auto	1-2	1-2
100 MHz (x4)	2-3	2-3
133 MHz (x4)	NC	2-3
Reserved	NC	NC
200 MHz (x4)	2-3	NC

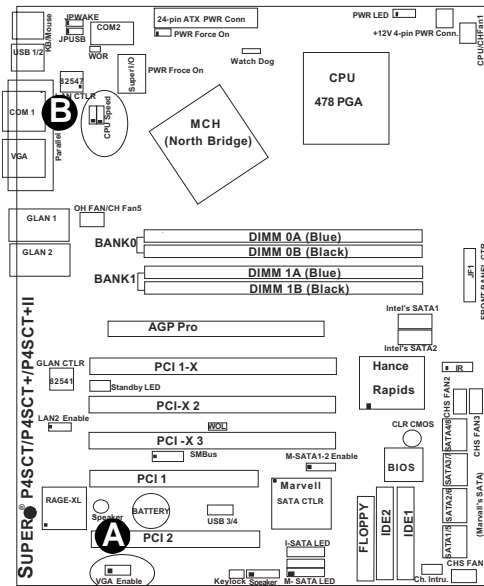

- A. VGA Enable**
- B. CPU Speed**

## 2-8 Parallel Port, Floppy Drive, Hard Drive and AGP Connections

Use the following information to connect the floppy and hard disk drive cables.

- The floppy disk drive cable has seven twisted wires.
- A red mark on a wire typically designates the location of pin 1.
- A single floppy disk drive ribbon cable has 34 wires and two connectors to provide for two floppy disk drives. The connector with twisted wires always connects to drive A, and the connector that does not have twisted wires always connects to drive B.
- The 80-wire ATA100/66 IDE hard disk drive cable that came with your system has two connectors to support two drives. This special cable should be used to take advantage of the speed this new technology offers. The blue connector connects to the onboard IDE connector interface and the other connector(s) to your hard drive(s). Consult the documentation that came with your disk drive for details on actual jumper locations and settings for the hard disk drive.

### Parallel Port Connector

The parallel port is located on J8. Refer to Figure 2-3 for location. See the table on the right for pin definitions.

Parallel (Printer) Port Pin Definitions (J8)

Pin Number	Function	Pin Number	Function
1	Strobe-	2	Auto Feed-
3	Data Bit 0	4	Error-
5	Data Bit 1	6	Init-
7	Data Bit 2	8	SLCT IN-
9	Data Bit 3	10	GND
11	Data Bit 4	12	GND
13	Data Bit 5	14	GND
15	Data Bit 6	16	GND
17	Data Bit 7	18	GND
19	ACK	20	GND
21	BUSY	22	GND
23	PE	24	GND
25	SLCT	26	NC

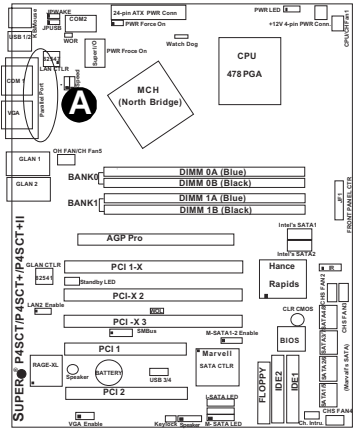

### A. Parallel Port

## Floppy Connector

The floppy connector is located on J7. Refer to Figure 2-3 for location. See the table on the right for pin definitions.

Floppy Connector Pin Definitions (J7)

Pin Number	Function	Pin Number	Function
1	GND	2	FDHDIN
3	GND	4	Reserved
5	Key	6	FDEDIN
7	GND	8	Index
9	GND	10	Motor Enable
11	GND	12	Drive Select B-
13	GND	14	Drive Select A-
15	GND	16	Motor Enable
17	GND	18	DIR-
19	GND	20	STEP-
21	GND	22	Write Data-
23	GND	24	Write Gate-
25	GND	26	Track 00-
27	GND	28	Write Protect-
29	GND	30	Read Data-
31	GND	32	Side 1 Select-
33	GND	34	Diskette

## IDE Connectors

You do not need to configure the onboard IDE interfaces (- Pins 13,14 of JF1.) Refer to Figure 2-3 for location. See the table on the left for pin definitions. **Note:** You must use the ATA100/66 cable included with your system to benefit from the ATA100/66 technology.

IDE Connector Pin Definitions (J2, J5)

Pin Number	Function	Pin Number	Function
1	Reset IDE	2	GND
3	Host Data 7	4	Host Data 8
5	Host Data 6	6	Host Data 9
7	Host Data 5	8	Host Data 10
9	Host Data 4	10	Host Data 11
11	Host Data 3	12	Host Data 12
13	Host Data 2	14	Host Data 13
15	Host Data 1	16	Host Data 14
17	Host Data 0	18	Host Data 15
19	GND	20	Key
21	DRQ3	22	GND
23	I/O Write-	24	GND
25	I/O Read-	26	GND
27	IOCHRDY	28	BALE
29	DACK3-	30	GND
31	IRQ14	32	IOCS16-
33	Addr 1	34	GND
35	Addr 0	36	Addr 2
37	Chip Select 0	38	Chip Select 1-
39	Activity	40	GND

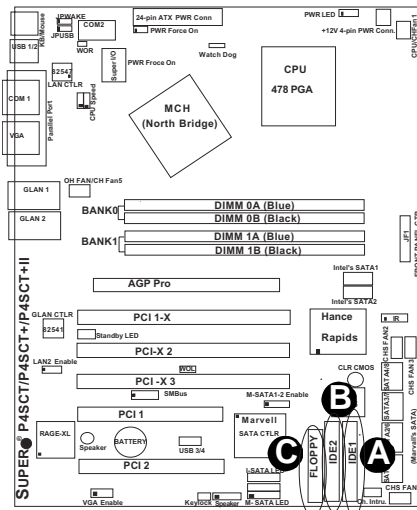

- A. IDE 1 Connector**
- B. IDE 1 Connector**
- C. Floppy**

## 1.5V 8xAGP Pro Slot (\*P4SCT/P4ST+II)

The P4SCT/P4SCT+/P4SCT+II includes an 8xAGP Pro slot for high-performance video cards. It is backward compatible with 4xAGP and 2xAGP graphics cards. To install a VGA card, power down the system and remove the I/O shield corresponding to the AGP Pro slot. Push the AGP card down and make sure that the golden finger does not show. Then, screw the AGP card onto the board. Replace all chassis covers before restoring power to the system.

Figure 2-5. 8xAGP Pro Slot

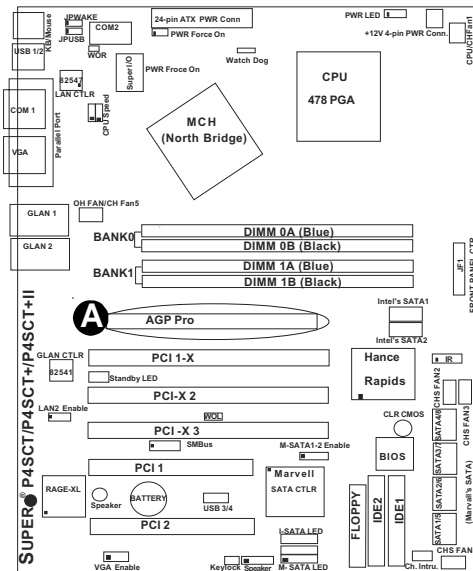

### A. AGP Slot

**Notes**

---

## Chapter 3

# Troubleshooting

### 3-1 Troubleshooting Procedures

Use the following procedures to troubleshoot your system. If you have followed all of the procedures below and still need assistance, refer to the 'Technical Support Procedures' and/or refer to the section regarding 'Returning Merchandise for Service' in this chapter. Always disconnect the AC power cord before adding, changing or installing any hardware components.

#### Before Power On

1. Check that the +5v standby LED is not lit (LE2 on motherboard).
2. Make sure the 4-pin 12v power connector at J21 is connected to your power supply.
3. Make sure no short circuits exist between the motherboard and chassis.
4. Disconnect all ribbon/wire cables from the motherboard, including those for the keyboard and mouse.
5. Remove all add-on cards.
6. Install a CPU and heatsink (making sure it is fully seated) and connect the chassis speaker and the power LED to the motherboard. Check all jumper settings as well.

#### No Power

1. Make sure no short circuits exist between the motherboard and the chassis.
2. Verify that all jumpers are set to their default positions.
3. Check that the 115V/230V switch on the power supply is properly set.
4. Turn the power switch on and off to test the system.
5. The battery on your motherboard may be old. Check to verify that it still supplies ~3VDC. If it does not, replace it with a new one.

**\*Warning: Do not use a wrong type of onboard CMOS battery or install the battery upside down to avoid possible explosion.**

#### No Video

1. If the power is on but you have no video, remove all the add-on cards and cables.
2. Use the speaker to determine if any beep codes exist. Refer to Appendix A for details on beep codes.
3. There is no video display if the process of ECC Memory initialization is not completed. (Refer to the note on Page 3-2).

**NOTE:** If you are a system integrator, VAR or OEM, a POST diagnostics card is recommended. For I/O port 80h codes, refer to Appendix B.

---

## Memory Errors

1. Make sure the DIMM modules are properly and fully installed.
2. You should be using unbuffered ECC/Non ECC DDR memory (see next page). Also, it is recommended that you use the same memory speed for all DIMMs in the system. See Section 2-4 for memory limitations.
3. Check for bad DIMM modules or slots by swapping modules between slots and noting the results.
4. Check the power supply voltage 115V/230V switch.

(\*Note: The Intel 875P Canterwood/7210 Canterwood ES chipset supports non-ECC or ECC Unbuffered memory. If ECC memory is installed, the ECC bits need to be initialized via BIOS before normal operation. For a 4 GB-Memory and 2.4-GHz P4 system, it will take about 65 seconds for all the ECC bits to be initialized before any video displays. Since ECC initialization takes time, the Watch Dog Timer Select needs to be set to a time longer than what the ECC initialization will take.)

## Losing the System's Setup Configuration

1. Make sure that you are using a high quality power supply. A poor quality power supply may cause the system to lose CMOS setup information. Refer to Section 1-6 for details on recommended power supplies.
2. The battery on your motherboard may be old. Check to verify that it still supplies ~3VDC. If it does not, replace it with a new one.
3. If the above steps do not fix the Setup Configuration problems, contact your vendor for repair.

## 3-2 Technical Support Procedures

Before contacting Technical Support, please take the following steps. Also, note that as a motherboard manufacturer, Supermicro does not sell directly to end-users, so it is best to first check with your distributor or reseller for troubleshooting services. They should know of any possible problem(s) with the specific system configuration that was sold to you.

1. Please go through the 'Troubleshooting Procedures' and 'Frequently Asked Questions' (FAQs) sections in this chapter or see the FAQs on our web site (<http://www.supermicro.com/techsupport.htm>) before contacting Technical Support.



2. BIOS upgrades can be downloaded from our web site at <http://www.supermicro.com/techsupport/download.htm>.

**Note:** **Not all BIOS can be flashed, it depends on the modifications to the boot block code.**

3. If you still cannot resolve the problem, please make sure to have the following information ready when contacting Supermicro for technical support:

- Motherboard model and PCB revision number
- BIOS release date/version (this can be seen on the initial display when your system first boots up)
- System configuration

An example of a Technical Support form is posted on our web site at [http://www.supermicro.com/techsupport/contact\\_support.htm](http://www.supermicro.com/techsupport/contact_support.htm).

4. Distributors: For immediate assistance, please have your account number ready when contacting our technical support department by e-mail at [support@supermicro.com](mailto:support@supermicro.com) or by fax at (408) 503-8019.

### 3-3 Frequently Asked Questions

**Question:** What type of memory does my motherboard support?

**Answer:** The P4SCT/P4SCT+/P4SCT+II supports up to 4 GB of ECC/non-ECC, **unbuffered** DDR2-400, DDR-333/266, two-way interleaved SDRAM. See Section 2-4 for details on installing memory.

**Question:** How do I update my BIOS?

**Answer:** It is recommended that you **not** upgrade your BIOS if you are not experiencing problems with your system. Updated BIOS files are located on our web site at <http://www.supermicro.com/techsupport/BIOS/bios.htm>. Please check our BIOS warning message and the information on how to update your BIOS on our web site. Also, check the current BIOS revision and make sure it is newer than your current BIOS before downloading. Select your mainboard model and download the BIOS file to your computer. Unzip the BIOS update file and you will find the readme.txt (flash instructions), the awdfash.exe (BIOS flash utility) and the BIOS image (xxxx.bin) files. Copy these files onto a bootable floppy and reboot your system. It is not necessary to set the BIOS boot block protection jumpers on the mainboard. At the DOS prompt upon rebooting, enter the command "awdfash." Then type in the BIOS file that you want to update (xxxx.bin). You can also download the EXE file to your desktop and then, double click on it. When prompted, insert a floppy disk, and a bootable floppy will be created. Once the bootable floppy disk is created, please reboot your system with the floppy in your disk drive, and it will automatically flash the system.

**Question: What's on the CD that came with my motherboard?**

**Answer:** The supplied compact disc has quite a few drivers and programs that will greatly enhance your system. We recommend that you review the CD and install the applications you need. Applications on the CD include chipset drivers for Windows and security and audio drivers.

**Question: I see some of my PCI devices sharing IRQs, but the system seems to be fine. Is this correct or not?**

**Answer:** Some PCI Bus Mastering devices can share IRQs without performance penalties. These devices are designed to work correctly while sharing IRQs. See Table 3-1, below, for details on shared IRQs.

**Table 3-1. P4SCT/P4SCT+/P4SCT+II PCI IRQs**

	<b>INT A</b>	<b>INT B</b>	<b>INT C</b>	<b>INT D</b>
AGP Pro slot	PIRQ#A	PIRQ#B		
PCI slot 1	PIRQ#E	PIRQ#F	PIRQ#G	PIRQ#H
PCI slot 2	PIRQ#F	PIRQ#G	PIRQ#H	PIRQ#E
Onboard VGA	PIRQ#B			
Onboard LAN1(82547GI)	PIRQ#C			
Onboard LAN2(82541GI)	PIRQ#D			
PCI-X slot 1	PXIRQ#0	PXIRQ#1	PXIRQ#2	PXIRQ#3
PCI-X slot 2	PXIRQ#1	PXIRQ#2	PXIRQ#3	PXIRQ#0
PCI-X slot 3	PXIRQ#2	PXIRQ#3	PXIRQ#0	PXIRQ#1
Onboard SATA(Marvell/ Adaptec)	PXIRQ#3			

**Question: How do I connect the ATA100/66 cable to my IDE device(s)?**

**Answer:** The 80-wire/40-pin high-density ATA100/66 IDE cable that came with your system has two connectors to support two drives. This special cable must be used to take advantage of the speed the ATA100/66 technology offers. **Connect the blue connector to the onboard IDE header and the other connector(s) to your hard drive(s).** Consult the documentation that came with your disk drive for details on actual jumper locations and settings.

### 3-4 Returning Merchandise for Service

A receipt or copy of your invoice marked with the date of purchase is required before any warranty service will be rendered. You can obtain service by calling your vendor for a Returned Merchandise Authorization (RMA) number. When returning to the manufacturer, the RMA number should be prominently displayed on the outside of the shipping carton, and mailed prepaid or hand-carried. Shipping and handling charges will be applied for all orders that must be mailed when service is complete.

This warranty only covers normal consumer use and does not cover damages incurred in shipping or from failure due to the alteration, misuse, abuse or improper maintenance of products.

During the warranty period, contact your distributor first for any product problems.

**Notes**

# Chapter 4

## BIOS

### 4-1 Introduction

This chapter describes the AwardBIOS for the P4SCT/P4SCT+/P4SCT+II. The Award ROM BIOS is stored in a Flash chip and can be easily upgraded using a floppy disk-based program.

**Note:** Due to periodic changes to the BIOS, some settings may have been added or deleted and might not yet be recorded in this manual. Refer to the Manual Download area of our web site for any changes to BIOS that are not reflected in this manual.

#### System BIOS

The BIOS is the Basic Input Output System used in all IBM® PC, XT™, AT®, and PS/2® compatible computers. The AwardBIOS Flash chip stores the system parameters, such as amount of memory, type of disk drives and video displays, etc. CMOS requires very little power. When the computer is turned off, a back-up battery provides power to the BIOS Flash chip, enabling it to retain the system parameters. Each time the computer is powered-on, the computer is then configured with the values stored in the BIOS ROM by the system BIOS, which gains control when the computer is powered on.

#### How To Change the Configuration Data

The CMOS information that determines the system parameters may be changed by entering the BIOS Setup utility. This Setup utility can be accessed by pressing <Del> at the appropriate time during system boot.

#### Starting the Setup Utility

Normally, the only visible POST (Power On Self Test) routine is the memory test. As the memory is being tested, press the <Delete> key to enter the main menu of the BIOS Setup utility. From the main menu, you can access the other setup screens, such as the Chipset and Power menus. Section 4-3 gives detailed descriptions of each parameter setting in the Setup utility.

## 4-2 Running Setup

*\*Optimal default settings are in bold text unless otherwise noted.*

The BIOS setup options described in this section are selected by choosing the appropriate text from the Main BIOS Setup screen. All displayed text is described in this section, although the screen display is often all you need to understand how to set the options (see on next page).

When you first power on the computer, the AwardBIOS™ is immediately activated.

While the BIOS is in control, the Setup program can be activated in one of two ways:

1. By pressing <Del> immediately after turning the system on, or
2. When the following message appears briefly at the bottom of the screen during the POST (Power On Self-Test), press the <Del> key to activate the Main Setup Menu.

Press DEL to enter SETUP

## 4-3 Main BIOS Setup

All Main Setup options are described in this section. The Main BIOS Setup screen is displayed below.

Use the <Up> <Down> arrow keys or the <Tab> key to move among the different settings in the above menu.

Press the <Esc> key to exit the CMOS Setup Menu and use the <Left> <Right> arrow keys to enter the other categories of BIOS settings. The next section is described in detail to illustrate how to navigate through the menus.

### Main BIOS Setup Menu

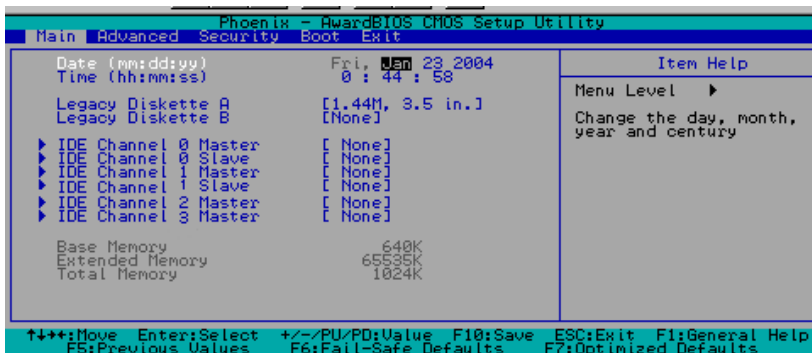

## Date/Time

Set the system date and time. Key in the correct information in the "mm", "dd" and "yy" fields. Press the "Enter" key to save the data.

## Legacy Diskette A

This setting allows the user to set the type of floppy disk drive installed as diskette A. The options are "None", "360Kb, 5.25 in", "1.2MB, 5.25 in", "720Kb, 3.5 in", **"1.44 MB, 3.5 in"**, and "2.88MB 3.5 in".

## Legacy Diskette B

This setting allows the user to set the type of floppy disk drive installed as diskette B. The options are **"None"**, "360Kb, 5.25 in", "1.2MB, 5.25 in", "720Kb, 3.5 in", "1.44 MB, 3.5 in", and "2.88MB 3.5 in".

## ►IDE Channel 0 Master/Slave, IDE Channel 1 Master/Slave, IDE Channel 2 Master, IDE Channel 3 Master

These settings allow the user to set the parameters of the IDE Channel 0 Master/Slave, IDE Channel 1 Master/Slave, IDE Channel 1 Master/Slave, IDE Channel 2 Master, IDE Channel 3 Master slots. Hit <Enter> to activate the sub-menu screen for detailed options of these items. Set the correct configurations accordingly.

### IDE HDD Auto-Detection

This option allows the user to determine the manner in which the AwardBIOS sets the settings for the IDE Primary Master Device. The options are "None", **"Auto"** and "Manual."

### IDE Channel 0 Master/Slave, IDE Channel 1 Master/Slave, IDE Channel 2 Master, IDE Channel 3 Master

Press the <Auto> key to activate the function of 'IDE HDD Auto-Detection', which will allow the BIOS to automatically detect the status of the IDE HDD installed in the system, such as the size, the number of cylinders, the configurations of items such as Head, Precomp, Landing Zone and Sector. The options are "None", **"Auto"**, and "Manual."

### Access Mode

This item determines the location through which the AwardBIOS accesses the IDE Primary Master Device. The settings are "CHS", "LBA", "Large", and **"Auto"**.

## Base Memory/Extended Memory/Total Memory

These are displays that inform you how much of each type of memory is recognized as being present in the system.

---

## 4-4 Advanced BIOS Setup

Choose Advanced BIOS Setup from the Award BIOS main menu with the Left/Right arrow keys. You should see the following display. Select one of the items in the left frame of the screen to go to the sub screen for that item. Advanced BIOS Setup options are displayed by highlighting the option using the arrow keys. All Advanced BIOS Setup options are described in this section.

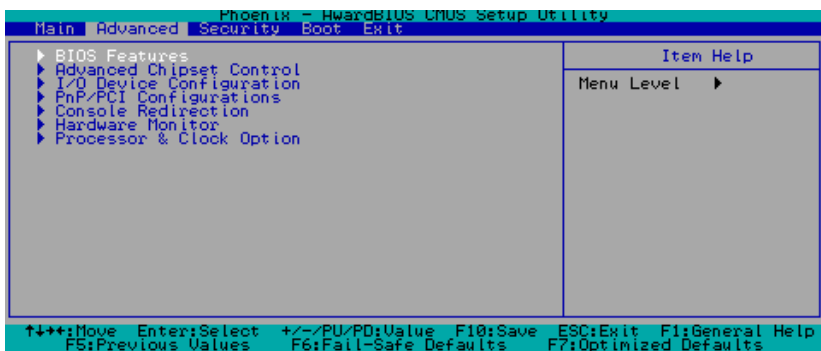

### 4-4.1 Advanced BIOS Features

When the item of Advanced BIOS Features is highlighted, press the <Enter> key to activate the screen below:

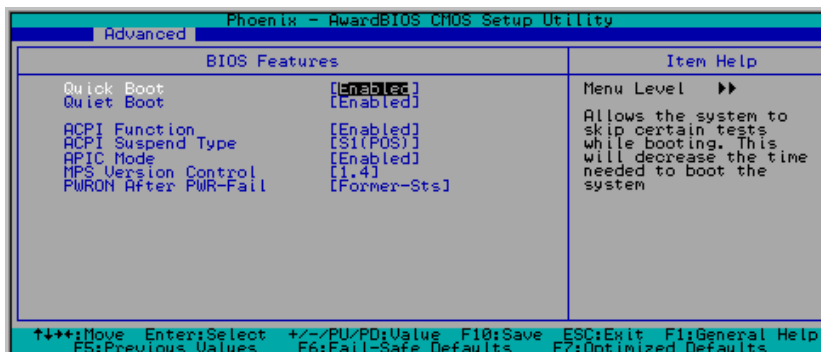

#### Quick Boot

If enabled, this feature allows the system to skip certain tests while booting. This will decrease the time needed to boot the system. The settings are "Enabled" and "Disabled".

#### Quiet Boot

This feature allows the user to activate the function of "Quiet Boot". The options are: "Enabled" and "Disabled".



## ACPI Function

Select "Enabled" to activate the function of BIOS Support for Advanced Configuration and Power Interface features. The settings are "Enabled" or "Disabled".

## ACPI Suspend Type

If enabled, the option allows the user to determine the ACPI Suspend type. The options are "S1(POS)", "S3(STR)", and S1&S3.

## APIC Mode

This setting allows you to **Enable** or Disable APIC. APIC is used to assign interrupt signals to a specific processor on multi-processor system and provides IRQs beyond the conventional 16 under Windows 2000 or XP. It has no effect on single processor systems.

## MPS Version Control

This setting allows you to state the MPS version for your operating system. Options are "1.1" and "1.4".

## PWRON After PWR-Fail

This setting allows the user to specify how the system will respond when power is reapplied after the system has gone down due to a power failure. The options are "Off", "On" and "Former-Sts (Former Status)".

## 4-4.2 Advanced Chipset Control

Access the submenu to make changes to the following settings.



### **ECC Configuration**

This setting allows you to enable or disable ECC (Error Correction and Checking). The options are "**ECC**" and "Non-ECC".

### **CSA LAN (Giga-LAN)**

Select "Enabled" to activate the function of CSA LAN. The options are "**Enabled**" and "Disabled".

### **Smart Fan Control**

Select "Enabled" to enable the function of Smart Fan Control. The options are "**Disabled**" and "Enabled".

### **SATA Mode**

This setting allows you to set the SATA Mode RAID via BIOS. The options are "**RAID**" and "IDE".

### **On-Chip Serial ATA**

This setting allows you to configure On-Chip Chipset Configurations. Select "Disabled" to disable SATA controller. If "Auto" is selected, BIOS will automatically configure the settings for SATA controller. Select "Combined Mode" to combine the functionality of Parallel ATA (PATA) and Serial ATA(SATA) (\* with the maximum of two IDE drives available for each channel.) If "Enhanced Mode" is selected, both SATA and PATA are supported (\*with the maximum of 6 IDE drives available.) If "SATA Only" is selected, SATA will operate in the Legacy Mode. The options are Disabled, **Auto**, Combined Mode, Enhanced Mode, and SATA only.

### **Serial ATA Port0/1 mode**

This setting allows you to configure Serial ATA Port0/1 modes. The options are **Primary Master**, Primary Slave, Secondary Master, Secondary Slave, SATA0 Master and SATA1 Master.

### **USB Controller**

This setting allows you to enable or disable the USB Controller. The options are **Enabled**, and Disabled.

### **USB 2.0 Controller**

This setting allows you to enable or disable USB 2.0 (EHCI) Controller. The options are **Enabled**, and Disabled.

## USB Legacy Support

This setting allows you to enable or disable the functions of USB, Keyboard/ Mouse under POST and DOS. The options are **Disabled**, and Enabled.

## CPU THRM-Throttling

THRM throttling is used to lower power consumption and reduce the heat generated by the CPU. The options for this setting are "87.5%", "75%", "62.5%", "50%", "37.5%", "25%" and "12.5%".

## 4-4.3 I/O Device Configuration

Choose I/O Device Configuration from the Award BIOS main menu with the Left/Right arrow keys. You should see the following display:

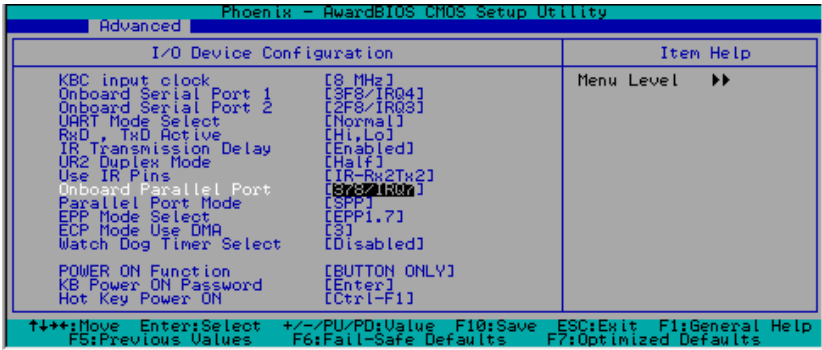

### Keyboard Input Clock

This setting allows you to set the speed of the keyboard. The options are 6 MHz, **8 MHz**, 12 MHz, and 16 MHz.

### Onboard Serial Port1/Onboard Serial Port2

This setting allows the user to set the address and the corresponding IRQ for the Serial Port1 and Serial Port 2. The options are "Disabled", "3F8/IRQ4", "2F8/IRQ3", "3E8/IRQ4", "2E8/IRQ3", and "Auto". The default setting for Serial Port1 is "**3F8/IRQ4**" and the default for Port 2 is "**2F8/IRQ3**".

### **UART Mode Select**

This setting allows the user to select the UART mode for the BIOS. The options are "IrDA", "ASKIR" and "**Normal**".

### **RxD, TxD Active**

This allows the user to change the settings for the "RxD, TxD Active" function. The options are "Hi, Hi", "**Hi, Lo**", "Lo, Hi", and "Lo, Lo".

### **IR Transmission Delay**

If "Enabled", the transmission of IR (infrared) signals will be delayed. The options are "**Enabled**" and "Disabled".

### **UR2 Duplex Mode**

This setting set the mode for the UR2 Duplex Mode. The options are "Full" and "**Half**".

### **Use IR Pins**

This item sets the usage of the IR pins. The options are "RxD2, TxD2" and "**IR-Rx2Tx2**".

### **Onboard Parallel Port**

This setting allows the user to set the address and the corresponding IRQ for the onboard parallel port. The options are "Disabled", "**378/IRQ7**", "278/IRQ5" and "3BC/IRQ7".

### **Parallel Port Mode**

This setting sets the mode for the onboard Parallel port. The options are "**SPP**," "EPP", "ECP" "ECP+EPP" and "Normal".

### **EPP Mode Select**

This setting allows the user to select the EPP port type. The options are "EPP 1.9" and "**EPP 1.7**".

### **ECP Mode Use DMA**

This setting allows the user to select the DMA channel for the ECP mode (port) to use. The options are "1" and "**3**".

### **Watch Dog Timer Select**

This setting allows you to select the setting for the Watch Dog Timer. The Options are "**Disabled**", "10 Sec", "20 Sec", "30 Sec", "40 Sec", "1 min", "2 min",and "4 min".

## Power On Function

This setting allows the user to decide which method to use to power on the system. The options are "Password", "Hot Key", "Mouse Left", "Mouse Right", "Any Key", and "**Button Only**".

## KB Power On Password

This setting allows the user to enter the Password when the system is powered on via keyboard.

## Hot Key Power On

This setting allows the user to decide which hot-keys to use in order to power on the system. The options are "**Ctrl-F1**", "Ctrl-F2, Ctrl-F3", "Ctrl-F4", "Ctrl-F5", "Ctrl-F6", "Ctrl-F7", "Ctrl-F8", "Ctrl-F9", "Ctrl-F10", "Ctrl-F11" and "Ctrl-F8".

## 4-4.4 PnP Configuration

Choose PCI/PnP Configurations from the Award BIOS main menu with the Left/Right arrow keys. You should see the following display:

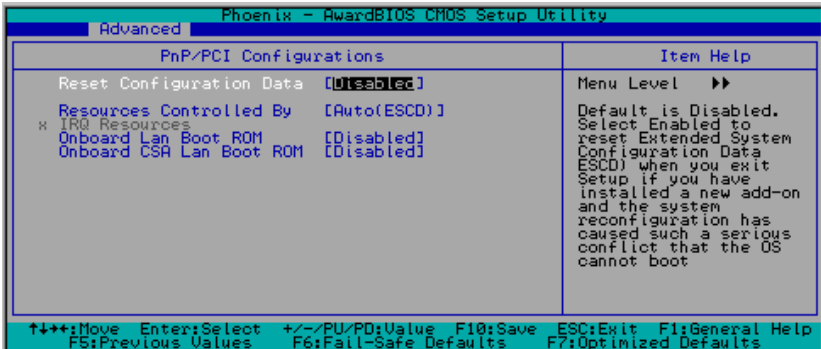

### Reset Configuration Data

Enabling this setting resets the extended system configuration data when you exit setup. Do this when you have installed a new add-on and the system reconfiguration has caused such a serious conflict that the OS cannot reboot the system. The options are "Enabled" and "**Disabled**".

## Resources Controlled By

This setting allows BIOS to automatically configure all boot and Plug and Play compatible devices. If you choose Auto, you cannot select the IRQ, DMA and memory base address fields because BIOS automatically assigns them. The options are "Auto <ESCD>" and "Manual".

## Onboard CSA LAN Boot

Select "Enabled" to enable the Boot ROM embedded in the Onboard CSA LAN Chip. The options are: "Enabled" and "Disabled".

## 4-4.5 Console Redirection

Choose Console Redirection from the Award BIOS main menu with the Left/ Right arrow keys. You should see the following display:

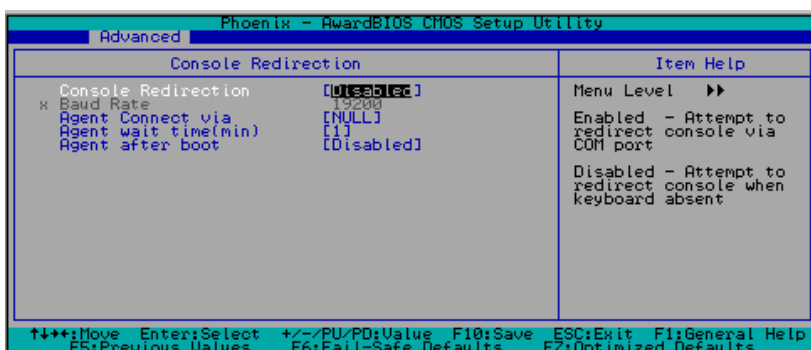

### Console Redirection

Select "Enabled" to redirect Console via COM Port. Select "Disabled" to redirect Console when the keyboard is absent. The options are: "Enabled" and "Disabled".

### Agent Connect Via

This feature allows the user to set the connection mode for Console Redirection. When "Null" is entered, Console Redirection will be set to direct connection.

### Agent Wait Time

This feature allows the user to set the timeout for the connection. The options are "1 (Min)", "2 (Min)", "4 (Min)" and "8 (Min)".

## Agent after Boot

Select "Disabled" to allow the Agent of Console Redirection to continue running after OS bootup. The Options are "Enabled", and "**Disabled**".

### 4-4.6 Hardware Monitor

Choose Hardware Monitor from the Award BIOS main menu with the Left/ Right arrow keys. You should see the following display:

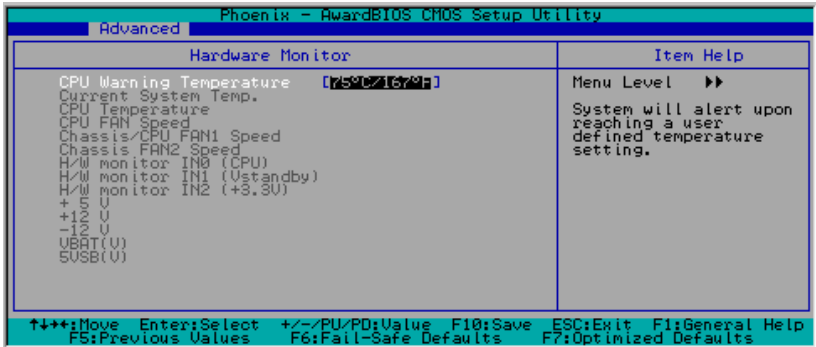

### CPU Warning Temperature

This allows you to set the CPU warning temperature. If the CPU temperature reaches this threshold, an alarm will activate and a warning message will be displayed onscreen. The options are "Disabled", "60° C/140° F", "65° C/149° F", "70° C/158° F", "**75° C/167° F**", "80° C/176° F" and "85° C/185° F".

## 4-4.7 Processor & Clock Options

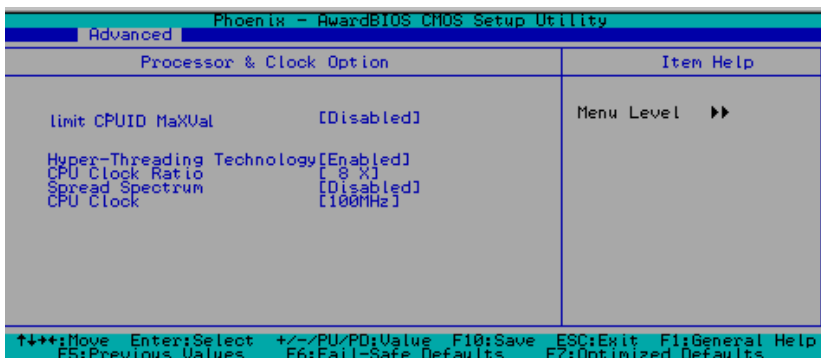

### Limit CPUID MaxVal

This feature allows the user to set the limit for the CPUID Maximum Value. The value can be set from 1 to 3. The options are "Enabled" and "Disabled". (\*For Windows XP, the option should be set to "Disabled".)

### Hyper-Threading Technology

Select "Enabled" to activate the hyper-threading function of the CPUs to make each CPU appear as if there were two CPUs to any programs that support it (you must have OS support also). The settings are "Disabled" and "Enabled."

### CPU Clock Ratio

Key in a number between 8x to 50x to set the clock ratio of the processor. The default setting is **8x**. (\*8x is only available for retail CPUs.)

### Spread Spectrum

Spread Spectrum is a technique used to stabilize a system by reducing the level of ElectroMagnetic Interference. The options are "Enabled" and "Disabled".

### CPU Clock

Key in a number between 100 and 233 to set the CPU clock (MHz). Supermicro does not recommend or make any guarantees with CPU overlocking. The default setting is **200 MHz**.



## 4-5 Security

Choose Security from the Award BIOS main menu with the Left/Right arrow keys. You should see the following display:

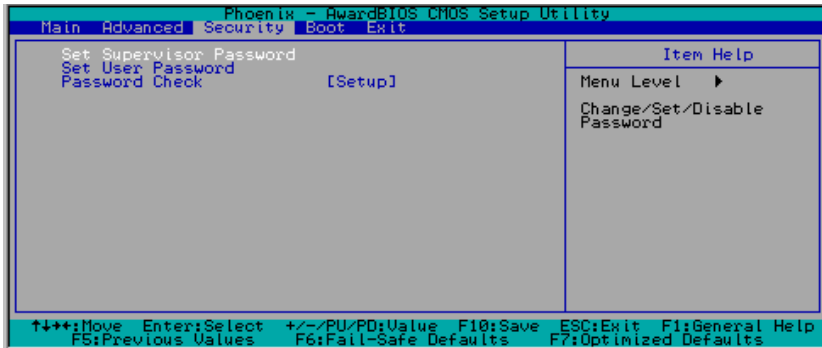

### Set Supervisor Password

When the item "Set Supervisor Password" is highlighted on the above screen, press the <Enter> key. When prompted, type the Supervisor Password in the dialogue box to set or to change the Supervisor Password.

### Set User Password

When the item "Set User Password" is highlighted on the above screen, press the <Enter> key. When prompted, type the User Password in the dialogue box to set or to change the User Password.

### Password Check

This setting allows the user to determine if the password is required every time when the system boots up or if the password is required only when you enter the CMOS setup. The options are "System" and "**Setup**".

## 4-6 Boot

Choose Boot from the Award BIOS main menu with the Left/Right arrow keys. You should see the following display:

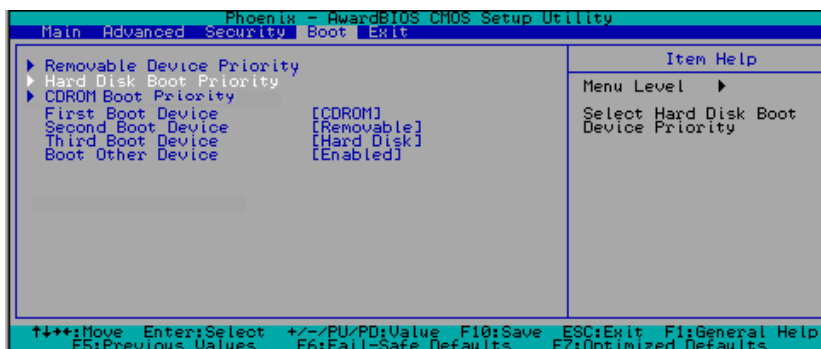

### ▶ Removable Device Priority

This setting allows you to set the priority of removable devices. The options are **"Floppy Disks"**, "LS120", "Zip 100", "USB-FDD0", "USB-FDD1", "USB-ZIP0", and "USB-ZIP1".

### ▶ CD ROM Drives Boot Priority

This item allows the user to specify the boot sequence of the available CD ROM Devices.

### ▶ Hard Disk Boot Priority

This item allows the user to select the Boot Priority of the following Hard Disk Devices.

### First Boot Device

This item allows the user to set the first boot-up device. The options are "Removable", "Hard Disks", **"CDROM"**, "Legacy LAN", and "Disabled".

## Second Boot Device

This item allows the user to set the second boot-up device. The options are **"Removable"**, "Hard Disks", "CDROM", "Legacy LAN", and "Disabled".

## Third Boot Device

This item allows the user to set the Third boot-up device. The options are "Removable", **"Hard Disks"**, "CDROM", "Legacy LAN", and "Disabled".

## Boot Other Device

If enabled, this option enables the BIOS to load the OS from another device rather than the ones that have been specified as the first, second and third boot up devices. The settings are **"Enabled"** and "Disabled".

## 4-7 Exit

Choose Exit from the Award BIOS main menu with the Left/Right arrow keys. You should see the following display:

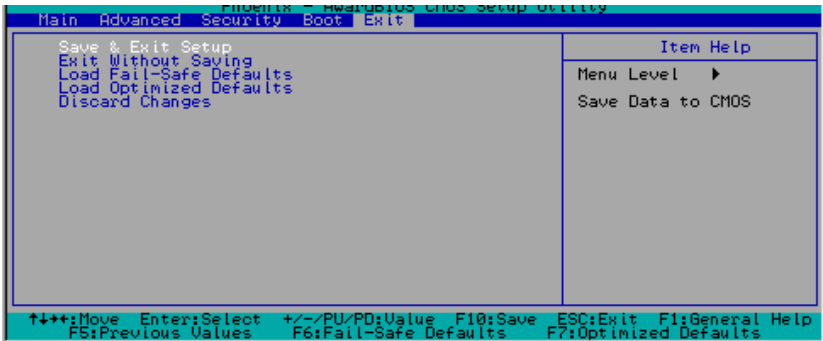

### Save & Exit Setup

When the item "Save & Exit Setup" is highlighted, press <Enter> to save the changes you've made in the BIOS program (CMOS) and exit. Your system should, then, continue with the boot-up procedure.

### Exit without Saving

When the item "Exit without Saving" is highlighted, press <Enter> to exit the Setup routine without saving any changes you may have made. Your system should then continue with the boot-up procedure.

### **Load Fail-Safe Defaults**

Highlight this item and hit <Enter> to load the default settings for all items in the BIOS Setup. These are the safest settings to use.

### **Load Optimized Defaults**

Highlight this item and hit <Enter> to load the optimized settings for all items in the BIOS Setup. These settings provide you with optimal system performance.

### **Discard Changes**

When the item "Discard Changes" is highlighted, press <Enter> to discard any changes you made to the BIOS settings and to stay in BIOS Setup. Your system should then continue with the boot-up procedure.

## Appendix A BIOS POST Messages

During the Power-On Self-Test (POST), the BIOS will check for problems. If a problem is found, the BIOS will activate an alarm or display a message. The following is a list of such BIOS messages.

### Beeps

1 long beep

1 long beep+2 short beeps

### Error Messages

Memory Modules Errors

VGA Errors

**Notes**

## Appendix B: Award BIOS POST Codes

This section lists the POST (Power On Self Testing) Codes for the Award BIOS.

POST (hex)	Description
CFh	Test CMOS R/W functionality.
C0h	Early chipset initialization: -Disable shadow RAM -Disable L2 cache (socket 7 or below) -Program basic chipset registers
C1h	Detect memory -Auto-detection of DRAM size, type and ECC. -Auto-detection of L2 cache (socket 7 or below)
C3h	Expand compressed BIOS code to DRAM
C5h	Call chipset hook to copy BIOS back to E000 & F000 shadow RAM.
0h1	Expand the Xgroup codes locating in physical address 1000:0
02h	Reserved
03h	Initial Superio_Early_Init switch.
04h	Reserved
05h	1. Blank out screen 2. Clear CMOS error flag
06h	Reserved
07h	1. Clear 8042 interface 2. Initialize 8042 self-test
08h	1. Test special keyboard controller for Winbond 977 series Super I/O chips. 2. Enable keyboard interface.
09h	Reserved
0Ah	<ul style="list-style-type: none"> <li>● Disable PS/2 mouse interface (optional).</li> <li>● Auto detect ports for keyboard &amp; mouse followed by a port &amp; interface swap (optional).</li> <li>● Reset keyboard for Winbond 977 series Super I/O chips.</li> </ul>
0Bh	Reserved
0Ch	Reserved
0Dh	Reserved
0Eh	Test F000h segment shadow to see whether it is R/W-able or not. If test fails, keep beeping the speaker.

POST (hex)	Description
------------	-------------

0Fh	Reserved
10h	Auto detect flash type to load appropriate flash R/W codes into the run time area in F000 for ESCD & DMI support.
11h	Reserved
12h	Use walking 1's algorithm to check out interface in CMOS circuitry. Also set real-time clock power status, and then check for override.
13h	Reserved
14h	Program chipset default values into chipset. Chipset default values are MODBINable by OEM customers.
15h	Reserved
16h	Initial Early_Init_Onboard_Generator switch.
17h	Reserved
18h	Detect CPU information including brand, SMI type (Cyrix or Intel) and CPU level (586 or 686).
19h	Reserved
1Ah	Reserved
1Bh	Initial interrupts vector table. If no special specified, all H/W interrupts are directed to SPURIOUS_INT_HDLR & S/W interrupts to SPURIOUS_soft_HDLR.
1Ch	Reserved
1Dh	Initial EARLY_PM_INIT switch.
1Eh	Reserved
1Fh	Load keyboard matrix (notebook platform)
20h	Reserved
21h	HPM initialization (notebook platform)
22h	Reserved
23h	<ol style="list-style-type: none"> <li>1. Check validity of RTC value: e.g. a value of 5Ah is an invalid value for RTC minute.</li> <li>2. Load CMOS settings into BIOS stack. If CMOS checksum fails, use default value instead.</li> <li>3. Prepare BIOS resource map for PCI &amp; PnP use. If ESCD is valid, take into consideration of the ESCD's legacy information.</li> <li>4. Onboard clock generator initialization. Disable respective clock resource to empty PCI &amp; DIMM slots.</li> <li>5. Early PCI initialization: <ul style="list-style-type: none"> <li>-Enumerate PCI bus number</li> <li>-Assign memory &amp; I/O resource</li> <li>-Search for a valid VGA device &amp; VGA BIOS, and put it into C000:0.</li> </ul> </li> </ol>
24h	Reserved
25h	Reserved
26h	Reserved
27h	Initialize INT 09 buffer
28h	Reserved
29h	<ul style="list-style-type: none"> <li>● Program CPU internal MTRR (P6 &amp; PII) for 0-640K memory address.</li> <li>● Initialize the APIC for Pentium class CPU.</li> <li>● Program early chipset according to CMOS setup. Example: onboard IDE controller.</li> <li>● Measure CPU speed.</li> <li>● Invoke video BIOS.</li> </ul>
2Ah	Reserved
2Bh	Reserved
2Ch	Reserved



POST (hex)	Description
2Dh	1. Initialize multi-language 2. Put information on screen display, including Award title, CPU type, CPU speed ....
2Eh	Reserved
2Fh	Reserved
30h	Reserved
31h	Reserved
32h	Reserved
33h	Reset keyboard except Winbond 977 series Super I/O chips.
34h	Reserved
35h	Reserved
36h	Reserved
37h	Reserved
38h	Reserved
39h	Reserved
3Ah	Reserved
3Bh	Reserved
3Ch	Test 8254
3Dh	Reserved
3Eh	Test 8259 interrupt mask bits for channel 1.
3Fh	Reserved
40h	Test 8259 interrupt mask bits for channel 2.
41h	Reserved
42h	Reserved
43h	Test 8259 functionality.
44h	Reserved
45h	Reserved
46h	Reserved
47h	Initialize EISA slot
48h	Reserved
49h	1. Calculate total memory by testing the last double word of each 64K page. 2. Program writes allocation for AMD K5 CPU.
4Ah	Reserved
4Bh	Reserved
4Ch	Reserved
4Dh	Reserved
4Eh	1. Program MTRR of M1 CPU 2. Initialize L2 cache for P6 class CPU & program CPU with proper cacheable range. 3. Initialize the APIC for P6 class CPU. 4. On MP platform, adjust the cacheable range to smaller one in case the cacheable ranges between each CPU are not identical.
4Fh	Reserved
50h	Initialize USB
51h	Reserved
52h	Test all memory (clear all extended memory to 0)
53h	Reserved
54h	Reserved
55h	Display number of processors (multi-processor platform)
56h	Reserved
57h	1. Display PnP logo 2. Early ISA PnP initialization -Assign CSN to every ISA PnP device.

POST (hex)	Description
58h	Reserved
59h	Initialize the combined Trend Anti-Virus code.
5Ah	Reserved
5Bh	(Optional Feature) Show message for entering AWDFLASH.EXE from FDD (optional)
5Ch	Reserved
5Dh	1. Initialize Init_Onboard_Super_IO switch. 2. Initialize Init_Onboard_AUDIO switch.
5Eh	Reserved
5Fh	Reserved
60h	Okay to enter Setup utility; i.e. not until this POST stage can users enter the CMOS setup utility.
61h	Reserved
62h	Reserved
63h	Reserved
64h	Reserved
65h	Initialize PS/2 Mouse
66h	Reserved
67h	Prepare memory size information for function call: INT 15h ax=E820h
68h	Reserved
69h	Turn on L2 cache
6Ah	Reserved
6Bh	Program chipset registers according to items described in Setup & Auto-configuration table.
6Ch	Reserved
6Dh	1. Assign resources to all ISA PnP devices. 2. Auto assign ports to onboard COM ports if the corresponding item in Setup is set to "AUTO".
6Eh	Reserved
6Fh	1. Initialize floppy controller 2. Set up floppy related fields in 40:hardware.
70h	Reserved
71h	Reserved
72h	Reserved
73h	(Optional Feature) Enter AWDFLASH.EXE if : -AWDFLASH is found in floppy drive. -ALT+F2 is pressed
74h	Reserved
75h	Detect & install all IDE devices: HDD, LS120, ZIP, CDROM.....
76h	Reserved
77h	Detect serial ports & parallel ports.
78h	Reserved
79h	Reserved
7Ah	Detect & install co-processor
7Bh	Reserved
7Ch	Reserved
7Dh	Reserved
7Eh	Reserved
7Fh	1. Switch back to text mode if full screen logo is supported. -If errors occur, report errors & wait for keys -If no errors occur or F1 key is pressed to continue: ♦Clear EPA or customization logo.

POST (hex)	Description
80h	Reserved
81h	Reserved
82h	<ol style="list-style-type: none"> <li>1. Call chipset power management hook.</li> <li>2. Recover the text font used by EPA logo (not for full screen logo)</li> <li>3. If password is set, ask for password.</li> </ol>
83h	Save all data in stack back to CMOS
84h	Initialize ISA PnP boot devices
85h	<ol style="list-style-type: none"> <li>1. USB final Initialization</li> <li>2. NET PC: Build SYSID structure</li> <li>3. Switch screen back to text mode</li> <li>4. Set up ACPI table at top of memory.</li> <li>5. Invoke ISA adapter ROMs</li> <li>6. Assign IRQs to PCI devices</li> <li>7. Initialize APM</li> <li>8. Clear noise of IRQs.</li> </ol>
86h	Reserved
87h	Reserved
88h	Reserved
89h	Reserved
90h	Reserved
91h	Reserved
92h	Reserved
93h	Read HDD boot sector information for Trend Anti-Virus code
94h	<ol style="list-style-type: none"> <li>1. Enable L2 cache</li> <li>2. Program boot up speed</li> <li>3. Chipset final initialization.</li> <li>4. Power management final initialization</li> <li>5. Clear screen &amp; display summary table</li> <li>6. Program K6 write allocation</li> <li>7. Program P6 class write combining</li> </ol>
95h	<ol style="list-style-type: none"> <li>1. Program daylight saving</li> <li>2. Update keyboard LED &amp; typematic rate</li> </ol>
96h	<ol style="list-style-type: none"> <li>1. Build MP table</li> <li>2. Build &amp; update ESCD</li> <li>3. Set CMOS century to 20h or 19h</li> <li>4. Load CMOS time into DOS timer tick</li> <li>5. Build MSIRQ routing table.</li> </ol>
FFh	Boot attempt (INT 19h)

**NOTES**

## Appendix C

# Installing Software Drivers and Windows Operating System

After all the hardware has been installed, you must first configure the Adaptec Embedded Serial ATA RAID Driver before you install the Windows operating system. The necessary drivers are all included on the Supermicro bootable CDs that came packaged with your motherboard. (*The following section provides information on Adaptec's SATA RAID Driver based on the Intel Hance Rapids ICH Controller. For additional information regarding the Adaptec SATA Host RAID driver based on the Marvell 88SX5041 Controller, please refer to Adaptec's SATA Host RAID Utility User's Guide included in Supermicro's bootable CD. You can also access Adaptec's User's Guides on our web site at [www.supermicro.com](http://www.supermicro.com). Please also note that the Marvell Controller is only available for the P4SCT+ and the P4SCT+II boards.*)

### **C-1 Introduction to the Adaptec Embedded Serial ATA RAID Controller Driver**

#### **Serial ATA (SATA)**

Serial ATA(SATA) is a physical storage interface. It uses a single cable with a minimum of four wires to create a point-to-point connection between devices. It is a serial link which supports SATA Transfer rates from 150MBps. Because the serial cables used in SATA are thinner than the traditional cables used in Parallel ATA(PATA), SATA systems have better airflow and can be installed in smaller chassis than Parallel ATA. In addition, the cables used in PATA can only extend to 40cm long, while Serial ATA cables can extend up to one meter. Overall, Serial ATA provides better functionality than Parallel ATA.

#### **Introduction to the Intel 6300ESB (Hance Rapids) I/O Controller Hub**

Located in the South Bridge of the Intel Canterwood (875P) and Canterwood ES (E7210)Chipset, the 6300ESB (Hance Rapids) I/O Controller Hub provides the I/O subsystem with access to the rest of the system. It supports 2-channel Ultra ATA/100 Bus Master IDE controller (PATA) and two Serial ATA (SATA) Host Controllers, which support up to two Serial ATA ports and up to two RAID drives. The 6300ESB (Hance Rapids) I/O Controller Hub supports the following Parallel ATA (PATA) and Serial (SATA) device configurations:

## ATA Operate Mode

You can select from the following two modes: Combined Mode and Enhanced Mode.

### **Combined Mode:**

In this mode, system BIOS assigns the traditional IRQ 14 and IRQ 15 for the use of HDD. Up to 4 ATA devices are supported by this mode.

Within the Combined Mode, the following three modes are supported:

\*Non-Combined Mode: Parallel ATA only:with the maximum of 4 devices supported;

\*Non-Combined Mode: Serial ATA only:with the maximum of 2 devices supported;

\*Combined Mode: SATA devices and PATA: with the support of 2 devices each (total: 4 devices maximum). (For IDE/SATA configurations, please refer to the table below.)

Primary Master(=PM)	Yes	Yes	No	No	No	No
Primary Slave(=PS)	Yes	No	Yes	No	No	No
Secondary Master(=SM)	Yes	No	No	Yes	No	No
Secondary Slave(=SS)	Yes	No	No	No	Yes	No
SATA Port0	No	SM	SM	PM	PM	PM
SATA Port1	No	SS	SS	PS	PS	PS
*Note: (No=Not Present, Yes=Present) Also, if Logical Primary is selected, the IDE channels are no longer available.						

### **Enhanced Mode:**

In this mode, system BIOS will automatically search for all available IRQs for the use of HDD. For newer Operating Systems that support the Enhanced Mode, such as Windows XP, Windows 2000, and Windows 2003, you can set SATA and PATA to the Enhanced Mode. (\*The newer Operating Systems can accommodate both Enhanced Mode and Combined Mode and support up to 6 ATA devices.)

(\*Please refer to the "Advanced Chipset Control" under the "Advanced" Setup in the BIOS for the selection of Combined Mode or Enhanced Mode.).

## **Configuring BIOS settings for the SATA RAID Functions (Enhanced Mode)**

1. Press the <Del> key during system bootup to enter the BIOS Setup Utility.

(\*Note: If it is the first time to power on the system, we recommend that you load the Optimized Default Settings. If you have already done so, please skip to Step 3.

2. Use the arrow keys to select the "Exit" Menu. Once in the "Exit" Menu, scroll down the menu to select the item- "Load Optimized Default settings" and press the <Enter> key. Select "OK" to confirm the selection. Press the <Enter> key to load the default settings to the BIOS.

3. Use the arrow keys to select the "Advanced" Menu in the BIOS.

4. Scroll down to "Advanced Chipset Control", select "On-chip SATA" and press the <Enter> Key to select this option.

5. From this submenu, select the "Enhanced Mode" and press <Enter>.

6. Scroll up to the item-"SATA Mode" and select the "Configure SATA as RAID" and press the <Enter> Key to select this option.

7. Tap the <Esc> key and scroll down to "Exit". Select "Save and Exit" from the "Exit" menu. Press the <Enter> key to save the changes and exit the BIOS.

8. Once you've exited the BIOS Utility, the system will re-boot.

9. During the system startup, press the <Ctrl> and the <A> keys simultaneously to run the Adaptec RAID Configuration Utility when prompted by the following message:

Press <Ctrl><A> for Adaptec RAID Configuration Utility

## **The Adaptec Embedded Serial ATA with HostRAID Controller Driver**

Adaptec's Embedded Serial ATA RAID with HostRAID controller adds RAID functionality to the Serial ATA I/O controller by supporting RAID 0 (Striping) or RAID 1 (Mirroring) to enhance the industry's pioneer PCI-to-e host controller products. RAID striping (RAID 0) can greatly improve hard disk I/O performance because of its capability in striping data across multiple drives. RAID mirroring (RAID 1) allows the data to be simultaneously written to two drives, so critical data is always available even if a single hard disk fails. Due to the built-in functionality, the P4SCT/P4SCT+/P4SCT+II is specially designed to keep pace with the increasing performance demands of computer systems by improving disk I/O throughput and providing data accessibility regardless of a single disk failure. By incorporating the Adaptec Embedded Serial ATA into the motherboard design, Supermicro's P4SCT/P4SCT+/P4SCT+II offers the user with the benefits of SATARAID without the high costs associated with hardware RAID applications.

(\***Note:** For Adaptec's RAID Driver Installation Instructions, please refer to the Adaptec RAID Controller User's Guide: "Emb\_SA\_RAID\_UG.pdf" in the CD that came with this motherboard. You can also download a copy of Adaptec's User's Guide from our web site at [www.supermicro.com](http://www.supermicro.com).)

### **Using the Adaptec RAID Configuration Utility (ARC)**

The Adaptec RAID Configuration Utility is an embedded BIOS Utility, including:

\*Array Configuration Utility: Use this utility when you want to create, configure and manage arrays.

\* Disk Utilities: Use this option to format or verify disks.

To run the Adaptec RAID Configuration Utility, you will need to enable the RAID function in the system BIOS (refer to Chapter 4 for System BIOS Configurations), and then, press the <Ctrl> and <A> keys simultaneously when prompted to do so during the system startup. (Refer to the previous page for detailed instructions.)

(\***Note:** To select an option, use the arrow keys to highlight the item and then press the <Enter> key to select it. To return to the previous menu, press the <ESC> key.)

#### **A. Using the Array Configuration Utility (ACU)**

The Array Configuration Utility (ACU) enables you to create, manage, and delete arrays from the controller's BIOS, add and delete spare drives, and initialize drives. During the system startup, press <Ctrl> and <A> key simultaneously, and the main menu will appear.



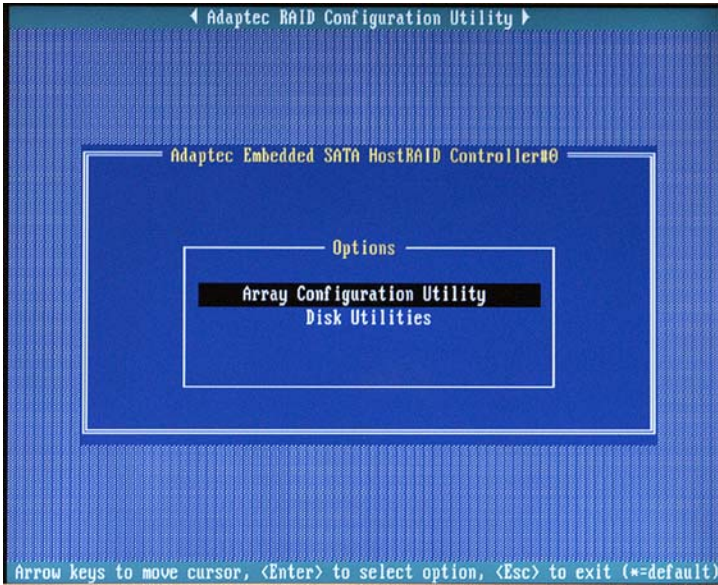

## Managing Arrays

Select this option to view array properties, and delete arrays. The following sections describe the operations Of "Managing Arrays".

To select this option, use the arrow keys and the <enter> key to select "Managing Arrays" from the main menu (as shown above).

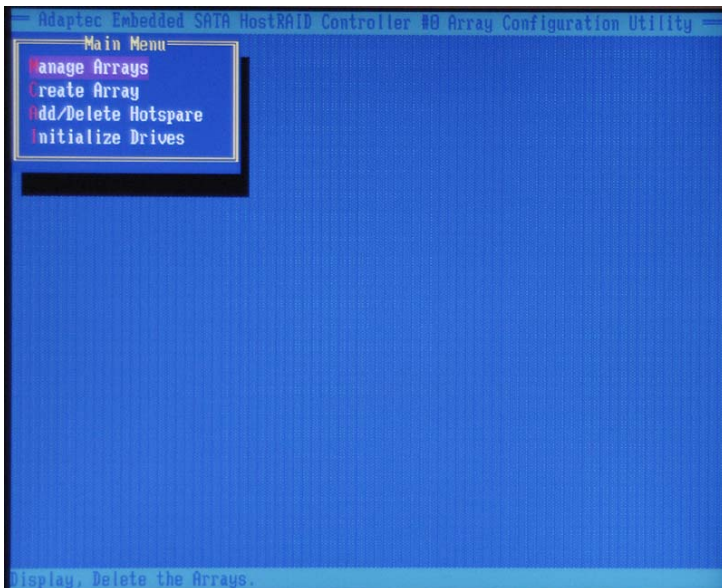

### **Viewing Array Properties**

To view the properties of an existing array:

1. At the BIOS prompt, press **Ctrl+A**.
2. From the ARC menu, select **Array Configuration Utility (ACU)**.
3. From the ACU menu, select **Manage Arrays** (as shown on the previous screen.)
4. From the List of Arrays dialog box, select the array you want to view and press **Enter**.

The Array Properties dialog box appears, showing detailed information on the array. The physical disks associated with the array are displayed here.

5. Press **Esc** to return to the previous menu.

### **Deleting Arrays**

*\*Warning: Back up the data on an array before you delete it to prevent the loss of data. Deleted arrays cannot be restored.*

To delete an existing array:

1. Turn on your computer and press **Ctrl+A** when prompted to access the ARC utility.
2. From the ARC main menu, select **Array Configuration Utility (ACU)**.
3. From the ACU menu, select **Manage Arrays**.
4. Select the array you wish to delete and press **Delete**.
5. In the Array Properties dialog box, select **Delete** and press **Enter**. The following prompt is displayed:

*\*Warning!! Deleting the array will render array unusable. Do you want to delete the array?(Yes/No):*

**RAID 1 only—the following prompt is also displayed:**

*Deleting the partition will result in data loss! Do you also want to delete the partition? (Yes/No):*

6. Press **Yes** to delete the array or partition or **No** to return to the previous menu.
7. Press **Esc** to return to the previous menu.

## Creating Arrays

Before creating arrays, make sure the disks for the array are connected and installed in your system. Note that disks with no usable space, or disks that are un-initialized are shown in gray and cannot be used. See [Initializing Disk Drives](#).

### To create an array:

- 1 Turn on your computer and press **Ctrl+A** when prompted to access the ARC utility.
  - 2 From the ARC menu, select **Array Configuration Utility Main Menu (ACU)** (as shown on the first screen on page C-5).
  - 3 From the ACU menu, select **Create Array**.
  - 4 Select the disks for the new array and press **Insert** (as the screen shown below).
- (\*Note: To deselect any disk, highlight the disk and press **Delete**.)

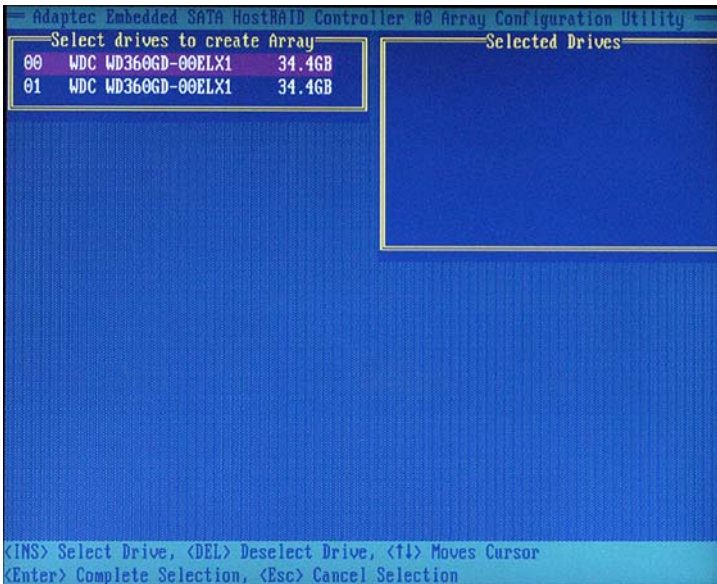

- 5 Press **Enter** when both disks for the new array are selected. The Array Properties menu displays (as the screen shown on the next page).

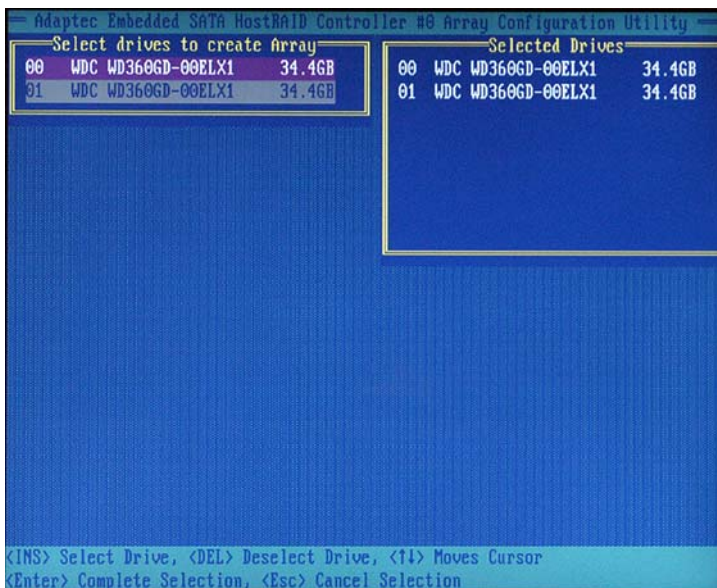

### Assigning Array Properties

Once you've create a new array, you are ready to assign the properties to the array.

**\*Caution:** Once the array is created and its properties are assigned, you cannot change the array properties using the ACU. You will need to use the Adaptec Storage Manager - Browser Edition. (Refer to Adaptec's User's Guide in the enclosed CD.)

To assign properties to the new array:

1. In the Array Properties menu (as shown in the following screen), select an array type and press **Enter**.

Note that only the available array types: RAID 0, and RAID1, are displayed on the screen. (\*RAID 0 or RAID 1 requires two drives.)

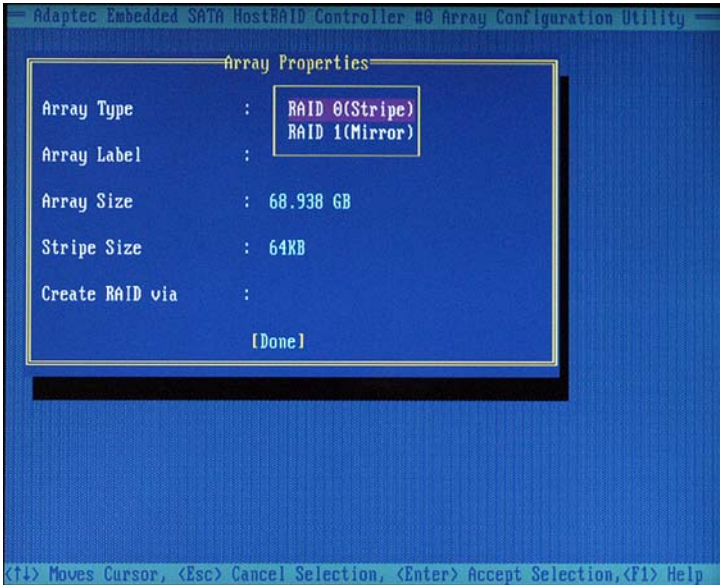

2. Under the item "**Arrays Label**", type in an label and press **Enter**. (\***Note**: The label shall not be more than 15 characters.)
3. For RAID 0, select the desired stripe size. (\***Note**: Available stripe sizes are 16, 32, and 64 KB-default. It is recommended that you *do not* change the default setting.)
4. The item: "**Create RAID via**" allows you to select between the different creating methods for RAID 0 and RAID 1.

The following table gives examples of when each is appropriate.

Raid Level	Create Via	When Appropriate
RAID 0	No Init	Creating a RAID 0 on new drives
RAID 0	Migrate (* <b>Note</b> )	Creating a RAID 0 from one new drive and one drive with data you wish to preserve
RAID 1	Build1	Any time you wish to create a RAID 1, but especially if you have data on one drive that you wish to preserve
RAID 1	Clear	Creating a RAID 1 on new drives, or when you want to ensure that the array contains no data after creation.
RAID 1	Quick	Fastest way to create a RAID 1. Appropriate when using new drives
RAID 1	Init	

(\***Note**: If you select Migrate for RAID 0, or Build for RAID 1, you will be asked to select the source drive. The contents of the source drive will be preserved. However, the data on the new drive will be lost.)



5. When you are finished, press **Done** (as the screen shown below).

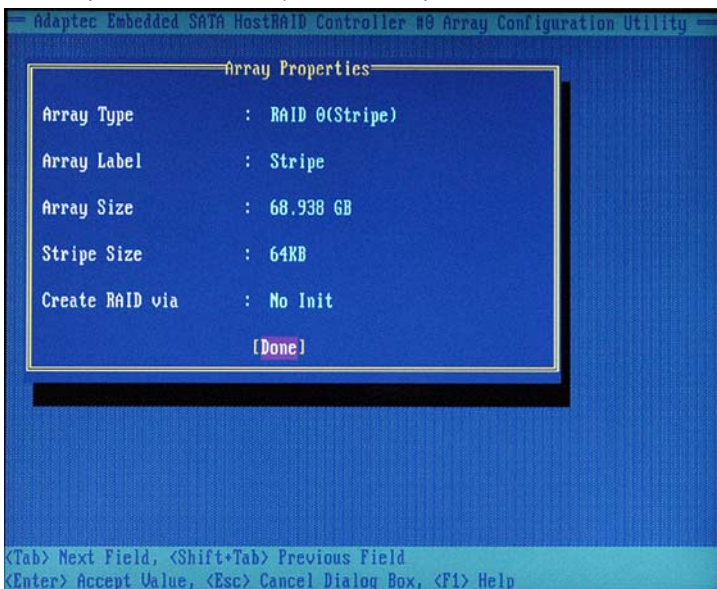

**Notes:**

1. Before adding a new drive to an array, back up any data contained on the new drive. Otherwise, all data will be lost.
2. If you stop the Build or Clear process on a RAID 1 from ACU, you can restart it by pressing Ctrl+R.
3. A RAID 1 created using the Quick Init option may return some data mismatches if you later run a consistency check. This is normal and is not a cause for concern.
4. The ACU allows you to use drives of different sizes in a RAID . However, during a build operation, only the smaller drive can be selected as the source or first drive.
5. When migrating from single volume to RAID 0, migrating from a larger drive to a smaller drive is allowed. However, the destination drive must be at least half the capacity of the source drive.
6. Adaptec does not recommend that you migrate or build an array on Windows dynamic disks (volumes), as it will result in data loss.

**Warning:** Do not interrupt the creation of a RAID 0 using the Migrate option. If you do, you will not be able to restart, or to recover the data that was on the source drive.

## Adding a Bootable Array

To make an array bootable:

1. From the Main menu, select **Manage Arrays**.
2. From the List of Arrays, select the array you want to make bootable, and press **Ctrl+B**.
3. Enter Y to create a bootable array when the following message is displayed: "This will make all other existing bootable array non-bootable. Do you want to make this array bootable? (Yes/No):" Then, a bootable array will be created. An asterisk will appear next to the bootable array (as shown in the picture below:)

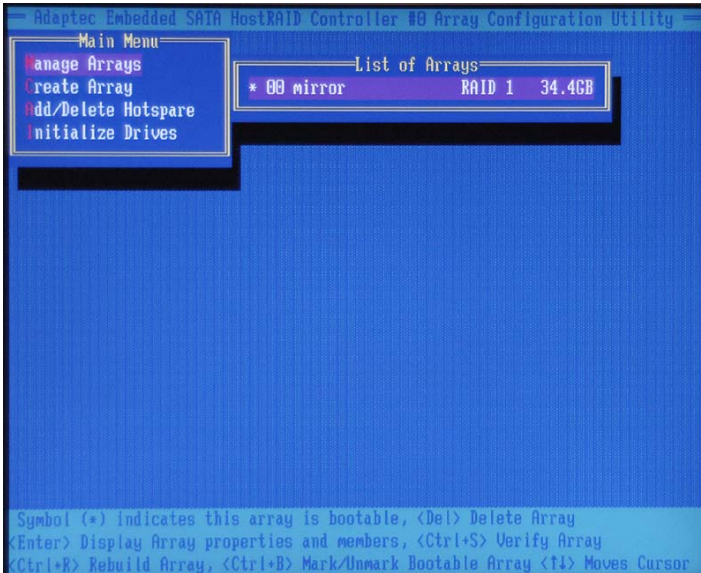

## Deleting a Bootable Array

To delete a bootable array:

1. From the Main menu, select **Manage Arrays**.
2. From the List of Arrays, select the bootable array (\*) you want to delete, and press **Ctrl+B**. (\* a bootable array is the array marked with an asterisk (as shown in the picture above.)
3. Enter Y to delete a bootable array when the following message is displayed: "The array is already marked bootable. Do you want to make this array as not bootable? (Yes/No):" Then, the bootable array will be deleted and the asterisk will disappear.

**(\*Note: do not use the delete key to delete the bootable array.)**

### **Adding/Deleting Hotspares**

(\*Note: In order to rebuild a RAID (RAID 0 or RAID 1), you would need to add a new HDD as a hotspare.)

1. Turn on your computer and press Ctrl+A as prompted to access the ARC Utility.
2. From the ARC menu, select Array Configuration Utility (ACU).
3. From the ACU menu, select Add/Delete Hotspares.
4. Use the up and down arrow keys to highlight and select the disk you want to designate as a hotspare, and press <Insert>, and then, press <Enter>.
5. Press yes when the following prompt is displayed:

"Do you want to create spare?" (Yes/No?)

The spare you have selected will appear in the Select Drive Menu.



## Initializing Disk Drives

If an installed disk does not appear in the disk selection list for creating a new array, or if it appears grayed out, you may have to initialize it before you can use it as part of an array. Drives attached to the controller must be initialized before they can be used in an array.

**Caution:** Initializing a disk overwrites the partition table on the disk and makes any data on the disk inaccessible. If the drive is used in an array, you may not be able to use the array again.

**Do not** initialize a disk that is part of a boot array. To determine which disks are associated with a particular array, please refer to [Viewing Array Properties](#).

### To initialize drives:

1. Turn on your computer and press **Ctrl+A** when prompted to access the ARC utility.
2. From the ARC menu, select **Array Configuration Utility (ACU)** (as shown in the screen below).

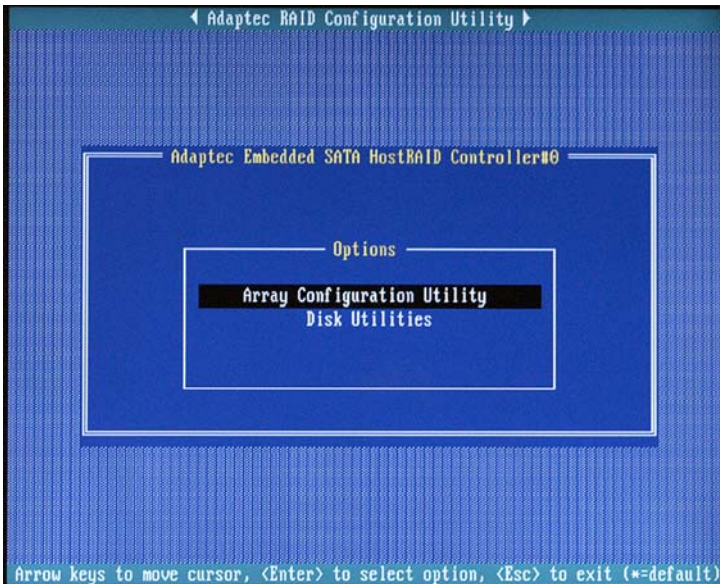

3. Select **Initialize Drives** (as shown in the screen below).

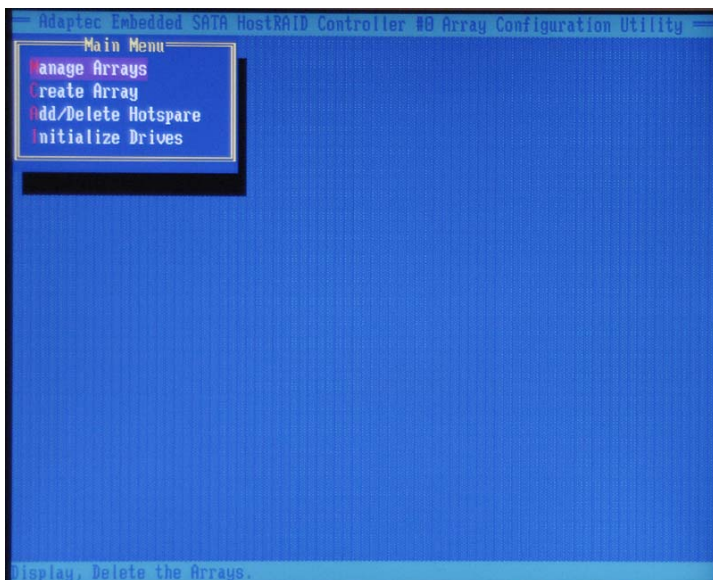

4. Use the up and down arrow keys to highlight the disk you wish to initialize and press **Insert** (as shown in the screen below).

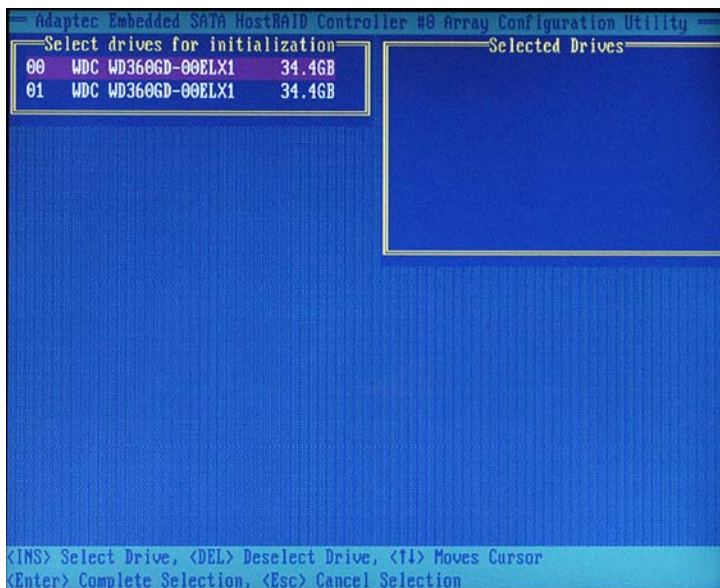

- Repeat [Step 4](#) so that both drives to be initialized are selected (as shown in the screen below).

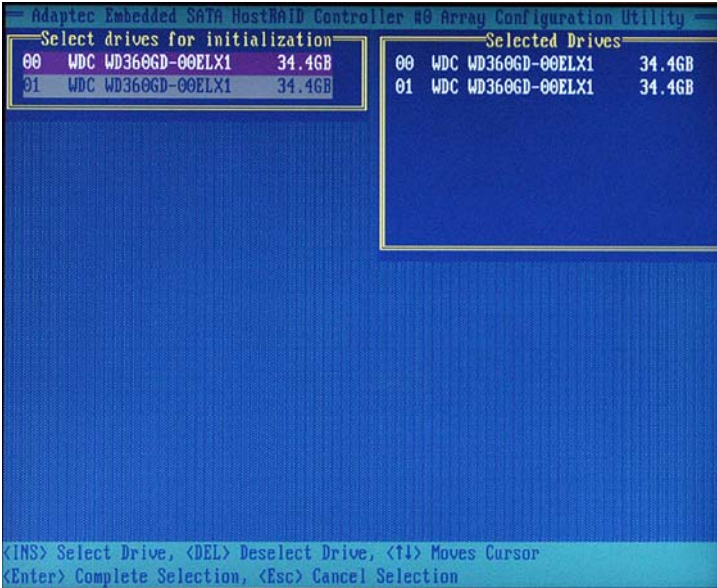

- Press **Enter**.
- Read the warning message as shown in the screen.

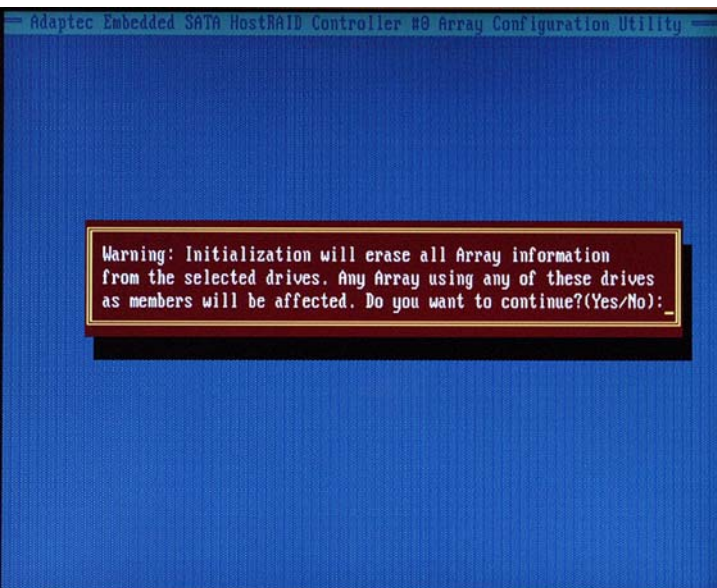

- Make sure that you have selected the correct disk drives to initialize. If correct, type **Y** to continue.

## Rebuilding Arrays

**\*Note 1:** Rebuilding applies to Fault Tolerant array (RAID 1) only.

If an array Build process (or initialization) is interrupted or critical with one member missing, you must perform a Rebuild to optimized its functionality. For a critical array Rebuild operation, the optimal drive is the source drive.

**\*Note 2:** If no spare array exists and a hard disk drive fails, you need to create a spare before you can rebuild an array.

### To Rebuild an array:

**1** From the Main Menu, select **Manage Arrays** (as shown in the screen below). From the List of Arrays, select the array you want to Rebuild.

**2** Press **Ctrl+R** to Rebuild.

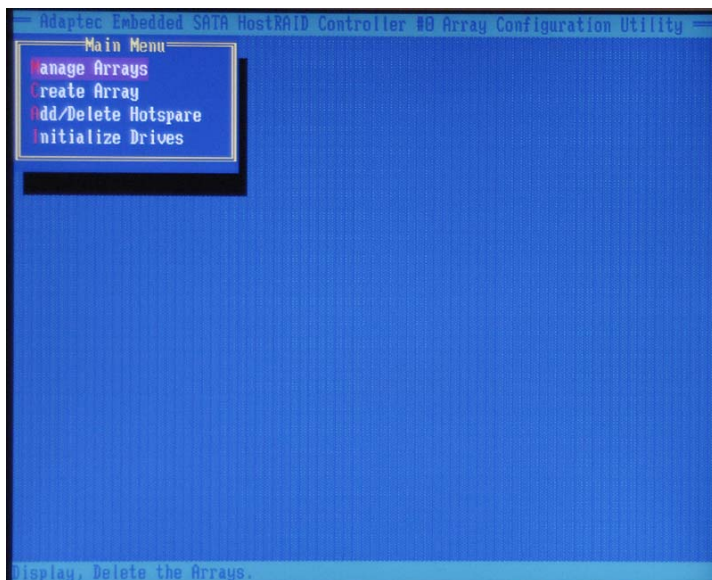



## Using the Disk Utilities

The Disk Utilities enable you to format or verify the media of your Serial ATA hard disks.

### To access the disk utilities:

1. Turn on your computer and press **Ctrl+A** when prompted to access the ARC utility (as shown in the screen below.)

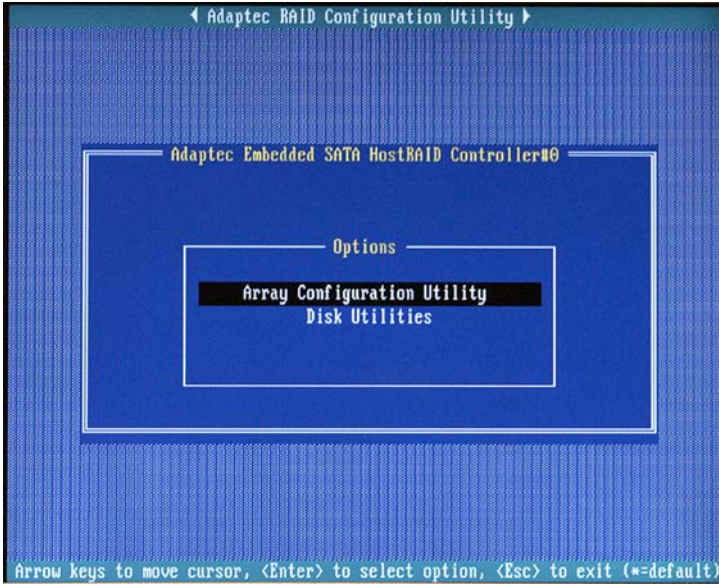

2. From the ARC menu, select **Disk Utilities** as shown in the screen below.

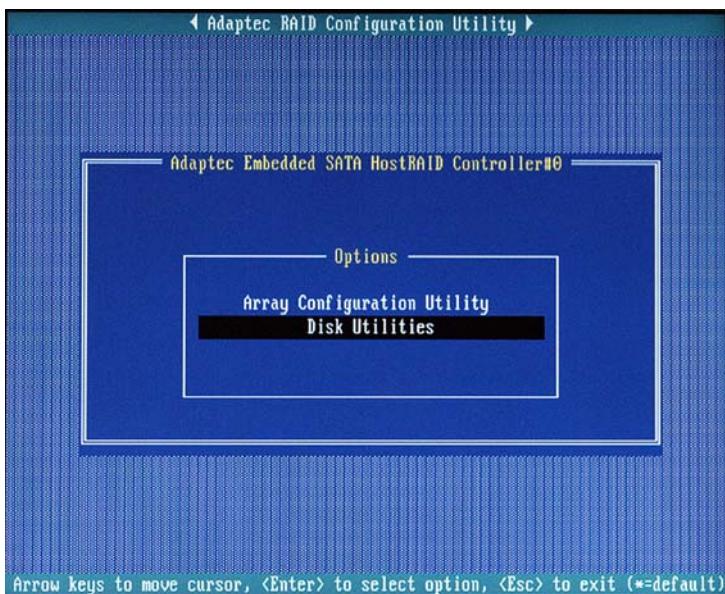

- 3 Select the desired disk and press **Enter** (as shown in the screen below.)

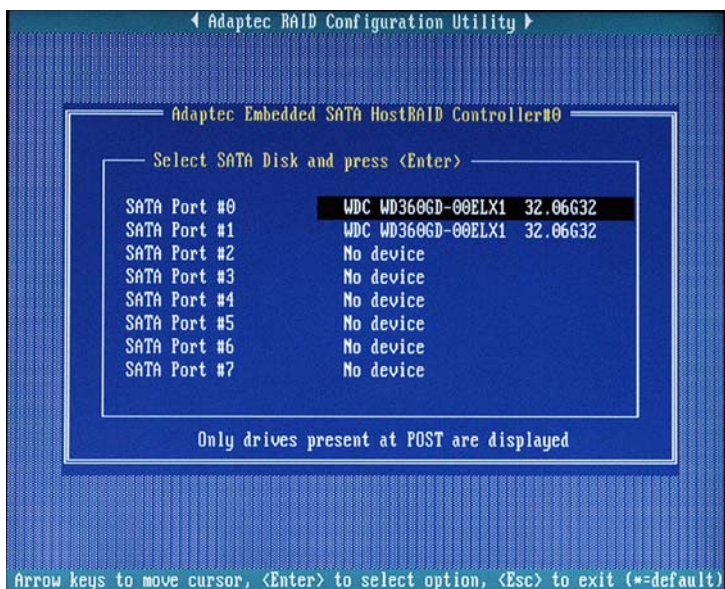

**You can choose from the following options:**

**1. Format Disk**—Simulates a low-level format of the hard drive by writing zeros to the entire disk. Serial ATA drives are low-level formatted at the factory and do not need to be low-level formatted again.

(\***Caution:** Formatting destroys all data on the drive. Be sure to back up your data before performing this operation.)

**2. Verify Disk Media**—Scans the media of a disk drive for defects.

**To Exit Adaptec RAID Configuration Utility**

1. Once you have completed RAID array configurations, press **ESC** to exit. The following screen will appear.

2. Press **Yes** to exit the Utility.

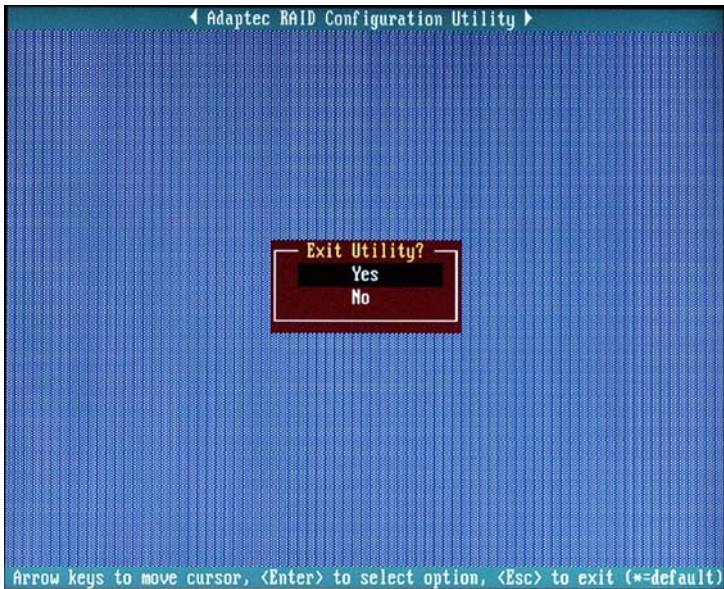

(\***For more information regarding Adaptec RAID Utility, please refer to Adaptec's User's Guide in the CD included in your shipping package. You can also download a copy of Adaptec User's Guide from our web site at: [www. supermicro.com.](http://www.supermicro.com)**\*)

## **C-2 Installing Intel's Hance Rapids Driver by Adaptec and the OS**

- a. Insert Supermicro's bootable CD that came with the package into the CD Drive during the system reboot, and the screen:"Super Micro Driver Diskette Maker" will appear.
- b. Choose from the list the item: "Intel Hance Rapids Driver by 3rd Party (Adaptec)" and press <ENTER>.
- c. From the next screen displayed, choose the OS driver you want to install and press <Enter>.
- d. Insert a formatted diskette into drive A: and press <Enter> as prompted.
- e. Exit the program after the process is completed. Then, reboot the system.
- f. Insert Microsoft Windows OS Setup CD in the CD Driver, and the system will start to boot up from CD.
- g. Press the <F6> key when the message-"Press F6 if you need to install a third party SCSI or RAID driver" displays.
- h. When the Windows OS Setup screen appears, press "S" to specify additional device(s).
- i. Insert the driver diskette-"Adaptec Embedded Serial ATA Raid Controller Driver" into Drive A: and press the <Enter> key.
- j. Choose Adaptec Embedded Host Serial ATA Raid Controller from the list indicated in the Windows OS Setup Screen, and press the <Enter> key.
- k. Press the <Enter> key to continue the installation process. (If you need to specify any additional devices to be installed, do it at this time.) Once all devices are specified, press the <Enter> key to continue with the installation.
- l. From the Windows OS Setup screen, press the <Enter> key. The OS Setup will automatically load all device files, and, then, continue the Windows OS installation.
- m. After Windows OS Installation is completed, the system will automatically reboot.



## C-3 Installing Other Software Programs and Drivers

### A. Installing Drivers other than Adaptec Embedded Serial ATA RAID Controller Driver

After you've installed Windows Operating System, a screen as shown below will appear. You are ready to install software programs and drivers that have not yet been installed. To install these software programs and drivers, click the icons to the right of these items.

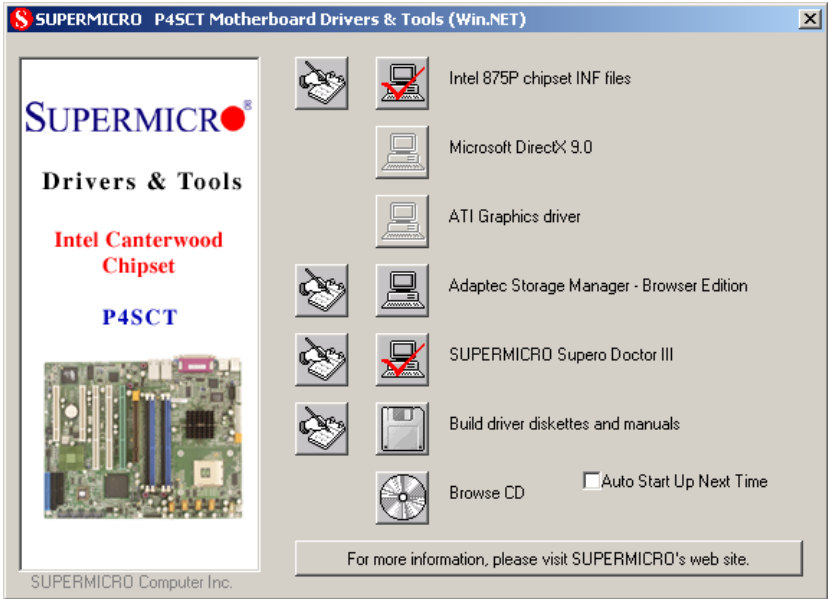

**Driver/Tool Installation Display Screen**

(\*Note: Click the icons showing a hand writing on paper to view the readme files for each item. Click the computer icons to the right of these items to install each item (from top to the bottom) one at a time. **After installing each item, you must re-boot the system before moving on to the next item on the list.** You should install everything here except for the SUPER Doctor utility, Intel LDCM and the LAN/SCSI driver diskettes, which are optional. The bottom icon with a CD on it allows you to view the entire contents of the CD. )

(\*Please refer to the Adaptec User's Guide for the installation of Adaptec's Serial ATA RAID Controller Driver. Adaptec's User's Guide is included in the CD. You can also download a copy of the user's guide from our web site.)

## Supero Doctor III

The Supero Doctor III program is a Web base management tool that supports remote management capability. It includes Remote and Local Management tools. The local management is called SD III Client. The Supero Doctor III program included on the CDROM that came with your motherboard allows you to monitor the environment and operations of your system. Supero Doctor III displays crucial system information such as CPU temperature, system voltages and fan status. See the Figure below for a display of the Supero Doctor III interface.

### Supero Doctor III Interface Display Screen-I (Health Information)

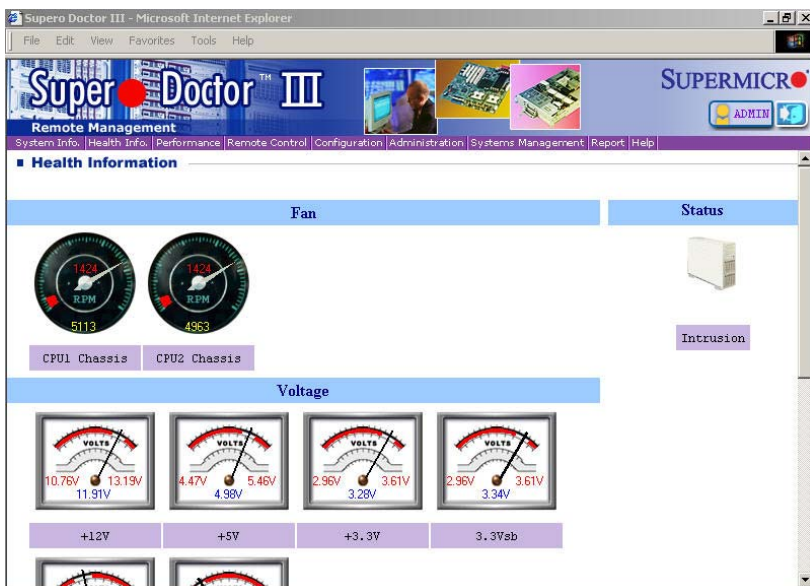

## Supero Doctor III Interface Display Screen-II (Remote Control)



**Graceful power control**

Supero Doctor III allows a user to inform the OS to reboot or shut down within a specified time (the default is 30 seconds). Before the system reboots or shuts down, it's allowed to cancel the action.

**Requirements**

Keep Supero SD3Service Daemon running at all times on this system.  
Provide TCP/IP connectivity.

**Power control**

(\*Note: SD III Software Revision 1.0 can be downloaded from our Web site at: [ftp://ftp.supermicro.com/utility/Supero\\_Doctor\\_III/](ftp://ftp.supermicro.com/utility/Supero_Doctor_III/). You can also download SDIII User's Guide at: <http://www.supermicro.com/PRODUCT/Manuals/SDIII/UserGuide.pdf>. For Linux, we will still recommend Supero Doctor II.)

**Notes**