



# SMCWPCIT-G EZ Connect™ g 108Mbps Wireless PCI Adapter

USER GUIDE





# **EZ Connect™ g 108Mbps Wireless PCI Adapter User Guide**

---

The easy way to make all your network connections

**SMC**®

**Networks**

38 Tesla

Irvine, CA 92618

Phone: (949) 679-8000

May 2005

Pub No: R01

## Copyright

Information furnished by SMC Networks, Inc. (SMC) is believed to be accurate and reliable. However, no responsibility is assumed by SMC for its use, nor for any infringements of patents or other rights of third parties which may result from its use. No license is granted by implication or otherwise under any patent or patent rights of SMC. SMC reserves the right to change specifications at any time without notice.

Copyright © 2005 by  
SMC Networks, Inc.  
38 Tesla  
Irvine, CA 92618

### **Trademarks:**

SMC is a registered trademark; and EZ Connect is a trademark of SMC Networks, Inc. Other product and company names are trademarks or registered trademarks of their respective holders.

# Compliances

## Federal Communication Commission Interference Statement

This equipment has been tested and found to comply with the limits for a Class B digital device, pursuant to Part 15 of the FCC Rules. These limits are designed to provide reasonable protection against harmful interference in a residential installation. This equipment generates, uses and can radiate radio frequency energy and, if not installed and used in accordance with instructions, may cause harmful interference to radio communications. However, there is no guarantee that the interference will not occur in a particular installation. If this equipment does cause harmful interference to radio or television reception, which can be determined by turning the equipment off and on, the user is encouraged to try to correct the interference by one or more of the following measures:

- Reorient or relocate the receiving antenna
- Increase the separation between the equipment and receiver
- Connect the equipment into an outlet on a circuit different from that to which the receiver is connected
- Consult the dealer or an experienced radio/TV technician for help

**FCC Caution:** To assure continued compliance, (example - use only shielded interface cables when connecting to computer or peripheral devices) any changes or modifications not expressly approved by the party responsible for compliance could void the user's authority to operate this equipment.

This device complies with Part 15 of the FCC Rules. Operation is subject to the following two conditions: (1) This device may not cause harmful interference, and (2) this device must accept any interference received, including interference that may cause undesired operation.

## IMPORTANT STATEMENT FCC Radiation Exposure Statement

This equipment complies with FCC radiation exposure limits set forth for an uncontrolled environment. This equipment should be installed and operated with a minimum distance of 20 cm (8 in) between the radiator and your body. This transmitter must not be co-located or operating in conjunction with any other antenna or transmitter.

IEEE 802.11b or 802.11g operation of this product in the U.S.A. is firmware-limited to channels 1 through 11.

### Industry Canada - Class B

This digital apparatus does not exceed the Class B limits for radio noise emissions from digital apparatus as set out in the interference-causing equipment standard entitled "Digital Apparatus," ICES-003 of Industry Canada.

Cet appareil numérique respecte les limites de bruits radioélectriques applicables aux appareils numériques de Classe B prescrites dans la norme sur le matériel brouilleur: "Appareils Numériques," NMB-003 édictée par l'Industrie.

Operation is subject to the following two conditions:

- 1) this device may not cause interference and
- 2) this device must accept any interference, including interference that may cause undesired operation of the device

This device has been designed to operate with an antenna having a maximum gain of 2 dBi.

Antenna having a higher gain is strictly prohibited per regulations of Industry Canada. The required antenna impedance is 50 ohms.

To reduce potential radio interference to other users, the antenna type and its gain should be so chosen that the EIRP is not more than required for successful communication.

To prevent radio interference to the licensed service, this device is intended to be operated indoors and away from windows to provide maximum shielding. Equipment (or its transmit antenna) that is installed outdoors is subject to licensing.

### EC Conformance Declaration

SMC contact for these products in Europe is:

SMC Networks Europe,  
Edificio Conata II,  
Calle Frutuós Gelabert 6-8, 2o, 4a,  
08970 - Sant Joan Despí,  
Barcelona, Spain.

Marking by the above symbol indicates compliance with the Essential Requirements of the R&TTE Directive of the European Union (1999/5/EC). This equipment meets the following conformance standards:

- EN 300 328-1 December 2001 V1.3.1
- EN 300 328-2 December 2001 V1.2.1
- EN 301 489-1 September 2001 V1.4.1
- EN 301 489-17 September 2000 V1.2.1
- EN 60950 January 2000

## Countries of Operation & Conditions of Use in the European Community

This device is intended to be operated in all countries of the European Community. Requirements for indoor vs. outdoor operation, license requirements and allowed channels of operation apply in some countries as described below:

- Note:** The user must use the configuration utility provided with this product to ensure the channels of operation are in conformance with the spectrum usage rules for European Community countries as described below.
- This device requires that the user or installer properly enter the current country of operation in the command line interface as described in the user guide, before operating this device.
  - This device will automatically limit the allowable channels determined by the current country of operation. Incorrectly entering the country of operation may result in illegal operation and may cause harmful interference to other system. The user is obligated to ensure the device is operating according to the channel limitations, indoor/outdoor restrictions and license requirements for each European Community country as described in this document.
  - This device may be operated *indoors or outdoors* in all countries of the European Community using the 2.4 GHz band: Channels 1 - 13, except where noted below.
    - In Italy the end-user must apply for a license from the national spectrum authority to operate this device outdoors.
    - In Belgium outdoor operation is only permitted using the 2.46 - 2.4835 GHz band: Channel 13.
    - In France outdoor operation is only permitted using the 2.457 - 2.472 GHz band: Channels 10 - 13.

## Declaration of Conformity in Languages of the European Community

English	Hereby, SMC Networks, declares that this Radio LAN device is in compliance with the essential requirements and other relevant provisions of Directive 1999/5/EC.
Finnish	Valmistaja SMC Networks vakuuttaa täten että Radio LAN device tyyppinen laite on direktiivin 1999/5/EY oleellisten vaatimusten ja sitä koskevien direktiivin muiden ehtojen mukainen.
Dutch	Hierbij verklaart SMC Networks dat het toestel Radio LAN device in overeenstemming is met de essentiële eisen en de andere relevante bepalingen van richtlijn 1999/5/EG  Bij deze SMC Networks dat deze Radio LAN device voldoet aan de essentiële eisen en aan de overige relevante bepalingen van Richtlijn 1999/5/EC.

## Compliances

French	Par la présente SMC Networks déclare que l'appareil Radio LAN device est conforme aux exigences essentielles et aux autres dispositions pertinentes de la directive 1999/5/CE
Swedish	Härmed intygar SMC Networks att denna Radio LAN device står i överensstämmelse med de väsentliga egenskapskrav och övriga relevanta bestämmelser som framgår av direktiv 1999/5/EG.
Danish	I Undertegnede SMC Networks erklærer herved at følgende Με την παρούσα smc networks δηλώνει ότι radio LAN device συμμορφώνεται προς τις ουσιαστικές απαιτήσεις και τις λοιπές σχετικές διατάξεις της οδηγίας 1999/5/εκ
German	Hiermit erklärt SMC Networks, dass sich dieser/diese/dieses Radio LAN device in Übereinstimmung mit den grundlegenden Anforderungen und den anderen relevanten Vorschriften der Richtlinie 1999/5/EG befindet". (BMW)  Hiermit erklärt SMC Networks die Übereinstimmung des Gerätes Radio LAN device mit den grundlegenden Anforderungen und den anderen relevanten Festlegungen der Richtlinie 1999/5/EG. (Wien)
Greek	
Italian	Con la presente SMC Networks dichiara che questo Radio LAN device è conforme ai requisiti essenziali ed alle altre disposizioni pertinenti stabilite dalla direttiva 1999/5/CE.
Spanish	Por medio de la presente SMC Networks declara que el Radio LAN device cumple con los requisitos esenciales y cualesquiera otras disposiciones aplicables o exigibles de la Directiva 1999/5/CE
Portuguese	SMC Networks declara que este Radio LAN device está conforme com os requisitos essenciais e outras disposições da Directiva 1999/5/CE.



# TABLE OF CONTENTS

<b>EZ Connect™g 108Mbps WLAN PCI</b> .....	<b>1</b>
Features .....	1
Applications .....	2
System Requirements .....	3
Package Checklist .....	4
<b>Hardware Description</b> .....	<b>5</b>
LED Indicators .....	5
<b>Hardware Installation</b> .....	<b>6</b>
<b>Driver and Utility Installation</b> .....	<b>8</b>
Using the Installation Wizard .....	8
<b>Utility Configuration</b> .....	<b>14</b>
Using the SMCWPCIT-G Utility Program .....	14
Configuration .....	15
Link Information .....	22
IP Information .....	24
Site Survey .....	25
Version Information .....	26
<b>Network Configuration and Planning</b> .....	<b>27</b>
Network Topologies .....	27
Ad Hoc Wireless LAN .....	27
Infrastructure Wireless LAN .....	28
Setting the Communication Domain .....	29
Stationary Wireless PCs .....	29
Roaming Wireless PCs .....	29

*TABLE OF CONTENTS*

**Troubleshooting** .....**31**  
Adapter Installation Problems ..... 31  
Network Connection Problems ..... 32  
    SMCWPCIT-G Maximum Distance Table ..... 33

**Specifications** .....**35**

# EZ CONNECT™G 108Mbps WIRELESS PCI ADAPTER

SMC's EZ Connect™g 108Mbps Wireless PCI Adapter (SMCWPCIT-G) is a wireless network adapter for desktop PCs that seamlessly integrates with existing Ethernet networks. This solution offers a high data rate and reliable wireless connectivity with considerable cost savings over wired LANs (which include long-term maintenance overhead for cabling). Just install enough wireless access points to cover your network area, plug wireless cards into your desktop computers, and start networking.

Using this card in conjunction with SMCWEB-G wireless access points, you can create an instant network that integrates seamlessly with 10/100 Mbps Ethernet LANs. Moving or expanding your network is as easy as moving or installing additional access points – no wires!

## Features

- Up to 108Mbps data rate
- Wireless connection without the hassles and cost of cabling
- Greater flexibility to locate or move networked computers
- Integrates with or replaces wired LANs at dramatically lower cost than wired alternatives
- Seamless connectivity to wired Ethernet LANs augments existing networks quickly and easily
- Easy installation

## APPLICATIONS

- Working range up to 160 m (528 ft) at 54 Mbps, or up to 350 m (1,155 ft) at 1 Mbps for indoor communications
- Direct Sequence Spread-Spectrum (DSSS) technology provides robust, interference-resistant and secure wireless connection
- Supports a wide range of systems (Windows 98SE/Me/2000/XP)
- Plug-and-Play
- Provides a user-friendly interface for configuration
- Enhances your network security with WEP data encryption
- Removable antenna

## Applications

EZ Connect™ g wireless products offer fast and reliable network access for wireless clients in applications such as:

- **Remote access to corporate network information**  
Email, file transfer, and terminal emulation
- **Difficult-to-wire environments**  
Historic or old buildings, asbestos installations, and open areas where wiring is difficult to employ
- **Frequently changing environments**  
Retailers, manufacturers, and banks who frequently rearrange the workplace and change location

- **Temporary LANs for special projects or peak time**

Trade shows, exhibitions, and construction sites that need to set up for a short time period. Retailers, airline, and shipping companies who need additional workstations for peak periods. Auditors who require workgroups at customer sites

- **Access to databases for mobile workers**

Doctors, nurses, retailers, office workers who need access to databases while being mobile in a hospital, retail store, office, campus etc.

- **SOHO users**

SOHO (Small Office Home Office) users who need quick and easy installation of a small computer network

## System Requirements

Before you install the Wireless PCI Adapter, check your system for the following requirements:

- A computer with a bus-mastered PCI slot, and PCI card and socket services compliant with revision 2.2 of the PCI specification
- Windows 98SE/Me/2000/XP (have the Windows OS installation CD ready for use during driver installation)
- A minimum of 6 Mbytes of free disk space for installing the driver and utility program
- Another IEEE 802.11b/g compliant device installed in your network, such as the SMCWEB-G Wireless Access Point, or another computer with a wireless adapter

## **Package Checklist**

The EZ Connect™g 108Mbps Wireless PCI Adapter package includes:

- 1 EZ Connect™g 108Mbps Wireless PCI Adapter
- 1 EZ Installation Wizard and Documentation CD
- 1 External Antenna
- 1 Quick Installation Guide

Please register this product and upgrade the product warranty at SMC's web site at [www.smc.com](http://www.smc.com)

Please inform your dealer if there are any incorrect, missing, or damaged parts. If possible, retain the carton, including the original packing materials. Use them again to repack the product if there is a need to return it for repair.

# HARDWARE DESCRIPTION

The Wireless PCI Adapter supports up to 108 Mbps connections. This card is fully compliant with the specifications defined in IEEE 802.11g standard. It is designed to complement PCI Local Bus computers and supports Windows 98SE/Me/2000/XP.

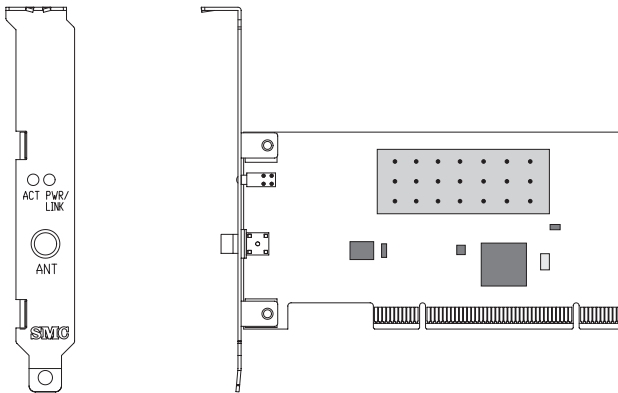

## LED Indicators

The Wireless PCI Adapter includes two status LED indicators, as described in the following table.

LED	Status	Description
Power/ Link	On	Indicates a valid connection with an access point.
	Flashing	Indicates that the Wireless PCI Adapter is operating in the ad hoc mode.
Activity	Flashing	Indicates that the Wireless PCI Adapter is browsing active access points.

# HARDWARE INSTALLATION

## **Warning:**

- This network adapter requires a PC and BIOS that supports the PCI Local Bus Specification v2.2 or later. If you are installing in an older computer model, upgrade the BIOS to the latest version.
  - Network cards are sensitive to static electricity. To protect the card, avoid touching its electrical components and always touch the metal chassis of your computer before handling the card.
1. Switch off the computer, unplug the power cord, and remove the computer's cover.
  2. Select an available bus-mastering PCI slot and remove the cover bracket.
  3. Detach the antenna from the Wireless PCI Adapter before inserting the card into a PCI slot.



4. Insert the network card into the slot so that it is firmly seated. Screw the card's bracket securely into the computer's chassis.

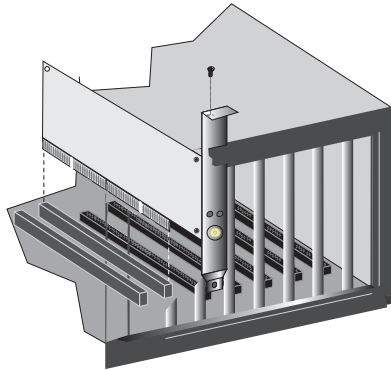

**Note:** Be careful that it does not touch any conducting parts on the computer motherboard.

5. Attach the antenna to the Wireless PCI Adapter.
6. Replace the chassis cover on your computer and power it on.
7. The Wireless PCI Adapter should be automatically configured by the host computer's BIOS. However, if you have an older computer, you may have to manually configure the computer's BIOS settings.
8. The installation CD contains all drivers for this card. Please read the RELEASE.TXT file on the disk for a list of all drivers. A text file is included with each driver to detail the proper installation procedure.
9. Install the Utility program for your Wireless PCI Adapter. The SETUP.EXE file of the utility program can be found on the CD.
10. Any new or updated drivers can be downloaded from SMC's web site (see the back cover of this guide).

# DRIVER AND UTILITY INSTALLATION

The SMCWPCIT-G EZ Installation Wizard and Documentation CD that comes with the package contains all the software drivers. Any new or updated software can be downloaded from SMC's web site at:

[http://www.smc.com/index.cfm?action=tech\\_support\\_support\\_tools](http://www.smc.com/index.cfm?action=tech_support_support_tools)

## Using the Installation Wizard

1. Insert the EZ Installation Wizard and Documentation CD into your CD-ROM drive. The program will auto-run. Click the **Install Driver/Utility** option on the wizard. The EZ Installation Wizard will start installing files into your system.

2. Windows XP will automatically install the driver.

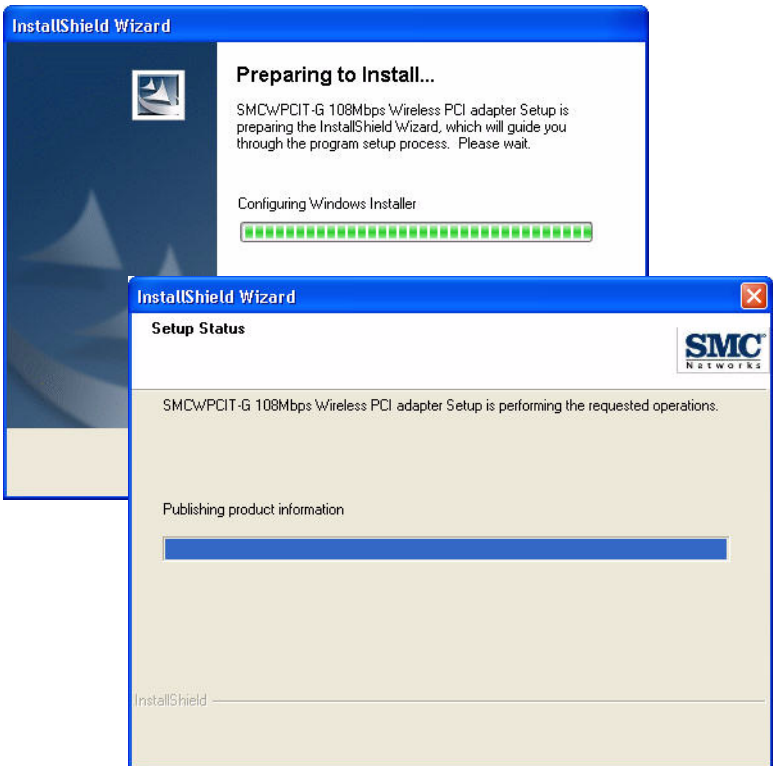

3. Then you will see the following message.



## USING THE INSTALLATION WIZARD

4. Once the adapter has been inserted into your PC, the **Found New Hardware Wizard** window will appear.



5. Select **Yes, this time only** and click **Next**.

6. Choose the **Install the software automatically** option, and click **Next**.

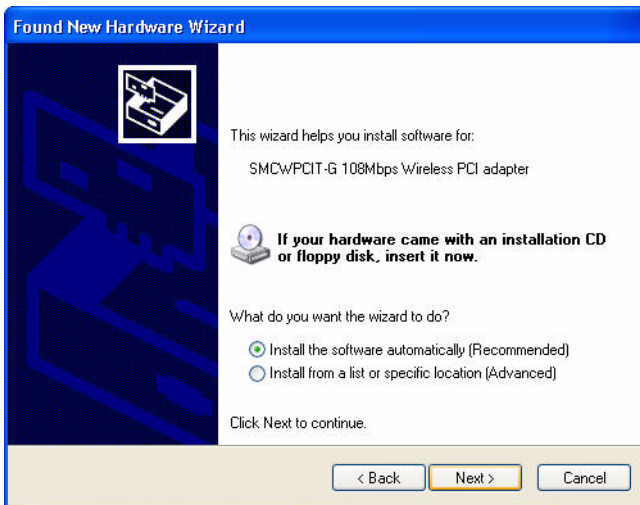

7. Click **Continue Anyway** to proceed with the installation.



## USING THE INSTALLATION WIZARD

**Note:** Do not select STOP Installation, as this will cancel the installation process, and the drivers will not be installed properly.

8. Click **Finish** to exit the wizard.

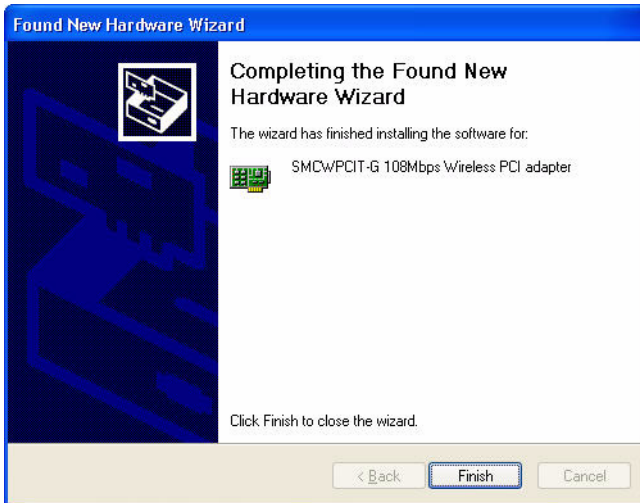

9. When the wizard has finished installing the driver, the following screen will appear. Select **Yes, I want to restart my computer now**. Click **Finish** and your PC will restart.

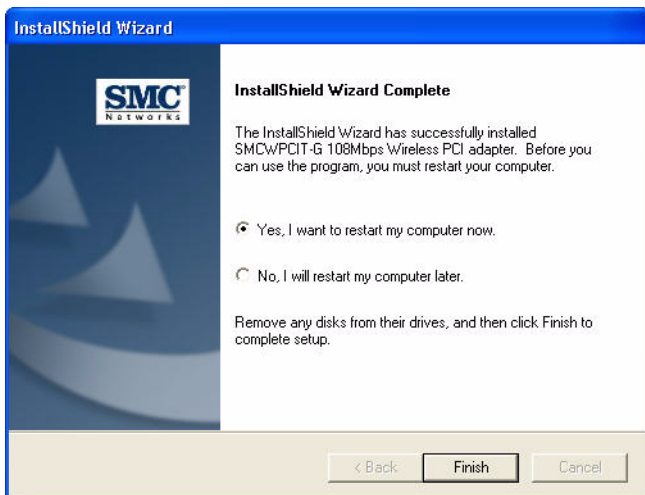

The driver and utility installation is completed. Your adapter is now ready for use.

# UTILITY CONFIGURATION

## Using the SMCWPCIT-G Utility Program

Once the installation is complete, the configuration utility can be accessed from the Start menu, or you can access it through the quick launch icon on the desktop.

When the utility program is running, there will be a quick launch icon in the lower right-hand corner of the task bar. If the icon is GREEN, you have a good connection. If it shows RED, try to turn the antenna in a different direction, or move closer to the access point on your network. If the icon is still RED, then follow the procedures described below, and verify that the SSID and radio channel are configured to match the settings on the access point to which you want to connect.

Double-clicking the quick launch icon will open the Wireless PCI Adapter Utility, providing quick access to the adapter settings.

The configuration utility includes the following tabs:

**Configuration** – Allows you to set parameters for the adapter.

**Link information**– Shows the connection status.

**IP information**– Displays TCP/IP data.

**Site Survey**– Scans/Shows all wireless devices within the adapter's signal range.

**Version information**– Shows the driver and utility version information.



**Wireless On/Off** - Click this button to turn on/turn off the radio signal of the adapter.

**Help** - Click this button to view the help file.

**Close** - Click this button to exit the utility.

## **Configuration**

When you start the Wireless PCI Adapter utility, the information window for the SMCWPCIT-G is shown as in the figure below.

**Select Profile** — To specify a profile for a specific configuration of parameters.

**New** — Click this button to create a new profile.

**Save** — Click this button to save a profile after configuring the settings.

**Delete** — Select the profile from the drop-down menu, and click this button to delete the profile.

**Auto Profile On/Off** — Click this button to turn on/off the Auto Profile feature.

**Active Profile** — The profile settings that you are using for the current connection.

## Common Tab

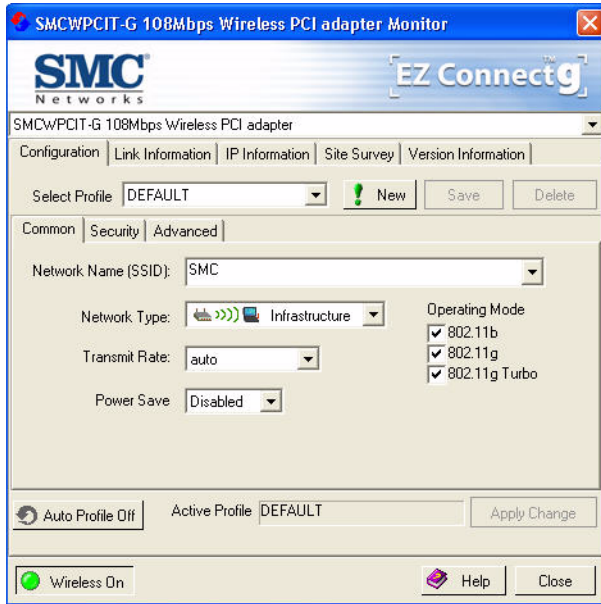

**Network Name (SSID)** — This is the Service Set ID (SSID) for the wireless network to which you want to connect.

**Network Type** — Set the station operation mode to ad hoc for network configurations that do not have an access point, or Infrastructure for configurations with an access point.

**Transmit Rate** — Set the transmit rate you want from the pull-down menu. Click Apply Changes after you have made your selection. Lower settings may improve throughput in environments hostile to radio transmission.

**Power Save** — Enable or disable the power saving feature.

## USING THE SMCWPCIT-G UTILITY PROGRAM

**Operating Mode** — The adapter supports 802.11b, 802.11g and 802.11g turbo mode. Check the type of network that you want to use for your wireless connection.

**Note:** 802.11g turbo mode is capable of Packet Bursting, Fast Frames, Compression, and Dynamic Turbo. It delivers the maximum operation speed of up to 108 Mbps. The Wireless PCI Adapter is backwards compatible with non-Turbo (legacy) devices. Dynamic Turbo mode is only enabled when all devices on the wireless network are SuperG with Dynamic Turbo enabled.

### Security Tab

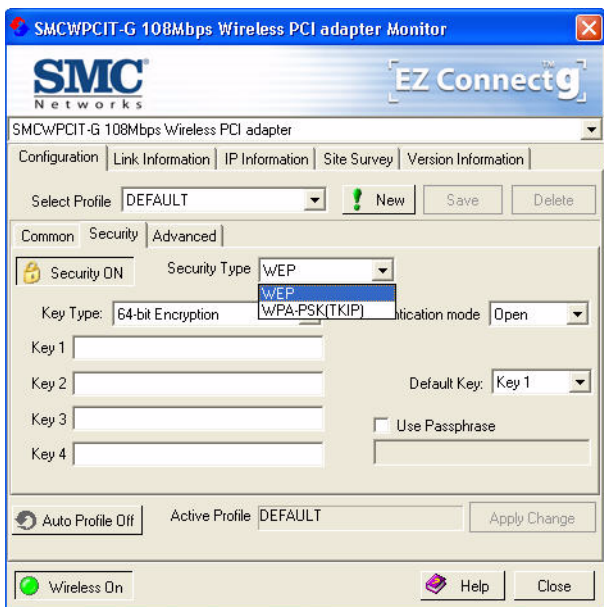

Go to the security tab to set the security features for your adapter.

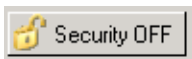

Click on this security button to turn on/turn off the security function.

Turn on the security function, and set detail parameters for your adapter.

To prevent unauthorized access, this adapter supports WEP (Wired Equivalent Privacy), and WPA (Wi-Fi Protected Access).

### *WEP*

WEP implemented in the SMCWPCIT-G is based on the RC4 encryption algorithm. The security keys provided to ensure data confidentiality are four 10-bit keys for the 64-bit WEP setting and one 26-bit key for the 128-bit WEP setting. WEP security protects your wireless LAN against eavesdropping and unauthorized access by intruders.

**Security Type** — WEP is supported by the adapter to prevent unauthorized access.

**Key Type** — Choose the **Key Type** (ASCII or Hex) from the drop-down list. ASCII: 13 regular text characters. Hex: 26 digits (0~9, A~F) hexadecimal characters.

**Authentication Mode** — Choose **Open** or **Shared**.

**Default Key** — Choose the **Key Number** that has the encryption string you prefer. If you are using a key generated from a passphrase, you must use the same passphrase and key on each station.

**Use Passphrase** — Check this box to auto-generate security keys for WEP encryption. Please note that you must use the same passphrase on all the stations in your network.

### WPA-PSK Encryption Type

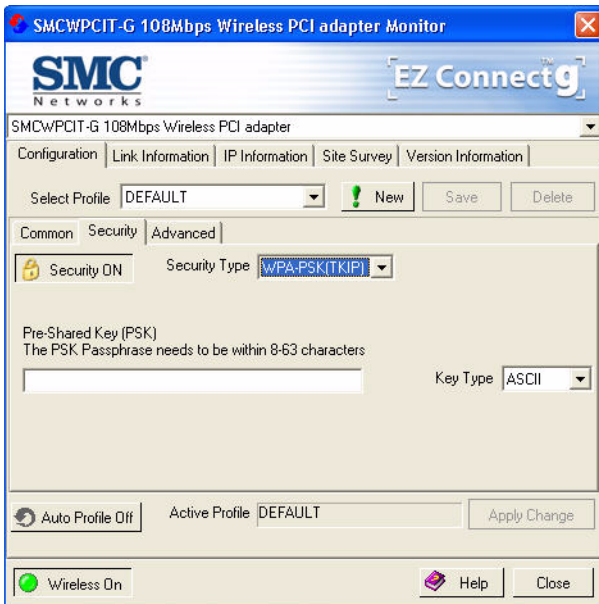

WPA is a stronger wireless security solution than WEP. It uses a combination of authentication and broadcast/session keys.

**Pre-Shared Key (PSK)** — If there is no authentication server on your SOHO network, you can issue the Pre-Shared Passphrase to the WLAN Cardbus. Please note that you must use the same passphrase on all the stations in your network.

**Key Type** — Choose the Key Type (ASCII or Hex) from the drop-down list.

**Notes:** 1. Manual Pre-Shared Key supports up to 64-Hex characters.

2. Type 8 - 63 Hex characters for the Pre-Shared Passphrase.

## USING THE SMCWPCIT-G UTILITY PROGRAM

3. Do not use a key that is long and complex for your clients to type accurately, as you might forget it.
4. A Hex (hexadecimal) digit is a number or letter in the range 0-9 or A-F.

### Advanced

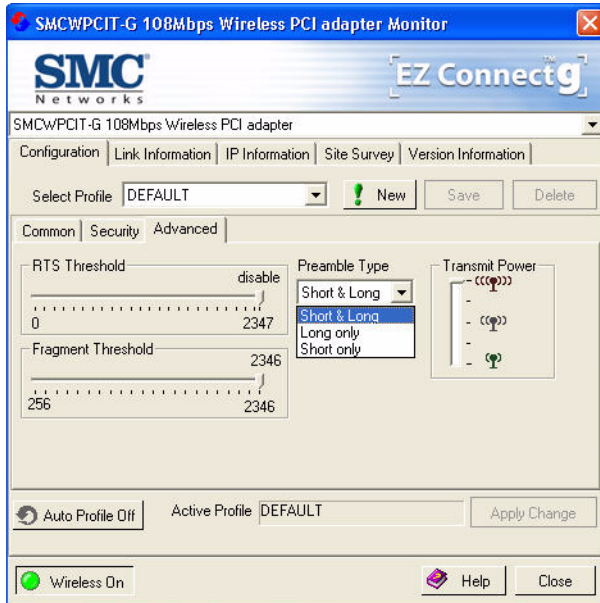

**RTS Threshold** - This sets the packet size threshold at which a Request to Send (RTS) signal must be sent to the receiving station prior to the sending station starting communications. Devices contending for the wireless medium may not be aware of each other. The RTS mechanism can solve this problem. The larger the threshold, the faster the speed.

## *USING THE SMCWPCIT-G UTILITY PROGRAM*

**Fragment Threshold** - Sets the minimum packet size that can be transmitted from the adapter without being fragmented.

Fragmentation can increase the reliability of transmissions because it increases the probability of a successful transmission due to smaller frame size. The larger the threshold, the faster the speed.

**Preamble Type** - The preamble is used to acquire the incoming signal and synchronize the receiver. If all the clients in your service area support the short preamble or can automatically set the preamble type, then setting the preamble on the access point to short can boost your throughput. (Options: Short & Long, Long only, Short only; Default: Short & Long)

**Transmit Power** - Move the slider bar up and down to select an appropriate transmission power. Lower power reduces interference, higher power gives more range.

## Link Information

The Link information screen displays information on the current wireless network to which you are connected.

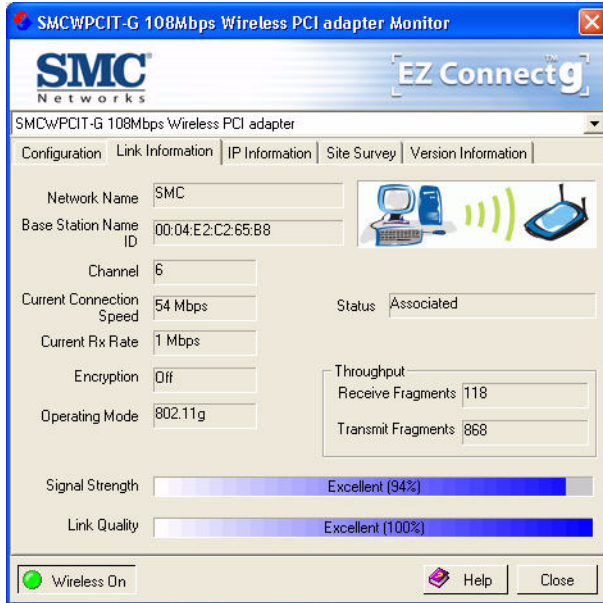

**Network Name** - This is the Service Set ID (SSID) for the wireless network to which you want to connect.

**Base Station Name ID** - The MAC address of the access point to which the card is connected in an infrastructure network. In an ad hoc network, this ID is a random number generated by the first station that communicates with other stations in the network. The BSS ID of the other stations will then be set to the same value.

**Channel** - This is the radio channel through which the access point communicates to stations within the same network. A Basic Service Set (BSS) consists of a group of wireless PCs and an access point that is directly connected to the wired LAN. To



## *USING THE SMCWPCIT-G UTILITY PROGRAM*

establish an ad hoc network, make sure the Channel is set to the same radio channel as that used by the other wireless clients in your group. However, if you are connecting to a network via an access point, the adapter will automatically use the same channel as that used by the access point.

The available channel settings are limited by local regulations that determine the number of available channels.

**Current Connection Speed** - Shows the speed of the current wireless connection.

**Current Rx Rate** - This is the transmission rate of the current connection.

**Encryption** - This shows the encryption type of your wireless network.

**Operating Mode** - This adapter supports 802.11b and 802.11g mode.

**Status** - This is the station status.

**Throughput** - Shows the total number of data packets transmitted and received.

**Signal Strength** - Shows the relative strength of the wireless connection.

**Link Quality** - Shows the link quality of the wireless connection.

## IP Information

The IP information screen displays TCP/IP information for the adapter.

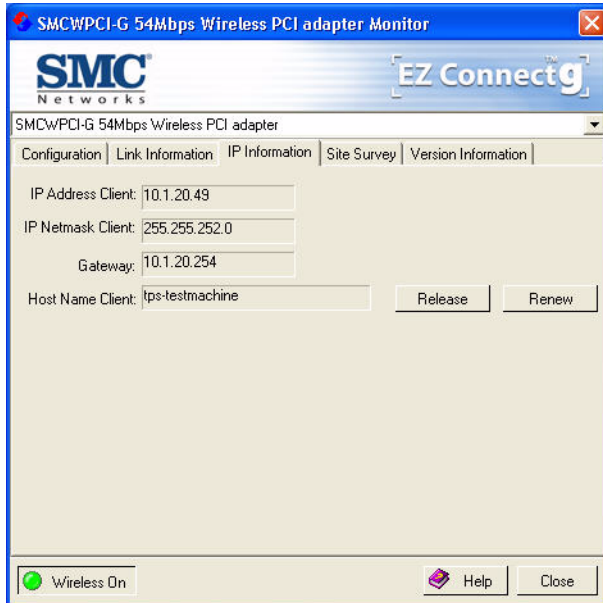

Now that you have configured your wireless adapter to connect to the wireless network, your adapter needs to obtain new network settings. By releasing old IP settings and renewing them with settings from the access point, you will also verify that the adapter is configured correctly.

**IP Address Client** – Internet address of your computer.

**IP Netmask Client** – A mask used to determine what subnet an IP address belongs to.

**Gateway** – The IP address of the network gateway.

**Host Name Client** – The computer's name on the network.

**Release** – Click on this button to release the IP address.

**Renew** – Click on this button to get a new IP address.

## Site Survey

The Site Survey screen scans and displays available wireless devices within range. Choose one of them to connect to by double-clicking on an entry.

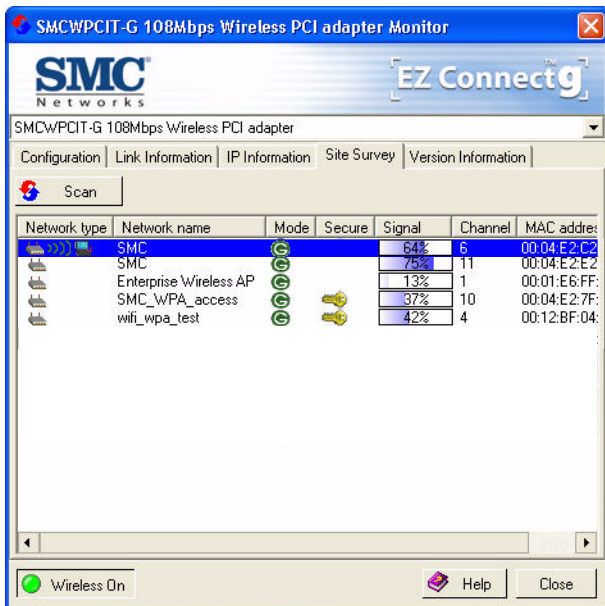

**Network Type** - Shows the network type. See “Configuration” on page 15.

**Network name** - Service Set ID (SSID) on the network. See “Configuration” on page 15.

**Mode** - Shows the wireless connection mode, whether it's 802.11b or 802.11g.

## USING THE SMCWPCIT-G UTILITY PROGRAM

**Secure** - This shows security mechanism has been enabled. A key icon indicates the encryption function is enabled.

**Signal** - This shows the signal strength of the listed wireless devices.

**Channel** - This is the channel used for the wireless connection.

**MAC address** - This is the MAC address of the listed wireless devices.

### Version Information

The following screen shows the current version information of the driver and configuration utility.

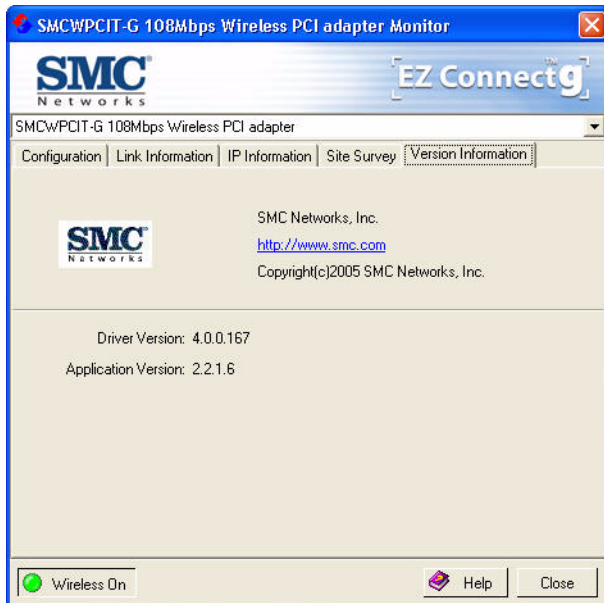

# NETWORK CONFIGURATION AND PLANNING

SMC's EZ Connect Wireless Solution supports a stand-alone wireless network configuration, as well as an integrated configuration with 10/100 Mbps Ethernet LANs.

The SMCWPCIT-G can be configured as:

- Ad hoc - for small groups that only communicate with each other
- Infrastructure - for mixed wired/wireless LANs

## Network Topologies

### Ad Hoc Wireless LAN

An ad hoc wireless LAN consists of a group of computers, each equipped with a wireless adapter, connected via radio signals as an independent wireless LAN. Computers in a specific ad hoc wireless LAN must be configured to the same radio channel. An ad hoc wireless LAN can be used in a SOHO or temporary environment.

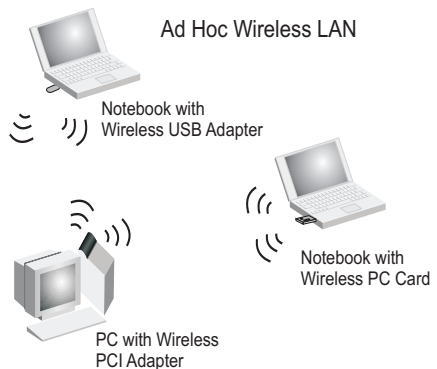

## Infrastructure Wireless LAN

The SMCWPCIT-G also provides wireless workstations with access to a wired LAN. An integrated wired and wireless LAN is called an Infrastructure configuration. A Basic Service Set (BSS) consists of a group of wireless PC users and an access point that is directly connected to the wired LAN. Each wireless PC in this BSS can talk to any computer in its wireless group via a radio link, or access other computers or network resources in the wired LAN Infrastructure via the access point.

The Infrastructure configuration not only extends the accessibility of wireless PCs to the wired LAN, but also extends the effective wireless transmission range for wireless PCs by passing their signal through one or more access points.

A wireless Infrastructure can be used for access to a central database, or for connection between mobile workers, as shown in the following figure.

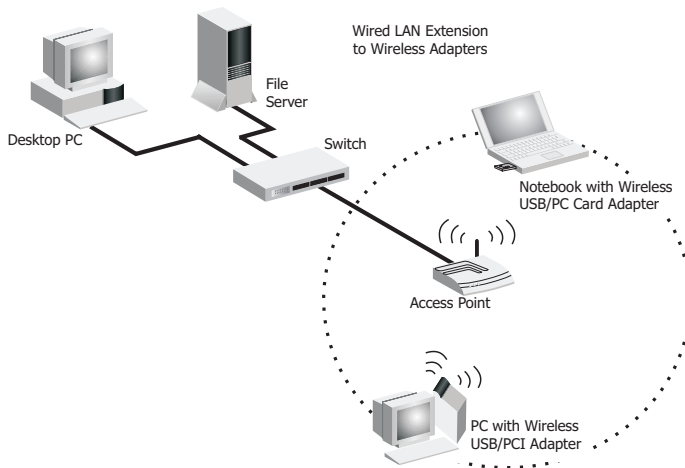

# Setting the Communication Domain

## Stationary Wireless PCs

The Basic Service Set (BSS) is the communication domain for each access point. For wireless PCs that do not need to support roaming, set the Service Set Identifier (SSID) for the wireless card to the SSID of the access point to which you want to connect. Check with your network administrator for the SSID.

## Roaming Wireless PCs

A wireless Infrastructure can also support roaming for mobile workers. More than one access point can be configured to create an Extended Service Set (ESS). By placing the access points so that a continuous coverage area is created, wireless users within this ESS can roam freely. All wireless adapters and access points within a specific ESS must be configured with the same SSID and to the same radio channel.

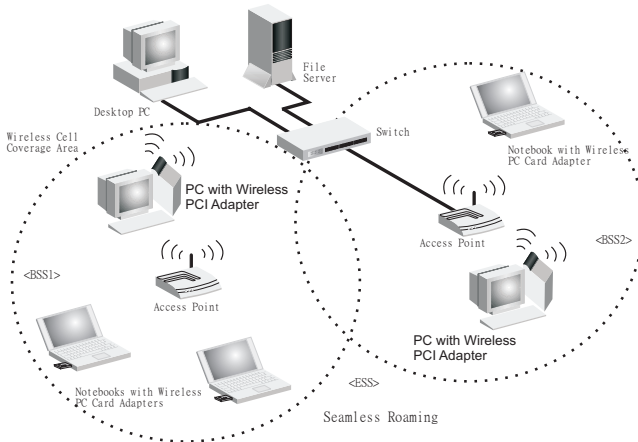

## *SETTING THE COMMUNICATION DOMAIN*

Before setting up an ESS for roaming, you need to choose a clear radio channel and a suitable location for the access points to maximize performance. (Refer to “Troubleshooting” on the following page for detailed information.)



# TROUBLESHOOTING

Check the following troubleshooting items before contacting SMC Technical Support.

## Adapter Installation Problems

If your computer cannot find the Wireless PCI Adapter, or the network driver does not install correctly, check the following:

- Make sure the adapter is securely seated in the PCI slot. Check for any hardware problems, such as physical damage to the card's connector.
- Try the card in another PCI slot. If this also fails, test your computer with another PCI adapter that is known to operate correctly.
- Make sure your computer is using the latest BIOS.
- If there are other network adapters in the computer, they may be causing conflicts. Remove other adapters from the computer and test the wireless adapter separately.
- Check for a defective computer or PC connection by trying the adapter in another computer that is known to operate correctly.

## **Network Connection Problems**

If the Link LED on the SMCWPCIT-G does not light, or if you cannot access network resources from the computer, check the following:

- Make sure the correct software driver is installed for your operating system. If necessary, try reinstalling the driver.
- Make sure the computer and other network devices are receiving power.
- The access point you want to attach to may be defective. Try using another access point.
- If you cannot access a Windows service on the network, check that you have enabled and configured the service correctly. If you cannot connect to a particular server, be sure that you have access rights and a valid ID and password.
- If you cannot access the Internet, be sure you have configured your system for TCP/IP.

If your wireless station cannot communicate with a computer in the Ethernet LAN when configured for Infrastructure mode, check the following:

- Make sure the access point that the station is associated with is powered on.
- If you still cannot connect, change the access point and all the stations within the BSS to another radio channel.
- Make sure the SSID is the same as that used by the BSS configured on the access point, or the same as that used by the access points in the extended service set (ESS).

## SMCWPCIT-G Maximum Distance Table

### Important Notice

Maximum distances posted below are actual tested distance thresholds. However, there are many variables such as barrier composition and construction, as well as local environmental interference that may impact your actual distances and cause you to experience distance thresholds far lower than those posted below. If you have any questions or comments regarding the features or performance of this product, or if you would like information regarding our full line of wireless products, visit us at [www.smc.com](http://www.smc.com), or call us toll-free at 800.SMC.4YOU. SMC Networks stands behind every product sold with a 30-day satisfaction guarantee and a limited-lifetime warranty.

<b>SMCWPCIT-G Wireless PCI Card Maximum Distance Table</b>				
<b>Environmental Condition</b>	<b>Speed and Distance Ranges</b>			
	11Mbps	5.5 Mbps	2 Mbps	1 Mbps
<b>Outdoors:</b> A line-of-sight environment with no interference or obstruction between the access point and users.	160 m (528ft)	195 m (640 ft)	255 m (837 ft)	350 m (1155 ft)
<b>Indoors:</b> A typical office or home environment with floor to ceiling obstructions between the access point and users.	72 m (236 ft)	73 m (240 ft)	73 m (240 ft)	75 m (246 ft)

## NETWORK CONNECTION PROBLEMS

SMCWPCIT-G Wireless PCI Card Maximum Distance Table							
Environmental Condition	Speed and Distance Ranges						
	54 Mbps	48 Mbps	36 Mbps	24 Mbps	18 Mbps	12 Mbps	6-9 Mbps
<b>Outdoors:</b> A line-of-sight environment with no interference or obstruction between the access point and users.	60 m (197 ft)	90 m (295 ft)	150 (492 ft)	190 (623 ft)	220 (722 ft)	270 (886 ft)	350 (1155 ft)
<b>Indoors:</b> A typical office or home environment with floor to ceiling obstructions between the access point and users.	40 (131 ft)	50 (164 ft)	60 (197 ft)	65 (213 ft)	70 (230 ft)	110 (361 ft)	180 (591 ft)

# SPECIFICATIONS

Below is an outline of the technical specifications for the SMCWPCIT-G.

## Functional Criteria

Data Rate: Up to 108 Mbps with turbo mode  
Operating Range: Indoor: up to 18 m (60 ft) at 54 Mbps up to 80 m (262 ft) at 1 Mbps  
Outdoor: up to 100 m (328 ft) at 54 Mbps up to 560 m (1837 ft) at 1Mbps

## Radio Signal

Modulation: Orthogonal Frequency Division Multiplexing (OFDM)  
Complementary Code Keying (CCK)

Operating Frequency: USA (FCC): 2412~2462 MHz  
Canada (IC): 2412~2462 MHz  
Europe (ETSI) 2412~2472 MHz  
France: 2457~2472 MHz  
Japan: 2412~2484 MHz

Operating Channel: USA, Canada: 11 channels  
ETSI: 13 channels  
France (indoor): 13 channels  
Japan: 14 channels

Sensitivity: -80 dBm (typical)

Output Power: >+11 dBm (without antenna)

## SPECIFICATIONS

### Physical Characteristics

Power Consumption:	TX: 480 mA Max, RX: 350 mA Max
Dimensions:	120 x 62 mm (4.72 x 2.44 in)
LED Indicator:	Power/Link, Activity
Host Interface:	PCI Spec v. 2.2

### Antenna

Antenna type:	External detachable
Frequency Band:	2.4~2.5 GHz
Impedance:	50 Ohms Nominal
Gain:	2.0 dBi Peak
Radiation:	Omni directional
Polarization:	Vertical
VSWR (Voltage Standing Wave Ratio):	<= 2.0
Connector:	Reverse SMA (SubMiniature version A)
Temperature	Operating: -20 to 65 °C (-4 to 149 °F) Storage: -30 to 75 °C (-22 to 167 °F)

### Standards Conformance

Wireless Standard:	IEEE 802.11b and IEEE 802.11g
Media Access Protocol:	CSMA/CA with ACK

### Environmental

Temperature:	Operating: 0 to 50 °C (32 to 122 °F) Storage: 0 to 70 °C (32 to 158 °F)
Humidity:	5 to 90% (non-condensing)
Vibration/Shock/Drop:	IEC 68-2-34, IEC 68-2-27, IEC68-2-32

### Certification

General Safety:	R&TTE Directive 1999/5 EC EN 60950 (6.2000) 99/519/EC EN 50360
EMC:	EN 301 489-1/17
Radio:	EN 301 328-2

**Software Drivers**

NDIS Drivers:

Windows 98 SE

Windows Me

Windows 2000

Windows XP

## *SPECIFICATIONS*





**FOR TECHNICAL SUPPORT, CALL:**

From U.S.A. and Canada (24 hours a day, 7 days a week)  
(800) SMC-4-YOU; Phn: (949) 679-8000; Fax: (949) 679-1481  
From Europe : Contact details can be found on  
[www.smc-europe.com](http://www.smc-europe.com) or [www.smc.com](http://www.smc.com)

**INTERNET**

E-mail addresses:

[techsupport@smc.com](mailto:techsupport@smc.com)  
[european.techsupport@smc-europe.com](mailto:european.techsupport@smc-europe.com)

Driver updates:

[http://www.smc.com/index.cfm?action=tech\\_support\\_drivers\\_downloads](http://www.smc.com/index.cfm?action=tech_support_drivers_downloads)

World Wide Web:

<http://www.smc.com>

**FOR LITERATURE OR ADVERTISING RESPONSE, CALL:**

U.S.A. and Canada:	(800) SMC-4-YOU;	Fax (949) 679-1481
Spain:	34-91-352-00-40;	Fax 34-93-477-3774
UK:	44 (0) 1932 866553;	Fax 44 (0) 118 974 8701
France:	33 (0) 41 38 32 32;	Fax 33 (0) 41 38 01 58
Italy:	39 (0) 335 5708602;	Fax 39 02 739 14 17
Benelux:	31 33 455 72 88;	Fax 31 33 455 73 30
Central Europe:	49 (0) 89 92861-0;	Fax 49 (0) 89 92861-230
Nordic:	46 (0) 868 70700;	Fax 46 (0) 887 62 62
Eastern Europe:	34 -93-477-4920;	Fax 34 93 477 3774
Sub Saharian Africa:	216-712-36616;	Fax 216-71751415
North West Africa:	34 93 477 4920;	Fax 34 93 477 3774
CIS:	7 (095) 7893573;	Fax 7 (095) 789 35 73
PRC:	86-10-6235-4958;	Fax 86-10-6235-4962
Taiwan:	886-2-8797-8006;	Fax 886-2-8797-6288
Asia Pacific:	(65) 238 6556;	Fax (65) 238 6466
Korea:	82-2-553-0860;	Fax 82-2-553-7202
Japan:	81-45-224-2332 ;	Fax 81-45-224-2331
Australia:	61-2-8875-7887;	Fax 61-2-8875-7777
India:	91-22-8204437 ;	Fax 91-22-8204443

If you are looking for further contact information, please visit  
[www.smc.com](http://www.smc.com), [www.smc-europe.com](http://www.smc-europe.com), or [www.smc-asia.com](http://www.smc-asia.com).

38 Tesla  
Irvine, CA 92618  
Phone: (949) 679-8000

Model Number: SMCWPCIT-G  
Revision number: E052005-R01