



VH410

Extended User guide

Sony Ericsson
make.believe

Contents

Headset overview	5
Introduction	6
Charging	7
Turning on and off	8
Pairing the headset	9
Pairing the headset with a phone.....	9
Pairing the headset with another phone.....	9
Multipoint	10
Putting on the headset	11
Calling	12
Transferring sound.....	12
Battery	13
Removing the cover	14
Resetting the headset	15
Troubleshooting	16
The headset is automatically turned off.....	16
Unexpected behaviour.....	16
No connection to the phone.....	16
FCC Statement	17
Industry Canada Statement	18
Declaration of Conformity for VH410	19

1.

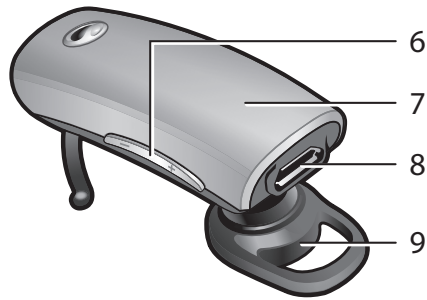
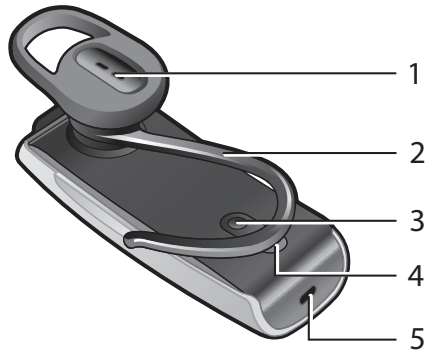

2.

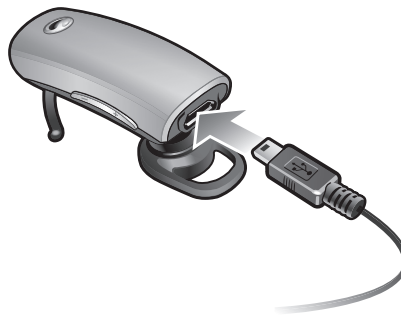

3.

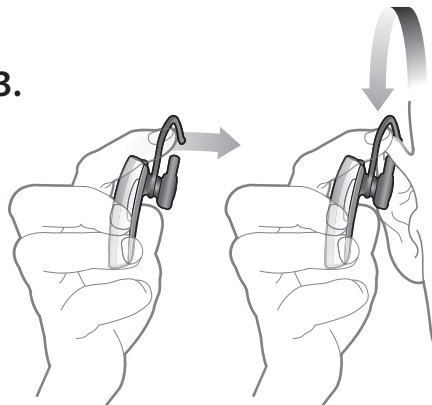

4.

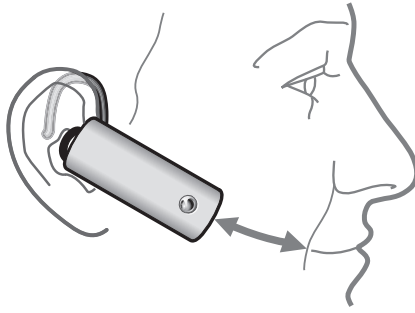

5.

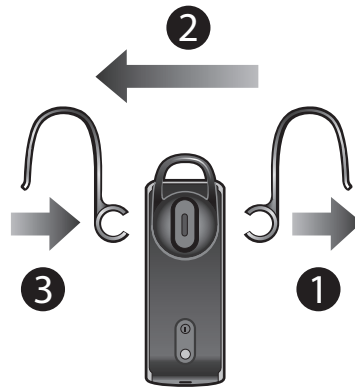

6.

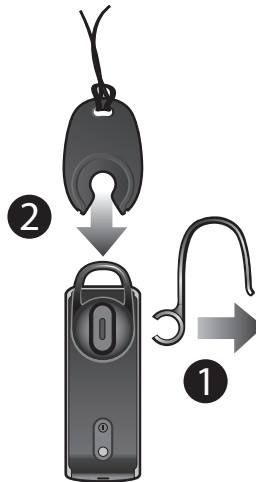

7.



Headset overview

See illustration 1.

- | | |
|---|-------------------|
| 1 | Ear speaker |
| 2 | Ear hook |
| 3 | On/off key |
| 4 | Indicator light |
| 5 | Microphone |
| 6 | Volume keys |
| 7 | Call key |
| 8 | Charger connector |
| 9 | Ear bud |

Introduction

The VH410 Bluetooth™ Handsfree can be connected to any Bluetooth™ compatible device that supports the headset. This User guide focuses on use with a Sony Ericsson mobile phone.

Charging

Before using the headset for the first time, you need to charge it with the supplied charger for 8 hours (See illustration 2). The normal charging time is 2.5 hours. Use Sony Ericsson chargers only.

Turning on and off

To turn on the headset

- Press and hold down ① until the indicator light shows a steady green or red light. If the light is red, the headset needs charging. After 3 seconds, the light turns off and the headset is on.

To turn off the headset

- Press and hold down ① until the indicator light shows a green or red light. If the light is red, the headset needs charging. After 3 seconds, the light turns off and the headset is off.

Pairing the headset

Pairing the headset with a phone

To use the headset with a phone, you need to pair the headset with the phone. After successful pairing, the headset connects automatically to the phone as soon as the headset is turned on and within range.

To pair the headset with a phone

- 1 Make sure the headset is turned off.
- 2 Turn on the Bluetooth function in the phone. For instructions, see the phone User guide.
- 3 Turn on Bluetooth visibility in the phone. This makes the phone visible to other Bluetooth devices.
- 4 Place the phone within 20 cm (8 inches) of the headset.
- 5 Press and hold down ① on the headset for about 5 seconds until the indicator light flashes green and red alternately.
- 6 Auto pairing in your phone: When asked to add the VH410, follow the instructions that appear.
- 7 Normal pairing in your phone: Search for and add a new device.
- 8 If a passcode is required, enter 0000.

Pairing the headset with another phone

To use the headset with another phone, you need to pair the headset with the phone. After successful pairing, the headset connects automatically to the phone as soon as the headset is turned on and within range.

To pair the headset with another phone

- 1 Make sure the headset is turned off.
- 2 Turn on the Bluetooth function in the other phone. For instructions, see the phone User guide.
- 3 Place the other phone within 20 cm (8 inches) of the headset.
- 4 Press and hold down ① on the headset for about 5 seconds until the indicator light flashes green and red alternately.
- 5 In the other phone: Search for and add a new device.
- 6 If a passcode is required, enter 0000.

Multipoint

With the multipoint feature, you can use the headset with two different phones at the same time. Before you use this feature, you need to enable it.

To enable the multipoint feature

- 1 Make sure the headset is turned off.
 - 2 Press and hold down **Ⓜ** on the headset until the indicator light flashes green and red alternately.
 - 3 Multipoint mode: Press and hold down the plus sign on the volume key. Two orange flashes on the indicator light shows that multipoint has been enabled.
 - 4 Singlepoint mode: Press and hold down the minus sign on the volume key. One orange flash on the indicator light shows that singlepoint has been enabled.
- ! When the headset is in multipoint mode, you cannot answer a second call on the same phone.

Putting on the headset

To put on the headset

- Slide the ear hook behind your ear and point the microphone towards your mouth. See illustration 3 and 4.
- ! You can use the headset with or without the ear hook. You can also use the headset either on the left or right ear. See illustration 5.

Calling

When you have paired the headset with your phone, you can make and receive calls as long as the headset is turned on.

To make a call

- Dial the number using the phone keys. The call is automatically activated in the headset.

To end a call

- Press the end call key.

To answer a call

- A beep indicates an incoming call. Press the call key.

To reject a call

- A beep indicates an incoming call. Press and hold down the call key.

To answer a second call

- Press the call key. The ongoing call is put on hold.

To switch between two calls

- Press the call key until you hear a beep.

To mute the microphone during a call

- Press both volume keys simultaneously. A beep indicates that the microphone has been muted. To turn on the microphone again, press both volume keys simultaneously.

To change the ear speaker volume

- During a call, press a volume key.

Transferring sound

To transfer the sound from the headset to the phone

- See *Transferring sound to and from a Bluetooth handsfree* in the phone User guide.

Battery

A battery that has been infrequently used, or a new one, could have reduced capacity. You may need to recharge it a number of times. When the battery level is low, the indicator light flashes red and you hear a low beep. If you do not charge the headset, it turns off after 10 minutes.

Removing the cover

To remove the cover

- See illustration 6. You can see the regulatory information on the headset.

Resetting the headset

Reset the headset if it behaves unexpectedly. Resetting the headset removes all information about paired devices.

To reset the headset

- Press and hold down ① for 10 seconds.

To reset the headset to factory settings

- Simultaneously press and hold down ① and the call handling key during pairing mode.

Troubleshooting

The headset is automatically turned off

- The battery level is too low. You hear a beep approximately 10 minutes before the headset turns off. Charge the battery.
- The headset turns off if you do not pair it with the phone within 10 minutes.

Unexpected behaviour

- Reset the headset.

No connection to the phone

Make sure the headset is charged and within range of the phone. We recommend a maximum distance of 10 metres (33 feet) with no solid objects in between. Check or reset the Bluetooth settings in the phone. Pair the headset with the phone again.

FCC Statement

This device complies with Part 15 of the FCC rules. Operation is subject to the following two conditions: (1) This device may not cause harmful interference, and (2) This device must accept any interference received, including interference that may cause undesired operation.



Any change or modification not expressly approved by Sony Ericsson may void the user's authority to operate the equipment.

This equipment has been tested and found to comply with the limits for a Class B digital device, pursuant to Part 15 of the FCC Rules. These limits are designed to provide reasonable protection against harmful interference in a residential installation. This equipment generates, uses and can radiate radio frequency energy and, if not installed and used in accordance with the instructions, may cause harmful interference to radio communications. However, there is no guarantee that interference will not occur in a particular installation.

If this equipment does cause harmful interference to radio or television reception, which can be determined by turning the equipment off and on, the user is encouraged to try to correct the interference by one or more of the following measures:

- Reorient or relocate the receiving antenna.
- Increase the separation between the equipment and receiver.
- Connect the equipment into an outlet on a circuit different from that to which the receiver is connected.
- Consult the dealer or an experienced radio/TV technician for help.

Industry Canada Statement

This device complies with RSS-210 of Industry Canada.

Operation is subject to the following two conditions: (1) this device may not cause interference, and (2) this device must accept any interference, including interference that may cause undesired operation of the device.

This Class B digital apparatus complies with Canadian ICES-003.

Cet appareil numérique de la classe B est conforme à la norme NMB-003 du Canada.

Declaration of Conformity for VH410

We, **Sony Ericsson Mobile Communications AB** of

Nya Vattentorget

SE-221 88 Lund, Sweden

declare under our sole responsibility that our product

Sony Ericsson type DDA-0002028

and in combination with our accessories, to which this declaration relates is in conformity with the appropriate standards **EN 300 328:V1.7.1, EN 301 489-7:V1.3.1, EN 301 489-17:V2.1.1 and EN 60 950-1:2006** following the provisions of, Radio Equipment and Telecommunication Terminal Equipment directive **1999/5/EC**.

Lund, January 2010

CE 0682

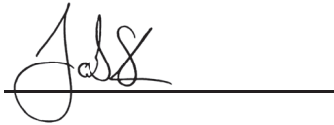

Jacob Sten,
Head of Product Business Unit Accessories

We fulfil the requirements of the R&TTE Directive (1999/5/EC).



Sony Ericsson VH410

Prior to use, please read the *Important information* leaflet separately provided.

This User guide is published by Sony Ericsson Mobile Communications AB or its local affiliated company, without any warranty. Improvements and changes to this User guide necessitated by typographical errors, inaccuracies of current information, or improvements to programs and/or equipment, may be made by Sony Ericsson Mobile Communications AB at any time and without notice. Such changes will, however, be incorporated into new editions of this User guide. All rights reserved.

©Sony Ericsson Mobile Communications AB, 2010

Publication number: 1239-2737.2

Bluetooth is a trademark or a registered trademark of Bluetooth SIG Inc. and any use of such mark by Sony Ericsson is under license.

Interoperability and compatibility among Bluetooth™ devices varies. Device generally supports products utilizing Bluetooth spec. 1.2 or higher, and Headset or Handsfree profile.

The Liquid Identity logo is a trademark or registered trademark of Sony Ericsson Mobile Communications AB.

Sony and "make.believe" are trademarks or registered trademarks of Sony Corporation.

Ericsson is a trademark or registered trademark of Telefonaktiebolaget LM Ericsson.