

OUTDOOR UNIT SERVICE MANUAL

No. OBH498



Wireless type
Models

MUZ-FD09NA
MUZ-FD09NA-U1
MUZ-FD12NA
MUZ-FD12NA-U1

Indoor unit service manual
MSZ-FD•NA Series (OBH497)

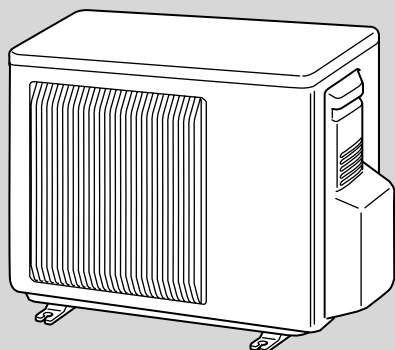

CONTENTS

1. TECHNICAL CHANGES	3
2. PART NAMES AND FUNCTIONS.....	3
3. SPECIFICATION.....	4
4. OUTLINES AND DIMENSIONS	6
5. WIRING DIAGRAM.....	7
6. REFRIGERANT SYSTEM DIAGRAM	8
7. DATA	9
8. ACTUATOR CONTROL.....	15
9. SERVICE FUNCTIONS	16
10. TROUBLESHOOTING	16
11. DISASSEMBLY INSTRUCTIONS	32

PARTS CATALOG (OBB498)

NOTE:
RoHS compliant products have <G> mark on the spec name plate.

Mr. SLIM™

1

TECHNICAL CHANGES

MUZ-FD09NA
MUZ-FD12NA
MUZ-FD09NA - U1
MUZ-FD12NA - U1

1. New model

2

PART NAMES AND FUNCTIONS

MUZ-FD09NA
MUZ-FD12NA

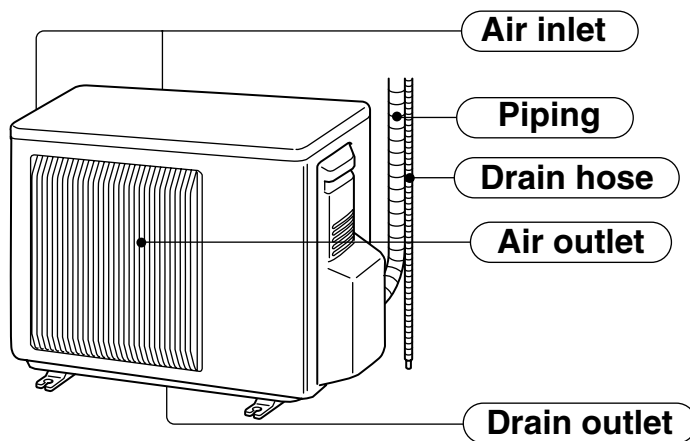

3

SPECIFICATION

Outdoor unit model			MUZ-FD09NA	MUZ-FD12NA
Capacity Rated (Minimum~Maximum)	Cooling *1	Btu/h	9,000 (2,800~9,000)	12,000 (2,800~12,000)
	Heating 47 *1	Btu/h	10,900 (3,000~18,000)	13,600 (3,000~21,000)
Capacity Rated	Heating 17 *2	Btu/h	7,700	8,300
Power consumption Rated (Minimum~Maximum)	Cooling *1	W	650 (160~650)	960 (160~960)
	Heating 47 *1	W	750 (150~2,400)	980 (150~2,400)
Power consumption Rated	Heating 17 *2	W	1,730	1,780
EER *1 [SEER] *3	Cooling		13.8 [23.0]	12.5 [22.0]
HSPF IV(V) *4	Heating		10.55 (7.4)	10.55 (7.4)
COP	Heating *1		4.30	4.10
External nish	Munsell 3Y 7.8/1.1			
Power supply	V , phase , Hz		208/230 , 1 , 60	
Max. fuse size (time delay)	A		15	
Min. circuit ampacity	A		12	
Fan motor	F.L.A		0.56	
Compressor	Model		SNB130FQAH	
	R.L.A		8.6	
	L.R.A		10.8	
Refrigerant control	Liner expansion valve			
Sound level *1	Cooling	dB(A)	48	48
	Heating	dB(A)	49	49
Defrost method	Reverse cycle			
Dimensions	W	in.	31-1/2	
	D	in.	11-1/4	
	H	in.	21-5/8	
Weight	lb.		80	
Remote controller	Wireless type			
Control voltage (by built-in transformer)	VDC		12 - 24	
Refrigerant piping	Not supplied			
Refrigerant pipe size (Min. wall thickness)	Liquid	in.	1/4 (0.0315)	
	Gas	in.	3/8 (0.0315)	
Connection method	Indoor		Flared	
	Outdoor		Flared	
Between the indoor & outdoor units	Height difference	ft.	40	
	Piping length	ft.	65	
Refrigerant charge (R410A)	2 lb. 9 oz.			
Refrigeration oil (Model)	NE022			

NOTE : Test conditions are based on ARI 210/240.

*1 : Rating conditions (Cooling) — Indoor : 80 FDB, 67 FWB, Outdoor : 95 FDB, (75 FWB) Rated frequency
(Heating) — Indoor : 70 FDB, 60 FWB, Outdoor : 47 FDB, 43 FWB Rated frequency

*2 : (Heating) — Indoor : 70 FDB, 60 FWB, Outdoor : 17 FDB, 15 FWB Maximum frequency

Test condition

※3,※4

ARI	Mode	Test	Indoor air condition		Outdoor air condition	
			Dry bulb (°F)	Wet bulb (°F)	Dry bulb (°F)	Wet bulb (°F)
	SEER (Cooling)	"A" Cooling Steady State at rated compressor Speed	80	67	95	(75)
		"B-2" Cooling Steady State at rated compressor Speed	80	67	82	(65)
		"B-1" Cooling Steady State at minimum compressor Speed	80	67	82	(65)
		Low ambient Cooling Steady State at minimum compressor Speed	80	67	67	(53.5)
		Intermediate Cooling Steady State at Intermediate compressor Speed ※5	80	67	87	(69)
	HSPF (Heating)	Standard Rating-Heating at rated compressor Speed	70	60	47	43
		Low temperature Heating at rated compressor Speed	70	60	17	15
		Max temperature Heating at minimum compressor Speed	70	60	62	56.5
		High temperature Heating at minimum compressor Speed	70	60	47	43
		Frost Accumulation at rated compressor Speed	70	60	35	33
		Frost Accumulation at Intermediate compressor Speed ※5	70	60	35	33

※5 : At Intermediate compressor Speed
 =("Cooling rated compressor speed" - "minimum compressor speed") / 3 + "minimum compressor speed".

OPERATING RANGE

(1) POWER SUPPLY

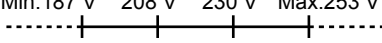
	Rated voltage	Guaranteed Voltage
Outdoor unit	208/230 V 1 phase 60 Hz	Min.187 V 208 V 230 V Max.253 V 

(2) OPERATION

Mode	Condition	Intake air temperature (°F)			
		Indoor		Outdoor	
		DB	WB	DB	WB
Cooling	Standard temperature	80	67	95	—
	Maximum temperature	90	73	115	—
	Minimum temperature	67	57	14	—
	Maximum humidity	78 %		—	
Heating	Standard temperature	70	60	47	43
	Maximum temperature	80	67	75	65
	Minimum temperature	70	60	14	13

4

OUTLINES AND DIMENSIONS

MUZ-FD09NA
 MUZ-FD12NA

Unit: inch

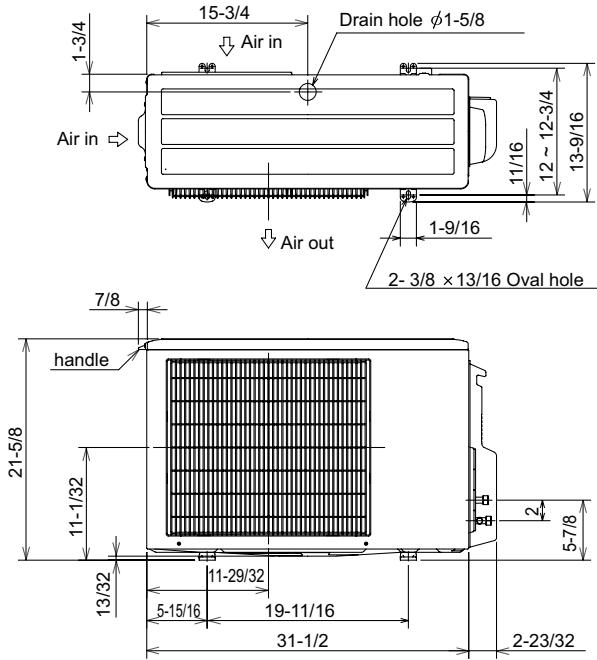

REQUIRED SPACE

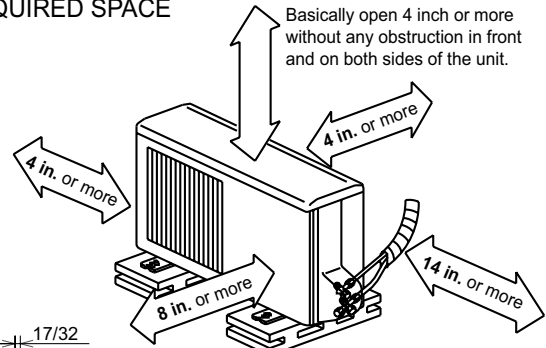

Basically open 4 inch or more without any obstruction in front and on both sides of the unit.

Open two sides of left, right, or rear side.

Liquid pipe : $1/4$ (flared)
 Gas pipe : $3/8$ (flared)

MUZ-FD09NA MUZ-FD12NA

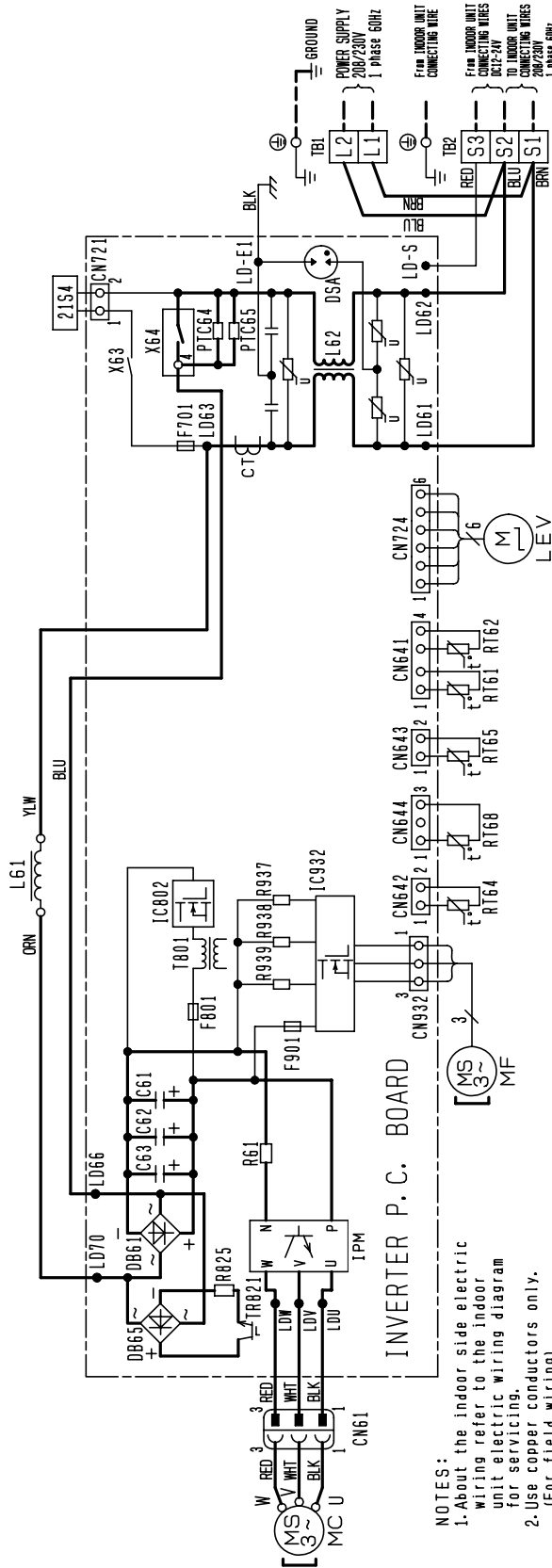

INVERTER P.C. BOARD

- NOTES:
- About the indoor side electric wiring refer to the indoor unit electric wiring diagram for servicing.
 - Use copper conductors only. (For field wiring).

SYMBOL	NAME	SYMBOL	NAME	SYMBOL	NAME
CT	CURRENT TRANSFORMER	MC	COMPRESSOR	R825, R937	CURRENT-DETECTING RESISTOR
CB, CB2, CB3	SMOOTHING CAPACITOR	MF	FAN MOTOR	R938, R939	CURRENT-DETECTING RESISTOR
DB61, DB65	DIODE MODULE	PTC64, PTC65	CIRCUIT PROTECTION	TBL, TB2	TERMINAL BLOCK
DSA	SURGE ABSORBER	RT61	DEFROST THERMISTOR	TR821	SWITCHING POWER TRANSISTOR
F701, F801, F801	FUSE (T3, 15A(1250V))	RT62	DISCHARGE TEMP. THERMISTOR	T801	TRANSFORMER
IC802	INTELLIGENT POWER DEVICE	RT64	FIN TEMP. THERMISTOR	X63, X64	RELAY
IPM	INTELLIGENT POWER MODULE	RT65	AMBIENT TEMP. THERMISTOR	Z1S4	REVERSING VALVE COIL
L61	REACTOR	RT68	OUTDOOR HEAT EXCHANGER TEMP. THERMISTOR		
L62	CHC COIL				
LEV	EXPANSION VALVE COIL	R61	CURRENT-DETECTING RESISTOR		

6

REFRIGERANT SYSTEM DIAGRAM

MUZ-FD09NA
MUZ-FD12NA

Unit:inch

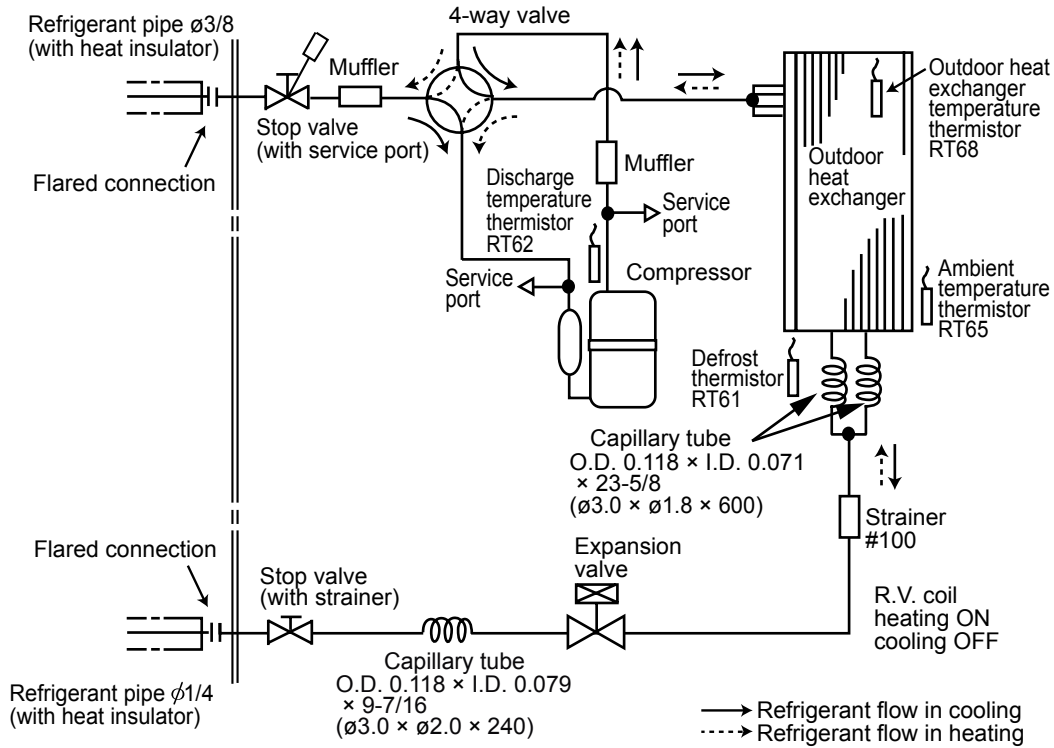

MAX. REFRIGERANT PIPING LENGTH and MAX. HEIGHT DIFFERENCE

Model	Refrigerant piping : ft		Piping size O.D : in	
	Max. Length A	Max. Height difference B	Gas	Liquid
MUZ-FD09NA MUZ-FD12NA	65	40	3/8	1/4

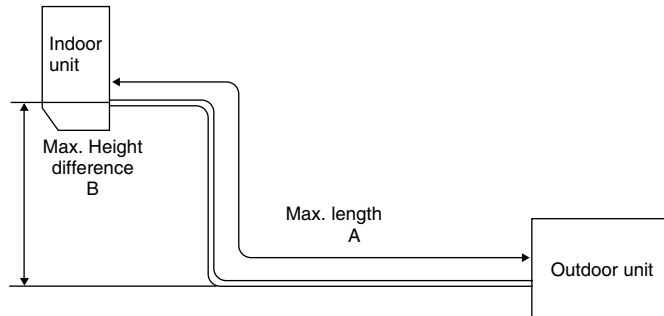

ADDITIONAL REFRIGERANT CHARGE (R410A:oz.)

NOTE : Refrigerant piping exceeding 25 ft. requires additional refrigerant charge according to the calculation.

Model	Outdoor unit precharged	Refrigerant piping length (one way) : ft					
		25	30	40	50	60	65
MUZ-FD09NA MUZ-FD12NA	2 lb. 9 oz.	0	1.62	4.86	8.10	11.34	12.96

Calculation : X oz. = 1.62/ 5 oz./ ft \times (Refrigerant piping length (ft) - 25)

NOTE : Refrigerant piping exceeding 25 ft. requires additional refrigerant charge according to the calculation.

MUZ-FD09NA MUZ-FD12NA

7-1. PERFORMANCE DATA

1) COOLING CAPACITY

Model	Indoor air		Outdoor intake air DB temperature (°F)													
	IWB	75	85			95			105			115				
	(°F)		TC	SHC	TPC	TC	SHC	TPC	TC	SHC	TPC	TC	SHC	TPC		
MUZ-FD09NA	71	11.0	6.9	0.58	10.3	6.5	0.63	9.7	6.1	0.68	9.0	5.6	0.72	8.3	5.2	0.75
	67	10.4	7.9	0.55	9.7	7.4	0.60	9.0	6.8	0.65	8.4	6.4	0.69	7.7	5.8	0.72
	63	9.8	8.8	0.52	9.1	8.1	0.58	8.5	7.6	0.62	7.7	6.9	0.66	7.0	6.3	0.69
MUZ-FD12NA	71	14.7	8.8	0.85	13.7	8.2	0.94	12.9	7.7	1.01	12.0	7.2	1.06	11.0	6.6	1.10
	67	13.9	10.2	0.81	13.0	9.5	0.89	12.0	8.8	0.96	11.2	8.1	1.02	10.3	7.5	1.07
	63	13.1	11.3	0.77	12.1	10.5	0.85	11.3	9.7	0.92	10.3	8.9	0.98	9.4	8.1	1.02

- NOTE :** 1. IWB : Intake air wet-bulb temperature
 TC : Total Capacity ($\times 10^3$ Btu/h)
 SHC : Sensible Heat Capacity ($\times 10^3$ Btu/h)
 TPC : Total Power Consumption (kW)
 2. SHC is based on 80 °F of indoor Intake air DB temperature.

2) COOLING CAPACITY CORRECTIONS

Refrigerant piping length (one way : ft.)			
	25 (std.)	40	65
MUZ-FD09NA MUY-FD12NA	1.0	0.954	0.878

3) HEATING CAPACITY

Model	Indoor air		Outdoor intake air WB temperature (°F)										
	IDB	15	25		35		43		45		55		
	(°F)		TC	TPC	TC	TPC	TC	TPC	TC	TPC	TC	TPC	
MUZ-FD09NA	75	6.3	0.56	7.9	0.66	9.4	0.73	10.6	0.77	11.0	0.78	12.4	0.81
	70	6.7	0.54	8.2	0.64	9.6	0.71	10.9	0.75	11.2	0.77	12.7	0.80
	65	6.9	0.52	8.6	0.62	10.0	0.69	11.2	0.73	11.6	0.74	13.0	0.78
MUZ-FD12NA	75	7.9	0.73	9.9	0.86	11.8	0.96	13.3	1.00	13.7	1.02	15.5	1.06
	70	8.4	0.71	10.2	0.84	12.0	0.93	13.6	0.98	14.0	1.00	15.8	1.04
	65	8.6	0.68	10.7	0.81	12.4	0.91	14.0	0.96	14.4	0.97	16.2	1.02

- NOTE :** 1. IDB : Intake air dry-bulb temperature
 TC : Total Capacity ($\times 10^3$ Btu/h)
 TPC : Total Power Consumption (kW)
 2. Above data is for heating operation without any frost.

How to operate with fixed operational frequency of the compressor.

1. Press the EMERGENCY OPERATION switch on the front of the indoor unit, and select either EMERGENCY COOL mode or EMERGENCY HEAT mode before starting to operate the air conditioner.
2. The compressor starts with operational frequency.
3. The fan speed of the indoor unit is High.
4. This operation continues for 30 minutes.
5. In order to release this operation, press the EMERGENCY OPERATION switch twice or once, or press any button on the remote controller.

7-2. PERFORMANCE CURVE

Cooling

MUZ-FD09NA

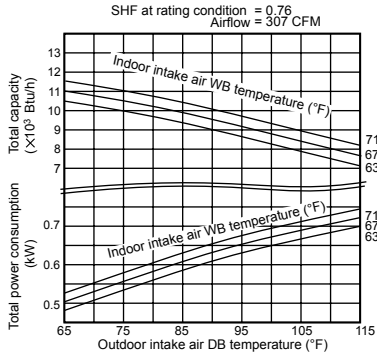

MUZ-FD12NA

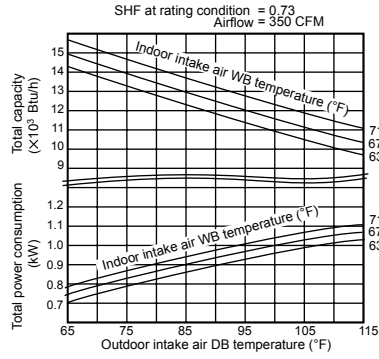

Heating

MUZ-FD09NA

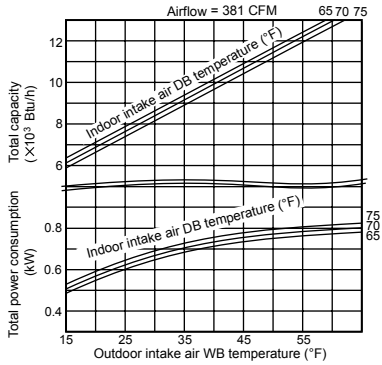

MUZ-FD12NA

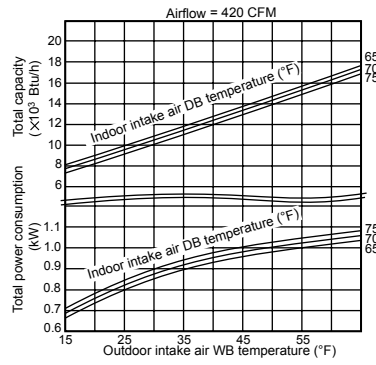

This value of frequency is not the same as the actual frequency in operating. Refer to 7-5 and 7-6 for the relationships between frequency and capacity.

7-3. CONDENSING PRESSURE

Cooling

Data is based on the condition of indoor humidity 50 %.

Air flow should be set to High speed.

MUZ-FD09NA

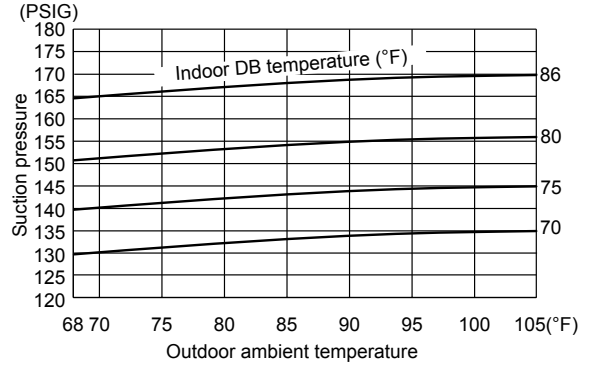
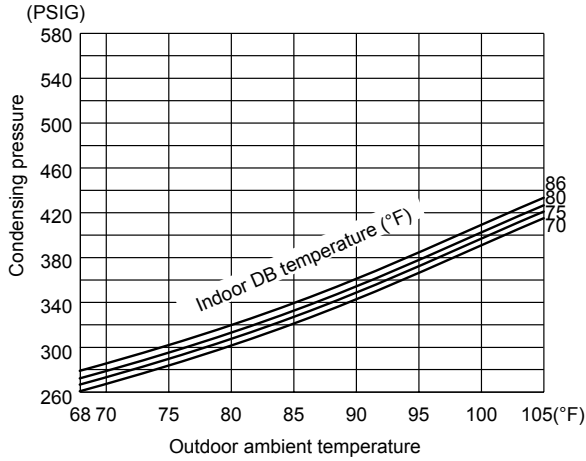

MUZ-FD12NA

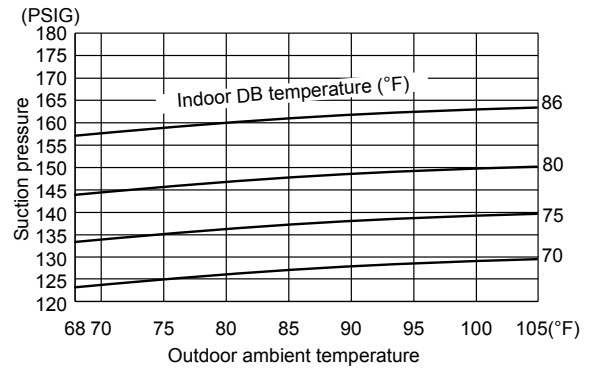
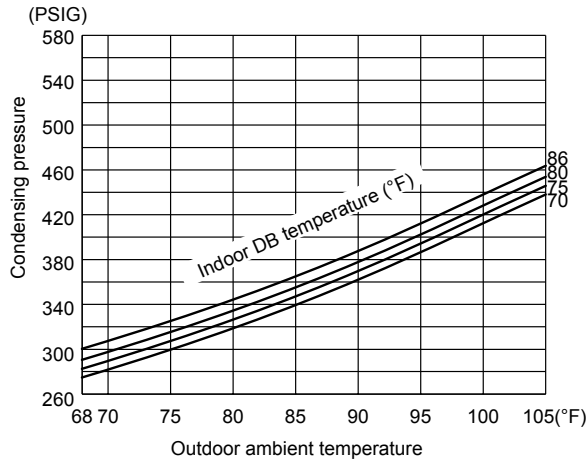

Heating

Data is based on the condition of outdoor humidity 75 %.

Air flow should be set to High speed.

Data is for heating operation without any frost.

MUZ-FD09NA

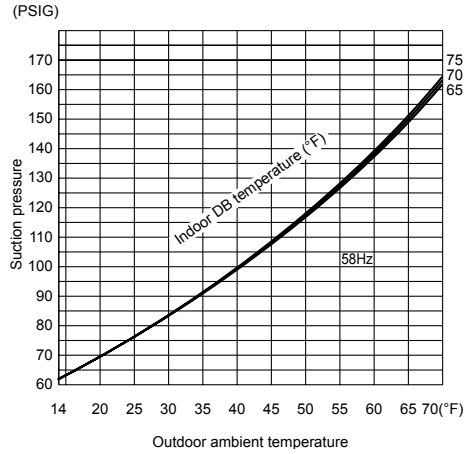
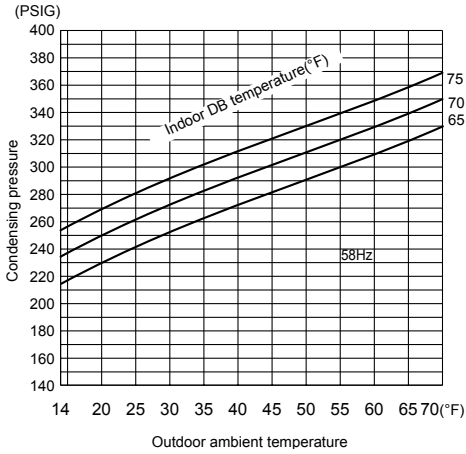

MUZ-FD12NA

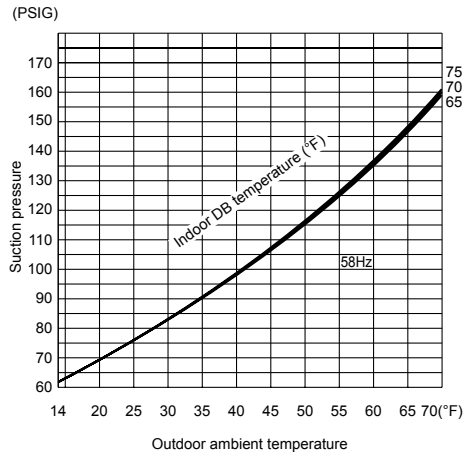
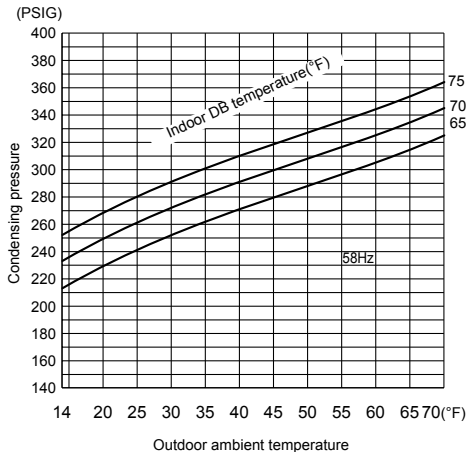

7-4. STANDARD OPERATION DATA

Model			MSZ-FD09NA		MSZ-FD12NA		
Item		Unit	Cooling	Heating	Cooling	Heating	
Total	Capacity	Btu/h	9,000	10,900	12,000	13,600	
	SHF	—	0.76	—	0.73	—	
	Input	kW	0.650	0.750	0.960	0.980	
	Rated frequency	Hz	35	43	51	54	
Electrical circuit	Indoor unit		MSZ-FD09NA		MSZ-FD12NA		
	Power supply	V, phase, Hz	208/230 , 1 , 60				
	Input	kW	0.018	0.024	0.024	0.030	
	Fan motor current	A	0.19/0.17	0.25/0.23	0.25/0.23	0.32/0.29	
	Outdoor unit		MUZ-FD09NA		MUZ-FD12NA		
	Power supply	V, phase, Hz	208/230 , 1 , 60				
	Input	kW	0.632	0.726	0.936	0.950	
	Comp. current	A	2.96/2.68	3.39/3.06	4.40/3.97	4.43/4.01	
	Fan motor current	A	0.35/0.32				
	Refrigerant circuit	Condensing pressure	PSIG	376	355	402	392
Suction pressure		PSIG	154	108	148	104	
Discharge temperature		°F	143	144	161	159	
Condensing temperature		°F	112	108	117	115	
Suction temperature		°F	51	46	51	45	
Comp. shell bottom temperature		°F	144	128	146	129	
Ref. pipe length		ft.	25				
Refrigerant charge (R410A)			2 lb. 9 oz.				
Indoor unit	Intake air temperature	DB	°F	80	70	80	70
		WB	°F	67	60	67	60
	Discharge air temperature	DB	°F	59	100	56	105
		WB	°F	56	—	54	—
	Fan speed (High)	rpm	1,020	1,120	1,120	1,220	
Airflow (High)	CFM	307 (Wet)	381	350 (Wet)	420		
Outdoor unit	Intake air temperature	DB	°F	95	47	95	47
		WB	°F	—	43	—	43
	Fan speed	rpm	810	870	810	870	
	Airflow	CFM	1,102	1,187	1,102	1,187	

7-5. CAPACITY AND INPUT CORRECTION BY INVERTER OUTPUT FREQUENCY

MUZ-FD09NA

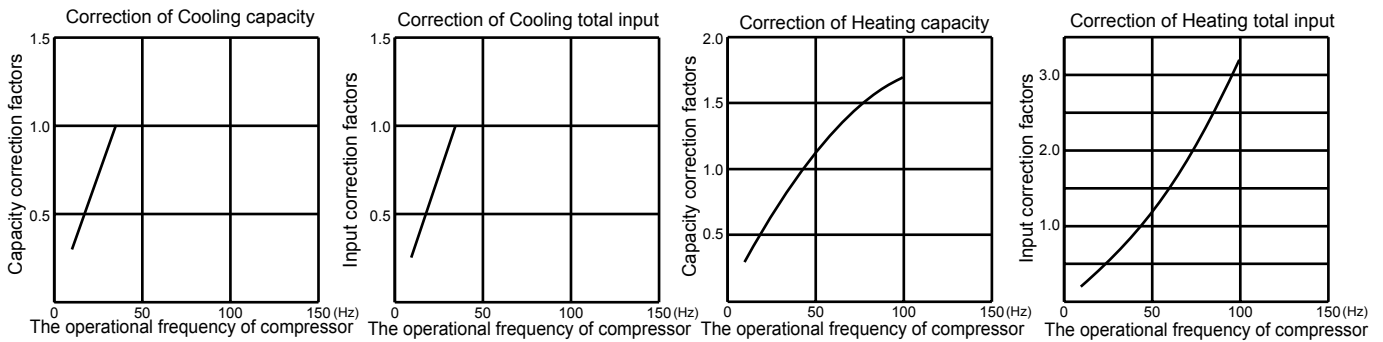

MUZ-FD12NA

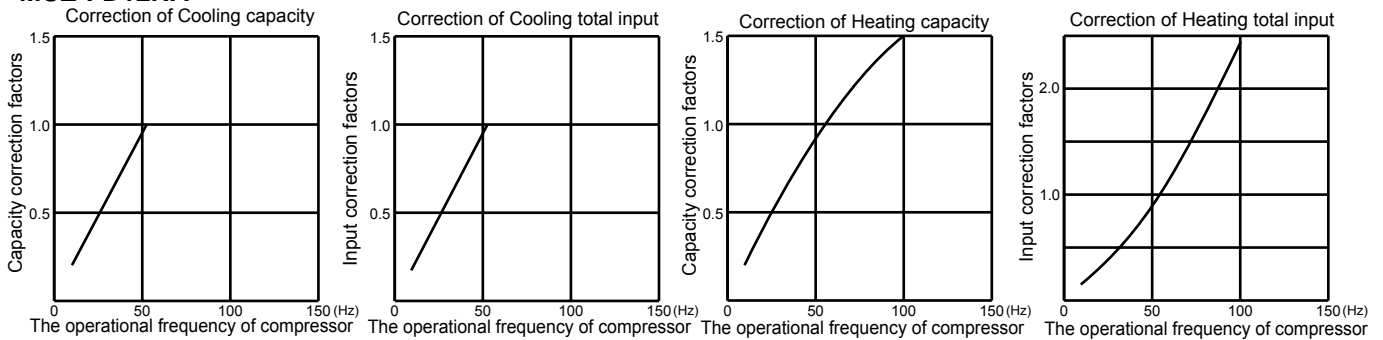

7-6. TEST RUN OPERATION (How to operate fixed-frequency operation)

1. Press EMERGENCY OPERATION switch to COOL or HEAT mode (COOL : Press once, HEAT : Press twice).
2. Test run operation starts and continues to operate for 30 minutes.
3. Compressor operates at rated frequency in COOL mode or 58 Hz in HEAT mode.
4. Indoor fan operates at High speed.
5. After 30 minutes, test run operation finishes and EMERGENCY OPERATION starts (Operation frequency of compressor varies).
6. To cancel test run operation (EMERGENCY OPERATION), press EMERGENCY OPERATION switch or any button on remote controller.

**MUZ-FD09NA
MUZ-FD12NA**

8-1. OUTDOOR FAN MOTOR CONTROL

The fan motor turns ON/OFF, interlocking with the compressor.

[ON] The fan motor turns ON 5 seconds before the compressor starts up.

[OFF] The fan motor turns OFF 15 seconds after the compressor has stopped running.

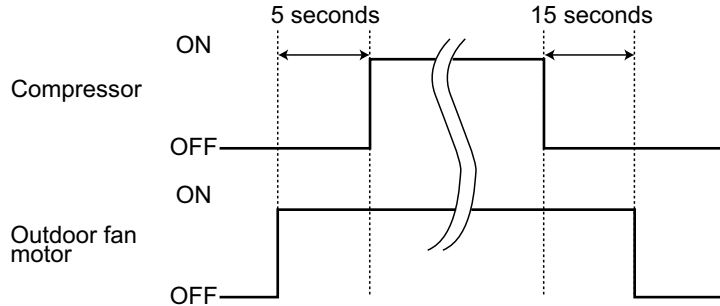

8-2. R.V. COIL CONTROL

- Heating ON
- Cooling OFF
- Dry OFF

NOTE: The 4-way valve reverses for 5 seconds right before start-up of the compressor.

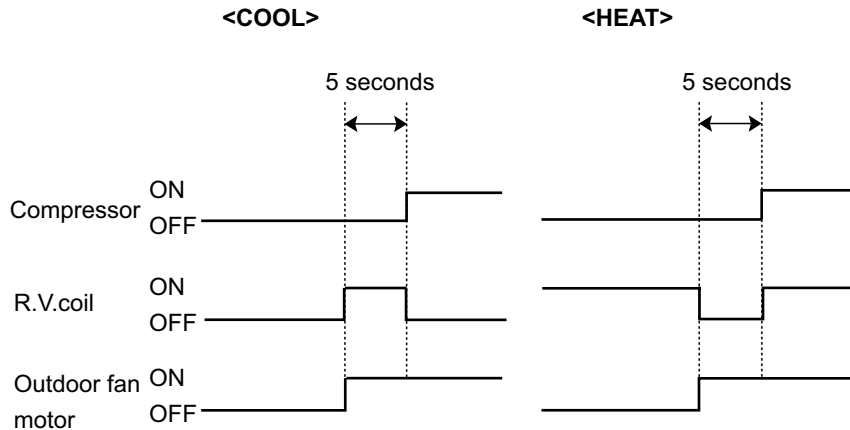

8-3. RELATION BETWEEN MAIN SENSOR AND ACTUATOR

Sensor	Purpose	Actuator				
		Compressor	LEV	Outdoor fan motor	R.V. coil	Indoor fan motor
Discharge temperature thermistor	Protection	○	○			
Indoor coil temperature thermistor	Cooling : Coil frost prevention	○				
	Heating : High pressure protection	○	○			
Defrost thermistor	Cooling : High pressure protection	○	○			
	Heating : Defrosting	○	○	○	○	○
Fin temperature thermistor	Protection	○		○		
Outdoor heat exchanger temperature thermistor	High pressure protection	○	○	○		
Ambient temperature thermistor	Low ambient temperature operation	○	○	○		

9

SERVICE FUNCTIONS

MUZ-FD09VA MUZ-FD12VA

9-1. CHANGE IN DEFROST SETTING

Changing defrost finish temperature

<JS> To change the defrost finish temperature, cut/solder the JS wire of the outdoor inverter P.C. board.
(Refer to 10-6-1.)

Jumper		Defrost finish temperature
JS	Soldered (Initial setting)	41 °F (5 °C)
	None (Cut)	50 °F (10 °C)

9-2. PRE-HEAT CONTROL SETTING

PRE-HEAT CONTROL

When moisture gets into the refrigerant cycle, it may interfere the start-up of the compressor at low outside temperature. The pre-heat control prevents this interference. The pre-heat control turns ON when outside temperature is 68 °F (20 °C) or below. When pre-heat control is turned ON, compressor is energized. (about 50 W)

<JK> To activate the pre-heat control, cut the JK wire of the inverter P.C. board. (Refer to 10-6.1)

NOTE: When the inverter P.C. board is replaced, check the Jumper wires, and cut/solder them if necessary.

10

TROUBLESHOOTING

MUZ-FD09NA MUZ-FD12NA

10-1. CAUTIONS ON TROUBLESHOOTING

1. Before troubleshooting, check the following

- 1) Check the power supply voltage.
- 2) Check the indoor/outdoor connecting wire for miswiring.

2. Take care of the following during servicing

- 1) Before servicing the air conditioner, be sure to turn OFF the main unit first with the remote controller, then after confirming the horizontal vane is closed, turn off the breaker and / or disconnect the power plug.
- 2) Be sure to turn OFF the power supply before removing the front panel, the cabinet, the top panel, and the electronic control P.C. board.
- 3) When removing the electrical parts, be careful to the residual voltage of smoothing capacitor.
- 4) When removing the electronic control P.C. board, hold the edge of the board with care NOT to apply stress on the components.
- 5) When connecting or disconnecting the connectors, hold the housing of the connector. DO NOT pull the lead wires.

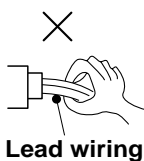

3. Troubleshooting procedure

- 1) First, check if the OPERATION INDICATOR lamp on the indoor unit is flashing on and off to indicate an abnormality. To make sure, check how many times the abnormality indication is flashing on and off before starting service work.
- 2) Before servicing check that the connector and terminal are connected properly.
- 3) When the electronic control P.C. board seems to be defective, check the copper foil pattern for disconnection and the components for bursting and discoloration.
- 4) Refer to 10-2. and 10-3.

10-2. FAILURE MODE RECALL FUNCTION

Outline of the function

This air conditioner can memorize the abnormal condition which has occurred once.

Even though LED indication listed on the troubleshooting check table (10-3.) disappears, the memorized failure details can be recalled.

This mode is very useful when the unit needs to be repaired for the abnormality which doesn't recur.

1. Flow chart of failure mode recall function for the indoor/outdoor unit

Operational procedure

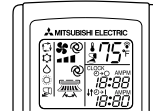
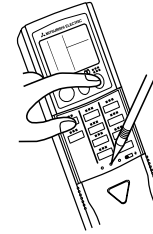
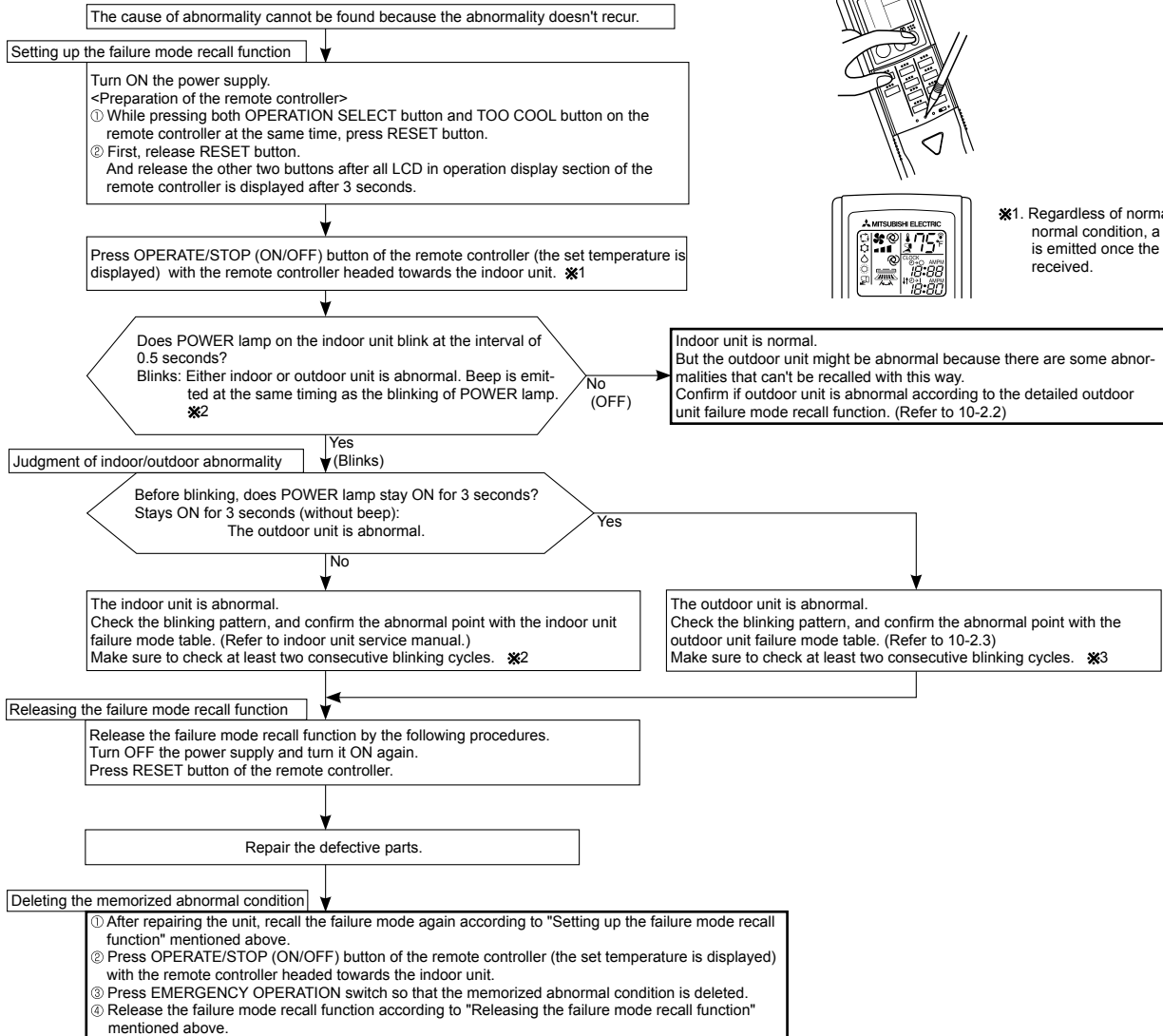

※1. Regardless of normal or abnormal condition, a short beep is emitted once the signal is received.

NOTE: 1. Make sure to release the failure mode recall function once it's set up, otherwise the unit cannot operate properly.
2. If the abnormal condition is not deleted from the memory, the last abnormal condition is kept memorized.

※2. Blinking pattern when the indoor unit is abnormal:

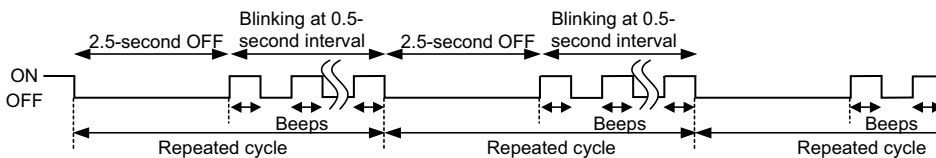

※3. Blinking pattern when the outdoor unit is abnormal:

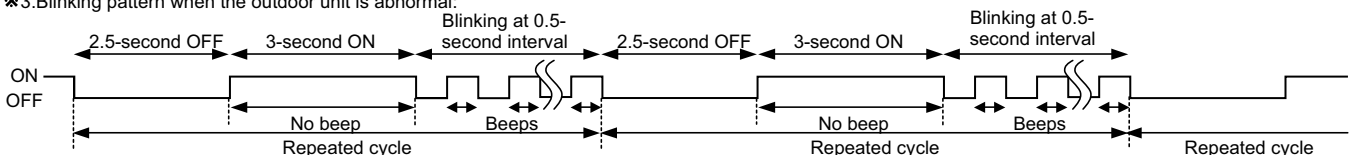

2. Flow chart of the detailed outdoor unit failure mode recall function

Operational procedure

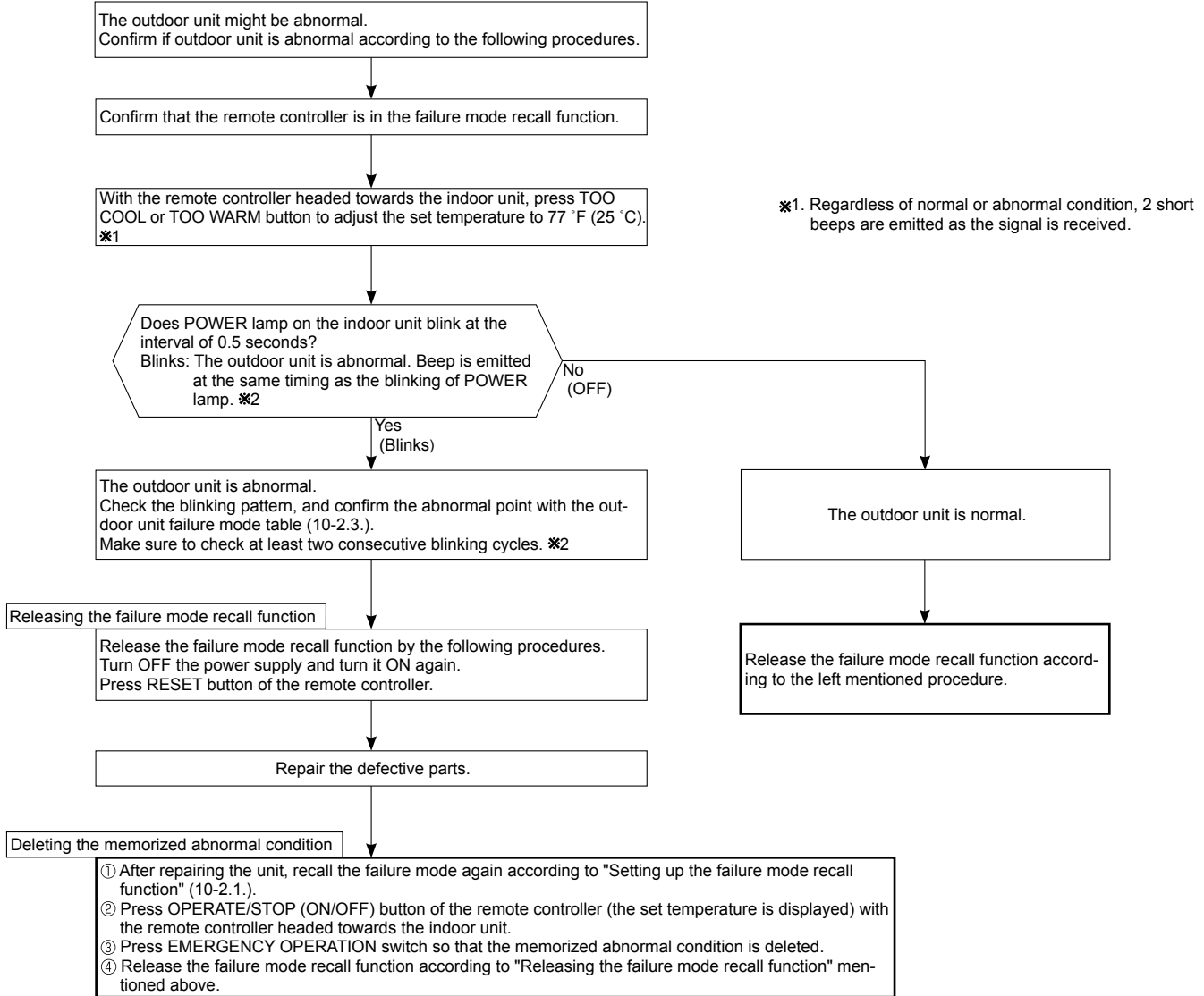

- NOTE:** 1. Make sure to release the failure mode recall function once it's set up, otherwise the unit cannot operate properly.
2. If the abnormal condition is not deleted from the memory, the last abnormal condition is kept memorized.

※2. Blinking pattern when outdoor unit is abnormal:

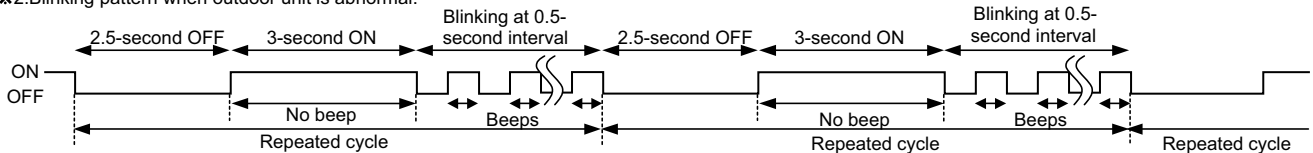

3. Outdoor unit failure mode table

POWER lamp (Indoor unit)	Abnormal point (Failure mode / protection)	LED indication (Outdoor P.C. board)	Condition	Correspondence	Indoor/outdoor unit failure mode recall function	Outdoor unit failure mode recall function
OFF	None (Normal)	—	—	—	—	—
2-time flash 2.5 seconds OFF	Outdoor power system	—	Overcurrent protection stop is continuously performed 3 times within 1 minute after the compressor gets started.	<ul style="list-style-type: none"> •Reconnect connectors. •Refer to 10-5. Ⓐ"How to check inverter/compressor". •Check stop valve. 	○	○
3-time flash 2.5 seconds OFF	Discharge temperature thermistor	1-time flash every 2.5 seconds	Thermistor shorts or opens during compressor running.	<ul style="list-style-type: none"> •Refer to 10-5. Ⓒ "Check of outdoor thermistors". Defective outdoor thermistors can be identified by checking the blinking pattern of LED. 	○	○
	Defrost thermistor					
	Fin temperature thermistor	3-time flash 2.5 seconds OFF				
	P.C. board temperature thermistor	4-time flash 2.5 seconds OFF				
	Ambient temperature thermistor	2-time flash 2.5 seconds OFF				
4-time flash 2.5 seconds OFF	Overcurrent	11-time flash 2.5 seconds OFF	Large current flows into intelligent power module.	<ul style="list-style-type: none"> •Reconnect compressor connector. •Refer to 10-5. Ⓐ"How to check inverter/compressor". •Check stop valve. 	—	○
	Compressor synchronous abnormality (Compressor start-up failure protection)	12-time flash 2.5 seconds OFF	Waveform of compressor current is distorted.	<ul style="list-style-type: none"> •Reconnect compressor connector. •Refer to 10-5. Ⓐ"How to check inverter/compressor". 	—	○
5-time flash 2.5 seconds OFF	Discharge temperature	—	Temperature of discharge temperature thermistor exceeds 241 °F (116 °C), compressor stops. Compressor can restart if discharge temperature thermistor reads 212 °F (100 °C) or less 3 minutes later.	<ul style="list-style-type: none"> •Check refrigerant circuit and refrigerant amount. •Refer to 10-5. Ⓒ"Check of LEV". 	—	○
6-time flash 2.5 seconds OFF	High pressure	—	Temperature of indoor coil thermistor exceeds 158 °F (70 °C) in HEAT mode. Temperature of defrost thermistor exceeds 158 °F (70 °C) in COOL mode.	<ul style="list-style-type: none"> •Check refrigerant circuit and refrigerant amount. •Check stop valve. 	—	○
7-time flash 2.5 seconds OFF	Fin temperature/ P.C. board temperature	7-time flash 2.5 seconds OFF	Temperature of fin temperature thermistor on the inverter P.C. board exceeds 167 ~ 176 °F (75 ~ 80 °C), or temperature of P.C. board temperature thermistor on the inverter P.C. board exceeds 158 ~ 167 °F (70 ~ 75 °C).	<ul style="list-style-type: none"> •Check around outdoor unit. •Check outdoor unit air passage. •Refer to 10-5. Ⓓ"Check of outdoor fan motor". 	—	○
8-time flash 2.5 seconds OFF	Outdoor fan motor	—	Outdoor fan has stopped 3 times in a row within 30 seconds after outdoor fan start-up.	<ul style="list-style-type: none"> •Refer to 10-5. Ⓓ"Check of outdoor fan motor". Refer to 10-5. Ⓓ"Check of inverter P.C. board". 	—	○
9-time flash 2.5 seconds OFF	Nonvolatile memory data	5-time flash 2.5 seconds OFF	Nonvolatile memory data cannot be read properly.	<ul style="list-style-type: none"> •Replace the inverter P.C. board. 	○	○
10-time flash 2.5 seconds OFF	Discharge temperature	—	Temperature of discharge temperature thermistor has been 122 °F (50 °C) or less for 20 minutes.	<ul style="list-style-type: none"> •Refer to 10-5. Ⓒ"Check of LEV". •Check refrigerant circuit and refrigerant amount. 	—	○
11-time flash 2.5 seconds OFF	DC voltage	8-time flash 2.5 seconds OFF	DC voltage of inverter cannot be detected normally.	<ul style="list-style-type: none"> •Refer to 10-5. Ⓐ"How to check inverter/compressor". 	—	○
	Each phase current of compressor	9-time flash 2.5 seconds OFF	Each phase current of compressor cannot be detected normally.			
12-time flash 2.5 seconds OFF	Overcurrent Compressor open-phase	10-time flash 2.5 seconds OFF	Large current flows into intelligent power module (IPM). The open-phase operation of compressor is detected. The interphase short out occurs in the output of the intelligent power module (IPM). The compressor winding shorts out.	<ul style="list-style-type: none"> •Reconnect compressor connector. •Refer to 10-5. Ⓐ"How to check inverter/compressor". 	—	○
14-time flash 2.5 seconds OFF	Stop valve (Closed valve)	14-time flash 2.5 seconds OFF	Closed valve is detected by compressor current.	<ul style="list-style-type: none"> •Check stop valve 	○	○

NOTE: Blinking patterns of this mode differ from the ones of Troubleshooting check table (10-3.).

10-3. TROUBLESHOOTING CHECK TABLE

No.	Symptom	LED indication	Abnormal point/ Condition	Condition	Correspondence	
1	Outdoor unit does not operate.	1-time flash every 2.5 seconds	Outdoor power system	Overcurrent protection stop is continuously performed 3 times within 1 minute after the compressor gets started, or failure of restart of compressor has repeated 24 times.	•Reconnect connector of compressor. •Refer to 10-5.Ⓐ "How to check inverter/ compressor". •Check stop valve.	
2			Outdoor thermistors	Discharge temperature thermistor, fin temperature thermistor, defrost thermistor, P.C. board temperature thermistor or ambient temperature thermistor shorts or opens during compressor running.	•Refer to 10-5.Ⓒ "Check of outdoor thermistors".	
3			Outdoor control system	Nonvolatile memory data cannot be read properly. (POWER lamp of the indoor unit lights up or flashes 7-time.)	•Replace inverter P.C. board.	
4		6-time flash 2.5 seconds OFF	Serial signal	The communication fails between the indoor and outdoor unit for 3 minutes.	•Refer to 10-5.Ⓜ "How to check miswiring and serial signal error."	
5		11-time flash 2.5 seconds OFF	Stop valve/ Closed valve	Closed valve is detected by compressor current.	•Check stop valve.	
6		14-time flash 2.5 seconds OFF	Outdoor unit (Other abnormality)	Outdoor unit is defective.	•Refer to 10-2.2. "Flow chart of the detailed outdoor unit failure mode recall function".	
7	'Outdoor unit stops and restarts 3 minutes later' is repeated.	2-time flash 2.5 seconds OFF	Overcurrent protection	Large current flows into intelligent power module. ※ When overcurrent protection occurs within 10 seconds after compressor starts, compressor restarts after 15 seconds.	•Reconnect connector of compressor. •Refer to 10-5.Ⓐ "How to check inverter/compressor". •Check stop valve.	
8		3-time flash 2.5 seconds OFF	Discharge temperature overheat protection	Temperature of discharge temperature thermistor exceeds 241 °F (116 °C), compressor stops. Compressor can restart if discharge temperature thermistor reads 212 °F (100 °C) or less 3 minutes later.	•Check refrigerant circuit and refrigerant amount. •Refer to 10-5.Ⓚ "Check of LEV".	
9		4-time flash 2.5 seconds OFF	Fin temperature /P.C. board temperature thermistor overheat protection	Temperature of fin temperature thermistor on the heat sink exceeds 167 ~ 176 °F (75 ~ 80 °C) or temperature of P.C. board temperature thermistor on the inverter P.C. board exceeds 158 ~ 167 °F (70 ~ 75 °C).	•Check around outdoor unit. •Check outdoor unit air passage. •Refer to 10-5.Ⓛ "Check of outdoor fan motor".	
10		5-time flash 2.5 seconds OFF	High pressure protection	Indoor coil thermistor exceeds 158 °F (70 °C) in HEAT mode. Defrost thermistor exceeds 158 °F (70 °C) in COOL mode.	•Check refrigerant circuit and refrigerant amount. •Check stop valve.	
11		8-time flash 2.5 seconds OFF	Compressor synchronous abnormality	The waveform of compressor current is distorted.	•Reconnect connector of compressor. •Refer to 10-5.Ⓐ "How to check inverter/compressor".	
12		10-time flash 2.5 seconds OFF	Outdoor fan motor	Outdoor fan has stopped 3 times in a row within 30 seconds after outdoor fan start-up.	•Refer to 10-5.Ⓛ "Check of outdoor fan motor." •Refer to 10-5.Ⓛ "Check of inverter P.C. board."	
13		12-time flash 2.5 seconds OFF	Each phase current of compressor	Each phase current of compressor cannot be detected normally	•Refer to 10-5.Ⓐ "How to check inverter/compressor".	
14		13-time flash 2.5 seconds OFF	DC voltage	DC voltage of inverter cannot be detected normally.	•Refer to 10-5.Ⓐ "How to check inverter/compressor".	
15		Outdoor unit operates.	1-time flash 2.5 seconds OFF	Frequency drop by current protection	Current from power outlet reaches the protection current, and compressor frequency lowers.	The unit is normal, but check the following.
16			3-time flash 2.5 seconds OFF	Frequency drop by high pressure protection	Temperature of indoor coil thermistor exceeds 131 °F (55 °C) in HEAT mode, compressor frequency lowers.	•Check if indoor filters are clogged. •Check if refrigerant is short. •Check if indoor/outdoor unit air circulation is short cycled.
				Frequency drop by defrosting in COOL mode	Indoor coil thermistor reads 46 °F (8 °C) or less in COOL mode, compressor frequency lowers.	
17		4-time flash 2.5 seconds OFF	Frequency drop by discharge temperature protection	Temperature of discharge temperature thermistor exceeds 232 °F (111 °C), compressor frequency lowers.	•Check refrigerant circuit and refrigerant amount. •Refer to 10-5.Ⓚ "Check of LEV". •Refer to 10-5.Ⓒ "Check of outdoor thermistors".	

NOTE: 1. The location of LED is illustrated at the right figure. Refer to 10-6.1.
2. LED is lighted during normal operation.

Inverter P.C. board(Parts side)

The flashing frequency shows the number of times the LED blinks after every 2.5-second OFF. Flashing (Example) When the flashing frequency is "2".

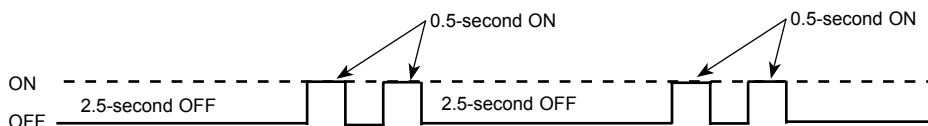
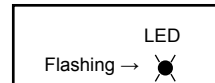



No.	Symptom	LED indication	Abnormal point/ Condition	Condition	Correspondence
18	Outdoor unit operates.	7-time flash 2.5 seconds OFF	Low discharge temperature protection	Temperature of discharge temperature thermistor has been 122 °F (50 °C) or less for 20 minutes.	•Refer to 10-5.⊗ "Check of LEV". •Check refrigerant circuit and refrigerant amount.
19		8-time flash 2.5 seconds OFF	PAM protection PAM: Pulse Amplitude Modulation	The overcurrent flows into IGBT (Insulated Gate Bipolar transistor : TR821) or when the bus-bar voltage reaches 320 V or more, PAM stops and restarts.	This is not malfunction. PAM protection will be activated in the following cases; 1 Instantaneous power voltage drop (Short time power failure) 2 When the power supply voltage is high.
20		9-time flash 2.5 seconds OFF	Inverter check mode	The connector of compressor is disconnected, inverter check mode starts.	•Check if the connector of the compressor is correctly connected. Refer to 10-5.Ⓐ "How to check inverter/ compressor".

10-4. TROUBLE CRITERION OF MAIN PARTS
MUZ-FD09NA MUZ-FD12NA

Part name	Check method and criterion	Figure						
Defrost thermistor (RT61) Ambient temperature thermistor (RT65) Outdoor heat exchanger temperature thermistor (RT68)	Measure the resistance with a tester. Refer to 10-6. "Test point diagram and voltage", 1. "Inverter P.C. board", the chart of thermistor.							
Discharge temperature thermistor (RT62) Fin temperature thermistor (RT64)	Measure the resistance with a tester. Before measurement, hold the thermistor with your hands to warm it up. Refer to 10-6. "Test point diagram and voltage", 1. "Inverter P.C. board", the chart of thermistor.							
Compressor	Measure the resistance between terminals using a tester. (Winding temperature : -4 ~ 104 °F (-20 ~ 40 °C)) <table border="1" style="margin: 10px auto;"> <thead> <tr> <th colspan="2">Normal</th> </tr> </thead> <tbody> <tr> <td>U-V</td> <td rowspan="3" style="text-align: center;">1.52 ~ 2.17 Ω</td> </tr> <tr> <td>U-W</td> </tr> <tr> <td>V-W</td> </tr> </tbody> </table>		Normal		U-V	1.52 ~ 2.17 Ω	U-W	V-W
Normal								
U-V	1.52 ~ 2.17 Ω							
U-W								
V-W								
Outdoor fan motor	Measure the resistance between lead wires using a tester. (Part temperature : 14 ~ 104 °F (-10 ~ 40 °C)) <table border="1" style="margin: 10px auto;"> <thead> <tr> <th>Color of lead wire</th> <th>Normal</th> </tr> </thead> <tbody> <tr> <td>RED – BLK</td> <td rowspan="3" style="text-align: center;">11 ~ 16 Ω</td> </tr> <tr> <td>BLK – WHT</td> </tr> <tr> <td>WHT – RED</td> </tr> </tbody> </table>	Color of lead wire	Normal	RED – BLK	11 ~ 16 Ω	BLK – WHT	WHT – RED	
Color of lead wire	Normal							
RED – BLK	11 ~ 16 Ω							
BLK – WHT								
WHT – RED								
R. V. coil (21S4)	Measure the resistance using a tester. (Part temperature : 14 ~ 104 °F (-10 ~ 40 °C)) <table border="1" style="margin: 10px auto;"> <thead> <tr> <th>Normal</th> </tr> </thead> <tbody> <tr> <td style="text-align: center;">970 ~ 1380 Ω</td> </tr> </tbody> </table>	Normal	970 ~ 1380 Ω					
Normal								
970 ~ 1380 Ω								
Expansion valve coil (LEV)	Measure the resistance using a tester. (Part temperature : 14 ~ 104 °F (-10 ~ 40 °C)) <table border="1" style="margin: 10px auto;"> <thead> <tr> <th>Color of lead wire</th> <th>Normal</th> </tr> </thead> <tbody> <tr> <td>WHT – RED</td> <td rowspan="4" style="text-align: center;">37 ~ 54 Ω</td> </tr> <tr> <td>RED – ORN</td> </tr> <tr> <td>YLW – BRN</td> </tr> <tr> <td>BRN – BLU</td> </tr> </tbody> </table>	Color of lead wire	Normal	WHT – RED	37 ~ 54 Ω	RED – ORN	YLW – BRN	BRN – BLU
Color of lead wire	Normal							
WHT – RED	37 ~ 54 Ω							
RED – ORN								
YLW – BRN								
BRN – BLU								

10-5. TROUBLESHOOTING FLOW

**POWER lamp flashes 5-times.
Outdoor unit does not operate.**

A How to check inverter/ compressor

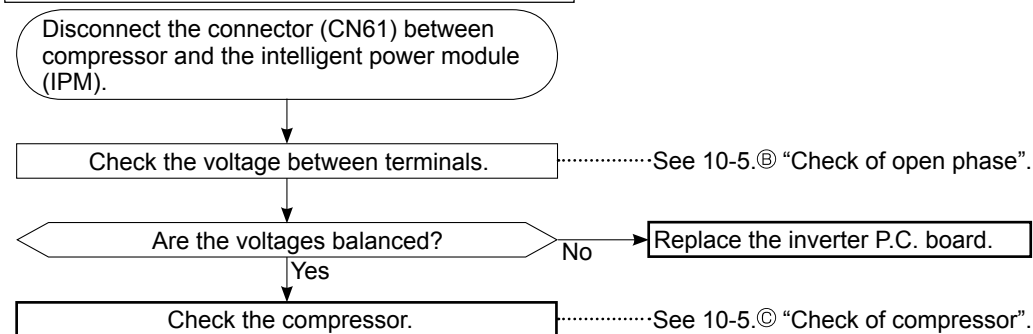

B Check of open phase

- With the connector between the compressor and the intelligent power module disconnected, activate the inverter and check if the inverter is normal by measuring the balance of voltage between the terminals.

Output voltage 115 V

<< Operation method >>

Start cooling or heating operation by pressing EMERGENCY OPERATION switch on the indoor unit. (TEST RUN OPERATION : Refer to 7-6.)

<<Measurement point>>

at 3 points

BLK (U)-WHT (V)

BLK (U)-RED (W)

WHT(V)-RED (W)

Measure AC voltage between the lead wires at 3 points.

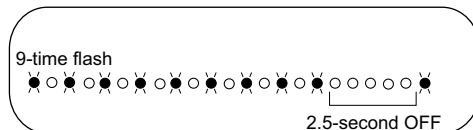

- NOTE:** 1. Output voltage varies according to power supply voltage.
2. Measure the voltage by analog type tester.
3. During this check, LED of the inverter P.C. board flashes 9 times. (Refer to 10-6.1.)

C Check of compressor

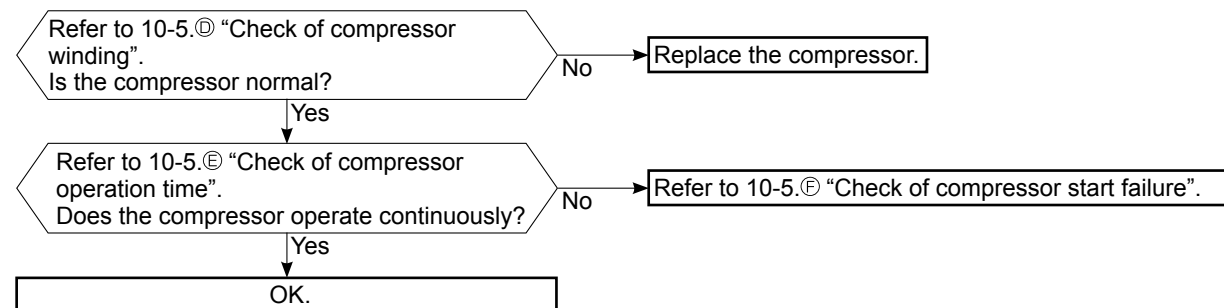

D Check of compressor winding

- Disconnect the connector (CN61) between the compressor and intelligent power module, and measure the resistance between the compressor terminals.

<<Measurement point>>

at 3 points

BLK-WHT

BLK-RED

WHT-RED

※ Measure the resistance between the lead wires at 3 points.

<<Judgement>>

Refer to 10-4.

0[Ω]Abnormal [short]

Infinite[Ω]Abnormal [open]

NOTE: Be sure to zero the ohmmeter before measurement.

E Check of compressor operation time

- Connect the compressor and activate the inverter. Then measure the time until the inverter stops due to over current.

<<Operation method>>

Start heating or cooling operation by pressing EMERGENCY OPERATION switch on the indoor unit.

(TEST RUN OPERATION : Refer to 7-6.)

<<Measurement>>

Measure the time from the start of compressor to the stop of compressor due to overcurrent.

<<Judgement>>

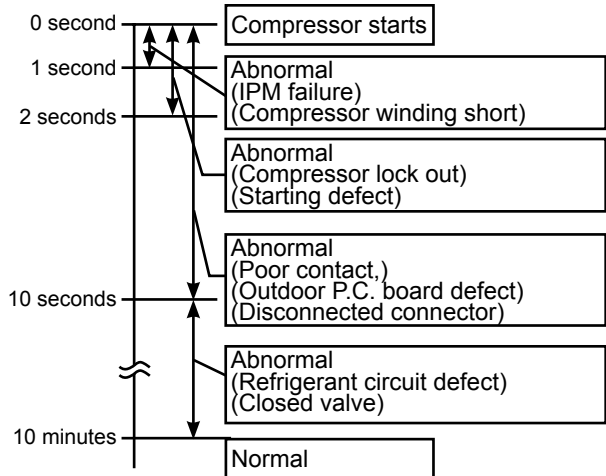

F Check of compressor start failure

Confirm that 1~4 is normal.

- Electrical circuit check

1. Contact of the compressor connector (including CN61)

2. Output voltage of inverter P.C. board and balance of them (See 10-5.⑥)

3. Direct current voltage between DB61(+) and (-) on the inverter P.C. board

4. Voltage between outdoor terminal block S1-S2

Does the compressor run for 10 seconds or more after it starts?

Yes

Check the refrigerant circuit.
Check the stop valve.

No

After the compressor is heated with a drier, does the compressor start? ※1

No

Replace the compressor.

Yes

Compressor start failure. Activate pre-heat control.
(Refer to 9-2. "PRE-HEAT CONTROL SETTING")

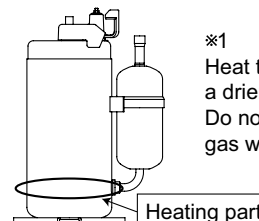

※1

Heat the compressor with a drier for about 20 minutes. Do not recover refrigerant gas while heating.

**POWER lamp flashes 6-time.
The thermistors in the outdoor unit are abnormal.**

Ⓒ Check of outdoor thermistors

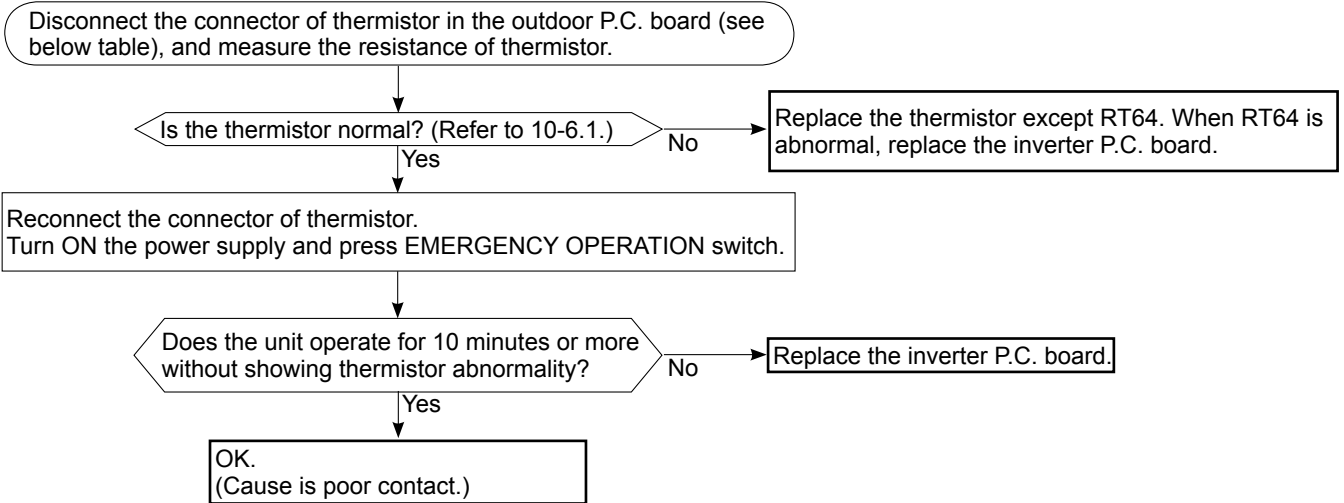

Thermistor	Symbol	Connector, Pin No.	Board
Defrost	RT61	Between CN641 pin1 and pin2	Inverter P.C. board
Discharge temperature	RT62	Between CN641 pin3 and pin4	
Fin temperature	RT64	Between CN642 pin1 and pin2	
Ambient temperature	RT65	Between CN643 pin1 and pin2	
Outdoor heat exchanger temperature	RT68	Between CN644 pin1 and pin3	

Ⓓ Check of R.V. coil

- ※ First of all, measure the resistance of R.V. coil to check if the coil is defective. Refer to 10-4.
- ※ In case CN721 is not connected or R.V. coil is open, voltage is generated between the terminal pins of the connector although any signal is not being transmitted to R.V. coil. Check if CN721 is connected.

Unit operates COOL mode even if it is set to HEAT mode.

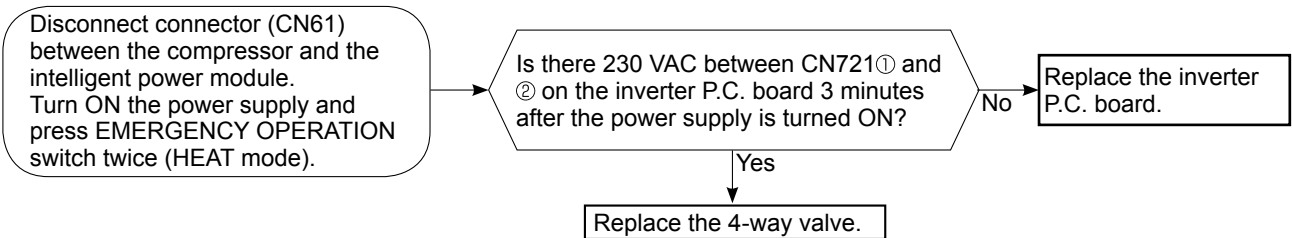

Unit operates HEAT mode even if it is set to COOL mode.

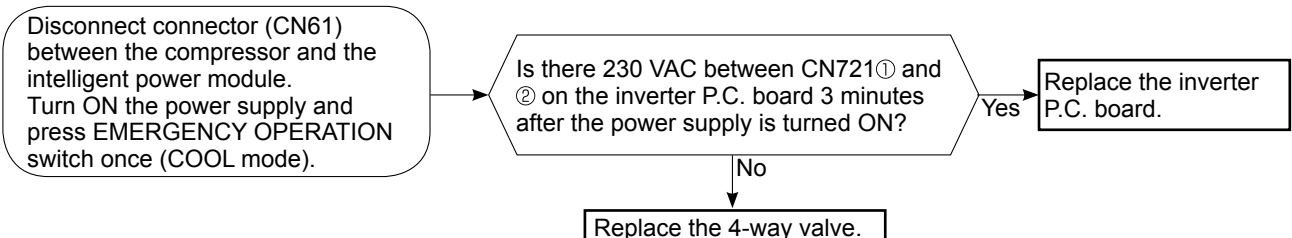

Outdoor fan motor does not operate.

① Check of outdoor fan motor

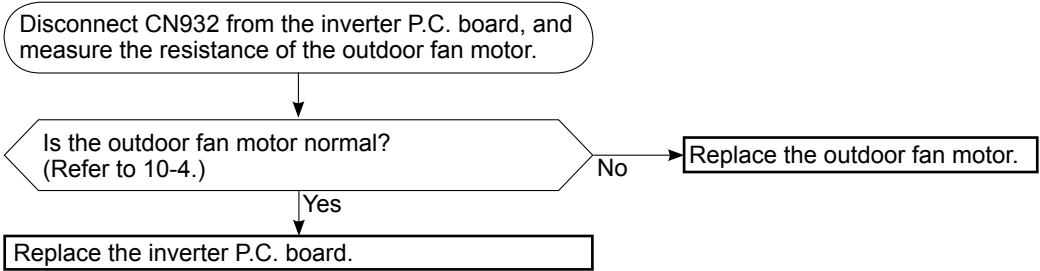

Inverter does not operate.

② Check of power supply

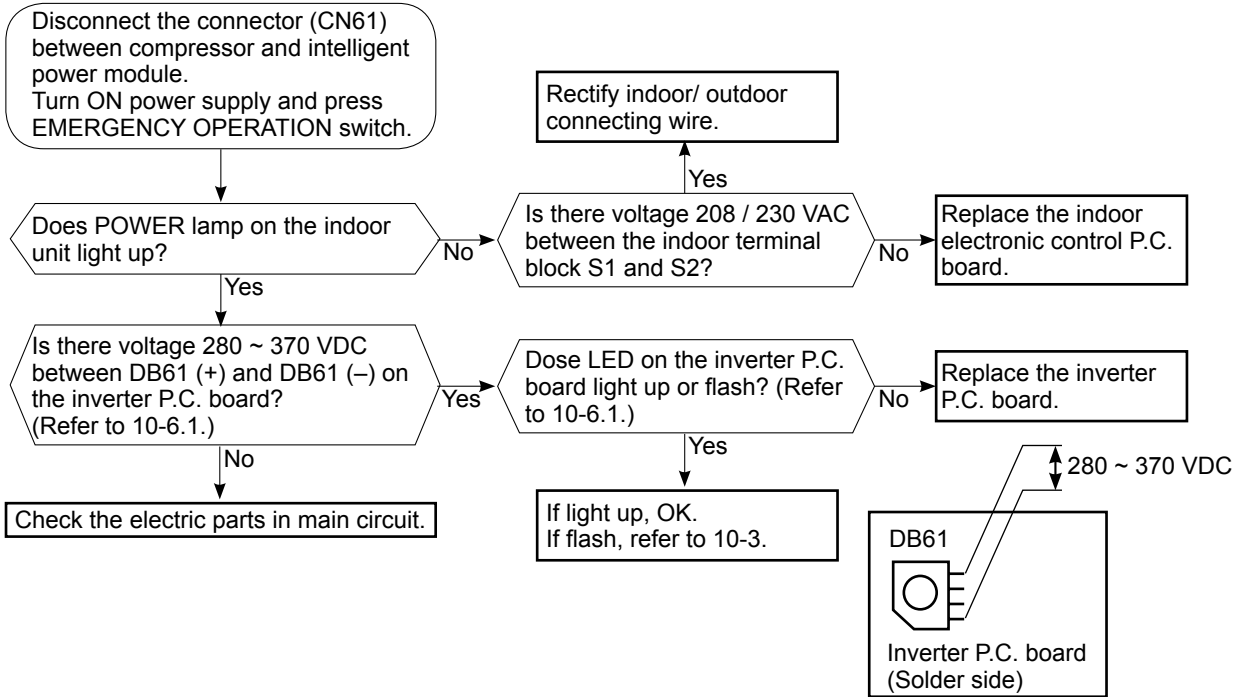

Heating/Cooling does not work sufficiently.

K Check of LEV (Expansion valve)

Turn ON the power supply.

<Preparation of the remote controller>

- ① While pressing both OPERATION SELECT button and TOO COOL button on the remote controller at the same time, press RESET button.
- ② First, release RESET button.
And release the other two buttons after all LCD except the set temperature in operation display section of the remote controller is displayed after 3 seconds.

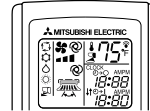
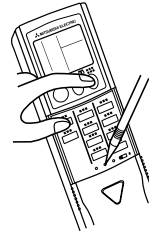

Press OPERATE/STOP (ON/OFF) button of the remote controller (the set temperature is displayed) with the remote controller headed towards the indoor unit. *1

Expansion valve operates in full-opening direction.

*1. Regardless of normal or abnormal condition, a short beep is emitted once the signal is received.

Do you hear the expansion valve "click, click....."?
Do you feel the expansion valve vibrate on touching it?

Yes → OK.

No →

Is LEV coil properly fixed to the expansion valve?

No → Properly fix the LEV coil to the expansion valve.

Yes →

Does the resistance of LEV coil have the characteristics? (Refer to 10-4.)

No → Replace the LEV coil.

Yes →

Measure each voltage between connector pins of CN724 on the inverter P.C. board.

1. Pin③(-) — Pin①(+)
2. Pin④(-) — Pin①(+)
3. Pin⑤(-) — Pin①(+)
4. Pin⑥(-) — Pin①(+)

Is there about 3 ~ 5 VAC between each?
NOTE: Measure the voltage by an analog tester.

No → Replace the inverter P.C. board.

Yes → Replace the expansion valve.

NOTE : After check of LEV, do the undermentioned operations.
1. Turn OFF the power supply and turn ON it again.
2. Press RESET button on the remote controller.

Outdoor fan motor does not operate, or stops immediately after starting up.

Ⓐ Check of inverter P.C. board

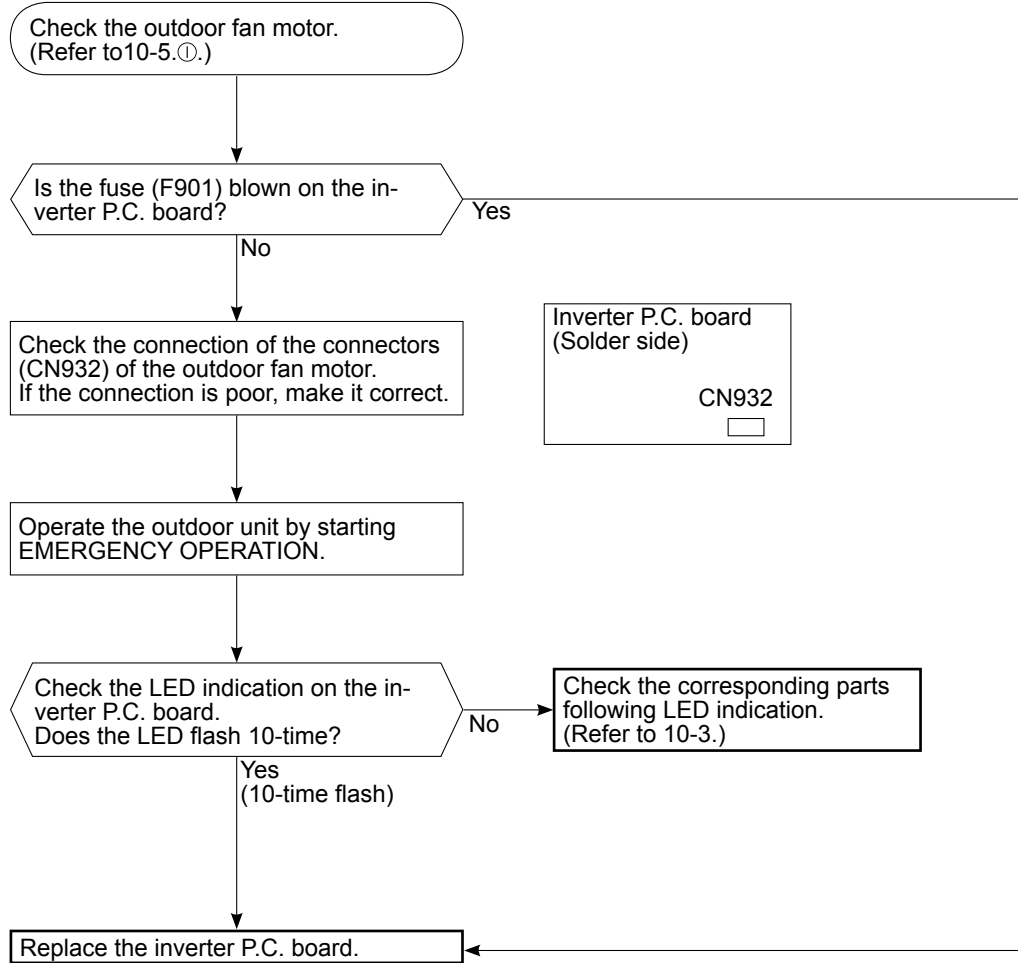

- Unit cannot operate neither by the remote controller nor by EMERGENCY OPERATION switch.
Indoor unit does not operate.
- POWER lamp flashes ON and OFF in every 0.5 seconds.
Outdoor unit doesn't operate.

M How to check miswiring and serial signal error (outdoor unit does not work)

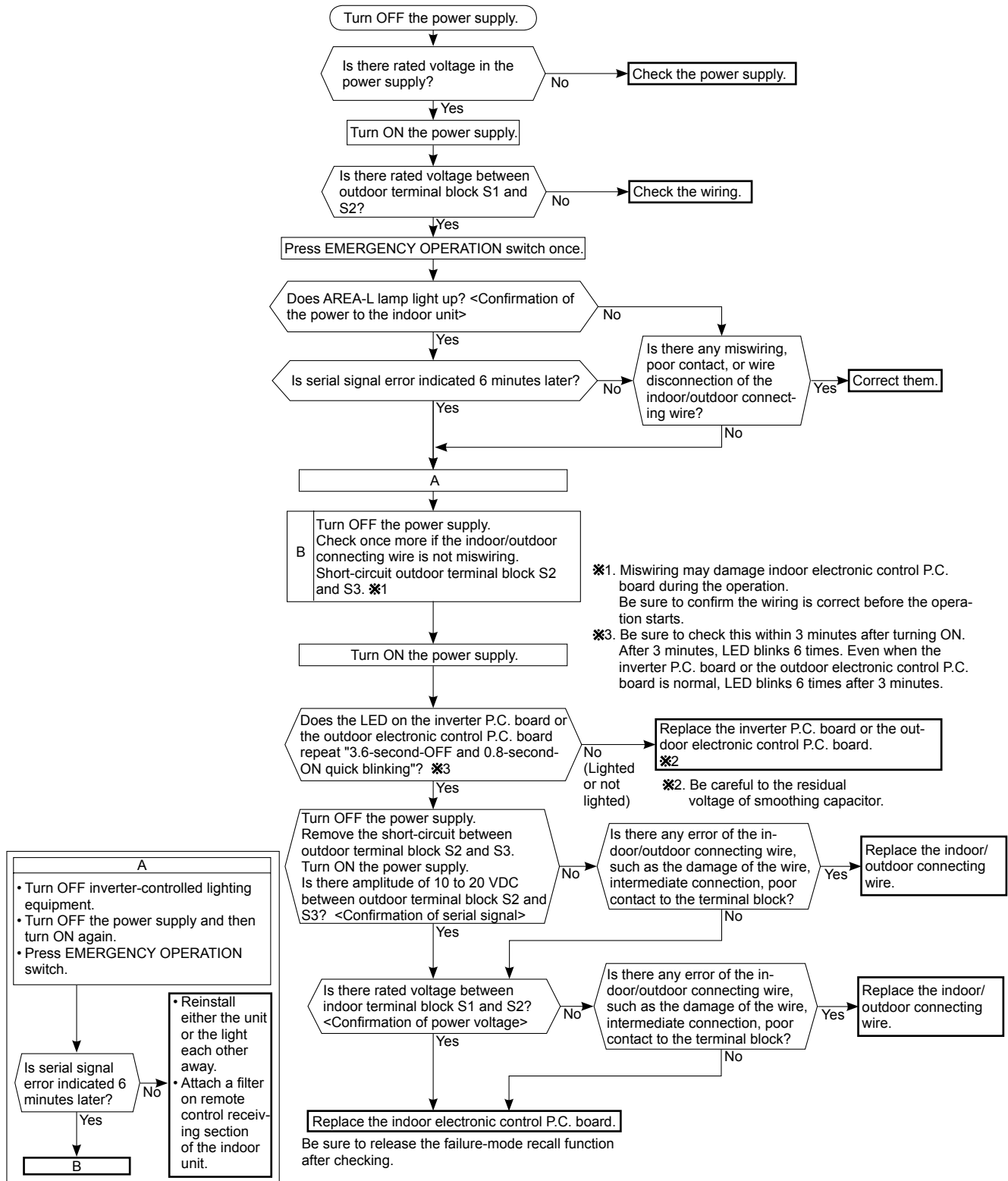

Ⓝ Electromagnetic noise enters into TV sets or radios

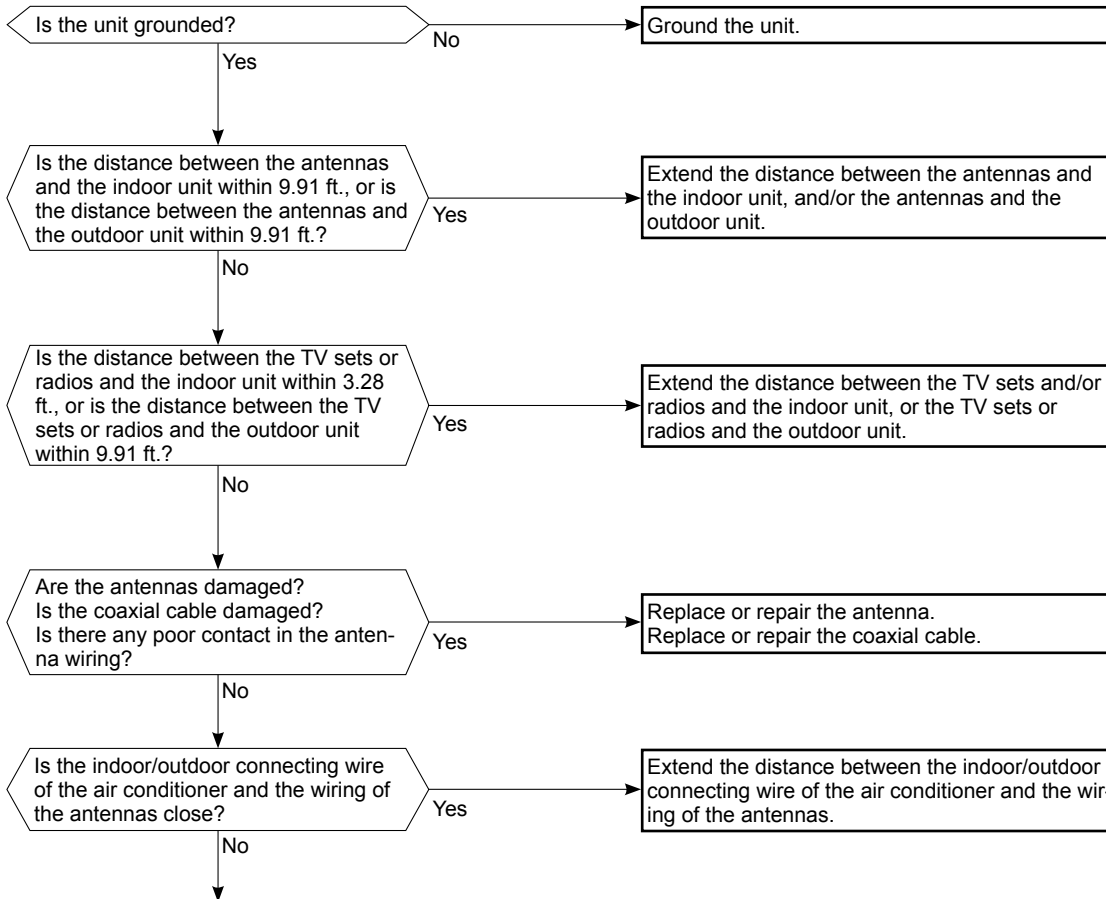

Even if all of the above conditions are fulfilled, the electromagnetic noise may enter, depending on the electric field strength or the installation condition (combination of specific conditions such as antennas or wiring).

Check the followings before asking for service.

1. Devices affected by the electromagnetic noise
TV sets, radios (FM/AM broadcast, shortwave)
2. Channel, frequency, broadcast station affected by the electromagnetic noise
3. Channel, frequency, broadcast station unaffected by the electromagnetic noise
4. Layout of ;
indoor/outdoor unit of the air conditioner, indoor/outdoor wiring, grounding wire, antennas, wiring from antennas, receiver
5. Electric field intensity of the broadcast station affected by the electromagnetic noise
6. Presence or absence of amplifier such as booster
7. Operation condition of air conditioner when the electromagnetic noise enters in
 - 1) Turn OFF the power supply once, and then turn ON the power supply. In this situation, check for the electromagnetic noise.
 - 2) Within 3 minutes after turning ON the power supply, press OPERATE/STOP (ON/OFF) button on the remote controller for power ON, and check for the electromagnetic noise.
 - 3) After a short time (3 minutes later after turning ON), the outdoor unit starts running. During operation, check for the electromagnetic noise.
 - 4) Press OPERATE/STOP (ON/OFF) button on the remote controller for power OFF, when the outdoor unit stops but the indoor/outdoor communication still runs on. In this situation, check for the electromagnetic noise.

10-6. TEST POINT DIAGRAM AND VOLTAGE

1. Inverter P.C. board

MUZ-FD09NA MUZ-FD12NA

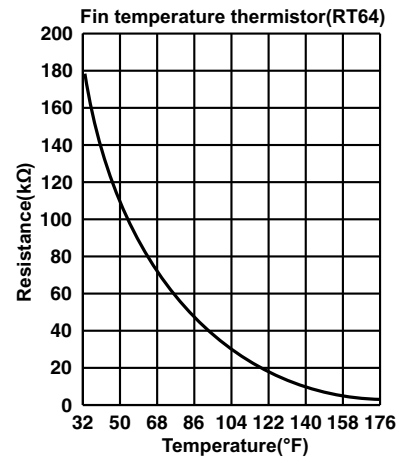
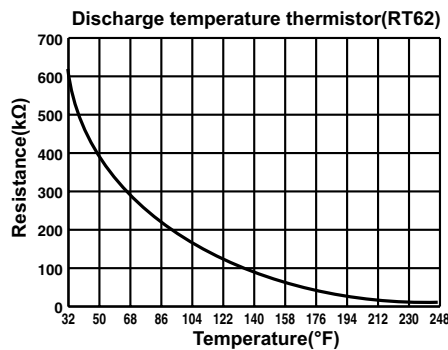
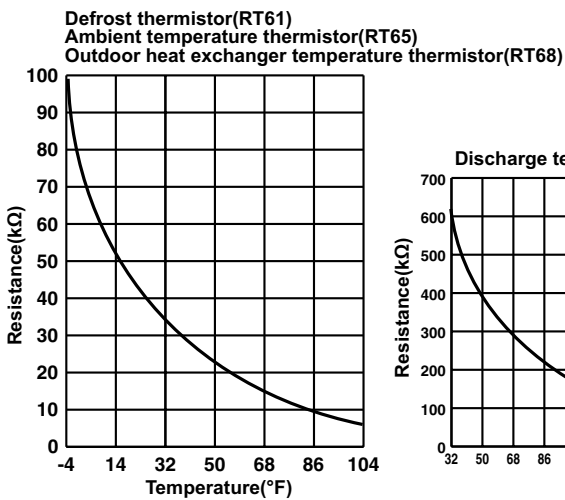
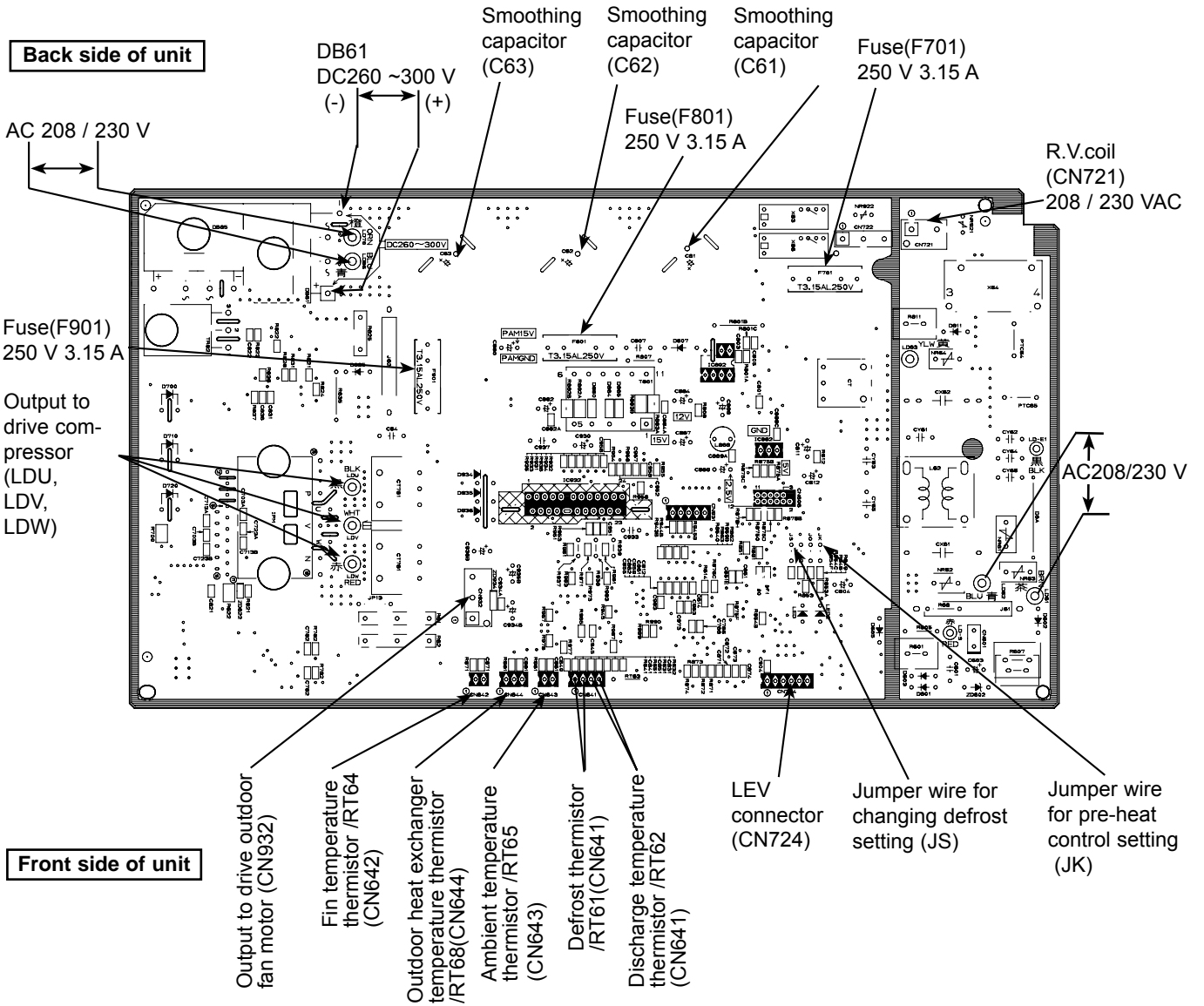

<"Terminal with locking mechanism" Detaching points>

The terminal which has the locking mechanism can be detached as shown below.
 There are two types (Refer to (1) and (2)) of the terminal with locking mechanism.
 The terminal without locking mechanism can be detached by pulling it out.
 Check the shape of the terminal before detaching.

(1) Slide the sleeve and check if there is a locking lever or not.

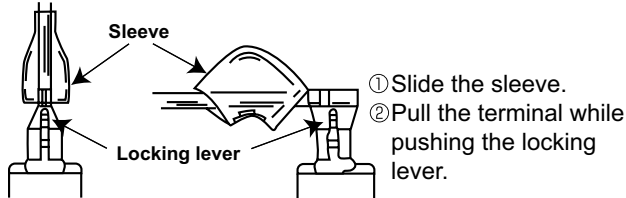

(2) The terminal with this connector has the locking mechanism.

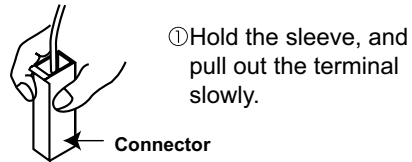

11-1. MUZ-FD09NA MUZ-FD12NA

NOTE : Turn OFF power supply before disassembling.

OPERATING PROCEDURE	PHOTOS
<p>1. Removing the cabinet</p> <p>(1) Remove the screw fixing the service panel. (See Photo 1.)</p> <p>(2) Pull down the service panel and remove it. (See Photo 1.)</p> <p>(3) Remove the screws fixing the conduit cover. (See Photo 2.)</p> <p>(4) Remove the conduit cover. (See Photo 2.)</p> <p>(5) Disconnect the power supply wire and indoor/outdoor connecting wire.</p> <p>(6) Remove the screws fixing the top panel. (See Photo 1.)</p> <p>(7) Remove the top panel. (See Photo 1.)</p> <p>(8) Remove the screws fixing the cabinet.</p> <p>(9) Remove the cabinet.</p> <p>(10) Remove the screws fixing the back panel.</p> <p>(11) Remove the back panel.</p> <p>Photo 2</p>	<p>Photo 1</p>

OPERATING PROCEDURE

2. Removing the inverter assembly, inverter P.C. board

- (1) Remove the cabinet and panels. (Refer to 1.)
- (2) Disconnect the lead wire to the reactor and the following connectors;
<Inverter P.C. board>
CN721 (R.V.coil)
CN932 (Fan motor)
CN641 (Defrost thermistor and discharge temperature thermistor)
CN643 (Ambient temperature thermistor)
CN644 (Outdoor heat exchanger temperature thermistor)
CN724 (LEV)
- (3) Remove the compressor connector (CN61).
- (4) Remove the screws fixing the relay panel. (See Photo 3.)
- (5) Remove the inverter assembly. (See Photo 4.)
- (6) Remove the screw of the ground wire and screw of the T.B.support. (See Photo 4.)
- (7) Remove the inverter P.C. board from the inverter assembly.

3. Removing R.V. coil

- (1) Remove the cabinet and panels. (Refer to 1.)
- (2) Remove the R.V. coil. (See Photo 5.)

4. Removing the discharge temperature thermistor, defrost thermistor and outdoor heat exchanger temperature thermistor.

- (1) Remove the cabinet and panels. (Refer to 1.)
- (2) Pull out the discharge temperature thermistor from its holder. (See Photo 5.)
- (3) Pull out the defrost thermistor from its holder. (See Photo 6.)
- (4) Pull out the outdoor heat exchanger temperature thermistor from its holder. (See Photo 6.)

PHOTOS

Photo 3

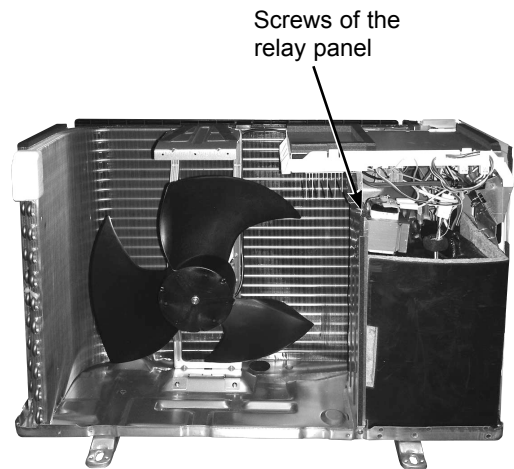

Photo 4 (inverter assembly)

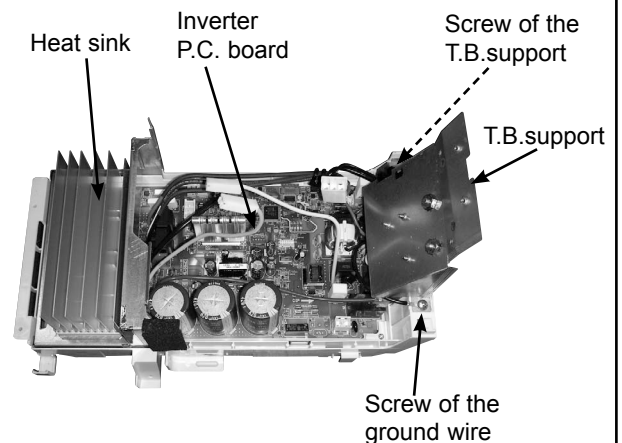
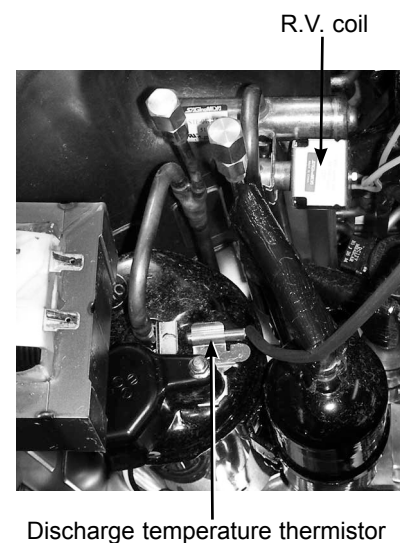

Photo 5



OPERATING PROCEDURE

5. Removing outdoor fan motor

- (1) Remove the cabinet and panels. (Refer to 1.)
- (2) Disconnect the connectors for outdoor fan motor.
- (3) Remove the propeller nut. (See Photo 7.)
- (4) Remove the propeller. (See Photo 7.)
- (5) Remove the screws fixing the fan motor. (See Photo 7.)
- (6) Remove the fan motor.

6. Removing the compressor and 4-way valve

- (1) Remove the cabinet and panels. (Refer to 1.)
- (2) Remove the inverter assembly. (Refer to 2.)
- (3) Recover gas from the refrigerant circuit.
NOTE: Recover gas from the pipes until the pressure gauge shows 0 PSIG.
- (4) Detach the welded part of the suction and the discharge pipe connected with compressor.
- (5) Remove the nuts of compressor legs.
- (6) Remove the compressor.
- (7) Detach the welded part of pipes connected with 4-way valve. (See Photo 8.)

PHOTOS

Photo 6

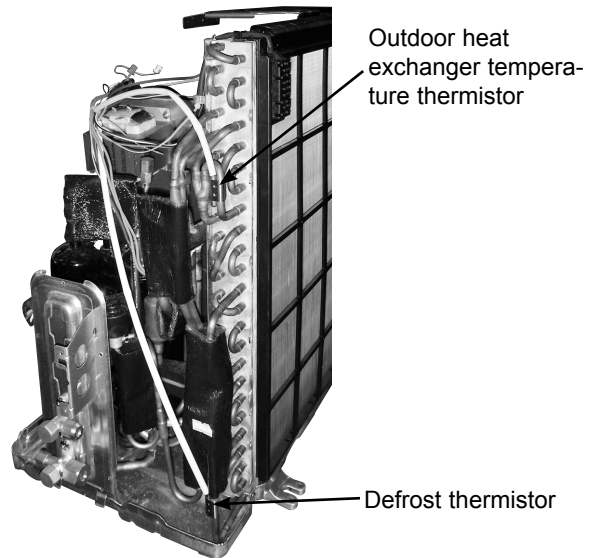
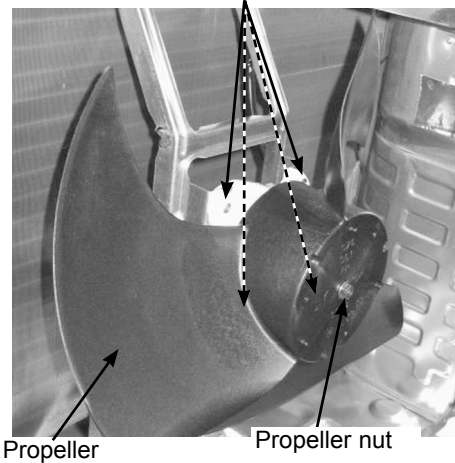

Photo 7 Screws of the outdoor fan motor



Propeller

Propeller nut

Photo 8

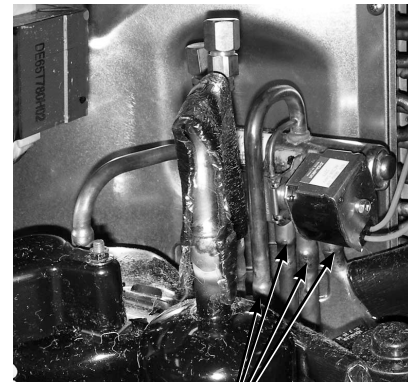

Welded parts of 4-way valve

Mr. SLIM™

 **MITSUBISHI ELECTRIC CORPORATION**
HEAD OFFICE: TOKYO BLDG., 2-7-3, MARUNOUCHI, CHIYODA-KU, TOKYO 100-8310, JAPAN

© Copyright 2008 MITSUBISHI ELECTRIC ENGINEERING CO.,LTD
Distributed in Jan. 2008. No. OBH498 7
Made in Japan

New publication, effective Jan. 2008
Specifications subject to change without notice.