

SHARP®

Version 2.2
Produced in April 2002

Sharp Programmable Controller New Satellite JW20H/30H

ME-NET module

Model name
JW-21MN

User's Manual



Thank you for purchasing the ME-NET module (JW-21MN) for the SHARP programmable controller. Read this manual thoroughly to completely familiarize yourself with the operation according to the examples. Keep this manual for future reference. We are confident that this manual will be helpful whenever you encounter a problem.

Note

- This manual describes the JW-21MN that will be compatible with the JW30H. The JW-21MN that is applied to JW30H has a **30Hn** mark in front of the module. Beside this, the JW-21MN has models with **30H** marks and without **30H** marks.

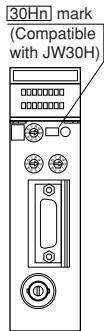

JW-21MN	Descriptions
With 30Hn mark	Can be used when installing the JW-21MN into JW30H control module: JW-31CUH/32CUH/33CUH (conventional models) and JW-31CUH1/32CUH1/33CUH1/33CUH2 /33CUH3 (new models).
With 30H mark	Can be used when installing the JW-21MN into JW30H control module (conventional models). When installing the JW-21MN into the new models, the control module can be used as conventional models.
No mark	The JW-21MN cannot be used with the JW30H control module (both conventional and new models). It can be used only with the JW20/JW20H control module.

- New functions in the revised edition in order to apply to JW30H are represented by the **V2** mark.

Marks used in this manual	Descriptions
V2	Functions that can be used when the JW-21MN (compatible with the JW30H) is installed into the JW20/JW20H/JW30H.

- In this manual, programmable controller is referred to as "PC." Number and symbol in parentheses added to address or setting value indications represent the following:
 Octal..... (8)
 Hexadecimal..... (H)
 Decimal..... (D) or no indication

Note

- This manual was written with the utmost care. However, if you have any questions or inquiries concerning the product, please feel free to contact our dealers or service agents.
- No part of this manual may be reproduced in any form without the written permission of Sharp corporation.
- The contents of this manual are subject to change without prior notice.

Safety Precautions



Read this manual and attached documents carefully before installation, operation, maintenance and checking in order to use the machine correctly. Understand all of the machine knowledge, safety information, and cautions before starting to use. In this instruction manual, safety precautions are ranked into "danger" and "caution" as follows.



 **Danger** : Wrong handling may possibly lead to death or heavy injury.

 **Caution** : Wrong handling may possibly lead to medium or light injury.

Even in the case of  **Caution** , a serious result may be experienced depending on the circumstances. Anyway, important points are mentioned. Be sure to observe them strictly.

The picture signs of prohibit and compel are explained below.

 : It means don'ts. For example, prohibition of disassembly is indicated as ().

 : It means a must. For example, obligation of grounding is indicated as (.

1) Installation

Caution

- Use in the environments specified in the catalog, instruction manual, and user's manual. Electric shock, fire or malfunction may be caused when used in the environments of high temperature, high humidity, dusty or corrosive atmosphere, vibration or impact.
- Install according to the manual. Wrong installation may cause drop, breakdown, or malfunction.
- Never admit wire chips or foreign matters. Or fire, breakdown or malfunction may be caused.

2) Wiring

Compel

- Be sure to ground. Unless grounded, electric shock or malfunction may be caused.

Caution

- Connect the rated power source. Connection of a wrong power source may cause a fire.
- Wiring should be done by a qualified electrician. Wrong wiring may lead to fire, breakdown or electric shock.

3) Use

 **Danger**

- Don't touch the terminal while the power is being supplied or you may have an electric shock.
- Assemble the emergency stop circuit and interlock circuit outside of the programmable controller. Otherwise breakdown or accident damage of the machine may be caused by the trouble of the programmable controller.

 **Caution**

- "RUN" or "STOP" during operation should be done with particular care by confirming safety. Misoperation may lead to damage or accident of the machine.
- Turn on the power source in the specified sequence. Turning ON with wrong sequence may lead to machine breakdown or accident.

4) Maintenance

 **Prohibit**

- Don't disassemble or modify the modules.
Or fire, breakdown or malfunction may be caused.

 **Caution**

- Turn OFF the power source before detaching or attaching the module.
Or electric shock, malfunction or breakdown may be caused.

ME-NET Module: JW-21MN

- User's Manual -

Chapter 1 Features and Functions

Chapter 2 Safety Precautions

Chapter 3 System Configuration

Chapter 4 Name and Function of Each Part

Chapter 5 Installation

Chapter 6 Processing of Cables

Chapter 7 Wiring Method

Chapter 8 Memory Address on the ME-NET

Chapter 9 Description for Data Link Operation

Chapter 10 Description for Computer Link Operation

Chapter 11 Setting of Switches and Parameters

Chapter 12 Errors and Countermeasures

Chapter 13 Replacement of the JW-21MN

Chapter 14 Support Tools

Chapter 15 Specifications

Chapter 16 Appendix

Alphabetical Index

Table of contents

Chapter 1: Features and Functions	1-1
Chapter 2: Safety Precautions	2-1 to 3
2-1 Installation	2-1
2-2 Wiring	2-1
2-3 Treatment	2-3
2-4 Static electricity	2-3
2-5 Maintenance	2-3
2-6 Allocation of relay number	2-3
Chapter 3: System Configuration	3-1
Chapter 4: Name and Function of Each Part	4-1
Chapter 5: Installation	5-1
Chapter 6: Processing of Cables	6-1 to 6
6-1 Processing cable end	6-2
6-2 Connector crimping procedure	6-5
Chapter 7: Wiring Method	7-1 to 7
7-1 Cable trunk and branch lines	7-1
7-2 Relaying of trunk cables	7-1
7-3 Cable wiring procedure in control panel	7-2
7-4 Waterproof and insulation processing of connectors	7-4
7-5 Wiring of cables at outside control panels	7-5
7-6 Check after wiring	7-5
7-7 Wiring method for adding a communication station	7-6
Chapter 8: Memory Address on the ME-NET	8-1 to 4
8-1 Memory address for data links	8-1
8-2 Memory addresses for computer links	8-3
Chapter 9: Description for Data Link Operation	9-1 to 7
9-1 Communication method	9-1
[1] Data link (Standard function)	9-1
[2] Data link (Save memory function)	9-2
9-2 Required transmission time and communication delay time	9-3
[1] Required transmission time	9-3
[2] Communication delay time	9-4
[3] Data transmission between master PC and slave PC	9-5
9-3 Expansion of network	9-6
[1] Multiple installation of the JW-21MN	9-6
[2] Hierarchical link	9-7

Chapter 10: Description for Computer Link Operation	10-1 to 14
10-1 Computer link function	10-1
[1] Basic commands	10-1
[2] Optional commands	10-1
10-2 Basic commands	10-2
10-3 Optional commands	10-3
[1] Read free memory size	10-4
[2] Monitor TMR, CNT, and MD	10-4
[3] Reading PC mode	10-5
[4] Setting PC mode	10-5
[5] Reading system memory	10-6
[6] Writing system memory	10-6
[7] Reading date	10-7
[8] Setting date	10-7
[9] Reading time	10-8
[10] Setting time	10-8
[11] Correct clock time	10-9
[12] Monitor step status: JW20/JW20H only	10-9
[13] Read the optional parameters	10-10
[14] Set the optional parameters	10-10
[15] Read the special I/O parameters	10-11
[16] Set the special I/O parameters	10-11
[17] Set the secret function: JW30H only	10-12
[18] Release the secret function, register password: JW30H only	10-12
[19] Check the secret function: JW30H only	10-13
[20] Response on error	10-14
 Chapter 11: Setting of Switches and Parameter	 11-1 to 28
11-1 Operation procedure	11-1
11-2 Switch setting of master station and slave station	11-2
[1] Mode switch (MODE)	11-2
[2] Module No. switch (UNIT NO.)	11-2
11-3 Setting contents of master station parameters	11-5
[1] Setting contents	11-5
[2] Communication area map	11-7
[3] Setting range of relay link area, register link area, and flag area	11-11
[4] Setting procedure	11-13
11-4 Setting slave station parameters (common for all slave stations)	11-22
[1] Setting contents	11-22
[2] Setting range of flag area	11-23
[3] Setting procedure	11-24
 Chapter 12: Errors and Countermeasures	 12-1 to 7
12-1 Indication lamps	12-1
12-2 Flag	12-2
[1] Flag table	12-2
[2] In the case of a master station	12-3
[3] In the case of slave station 01 to 77 ⁽⁸⁾	12-4
[4] Monitor operation condition by each station PC	12-5

12-3 Storage of error code	12-6
Chapter 13: Replacement of the JW-21MN	13-1
Chapter 14: Support Tools	14-1 to 2
Chapter 15: Specifications	15-1 to 3
15-1 General specifications	15-1
15-2 Communication specifications	15-1
15-3 Data link specifications	15-2
15-4 Computer link specifications	15-3
Chapter 16: Appendix	16-1 to 16
16-1 Maintenance and check	16-1
16-2 Recovery method at communication errors	16-2
16-3 Table of parameter memory	16-8
16-4 Special functions unique to the JW-21MN	16-13

Chapter 1: Features and Functions

JW-21MN is a ME-NET module for JW20/JW20H/JW30H. Using this module, you can construct an ME-NET combining various FA equipment such as personal computer and robot. Using this module, you can easily transmit and receive ON/OFF signals and data with devices that have a network module which is compatible with the ME-NET specifications. [When you want to install a JW-21MN in the JW30H, make sure to select one that is compatible with the JW30H. (See precautions inside the front page of this manual.)]

(1) Data link function

- Send and receive an ON/OFF signal (relay link) and data (register link) between modules on the ME-NET.

Linkage method	Number of linkage points
Relay link	2048 (256 bytes) in total
Register link	2048 bytes in total

* The amount of data that can be transmitted by one station is a maximum of 1024 bytes, including both relay link and register link.

- In order to use memory effectively, the JW-21MN has a memory save function. When this function is enabled, it only needs to receive the specifically required data.

(2) Computer link function

- Triggered on commands (instructions) from a host computer which has a network module compatible with the ME-NET specifications, the JW-21MN starts reading and writing the memory in the JW20/JW20H/JW30H.
- After an instruction is received from the host computer, the JW-21MN returns a response. Therefore, the host computer is required to create an application program. For detailed description of how to transmit instructions and receive responses, see the instruction manual for the host computer.

(3) This module is available communication up to 64 stations. By using a cable, it can be extended up to 1 km.

Reference

ME-NET is a communication network to link different brands of devices and equipment with different models of facility control equipment. It has been developed under the support of Toyota Motor Co., Ltd.

Chapter 2: Safety Precautions

2-1 Installation

- Do not install or store the JW-21MN in the following conditions.
 - Direct sunlight
 - Ambient temperature exceeding the range of 0 to 55 °C (Storage temperature : -20 to 70 °C)
 - The relative humidity exceeding the range of 35 to 90%.
 - Sudden temperature changes which may cause condensation.
 - Corrosive or inflammable gas
 - Vibration or hard jolts
- Prior to installing or detaching the JW-21MN, make sure to turn OFF the power supply to the JW20/JW30H (main PC of the system).
- All screws must be tightened firmly.

2-2 Wiring

- Make sure to use only the recommended types (see page 6-1) for cables, connectors, and crimping tools. Cable and connector installation and changes must be performed only by specialists approved by the ME-NET bureau.
- When using connectors for branch or joint lines, provide jackets to protect connectors. (When a connector touches with an external enclosure or the like, a communication error may occur.)

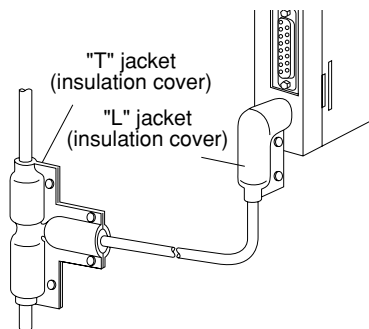

- Do not connect the ground terminal of the power supply module together with other equipment's ground lines. Make sure to provide class-3 grounding. When the JW-21MN is used without connecting a class-3 grounding, malfunctions by noise may occur.
- Communication cables should be arranged as far from any high voltage lines and strong power lines as possible. Do not lay the communication cable parallel or proximate to these lines.

- Communication cables should be laid from the master station to the slave station one by one. Multiple wiring from one point or wiring without terminators may cause communication errors.

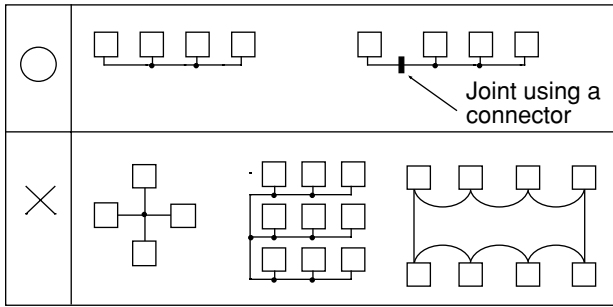

- Arrange total cable length within 1 km.
- Arrange branch cable line from a trunk within 400 mm.
- Prior to any electric welding around the JW-21MN, take out the coaxial cable from the JW-21MN. While the coaxial cable is connected to the JW-21MN, any electric welding nearby the JW-21MN will cause the welding current to enter the JW-21MN and may damage part of its circuit pattern.

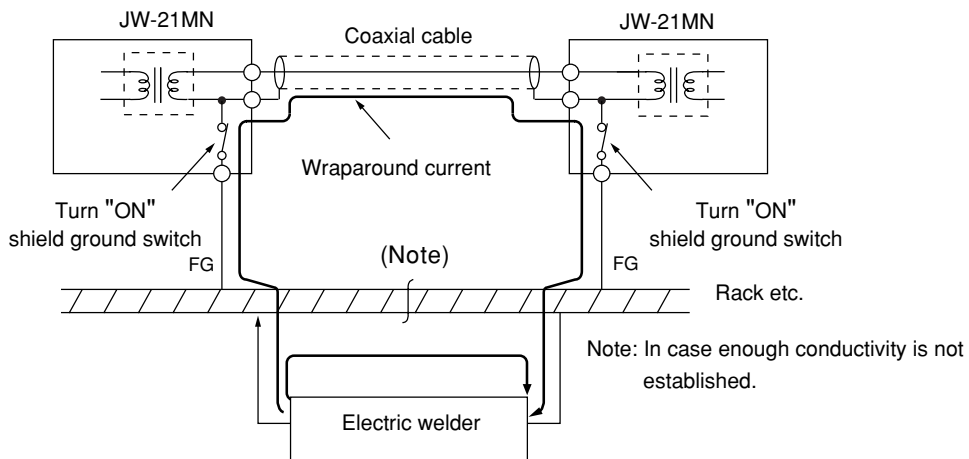

2-3 Treatment

- For ventilation, holes are provided in the cabinet to prevent a temperature rise. Do not block the ventilation holes. Good ventilation is necessary.
- Never allow a liquid such as water and chemical solution and a metallic object like a copper wire inside the JW-21MN to avoid a possible hazard. Otherwise, it may be a cause of machine trouble.
- When a trouble or abnormal condition such as overheat, fume, or smoke is met, stop the operation immediately, and call your dealer or our service department.

2-4 Static electricity

In extremely dry circumstances, the human body may have excessive static current. This excessive static current may damage parts in the JW-21MN's PC board. Therefore, prior to accessing the JW-21MN, touch your hand to a grounded piece of metal to discharge the static current in your body.

2-5 Maintenance

Use a clean, dry cloth when cleaning the JW-21MN. Do not use volatile chemicals such as thinner or alcohol as it may result in deformation and color fading.

2-6 Allocation of relay number

JW20/JW20H/JW30H which installs JW-21MN are laid out 16 points to the JW-21MN as a relay number. These 16 points are dummy area which is not used in JW-21MN.

Chapter 3: System Configuration

- An example of system configuration using the JW-21MN as a master station

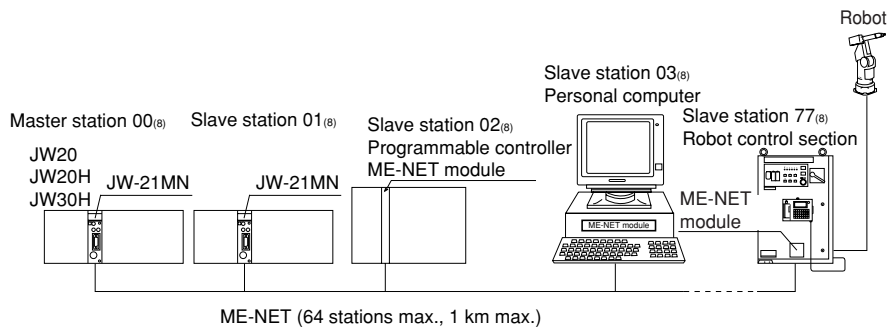

- An example of system configuration using some other module as a master station

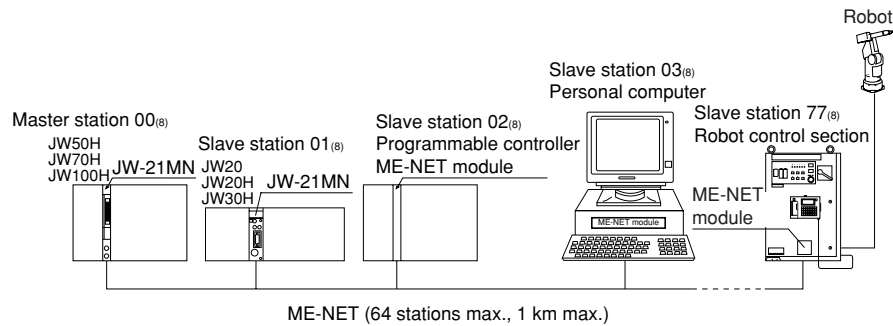

Chapter 4: Name and Function of Each Part

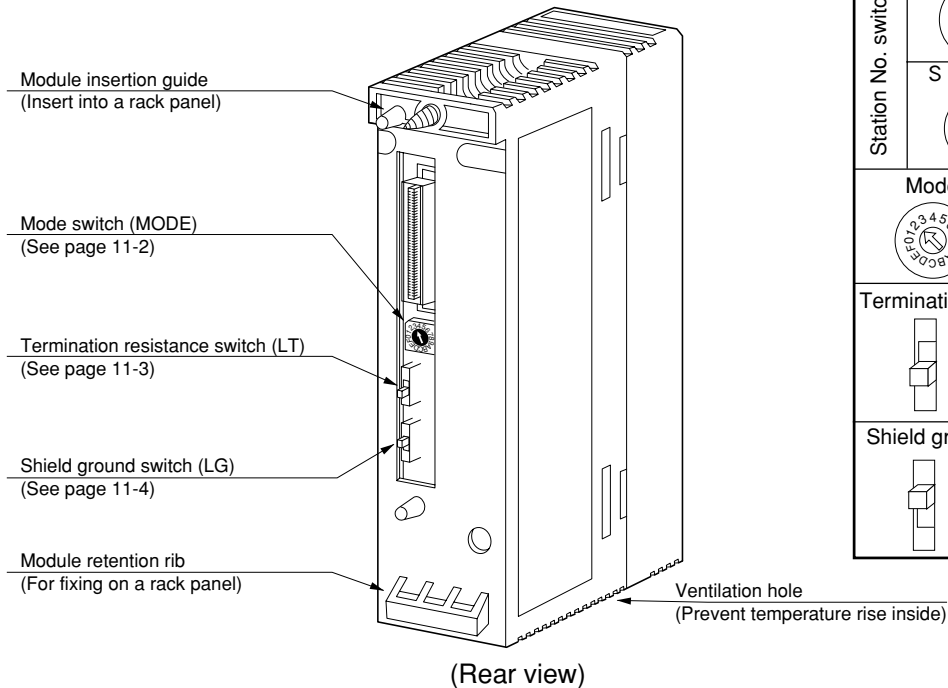
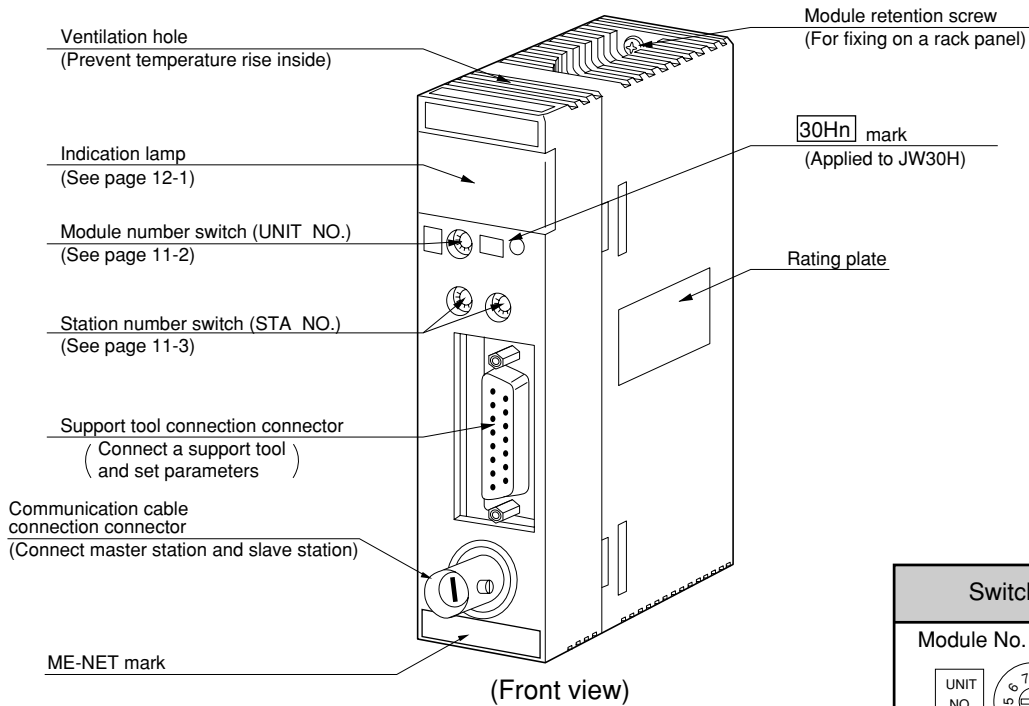

Switch		Factory setting
Module No. switch UNIT NO.		0
Station No. switch	STA NO. ×10	0
	STA NO. ×1	0
Mode switch MODE		2
Termination resistance switch ON OFF LT		OFF
Shield ground switch ON OFF LG		ON

Chapter 5: Installation

Installation procedure

① Turn "OFF" the power supply to the JW20/JW20H/JW30H.

② Set the mode switch, the termination resistance switch, and the shield ground switch on the rear side of the JW-21MN.
(See page 11-2 to 11-4 for settings)

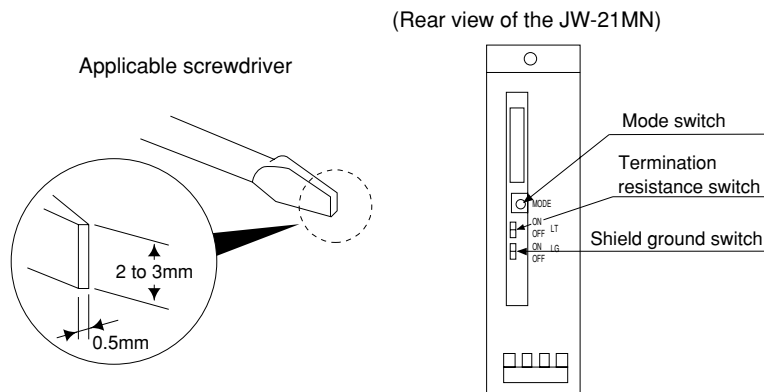

③ Hang the module retention rib of the JW-21MN on the retention rib insertion hole of the JW20/JW20H/JW30H's basic rack panel, and press in the JW-21MN. Then tighten the module retention screws at the top of the JW-21MN module using a Phillips screwdriver.

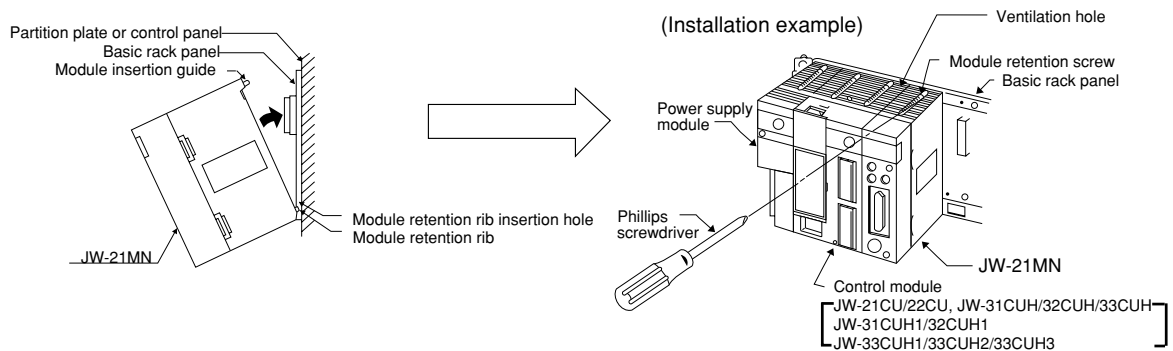





Remarks

- The JW-21MN cannot be installed on the expansion rack panel.
- Number of installations of the JW-21MN on the same JW20/JW20H/JW30H basic rack panel should be within 7 in total including other option module (including JW-21MN). Installation of more than seven modules of the JW-21MN will not allow the JW20/JW20H/JW30H to function.
- Make sure to tighten the module retention screws securely. Looseness of the screws may cause malfunctions.

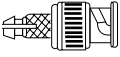
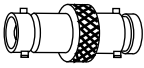
Chapter 6: Processing of Cables

Make sure to use the qualified products shown below for cables and connectors. Cable and connector installation and changes must be performed only by specialists approved by the ME-NET bureau.

Name		Model	Maker
Cable	High frequency coaxial cable	ME-5C-2V	Mitsubishi Cable Industries,. Ltd. Fujikura Cable,. Ltd. Furukawa Denko Corporation Chugoku Cable,. Ltd. Shinagawa Cable,. Ltd.
Crimping tools		ME-42H Dice: 67-42H	Toko Denshi Corporation
Stripper for high frequency coaxial cable		CST-TM (The system consists of the main body, a blade cassette, and a blade setting gauge)	Nihon Weidmüller Co., Ltd.
Jacket	"L" jacket	SB-2878	Shinagawa Shoko Co., Ltd.
	"T" jacket	SB-2879	
Insulation tape	Self-adhesive tape	NO.11	Nitto Denko Corporation
Connectors	Connector 	ME-GP-01	Toko Denshi Corporation DDK Ltd.
	Straight 	ME-JJ-01	
	Elbow 	ME-LA-01	
	T's 	ME-TA-01	
	Termination 	ME-75	

6-1 Processing cable end

① Applicable cable

High frequency coaxial cable: ME-5C-2V

② Required tools

Stripper for high frequency coaxial cable: CST-TM

③ Processing procedure

<Basic operation>

Move the cam wheel of the stripper (amber colored ring) back and forth and the cable holder moves back and forth accordingly. Confirm this movement of the stripper first.

To hold the stripper, put your forefinger through the hole and move the cam while pushing back and forth with your thumb.

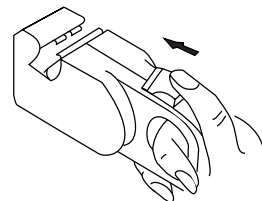
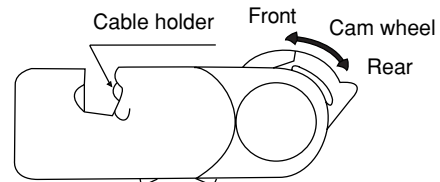

<Pressure setting>

Set the operation range of the cable holder by moving the slider at the bottom of the body. Move to the left to increase pressure.

In this example, set the slider to the cam wheel side's end (right side) to set the pressure to low.

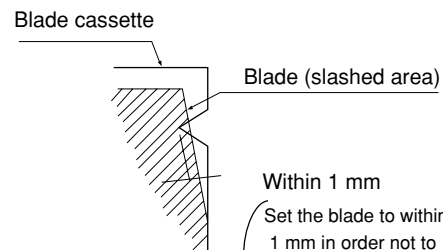

<Adjustment of blade cutting depth>

Adjust the cutting depth of the blade by turning the two screws at both ends of the screw holder. Set the blade position to within 1 mm from the cutting surface of the blade cassette prior to adjusting the cutting depth. For the cutting depth adjustment, use the "blade setting gauge" supplied as an accessory and match the blade position with the caved position of the gauge. Then move the cam wheel forward and secure firmly. Turn right lightly both adjustment screws at either end of the screw holder for adjustment. (Be careful not to break the blade setting gauge as it is made of aluminum.)

(Fine adjustment is required to get the optimum cutting depth.)

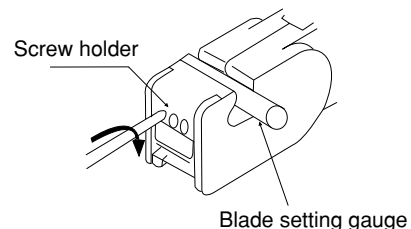
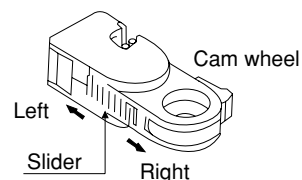

To the next page

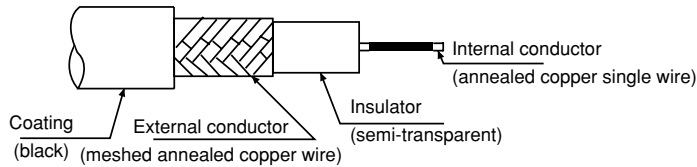

From the previous page

<Cutting of coating, external conductor, and insulator>

Put a coaxial cable while remaining approximately 10 mm into the cable stripper and securely tighten the cable with the middle finger, ring finger, and little finger of your left hand in order to hold stable during turning the stripper. Put your right hand forefinger into the cam wheel and execute the procedure in order from step 1 below.

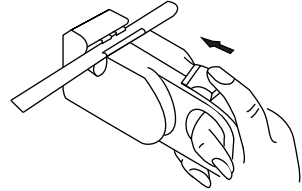

- Step 1** Press the cam wheel forward 3 times and turn the stripper in the direction of arrow 2 to 3 times.
- Step 2** Press the cam wheel forward 1 time and then turn the stripper in the direction of arrow a further 2 to 3 times.
- Step 3** Press the cam wheel forward 1 more time and turn the stripper in the direction of the arrow another 2 to 3 times.

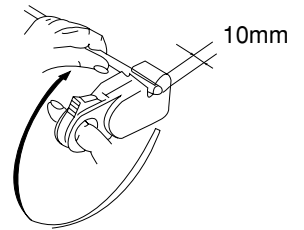

<Removal of coating, external conductor, and insulator>

While holding the coaxial cable with your left hand, grip the cable stripper so that it keeps a right angle against the coaxial cable, and press out the cable stripper with your left hand's thumb.

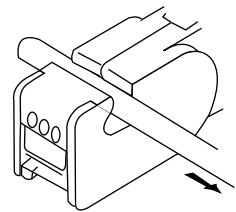

When the adjustment of the blade is not required

If the stripper cannot be removed smoothly, adjustment of the blade is not appropriate. In this case slide the cam wheel backward and remove the coaxial cable. Then adjust the blade.

<Fine adjustment of blade cutting depth>

When the cutting depth is too shallow or too deep, and damages the external conductor or the internal conductor, turn the screws on the screw holder and adjust the blade depth a little.

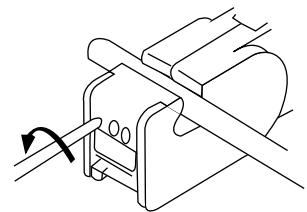

To the next page

From the previous page

<Display of blade setting>

We recommend that in order to keep the adjusted position of the adjustment screws, after completion of adjustment for the coaxial cable and the screw holder, write the screw position etc. on a sticker and adhere it to the adjustment screws.

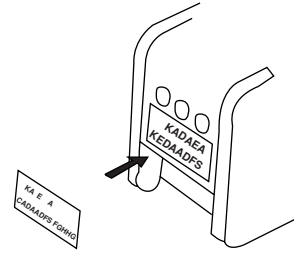

<Replacement of blades>

Hold up the upper section of the screw holder with a minus driver, and open the screw holder. Remove the blade cassette and reinsert by turning the current blade back side front or insert a new blade cassette from its top.

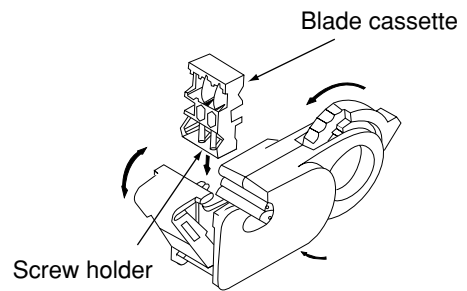

<Processing of cable end>

Cut the internal conductor of the coaxial cable, which is already cut by the stripper, using a nipper etc. to the optimum dimension of 4 mm.

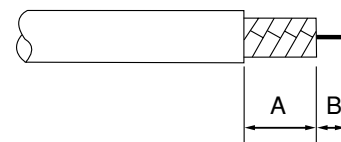
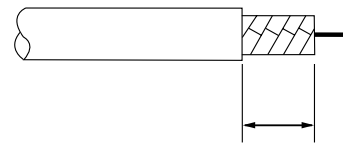

A: $10 \pm 0.5\text{mm}$
B: $4 \pm 0.5\text{mm}$

6-2 Connector crimping procedure

① Required tools: Hand-held crimping tool

Model	: ME-42H
Dice No.	: 67-42H
Crimping width	: 10 mm

Connector parts

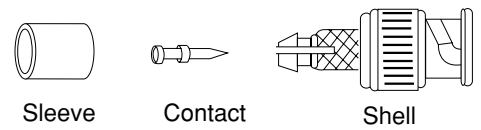

② Connector: ME-GP-01

③ Processing procedure

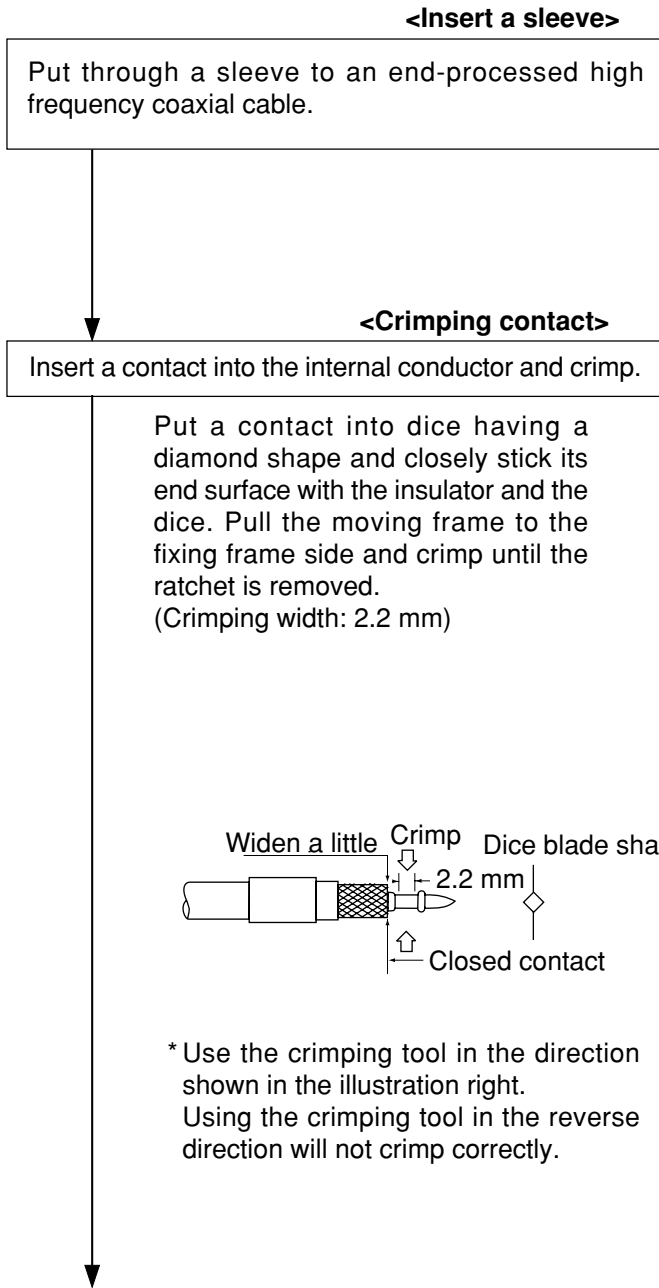

To the next page

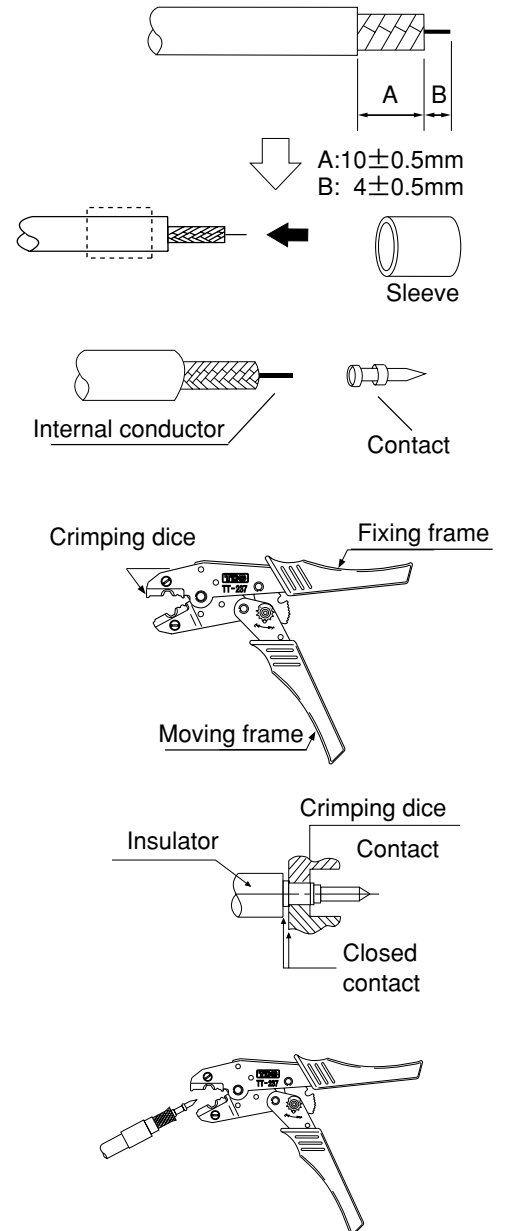

From the previous page

<Fixing the connector>

Slightly widen the external conductor of the coaxial cable, which is crimped to a contact on the internal conductor, in order to smoothly enter the shell inside the external conductor. Press in the external conductor end of the coaxial cable to just before the crimping part of the shell and put the sleeve into the crimping section. Then press in the coaxial cable until a "click" sound can be heard. Confirm that the contact end point touches your finger cushion.

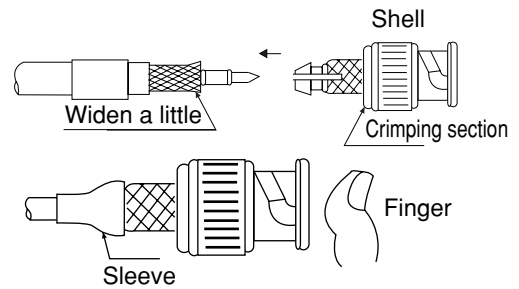

<Crimping external conductor>

Crimp the external conductor.

Insert thoroughly the sleeve into the crimping section of the shell and crimp. Put the sleeve in the hexagonal dice and closely stick the shell to the crimping dice. Pull the moving frame to the fixing frame side while pressing the coaxial cable and shell from both sides, and crimp until the ratchet is removed. (Crimping width: 10 mm)

* Use the crimping tool in the direction shown in the illustration right. Using the crimping tool in the reverse direction will not crimp correctly.

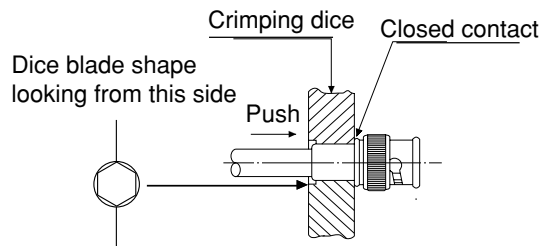
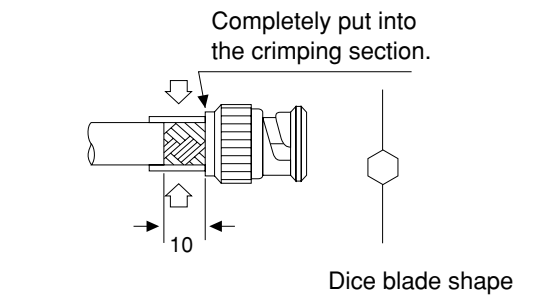

<Insulation test>

Insulation test of shell and contact

Using a tester, check the conductivity between the internal conductor and the external conductor in the connector. When the indication of the tester shows \times ohms, the insulation is appropriate.

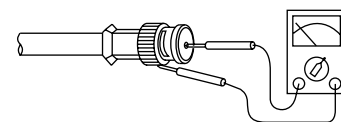
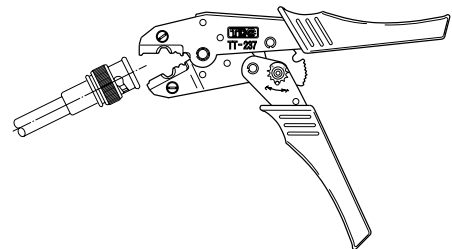

<Conductivity test>

Conductivity test

After short-circuiting the one end of the connector crimped to the coaxial cable, check that conductivity is attained.

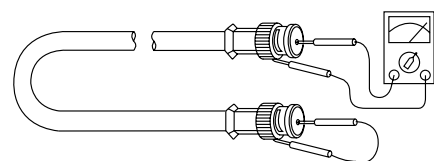

Chapter 7: Wiring Method

7-1 Cable trunk and branch lines

- ① On the illustration of the cable wiring below, a bold line means a trunk and the thin lines branched from the trunk with a "T" shape are called branch lines.

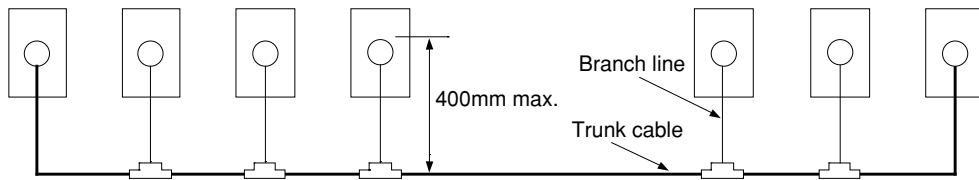

- ② The length of branch lines branched from the trunk should be within 400 mm.

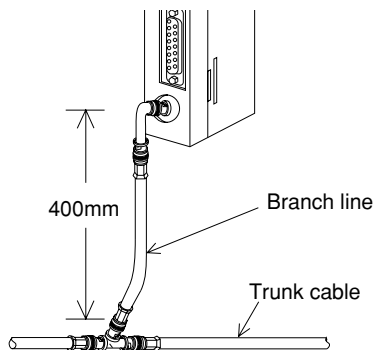

- ③ Total cable length should be within 1 km.

7-2 Relaying of trunk cables

- ① To relay trunk cables, use the straight joint (ME-JJ-01).

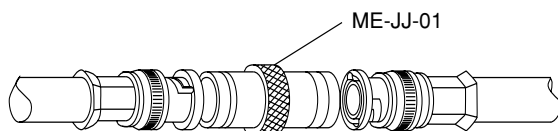

- ② Relaying of trunk cables should be limited to indispensable cases only. Inadvertent relaying of trunk cables may cause a communication fault such as a weakened signal level due to contact resistance in the junction connector (straight).

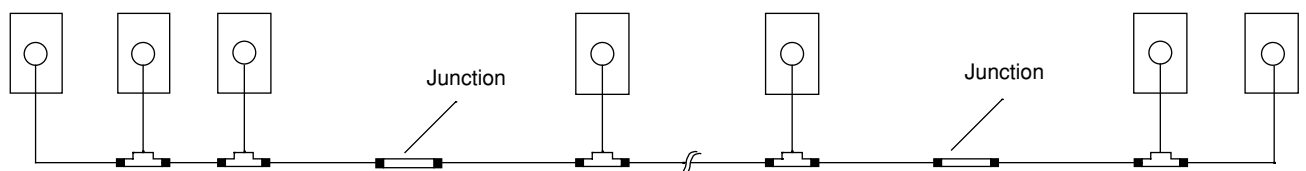

7-3 Cable wiring procedure in control panel

(1) Fixing of the cable

In order not to put any force on the cable and the JW-21MN, fasten the cable to an line nearby input of a control panel or a "T" branch point to the JW-21MN using saddles etc.

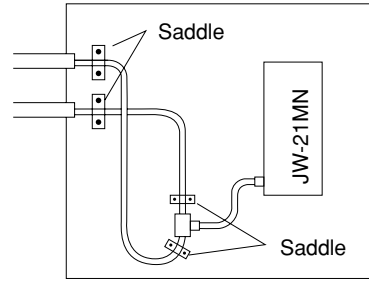

(2) Extra length of cable

Provide an extra length of the cable of 2 to 3 m inside a control panel for easier processing of the cable end and easier wiring when changing module positions.

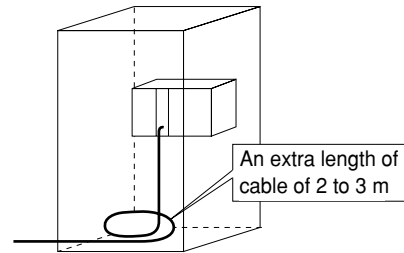

(3) Connection to the JW-21MN

The connector to the JW-21MN should be turned right to secure locking, not merely inserted.

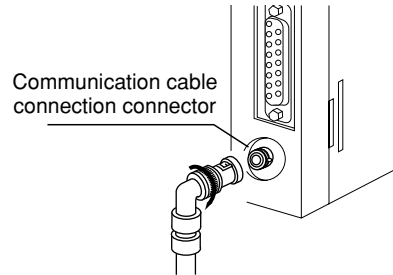

(4) Insulation cover

When the connector touches with a high voltage section or external enclosures, communication errors may occur. Make sure to install an insulation cover.

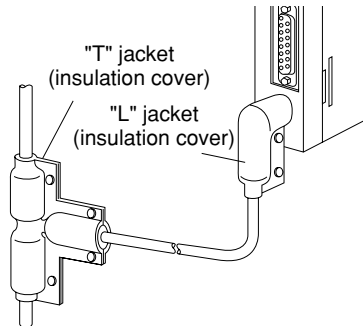

(5) Grounding of power supply module (JW-22PU/31PU)

Make sure to use a class-3 grounding to connect the GND terminal of the power supply module.
 - If the power supply module is not grounded, the JW-21MN cannot conduct with the ground after turning "ON" the shield ground switch.

When using a JW-31PU AC power supply module

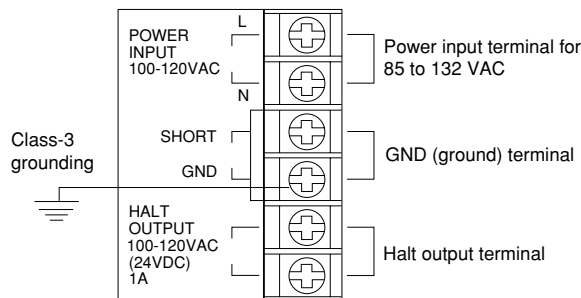

(6) Bending radius of the signal cable should be less than 45 mm (outside).

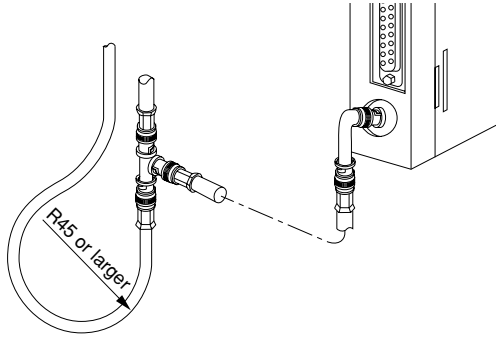

- Specification of the cable manufacturer is that bending radius should be 6x of the cable finish outside diameter (approx. 7.5 mm).

(7) When you install more than one module of the JW-21MN into one programmable controller, we recommend to put identification tag on each cable.

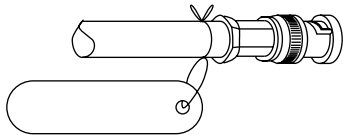

(8) Before transport or store the JW-21MN, put a protection cap on the connector of the JW-21MN.

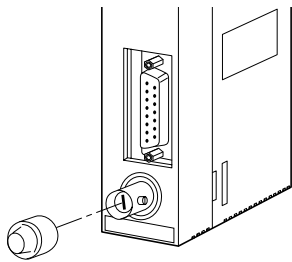

7-4 Waterproof and insulation processing of connectors

In order to prevent water intrusion into the "T" branch connectors and the straight connectors, we recommend to wind a self-adhesive tape and provide waterproof processing for them. For insulation purposes, cover these connectors with jackets.

(1) "T" branch connector

To wind a self-adhesive tape, cut the tape at about 10 cm each and start winding from position ①. Start winding cut tapes from ② and ③ as well.

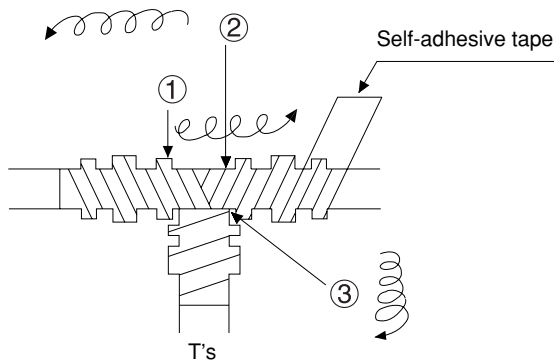

(2) Straight connector

To wind the self-adhesive tape, cut the tape at about 15 cm each and start winding from position ①.

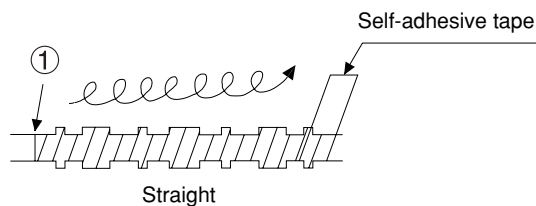

Remarks

Prior to adhering the tape, clean the surface of the connectors and stick the adhesive side of the tape on the connector surface. Wind to lightly spread on the connector surface, and overlap with the next wrap to half of the tape width. Wind the tape for each wrap evenly so that the connector metal portion is completely covered with the tape. Be careful not to excessively stretch the tape.

7-5 Wiring of cables at outside control panels

- ① Do not bundle the coaxial cable (the trunk and branch lines) together with power cables, and separate from power cables at least by 100 mm. Do not put the coaxial cable into a power line wired duct. The best way is to put the communication line in an independent duct.
- ② Be careful that the coaxial cable does not receive any load by laying under a heavy weight such as other cables.
When other cables run in the same duct as the coaxial cable, run the coaxial cable on the top position.
- ③ Do not run the coaxial cable outdoors as it may cause damage to the JW-21MN due to inductive lightning or atmospheric charge during lightning.

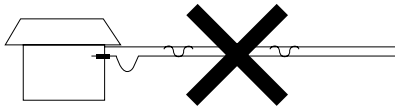

7-6 Check after wiring

Check the items below after completion of wiring.

	Check contents
1	The recommended connector types are used.
2	The connectors are securely locked.
3	The connectors are insulated by "T" jacket or "L" jacket.
4	The recommended coaxial cable type is used.
5	Curved radius of the coaxial cables are more than 45 mm.
6	No heavy load is on the coaxial cables.
7	The coaxial cable is not bundled with a power line cable. (Away from power line cables more than 100mm.)
8	Length of branch lines is shorter than 400mm.
9	Total length of the cable is less than 1km.
10	Settings of the termination resistance switch and the shield ground switch are as per the drawings.

7-7 Wiring method for adding a communication station

(1) Branching method

When branching a line for an additional station, be sure to branch from the trunk using a T connector.

Never branch from a branch line.

(2) Station number of the additional station

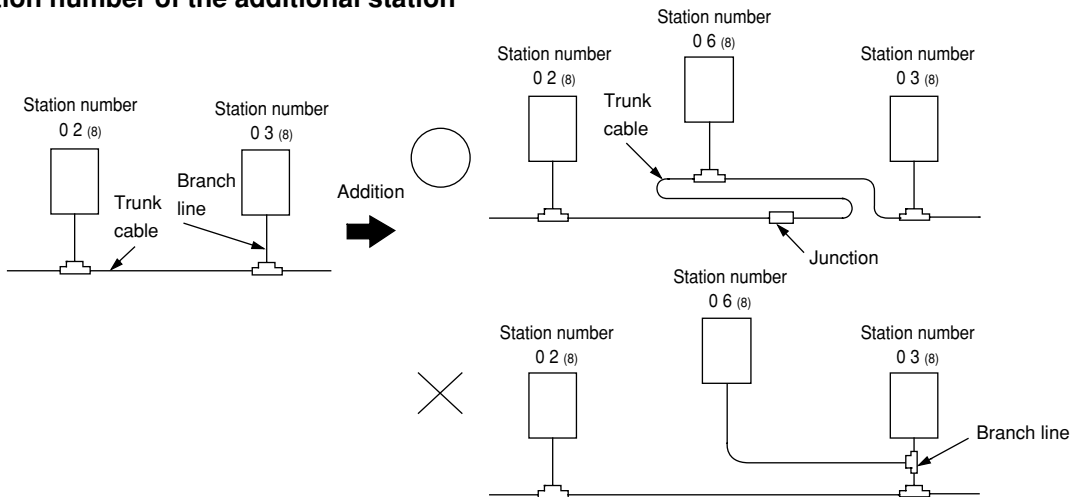

Station number of the newly added station should be next largest number from the current largest numbered station. Each station should not be required to be arranged in order of each station's number.

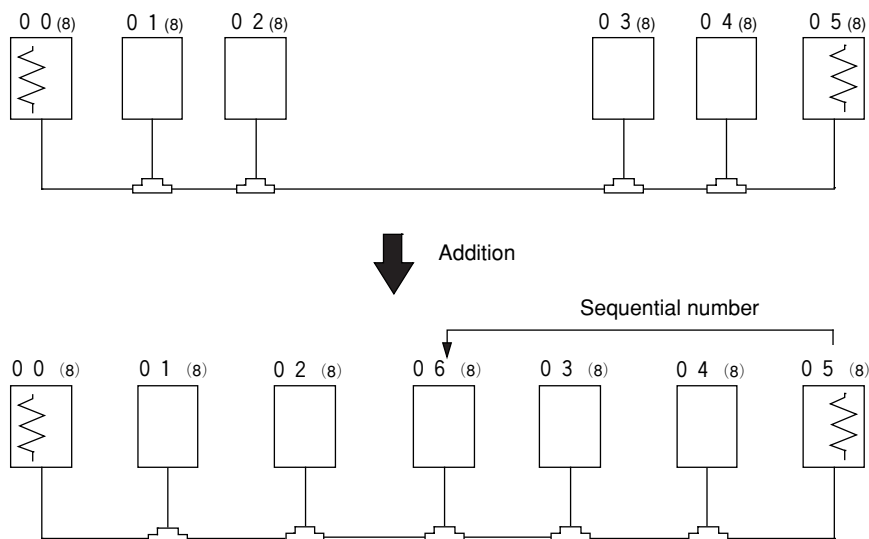

 means the termination resistance switch being turned "ON."

(3) Notes

When adding a communication station, follow the items below.

No.	Item	Reason
1	Branch from the trunk cable.	Another branch line from a branch line may not give appropriate communication by reflection wave.
2	Don't use the same station number twice.	The use of the same station number twice may cause communication errors.
3	Check the termination resistance switch.	When the newly added station becomes a termination of the circuit, change the setting of the LT switch.
4	Provide extra length for the expansion cable.	Have enough cable length in order to provide easy wiring.
5	Do not exceed the 1 km limit for total length of the cable.	Longer wiring may cause communication error by signal attenuation.
6	Change the layout drawing for installation.	Maintain the added work data for future maintenance use.
7	Do not overlap with any PC's communication area.	When the communication area or the flag area of the added station overlaps with other addresses in use, communication errors may occur.
8	Set the parameter memory of the master station and that of the newly added station.	Without setting the parameter memory of the master station and that of the slave station, the added station cannot communicate.

Chapter 8: Memory Address on the ME-NET

The ME-NET employs a system for addressing individual memory banks in all of the connected equipment by allocating address throughout the ME-NET. Therefore, the top address in any link area which will contain in the data link parameters and memory addresses used for computer link instructions must be a valid memory address in the ME-NET.

The relationship between memory addresses in Sharp PCs (JW20/JW20H/JW30H) and those on the ME-NET are shown below.

8-1 Memory address for data links

The memory addresses⁽⁸⁾ on the ME-NET correspond to the file addresses⁽⁸⁾ in a Sharp PC (JW20/JW20H/JW30H).

(1) Memory address map (against JW20/JW20H)

	JW20/20H address			ME-NET address	
	Byte address ⁽⁸⁾ 1 address = 1 point	Byte address ⁽⁸⁾ 1 address = 8 points	File address ⁽⁸⁾ 1 address = 8 points	Byte unit: Hexadecimal	Byte unit: Octal
I/O relay	00000 to 03777	⊃ 0000 to ⊃ 0377	000000 to 000377	0000 to 00FF	000000 to 000377
Auxiliary relay	04000 to 06777	⊃ 0400 to ⊃ 0677	000400 to 000677	0100 to 016F	000400 to 000677
Latched relay	07000 to 07777	⊃ 0700 to ⊃ 0777	000700 to 000777	0170 to 01FF	000700 to 000777
General-purpose relay	10000 to 15777	⊃ 1000 to ⊃ 1577	001000 to 001577	0200 to 0037F	001000 to 001577
TMR/CNT contact point	T-C000 to T-C777	————	001600 to 001777	0380 to 03FF	001600 to 001777
TMR/CNT current value	————	b0000 to b1777	002000 to 003777	0400 to 07FF	002000 to 003777
Register	————	09000 to 09777	004000 to 004777	0800 to 09FF	004000 to 004777
		19000 to 19777	005000 to 005777	0A00 to 0BFF	005000 to 005777
		29000 to 29777	006000 to 006777	0C00 to 0DFF	006000 to 006777
		39000 to 39777	007000 to 007777	0E00 to 0FFF	007000 to 007777
		49000 to 49777	010000 to 010777	1000 to 11FF	010000 to 010777
		59000 to 59777	011000 to 011777	1200 to 13FF	011000 to 011777
		69000 to 69777	012000 to 012777	1400 to 15FF	012000 to 012777
		79000 to 79777	013000 to 013777	1600 to 17FF	013000 to 013777
		89000 to 89777	014000 to 014777	1800 to 19FF	014000 to 014777
99000 to 99777	015000 to 015777	1A00 to 1BFF	015000 to 015777		
Self diagnosis result storage register	————	E0000 to E1777	016000 to 017777	1C00 to 1FFF	016000 to 017777

- For details about the address range of relay link, register link, and the JW-21MN flag, see page 11-11 in this manual.
- The addresses that can be used vary with PC model in which the JW-21MN is installed and with the memory capacity of the PC. For details, see the instruction manual for a particular PC.

(2) Memory address map (against JW30H)

	JW30H address			ME-NET address		
	Byte address ⁽⁸⁾ 1 address = 1 point	Byte address ⁽⁸⁾ 1 address = 8 points	File address ⁽⁸⁾ 1 address = 8 point	Byte unit: Hexadecimal	Byte unit: Octal	
Relay	00000 to 15777	⊃ 0000 to ⊃ 1577	000000 to 001577	0000 to 037F	000000 to 001577	
TRM/CNT contact point	T-C0000 to T-C0777	————	001600 to 001777	0380 to 03FF	001600 to 001777	
TMR/CNT current value	————	b0000 to b1777	002000 to 003777	0400 to 07FF	002000 to 003777	
Register	————	09000 to 09777	004000 to 004777	0800 to 09FF	004000 to 004777	
		19000 to 19777	005000 to 005777	0A00 to 0BFF	005000 to 005777	
		29000 to 29777	006000 to 006777	0C00 to 0DFF	006000 to 006777	
		39000 to 39777	007000 to 007777	0E00 to 0FFF	007000 to 007777	
		49000 to 49777	010000 to 010777	1000 to 11FF	010000 to 010777	
		59000 to 59777	011000 to 011777	1200 to 13FF	011000 to 011777	
		69000 to 69777	012000 to 012777	1400 to 15FF	012000 to 012777	
		79000 to 79777	013000 to 013777	1600 to 17FF	013000 to 013777	
		89000 to 89777	014000 to 014777	1800 to 19FF	014000 to 014777	
		99000 to 99777	015000 to 015777	1A00 to 1BFF	015000 to 015777	
E0000 to E5777	016000 to 023777	1C00 to 27FF	016000 to 023777			
Register (storable error history)	————	E6000 to E7777	024000 to 025777	2800 to 2BFF	024000 to 025777	
TMR/CNT current value	————	b2000 to b3777	026000 to 027777	2C00 to 2FFF	026000 to 027777	
Expansion relay	20000 to 75777	⊃ 2000 to ⊃ 7577	030000 to 035577	3000 to 3B7F	030000 to 035577	
TMR/CNT contact point	T-C1000 to T-C1777	⊃ 7600 to ⊃ 7777	035600 to 035777	3B80 to 3BFF	035600 to 035777	
File register	File 1	————	————	000000 to 037777	1-000 to 3FFF	000000 to 037777
	File 2	————	————	000000 to 177777	2-000 to FFFF	000000 to 177777
	File 3	————	————	000000 to 177777	3-000 to FFFF	000000 to 177777
	File 10 _(H)	————	————	000000 to 177777	10-000 to FFFF	000000 to 177777
	File 10 _(H)	————	————	000000 to 177777	11-000 to 3FFFF	000000 to 177777
	:	————	————	:	:	:
	File 1F _(H)	————	————	000000 to 177777	1F-000 to FFFF	000000 to 177777
	File 20 _(H)	————	————	000000 to 177777	20-000 to FFFF	000000 to 177777
	File 21 _(H)	————	————	000000 to 177777	21-000 to FFFF	000000 to 177777
	:	————	————	:	:	:
	File 2C _(H)	————	————	000000 to 177777	2C-000 to FFFF	000000 to 177777

* ME-NET addresses for file 10 to 2C_(H) are out of the range the ME-NET specification. These are special addresses for the JW-21MN.

- As for address setting range of relay link, register link, and flag of the JW-21MN, see page 11-12 in this manual.
- Available addresses vary with PC model on which the JW-21MN is installed and its capacity. For details, see an instruction manual for each PC.

8-2 Memory addresses for computer links

- Data memory byte addresses in the computer link must be entered the same way a data link address is entered.
- The relay numbers and TMR/CNT numbers are the same for the ME-NET. However the TMR/CNT contact points correspond to the even addresses from 16000 to 17777⁽⁸⁾.
- Program addresses correspond to addresses of file (SEG)8.

For details about the detailed addresses to use on the host computer, see the instruction manual for the host computer.

(1) Memory address map (against JW20/JW20H)

	JW20/20H address ⁽⁸⁾	ME-NET address ⁽⁸⁾	Capacity	Remarks	
I/O relay	00000 to 03777	SEG0 00000.0 to 00377.7	2048 points	Bit address	
Auxiliary relay/JW20H	04000 to 06777	SEG0 00400.0 to 00677.7	1536 points		
Latched relay	07000 to 07777	SEG0 00700.0 to 00777.7	512 points		
General-purpose relay	10000 to 15777	SEG0 01000.0 to 01577.7	3072 points		
TMR/CNT contact point	T-C000 to T-C777	Even addresses of SEG0 01600.0 to 01777.7	512 points		
I/O relay	□ 0000 to □ 0377	SEG0 00000 to 00377	256 bytes	Byte address	
Auxiliary relay	□ 0400 to □ 0677	SEG0 00400 to 00677	192 bytes		
Latched relay	□ 0700 to □ 0777	SEG0 00700 to 00777	64 bytes		
General-purpose relay	□ 1000 to □ 1577	SEG0 01000 to 01577	384 bytes		
TMR/CNT current value	b0000 to b1777	SEG0 02000 to 03777	1024 bytes		
Register	09000 to 09777	SEG0 04000 to 04777	512 bytes		
	19000 to 19777	SEG0 05000 to 05777	512 bytes		
	29000 to 29777	SEG0 06000 to 06777	512 bytes		
	39000 to 39777	SEG0 07000 to 07777	512 bytes		
	49000 to 49777	SEG0 10000 to 10777	512 bytes		
	59000 to 59777	SEG0 11000 to 11777	512 bytes		
	69000 to 69777	SEG0 12000 to 12777	512 bytes		
	79000 to 79777	SEG0 13000 to 13777	512 bytes		
	89000 to 89777	SEG0 14000 to 14777	512 bytes		
	99000 to 99777	SEG0 15000 to 15777	512 bytes		
E0000 to E1777	SEG0 16000 to 17777	1024 bytes			
TMR/CNT number	000 to 777	0000 to 0777	512 pieces	----	
Program address	JW-21CU/22CU	000000 to 006777	SEG8 000000 to 006777	3584 step	----
	JW-22CU	000000 to 016777	SEG8 000000 to 016777	7680 step	----

- Relay addresses 07300 to 07377⁽⁸⁾ and 15760 to 15767⁽⁸⁾ in the JW20/JW20H are special address ranges for relays.
- Available addresses vary with PC model on which the JW-21MN is installed and its capacity. For details, see an instruction manual for each PC.

(2) Memory address map (against JW30H)

	JW30H address ⁽⁸⁾	ME-NET address ⁽⁸⁾	Capacity	Remarks	
Relay	00000 to 15777	SEG0 00000.0 to 1577.7	7168 points	Bit address	
Extension relay	20000 to 75777	SEG0 30000.0 to 35577.7	23552 points		
TMR/CNT contact points	T-C0000 to T-C0777	SEG0 01600.0 to 01777.7	512 points		
	T-C1000 to T-C1777	SEG0 35600.0 to 35777.7	512 points		
Relay	⊔ 0000 to ⊔ 1577	SEG0 00000 to 01577	896 bytes	Byte address	
Extension relay	⊔ 2000 to ⊔ 7577	SEG0 30000 to 35577	2944 bytes		
TMR/CNT current value	b2000 to b3777	SEG0 26000 to 27777	1024 bytes		
Register	09000 to 09777	SEG0 04000 to 04777	512 bytes		
	19000 to 19777	SEG0 05000 to 05777	512 bytes		
	29000 to 29777	SEG0 06000 to 06777	512 bytes		
	39000 to 39777	SEG0 07000 to 07777	512 bytes		
	49000 to 49777	SEG0 10000 to 10777	512 bytes		
	59000 to 59777	SEG0 11000 to 11777	512 bytes		
	69000 to 69777	SEG0 12000 to 12777	512 bytes		
	79000 to 79777	SEG0 13000 to 13777	512 bytes		
	89000 to 89777	SEG0 14000 to 14777	512 bytes		
99000 to 99777	SEG0 15000 to 15777	512 bytes			
E0000 to E5777	SEG0 16000 to 23777	3072 bytes			
Register (storable error history)	E6000 to E7777	SEG0 24000 to 25777	1024 bytes		
TMR/CNT number	0000 to 1777	0000 to 1777	1024 pcs.	-----	
File register *	File 1	000000 to 037777	SEG1 000000 to 037777	16 K bytes	Byte address
	File 2	000000 to 177777	SEG2 000000 to 177777	64 K bytes	
	File 3	000000 to 177777	SEG3 000000 to 177777	64 K bytes	
	File 10 ^(H)	000000 to 177777	SEG10 000000 to 177777	64 K bytes	
	File 10 ^(H)	000000 to 177777	SEG11 000000 to 177777	64 K bytes	
	:	:	:	:	
	File 1F ^(H)	000000 to 177777	SEG1F 000000 to 177777	64 K bytes	
	File 20 ^(H)	000000 to 177777	SEG20 000000 to 177777	64 K bytes	
	File 21 ^(H)	000000 to 177777	SEG21 000000 to 177777	64 K bytes	
	:	:	:	:	
File 2C ^(H)	000000 to 177777	SEG2C 000000 to 177777	64 K bytes		
Program address	JW-31CUH/H1	000000 to 016777	SEG8 000000 to 016777	7680 steps	-----
	JW-32CUH	000000 to 036777	SEG8 000000 to 036777	15872 steps	
	JW-32CUH1	000000 to 036777	SEG8 000000 to 036777	15872 steps	
		000000 to 076777	SEG8 000000 to 076777	32256 steps	
	JW-33CUH/H1	000000 to 076777	SEG8 000000 to 076777	32256 steps	
JW-33CUH2/H3	000000 to 076777, 100000 to 176777	SEG8 000000 to 076777, SEG9 000000 to 076777	64512 steps		

* ME-NET addresses (SEG10 to 2C) of file 10 to 2C^(H) are out of ranges of the ME-NET specification. These are special addresses for the JW-21MN.

- Available addresses vary with PC model on which the JW-21MN is installed and its capacity. For details, see an instruction manual for each PC.

Chapter 9: Description for Data Link Operation

The data link function is used to send and receive ON/OFF signals (relay link) and data (register link) between modules by assigning one module from PCs or FA devices as the master station and other units as slave stations in the satellite net system. Up to 64 sets of PCs and FA devices can be connected in the satellite net.

Each station sends data in its sending area cyclically and stores data received from other stations in its receiving area. For the JW-21MN to execute automatically these sending and receiving procedures, a special program for communications is required.

When the JW-21MN is assigned as a slave station, it has the standard function and save memory function for data link, but the data contents for receiving from other stations is different between these two functions. (When the JW-21MN is used as a master station, only the standard function is available.)
 [When all of a master station and slave stations are JW-21MN]

- Master station — Data link (Standard function) } Receiving data of all of the relay link area and
- Slave station — Data link (Standard function) } all of the register link area of all the stations.
- Data link (Save memory function) — In order to effectively use the memory, unify a partial data area or sending/receiving address (program) of slave stations.

For the standard function and the save memory function of the JW-21MN, see page 15-2.

9-1 Communication method

[1] Data link (Standard function)

Each station cyclically sends and receives ON/OFF signals and data of the relay link area and register link area set to a master station parameter.

(1) Relay link

Mainly used for sending and receiving ON/OFF information

[Example] In the case of sending 1-byte data from a master station and slave stations 01 and 02.

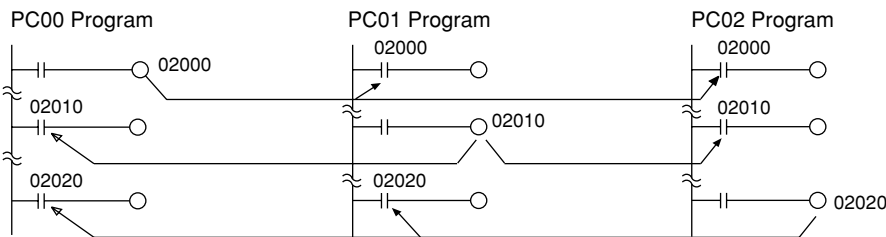
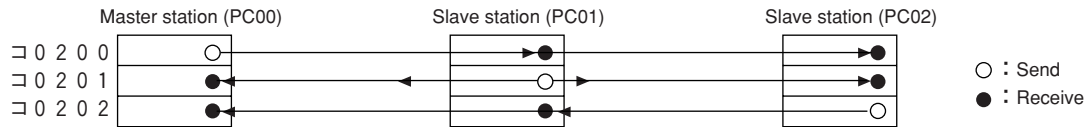

- The link relay of the receiving station must be programmed as input signal by the PC programming. Also, it may be used as source (S) side of application instruction.
- The sending and receiving data correspond in bits of one point unit.

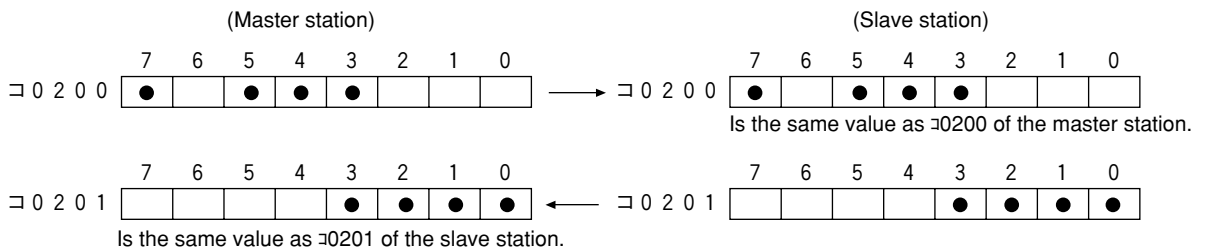

(2) Register link

Mainly used for sending and receiving numerical data.

[Example] In the case of sending 1 byte data from a master station and slave station 01 and 02.

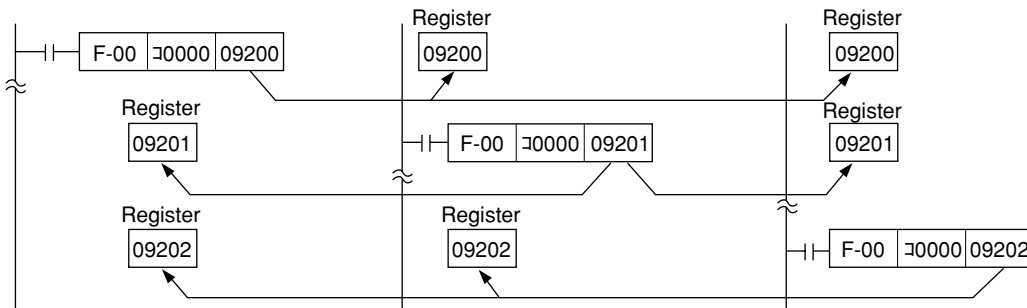
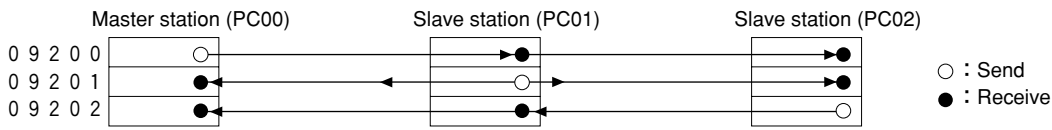

- The register link of the sending station may be used as D (Destination) side of the application instruction of the PC program.
- The register link of the receiving station may be used as S (Source) side of the application instruction of the PC program.

[2] Data link (Save memory function)

The save memory function is to provide a part of the data link area in the slave station data memory as a receiving area. A slave station can receive only the required area by relay link/register link so that the slave stations can save on use of the memory area.

As this function can unify the receiving area address and the sending area address of each slave station, the same program can be used for each slave station. Mixed allocation of the addresses with the data link (standard function) is also possible.

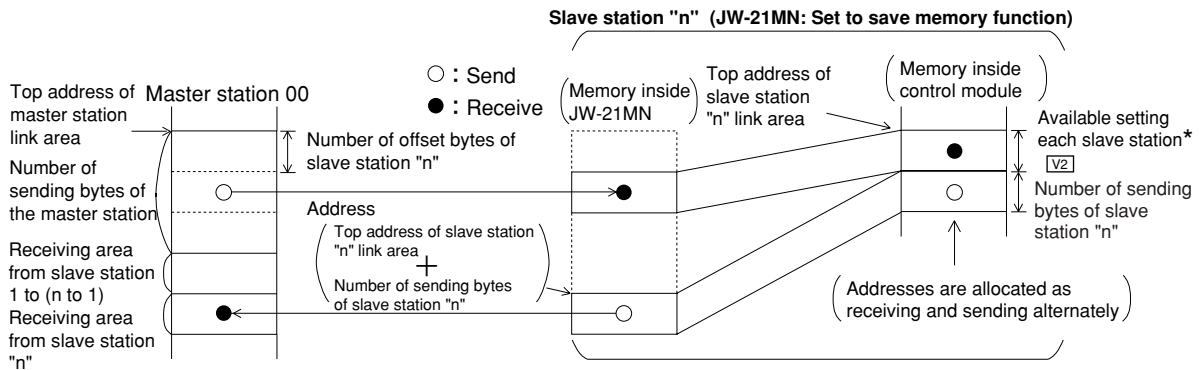

- Top address of receiving area in a slave station shall be set by the number of offset bytes from the link area's top. ($0 \leq \text{Number of offset bytes} \leq \text{total number of bytes of link area}$)

Setting item	Set location
Top address of master station link area	Master station's parameter
Number of sending bytes of the master station	
Number of offset bytes of slave station	
Number of sending bytes of the slave station	
Top address of slave station link area	Module No. switch of slave station
Number of receiving bytes of slave station $\boxed{V2}$ *	Slave station's parameter

* When JW-21MNs without $\boxed{30Hn}$ mark and $\boxed{30H}$ mark are used, these cannot set each slave station. Automatically allocated with the same number of the sending bytes of the slave station.

9-2 Required transmission time and communication delay time

[1] Required transmission time

This is the time required for the master station to complete communication with all stations, and is determined by the number of connected stations with and the number of data items to transmit.

$$\text{Transmission T operation cycle} = \frac{N + 136 \times P}{1250} + 2.5 \times P + \alpha + 16 \text{ (ms)}$$

N : Total number of link points (value to be calculated by relay link bytes and register link bytes 8 points).

P : Number of connected stations (master + slave)

136 : 136 bits are used for station address and error check data on the communication format.

1250 : Transmission rate: 1.25M bits per second

2.5 : Inter-station wait time plus processing time to move to next station (unit : ms)

α : Communication recovery operation time

• When an error occurs at any station, the master station periodically treats the error.

$$\alpha = 3.5 \times \text{number of error stations ms}$$

16 : Time to maintain token bus. It can enter at random intervals.

[Example] In the case of two connected stations and 8 bytes of link points,

$$\begin{aligned} \text{Transmission T operation cycle} &= \frac{8 \text{ bytes} \times 8 \text{ points} \times 2 \text{ stations} + 136 \times 2 \text{ stations}}{1250} \\ &+ 2.5 \times 2 \text{ stations} + 16 = 21.32 \text{ ms} \end{aligned}$$

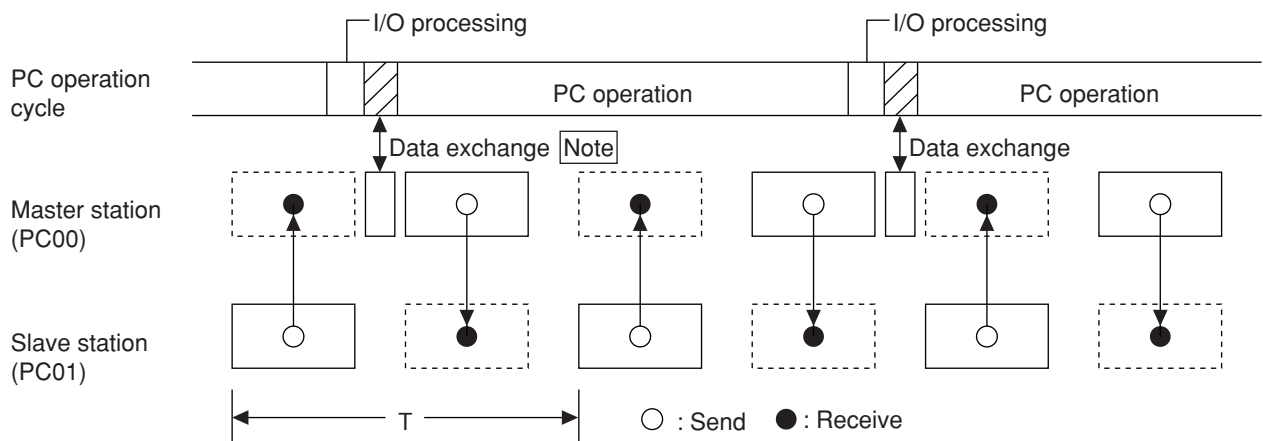

Note: Data exchange time between a PC and the JW-21MN can be obtained by the following formula:

When the control module is JW-31CUH1/32CUH1/33CUH1/33CUH2/33CUH3,
 $0.5 \text{ ms} + 0.5 \mu\text{s} \times \text{number of bytes to transfer}$.

(When the number of bytes to transfer is maximum (2304 bytes), $0.5 \text{ ms} + 0.5 \mu\text{s} \times 2304 = 1.65 \text{ ms}$)

[2] Communication delay time

The communication data on the ME-NET may have the delay shown below.

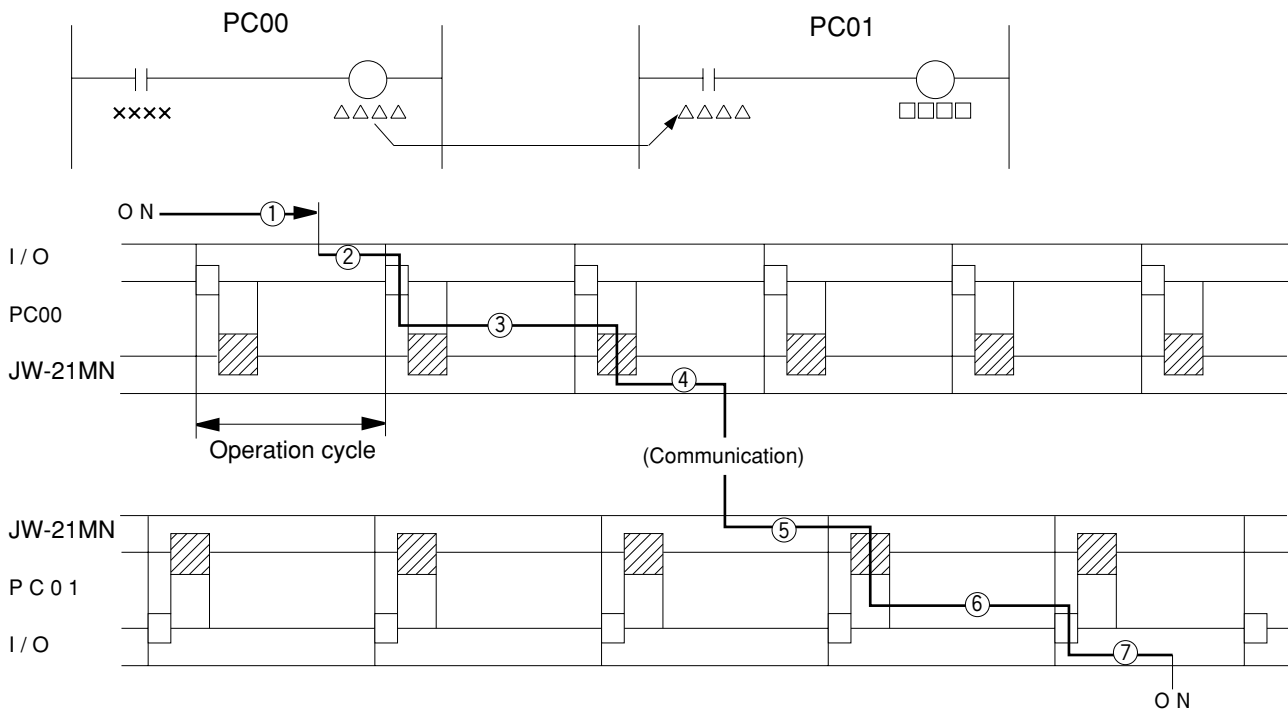

- ① Delay of input module
- ② Time required for PC to detect input state (one operation cycle max.)
- ③ Operation time of sending PC (one operation cycle)
- ④ Time to complete sending of operation result (one communication cycle max.)
- ⑤ Time required for receiving PC to write receive data in PC data memory (one operation cycle max.)
- ⑥ Operation time of receiving PC (one operation cycle)
- ⑦ Delay of output module

Communication delay time is the total time of ① to ⑦ above.

Remarks

The buffer memory contents of the JW-21MN is renewed for each PC operation cycle. Therefore, a contact point which turns "ON" for only one operation cycle of a PC may not be transferred.

[3] Data transmission between master PC and slave PC

Providing synchronous transfer gives positive data communication.

[An example of synchronized transfer by OUT instruction]

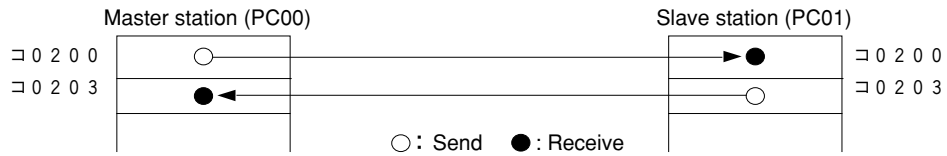

Program in master station

Program in slave station

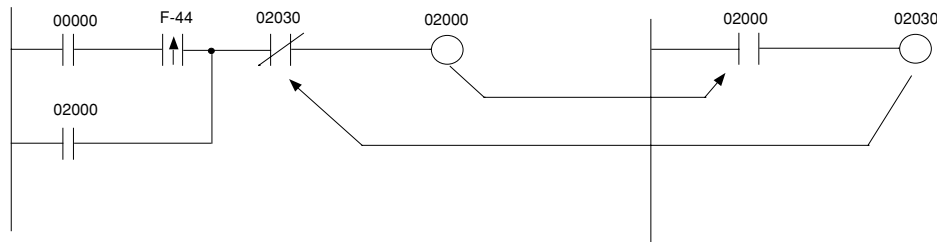

- 00000 is turned "ON" at the master station side.(OUT 02000 is a self-holding circuit.)
- When 02000 is turned "ON" at the slave station side, OUT 02030 is also turned "ON." This is sent back to the master station side.

9-3 Expansion of network

The JW-21MN can transmit data between 64 stations at maximum. If more than 64 stations are required for data link, you can add communication stations with the procedure below.

[1] Multiple installation of the JW-21MN

Mounting more than one JW-21MN on the basic rack panel of the JW20/JW20H/JW30H can increase the number of stations.

[In the case of mounting 4 sets of JW-21MN]

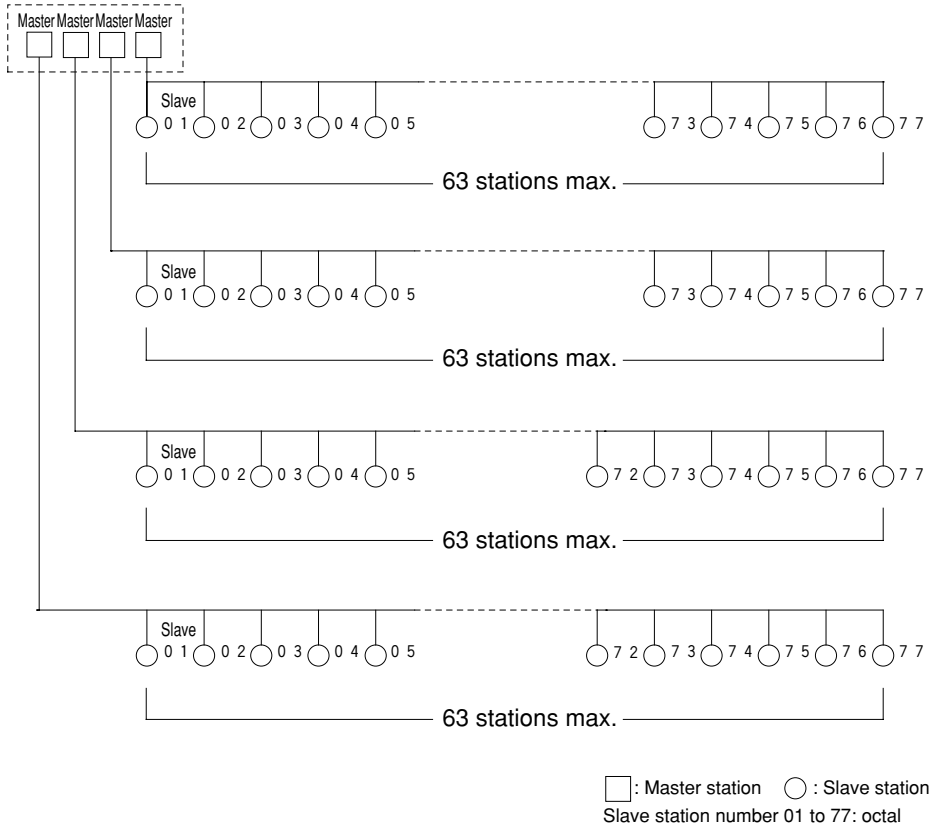

Remarks

- When installing multiple number of modules on a single PC, make them allocated so that relay link area, register link area, and flag area may not overlap with each other.
- When installing multiple number of modules on a single PC, pay attention to the total communication data volume and the number of bytes available for communication area.
- Though more than one JW-21MN can be mounted on single basic rack panel, they cannot directly communicate with other stations beyond one network.

[2] Hierarchical link

When 2 sets of JW-21MN are mounted on the basic rack panel of the JW20/JW20H/JW30H, hierarchical link communication is possible and can increase the number of stations.

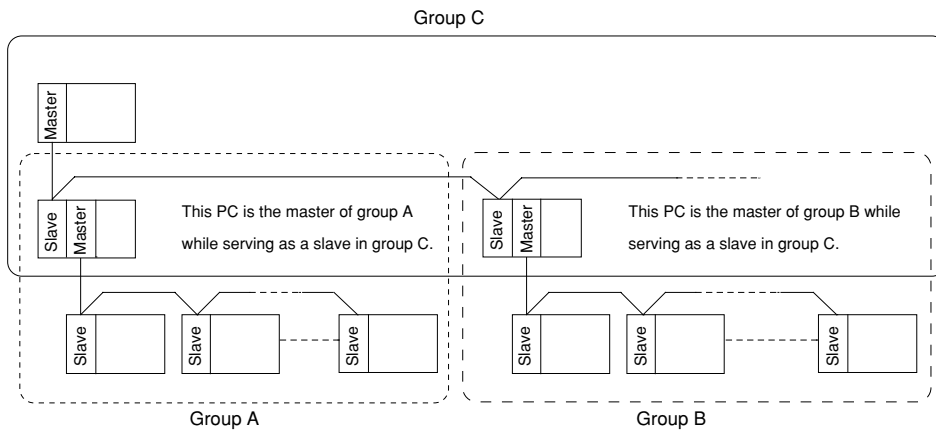
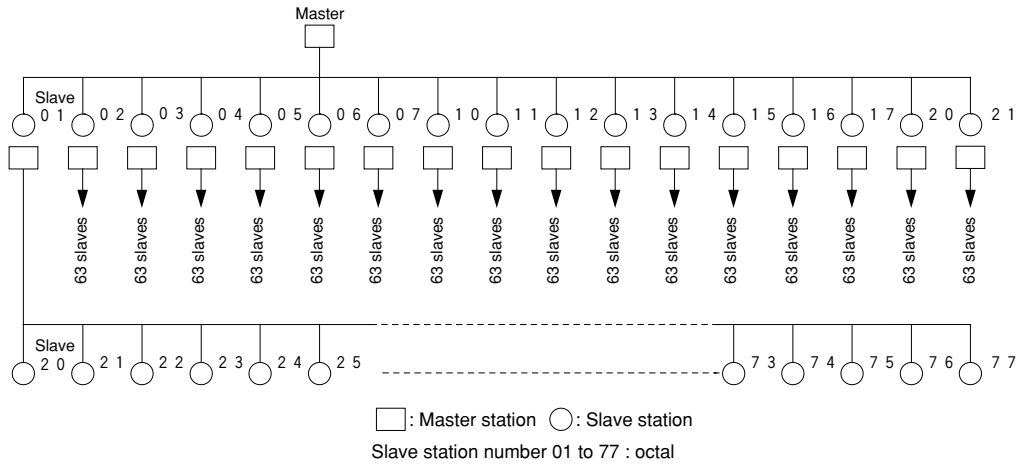

Remarks

- Pay attention to hierarchical link system consisting of more than two levels as it takes time for communication between the stations at the highest level and at the lowest level.
- Though more than one JW-21MN can be mounted on single basic rack panel, they cannot directly communicate with other stations beyond one network.

Chapter: 10 Description for Computer Link Operation

When connected to a host computer with a network module that is compatible with the ME-NET specifications, the JW-21MN can transfer data.

10-1 Computer link function

The host computer communicates with each station number one by one. On the computer link, the host computer can communicate with any required station regardless of whether it is the master or slave station.

- (1) The host computer instructs station number/communication contents/memory address/data etc. of the communicating station as a "command."
- (2) The "command" receiving station processes this data and returns the result as "response."

(System example)

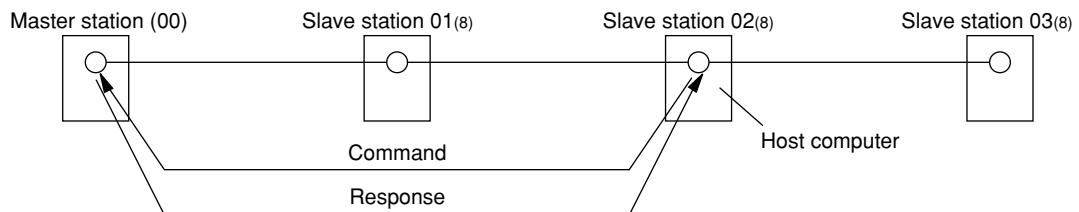

In order to use the computer link function above, the host computer needs program application software. For programming this software, see the instruction manual attached with the network module.

Computer link commands of the ME-NET can be roughly classified into basic commands and optional commands.

[1] Basic commands

Commands mainly used with PCs.

These commands are the functions used to read and write relays and registers. The JW-21MN supports all of the basic commands (for both the 47 and 57 family). ⇨ See the next page.

Reference

The 47 and 57 family: ME-NET computer link commands are divided into the 47 and 57 families of commands, which use different communication formats. However, you do not need to be concerned about the differences in these families when using the computer link function.

[2] Optional commands

Commands other than the basic commands. These are individual commands specific to each device.

⇨ See page 10-3.

10-2 Basic commands

Meaning and available memory address ranges of each command are shown in the table below

- Numeric values of each command are command numbers specified by the ME-NET.

- Write mode assignment shows write enabled/disabled to the PC memory. (See command No. F9_(H).)

Command	Setting available address range (octal) and notes for use		Write mode assignment
	JW20/JW20H	JW30H	
Reading Relay 20 _(H)	00000 to 15777 (relay) T-C000 to 777 (TMR/CNT contact point)	00000 to 15777, 20000 to 75777 (relay) T-C0000 to 0777, T-C1000 to 1777 (TMR/CNT contact)	None
	Set in units of one points		
Relay start/reset 30 _(H)	00000 to 15777 (relay)	00000 to 15777 20000 to 75777 (relay)	1 or 2
	Set in units of one points (SET = 1, RESET = 0)		
Reading register current value 24 _(H)	0000 to 1577 b0000 to b1777 09000 to 09777, 19000 to 19777 29000 to 29777, 39000 to 39777 49000 to 49777, 59000 to 59777 69000 to 69777, 79000 to 79777 89000 to 89777, 99000 to 99777 E0000 to E1777	0000 to 1777, 2000 to 7777 b0000 to b1777, b2000 to b3777 09000 to 09777, 19000 to 19777 29000 to 29777, 39000 to 39777 49000 to 49777, 59000 to 59777 69000 to 69777, 79000 to 79777 89000 to 89777, 99000 to 99777 E0000 to E1777 - For details about the file register, see page 8-4.	None
	Can be set to read up to 1024 bytes at one time. Write to register 24 _(H) .		
Write to register 34 _(H)	The allowable address ranges are the same as shown in "Reading the register's current value 24 _(H) ." Can be set up to 1024 bytes at one time. You must enter a value for the number of bytes that will be written.		1 or 2
Write the same data into register 35 _(H)	The allowable address ranges are the same as shown in "Reading the register's current value 24 _(H) ." Can be set up to 1024 bytes at one time.		
Set/reset TMR/CNT 32 _(H)	000 to 777	000 to 0777, 1000 to 1777	
	Set in units of one points (SET = 1, RESET = 0)		
Read program memory 04 _(H)	Different with control module and memory module types - JW-21CU: 000000 to 006777 - JW-22CU: 000000 to 006777 When using memory module JW-21MA /21MO/21ME) 000000 to 016777 (When using memory module JW-22MA)	Different with control module - JW-31CUH/H1: 000000 to 016777 - JW-32CUH: 000000 to 036777 - JW-32CUH1: 000000 to 036777 or 000000 to 076777 - JW-33CUH/H1: 000000 to 0076777 - JW-32CUH2/H3: 000000 to 076777, 1000000 to 176777	None
	Can be set up to 512 steps per one reading. Data are read out with machine language.		
Write program memory 14 _(H)	The allowable address ranges are the same as shown in "Reading program memory 04 _(H) ." Can be set up to 512 steps per one writing This command can be executed only when a PC is stopped operation with "PC operation stop" command, and "write mode specification as 2."		2 only
Read PC operation status E8 _(H)	----		
Stop PC operation F8 _(H)	When this command is executed, the PC cannot be restarted using a support tool.		
Restart PC operation P8 _(H)	This command is effective only when the PC is stopped operation by the "PC operation stop" command. When the PC stops operation with another reason, the PC cannot restart operation with this command.		
Read write mode status E9 _(H)	----		None
Assign write mode F9 _(H)	Prohibit writing all PC memory --- 0 Allows writing to PC data memory --- 1 Allows writing to PC all memory --- 3 Choose any of these.		
Read manufacturer code 6F _(H)	The JW-21MN returns manufacturer code (CL: SHARP), and model code (A: PC).		

10-3 Optional commands

The JW-21MN optional commands are any commands not specified in the ME-NET specifications. These are commands specific to the JW-21MN. The host computer may use these optional commands for communication between JW-21MNs and PCs (JW20/JW20H/JW30H) with a JW-21MN installed. The table below shows optional commands (1) to (19) for the JW-21MN.

Optional command	Reference page
[1] Read free memory size	10-4
[2] Monitor TMR, CNT, and MD	10-4
[3] Reading PC mode	10-5
[4] Setting PC mode	10-5
[5] Reading system memory	10-6
[6] Writing system memory	10-6
[7] Reading date	10-7
[8] Setting date	10-7
[9] Reading time	10-8
[10] Setting time	10-8
[11] Correct clock time	10-9
[12] Monitor step status	10-9
[13] Read the optional parameters	10-10
[14] Set the optional parameters	10-10
[15] Read the special I/O parameters	10-11
[16] Set the special I/O parameters	10-11
[17] Set the secret function	10-12
[18] Release the secret function, register a password	10-12
[19] Check the secret status	10-13

JW20/JW20H only

JW30H only

10

[Communication format, basic pattern]

■ Command

"+"	"C"	"L"	"A"	CMD	SUB	ATTR	C.TEXT
-----	-----	-----	-----	-----	-----	------	--------

■ Response (normal)

"+"	ACK	"C"	"L"	"A"	CMD	SUB	ATTR	C.TEXT
-----	-----	-----	-----	-----	-----	-----	------	--------

- Response on error: See page 10-14.

Symbol	Data	Details
"+"	2B _(H)	Optional command
"C"	43 _(H)	SHARP manufacturer Identification code
"L"	4C _(H)	
"A"	41 _(H)	Model code (PC)
CMD	*1	Function code
SUB	*2	Sub code
ATTR	00 _(H)	Always set to 00 _(H)
C.TEXT	*3	Assignment detail of each optional code
R.TEXT		
ACK	00 _(H)	Response (when normal)

*1, *2, and *3
See each optional command (10-4 to 10-13)

[1] Read free memory size

Read free memory size.

[Write mode assignment]: None

[Communication format]

Command	"+"	"C"	"L"	"A"	CMD	SUB	ATTR
---------	-----	-----	-----	-----	-----	-----	------

Response	"+"	ACK	"C"	"L"	"A"	CMD	SUB	ATTR	MODE
----------	-----	-----	-----	-----	-----	-----	-----	------	------

Symbol	Data	Details
CMD	43(H)	Function code
SUB	4D(H)	Sub code
M	03(H)	Program memory capacity: 3.5 k words
	07(H)	Program memory capacity: 7.5 k words
	07(H)	Program memory capacity: 15.5 k words
	07(H)	Program memory capacity: 31.5 k words

(Symbols other than the left: See page 10-3.)

Ex. When reading the amount of free program memory (up to 7.5 k words). The data in the cells are hexadecimal numbers.

Command	2B	43	4C	41	43	4D	00		
	"+"	"C"	"L"	"A"	CMD	SUB	ATTR		
Response	2B	00	43	4D	41	43	4D	00	07
		ACK			CMD	SUB			7.5k word

[2] Monitor TMR, CNT, and MD

Read out the current value and attributed data from TMR, CNT, and MD in the specified area.

[Write mode assignment]: None

[Communication format]

Command	"+"	"C"	"L"	"A"	CMD	SUB	ATTR	TMR.NO.	N
---------	-----	-----	-----	-----	-----	-----	------	---------	---

Response	"+"	ACK	"C"	"L"	"A"	CMD	SUB	ATTR	TMR.NO.	N
					D1			DN	TA1	TAN

Symbol	Data	Details	Symbol	Data	Details	
CMD	42(H)	Function code	TA1 to TAN	00(H)	Not used as TMR, CNT, or MD	
SUB	23(H)	Sub code		01(H)	ZW/JW MD	
TMR NO	When JW20/JW20H is used: 000 to 777(8)	TMR, CNT, MD number (in order of 2 bytes data, L and H.)		02(H)	ZW CNT	
	When JW30H is used: 0000 to 7777(8) (TMR, CNT, MD) 1000 to 1777(8) (TMR, CNT)			04(H)	ZW TMR	
N	0000 to 0100(8)	Number of reading data (in order of 2 bytes data, L and H.)		08(H)	DTMR (BCD)	Data 1 bytes x Number of reading data
				09(H)	DTMR (BIN)	
				0A(H)	UTMR (BCD)	
				0B(H)	UTMR (BIN)	
				0C(H)	DCNT (BCD)	
				0D(H)	DCNT (BIN)	
				0E(H)	UCNT (BCD)	
				0F(H)	UCNT (BIN)	
D1 to DN	See the example	Reading current value data (Data 2 bytes x number of reading data)				

(See page 10-3 for other symbols not described above)

[Ex.] Read the current value of TMR, CNT, and MD at addresses 000 to 002(8)

(The data in cells are in hexadecimal notation)

Command	2B	43	4C	41	42	23	00	00	00	03	00	
	"+"	"C"	"L"	"A"	CMD	SUB	ATTR	000(8)		3 pieces		
Response	2B	00	43	4C	41	42	23	00	00	00	03	00
		ACK			CMD	SUB	ATTR	000(8)		3 pieces		
	65	38	32	60	14	73	08	0C	0E			
	No. 000	No. 001	No. 002	DTMR	DCNT	UCNT						
	Current value:	Current value:	Current value:	000	001	002						
	3865	6032	7314	(BCD)	(BCD)	(BCD)						

[3] Reading PC mode

Read PC's mode.

[Write mode assignment]: None

[Communication format]

■ Command

"+"	"C"	"L"	"A"	CMD	SUB	ATTR
-----	-----	-----	-----	-----	-----	------

■ Response

"+"	ACK	"C"	"L"	"A"	CMD	SUB	ATTR	MODE
-----	-----	-----	-----	-----	-----	-----	------	------

Symbol	Data	Details
CMD	43(H)	Function code
SUB	4E(H)	Sub code
MODE	00(H)	Monitor code
	02(H)	Change mode
	03(H)	Program mode

(Symbols other than the left: See page 10-3.)

[Ex.] When the PC reads program mode (Data in the cells are hexadecimal notation).

Command

2B	43	4C	41	43	4E	00
----	----	----	----	----	----	----

Response

2B	00	43	4C	41	43	4E	00	03
	ACK				CMD	SUB	ATTR	Program Mode

[4] Setting PC mode

Set the PC to an assigned mode.

[Write mode assignment]: None

[Communication format]

■ Command

"+"	"C"	"L"	"A"	CMD	SUB	ATTR	MODE
-----	-----	-----	-----	-----	-----	------	------

■ Response

"+"	ACK	"C"	"L"	"A"	CMD	SUB	ATTR
-----	-----	-----	-----	-----	-----	-----	------

Symbol	Data	Details
CMD	43(H)	Function code
SUB	5E(H)	Sub code
MODE	00(H)	Monitor code
	02(H)	Change mode
	03(H)	Program mode

(Symbols other than the left: See page 10-3.)

[Ex.] When to set the PC to the change mode. (Data in cells are hexadecimal notation)

Command

2B	43	4C	41	43	5E	00	02
----	----	----	----	----	----	----	----

Response

2B	00	43	4C	41	43	5E	00
	ACK				CMD	SUB	ATTR

[5] Reading system memory

Read the specified number of bytes of data from the specified address in system memory.

[Write mode assignment]: None

[Communication format]

■ Command

"+	"C"	"L"	"A"	CMD	SUB	ATTR	SEG	SADR	N
----	-----	-----	-----	-----	-----	------	-----	------	---

■ Response

"+	ACK	"C"	"L"	"A"	CMD	SUB	ATTR	SEG	SADR	N	D1
----	-----	-----	-----	-----	-----	-----	------	-----	------	---	----

DN

Symbol	Data	Details
CMD	43(H)	Function code
SUB	44(H)	Sub code
SEG	08(H)	Read out segment
SADR	0000 to 00FF(H)	Read out address #000 to #377 ₍₈₎ (2 byte data, in order of L and H)
N	0001 to 0100(H)	Number of read out bytes (2 byte data, in order of L and H)
D1 to DN	See the example	Reading data of system memory (1 byte data x number of reading data bytes)

[Ex.] To read data from system memory addresses #201 and #202

(201₍₈₎ = 81(H), Data in cells: Hexadecimal notation)

Command

2B	43	4C	41	43	44	00	08	81	00	02	00
----	----	----	----	----	----	----	----	----	----	----	----

Response

"+	"C"	"L"	"A"	CMD	SUB	ATTR	SEG	SADR	N	01	01
----	-----	-----	-----	-----	-----	------	-----	------	---	----	----

ACK	CMD	SUB	ATTR	SEG	SADR	N	#201	#202
-----	-----	-----	------	-----	------	---	------	------

Read data

10

[6] Writing system memory

Write the specified number of bytes of data from the specified address in system memory.

[Write mode assignment]: 2 (When the PC has been stopped with a "halt PC operation F8(H)" command)

[Communication format]

■ Command

"+	"C"	"L"	"A"	CMD	SUB	ATTR	SEG	SADR	N	D1
----	-----	-----	-----	-----	-----	------	-----	------	---	----

DN

■ Response

"+	ACK	"C"	"L"	"A"	CMD	SUB	ATTR	SEG	SADR	N
----	-----	-----	-----	-----	-----	-----	------	-----	------	---

Symbol	Data	Details
CMD	43(H)	Function code
SUB	54(H)	Sub code
SEG	08(H)	Write segment
SADR	0000 to 00FF(H)	Write address #000 to #377 ₍₈₎ (2 byte data, in order of L and H)
N	0001 to 0100F(H)	Number of writing bytes (2 byte data, in order of L and H)
D1 to DN	See the example	Write data of system memory (1 byte data x number of write data bytes)

[Ex.] To write data 01(H), 01(H) to data from system memory addresses #201 and #202

(201₍₈₎ = 81(H), Data in cells: Hexadecimal notation)

Command

2B	43	4C	41	43	54	00	08	81	00	02	00	01	01
----	----	----	----	----	----	----	----	----	----	----	----	----	----

"+	"C"	"L"	"A"	CMD	SUB	ATTR	SEG	SADR	N	#201	#202
----	-----	-----	-----	-----	-----	------	-----	------	---	------	------

Write data

Response

2B	00	43	4C	41	43	54	00	08	81	00	02	00
----	----	----	----	----	----	----	----	----	----	----	----	----

ACK	CMD	SUB	ATTR	SEG	SADR	N
-----	-----	-----	------	-----	------	---

[7] Reading date

Read the year, month, date, and day of week. However, when JW-21CU or JW-31CUH/H1 is used as PC, they do not have clock function and the reading will be meaningless.

[Write mode assignment]: None

[Communication format]

■ Command

"+"	"C"	"L"	"A"	CMD	SUB	ATTR
-----	-----	-----	-----	-----	-----	------

■ Response

"+"	ACK	"C"	"L"	"A"	CMD	SUB	ATTR	Y	D	DW
-----	-----	-----	-----	-----	-----	-----	------	---	---	----

Symbol	Data	Details
CMD	45(H)	Function code
SUB	A2(H)	Sub code
Y	00 to 99(H)	00 to 99 year (lower two digits of western year)
M	01 to 12(H)	January to December
D	01 to 31(H)	1st to 31st day of month
DW	00 to 06(H)	Day of week (Sunday: 00(H), Monday: 01(H), Tuesday: 02(H), Wednesday: 03(H), Thursday: 04(H), Friday: 05(H), Saturday: 06(H))

[Ex.] Reading out April 25, 1996 (Thursday). (The data in cells are in hexadecimal notation)

Command

2B	43	4C	41	45	A2	00
"+"	"C"	"L"	"A"	CMD	SUB	ATTR

Response

2B	00	43	4C	41	45	A2	00	96	04	25	03
	ACK				CMD	SUB		1996	April	25	Thursday

[8] Setting date

Set year, month, day, and day of week. However, when JW-21CU or JW-31CUH/H1 is used as PC, these PC do not have clock function and date cannot be set.

[Write mode assignment]: 1 or 2

[Communication format]

■ Command

"+"	"C"	"L"	"A"	CMD	SUB	ATTR	Y	M	D	DW
-----	-----	-----	-----	-----	-----	------	---	---	---	----

■ Response

"+"	ACK	"C"	"L"	"A"	CMD	SUB	ATTR
-----	-----	-----	-----	-----	-----	-----	------

Symbol	Data	Details
CMD	45(H)	Function code
SUB	B2(H)	Sub code
Y, M, D, DW	Same as the "Reading out date" above.	

(Symbols other than the left: See page 10-3.)

[Ex.] Set May 1st (Wednesday), 1996 (Data in frame: Hexadecimal)

Command

2B	43	4C	41	45	B2	00	96	05	01	02
"+"	"C"	"L"	"A"	CMD	SUB	ATTR	1996	May	1	Wednesday

Response

2B	00	43	4C	41	45	B2	00
	ACK				CMD	SUB	

[9] Reading time

Read out time (hour, minute, second) of clock. However, when JW-21CU or JW-31CUH/H1 is used as PC, these PC do not have clock function and the read out data will be unsettled.

[Write mode assignment]: None

[Communication format]

■ Command "+" "C" "L" "A" CMD SUB ATTR

■ Response "+" ACK "C" "L" "A" CMD SUB ATTR H M S

Symbol	Data	Details
CMD	45(H)	Function code
SUB	A3(H)	Sub code
H	00 to 23(H)	00 to 23 o'clock
M	00 to 59(H)	00 to 59 minutes
S	00 to 59(H)	00 to 59 seconds

(Symbols other than the left: See page 10-3.)

[Example] Reading a time of 8 : 30 : 30 AM. (The data in cells are in hexadecimal notation)

Command 2B 43 4C 41 45 A3 00
 "+" "C" "L" "A" CMD SUB ATTR

Response 2B 00 43 4C 41 45 A3 00 08 30 30
 ACK CMD SUB 8: 30: 30AM

[10] Setting time

Set time (hour, minute, second) of clock. However, when JW-21CU or JW-31CUH/H1 is used as PC, these PC do not have clock function and date cannot be set.

[Write mode assignment]: 1 or 2

[Communication format]

■ Command "+" "C" "L" "A" CMD SUB ATTR H M S CTRL

■ Response "+" ACK "C" "L" "A" CMD SUB ATTR

Symbol	Data	Details
CMD	45(H)	Function code
SUB	B3(H)	Sub code
H, M, S	Same as the "Reading out time" above.	
CTRL	00(H)	Start operation of the clock
	01(H)	Stop operation of the clock
	02(H)	Reset digits lower than the second
	08(H)	Correct 30 seconds (Round off 0 to 29 sec., and round up 30 to 59 sec.)

[Example] When the time is 13 : 30 : 00. (The data in cells are in hexadecimal notation)

Command 2B 43 4C 41 45 B3 00 13 30 00 00
 "+" "C" "L" "A" CMD SUB ATTR 13 30 00 At operation

Response 2B 00 43 4C 41 45 B3 00
 ACK CMD SUB

[11] Correct clock time

Correct the clock setting. However, when a JW-21CU or JW-31CUH/H1 is used as PC, they do not have clock function and the reading will be meaningless.

[Write mode assignment]: 1 or 2

[Communication format]

■ Command	"+"	"C"	"L"	"A"	CMD	SUB	ATTR	CTRL
-----------	-----	-----	-----	-----	-----	-----	------	------

■ Response	"+"	ACK	"C"	"L"	"A"	CMD	SUB	ATTR
------------	-----	-----	-----	-----	-----	-----	-----	------

Symbol	Data	Details
CMD	45(H)	Function code
SUB	B4(H)	Sub code
CTRL	00(H)	Start operation of the clock
	01(H)	Stop operation of the clock
	02(H)	Reset digits lower than the second
	08(H)	Correct 30 seconds (Round off 0 to 29 sec., and round up 30 to 59 sec.)

[Ex.] To stop the clock. (The data in cells are in hexadecimal notation)

Command	2B	43	4C	41	45	B4	00	01
	"+"	"C"	"L"	"A"	CMD	SUB	ATTR	Stop operation

Response	2B	00	43	4C	41	45	B4	00
		ACK				CMD	SUB	

[12] Monitor step status: JW20/JW20H only

Read out "N" byte data from specified process and step.

[Write mode assignment]: None

[Communication format]

■ Command	"+"	"C"	"L"	"A"	CMD	SUB	ATTR	PRS	STP	N
-----------	-----	-----	-----	-----	-----	-----	------	-----	-----	---

■ Response	"+"	ACK	"C"	"L"	"A"	CMD	SUB	ATTR	PRS	SPT	N	D1	D2		DN
------------	-----	-----	-----	-----	-----	-----	-----	------	-----	-----	---	----	----	--	----

Symbol	Data	Details
CMD	44(H)	Function code
SUB	64(H)	Sub code
PRS	000 to 003(H)	Process number
STP	000 to 007(H)	Step number
N	01 to 08(H)	Number of bytes to read out
D1 to DN	See the example	Read the data

(Symbols other than those shown on the left: See page 10-3.)

[Ex.] Read the data for process number 03 and step number 002 to 004₍₆₎. (The data in the cells are in hexadecimal notation)

Command	2B	43	4C	41	44	64	00	03	02	03
	"+"	"C"	"L"	"A"	CMD	SUB	ATTR	Process Number	Step Number	Number of reading bytes

Response	2B	00	43	4C	41	44	64	00	03	02	03	08	01	03
		ACK				CMD	SUB		AM 3 o'clock	30 minute	30 seconds	Step 002	Step 003	Step 004
												Read out data		

[13] Read the optional parameters

Read the parameter data for option module (other than JW-21MN) from the control module.

[Write mode assignment]: None

[Communication format]

■ Command

"+"	"C"	"L"	"A"	CMD	SUB	ATTR	UNO	PAADR	N
-----	-----	-----	-----	-----	-----	------	-----	-------	---

■ Response

"+"	ACK	"C"	"L"	"A"	CMD	SUB	ATTR	UNO	PAADR	N	D1		DN
-----	-----	-----	-----	-----	-----	-----	------	-----	-------	---	----	--	----

Symbol	Data	Details
CMD	42(H)	Function code
SUB	02(H)	Sub code
UNO	00 to 07(H)	Set value for the module No. switch
PAADR	000 to 077(8)	Read the starting address
N	01 to 40(H)	Number of bytes to read out
D1 to DN	See the example	Read out data (for number of bytes of reading data)

(Symbols other than the left: See page 10-3.)

[Ex.] Read the parameters at address 030 to 032(8) for an option module (No.3). (Data in frames are in hexadecimal, except when followed by an(8), indicating octal data).

Command

2B	43	4C	41	42	02	00	03	030(8)	003(8)
"+"	"C"	"L"	"A"	CMD	SUB	ATTR	UNO	PAADR	N

Response

2B	00	43	4C	41	42	02	00	03	030(3)	003(3)	15	21	03
	ACK				CMD	SUB					030	031	032
											Read out data		

[14] Set the optional parameters

Write parameter data of option module (other than JW-21MN) to the control module.

[Write mode assignment]

2 (or when the PC is stopped by using a "PC operation stop F8(H)" command).

[Communication format]

■ Command

"+"	"C"	"L"	"A"	CMD	SUB	ATTR	UNO	PAADR	N	D1		DN
-----	-----	-----	-----	-----	-----	------	-----	-------	---	----	--	----

■ Response

"+"	ACK	"C"	"L"	"A"	CMD	SUB	ATTR	UNO	PAADR	N
-----	-----	-----	-----	-----	-----	-----	------	-----	-------	---

Symbol	Data	Details
CMD	42(H)	Function code
SUB	12(H)	Sub code
UNO	00 to 07(H)	Set value for the module No. switch
PAADR	000 to 077(8)	Write the starting address
N	01 to 40(H)	Number of bytes to write
D1 to DN	See the example	Write data (corresponding to the number of bytes to write)

(Symbols other than the left: See page 10-3.)

[Ex.] Write 14(H), 00(H), and 33(H) to parameter address 040 to 042(8) in option module (module No. 2). (The data in cells are in hexadecimal, except when followed by an(8), indicating octal data.)

Command

2B	43	4C	41	42	12	00	02	040(8)	003(8)	14	00	33
"+"	"C"	"L"	"A"	CMD	SUB	ATTR	UNO	PAADR	N	040	041	042
										Read out data		

Response

2B	00	43	4C	41	42	12	00	02	040(8)	003(8)
	ACK				CMD	SUB				

[15] Read the special I/O parameters

Read out parameter data of special I/O modules (other than JW-21MN) from the control module.

[Write mode assignment]: None

[Communication format]

■ Command

"+"	"C"	"L"	"A"	CMD	SUB	ATTR	UNO	PAADR	N
-----	-----	-----	-----	-----	-----	------	-----	-------	---

■ Response

"+"	ACK	"C"	"L"	"A"	CMD	SUB	ATTR	UNO	PAADR	N	D1		DN
-----	-----	-----	-----	-----	-----	-----	------	-----	-------	---	----	--	----

Symbol	Data	Details
CMD	42 ^(H)	Function code
SUB	03 ^(H)	Sub code
UNO	00 to 07 ^(H)	When connected to a JW20/JW20H, set the value for the module No. switch
	00 to 37 ^(H)	When connected to a JW30H, the upper digits are rack No. and the lower digits are the value for module No. switch.
PAADR	000 to 177 ⁽⁸⁾	Read out start address
N	01 to 80 ^(H)	Number of bytes to read out
D1 to DN	See the example	Read out data (for number of bytes of reading data)

(Symbols other than the left: See page 10-3.)

[Ex.] To read parameter address data 030 to 032⁽⁸⁾ of the special I/O module (Module No. 3). (Except one with ⁽⁸⁾, the data in cells are in hexadecimal notation)

Command

2B	43	4C	41	42	03	00	03	030 ⁽⁸⁾	003 ⁽⁸⁾
"+"	"C"	"L"	"A"	CMD	SUB	ATTR	UNO	PAADR	N

Response

2B	00	43	4C	41	42	03	00	03	030 ⁽³⁾	003 ⁽³⁾	15	21	03
	ACK				CMD	SUB			030	031	032		
									Read out data				

[16] Set the special I/O parameters

Write parameter data of the special I/O module (other than JW-21MN) to the control module.

[Write mode assignment]

2 (and when the PC stops operation by "PC operation stop F8^(H)" command).

[Communication format]

■ Command

"+"	"C"	"L"	"A"	CMD	SUB	ATTR	UNO	PAADR	N	D1		DN
-----	-----	-----	-----	-----	-----	------	-----	-------	---	----	--	----

■ Response

"+"	ACK	"C"	"L"	"A"	CMD	SUB	ATTR	UNO	PAADR	N
-----	-----	-----	-----	-----	-----	-----	------	-----	-------	---

Symbol	Data	Details
CMD	42 ^(H)	Function code
SUB	02 ^(H)	Sub code
UNO	00 to 07 ^(H)	When connecting to JW20/JW20H, set value of module No. switch
	00 to 37 ^(H)	When connecting to JW30H, upper digits are rack No. and lower digits are set value for module No. switch.
PAADR	000 to 177 ⁽⁸⁾	Write start address
N	01 to 80 ^(H)	Number of bytes to write
D1 to DN	See the example	Write data (for number of bytes of writing data)

(Symbols other than the left: See page 10-3.)

[Ex.] Write 14^(H), 00^(H), and 33^(H) to parameter address 040 to 042⁽⁸⁾ of the special I/O module (module No. 2). (Except ones with ⁽⁸⁾ marks, the data in cells are in hexadecimal notation)

Command

2B	43	4C	41	42	13	00	02	040 ⁽⁸⁾	003 ⁽⁸⁾	14	00	33
"+"	"C"	"L"	"A"	CMD	SUB	ATTR	UNO	PAADR	N	040	041	042
										Write data		

Response

2B	00	43	4C	41	42	13	00	02	040 ⁽⁸⁾	003 ⁽⁸⁾
	ACK				CMD	SUB				

[17] Set the secret function: JW30H only

Enables the secret function, or deletes previously registered passwords.

[Write mode assignment]

- When command S = 01_(H), none.
- When command S = 0F_(H), 2 (and when the PC is stopped by using the "PC operation stop F8_(H) command.)

[Communication format]

Command	"+"	"C"	"L"	"A"	CMD	SUB	ATTR	S
---------	-----	-----	-----	-----	-----	-----	------	---

Response	"+"	ACK	"C"	"L"	"A"	CMD	SUB	ATTR
----------	-----	-----	-----	-----	-----	-----	-----	------

Symbol	Data	Details
CMD	46 _(H)	Function code
SUB	FB _(H)	Sub code
MODE	01 _(H)	Enable the secret function
	0F _(H)	Disable the secret function

(Symbols other than the left: See page 10-3.)

[Ex.] Enables the secret function. (The data in the cells are in hexadecimal notation).

Command	2B	43	4C	41	46	FB	00	01
	"+"	"C"	"L"	"A"	CMD	SUB	ATTR	Enables

Response	2B	00	43	4C	41	46	FB	00
		ACK			CMD	SUB		

[18] Release the secret function, register password: JW30H only

Release the secret function, or register a password.

[Write mode assignment]

- When command S = 00_(H), none.
- When command S = 01_(H) or 02_(H), 2 (and the PC stops operation by "PC operation stop F8_(H) command).

[Communication format]

Command	"+"	"C"	"L"	"A"	CMD	SUB	ATTR	S		PW
---------	-----	-----	-----	-----	-----	-----	------	---	--	----

Response	"+"	ACK	"C"	"L"	"A"	CMD	SUB	ATTR
----------	-----	-----	-----	-----	-----	-----	-----	------

Symbol	Data	Details	
CMD	46 _(H)	Function code	
SUB	FC _(H)	Sub code	
S	00 _(H)	Release	Release the secret function.
	01 _(H)	Temporary password	Enter a temporary password.
	02 _(H)	Real password	Change the temporary password to a permanent one (the secret function is enabled).
PW	"0" to "9" "A" to "Z" "a" to "z"	Password (alphabetical and numeric 4 letters)	

[Ex.] To register password "15AE." (The data in cells are in hexadecimal notation.)

Command	2B	43	4C	41	46	FC	00	02	31	35	41	45
	"+"	"C"	"L"	"A"	CMD	SUB	ATTR	Real register	Password "15AE"			

Response	2B	00	43	4C	41	46	FC	00
		ACK			CMD	SUB		

[19] Check the secret function: JW30H only

Enables/disables the secret function.

[Write mode assignment]: None

[Communication format]

■ Command

"+"	"C"	"L"	"A"	CMD	SUB	ATTR
-----	-----	-----	-----	-----	-----	------

■ Response

"+"	ACK	"C"	"L"	"A"	CMD	SUB	ATTR	S
-----	-----	-----	-----	-----	-----	-----	------	---

Symbol	Data	Details
CMD	46(H)	Function code
SUB	FD(H)	Sub code
S	00(H)	Disable the secret function
	01(H)	Enable the secret function

(Symbols other than the left: See page 10-3.)

[Ex.] To determine whether the secret function is enabled (the data in cell are in hexadecimal).

Command

2B	43	4C	41	46	FD	00
"+"	"C"	"L"	"A"	CMD	SUB	ATTR

Response

2B	00	43	4C	41	46	FB	00	01
	ACK				CMD	SUB		Enable

[20] Response on error

When a station that has received data encounters an error while processing data after receiving an optional command from the host computer, it will send a response as follows.

■ Response

"+"	ACK	"C"	"L"	"A"	CMD	ERR
-----	-----	-----	-----	-----	-----	-----

ACK data	ERR data	Details
01(H)	None	Command data format is not correct.
06(H)	None	PC is not stopped operation.
07(H)	None	Write data is not properly done.
0F(H)	None	Memory access time out.
10(H)	None	Write mode is not compatible.
11(H)	None	Assigned address is not program area.
FF(H)	02(H)	Assigned address is not set value of TMR, CNT, or MD.
	04(H)	Tried to set/reset MD.
	05(H)	Set value of number of bytes exceeds the set range.
	13(H)	Tried to set/reset TMR, CNT while the PC is stopped operation.
	30(H)	A password is not registered.
	31(H)	The secret function is enabled.
	32(H)	The password is not correct.
	33(H)	Password error.
	34(H)	A JW-21CU/JW-31CUH is used as the PC, and an attempt was made to read, set, or correct the time.
	52(H)	Start/end block error
53(H)	System memory is not correct.	

- Symbols other than above

"+", "C", "L" and "A" : Same as the description on page 10-3.

CMD: Function code for each optional command

⇒ See pages 10-4 to 10-13.

Chapter 11: Setting of Switches and Parameter

11-1 Operation procedure

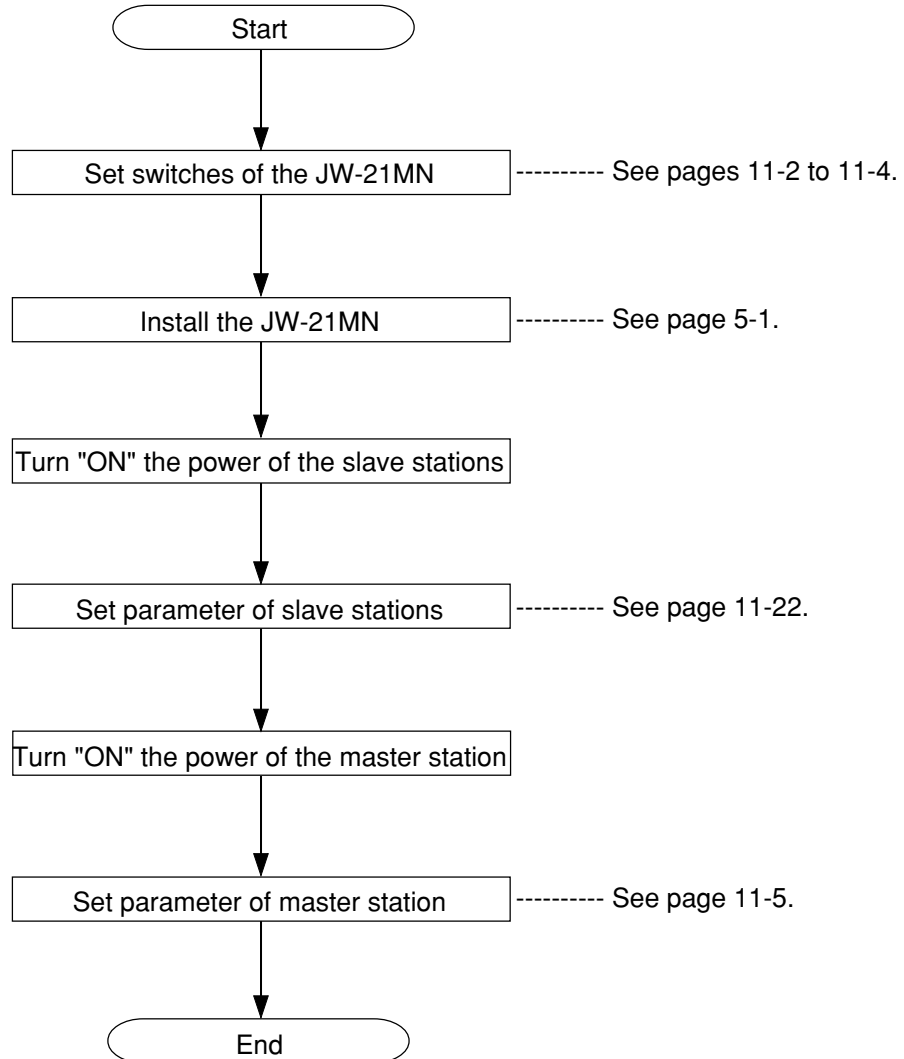

Remarks

- Make sure to turn "OFF" the power of the PC prior to setting the module No. switch and station number switch after installing the JW-21MN.
- Prior to setting the parameters, set the mode of the JW-21MN to "program mode."
- Make sure to write the set parameters into the EEPROM on the JW-21MN after setting.

11-2 Switch setting of master station and slave station

Prior to using the JW-21MN, set the following switches.

[1] Mode switch (MODE)

Set whether the JW-21MN is used as a master station or a slave station as well as the data link type (standard function or save memory function).

Station	Data link	Setting value of the mode switch
Master station	Standard function	2
Slave station	Standard function	2
	Save memory function	3

- Do not set the mode switch to "0," "1," or "4" to "F."
- The computer link function is effective for both "2" and "3" settings.

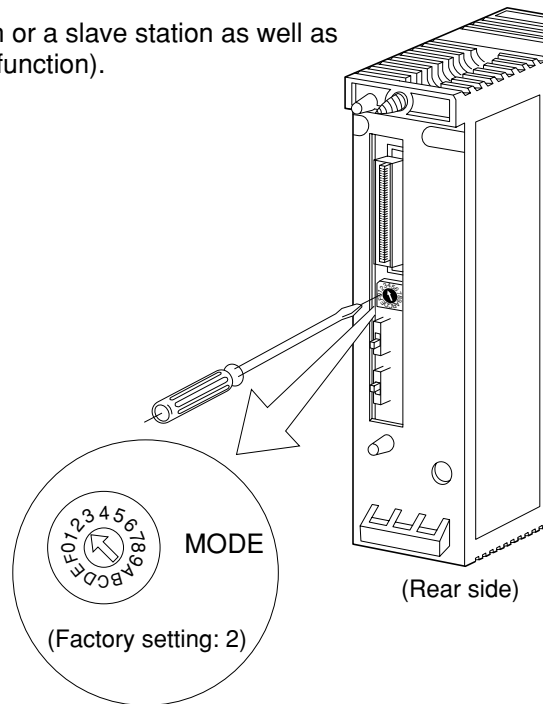

[2] Module No. switch (UNIT NO.)

Select error history storage registration area and data link (save memory function) area for a slave station by setting the mode switches.

(1) Setting the mode switch to "2"

Setting value of the module No. switch	Error history storage register	
	JW20/JW20H	JW30H
0	E1400 to E1577	E7400 to E7577
1	E1200 to E1377	E7200 to E7377
2	E1000 to E1177	E7000 to E7177
3	E0600 to E0777	E6600 to E6777
4	E0400 to E0577	E6400 to E6577
5	E0200 to E0377	E6200 to E6377
6	E0000 to E0177	E6000 to E6177
7 to 9	Prohibited setting	

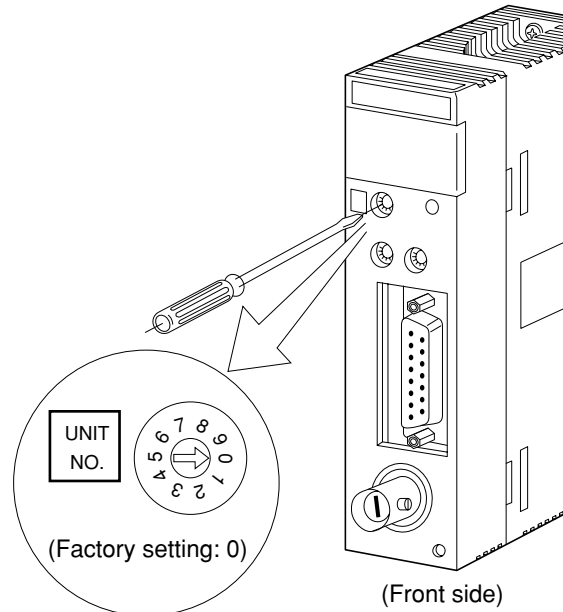

(2) Setting the mode switch to "3"

Setting value of the module No. switch	Data link (Save memory function)		Error history storage register	
	Relay link area	Register link area	JW20/JW20H	JW30H
0	∩1000 to ∩1077	09000 to 09777	E1400 to E1577	E7400 to E7577
1	∩1100 to ∩1177	19000 to 19777	E1200 to E1377	E7200 to E7377
2	∩1200 to ∩1277	29000 to 29777	E1000 to E1177	E7000 to E7177
3	∩1300 to ∩1377	39000 to 39777	E0600 to E0777	E6600 to E6777
4	∩1400 to ∩1477	49000 to 49777	E0400 to E0577	E6400 to E6577
5 to 9	Prohibited setting			

- The setting value of the module No. switch should not be the same as any other option module (including JW-21MN) mounted on the same basic rack panel.
- The top address of each relay link area and register link area corresponds to f1 to fn and g1 to gn on page 11-8 and 11-9.

(3) Station number switch (STA NO.)

Make sure to set the master station number to "00." For slave stations, set from "01" to "77" in octagonal sequence.

- Maximum amount of slave stations to be connected are 63. As the station number should be assigned by octagonal figures, setting of the following values causes errors and the JW-21MN cannot communicate.
08, 09, 18, 19, 28, 29, 38, 39, 48, 49, 58, 59, 68, 69, and 78 to 99.
- Be careful that there is no doubly allocated number and no number has been skipped.

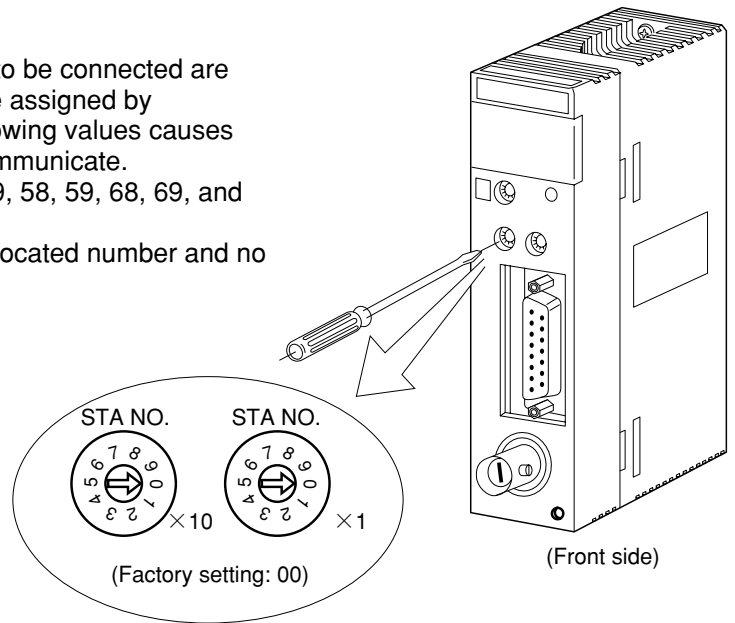

(4) Termination resistance switch (LT)

When the JW-21MN is at the termination station of the communication line, make sure to set the termination resistance switch to "ON."

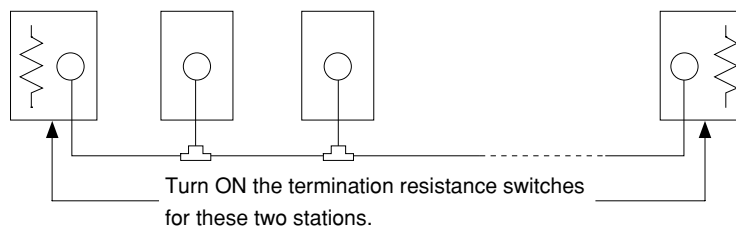

Setting	Condition of the JW-21MN
ON	Insert a termination resistance
OFF	Do not insert a termination resistance

- When using a termination (ME-75 made by Toko Denshi) (device to function as terminator) at the end of a signal cable, turn "OFF" the termination resistance switch of the termination station.

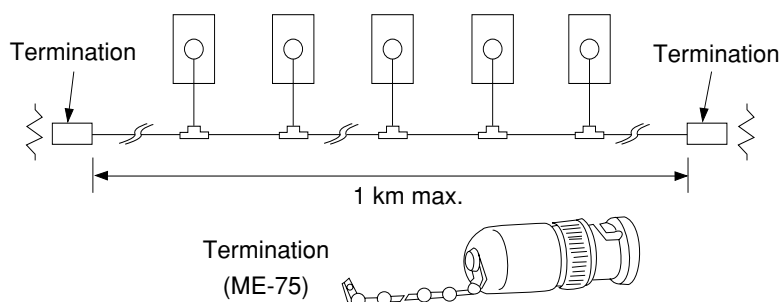
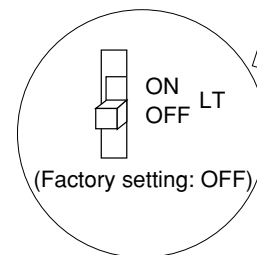

Reference Need for the termination resistance

When a termination resistance is not provided at a communication circuit end, the end of the circuit generates reflection waves. These reflection waves collide with sending signals and abnormal communication may occur. The termination resistance prevents the occurrence of these reflection waves. On the other hand, when an intermediate station has its termination resistance switch turned "ON," this station causes reflection and attenuates signals and causes abnormal communication.

(5) Shield ground switch (LG)

For communication lines, use a coaxial cable.
 As coaxial cable is an unbalanced circuit, ground its shield by turning "ON" the shield ground switch.

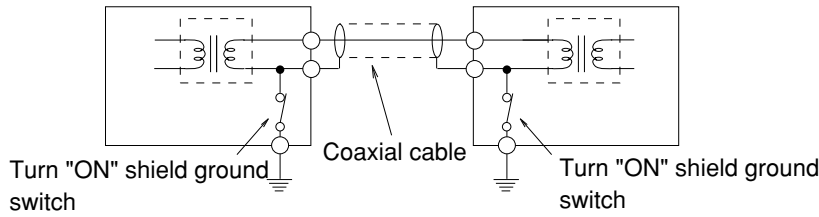

Setting	Condition of the JW-21MN
ON	Conductive between the shield and FG of the JW20/JW20H/JW30H
OFF	Not conductive between the shield and FG of the JW20/JW20H/JW30H

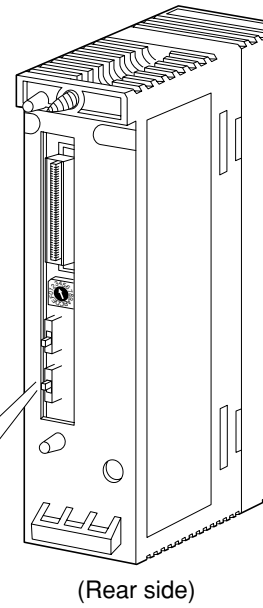
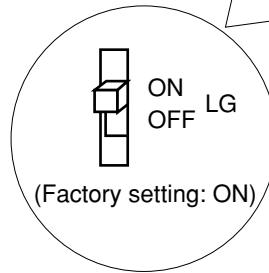

Remarks

- Make sure to provide a class-3 grounding for the GND terminal of the power supply module. Without grounding the power supply module, the JW-21MN cannot become conductive with the ground after turning "ON" the shield ground switch. (See page 7-2.)
- Prior to any electric welding around the JW-21MN, take out the coaxial cable from the JW-21MN. While the coaxial cable is connected to the JW-21MN, any electric welding nearby the JW-21MN will cause the welding current to the JW-21MN and may damage part of its circuit pattern.

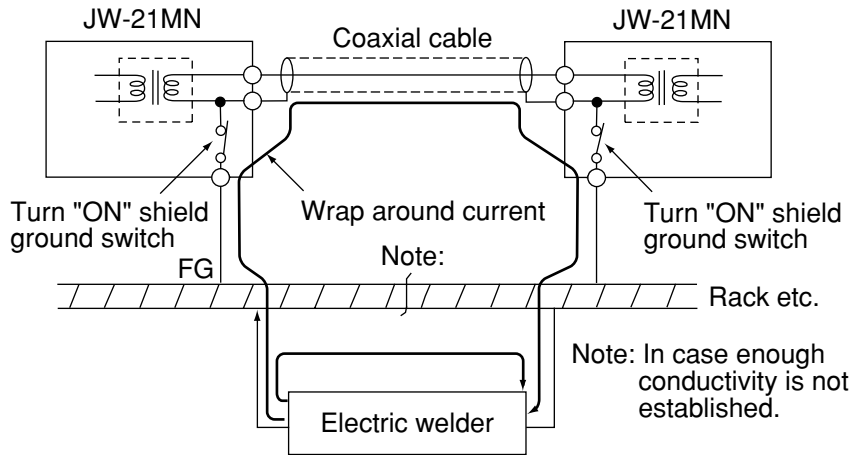

11-3 Setting contents of master station parameters

[1] Setting contents

When the JW-21MN is used as a master station, set the following items for parameters.

When the JW-21MN is used as a slave station, setting contents of the parameter address 004004 to 004377⁽⁸⁾ and 004404 to 004777⁽⁸⁾ may vary with the data link setting condition as a slave station (standard function/save memory function).

For details of the parameter memory, see pages 16-8 to 16-12.

*Corresponding symbols on pages 11-7 to 11-9

Setting item		Parameter address ⁽⁸⁾	Initial value ^(H)	Details (setting range)		*
①	Top address of relay link area on the master station	004000 to 004001	00	Set by file address ⁽⁸⁾ (000000 to 007777 ⁽⁸⁾)		a 0
②	Function	004002	00	Set to relay/register link (01 ^(H) only).		—
③	Number of connecting stations	004003	00	Set the amount of stations including a master station by decimals (002 to 064 ^(D)).		—
④	Relay link area top address or number of offset bytes on slave station 01 ⁽⁸⁾ .	004004 to 004007	00	- When a slave station is a data link (standard function), set the top address by file address ⁽⁸⁾	- When a slave station is a data link (save memory function), set the number of offset bytes by decimals: 00000 to 00256 ^(D)	a 1
	Relay link area top address or number of offset bytes on slave station 02 to 77 ⁽⁸⁾ .	004010 to 004377	00			a 2 to a 77
⑤	Top address of register link area on the master station	004400 to 004403	00	Set by file address ⁽⁸⁾		b 0
⑥	Register link area top address or number of offset bytes on slave station 01 ⁽⁸⁾ .	004404 to 004407	00	- When a slave station is a data link (standard function), set the top address by file address ⁽⁸⁾	- When a slave station is a data link (save memory function), set the number of offset bytes by decimals: 00000 to 02048 ^(D)	b 1
	Register link area top address or number of offset bytes on slave station 02 to 77 ⁽⁸⁾ .	004410 to 004777	00			b 2 to b 77
⑦	Number of sending bytes of master station relay link area.	005000 to 005001	00	Set the number of bytes by decimals: 00000 to 00256 ^(D)		c 0
⑧	Number of sending bytes of slave station 01 ⁽⁸⁾ relay link area.	005002 to 005003	00	Set the number of bytes by decimals. - When a slave station is data link (standard function): 00000 to 00256 ^(D) . - When a slave station is data link (save memory function): 00000 to 00032 ^(D) .		c 1
	Number of sending bytes of slave station 02 to 77 ⁽⁸⁾ relay link area.	005004 to 005177	00			c 2 to c 77
⑨	Number of sending bytes of master register link area	005200 to 005201	00	Set the number of bytes by decimals: 00000 to 01024 ^(D)		d 0
⑩	Number of sending bytes of slave station 01 ⁽⁸⁾ register link area.	005202 to 005203	00	Set the number of bytes by decimals. - When a slave station is data link (standard function): 00000 to 01024 ^(D) . - When a slave station is data link (save memory function): 00000 to 00256 ^(D)		d 1
	Number of sending bytes of slave station 02 to 77 ⁽⁸⁾ register link area.	005204 to 005377	00			d 2 to d 77
⑪	Slave station connection status (error code output)	007750 to 007757	00	Turn ON respective bit. (See page 16-12.)		—
⑫	Yes/no station number information output. V2	007763	00	When set to 01 ^(H) , stores its station number to the data memory (effective when 1 byte next to 24 bytes of flag area is 007767 ⁽⁸⁾ = 80 ^(H) .)		—

* "Connection condition of slave stations" and "Yes/no station number information out" are unique functions of the JW-21MN.

* Corresponding symbols on pages 11-7 to 11-9

Set item		Parameter address(8)	Initial value(H)	Details (set range)		*
⑬	Flag area top address (communication and PC operation status monitor flag)	007764	E0	File address lower digits	Set range: See page 11-11 to 11-12. - Initial value: 01E0(H) to 000740(8) (≡ 0740)	eo
		007765	01	File address upper digits		
		007766	00	File number		
		007767	80	Flag output (Yes: 80(H), No: 00(H))		
⑭	- Start/stop operation of the JW-21MN - Write to the JW-21MN EEPROM.	007777	01	Select "00, 01, 08, 80, 81" with hexadecimal notation. (See page 16-12.)		---

- ① to ⑭ are equivalent to number of page 11-13.
- Parameter addresses other than above mentioned are reserved areas and prohibited to be changed.
- When the JW-21MN is a slave station, set the top address and the number of sending bytes so that the data can be within the setting range of each area (see pages 11-7 to 11-12). When any slave stations are except JW-21MN, see the instruction manual of each device.

[2] Communication area map

(1) In case that setting data link (the standard function) when the master station and all slave stations are JW-21MN's.

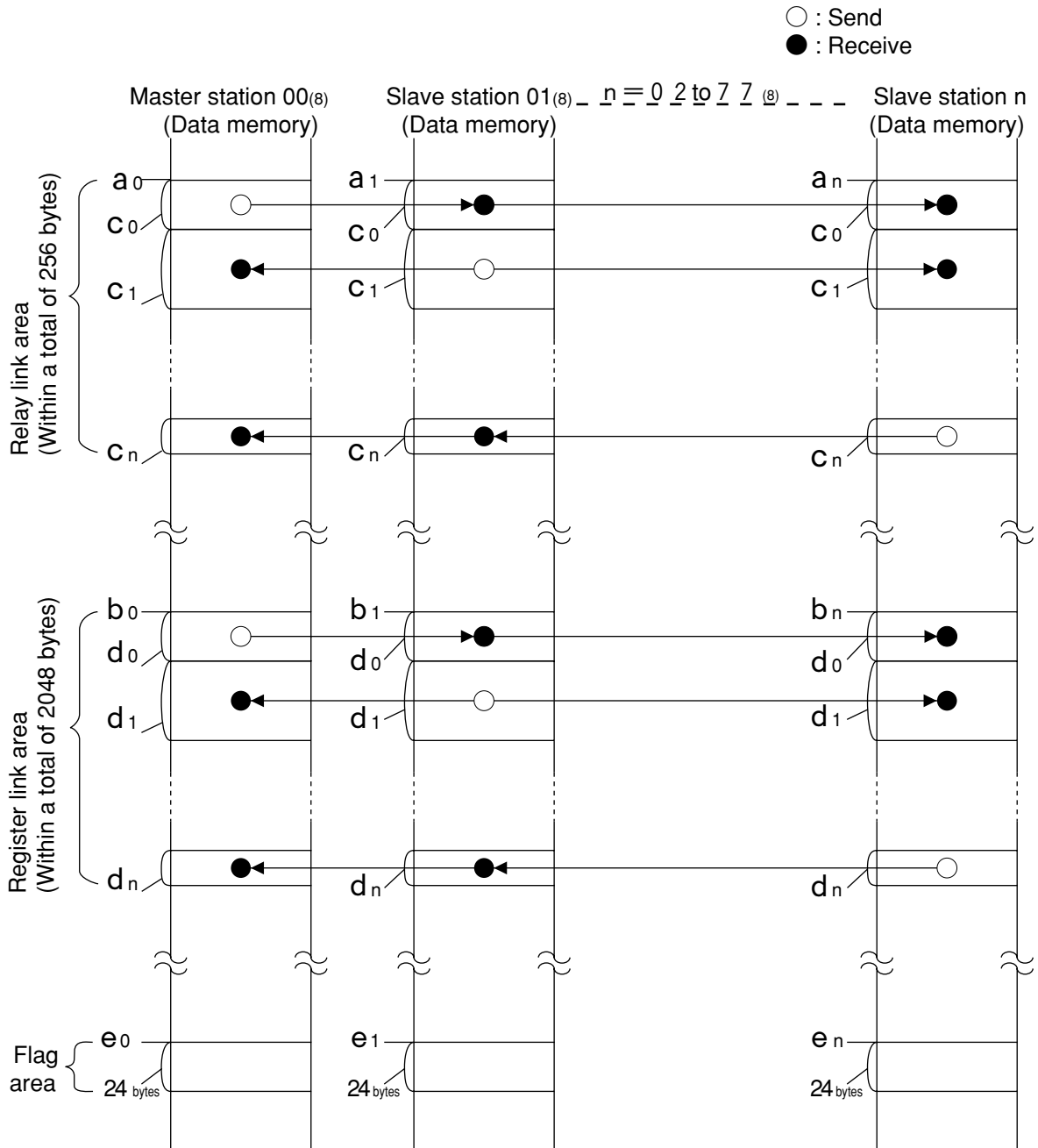

- Set the relay link area, register link area, flag area within the setting range nominated in page 11-11, 12 and 23. However, be careful not to double any address allocation of these.
- Set a₀ to e_n for parameters of master station and slave station. (See page 11-5, 6 and 22)

Parameter for setting in master station	Parameter for setting in slave station
Top address of relay link area a ₀ , a ₁ to a _n	Top address of flag area (slave station) e ₁ to e _n
Top address of register link area b ₀ , b ₁ to b _n	/
Number of sending bytes of relay link area C ₀ , C ₁ to C _n	
Number of sending bytes of register link area d ₀ , d ₁ to d _n	
Top address of flag area (master station) e ₀ .	

- Total number of sending bytes per station both relay link and register link is max. 1024 bytes.
c₀+d₀, c₁+d₁, c_n+d_n = 0 to 1024 bytes.

(2) In case that setting the data link (save memory function) when the master station and all slave stations are JW-21MN's.

Memory addresses inside control module of slave station continue in order of receiving and sending.

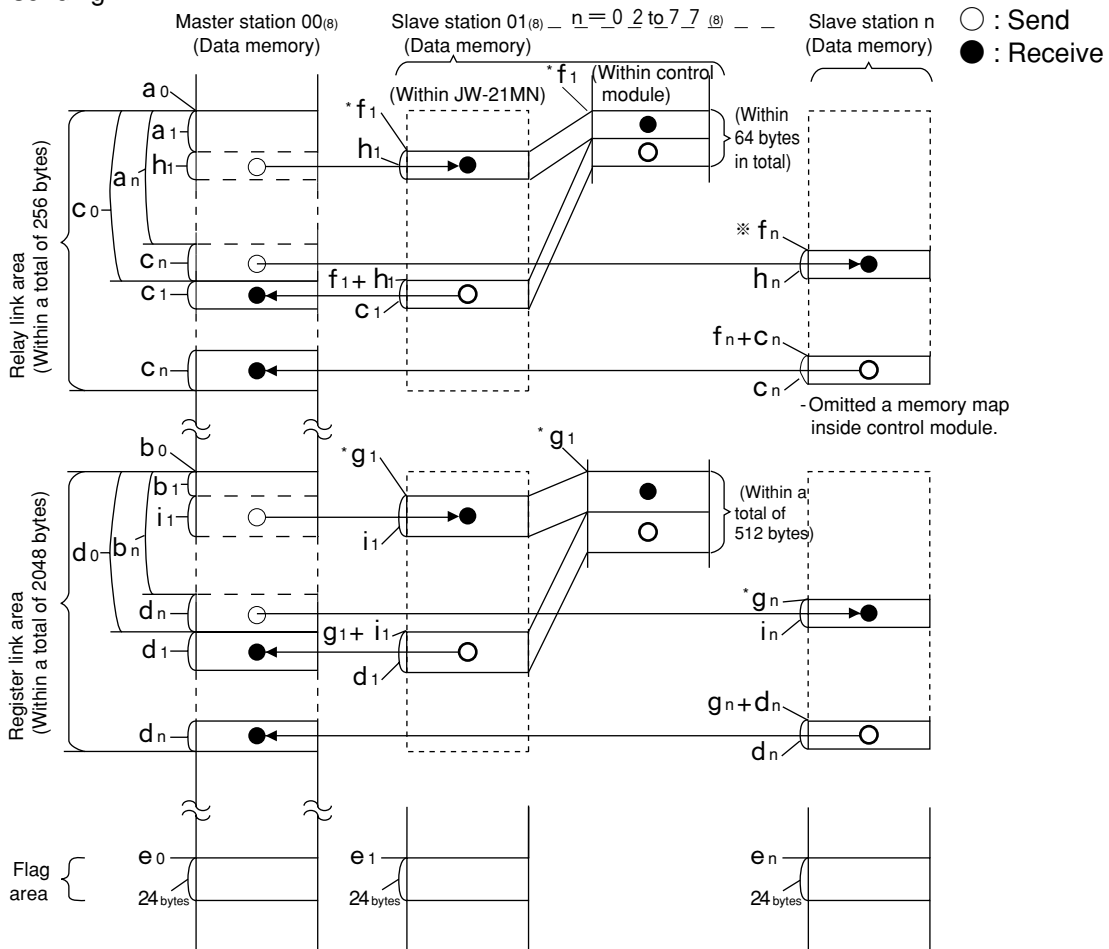

- Set the relay link area, the register link area, and the flag area within the settings range of page 11-11, 12 and 23. Be careful not to double any address allocation of these.
- Set a_0 to e_n , h_1 to i_n above for parameters of master station and slave station (see page 11-5, 6 and 22) and set $f_1/f_n/g_1/g_n$ marked "*" by module No. switch of the JW-21MN (see page 11-2).

Parameter for setting in master station	Parameter for setting in slave station
Top address of relay link area a_0, a_1 to a_n	Top address of flag area (slave station) e_1 to e_n
Top address of register link area b_0, b_1 to b_n	Number of receiving bytes of relay link area h_1 to h_n
Number of sending bytes of relay link area c_0, c_1 to c_n	Number of receiving bytes of register link area i_1 to i_n
Number of sending bytes of register link area d_0, d_1 to d_n	
Top address of flag area (master station) e_0 .	

* Number of receiving bytes of slave station (h_1 to h_n , i_1 to i_n)
 Select self-setting or "same as number of sending bytes (c_1 to c_n , d_1 to d_n)" according to parameter (007720 to 007723) of slave station.
 Note: When installing JW-21MN without $\boxed{30Hn}$ mark or $\boxed{30H}$ mark into JW20/JW20H, number of receiving bytes of each slave station is the same as number of sending bytes.

- Set the receiving area for save memory function within the range of the link area.
 $0 \leq a_1 \leq$ Total number of bytes of relay link area - h_1
 $0 \leq a_n \leq$ Total number of bytes of relay link area - h_n
 $0 \leq b_1 \leq$ Total number of bytes of register link area - i_1
 $0 \leq b_n \leq$ Total number of bytes of register link area - i_n
- Number of offset bytes can be set exceeding the number of sending bytes of the master station.
 $a_1, a_n \diamond c_0$ and $b_1, b_n \diamond d_0$
- Setting example of top address $f_1/f_n/g_1/g_n$
 When the setting value of the module No. switch is "2," f_1/f_n is $\exists 1200$, g_1/g_n is 29000.

(3) When the master station and slave stations are all JW-21MN's and both data link (the standard function) and data link (the save memory function) are set among slave stations.
 Set signs below by the parameters of the master station (page 11-5, 6) and the module No. switch of the JW-21MN (page 11-2).

- An example of a relay link area map for the setting of the data link (standard function) for slave station 01 and the data link (save memory function) to slave station 02.

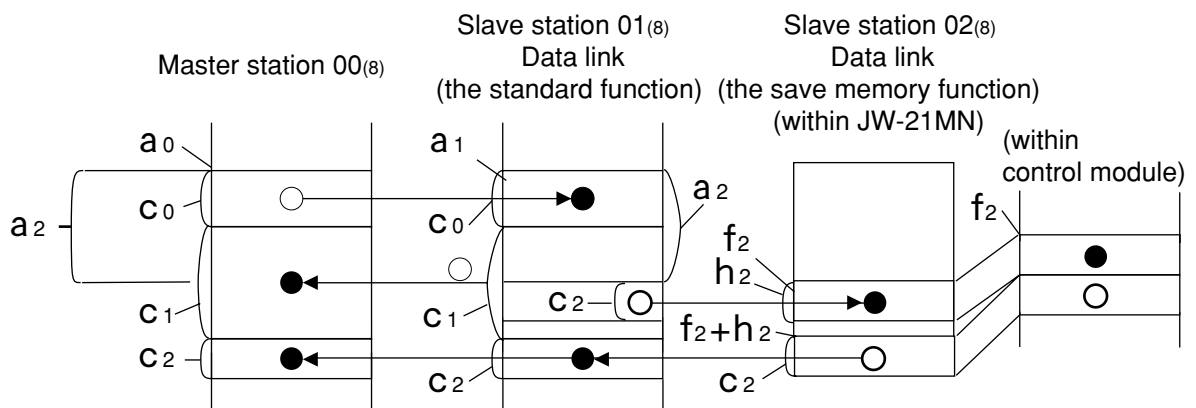

$$\left(\begin{array}{l} \text{Total number of bytes of relay link area } (C_0 + C_1 + C_2) \leq 256 \text{ bytes} \\ C_2 + h_2 \leq 64 \text{ bytes} \quad 0 \leq a_2 \leq C_0 + C_1 \end{array} \right)$$

- An example of register link area map for the setting of the data link (the save memory function) to slave station 01 and 03 and data link (the standard function) to slave station 02.

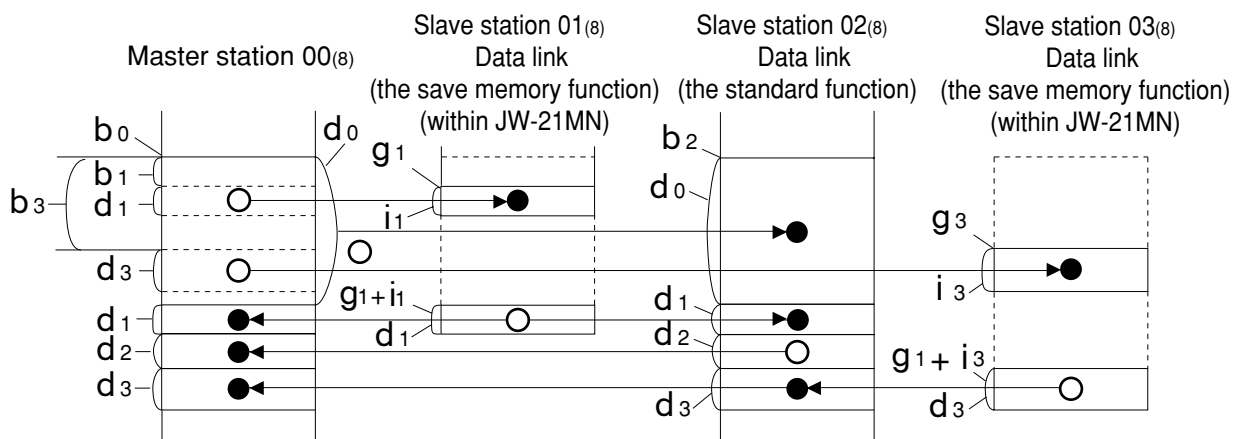

$$\left(\begin{array}{l} \text{Total number of bytes of register link area } (d_0 + d_1 + d_2 + d_3) \leq 2048 \text{ bytes} \\ 0 \leq b_1 \leq d_0 + d_2 + d_3 \quad 0 \leq b_3 \leq d_0 + d_1 + d_2 \\ i_1 + d_1 \leq 512 \quad i_3 + d_3 \leq 512 \end{array} \right)$$

[Example for setting]

The master station and slave station 01 and 02 are JW-21MN.

It shows example for setting that slave station 01 is data link (standard function) and slave station 02 is data link (save memory function with 30H mark).

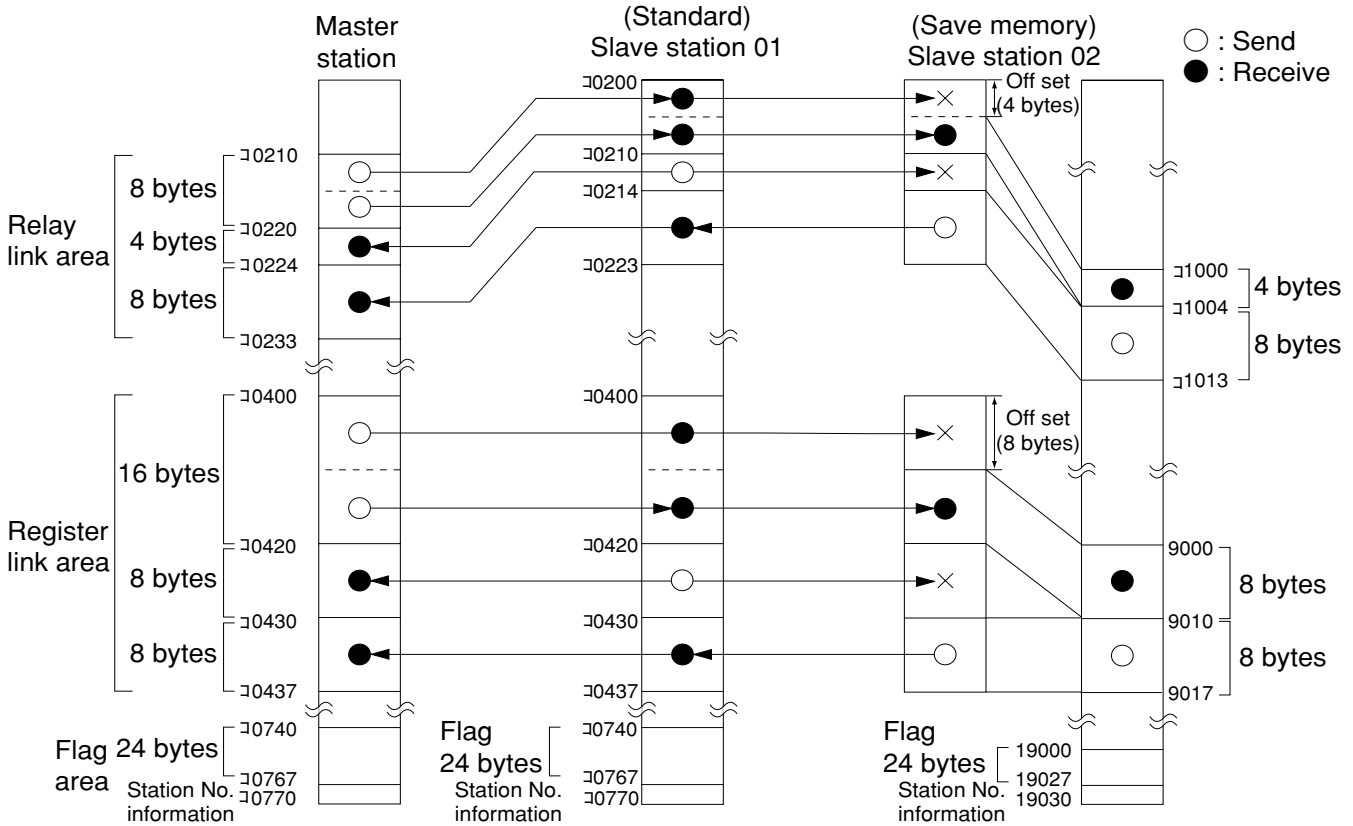

11

	Maser station	Slave station 1 (standard)	Slave station 2 (save memory)
Top address of relay link area	0210	0200	** 01000
Number of off set bytes of relay link area	-	-	4 bytes
Number of sending bytes of relay link	8 bytes	4 bytes	8 bytes
Number of receiving bytes of relay link	-	-	* 4 bytes
Top address of register link area	0400	0400	** 09000
Number of off set bytes of register link area	-	-	8 bytes
Number of sending bytes of register link	16 bytes	8 bytes	8 bytes
Number of receiving bytes of register link	-	-	* 8 bytes
Top address of flag area	0740	* 0740	* 19000
Station number information output	Yes	* Yes	* Yes

No mark -- Setting by parameter of master station
 * ----- Setting by parameter of slave station
 ** ----- Setting by module No. switch of slave station

[3] Setting range of relay link area, register link area, and flag area

For setting the top address of the master stations relay link, register link, and flag area, use the file address⁽⁸⁾ allocated throughout the memory area and set the number of sending bytes of the relay link and register link area within the setting range shown below. Flag areas are allocated by 24 bytes from each top address.

When a slave station is a JW-21MN and it is set to data link (the standard function), set the top address and the number of sending bytes of the slave station's relay link and register link area within the setting range shown below.

When a slave station is a JW-21MN and it is set to data link (the save memory function), the relay link and register link area of the slave station are determined by the setting value of the JW-21MN module No. switch (page 11-2) as shown below.

(1) When master station PC is JW20/JW20H

- When master and slave stations are JW-21MN and set to data link (the standard function) :

File address(8)		Byte address
000000	I / O relay	00000
000377		00377
000400	Auxiliary relay	00400
000677		00677
000700	Latched relay	00700
000777		00777
001000	General purpose relay	01000
001577		01577
001600	Time limited contact point of TMR/CNT	
001777		
002000	Current value of TMR/CNT/MD	b0000
003777		b1777
004000	Register	09000
004777		09777
005000	Register	19000
005777		19777
006000	Register	29000
006777		29777
007000	Register	39000
007777		39777
010000	Register	49000
010777		49777
011000	Register	59000
011777		59777
015000	Register	99000
015777		99777

Relay link area setting range

Register link area setting range

Flag area setting range

- When slave stations are JW-21MN and set to data link (the save memory function) :

File address(8)		Byte address
000000		00000
001000	Module No. 0	01000
	Module No. 1	01100
	Module No. 2	01200
	Module No. 3	01300
001477	Module No. 4	01400
001500		01500
003777		
004000	Module No. 0	09000
004777	Module No. 1	09777
005000	Module No. 2	19000
005777	Module No. 3	19777
006000	Module No. 4	29000
006777		29777
007000	Module No. 0	39000
007777	Module No. 1	39777
010000	Module No. 2	49000
010777	Module No. 3	49777
011000	Module No. 4	59000
015777		99777

Relay link area

Register link area

Flag area setting range

(2) When master station PC is JW30H

- When master and slave stations are JW-21MN and set to data link (the standard function) :

File address (8)		Byte address
000000	Relay	00000
001577		01577
001600	Time limited contact point of TMR/CNT 0000 to 0777	
001777		
002000	Current value of TMR/CNT/MD 0000 to 0777	b0000
003777		b1777
004000	Register	09000
007777		39777
010000	Register	49000
015777		99777
016000	Register	E0000
025777		E7777
026000	Current value of TMR/CNT 1000 to 1777	b2000
027777		b3777
030000	Relay	02000
035577		07577
035600	Time limited contact point of TMR/CNT 1000 to 1777	
035777		

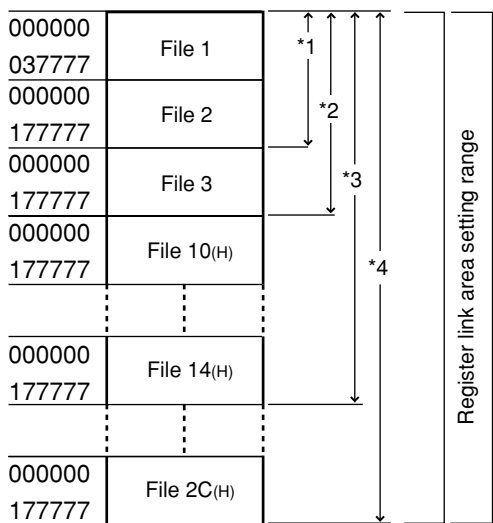

- When slave stations are JW-21MN and set to data link (the save memory function) :

File address (8)		Byte address
000000		00000
001000	Module No. 0	01000
	Module No. 1	01100
	Module No. 2	01200
	Module No. 3	01300
001477	Module No. 4	01400
001500		01500
003777		
004000	Module No. 0	09000
004777		09777
005000	Module No. 1	19000
005777		19777
006000	Module No. 2	29000
006777		29777
007000	Module No. 3	39000
007777		39777
010000	Module No. 4	49000
010777		49777
011000		59000
015777		99777
035777		

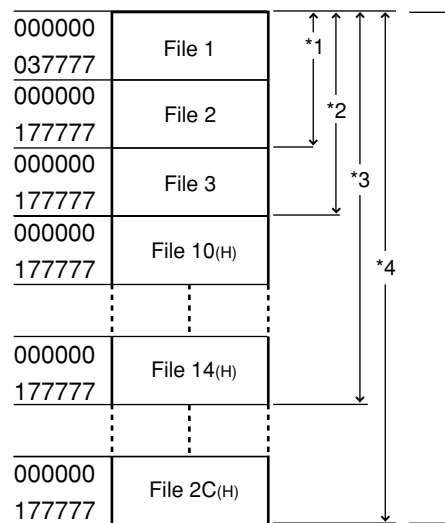

*1: When JW-32CUH/H1 is used (JW-32CUH1: 000000 to 177777 or 000000 to 077777).
 *2: When JW-33CUH/H1 is used.
 *3: When JW-33CUH2 is used.
 *4: When JW-33CUH3 is used.

[4] Setting procedure

Set parameters of the master station following the procedure below.

[] : See page in chapter 11

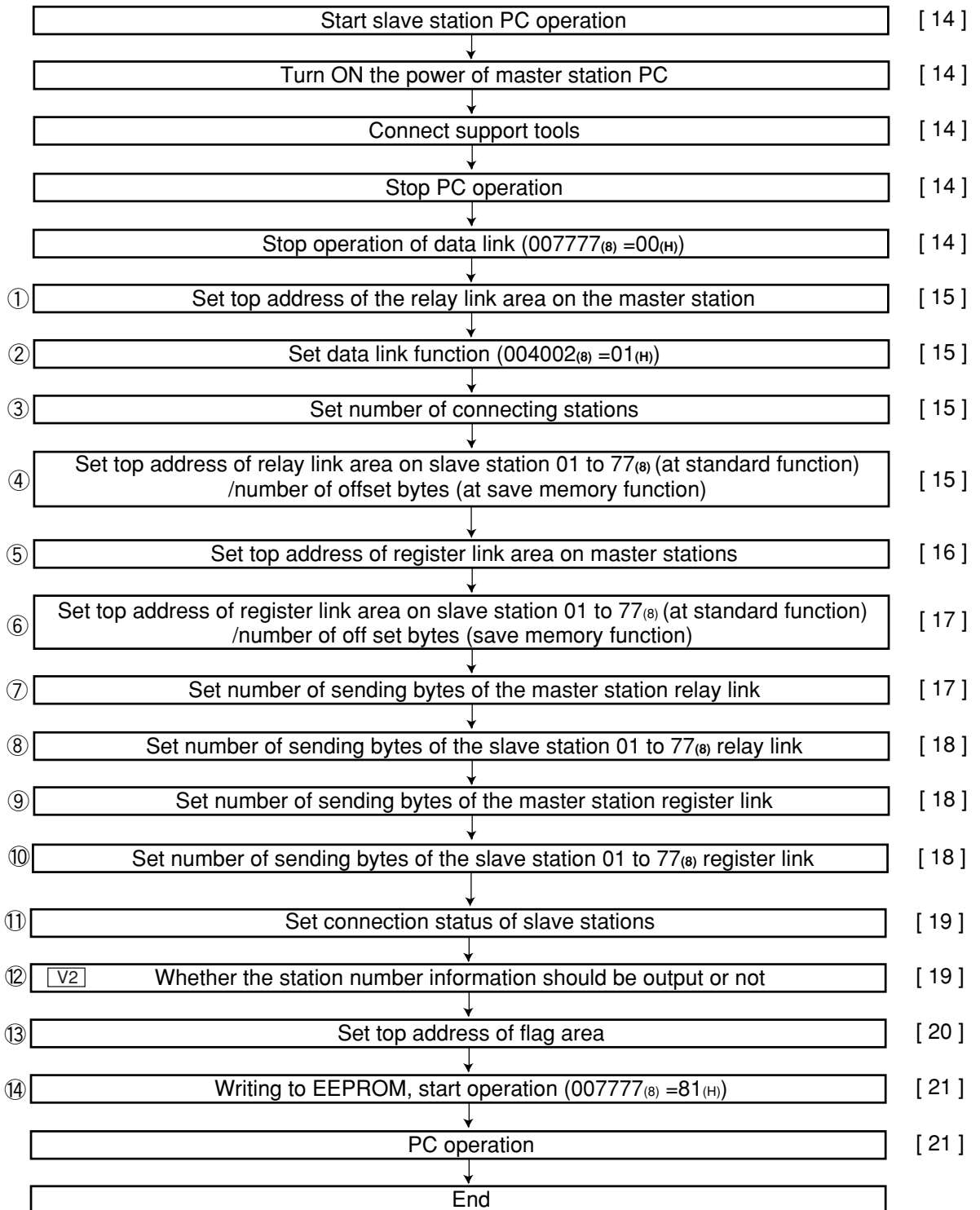

① to ⑭ are equivalent to number of page 11-5, and 11-6.

Indications in [] of each item mean as follows:

(Example) Stop operation of data link [HEX (hexadecimal), byte]

This means to set "stop operation" by hexadecimal and byte unit.

"Run" the slave station PC

Turn "ON" the power of the master station PC and connect support tools

Connect a support tool with the JW-21MN.

<Usable support tools>

JW-14PG/13PG/12PG

JW-50SP

JW-50PG, Z-100LP2S

- For operation of each support tool, see the instruction manual attached. **The following describes an example of JW-14PG's key operation.**

Note: Setting parameters is unavailable by JW-2PG.

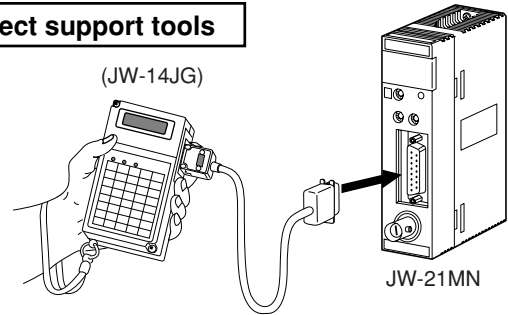

Stop PC operation

Turn to program mode (stop PC operation). Setting of parameters is only available when the PC is in program mode.

* * PROG MODE SET 8 → Stop PC operation

Select parameter setting mode.

クリア CLR * * シフト SHIFT INTL DISP SET 8 B 1
 Select initial mode (Set parameter)

Stop operation of data link [HEX (hexadecimal), byte]

Write "00_(H)" to parameter address 007777₍₈₎ and stop operation of the JW-21MN. Setting of the parameter is only available when the operation of the JW-21MN is stopped.

007777₍₈₎ 0 0_(H)

Screen display of JW-14PG

7 7 7 7 モニタ MNTR A 0 書込 ENT
 Display the contents of parameter address 007777 by hexadecimals. (Write 00_(H))

07775	HEX	00
07776	HEX	1F
I PARAM.		
>07777	HEX	00

Reference Function of JW-14PG

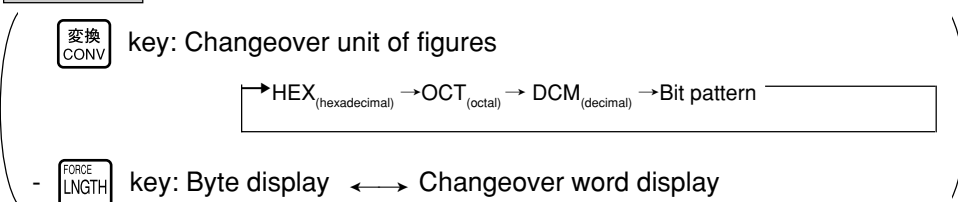

To the next page

From the previous page

Set top address of the relay link area on the master station [OCT (octal), word]

Set file address⁽⁸⁾ to parameter address 004000 to 004001⁽⁸⁾.
 - In case of setting 0210 (file address 000210⁽⁸⁾)
 (Example for page 11-10)

004000⁽⁸⁾ 004001⁽⁸⁾ 0 0 0 2 1 0 ⁽⁸⁾

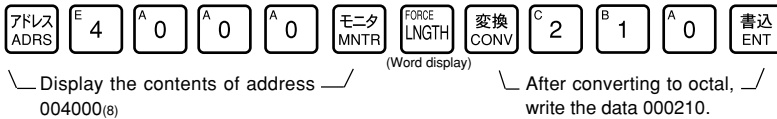

Screen display of JW-14PG

03774	0	000000
03776	0	000000
I PARAM.		
>04000	0	000210

Data link function setting [HEX (hexadecimal), byte]

Set "01^(H)" (=001⁽⁸⁾) in parameter address 004002⁽⁸⁾ and change to "relay/register link" function.

004002⁽⁸⁾ 0 1 ^(H)



Screen display of JW-14PG

04000	HEX	880
04001	HEX	00F
I PARAM.		
>04002	HEX	01

Set number of connecting stations [DCM (decimal), byte]

Set the number of connecting stations (02 to 64^(D)) including the master station in the parameter address 004003⁽⁸⁾ by octal.
 - In case of setting in 3 sets (003^(D)) (Example for page 11-10)

004003⁽⁸⁾ 0 0 3 ^(D)



Screen display of JW-14PG

04001	DCM	000
04002	DCM	001
I PARAM.		
>04003	DCM	003

Set top address of relay link area on slave station (01 to 77) (at standard function)/number of offset bytes (at save memory function)

Set in parameter addresses 004004 to 004377⁽⁸⁾. These top addresses should not overlap the register link area, flag area, or any area used by other option module.

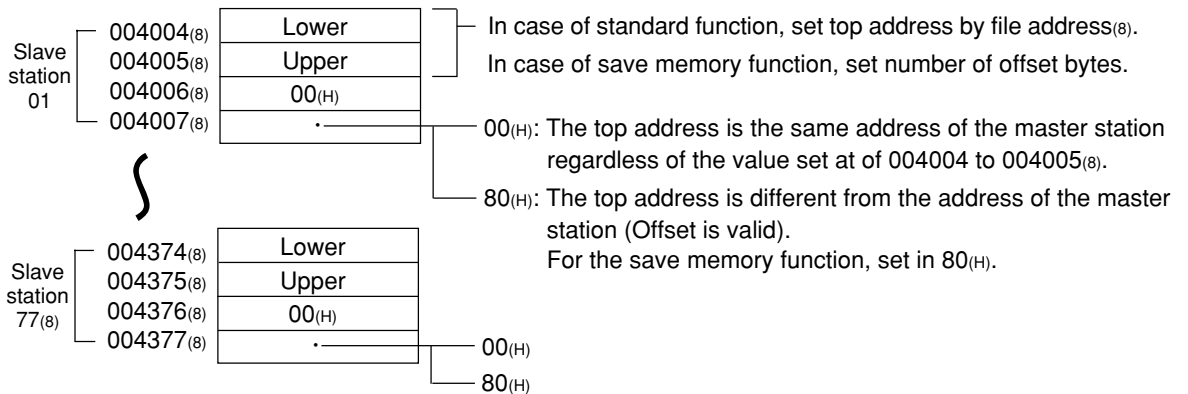

- In case of setting 0200 (file address 000200⁽⁸⁾) in parameter addresses 004004 to 004007⁽⁸⁾ (slave station 01) and set 4 (number of off set bytes) in 004010⁽⁸⁾ to 004013⁽⁸⁾ (slave station 02). (Example for page 11-10.)

To the next page

From the previous page

STEP (+) FORCE LNGLTH 変換 CONV 変換 CONV 変換 CONV C 2 A 0 A 0 書込 ENT → Write 000200₍₈₎ in parameter addresses 004004 to 004005₍₈₎.
(Word display) Convert to octal figures

Slave station 01
STEP (+) A 0 A 0 A 0 書込 ENT → Write 000₍₈₎ (=00_(H)) in parameter address 004006₍₈₎.

STEP (+) 変換 CONV 変換 CONV 変換 CONV SET 8 A 0 書込 ENT → Write 80_(H) (the top address is not same as the master station) in parameter address 004007₍₈₎.
Convert to hexadecimal figures

STEP (+) FORCE LNGLTH 変換 CONV 変換 CONV E 4 書込 ENT → Write 00004_(D) (offset 4) in parameter addresses 004010 to 004011₍₈₎.
(Word display)

Slave station 02
STEP (+) FORCE LNGLTH 変換 CONV 変換 CONV A 0 A 0 書込 ENT → Write 00_(H) in parameter address 004012₍₈₎.
(Byte display)

STEP (+) SET 8 A 0 書込 ENT → Write 80_(H) (offset valid) in parameter address 004013₍₈₎.

Screen display of JW-14PG

04011	HEX	00
04012	HEX	00
I PARAM.		
>04013	HEX	80

Slave station 01	004004 ₍₈₎	000200 ₍₈₎
	004005 ₍₈₎	000200 ₍₈₎
	004006 ₍₈₎	00 _(H)
	004007 ₍₈₎	80 _(H)
Slave station 02	004010 ₍₈₎	000004 _(D)
	004011 ₍₈₎	000004 _(D)
	004012 ₍₈₎	00 _(H)
	004013 ₍₈₎	80 _(H)

Set top address of register link area on the master station

Set on the parameter address (004400 to 004403₍₈₎) in the file address₍₈₎. These top addresses should not overlap the relay link area, flag area, or any area used by other option modules.

004400 ₍₈₎	Lower	File address ₍₈₎
004401 ₍₈₎	Upper	
004402 ₍₈₎	File number	
004403 ₍₈₎	Unused (00 _(H))	

- In case of setting 00400 (file address 000400₍₈₎) in parameter addresses 004400 to 004403₍₈₎ and set 0 (file number) in 004402₍₈₎. (Example for page 11-10).

アドレス ADRS E 4 E 4 A 0 A 0 モニタ MNTR → Display the contents of parameter addresses 004400 to 004401₍₈₎

変換 CONV E 4 A 0 A 0 書込 ENT → Write 000400₍₈₎

STEP (+) A 0 書込 ENT → Write 000₍₈₎ (=00_(H)) in parameter address 004402₍₈₎.

Screen display of JW-14PG

04400	OCT	000
04401	OCT	001
I PARAM.		
>04402	OCT	000

004400 ₍₈₎	000400 ₍₈₎
004401 ₍₈₎	000400 ₍₈₎
004402 ₍₈₎	00 _(H)
004403 ₍₈₎	Unused (00 _(H))

To the next page

From the previous page

Set top address of register link area on slave station 01 to 77⁽⁸⁾ (at standard function)/number of offset bytes (at save memory function)

Set in parameter addresses 004404 to 004777⁽⁸⁾. These top addresses should not overlap the register link area, flag area, or any area used by other option module.

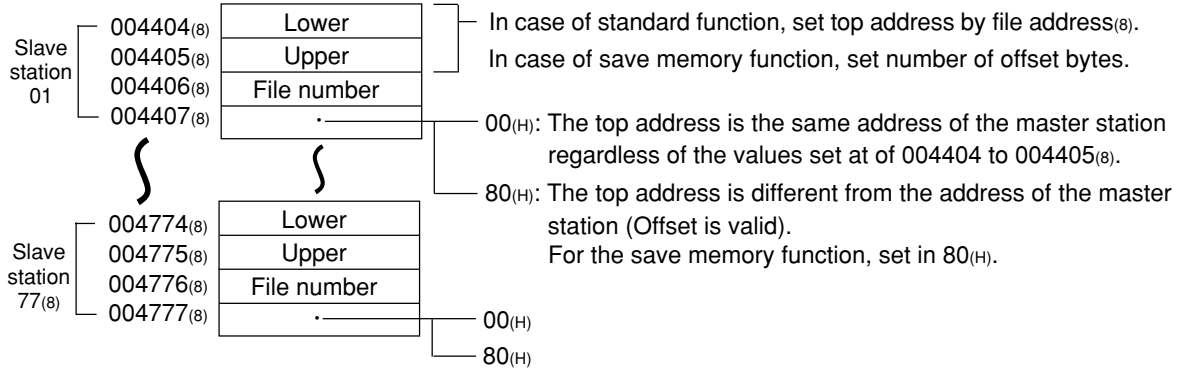

- In case of setting 0 (the top address is 00440, the same as the address of the master station) in parameter addresses 004404 to 004407⁽⁸⁾ (slave station 01) and the offset byte number 8 and "offset valid" on the parameter address 004410 to 004413⁽⁸⁾ (slave station 02). (Example for 11-10)

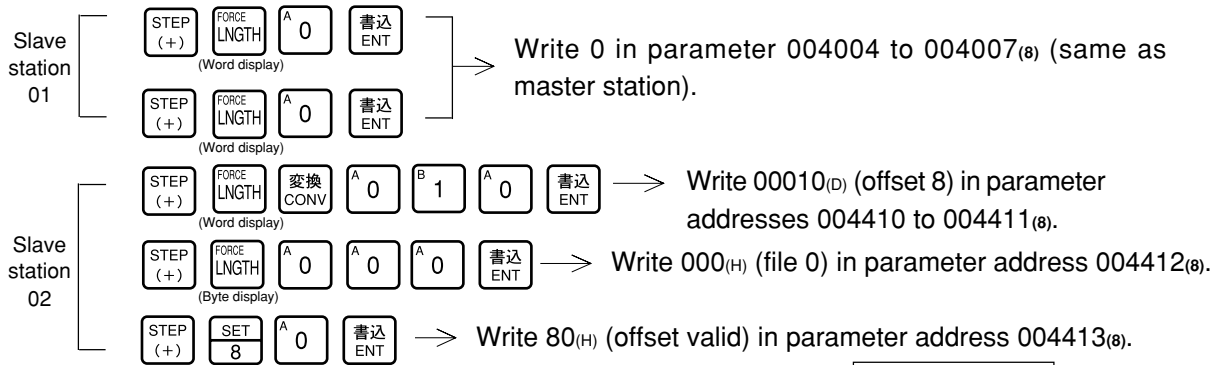

Screen display of JW-14PG

04011	HEX	00
04012	HEX	00
I PARAM.		
>04013	HEX	80

Slave station 01	004404 ⁽⁸⁾	0000 ^(H)
	004405 ⁽⁸⁾	
	004406 ⁽⁸⁾	00 ^(H)
	004407 ⁽⁸⁾	00 ^(H)
Slave station 02	004410 ⁽⁸⁾	0008 ^(D)
	004411 ⁽⁸⁾	
	004412 ⁽⁸⁾	00 ^(H)
	004413 ⁽⁸⁾	80 ^(H)

Set the number of sending bytes of the master station relay link [DCM (decimal), word]

Set in parameter addresses 005000 to 005001⁽⁸⁾.



These top addresses should not overlap the register link area, or the flag area, or exceed the setting range (0 to 256 bytes for each station, 256 bytes for all stations in total).

- In case of setting 8 bytes (Example for page 11-10)

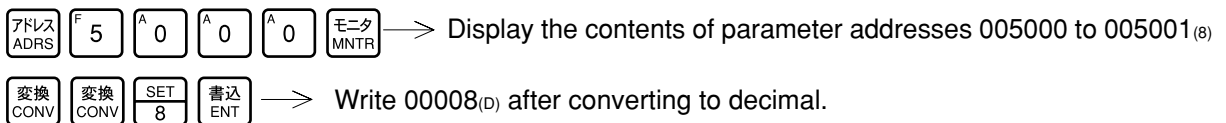

Screen display of JW-14PG

04774	D	00000
04776	D	00000
I PARAM.		
>05000	D	00008

005000 ⁽⁸⁾	00008 ^(D)
005001 ⁽⁸⁾	

To the next page

From the previous page

Set the number of sending bytes of the slave station (01 to 77) relay link [DCM (decimal), word]

Set the number of sending bytes in decimal on the parameter addresses 005002 to 005177⁽⁸⁾. (set in each station, 2 bytes for each station).
 These top addresses should not overlap the resister link area, or the flag area, or exceed the setting range (0 to 256 bytes for each station, 256 bytes for all stations in total).

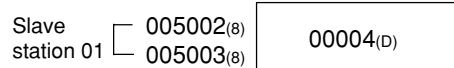
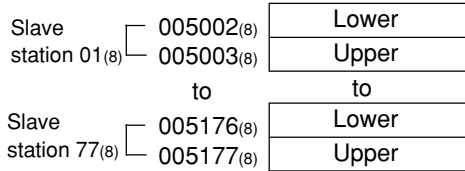

- In case of setting 4 bytes for parameter addresses 005002 to 005003⁽⁸⁾ (slave station 01), and set 8 bytes for parameter addresses 005004 to 005005⁽⁸⁾ (slave station 02). (Example for page 11-10)

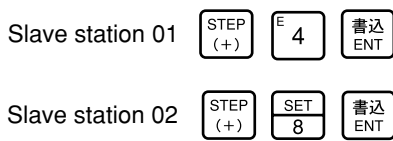
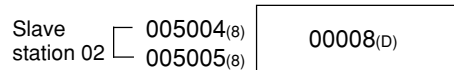

Write 00004^(D) in parameter addresses 005002 to 005003⁽⁸⁾.
 Write 00008^(D) in parameter addresses 005004 to 005005⁽⁸⁾.

Screen display of JW-14PG

05000	D	00008
05002	D	00004
I PARAM.		
>05004	D	00008

Set the number of sending bytes of the master station register link [DCM (decimal), word]

Set the number of sending bytes in decimal on the parameter addresses 005200 to 005201⁽⁸⁾.
 These top addresses should not overlap the relay link area or the flag area, or exceed the setting value (0 to 2048 bytes for each station, 2048 bytes for all stations in total).

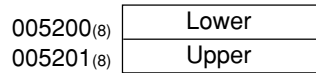

- In case of setting 16 bytes for parameter addresses 005200 to 005201⁽⁸⁾. (Example for page 11-10)

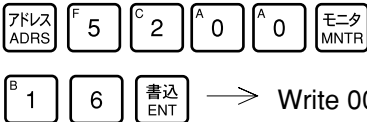

Display the contents of parameter addresses 005200 to 005201⁽⁸⁾.
 Screen display of JW-14PG

05174	D	00000
05176	D	00000
I PARAM.		
>05200	D	00016

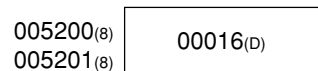

Set the number of sending bytes of the slave station (01 to 77) register link [DCM (decimal), word]

Set the number of sending bytes in decimal on the parameter addresses 005202 to 005377⁽⁸⁾. (set in each station, 2 bytes for each station).
 These top addresses should not overlap the relay link area, or the flag area, or exceed the setting range (0 to 2048 bytes for each station, 2048 bytes for all stations in total).

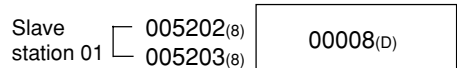
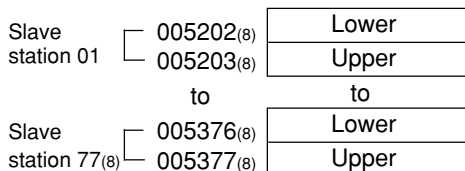

- In case of setting 8 bytes for parameter addresses 005202 to 005203⁽⁸⁾ (slave station 01), and set 8 bytes for parameter addresses 005204 to 005205⁽⁸⁾ (slave station 02). (Example for page 11-10)

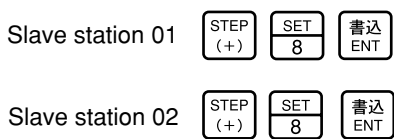
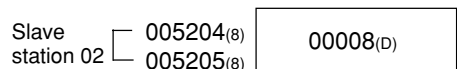

Write 00008^(D) in parameter addresses 005202 to 005203⁽⁸⁾.
 Write 00008^(D) in parameter addresses 005204 to 005205⁽⁸⁾.

Screen display of JW-14PG

05200	D	00016
05202	D	00008
I PARAM.		
>05204	D	00008

To the next page

From the previous page

Set connection status of slave station [bit pattern, byte]

Set "connected slave station as 01 and 02, output error code" in parameter address 007750⁽⁸⁾.

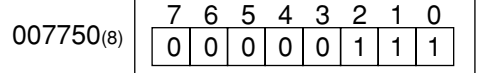

→ Display the contents of parameter address 007750⁽⁸⁾



→ Turn "ON" bit 0 (output error code)

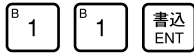

→ Turn "ON" bits 1 and 2 (connects slave station 01 and 02)

Screen display of JW-14PG

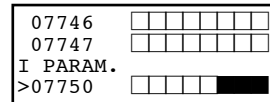

V2 Set whether the station number information should be output or not

Set whether the station number information should be output or not on the parameter address 007763⁽⁸⁾.

007763⁽⁸⁾

Whether the station number information should be output or not

00^(H): Do not output

01^(H): Output

The station number information is output on the next byte of the flag area (24 bytes.)

This setting is valid when the parameter address is 007767⁽⁸⁾ = 80^(H).

To the next page

From the previous page

Set top address of flag area

File address: OCT (octal), word
File number/flag: HEX (hexadecimal), byte

Set the top address of the flag area (24 bytes) in order to monitor the communication condition and PC operation condition on the parameter address 007764 to 007767⁽⁸⁾.
 Flag area uses 24 bytes regardless number of connecting stations.

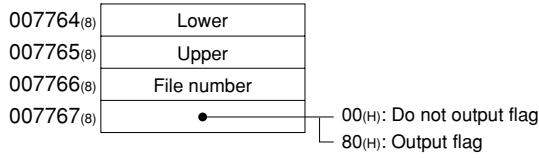

- In case of setting 0740 (file address 000740⁽⁸⁾), "output flag" in parameter address 007764 to 007767⁽⁸⁾. (Example for page 11-10)

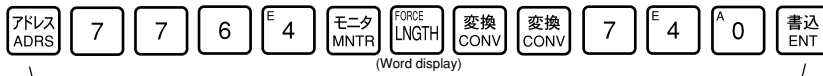

Write "000740⁽⁸⁾" in parameter addresses 007764 to 007765⁽⁸⁾.

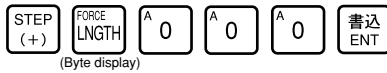

Write 000⁽⁸⁾ (=00^(H)) in parameter address 007766⁽⁸⁾.



Covert to hexadecimal figures

Write 80^(H) in parameter address 007767⁽⁸⁾.

Screen display of JW-14PG

07765	HEX	01
07766	HEX	00
I PARAM.		
>07767	HEX	80

007764 ⁽⁸⁾	000740 ⁽⁸⁾
007765 ⁽⁸⁾	000740 ⁽⁸⁾
007766 ⁽⁸⁾	00 ^(H)
007767 ⁽⁸⁾	80 ^(H)

To the next page

From the previous page

Writing to the EEPROM of the JW-21MN, start operation [HEX (hexadecimal), byte]

Write "81_(H)" into parameter address 007777₍₈₎ and write the set parameter contents into the EEPROM of the JW-21MN. Then start the JW-21MN. After starting operation, the setting value changes to "01_(H)."

Setting value _(H)	Contents
0 0	Stop operation of the JW-21MN
0 1	Start operation of the JW-21MN
8 0	Writing to the EEPROM of the JW-21MN, stop operation
8 1	Writing to the EEPROM of the JW-21MN, start operation
0 8	Initialize setting values of parameter addresses 004000 to 007777 ₍₈₎

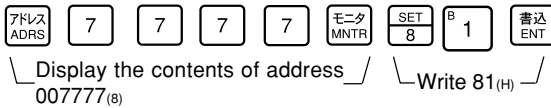

Screen display of JW-14PG

07775	HEX	01
07776	HEX	00
I PARAM.		
>07777	HEX	80

- Writing time to EEPROM is approximately 0.7 sec. When any error is found for parameter settings, the JW-21MN lights the error code (6F_(H)) by the indication lamp. To recover from this condition, see pages 16-2.
- Written contents into the EEPROM are automatically written to the RAM of the JW-21MN when turning ON the power of the PC. At reading, the PC checks BCC and compares BCC check code of the parameter memory address (007776₍₈₎). When an error is found, the JW-21MN lights the error code (6E_(H)) by the indication lamp.

PC operation

Turning a master station PC to monitor or change mode (PC operation).

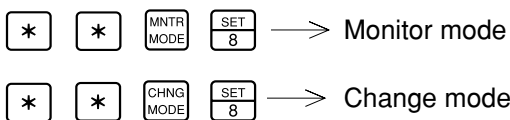

Screen display of JW-14PG

C00000
>

11-4 Setting slave station parameters (common for all slave stations)

When the JW-21MN is used as a slave station, set the following items for parameters.

[1] Setting contents

	Setting item	Address ⁽⁸⁾	Initial value ^(H)	Contents	Corresponding signs on pages 11-7 to 11-9
*1	① Number of receiving bytes of relay link in save memory function [V2]	007720 007721	00	Set the number of bytes by decimals. (0 to 256) - If 0 is set, the number of bytes will be the same as the number of the sending bytes which is set in the master station	h_1 to h_n
	② Number of receiving bytes of register link in save memory function [V2]	007722 007723	00	Set the number of bytes by decimals. (0 to 2048) - If 0 is set, the number of bytes will be the same as the number of the sending bytes which is set in the master station	i_1 to i_n
*2	③ Whether the station number information should be output or not [V2]	007763	00	Store the number of own station in the data memory when setting on 01 ^(H) . (storage area of 1 byte follows flag area of 24 bytes, valid when 007767 ⁽⁸⁾ is 80 ^(H))	—
	④ Top address of flag area (communication and PC operation condition monitor flag)	007764	E0	Lower of file address	e_1 to e_n
		007765	01	Upper of file address	
		007766	00	File number	
		007767	80	Flag output (Yes: 80 ^(H) No: 00 ^(H))	
	⑤ - Start/stop operation of the JW-21MN - Writing to EEPROM of the JW-21MN	007777	01	00 ^(H) : Stop operation	—
				01 ^(H) : Start operation	
				80 ^(H) : Writing to the EEPROM, stop operation	
				81 ^(H) : Writing to the EEPROM, start operation	
				08 ^(H) : Parameter initializing	

*1: Set only when the memory capacity save function is used.

*2: "Whether the station number information should be output or not" is a unique function of the JW-21MN.

- Parameter addresses other than above mentioned are reserved areas and prohibited to be changed.
- When any slave stations are except JW-21MN, see the instruction manual of each device.

[2] Setting range of flag area

Flag areas are allocated by 24 bytes from each top address. For setting the top address of flag area, use the file address⁽⁸⁾ allocated throughout the memory area and set within the setting range shown below.

• When PC is JW20/JW20H

File address ⁽⁸⁾		Byte address
000000	I/O Relay	00000
000377		00377
000400	Auxiliary relay	00400
000677		00677
000700	Latched relay	00700
000777		00777
001000	General purpose relay	01000
001577		01577
001600	Time limited contact point of TMR/CNT/MD	
001777		
002000	Current value of TMR/CNT/MD	b0000
003777		b1777
004000	Register	09000
004777		09777
005000	Register	19000
005777		19777
015000	Register	99000
015777		99777

Flag area setting range

• When PC is JW30H

File address ⁽⁸⁾		Byte address
000000	Relay	00000
001577		01577
001600	Time limited contact point of TMR/CNT 0000 to 0777	
001777		
002000	Current value of TMR/CNT/MD 0000 to 0777	b0000
003777		b1777
004000	Register	09000
007777		39777
010000	Register	49000
015777		99777
016000	Register	E0000
025777	Current value of TMR/CNT/MD 1000 to 1777	E7777
026000		b2000
027777	Relay	b3777
030000		032000
035577	Time limited contact point of TMR/CNT 1000 to 1777	037577
035600		
035777		

Flag area setting range

000000	File 1	*1	↑
037777			
000000	File 2	*2	↑
177777			
000000	File 3	*3	↑
177777			
000000	File 10 _(H)	*4	↑
177777			
000000	File 14 _(H)		↑
177777			
000000	File 2C _(H)		↑
177777			

Flag area setting range

*1: When JW-32CUH/H1 is used (JW-32CUH1: 000000 to 177777 or 000000 to 077777).

*2: When JW-33CUH/H1 is used.

*3: When JW-33CUH2 is used.

*4: When JW-33CUH3 is used.

Flag area setting range of data link (standard function) is same as data link (save memory function).

[3] Setting procedure

[] : See page in chapter 11

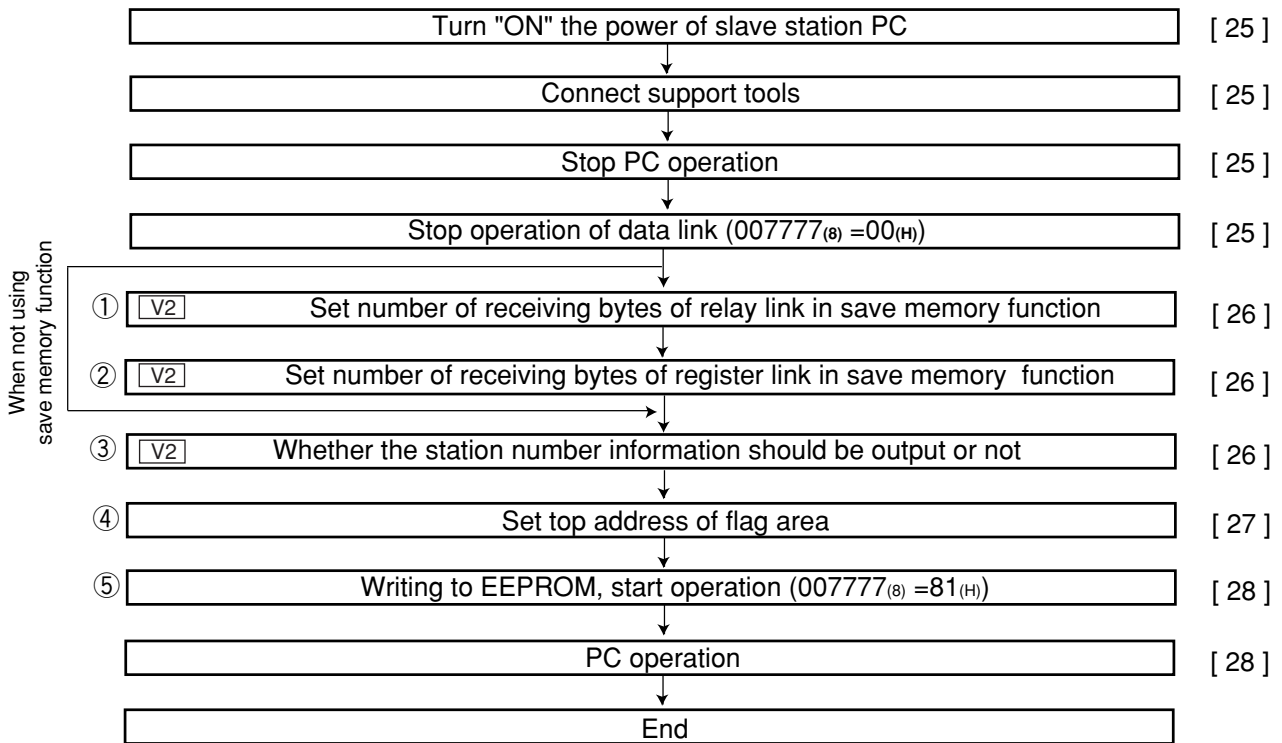

① to ⑤ are equivalent to number of page 11- 22.

Indications in [] of each item mean as follows:

(Example) Stop operation of data link [HEX (hexadecimal), byte]

This means to set "stop operation" by hexadecimal and byte unit.

Turn "ON" the power of slave station PC

Connect support tools

Connect a support tool with the JW-21MN.

<Usable support tools>

JW-14PG/13PG/12PG

JW-50SP

JW-50PG, Z-100LP2S

- For operation of each support tool, see the instruction manual attached. **The following describes an example of JW-14PG's key operation.**

Note: Setting parameters is unavailable by JW-2PG.

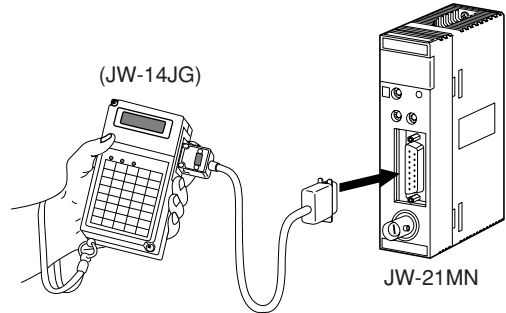

Stop PC operation

Turn to program mode (stop PC operation). Setting of parameters is only available when the PC is in program mode.

* * PROG MODE SET 8 → Stop PC operation

Select parameter setting mode.

クリア CLR * * シフト SHIFT INTL DISP SET 8 B 1
 \ Select initial mode / (Set parameter)

Stop operation of data link [HEX (hexadecimal), byte]

Write "00^(H)" to parameter address 007777⁽⁸⁾ and stop operation of the JW-21MN. Setting of the parameter is only available when the operation of the JW-21MN is stopped.

007777⁽⁸⁾ 00^(H)

7 7 7 7 モニタ MNTR A 0 書込 ENT
 \ Display the contents of parameter / (Write 00^(H). address 007777 by hexadecimals.)

Screen display of JW-14PG

07775	HEX	00
07776	HEX	1F
I PARAM.		
>07777	HEX	00

Reference Function of JW-14PG

- 変換 CONV key: Changeover unit of figures
 → HEX (hexadecimal) → OCT (octal) → DCM (decimal) → Bit pattern
- FORCE LNPTH key: Byte display ↔ Changeover word display

To the next page

From the previous page

"Only when using save memory function"

V2 Set the number of sending bytes of the relay link in save memory function [DCM (decimal), word]

Set the number of sending bytes in decimal on the parameter address 007720 to 007721⁽⁸⁾.

007200 ⁽⁸⁾	Lower
007721 ⁽⁸⁾	Upper

- In case of setting 4 bytes (Example for page 11-10)

アドレス ADRS 7 7 C 2 A 0 モータ MNTR →

Display the contents of parameter addresses 007720 to 007721⁽⁸⁾

変換 CONV 4 書込 ENT →

Write 00004^(D) after converting to decimal

Screen display of JW-14PG

07714	D	00000
07716	D	00000
I PARAM.		
>07720	D	00004

007720 ⁽⁸⁾	00004 ^(D)
007721 ⁽⁸⁾	

"Only when using save memory function"

V2 Set the number of receiving bytes of register link in save memory function [DCM (decimal), word]

Set the number of sending bytes in decimal on the parameter address 007722 to 007723⁽⁸⁾.

007722 ⁽⁸⁾	Lower
007723 ⁽⁸⁾	Upper

- In case of setting 8 bytes for parameter addresses 007722 to 007723⁽⁸⁾. (Example for page 11-10)

アドレス ADRS 7 7 C 2 C 2 モータ MNTR →

Display the contents of parameter addresses 007722 to 007723⁽⁸⁾

SET 8 書込 ENT →

Write 00008^(D)

Screen display of JW-14PG

07716	D	00000
07720	D	00000
I PARAM.		
>07722	D	00008

007722 ⁽⁸⁾	00008 ^(D)
007723 ⁽⁸⁾	

V2 Set whether the station number information should be output or not

Set whether the station number information should be output or not on the parameter address 007763⁽⁸⁾.

007763⁽⁸⁾

Whether the station number information should be output or not

00^(H): Do not output

01^(H): Output

The station number information is output on the next byte of the flag area (24 bytes.)

This setting is valid when the parameter address is 007767⁽⁸⁾ = 80^(H).

To the next page

From the previous page

Set top address of flag area

File address: OCT (octal), word
File number/flag: HEX (hexadecimal), byte

Set the top address of the flag area (24 bytes) in order to monitor the communication condition and PC operation condition on the parameter address 007764 to 007767⁽⁸⁾.
Flag area uses 24 bytes regardless number of connecting stations.

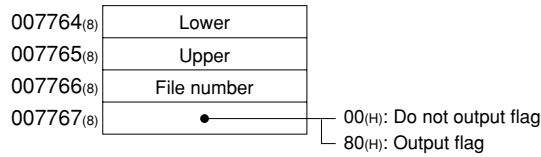

- In case of setting 00740 (file address 000740⁽⁸⁾), "output flag" in parameter address 007764 to 007767⁽⁸⁾. (Slave station 01 of page 11-10)



Write "000740⁽⁸⁾" in parameter addresses 007764 to 007765⁽⁸⁾.

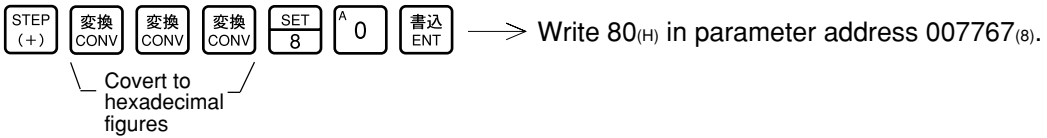
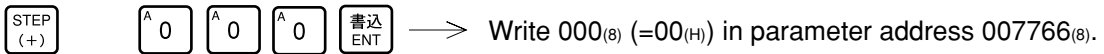

Screen display of JW-14PG

07765	HEX	01
07766	HEX	00
I PARAM.		
>07767	HEX	80

007764 ⁽⁸⁾	000740 ⁽⁸⁾
007765 ⁽⁸⁾	
007766 ⁽⁸⁾	00 ^(H)
007767 ⁽⁸⁾	80 ^(H)

To next page

From the previous page

Writing to the EEPROM of the JW-21MN, start operation [HEX (hexadecimal), byte]

Write "81(H)" into parameter address 007777₍₈₎ and write the set parameter contents into the EEPROM of the JW-21MN. Then start the JW-21MN. After starting operation, the setting value changes to "01(H)."

Setting value _(H)	Contents
0 0	Stop operation of the JW-21MN
0 1	Start operation of the JW-21MN
8 0	Writing to the EEPROM of the JW-21MN, stop operation
8 1	Writing to the EEPROM of the JW-21MN, start operation
0 8	Initialize setting values of parameter addresses 004000 to 007777 ₍₈₎



Display the contents of address 007777₍₈₎ / Write 81_(H)

Screen display of JW-14PG

07775	HEX	00
07776	HEX	36
I PARAM.		
>07777	HEX	81

- Writing time to EEPROM is approximately 0.7 sec. When any error is found for parameter settings, the JW-21MN lights the error code (6F_(H)) by the indication lamp. To recover from this condition, see pages 16-2.
- Written contents into the EEPROM are automatically written to the RAM of the JW-21MN when turning ON the power of the PC. At reading, the PC checks BCC and compares BCC check code of the parameter memory address (007776₍₈₎). When an error is found, the JW-21MN lights the error code (6E_(H)) by the indication lamp.

PC operation

Turning a slave station PC to monitor or change mode (PC operation).

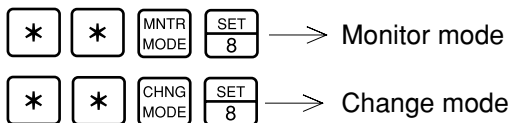

Screen display of JW-14PG

C00000
>

Chapter 12: Errors and Countermeasures

The operating condition of the JW-21MN can be monitored using its indication lamps, flags, and the system memory of a PC.

12-1 Indication lamps

LED name	Details	Measure
CM	Lights during data link operation	————
SD	Lights while sending data	————
RD	Lights while receiving data	————
CD	Lights when detecting carrier	————
LT	Lights when turning "ON" the termination resistance	————
T	Lights during testing (TEST)	————
COM.E	Lights at a communication error (COM. E)	- Check disconnection of the communication cable - Check the set contents of switches - Check the set contents of parameters - Check the power voltage of PC
UNT.E	Lights at time up of the watchdog timer	Replace the JW-21MN

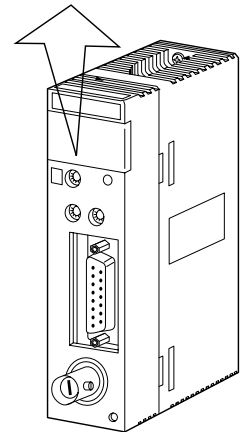
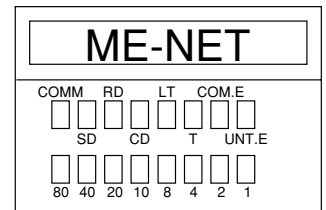

LED "1" to "80" indicate error codes when an error occurs. Error codes, their causes, and measures are as shown in the table below.

LED name								Error code (DEC)	Cause	Measure
80	40	20	10	8	4	2	1			
○	○	○	○	○	○	○	●	01	ROM error, upper CPU	Replace the JW-21MN
○	○	○	○	○	○	○	●	02	RAM error, upper CPU	
○	○	○	○	○	○	●	●	03	2 port RAM error against PC, upper CPU	
○	○	○	○	○	●	○	○	04	2 port RAM error against communication CPU, upper CPU	
○	○	○	●	○	○	○	●	11	ROM error, communication CPU	- Check the communication cable - Check for doubled allocation of station number - Replace the JW-21MN
○	○	○	●	○	○	●	○	12	RAM error, communication CPU	
○	○	○	●	●	○	○	○	18	Communication LSI error, communication CPU	
○	○	○	●	●	●	●	●	1F	No response, communication CPU	
○	○	●	○	○	○	○	○	20	More than one token detected	Check the parameter setting
○	○	●	○	○	○	○	●	21	Doubled address detected	Replace the JW-21MN
○	○	●	○	○	○	●	○	22	Fault of sending section	
○	○	●	○	○	○	●	●	23	Token does not return within the rated interval	Check the communication cable
○	○	●	○	●	○	●	○	2A	Over flow of receiving buffer.	————
○	○	●	○	●	○	●	●	2B	Flame length error	Check the communication cable
○	○	●	●	○	○	○	○	30	EEPROM error	Replace the JW-21MN
○	●	●	○	○	○	○	○	*60	Switch setting error	Check the switch setting
○	●	●	○	●	●	●	○	*6E	BCC error	Check the parameter setting
○	●	●	○	●	●	●	●	6F	Parameter setting error	
●	●	○	○	○	○	○	●	*C1	Communication error	Check the communication cable and slave module
to								to	- After converting into octal, the lower two digits represent the slave station number of the current error. (Ex. C1(H) = 301(8) = slave station 01)	
●	●	●	●	●	●	●	●	*FF		

● : ON, ○ : OFF

* Error code 60_(H), 6E_(H), C1 to FF_(H) are special error codes unique to the JW-21MN. Other codes are error codes specified by the ME-NET. Prior to displaying the error code C1 to FF_(H), the setting of the parameter addresses 007750 to 007757₍₈₎ is required. (See page 16-12.)

12-2 Flag

Flag area is 24 bytes from the "flag top address" set in the master station/slave station parameters.

[1] Flag table [In case of flag top address is 30740 (initial value)]

	7	6	5	4	3	2	1	0	
30740	07	06	05	04	03	02	01	00	Master station
30741	17	16	15	14	13	12	11	10	
30742	27	26	25	24	23	22	21	20	
30743	37	36	35	34	33	32	31	30	
30744	47	46	45	44	43	42	41	40	
30745	57	56	55	54	53	52	51	50	
30746	67	66	65	64	63	62	61	60	Slave station 70 ₍₈₎
30747	77	76	75	74	73	72	71	70	
30750	07	06	05	04	03	02	01	00	Master station
30751	17	16	15	14	13	12	11	10	Slave station 01 ₍₈₎
30752	27	26	25	24	23	22	21	20	
30753	37	36	35	34	33	32	31	30	
30754	47	46	45	44	43	42	41	40	
30755	57	56	55	54	53	52	51	50	
30756	67	66	65	64	63	62	61	60	Slave station 70 ₍₈₎
30757	77	76	75	74	73	72	71	70	
30760	07	06	05	04	03	02	01	00	Master station
30761	17	16	15	14	13	12	11	10	Slave station 01 ₍₈₎
30762	27	26	25	24	23	22	21	20	
30763	37	36	35	34	33	32	31	30	
30764	47	46	45	44	43	42	41	40	
30765	57	56	55	54	53	52	51	50	
30766	67	66	65	64	63	62	61	60	
30767	77	76	75	74	73	72	71	70	Slave station 70 ₍₈₎

① Communication monitor flag

② Operation condition monitor flag [1]

③ Operation condition monitor flag [2]

Remark

- Even a slave station can monitor 24 bytes of flag.

[2] In the case of a master station

(1) Communication monitor flag

This flag is used to monitor the communication condition with other stations. Non-connected station keeps this flag as "OFF."

Flag	Condition for flag operation	Flag operation
Own station flag (master station)	When the parameter address 007777 ⁽⁸⁾ of the master station is set to "01 ^(H) ," and the master station is operating normally.	ON
	When the parameter address 007777 ⁽⁸⁾ of the master station is set to "00 ^(H) ," Improper setting of parameter, BCC check error, or other errors.	OFF

Flag	Condition for flag operation	Flag operation	
Other station's flag (01 to 77)	Normal communication with slave stations.	ON	Specific slave station
	Stopped communication or unable to communicate with slave stations.	OFF	
	Communication monitor flag (1) of the master station is turned "OFF."		All slave stations

The master station periodically executes communication recovery operation with the communication error slave station. When the error situation is recovered, the master station returns to normal communication.

(2) Operation condition monitor flag [1]

This flag is used to monitor the operation condition of slave stations when the communication with each slave station is normal.

Non-connected station keeps this flag as "OFF."

Flag	Condition for flag operation	Flag operation
Own station flag (master station)	Communication monitor flag (1) of the master station is turned "ON."	* ON
	Communication monitor flag (1) of the master station is turned "OFF."	OFF

Flag	Condition for flag operation	Flag operation	
Other station's flag (01 to 77)	Slave station is operating.	ON	Specific slave station
	Slave station stops operation (not by an error cause).	OFF	
	Communication monitor flag (1) of the master station is turned "OFF."		All slave stations
	Slave station that communication monitor flag (1) is turned to "OFF."	Not specified	

* Even if a master station PC has stopped operation normally or by an error, the JW-21MN turns "ON" this flag while communicating.

(3) Operation condition monitor flag [2]

This flag is used to monitor the abnormal stop of each slave station when the communication with each slave station is normal.

Non-connected station keeps this flag as "OFF."

Flag	Condition for flag operation	Flag operation
Own station flag (master station)	Communication monitor flag (1) of the master station is turned "ON."	* ON
	Communication monitor flag (1) of the master station is turned "OFF."	OFF

Flag	Condition for flag operation	Flag operation	
Other station's flag (01 to 77)	Each slave station is normal.	ON	Specific slave station
	Any of the slave stations is faulty (caused to be stopped abnormally).	OFF	
	Communication monitor flag (1) of the master station is turned "OFF."		All slave stations
	Slave station that communication monitor flag (1) is turned to "OFF."	Not specified	

* Even if a master station PC has stopped operation normally or by an error, the JW-21MN turns "ON" this flag while communicating.

[3] In the case of slave station 01 to 77⁽⁸⁾

(1) Communication monitor flag

This flag is used to monitor the communication condition with other stations. Non-connected station keeps this flag as "OFF."

Flag	Condition for flag operation	Flag operation
Own station flag	When the parameter address 007777 ⁽⁸⁾ of each slave station is set to "01 ^(H) ," and at communicating with a master station normally.	ON
	When the parameter address 007777 ⁽⁸⁾ of each slave station is "00 ^(H) ."	OFF
	When link start switch "00 ^(H) " of the master station is OFF.	

Flag	Condition for flag operation	Flag operation	
Other station's flag	Normal communication with each station.	ON	Specific station
	Stopped communication or unable to communication with each station.	OFF	
	Communication monitor flag (1) of the master station is turned "OFF."		All stations

(2) Operation condition monitor flag [1]

This flag is used to monitor the operation condition of each station when the communication with each station is normal.

Non-connected station keeps this flag as "OFF."

Flag	Condition for flag operation	Flag operation
Own station flag	Communication monitor flag (1) of the own station is turned "ON."	* ON
	Communication monitor flag (1) of the own station is turned "OFF."	OFF

Flag	Condition for flag operation	Flag operation	
Other station's flag	Each station is operating.	ON	Specific station
	Each station stops operation (not by an error cause).	OFF	
	Communication monitor flag (1) of the own station is turned "OFF."		All slave stations
	Slave station that communication monitor flag (1) is turned to "OFF."	Not specified	

* Even if the own station PC has stopped operation normally or by an error, the JW-21MN turns "ON" this flag while communicating.

(3) Operation condition monitor flag [2]

This flag is used to monitor the abnormal stop of each station when the communication with each station is normal.

Non-connected station keeps this flag as "OFF."

Flag	Condition for flag operation	Flag operation
Own station flag	Communication monitor flag (1) of the own station is turned "ON."	* ON
	Communication monitor flag (1) of the own station is turned "OFF."	OFF

Flag	Condition for flag operation	Flag operation	
Other station's flag	Each station is normal.	ON	Specific station
	Any of the stations is faulty (caused to be stopped abnormally).	OFF	
	Communication monitor flag (1) of the own station is turned "OFF."		All stations
	Slave station that communication monitor flag (1) is turned to "OFF."	Not specified	

* Even if a own station PC has stopped operation normally or by an error, the JW-21MN turns "ON" this flag while communicating.

[4] Monitor operation condition by each station PC

By creating a program having the flags shown below in each station's PC, the JW-21MN can monitor the operation condition of each station's PC.

[Ex.: In this case the flag top address is □0740]

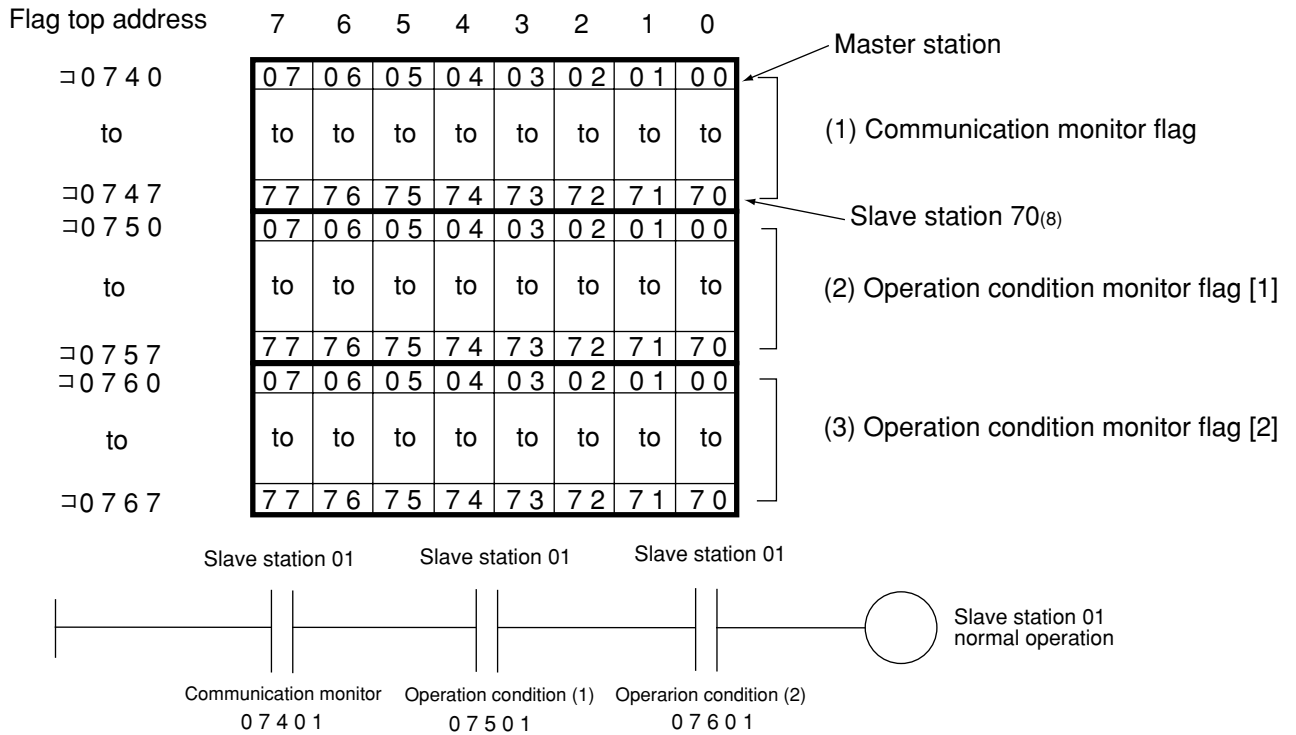

12-3 Storage of error code

When an error occurs in the JW-21MN, it stores the occurred error's code to system memory #160, #170 and error history storage register of each station's PC.

Error code (HEX)	Cause	Error code stored to system memory		Measure
		#160	#170	
01	ROM error, upper CPU	53 _(H)	_____	Replace the JW-21MN - Check the communication cable - Check for doubled allocation of station number - Replace the JW-21MN
02	RAM error, upper CPU			
03	2 port RAM error against PC, upper CPU			
04	2 port RAM error against communication CPU, upper CPU			
11	ROM error, communication CPU			
12	RAM error, communication CPU			
18	Communication LSI error, communication CPU			
1F	No response	_____	1F _(H)	Check the parameter setting
20	More than one token detected	_____	20 _(H)	
21	Doubled address detected	_____	21 _(H)	
22	Fault of sending section	_____	22 _(H)	Replace the JW-21MN
23	Token does not return within the rated interval	_____	23 _(H)	Check the communication cable
2A	Over flow of receiving buffer.	_____	2A _(H)	_____
2B	Flame length error	_____	2B _(H)	Check the communication cable
30	EEPROM error	_____	30 _(H)	Replace the JW-21MN
60	Switch setting error	_____	60 _(H)	Check the switch setting
6E	BCC error	_____	6E _(H)	Check the parameter setting
6F	Parameter setting error	_____	6F _(H)	
C1 to FF	Communication error - After converting into octal, the lower two digits represent the slave station number of the current error. (Ex. C1 _(H) = 301 ₍₈₎ = slave station 01)	_____	C1 _(H) to FF _(H)	Check the communication cable and slave module

- In some cases, error code 23_(H) or 2A_(H) is stored when inputting power. This is not an error.
- Error code 60_(H), 6E_(H), C1 to FF_(H) are special error codes unique to the JW-21MN.

(1) System memory #170 to 177 (option module error code)

The error code stored in the system memory #170 is shifted to #170 to #177 one after the other as new errors occur. Thus, the system memory can store up to 8 errors. When the PC is operating by RAM, these error codes do not disappear even after turning OFF the power. The contents of system memory #170 to #177 are kept storing after the JW-21MN recovers from the error.

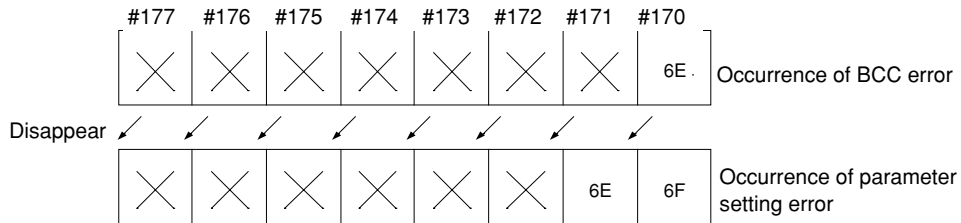

(2) System memory #160 to 167 (self diagnosis error code)

When any of errors "01_(H)" to "18_(H)" occurs among the error codes listed on the previous page, the JW-21MN stores error code "53_(H)" (optional error) in the system memory #160. It does not store any error code in system memory #170.

(3) System memory #150 (monitor error switch number)

When you monitor the system memory #050 at the occurrence of error code "53_(H)," you can check the module No. switch setting value of the error causing option module with a bit pattern. (At normal: OFF, at error: ON)

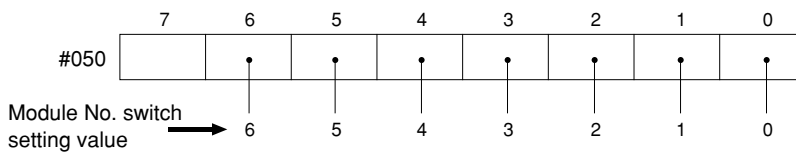

[Ex.] In the case below, an option module having the module No. switch setting value as "2" is an error.

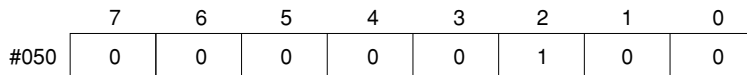

(4) Error history

When the JW-21MN has errors, it stores them in an error history register. The storage area is specified using the module No. switch setting value.

Module No. switch setting value	Error history storage register	
	JW20/JW20H	JW30H *1
0	E1400 to E1577	E7400 to E7577
1	E1200 to E1377	E7200 to E7377
2	E1000 to E1177	E7000 to E7177
3	E0600 to E0777	E6600 to E6777
4	E0400 to E0577	E6400 to E6577
5 *2	E0200 to E0377	E6200 to E6377
6 *2	E0000 to E0177	E6000 to E6177
7 to 9	Prohibited setting	

*1: When the JW30H is used, system memory should be set to #210 = 002₍₈₎.

*2: Setting the module No. switch to "5" or "6" is only valid when the model switch on the JW-21MN is set to "2."

The storage area for the error history (128 bytes) is divided into 8 sections (16 bytes each). The JW-21MN stores up to 8 errors, in the order they occurred. If a ninth error occurs, the oldest error data will be deleted.

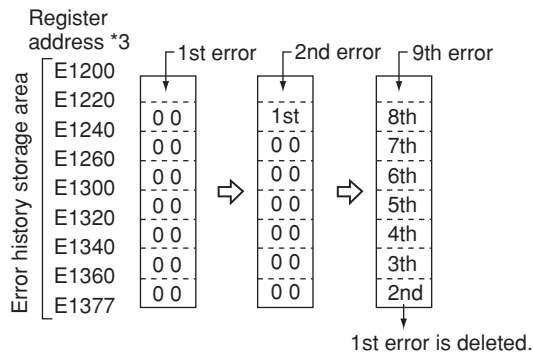

*3: The register address on the left is correct when the JW20H is used and the Module No. switch is set to "1."

Details of the data for each error (16 bytes) are as follows.

Address (*4)	Details		Remarks
n+0 (E1200)	Second	Date and time error occurred	- When a JW-21CU/31CUH/31CUH1 is used for the control module of a JW20/20H/30H, ignore data from bytes 1 to 7. (Since the JW-21CU/31CUH/31CUH1 do not have a clock function, they cannot store this data correctly.)
n+1 (E1201)	Minute		
n+2 (E1202)	Hour		
n+3 (E1203)	Date		
n+4 (E1204)	Month		
n+5 (E1205)	Year		
n+6 (E1206)	Day of week		
n+7 (E1207)	Error code	JW-21MN error code	- Stores the error code (value of #170). ⇒ See page 12-6.
n+8 (E1210) n+9 (E1211)	_____	_____	_____
n+10 (E1212)	Number of errors that have occurred	000 to 377 ₍₈₎	- When the same error occurs, the JW-21MN will count up to 377 ₍₈₎ . From error 400 ₍₈₎ , the number of errors will stay at 377 ₍₈₎ . (The date and time the error occurred is the date and time the error occurred for the first time.)
n+11 (E1213) to n+15 (E1217)	_____	_____	_____

*4: When the top address is "E1200."

Chapter 13: Replacement of the JW-21MN

When you want to change the JW-21MN due to an operation fault (lighting UNT.E lamp) etc., follow the procedures below.

(Make sure to store the set parameters onto a floppy diskette using a support tools. (See the next page)

Operation procedure

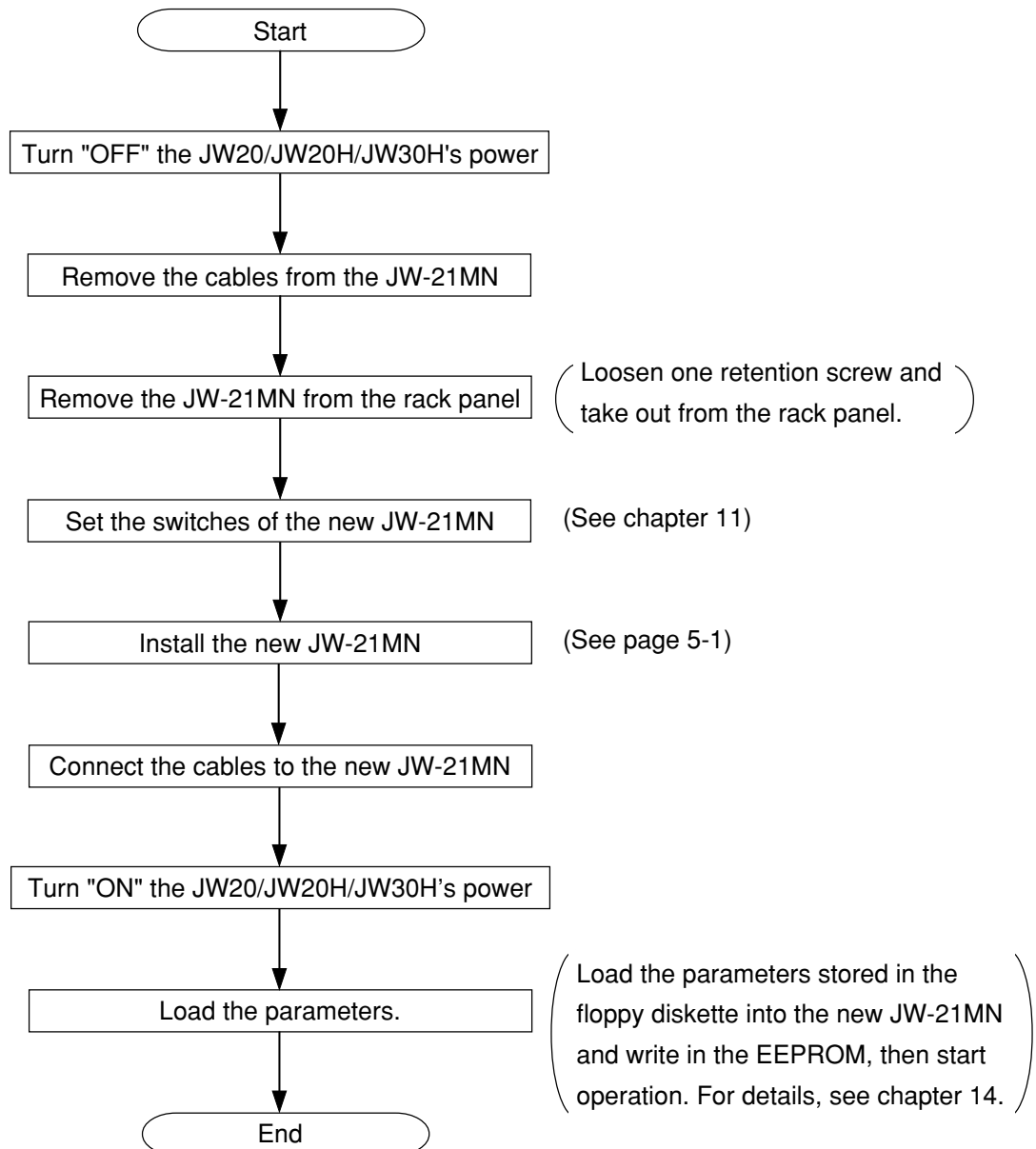

Chapter 14: Support Tools

The following support tools are available to record (store), and load the contents of the parameter memory.

(Make sure to save the set parameters onto a floppy diskette.)

Model name	Applicable floppy diskettes
Ladder software (JW-92SP, JW-50SP)	3.5-inch 2DD/2HD, 5-inch 2DD/2HD
Multipurpose programmer (JW-50PG)	3.5-inch 2DD
Ladder processor II (Z-100LP2S)	3.5-inch 2DD

Record and load by ladder software (JW-92SP, JW-50SP)

<Record>

(1) Stop operation of the JW-21MN

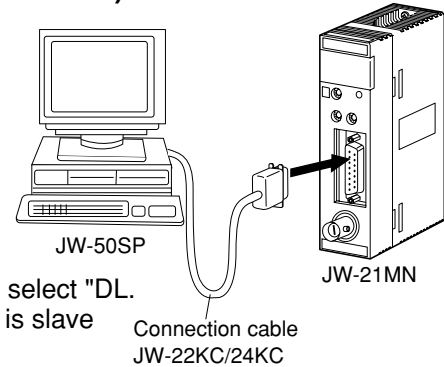
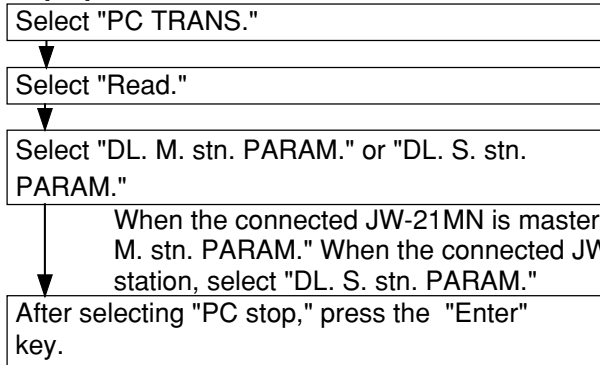

(2) Record onto the personal computer

After stopping operation, record the parameters of the JW-21MN onto the memory of the personal computer.

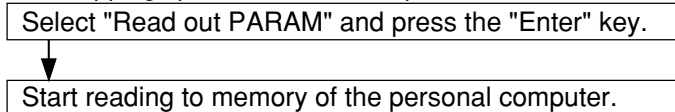

(3) Start operation of the JW-21MN

After recording the parameters onto the personal computer, start operation of the JW-21MN.

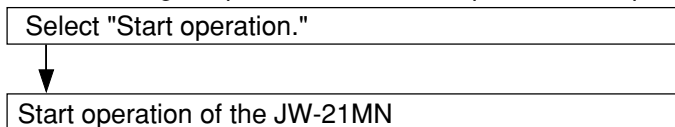

(4) Record onto a floppy diskette

Write (record) the memory contents of the personal computer onto a floppy diskette.

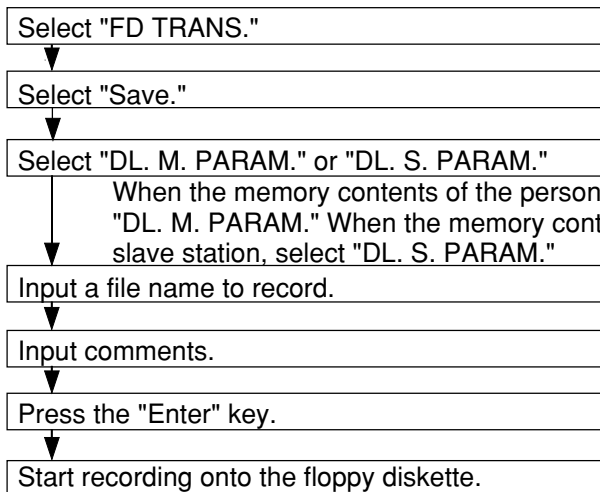

<Load>

(1) Load to the personal computer

Load the contents of the floppy diskette into the memory of the personal computer.

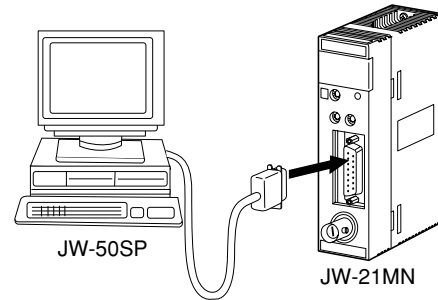
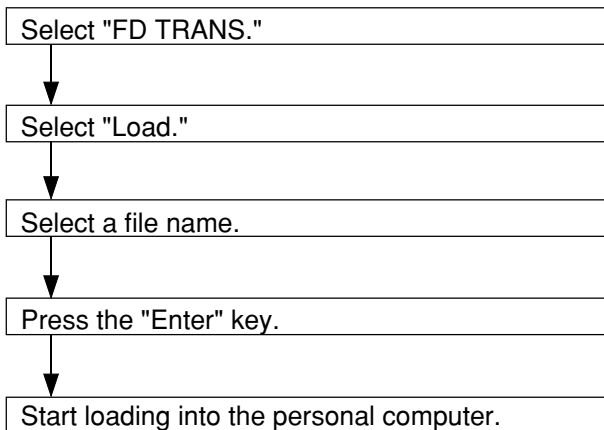

(2) Stop operation of the JW-21MN

After stopping operation, load the memory contents of the personal computer into the JW-21MN.

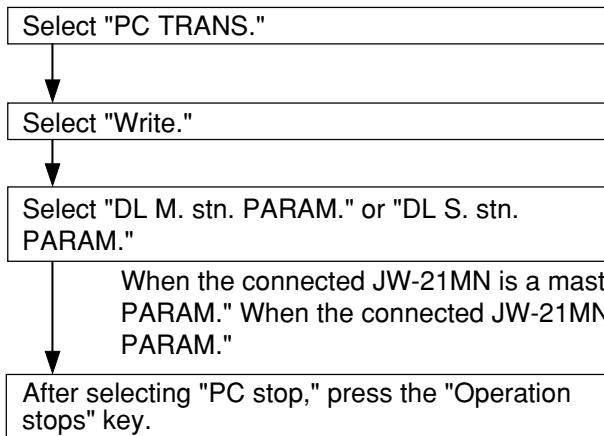

(3) Load to the JW-21MN

After stopping operation, load the memory contents of the personal computer into the JW-21MN.

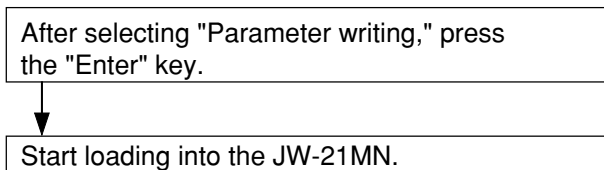

(4) Start operation of the JW-21MN

After loading the parameters from the personal computer, start operation of the JW-21MN.

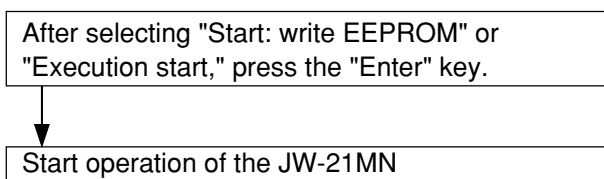

Chapter 15: Specifications

15-1 General specifications

Item	Specification
Applicable PC	New satellite JW20/JW20H (JW-21CU/22CU) New satellite JW30H (JW-31CUH/32CUH/33CUH, JW-31CUH1/32CUH1/33CUH1/33CUH2/33CUH3)
Installing slot	Basic rack panel of JW20/JW20H/JW30H
Storage temperature	-20 to +70°C
Ambient temperature	0 to +55°C
Ambient humidity	35 to 90%RH (without condensation)
Vibration resistance	JIS-C-0911 equivalent (X, Y, Z, 2 hours each)
Shock resistance	JIS-C-0912 equivalent
Internal power consumption	Approx. 360 mA
Weight	Approx. 285 g
Accessory	One instruction manual

15-2 Communication specifications

Item	Specification
Communication method	Token/passing
Transmission rate	1.25M bits/s
Transmission format	JIS X-5014 high level data link control procedure Compatible to (HDLC) frame configuration
Coding method	NRZI (Non Return To Zero Inverted)
Check method	CRC
Sync method	Bit synchronous
Modulation method	Continuous frequency phase modulation (FSK)
Communication network system	Bus type
Connectors	Module side: BNC receptacle (jack) Line side: BNC plug
Transmission line	Coaxial cable: 5C-2V JIS · C-3501 Characteristic impedance: 75 ohm Total cable distance: 1km max.

15-3 Data link specifications

Both standard function and save memory function are available. Select by the mode switch on the JW-21MN.

(1) Standard function

Item	Specifications	
Amount of connectable stations	64 stations max.	
Link area	JW20/JW20H	JW30H
	Relay link 0000 to 1577 09000 to 39777	0000 to 1577, 2000 to 7577 b0000 to b1777, b2000 to b3777 09000 to 99777, E0000 to E7777
Register link	0000 to 1577 09000 to 99777	File 1, 2 (When JW-32CUH1/33CUH1/33CUH2/33CUH3 is used) File 3 (When JW-33CUH1/33CUH2/33CUH3 is used) File 10 to 14 (When JW-33CUH2/33CUH3 is used) File 15 to 2C (When JW-33CUH3 is used)
Flag area	Set to the parameters of the JW-21MN, (Initial value: 740)	
Total number of links	Relay link : 2048 points max. Register link: 2048 bytes max.	
Transmit points per station	Max. 1024 bytes including relay link and register link	
Communication mode	N: M communication	

(2) Save memory function

Item	Specifications
Amount of connectable stations	64 stations max.
Link area	Relay link : 1000 to 1477 (Select by the module No. switch)
	Register link : 09000 to 49777 (Select by the module No. switch)
Flag area	Set to the parameters of the JW-21MN (Initial value: 740)
Total number of links	Relay link : 2048 points max. Register link: 2048 bytes max.
Sending points per station	Relay link : 256 points max. Register link: 256 bytes max.
Communication mode	N: M communication

15-4 Computer link specifications

Item	Specifications
Link station	64 stations max.
Communication data size	Maximum 1024 bytes per command
Communication control	According to the host computer command
Control functions	Data memory read/write Program memory read/write PC control Extension function by optional command

[Outside dimensional drawings]

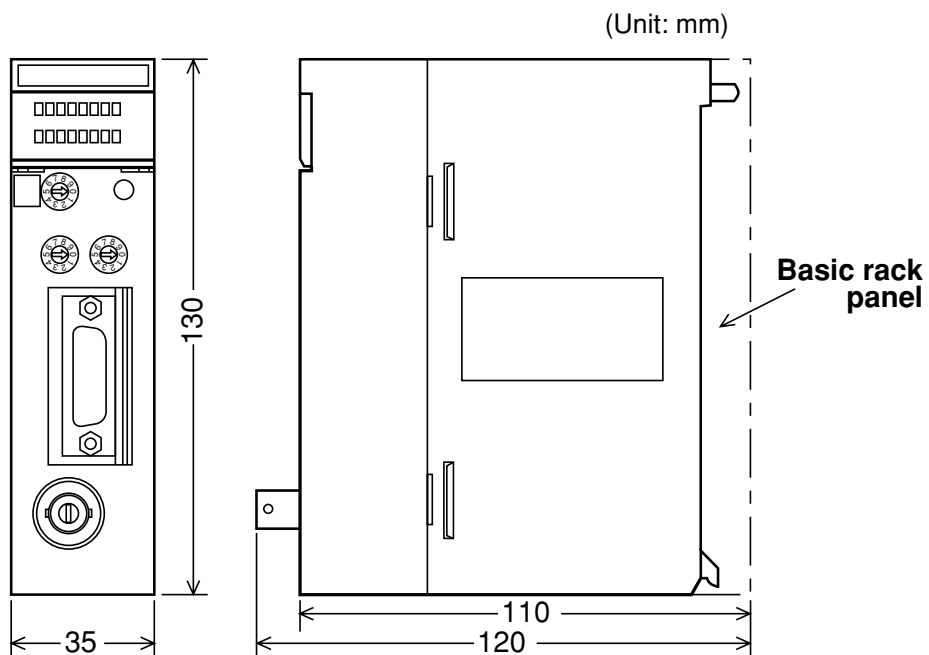

Chapter 16: Appendix

16-1 Maintenance and check

Check wiring, installation, and switch settings.

Check item		System configuration				
		()	()	()	()	()
Communication cable	Not parallel with or proximate to high voltage lines or strong power lines.					
	Branch lines (drop cable) are within 400 mm.					
	Total length is less than 1 km.					
	No damage or breaks in cables.					
	Connectors are securely assembled.					
	Connectors are securely connected and locked.					
	Insulation covers are put on connectors.					
Power supply module	Securely tighten the module retention screws.					
	A ground line is connected with the GND terminal.					
Control module	Securely tighten the module retention screws.					
	Memory module is appropriately installed.					
I/O module	Securely tighten the module retention screws.					
	No other cables than the communication cable and DC input cables are input in the same duct.					
Basic rack panel is appropriately installed.						
JW-21MN	Securely tighten the module retention screws.					
	Mode switches are appropriately set.					
	Station number switches are appropriately set (00 to 77 ⁽⁸⁾).					
	Termination resistance switches are appropriately set.	ON				
	Shield ground switches are appropriately set.					
	Parameters are appropriately set.					

16-2 Recovery method at communication errors

(1) Check flow chart

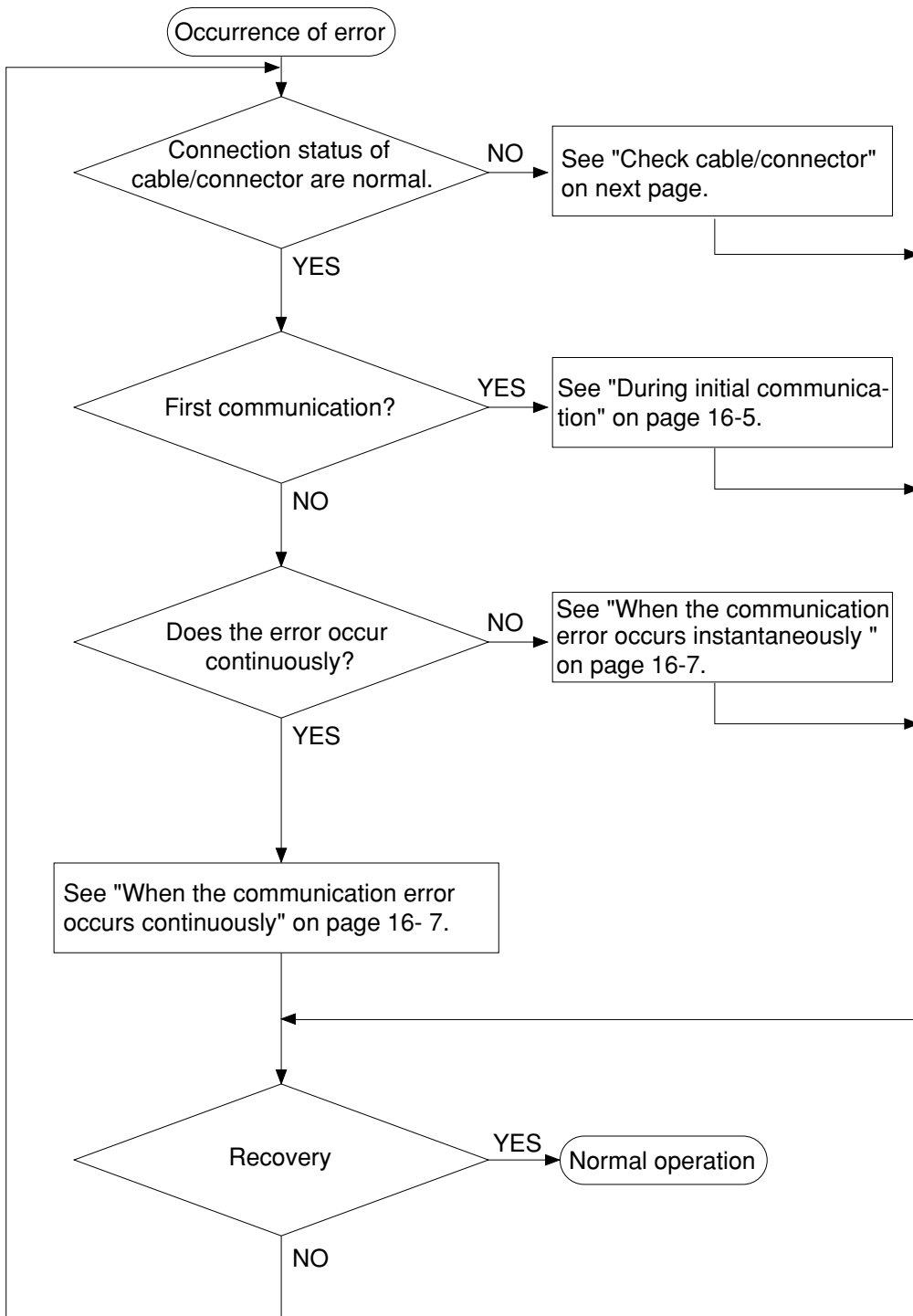

(2) Check cable/connector

As errors on the junction from the main cable to the drop cable or the contact failure on the connecting point of each station or errors of the master module are assumed, check with the following procedure.

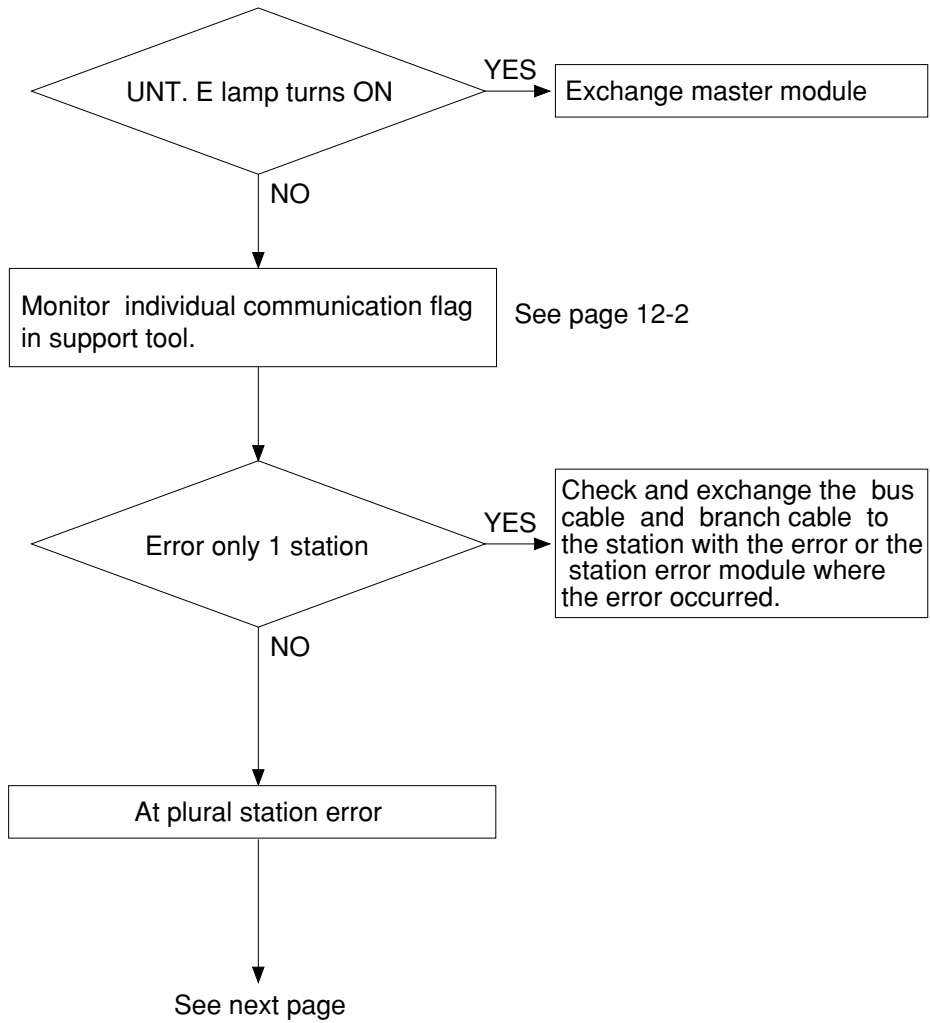

- If the bus cable between the slave station 05⁽⁸⁾ and 06⁽⁸⁾ is disconnected in the following system.

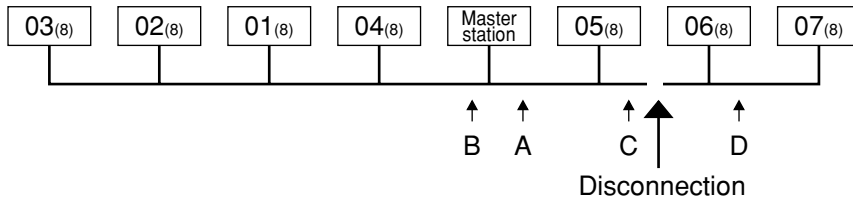

State of an individual communication flag

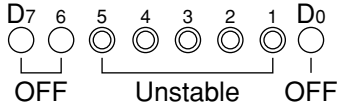

Remove the connector on point A, and turn ON the termination resistance of the master station.

As the communication possible stations 03⁽⁸⁾, 02⁽⁸⁾, 01⁽⁸⁾, and 04⁽⁸⁾ are normal, the state of communication monitoring flag is as follows.

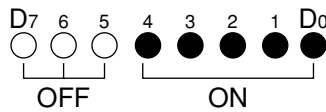

Connect the A connector, and then remove the connector on point B.

As the one side of the termination resistance is lost, all of the communication possible stations 05⁽⁸⁾, 06⁽⁸⁾, and 07⁽⁸⁾ are abnormal, and the station 05⁽⁸⁾ is unstable.

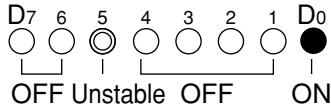

Remove the connector on point C and make sure the B connector is not connected. Turn ON the termination resistance of the slave module 05⁽⁸⁾.

As the communication possible station 05⁽⁸⁾ is normal, abnormal points exist ahead of the point C.

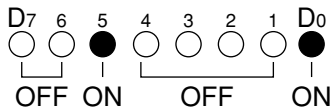

Connect the C connector and make sure the B connector is not connected, and remove the connector at the next point to the point D. Turn OFF the termination resistance of the slave station 05⁽⁸⁾, and turn ON the termination resistance of the end station 06⁽⁸⁾.

As the one side of the termination resistance is lost, the station 05⁽⁸⁾ and 06⁽⁸⁾ become communication possible stations, but the station 05⁽⁸⁾ is unstable and the station 06⁽⁸⁾ is turned to OFF, so the abnormal states occur between the point C and the point D.

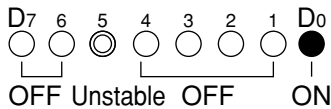

Cause	Countermeasure
Disconnection in the bus cable and the branch cable between the station 05 ⁽⁸⁾ and 06 ⁽⁸⁾ , or contact failure of the connectors	Remove both the bus cable and the branch cable connectors. After that, shorten one of these connectors and check conductivity using a tester.
Error on the slave station 06 ⁽⁸⁾	Exchange the slave module.

(3) During initial communication (startup of the system)

Lighting error code 6F^(H)

- When the master station indicates error code 6F^(H) and the COMM lamp is OFF.
The cause may be a parameter setting error of the master station. Check the master station parameters below.

Parameter address ⁽⁸⁾	Setting item	Reference page of the setting contents
004000 to 004001	Relay link top address of master station	11-5 to 9
004002	Amount of connectable stations	
004400 to 004403	Register link top address of master station	
005000 to 050001	Relay link transmit bytes of master station	
005200 to 005201	Register link transmit bytes of master station	
007764 to 007767	Flag top address	

- When the master station indicates error code 6F^(H) and the COMM lamp lights.
The cause may be a setting error of any of the slave stations which are set in the parameter. Check the following master station parameters.

Parameter address ⁽⁸⁾	Setting item	Reference page of the setting contents
004004 to 004377	Relay link top address of each slave station. Number of offset bytes.	11-5 to 9
004404 to 004777	Register link top address of each slave station. Number of offset bytes.	
005002 to 005177	Relay link transmit bytes of each slave station	
005202 to 005377	Register link transmit bytes of each slave station	

When slave station is JW-21MN, see "Chapter 11: Setting of Switches and Parameter" for setting range.

- When the master station is normal and the error code 6F^(H) of a slave station lights.
The cause may be a faulty setting of the slave station parameter. Check the following slave station parameters.

Parameter address ⁽⁸⁾	Setting item	Reference page of the
007764 to 007767	Flag top address	11- 22

When slave station is JW-21MN, see "Chapter 11: Setting of Switches and Parameter" for setting range.

When the COMM lamp of the master station is OFF (SD, RD, and CD are flickering).

Check the following master station's parameters.

Parameter address(⑥)	Contents	Setting value
004002	Function (relay/register link)	01 ^(H)
007777	Start/stop operation of the JW-21MN	01 ^(H)

Other cases

- Check the switches of the JW-21MN (see check item)
- Check optional cable of PC (The JW-21MN does not operate normally without an optional cable.)
- Check cable and connector (see check item)
- Check error code

[Switches required check in the JW-21MN]

- ① Station number (STA NO.)
- ② Mode switch (MODE)
- ③ Termination resistance switch (LT)
- ④ Shield ground switch (LG)

If there are errors in the station number and the mode switch, change the setting with the power OFF, and then turn ON the power.

[Check items of cables and connectors]

- ① No looseness or removal of connectors (turn the connector right until it completely locks).
- ② Connectors are appropriately fixed on the cables (When any faults such as extrusion of pins or connector being easily removed by pulling, reinstall these connectors.)
- ③ Wiring conditions are appropriate (See chapters 6 and 7).
- ④ Not too long branch lines (shorter than 400 mm).
- ⑤ Termination resistance are correctly connected.
(Turn "ON" the termination resistance switch of the end stations or install a termination tool.)

(4) When the communication error occurs instantaneously.

Cause may be:

- Noise on the communication line.
- Fault of a communication module.
- Fault of a communication cable.

Check the error's timing.

When the error occurs synchronous with a peripheral industrial robot's operation, noise to the communication line may be a cause. Consider arrangement of the wiring route.

Identify the error station.

When the error occurs at only the specific station, the cause may be the station or nearby. Check the following items.

- Setting of the LT (termination resistance) switch.
- Cable (See page 16-6 "Check items of cables and connectors")
- Error code (See page 12-1)

When identification of the cause is difficult.

Condition of the circuit may be unstable. (See page 16 -6 "Check items of cables and connectors")

(5) When the communication error occurs continuously.

Identify the error station.

Specify the error's station using the communication flag etc., and check this station.

- Check the power of the error's station.
- Check the error code of the error's station.
- Check cables near the error's station. (See page 16-6 "Check items of cables and connectors")

When identification of the cause is difficult.

Condition of the whole circuit may be unstable. Check cables and connectors.
(See page 16 -6 "Check items of cables and connectors")

16-3 Table of parameter memory

(1) Master station

The set contents of the parameter addresses 004004 to 004377⁽⁸⁾ and 004404 to 004777⁽⁸⁾ shown below are in the case that a JW-21MN is used for a slave station.

Address ⁽⁸⁾	Set contents	Setting method (value, example)		
000000	Store the mis-setting slave station number in the master station	—	—	
004000	Top address of relay link area in the master station	(Octal, word)	When ≥ 1000 , set to 001000 ⁽⁸⁾ by file address	
004001	station			
004002	Set function (relay/register link)	01 ^(H)	Fixed to 01 ^(H)	
004003	Amount of connectable stations (2 to 64 stations)	(Decimal, byte)	When 12 stations, set to 012 ^(D)	
004004 to 004007	- When slave station 01 ⁽⁸⁾ is set to data link (the standard function), top address of the relay link area on slave station 01 ⁽⁸⁾ are as shown at right.	004004) When ≥ 1200 , set to 001200 ⁽⁸⁾ (Set by file address) * 00 ^(H) : In this case the same as the master station 80 ^(H) : In this case different from the master station	
		004005		
		004006		00 ^(H)
		004007		●
004004 to 004007	- When slave station 01 ⁽⁸⁾ is set to data link (the save memory function), number of offset bytes of relay link area on slave station 01 ⁽⁸⁾ are shown at right.	004004) When 100 bytes, set to 00100 ^(D)	
		004005		
		004006		00 ^(H)
		004007		80 ^(H)

* When 00^(H) is set, the value becomes the same top address of the master station regardless of the setting value of 004004 to 004005⁽⁸⁾.

Address ⁽⁸⁾	Set contents
004010 to 004013	Top address or number of offset bytes on slave station 02 ⁽⁸⁾ (same as 004004 to 004007).
004014 to 004017	03 ⁽⁸⁾ (same as 004004 to 004007)
004020 to 004023	04 ⁽⁸⁾ (same as 004004 to 004007)
004024 to 004027	05 ⁽⁸⁾ (same as 004004 to 004007)
004030 to 004033	06 ⁽⁸⁾ (same as 004004 to 004007)
004034 to 004037	07 ⁽⁸⁾ (same as 004004 to 004007)
004040 to 004043	10 ⁽⁸⁾ (same as 004004 to 004007)
004044 to 004047	11 ⁽⁸⁾ (same as 004004 to 004007)
004050 to 004053	12 ⁽⁸⁾ (same as 004004 to 004007)
004054 to 004057	13 ⁽⁸⁾ (same as 004004 to 004007)
004060 to 004063	14 ⁽⁸⁾ (same as 004004 to 004007)
004064 to 004067	15 ⁽⁸⁾ (same as 004004 to 004007)
004070 to 004073	16 ⁽⁸⁾ (same as 004004 to 004007)
004074 to 004077	17 ⁽⁸⁾ (same as 004004 to 004007)
004100 to 004103	20 ⁽⁸⁾ (same as 004004 to 004007)
004104 to 004107	21 ⁽⁸⁾ (same as 004004 to 004007)
004110 to 004113	22 ⁽⁸⁾ (same as 004004 to 004007)
004114 to 004117	23 ⁽⁸⁾ (same as 004004 to 004007)
004120 to 004123	24 ⁽⁸⁾ (same as 004004 to 004007)
004124 to 004127	25 ⁽⁸⁾ (same as 004004 to 004007)
004130 to 004133	26 ⁽⁸⁾ (same as 004004 to 004007)
004134 to 004137	27 ⁽⁸⁾ (same as 004004 to 004007)
004140 to 004143	30 ⁽⁸⁾ (same as 004004 to 004007)
004144 to 004147	31 ⁽⁸⁾ (same as 004004 to 004007)
004150 to 004153	32 ⁽⁸⁾ (same as 004004 to 004007)
004154 to 004157	33 ⁽⁸⁾ (same as 004004 to 004007)
004160 to 004163	34 ⁽⁸⁾ (same as 004004 to 004007)
004164 to 004167	35 ⁽⁸⁾ (same as 004004 to 004007)
004170 to 004173	36 ⁽⁸⁾ (same as 004004 to 004007)
004174 to 004177	37 ⁽⁸⁾ (same as 004004 to 004007)

Address ⁽⁸⁾	Set contents
004200 to 004203	Top address or number of offset bytes on slave station 40 ⁽⁸⁾ (same as 004004 to 004007).
004204 to 004207	41 ⁽⁸⁾ (same as 004004 to 004007)
004210 to 004213	42 ⁽⁸⁾ (same as 004004 to 004007)
004214 to 004217	43 ⁽⁸⁾ (same as 004004 to 004007)
004220 to 004223	44 ⁽⁸⁾ (same as 004004 to 004007)
004224 to 004227	45 ⁽⁸⁾ (same as 004004 to 004007)
004230 to 004233	46 ⁽⁸⁾ (same as 004004 to 004007)
004234 to 004237	47 ⁽⁸⁾ (same as 004004 to 004007)
004240 to 004243	50 ⁽⁸⁾ (same as 004004 to 004007)
004244 to 004247	51 ⁽⁸⁾ (same as 004004 to 004007)
004250 to 004253	52 ⁽⁸⁾ (same as 004004 to 004007)
004254 to 004257	53 ⁽⁸⁾ (same as 004004 to 004007)
004260 to 004263	54 ⁽⁸⁾ (same as 004004 to 004007)
004264 to 004267	55 ⁽⁸⁾ (same as 004004 to 004007)
004270 to 004273	56 ⁽⁸⁾ (same as 004004 to 004007)
004274 to 004277	57 ⁽⁸⁾ (same as 004004 to 004007)
004300 to 004303	60 ⁽⁸⁾ (same as 004004 to 004007)
004304 to 004307	61 ⁽⁸⁾ (same as 004004 to 004007)
004310 to 004313	62 ⁽⁸⁾ (same as 004004 to 004007)
004314 to 004317	63 ⁽⁸⁾ (same as 004004 to 004007)
004320 to 004323	64 ⁽⁸⁾ (same as 004004 to 004007)
004324 to 004327	65 ⁽⁸⁾ (same as 004004 to 004007)
004330 to 004333	66 ⁽⁸⁾ (same as 004004 to 004007)
004334 to 004337	67 ⁽⁸⁾ (same as 004004 to 004007)
004340 to 004343	70 ⁽⁸⁾ (same as 004004 to 004007)
004344 to 004347	71 ⁽⁸⁾ (same as 004004 to 004007)
004350 to 004353	72 ⁽⁸⁾ (same as 004004 to 004007)
004354 to 004357	73 ⁽⁸⁾ (same as 004004 to 004007)
004360 to 004363	74 ⁽⁸⁾ (same as 004004 to 004007)
004364 to 004367	75 ⁽⁸⁾ (same as 004004 to 004007)
004370 to 004373	76 ⁽⁸⁾ (same as 004004 to 004007)
004374 to 004377	77 ⁽⁸⁾ (same as 004004 to 004007)

- Initial value of the address 004000 to 004377⁽⁸⁾ are all 00^(H).

Address ⁽⁸⁾	Set contents	Setting method (value, example)	
004400	Top address of register link area in the master station	(Octal, word)	When 09000 ⁽⁸⁾ , set to 004000 ⁽⁸⁾ (Set by file address)
004401		(Hexadecimal, byte)	
004402		00 ^(H)	When file number is 1 -> 01 ^(H)
004403			
004404 to 004407	- When slave station 01 ⁽⁸⁾ is set to data link (the standard function), top address of the register link area on slave station 01 ⁽⁸⁾ are as shown at right.	004404	When 29000, set to 006000 ⁽⁸⁾ (Set by file address)
		004405	
		004406	When file number is 2 -> 02 ^(H) 00 ^(H) : In this case the same as the master station* 80 ^(H) : In this case different from the master station
		004407	
004404 to 004407	- When slave station 01 ⁽⁸⁾ is set to data link (the save memory function), number of offset bytes of register link area on slave station 01 ⁽⁸⁾ are shown at right.	004404	When 100 bytes, set to 00100 ^(D)
		004405	
		004406	
		004407	

* When 00^(H) is set, the value becomes the same top address of the master station regardless of the setting value of 004404 to 004405⁽⁸⁾.

Address ⁽⁸⁾	Set contents
004410 to 004413	Top address or number of offset bytes on slave station 02 ⁽⁸⁾ (same as 004404 to 004407).
004414 to 004417	03 ⁽⁸⁾ (same as 004404 to 004407)
004420 to 004423	04 ⁽⁸⁾ (same as 004404 to 004407)
004424 to 004427	05 ⁽⁸⁾ (same as 004404 to 004407)
004430 to 004433	06 ⁽⁸⁾ (same as 004404 to 004407)
004434 to 004437	07 ⁽⁸⁾ (same as 004404 to 004407)
004440 to 004443	10 ⁽⁸⁾ (same as 004404 to 004407)
004444 to 004447	11 ⁽⁸⁾ (same as 004404 to 004407)
004450 to 004453	12 ⁽⁸⁾ (same as 004404 to 004407)
004454 to 004457	13 ⁽⁸⁾ (same as 004404 to 004407)
004460 to 004463	14 ⁽⁸⁾ (same as 004404 to 004407)
004464 to 004467	15 ⁽⁸⁾ (same as 004404 to 004407)
004470 to 004473	16 ⁽⁸⁾ (same as 004404 to 004407)
004474 to 004477	17 ⁽⁸⁾ (same as 004404 to 004407)
004500 to 004503	20 ⁽⁸⁾ (same as 004404 to 004407)
004504 to 004507	21 ⁽⁸⁾ (same as 004404 to 004407)
004510 to 004513	22 ⁽⁸⁾ (same as 004404 to 004407)
004514 to 004517	23 ⁽⁸⁾ (same as 004404 to 004407)
004520 to 004523	24 ⁽⁸⁾ (same as 004404 to 004407)
004524 to 004527	25 ⁽⁸⁾ (same as 004404 to 004407)
004530 to 004533	26 ⁽⁸⁾ (same as 004404 to 004407)
004534 to 004537	27 ⁽⁸⁾ (same as 004404 to 004407)
004540 to 004543	30 ⁽⁸⁾ (same as 004404 to 004407)
004544 to 004547	31 ⁽⁸⁾ (same as 004404 to 004407)
004550 to 004553	32 ⁽⁸⁾ (same as 004404 to 004407)
004554 to 004557	33 ⁽⁸⁾ (same as 004404 to 004407)
004560 to 004563	34 ⁽⁸⁾ (same as 004404 to 004407)
004564 to 004567	35 ⁽⁸⁾ (same as 004404 to 004407)
004570 to 004573	36 ⁽⁸⁾ (same as 004404 to 004407)
004574 to 004577	37 ⁽⁸⁾ (same as 004404 to 004407)

Address ⁽⁸⁾	Set contents
004600 to 004603	Top address or number of offset bytes on slave station 40 ⁽⁸⁾ (same as 004404 to 004407).
004604 to 004607	41 ⁽⁸⁾ (same as 004404 to 004407)
004610 to 004613	42 ⁽⁸⁾ (same as 004404 to 004407)
004614 to 004617	43 ⁽⁸⁾ (same as 004404 to 004407)
004620 to 004623	44 ⁽⁸⁾ (same as 004404 to 004407)
004624 to 004627	45 ⁽⁸⁾ (same as 004404 to 004407)
004630 to 004633	46 ⁽⁸⁾ (same as 004404 to 004407)
004634 to 004637	47 ⁽⁸⁾ (same as 004404 to 004407)
004640 to 004643	50 ⁽⁸⁾ (same as 004404 to 004407)
004644 to 004647	51 ⁽⁸⁾ (same as 004404 to 004407)
004650 to 004653	52 ⁽⁸⁾ (same as 004404 to 004407)
004654 to 004657	53 ⁽⁸⁾ (same as 004404 to 004407)
004660 to 004663	54 ⁽⁸⁾ (same as 004404 to 004407)
004664 to 004667	55 ⁽⁸⁾ (same as 004404 to 004407)
004670 to 004673	56 ⁽⁸⁾ (same as 004404 to 004407)
004674 to 004677	57 ⁽⁸⁾ (same as 004404 to 004407)
004700 to 004703	60 ⁽⁸⁾ (same as 004404 to 004407)
004704 to 004707	61 ⁽⁸⁾ (same as 004404 to 004407)
004710 to 004713	62 ⁽⁸⁾ (same as 004404 to 004407)
004714 to 004717	63 ⁽⁸⁾ (same as 004404 to 004407)
004720 to 004723	64 ⁽⁸⁾ (same as 004404 to 004407)
004724 to 004727	65 ⁽⁸⁾ (same as 004404 to 004407)
004730 to 004733	66 ⁽⁸⁾ (same as 004404 to 004407)
004734 to 004737	67 ⁽⁸⁾ (same as 004404 to 004407)
004740 to 004743	70 ⁽⁸⁾ (same as 004404 to 004407)
004744 to 004747	71 ⁽⁸⁾ (same as 004404 to 004407)
004750 to 004753	72 ⁽⁸⁾ (same as 004404 to 004407)
004754 to 004757	73 ⁽⁸⁾ (same as 004404 to 004407)
004760 to 004763	74 ⁽⁸⁾ (same as 004404 to 004407)
004764 to 004767	75 ⁽⁸⁾ (same as 004404 to 004407)
004770 to 004773	76 ⁽⁸⁾ (same as 004404 to 004407)
004774 to 004777	77 ⁽⁸⁾ (same as 004404 to 004407)

- Initial value of the address 004400 to 004777⁽⁸⁾ are all 00^(H).

Address ⁽⁸⁾	Set contents	Setting method (value, example)	
005000	Number of sending bytes of master station relay link area	(Decimal, word)	When 8 bytes, set to 00008 ^(D)
005001			
005002	(Decimal, word)		
005003			

Address ⁽⁸⁾	Set contents
005004 to 005005	Number of sending bytes of slave station 02 ⁽⁸⁾ relay link area (same as 005002 to 005003).
005006 to 005007	03 ⁽⁸⁾ (same as 005002 to 005003)
005010 to 005011	04 ⁽⁸⁾ (same as 005002 to 005003)
005012 to 005013	05 ⁽⁸⁾ (same as 005002 to 005003)
005014 to 005015	06 ⁽⁸⁾ (same as 005002 to 005003)
005016 to 005017	07 ⁽⁸⁾ (same as 005002 to 005003)
005020 to 005021	10 ⁽⁸⁾ (same as 005002 to 005003)
005022 to 005023	11 ⁽⁸⁾ (same as 005002 to 005003)
005024 to 005025	12 ⁽⁸⁾ (same as 005002 to 005003)
005026 to 005027	13 ⁽⁸⁾ (same as 005002 to 005003)
005030 to 005031	14 ⁽⁸⁾ (same as 005002 to 005003)
005032 to 005033	15 ⁽⁸⁾ (same as 005002 to 005003)
005034 to 005035	16 ⁽⁸⁾ (same as 005002 to 005003)
005036 to 005037	17 ⁽⁸⁾ (same as 005002 to 005003)
005040 to 005041	20 ⁽⁸⁾ (same as 005002 to 005003)
005042 to 005043	21 ⁽⁸⁾ (same as 005002 to 005003)
005044 to 005045	22 ⁽⁸⁾ (same as 005002 to 005003)
005046 to 005047	23 ⁽⁸⁾ (same as 005002 to 005003)
005050 to 005051	24 ⁽⁸⁾ (same as 005002 to 005003)
005052 to 005053	25 ⁽⁸⁾ (same as 005002 to 005003)
005054 to 005055	26 ⁽⁸⁾ (same as 005002 to 005003)
005056 to 005057	27 ⁽⁸⁾ (same as 005002 to 005003)
005060 to 005061	30 ⁽⁸⁾ (same as 005002 to 005003)
005062 to 005063	31 ⁽⁸⁾ (same as 005002 to 005003)
005064 to 005065	32 ⁽⁸⁾ (same as 005002 to 005003)
005066 to 005067	33 ⁽⁸⁾ (same as 005002 to 005003)
005070 to 005071	34 ⁽⁸⁾ (same as 005002 to 005003)
005072 to 005073	35 ⁽⁸⁾ (same as 005002 to 005003)
005074 to 005075	36 ⁽⁸⁾ (same as 005002 to 005003)
005076 to 005077	37 ⁽⁸⁾ (same as 005002 to 005003)

Address ⁽⁸⁾	Set contents
005100 to 005101	Number of sending bytes of slave station 40 ⁽⁸⁾ relay link area (same as 005002 to 005003).
005102 to 005103	41 ⁽⁸⁾ (same as 005002 to 005003)
005104 to 005105	42 ⁽⁸⁾ (same as 005002 to 005003)
005106 to 005107	43 ⁽⁸⁾ (same as 005002 to 005003)
005110 to 005111	44 ⁽⁸⁾ (same as 005002 to 005003)
005112 to 005113	45 ⁽⁸⁾ (same as 005002 to 005003)
005114 to 005115	46 ⁽⁸⁾ (same as 005002 to 005003)
005116 to 005117	47 ⁽⁸⁾ (same as 005002 to 005003)
005120 to 005121	50 ⁽⁸⁾ (same as 005002 to 005003)
005122 to 005123	51 ⁽⁸⁾ (same as 005002 to 005003)
005124 to 005125	52 ⁽⁸⁾ (same as 005002 to 005003)
005126 to 005127	53 ⁽⁸⁾ (same as 005002 to 005003)
005130 to 005131	54 ⁽⁸⁾ (same as 005002 to 005003)
005132 to 005133	55 ⁽⁸⁾ (same as 005002 to 005003)
005134 to 005135	56 ⁽⁸⁾ (same as 005002 to 005003)
005136 to 005137	57 ⁽⁸⁾ (same as 005002 to 005003)
005140 to 005141	60 ⁽⁸⁾ (same as 005002 to 005003)
005142 to 005143	61 ⁽⁸⁾ (same as 005002 to 005003)
005144 to 005145	62 ⁽⁸⁾ (same as 005002 to 005003)
005146 to 005147	63 ⁽⁸⁾ (same as 005002 to 005003)
005150 to 005151	64 ⁽⁸⁾ (same as 005002 to 005003)
005152 to 005153	65 ⁽⁸⁾ (same as 005002 to 005003)
005154 to 005155	66 ⁽⁸⁾ (same as 005002 to 005003)
005156 to 005157	67 ⁽⁸⁾ (same as 005002 to 005003)
005160 to 005161	70 ⁽⁸⁾ (same as 005002 to 005003)
005162 to 005163	71 ⁽⁸⁾ (same as 005002 to 005003)
005164 to 005165	72 ⁽⁸⁾ (same as 005002 to 005003)
005166 to 005167	73 ⁽⁸⁾ (same as 005002 to 005003)
005170 to 005171	74 ⁽⁸⁾ (same as 005002 to 005003)
005172 to 005173	75 ⁽⁸⁾ (same as 005002 to 005003)
005174 to 005175	76 ⁽⁸⁾ (same as 005002 to 005003)
005176 to 005177	77 ⁽⁸⁾ (same as 005002 to 005003)

- Initial value of the address 005000 to 005177⁽⁸⁾ are all 00^(H).

Address ⁽⁸⁾	Set contents	Setting method (value, example)	
005200	Number of sending bytes of master station register link area	(Decimal, word)	When 64 bytes, set to 00064 ^(D)
005201			
005202	Number of sending bytes of slave station 01 ⁽⁸⁾ register link area	(Decimal, word)	
005203			

Address ⁽⁸⁾	Set contents
005204 to 005205	Number of sending bytes of slave station 02 ⁽⁸⁾ register link area (same as 005202 to 005203).
005206 to 005207	03 ⁽⁸⁾ (same as 005202 to 005203)
005210 to 005211	04 ⁽⁸⁾ (same as 005202 to 005203)
005212 to 005213	05 ⁽⁸⁾ (same as 005202 to 005203)
005214 to 005215	06 ⁽⁸⁾ (same as 005202 to 005203)
005216 to 005217	07 ⁽⁸⁾ (same as 005202 to 005203)
005220 to 005221	10 ⁽⁸⁾ (same as 005202 to 005203)
005222 to 005223	11 ⁽⁸⁾ (same as 005202 to 005203)
005224 to 005225	12 ⁽⁸⁾ (same as 005202 to 005203)
005226 to 005227	13 ⁽⁸⁾ (same as 005202 to 005203)
005230 to 005231	14 ⁽⁸⁾ (same as 005202 to 005203)
005232 to 005233	15 ⁽⁸⁾ (same as 005202 to 005203)
005234 to 005235	16 ⁽⁸⁾ (same as 005202 to 005203)
005236 to 005237	17 ⁽⁸⁾ (same as 005202 to 005203)
005240 to 005241	20 ⁽⁸⁾ (same as 005202 to 005203)
005242 to 005243	21 ⁽⁸⁾ (same as 005202 to 005203)
005244 to 005245	22 ⁽⁸⁾ (same as 005202 to 005203)
005246 to 005247	23 ⁽⁸⁾ (same as 005202 to 005203)
005250 to 005251	24 ⁽⁸⁾ (same as 005202 to 005203)
005252 to 005253	25 ⁽⁸⁾ (same as 005202 to 005203)
005254 to 005255	26 ⁽⁸⁾ (same as 005202 to 005203)
005256 to 005257	27 ⁽⁸⁾ (same as 005202 to 005203)
005260 to 005261	30 ⁽⁸⁾ (same as 005202 to 005203)
005262 to 005263	31 ⁽⁸⁾ (same as 005202 to 005203)
005264 to 005265	32 ⁽⁸⁾ (same as 005202 to 005203)
005266 to 005267	33 ⁽⁸⁾ (same as 005202 to 005203)
005270 to 005271	34 ⁽⁸⁾ (same as 005202 to 005203)
005272 to 005273	35 ⁽⁸⁾ (same as 005202 to 005203)
005274 to 005275	36 ⁽⁸⁾ (same as 005202 to 005203)
005276 to 005277	37 ⁽⁸⁾ (same as 005202 to 005203)

Address ⁽⁸⁾	Set contents
005300 to 005301	Number of sending bytes of slave station 40 ⁽⁸⁾ register link area (same as 005202 to 005203).
005302 to 005303	41 ⁽⁸⁾ (same as 005202 to 005203)
005304 to 005305	42 ⁽⁸⁾ (same as 005202 to 005203)
005306 to 005307	43 ⁽⁸⁾ (same as 005202 to 005203)
005310 to 005311	44 ⁽⁸⁾ (same as 005202 to 005203)
005312 to 005313	45 ⁽⁸⁾ (same as 005202 to 005203)
005314 to 005315	46 ⁽⁸⁾ (same as 005202 to 005203)
005316 to 005317	47 ⁽⁸⁾ (same as 005202 to 005203)
005320 to 005321	50 ⁽⁸⁾ (same as 005202 to 005203)
005322 to 005323	51 ⁽⁸⁾ (same as 005202 to 005203)
005324 to 005325	52 ⁽⁸⁾ (same as 005202 to 005203)
005326 to 005327	53 ⁽⁸⁾ (same as 005202 to 005203)
005330 to 005331	54 ⁽⁸⁾ (same as 005202 to 005203)
005332 to 005333	55 ⁽⁸⁾ (same as 005202 to 005203)
005334 to 005335	56 ⁽⁸⁾ (same as 005202 to 005203)
005336 to 005337	57 ⁽⁸⁾ (same as 005202 to 005203)
005340 to 005341	60 ⁽⁸⁾ (same as 005202 to 005203)
005342 to 005343	61 ⁽⁸⁾ (same as 005202 to 005203)
005344 to 005345	62 ⁽⁸⁾ (same as 005202 to 005203)
005346 to 005347	63 ⁽⁸⁾ (same as 005202 to 005203)
005350 to 005351	64 ⁽⁸⁾ (same as 005202 to 005203)
005352 to 005353	65 ⁽⁸⁾ (same as 005202 to 005203)
005354 to 005355	66 ⁽⁸⁾ (same as 005202 to 005203)
005356 to 005357	67 ⁽⁸⁾ (same as 005202 to 005203)
005360 to 005361	70 ⁽⁸⁾ (same as 005202 to 005203)
005362 to 005363	71 ⁽⁸⁾ (same as 005202 to 005203)
005364 to 005365	72 ⁽⁸⁾ (same as 005202 to 005203)
005366 to 005367	73 ⁽⁸⁾ (same as 005202 to 005203)
005370 to 005371	74 ⁽⁸⁾ (same as 005202 to 005203)
005372 to 005373	75 ⁽⁸⁾ (same as 005202 to 005203)
005374 to 005375	76 ⁽⁸⁾ (same as 005202 to 005203)
005376 to 005377	77 ⁽⁸⁾ (same as 005202 to 005203)

- Initial value of the address 005200 to 005377⁽⁸⁾ are all 00^(H).

Address(8)	Set contents	Setting method (value, example)										
007750 to 007757	Connection condition of slave station - Turn ON the corresponding bit of connected station number (01 to 77 ⁽⁸⁾) from the list at right. - 00 ⁽⁸⁾ of master station (0 bit of address 000750) At ON: Output error code At OFF: Do not output error code.	Bit address	7	6	5	4	3	2	1	0	- When connecting slave station 00 to 04 ⁽⁸⁾ and output error code: (Address) (Bit pattern) 007750 — 00011111 007751 — 00000000 to to 007757 — 00000000	
		007750	07	06	05	04	03	02	01	00		
		007751	17	16	15	14	13	12	11	10		
		007752	27	26	25	24	23	22	21	20		
		007753	37	36	35	34	33	32	31	30		
		007754	47	46	45	44	43	42	41	40		
		007755	57	56	55	54	53	52	51	50		
007756	67	66	65	64	63	62	61	60				
007757	77	76	75	74	73	72	71	70				
007763	Whether the station number information should be output or not <input type="checkbox"/> V2	00 ^(H)										Do not output
		01 ^(H)										Output
007764 to 007767	Flag area top address on the master station	007764	(Octal, word)							When 00200, set to 000200 ⁽⁸⁾ (Set by file address)		
		007765										
		007766	00 ^(H)							00 ^(H) : Do not output flag		
		007767	●							80 ^(H) : Output flag		
007777	Stop operation of the JW-21MN	00 ^(H)										_____
	Start operation of the JW-21MN	01 ^(H)										
	Writing to EEPROM or operation of the JW-21MN/stop operation	80 ^(H)										
	Writing to EEPROM or operation of the JW-21MN/start operation	81 ^(H)										
	Initialize parameter settings	08 ^(H)										

- For initial values of above addresses, see page 11-5 and 6.

(2) Slave station (01 to 77⁽⁸⁾)

(1 / 1)

Address(8)	Set contents	Setting method (value, example)										
007720 007721	Number of receiving bytes of relay link in save memory function <input type="checkbox"/> V2	(Octal, byte)										If 0 is set, the number of bytes will be the same as the number of transfer bytes set in the master station.
007722 007723	Number of receiving bytes of register link in save memory function <input type="checkbox"/> V2	(Octal, byte)										If 0 is set, the number of bytes will be the same as the number of transfer bytes set in the master station.
007763	Whether the station number information should be output or not <input type="checkbox"/> V2	00 ^(H)										Do not output
		01 ^(H)										Output
007764 to 007767	Top address of flag area on each slave station	007764	(Octal, word)							When 00600, set to 000600 ⁽⁸⁾ (Set by file address)		
		007765										
		007766	00 ^(H)							00 ^(H) : Do not output flag		
		007767	●							80 ^(H) : Output flag		
007777	Stop operation of the JW-21MN	00 ^(H)										_____
	Start operation of the JW-21MN	01 ^(H)										
	Writing to EEPROM or operation of the JW-21MN / stop operation	80 ^(H)										
	Writing to EEPROM or operation of the JW-21MN / start operation	81 ^(H)										
	Initialize parameter settings	08 ^(H)										

- For initial values of above address, see page 11-22.

16-4 Special functions unique to the JW-21MN

The functions below are not covered by the ME-NET specifications. They can only be used with PCs which are equipped with a JW-21MN, ME-NET module JW-20MN or ZW-20CM2.

(1) Remote programming and remote monitor

This paragraph describes the operation procedure of any other station's PC which is connected on the ME-NET. The following support tools are available:

Hand-held programmer JW-14PG/13PG/12PG

Multipurpose programmer JW-50PG

Ladder software JW-92SP, JW-50SP

Ladder logic programming software .. JW-100SP

NOTE

- Remote programming operations when different software versions are combined. (When a JW30H is used.)

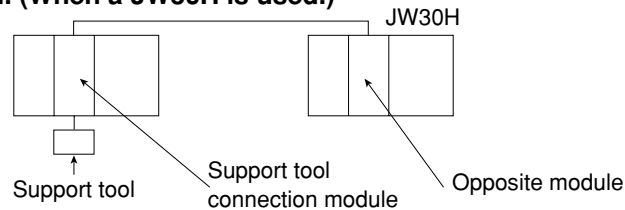

Support tool	Support tool connection module	Opposite module	
		With 30Hn mark	With 30H mark
JW-14PG, JW-13PG[B], JW-92SP (Ver5.5 or better) JW-100SP	With 30Hn mark	◎	○
	With 30H mark	○	○
	JW-21MN / JW-20MN without mark	△	△
	ZW-20CM2 with JW mark	□	□
JW-13PG, JW-13PG[A], JW-92SP (Ver5.0 to 5.3A)	With 30Hn mark	○	○
	With 30H mark	○	○
	JW-21MN / JW-20MN without mark	△	△
	ZW-20CM2 with JW mark	□	□
JW-12PG, JW-92SP(Ver4.0A)	With 30Hn mark	△	△
	With 30H mark	△	△
	JW-21MN / JW-20MN without mark	△	△
	ZW-20CM2 without JW mark	□	□

◎ : All functions are available

△ : Seen as a JW-22CU/50CUH

○ : Seen as a JW-31CUH/32CUH/33CUH
(standard JW30 model)

□ : Seen as a JW-50CU

- When you use the remote programming or remote monitor function after installing the ZW-20CM2, you cannot use the JW50H/70H/100H extension functions that are included on the JW50/70/100 models.

① **Function**

< Standard network connection >

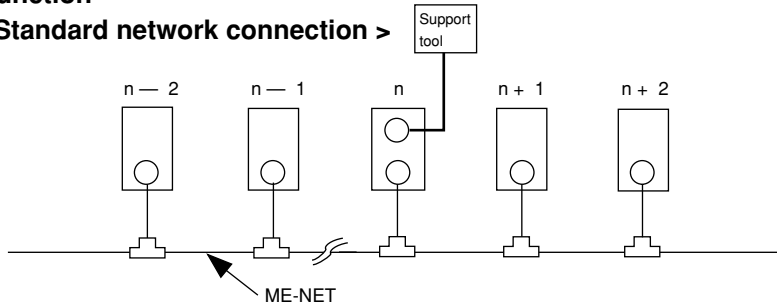

Writing data (change program) during operation of the PC is not available for hazard prevention reasons. Stop operation of the PC prior to writing data.

The operations below using a peripheral device, that is connected to a "n" station, is possible.

- Change programs
- Monitor
- Change parameter memory (only by using JW-14PG/13PG/12PG)

< Expansion network connection >

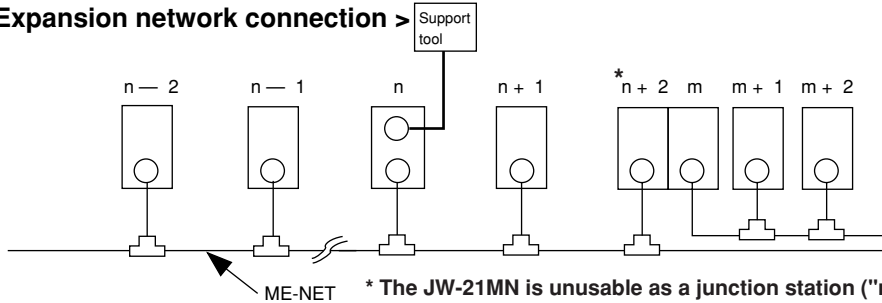

* The JW-21MN is unusable as a junction station ("n + 2" station and "m" station in the figure above). Use JW30H (JW-21MN), JW50H/70H/100H (JW-21MN).

The operations below using a peripheral device, that is connected to a "n" station, is possible.

- Change programs
- Monitor
- Change parameter memory (only by using JW-14PG/13PG/12PG)

Writing data (change program) during operation of the PC is not available for hazard prevention reasons. Stop operation of the PC prior to writing data.

② **Operation example**

This paragraph describes an operation example using the multipurpose programmer: JW-50PG. For operations with other support tools, see the attached instruction manuals.

- Connect the JW-50PG to the JW-21MN on the ME-NET.
- Set communication mode

Set the communication mode of the JW-50PG to "Network CONCT." and this enables remote programming and remote monitor.

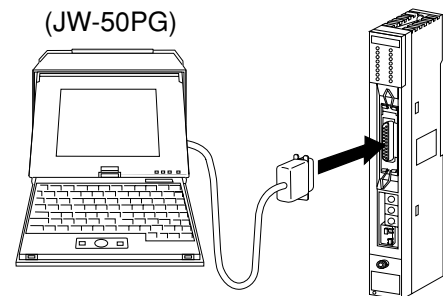
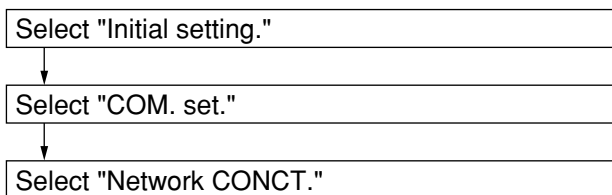

(JW-21MN)

- Network setting

Select whether the target station for remote programming or remote monitor is on the standard network connection or on the extension network connection.
In the case below, 10 to 12₍₈₎ are standard network connections. 01 to 03₍₈₎ are extension network connections.

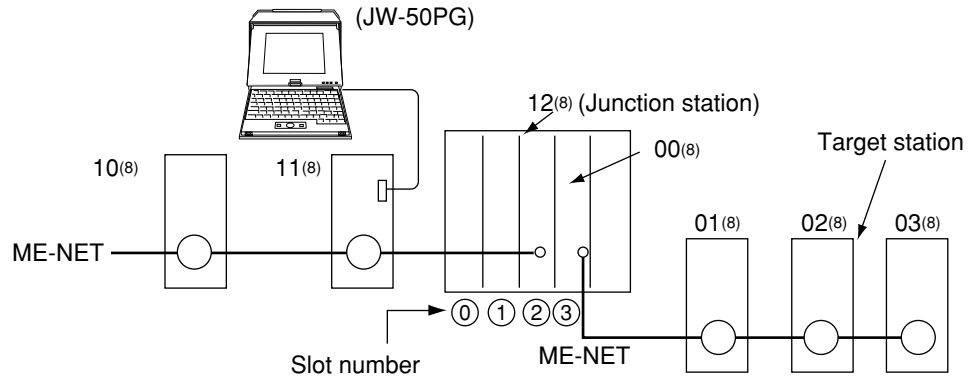

<Standard network connection>

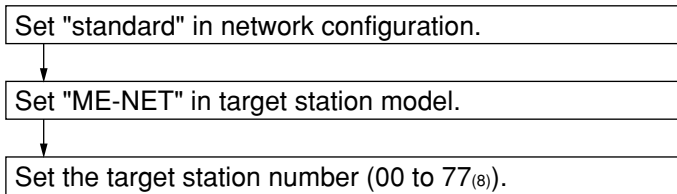

< Expansion network connection >

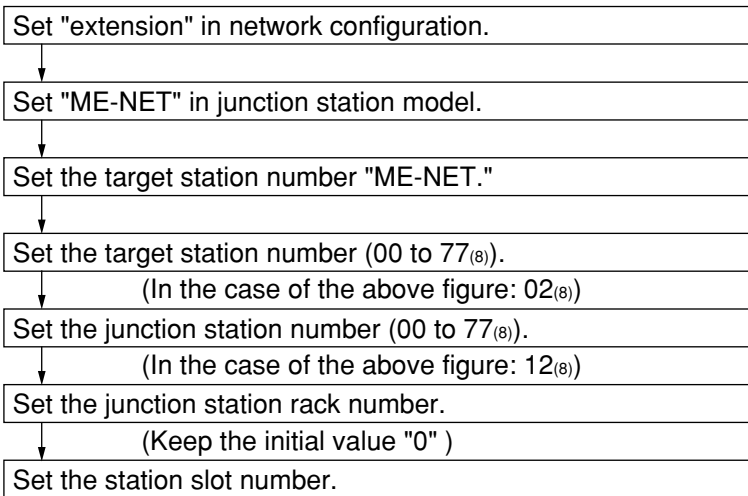

(Set the installed slot number of the master station on the target station side. In the case of the above figure: 3.)

(2) Parameter setting by remote function

This paragraph describes how to set the parameters of other stations' network module (JW-21MN/JW-20MN) connected on the ME-NET. This is only available when the target station is within the standard network connection.

Usable support tools are JW-14PG/13PG/12PG.

< An operation example using the JW-14PG >

- ① Connect the programmer to the JW-21MN on the ME-NET.

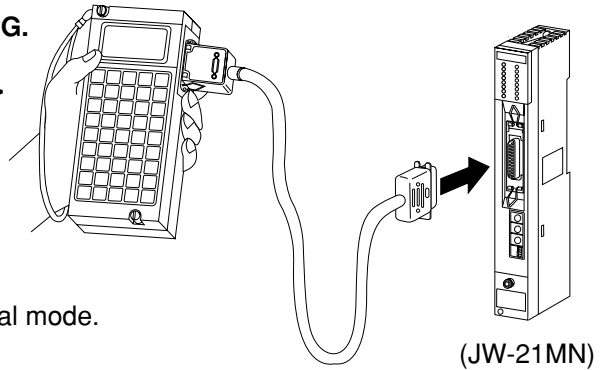

- ② Select initial mode.

→ Display initial mode.

- ③ Assign the parameter setting remotely.

→ Select "LINK" in initial.

→ Select display mode of "1PG, 2PG1 MODE" in specified link.

→ Select target station." in 1PG, 2PG1 MODE.

- ④ Select the target station to set the parameter remotely.

→ Change the code from hexadecimal_(H) display to octal_(O) display and input the target station (00_(O) to 77_(O)).

- ⑤ Communication with the target station.

→ Initiate communication with the target station.

- ⑥ After finishing communication with the target station, set the parameters remotely.

→ Return to initial menu.

- Turn the PC of the target station to program mode (stop PC operation).

- Select "PARAM." in the initial mode.

→ Display the contents of parameter address 007777_(O).
Write 00_(H) to stop operation of the JW-21MN.

(Input address) (Enter the set value)

→ Display the contents of the address and then set the parameters.

- ⑦ Write 81_(H) in parameter address 007777_(O), and then write the parameter contents into the EEPROM of the JW-21MN. Then start operation of the JW-21MN.

(3) Compatible with file register for file 10 to 2C (compatible with the JW-33CUH2/3)

1) When used with a data link

[File 10 to 2C_(H)] (SEG10 to 2C) can be assigned as the top address of the register link area and flag range.

2) When used with a computer link

[File 10 to 2C_(H)] (SEG10 to 2C) can be used to read the current register value (command 24_(H)), write to a register (command 34_(H)), or write to the same data register (command 35_(H)).

Alphabetical Index

[A]

Allocation of relay number	2-3
Appendix	16-1

[B]

Basic commands	10-1, 10-2
Branching method	7-6

[C]

Cable trunk and branch lines	7-1
Cable wiring procedure in control panel	7-2
Check after wiring	7-5
Check flow chart	16-2
Check secret function: JW30H only	10-13
Communication area map	11-7
Communication delay time	9-4
Communication method	9-1
Communication specifications	15-1
Computer link function	10-1
Computer link specifications	15-3
Connector crimping procedure	6-5
Correct clock time	10-9

[D]

Data link (Save memory function)	9-2
Data link (Standard function)	9-1
Data link specifications	15-2
Data transmission between master PC and slave PC	9-5
Description for Computer Link Operation	10-1
Description for Data Link Operation	9-1

[E]

Errors and Countermeasures	12-1
Expansion of network	9-6

[F]

Features and Functions	1-1
Flag table	12-2
Flag	12-2

[G]

General specifications	15-1
------------------------------	------

[H]

Hierarchical link	9-7
-------------------------	-----

[I]

In the case of a master station	12-3
In the case of slave station 01 to 77 ⁽⁸⁾	12-4
Indication lamps	12-1
Initial communication	16-5
Installation	2-1, 5-1

[M]

Maintenance and check	16-1
Maintenance	2-3
Memory address for data links	8-1
Memory Address on the ME-NET	8-1
Mode switch	11-2
Module No. switch	11-2
Monitor operation condition by each station PC	12-5
Monitor step status: JW20/JW20H only	10-9
Monitor TMR, CNT, and MD	10-4
Multiple installation of the JW-21MN	9-6

[N]

Name and Function of Each Part	4-1
--------------------------------------	-----

[O]

Operation procedure	11-1
Optional commands	10-1, 10-3

[P]

Parameter setting by remote function	16-16
Processing cable end	6-2
Processing of Cables	6-1

[R]

Reading date	10-7
Reading memory capacity	10-4
Reading optional parameter	10-10
Reading PC mode	10-5
Reading special I/O parameter	10-11
Reading system memory	10-6
Reading time	10-8
Record and load by ladder software (JW-92SP, JW-50SP)	14-1
Recovery method at communication errors	16-2
Relaying of trunk cables	7-1
Release secret function, register password: JW30H only	10-12
Remote programming and remote monitor	16-13
Replacement of the JW-21MN	13-1
Required transmission time and communication delay time	9-3
Required transmission time	9-3
Response on error	10-14

[S]

Safety Precautions	2-1
Save memory function	15-2
Setting contents of master station parameters	11-5
Setting contents	11-5, 11-22
Setting date	10-7
Setting of Switches and Parameter	11-1
Setting optional parameter	10-10
Setting PC mode	10-5
Setting procedure	11-13, 11-24
Setting range of flag area	11-23
Setting range of relay link area, register link area, and flag area	11-11
Setting secret function: JW30H only	10-12
Setting slave station parameters (common for all slave stations)	11-22

Setting special I/O parameter	10-11
Setting time	10-8
Shield ground switch	11-4
Special functions unique to the JW-21MN	16-13
Specifications	15-1
Standard function	15-2
Static electricity	2-3
Station number switch	11-3
Storage of error code	12-6
Support Tools	14-1
Switch setting of master station and slave station	11-2
System Configuration	3-1

[T]

Table of parameter memory	16-8
Termination resistance switch (LT)	11-3
Treatment	2-3

[W]

Waterproof and insulation processing of connectors	7-4
Wiring Method	7-1
Wiring of cables at outside control panels	7-5
Wiring	2-1
Wiring method for adding a communication station	7-6
Writing system memory	10-6