

Model DPC2505™ and EPC2505™ Cable Modem User's Guide









In This Document

- IMPORTANT SAFETY INSTRUCTIONS 2
- FCC Compliance..... 8
- Introduction 9
- What's in the Carton?..... 10
- Front Panel Description..... 11
- Back Panel Description 12
- Where Is the Best Location for My Cable Modem? 13
- What Are the System Requirements for Internet Service? 14
- How Do I Set Up My High-Speed Internet Access Account? 15
- How Do I Connect My Devices to Use the Internet?..... 16
- How Do I Configure TCP/IP Protocol? 18
- How Do I Install USB Drivers?..... 21
- How Do I Mount the Cable Modem on the Wall?..... 23
- Having Difficulty? 25
- Tips for Improved Performance 27
- How Do I Renew the IP Address on My PC?..... 28
- Front Panel LED Status Indicator Functions 29
- Notices 32

IMPORTANT SAFETY INSTRUCTIONS

Notice to Installers

The servicing instructions in this notice are for use by qualified service personnel only. To reduce the risk of electric shock, do not perform any servicing other than that contained in the operating instructions, unless you are qualified to do so.

<p>Note to System Installer</p> <p>For this apparatus, the coaxial cable shield/ screen shall be grounded as close as practical to the point of entry of the cable into the building. For products sold in the US and Canada, this reminder is provided to call the system installer's attention to Article 820-93 and Article 820-100 of the NEC (or Canadian Electrical Code Part 1), which provides guidelines for proper grounding of the coaxial cable shield.</p>  <p>This symbol is intended to alert you that uninsulated voltage within this product may have sufficient magnitude to cause electric shock. Therefore, it is dangerous to make any kind of contact with any inside part of this product.</p>	<table border="1"> <tr> <td></td> <td style="text-align: center;"> CAUTION RISK OF ELECTRIC SHOCK DO NOT OPEN </td> <td></td> </tr> <tr> <td></td> <td style="text-align: center;"> AVIS RISQUE DE CHOC ÉLECTRIQUE NE PAS OUVRIR </td> <td></td> </tr> </table> <p>CAUTION: To reduce the risk of electric shock, do not remove cover (or back). No user-serviceable parts inside. Refer servicing to qualified service personnel.</p> <p>WARNING TO PREVENT FIRE OR ELECTRIC SHOCK, DO NOT EXPOSE THIS UNIT TO RAIN OR MOISTURE.</p>  <p>This symbol is intended to alert you of the presence of important operating and maintenance (servicing) instructions in the literature accompanying this product.</p>		CAUTION RISK OF ELECTRIC SHOCK DO NOT OPEN			AVIS RISQUE DE CHOC ÉLECTRIQUE NE PAS OUVRIR	
	CAUTION RISK OF ELECTRIC SHOCK DO NOT OPEN						
	AVIS RISQUE DE CHOC ÉLECTRIQUE NE PAS OUVRIR						

20060608SICM-EN

Notice à l'attention des installateurs de réseaux câblés

Les instructions relatives aux interventions d'entretien, fournies dans la présente notice, s'adressent exclusivement au personnel technique qualifié. Pour réduire les risques de chocs électriques, n'effectuer aucune intervention autre que celles décrites dans le mode d'emploi et les instructions relatives au fonctionnement, à moins que vous ne soyez qualifié pour ce faire.

<p>Remarque à l'attention de l'installateur du système</p> <p>Avec cet appareil, le blindage/écran du câble coaxial doit être mis à la terre aussi près que possible du point d'entrée du câble dans le bâtiment. En ce qui concerne les produits vendus aux États-Unis et au Canada, ce rappel est fourni pour attirer l'attention de l'installateur sur les articles 820-93 et 820-100 du Code national de l'électricité (ou Code de l'électricité canadien, Partie 1) qui fournissent des lignes directrices concernant la mise à la terre correcte du blindage (écran) du câble coaxial.</p>  <p>Ce symbole a pour but de vous prévenir que des tensions électriques non isolées existent à l'intérieur de ce produit, pouvant être d'une intensité suffisante pour causer des chocs électriques. Il est donc dangereux d'établir un contact quelconque avec l'une des pièces comprises à l'intérieur de ce produit.</p>	<table border="1"> <tr> <td></td> <td style="text-align: center;"> CAUTION RISK OF ELECTRIC SHOCK DO NOT OPEN </td> <td></td> </tr> <tr> <td></td> <td style="text-align: center;"> ATTENTION DANGER ÉLECTRIQUE NE PAS OUVRIR </td> <td></td> </tr> </table> <p>ATTENTION : Pour réduire les risques de chocs électriques, ne pas enlever le couvercle (ou le panneau arrière). Ne contient aucune pièce réparable par l'utilisateur. Confier les interventions aux techniciens d'entretien qualifiés.</p> <p>AVERTISSEMENT POUR ÉVITER LES INCENDIES OU LES CHOC ÉLECTRIQUES, NE PAS EXPOSER L'APPAREIL À LA PLUIE OU À L'HUMIDITÉ.</p>  <p>Ce symbole a pour but de vous prévenir de la présence d'instructions importantes relatives au fonctionnement ou à l'entretien (et aux réparations) dans la documentation accompagnant ce produit.</p>		CAUTION RISK OF ELECTRIC SHOCK DO NOT OPEN			ATTENTION DANGER ÉLECTRIQUE NE PAS OUVRIR	
	CAUTION RISK OF ELECTRIC SHOCK DO NOT OPEN						
	ATTENTION DANGER ÉLECTRIQUE NE PAS OUVRIR						

20060810SICM-FR

Mitteilung für CATV-Techniker

Die in dieser Mitteilung aufgeführten Wartungsanweisungen sind ausschließlich für qualifiziertes Fachpersonal bestimmt. Um die Gefahr eines elektrischen Schlags zu reduzieren, sollten Sie keine Wartungsarbeiten durchführen, die nicht ausdrücklich in der Bedienungsanleitung aufgeführt sind, außer Sie sind zur Durchführung solcher Arbeiten qualifiziert.

<p>Mitteilung an den Systemtechniker</p> <p>Für dieses Gerät muss der Koaxialkabelschutz/ Schirm so nahe wie möglich am Eintrittspunkt des Kabels in das Gebäude geerdet werden. Dieser Erinnerungshinweis liegt den in den USA oder Kanada verkauften Produkten bei. Er soll den Systemtechniker auf Paragraph 820-93 und Paragraph 820-100 der US-Elektrovorschrift NEC (oder der kanadischen Elektrovorschrift Canadian Electrical Code Teil 1) aufmerksam machen, in denen die Richtlinien für die ordnungsgemäße Erdung des Koaxialkabelschirms festgehalten sind.</p>	 <p>CAUTION RISK OF ELECTRIC SHOCK DO NOT OPEN</p> <p>ACHTUNG STROMSCHLAGEGFAHR, NICHT ÖFFNEN</p>
 <p>Dieses Symbol weist den Benutzer auf das Vorhandensein von nicht isolierten gefährlichen Spannungen im Gerät hin, die Stromschläge verursachen können. Ein Kontakt mit den internen Teilen dieses Produktes ist mit Gefahren verbunden.</p>	<p>ACHTUNG: Zur Vermeidung eines Stromschlags darf die Abdeckung (bzw. die Geräterückwand) nicht entfernt werden. Das Gerät enthält keine vom Benutzer wartbaren Teile. Wartungsarbeiten dürfen nur von qualifiziertem Fachpersonal durchgeführt werden.</p> <p>WARNUNG</p> <p>DAS GERÄT NICHT REGEN ODER FEUCHTIGKEIT AUSSETZEN, UM STROMSCHLAG ODER DURCH EINEN KURZSCHLUSS VERURSACHTEN BRAND ZU VERMEIDEN.</p>
	 <p>Dieses Symbol weist den Benutzer darauf hin, dass die mit diesem Produkt gelieferte Dokumentation wichtige Betriebs- und Wartungsanweisungen für das Gerät enthält.</p>

20060810SICM-GR

Aviso a los instaladores de sistemas CATV

Las instrucciones de reparación contenidas en el presente aviso son para uso exclusivo por parte de personal de mantenimiento cualificado. Con el fin de reducir el riesgo de descarga eléctrica, no realice ninguna otra operación de reparación distinta a las contenidas en las instrucciones de funcionamiento, a menos que posea la cualificación necesaria para hacerlo.

<p>Nota para el instalador del sistema</p> <p>En lo que se refiere a este aparato, el blindaje del cable coaxial debe conectarse a tierra lo más cerca posible al punto por el cual el cable entra en el edificio. En el caso de los productos vendidos en los EE. UU. y Canadá, el presente aviso se suministra para llamar la atención del instalador del sistema sobre los Artículos 820-93 y 820-100 del NEC (o Código Eléctrico de Canadá, Parte 1), que proporcionan directrices para una correcta conexión a tierra del blindaje del cable coaxial.</p>	 <p>CAUTION RISK OF ELECTRIC SHOCK DO NOT OPEN</p> <p>ATENCIÓN RIESGO DE DESCARGA ELÉCTRICA NO ABRIR</p>
 <p>Este símbolo tiene como fin advertirle de que una tensión sin aislamiento en el interior de este producto podría ser de una magnitud suficiente como para provocar una descarga eléctrica. Por consiguiente, resulta peligroso realizar cualquier tipo de contacto con alguno de los componentes internos de este producto.</p>	<p>ATENCIÓN: con el fin de reducir el riesgo de descarga eléctrica, no retire la tapa (ni la parte posterior). No existen en el interior componentes que puedan ser reparados por el usuario. Encargue su revisión a personal de mantenimiento cualificado.</p> <p>ADVERTENCIA</p> <p>PARA EVITAR EL RIESGO DE INCENDIO O DESCARGA ELÉCTRICA, NO EXPONGA LA UNIDAD A LA LLUVIA O A LA HUMEDAD.</p>
	 <p>Este símbolo tiene como fin alertarle de la presencia de importantes instrucciones de operación y mantenimiento (revisión) contenidas en la literatura que acompaña al producto.</p>

20060810SICM-SP

IMPORTANT SAFETY INSTRUCTIONS

Heed All Warnings

Adhere to all warnings on the product and in the operating instructions.

Read, Retain, and Follow These Instructions

Carefully read all safety and operating instructions before operating this product. Follow all operating instructions that accompany this product. Retain the instructions for future use. Give particular attention to all safety precautions.

Comply with Warnings

Avoid electric shock. Comply with all warnings and cautions in the operating instructions, as well as those that are affixed to this product.

Power Warnings

Providing a Power Source

A label on this product indicates the correct power source for this product. Operate this product only from an electrical outlet with the voltage and frequency indicated on the product label.

If you are uncertain of the type of power supply to your home or business, consult your service provider or your local power company.

Grounding This Product (U.S.A. and Canada Only)



WARNING:

Avoid electric shock and fire hazard! Do not defeat the safety purpose of the polarized or grounding-type plug. A polarized plug has two blades with one wider than the other. A grounding-type plug has two blades and a third grounding prong. The wide blade or the third prong is provided for your safety. If the provided plug does not fit into your outlet, consult an electrician for replacement of the obsolete outlet.

If this product is equipped with either a three-prong (grounding pin) safety plug or a two-prong (polarized) safety plug, do not defeat the safety purpose of the polarized or grounding-type plug. Follow these safety guidelines to properly ground this product:

- For a 3-prong plug (consists of two blades and a third grounding prong), insert the plug into a grounded mains, 3-prong outlet.

Note: This plug fits only one way. The grounding prong is provided for your safety. If you are unable to insert this plug fully into the outlet, contact your electrician to replace your obsolete outlet.

- For a 2-prong plug (consists of one wide blade and one narrow blade), insert the plug into a polarized mains, 2-prong outlet in which one socket is wider than the other.

Note: If you are unable to insert this plug fully into the outlet, try reversing the plug. The wide blade is provided for your safety. If the plug still fails to fit, contact an electrician to replace your obsolete outlet.

Overloading



WARNING:

Avoid electric shock and fire hazard! Do not overload mains AC outlets and extension cords. For products that require battery power or other power sources to operate them, refer to the operating instructions for those products.

Do not overload electrical outlets, extension cords, or integral convenience receptacles as this can result in a risk of fire or electric shock. For products that require battery power or other sources to operate, refer to the operating instructions for that product.

Preventing Power Cord Damage

Protect the power cord from being walked on or pinched, particularly at plugs, convenience receptacles, and the point where they exit from the apparatus. Arrange all power cords so that pets cannot walk on or disturb the cords. Do not place objects on or lean objects against the cords, which can damage the cords.

Usage Warnings

Providing Ventilation

- Do not block any ventilation openings. Install in accordance with the manufacturer's instructions.
- Do not place this apparatus on a bed, sofa, rug, or similar surface.
- Do not install near any heat sources such as radiators, heat registers, stoves, or other apparatus (including amplifiers) that produce heat.
- Do not install this apparatus in an enclosure, such as a bookcase or rack, unless the installation provides proper ventilation.
- Do not place entertainment devices (such as VCRs or DVDs), lamps, books, vases with liquids, or other objects on top of this product.
- Do not use this apparatus near water.

Selecting a Proper Location



WARNING:

Avoid personal injury and damage to this product! An unstable surface may cause this product to fall.

Place this product on a stable surface. The surface must support the size and weight of this product. Any mounting accessory used must be recommended by the manufacturer. The product should be mounted to a wall or ceiling only as recommended by the manufacturer.

Important! The power cord is the mains power supply disconnect device.

Place this product in a location that is close enough to an electrical outlet and where the power cord is easily accessible to be disconnected from the wall outlet or from the rear panel of the product.

IMPORTANT SAFETY INSTRUCTIONS

Cleaning This Product



WARNING:

Avoid electric shock! Unplug this product before cleaning. Clean only with a dry cloth.

Before cleaning this product, unplug it from the electrical outlet. Clean this product only with a dry cloth. Do not use a liquid cleaner or an aerosol cleaner. Do not use a magnetic/static cleaning device (dust remover) to clean this product.

Protecting This Product from Foreign Objects and Water or Moisture Damage



WARNING:

Avoid electric shock and fire hazard! Never push objects through the openings in this product. Foreign objects can cause electrical shorts that can result in electric shock or fire. Do not expose this product to rain or moisture. Do not place objects filled with liquid, such as vases, on this product.

Never push objects of any kind into this product through openings as they may touch dangerous voltage points or short out parts that could result in a fire or electric shock.

Do not expose this product to liquids or moisture. Do not place this product on a wet surface. Do not spill liquids on or near this product.

Do not use this product near water (such as a bathtub, washbowl, sink, or laundry tub), in a wet basement, or near a swimming pool.

Accessories Warnings



WARNING:

Avoid any potential for electric shock or fire. Only use attachments/accessories specified by the manufacturer.

Do not use accessories or attachments with this product unless recommended by your service provider or manufacturer.

Service Warnings

Servicing This Product



WARNING:

Avoid electric shock! Opening or removing the cover may expose you to dangerous voltages. This product contains no user-serviceable parts. Refer all servicing to qualified service personnel.

Do not open the cover of this product. If you open the cover, your warranty will be void. Refer all servicing to qualified personnel only. Contact your service provider for instructions.

Obtaining Service for Product Damage

For damage that requires service, unplug this product from the AC outlet. Refer all servicing to your service provider or qualified service personnel. Servicing is required when:

- The apparatus has been damaged in any way
- A power-supply cord or plug is damaged
- Liquid has been spilled or objects have fallen into the apparatus
- The apparatus has been exposed to rain or moisture
- The apparatus does not operate normally
- The apparatus has been dropped

Checking Product Safety

Upon completion of any service or repairs to this product, the service technician must perform safety checks to determine that this product is in proper operating condition.

Lightning

For added protection, unplug this apparatus during lightning storms or when unused for long periods of time. In addition to disconnecting the AC power from the wall outlet, disconnect the signal inputs. This may prevent damage to the apparatus due to lightning and power-line surges. Plugging this apparatus into a surge protector may reduce the risk of damage.

20060712MDBN

FCC Compliance

United States FCC Compliance

This device has been tested and found to comply with the limits for a Class B digital device, pursuant to part 15 of the FCC Rules. These limits are designed to provide reasonable protection against such interference in a residential installation. This equipment generates, uses, and can radiate radio frequency energy. If not installed and used in accordance with the instructions, it may cause harmful interference to radio communications. However, there is no guarantee that interference will not occur in a particular installation. If this equipment does cause harmful interference to radio or television reception, which can be determined by turning the equipment OFF and ON, the user is encouraged to try to correct the interference by one or more of the following measures:

- Reorient or relocate the receiving antenna.
- Increase the separation between the equipment and receiver.
- Connect the equipment into an outlet on a circuit different from that to which the receiver is connected.
- Consult the cable company or an experienced radio/television technician for help.

Any changes or modifications not expressly approved by Scientific-Atlanta, Inc., could void the user's authority to operate the equipment.

The information shown in the FCC Declaration of Conformity paragraph below is a requirement of the FCC and is intended to supply you with information regarding the FCC approval of this device. *The phone numbers listed are for FCC-related questions only and not intended for questions regarding the connection or operation for this device. Please contact your service provider for any questions you may have regarding the operation or installation of this device.*

Declaration of Conformity

This device complies with Part 15 of FCC Rules. Operation is subject to the following two conditions: 1) the device may not cause harmful interference, and 2) the device must accept any interference received, including interference that may cause undesired operation.

Data Cable Modem DPC2505 and EPC2505 Manufactured by: Scientific-Atlanta, Inc. 5030 Sugarloaf Parkway Lawrenceville, Georgia 30044 USA Telephone: 770-236-1077
--

Canada EMI Regulation

This Class B digital apparatus complies with Canadian ICES-003.

Cet appareil numérique de la class B est conforme à la norme NMB-003 du Canada.

20060628FDC

Introduction

Welcome to the exciting world of high-speed Internet access. You have acquired one of the fastest cable modems available on the market today. Your new Model DPC2505 or Model EPC2505 Wideband Cable Modem offers high-end performance and unsurpassed reliability at data rates up to three times that of conventional DOCSIS 2.0 (DPC2505) and EuroDOCSIS (EPC2505) cable modems. With your new DPC2505 or EPC2505, your Internet enjoyment and business productivity will surely soar.

This guide provides procedures and recommendations for placing, installing, configuring, operating, and troubleshooting your DPC2505 or EPC2505.

Benefits and Features

Your new DPC2505 or EPC2505 offers the following additional outstanding benefits and features:

- Provides a high-speed broadband Internet connection that energizes your online experience, which makes downloading and sharing files and photos with your family and friends hassle free
- Features Plug and Play operation for easy set up and installation
- Offers a Gigabit Ethernet port supporting both Gigabit and 10/100BaseT speeds
- Includes both a USB 2.0 data port that is backwards compatible with USB 1.1
- Supports up to 64 users (1 USB port and up to 63 users on user-supplied Ethernet hubs)
- Utilizes vertical or horizontal placement
- Allows automatic software upgrades by your service provider
- Ensures interoperability with most service providers by complying with the following specifications:
 - DPC2505 – DOCSIS 2.0 and backward compatibility for operation in DOCSIS 1.1 and DOCSIS 1.0 networks
 - EPC2505 – EuroDOCSIS 2.0 and backward compatibility for operation in EuroDOCSIS 1.1 and EuroDOCSIS 1.0 networks

What's in the Carton?

When you receive your cable modem, you should check the equipment and accessories to verify that each item is in the carton and that each item is undamaged. The carton contains the following items:



One Model DPC2505 or EPC2505 Cable Modem



One Ethernet cable (CAT5/RJ-45)



One power adapter with power cord



One USB cable (not included with all models)



One CD-ROM containing the user's guide and the USB drivers

If any of these items are missing or damaged, please contact your service provider for assistance.

Note: You will need an optional cable signal splitter and additional standard RF coaxial cables if you want to connect a VCR, a Digital Home Communications Terminal (DHCT) or a set-top converter, or a TV to the same cable connection as your cable modem.

Front Panel Description

The front panel of your cable modem provides LED status indicators that indicate how well and at what state your cable modem is operating. After the cable modem is successfully registered on the network, the **POWER** and **ONLINE** LED status indicators illuminate continuously to show that the cable modem is active and fully operational. See *Front Panel LED Status Indicator Functions* (on page 29) for more information on front panel LED status indicator functions.

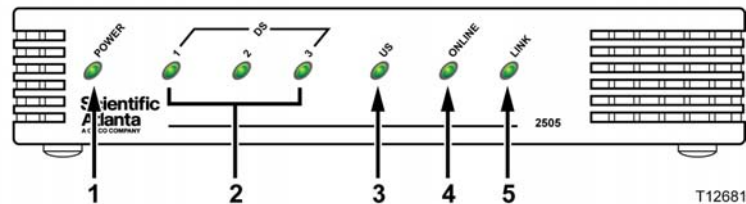

- 1 **POWER** – Illuminates solid green to indicate that power is being applied to the cable modem
- 2 **DS 1 (Downstream LED 1)** – Illuminates solid green to indicate that the cable modem is locked onto the downstream signal or blinks to indicate that the cable modem is scanning for the downstream signal
DS 2-3 (Downstream LEDs 2-3) – Off while the cable modem is connecting to the network, after connecting, illuminate solid green to indicate wideband operation, and Off if no wideband channels are found
- 3 **US (Upstream)** – Off when no upstream connectivity is present, illuminates solid green to indicate the upstream connection is operational, blinks to indicate that upstream calibration is in progress and during registration with the system. Off when the modem is off-line.
- 4 **ONLINE** – Illuminates solid green when the cable modem is registered on the network and fully operational
- 5 **LINK** – Off when no Ethernet/USB device is present, illuminates solid green to indicate that an Ethernet/USB device is connected, and blinks to indicate that Ethernet/USB data is being transferred between the PC and the cable modem

Note: After the cable modem is successfully registered on the network, the **POWER** (LED 1) and **ONLINE** (LED 4) indicators illuminate continuously to indicate that the cable modem is online and fully operational.

Back Panel Description

The following illustration describes the back panel components of the DPC2505 and EPC2505 wideband cable modems.

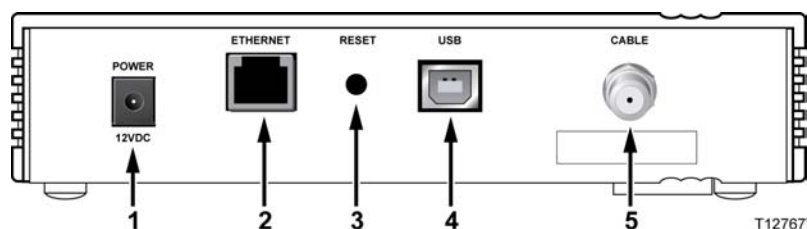

- 1 **POWER 12VDC**—Connects the cable modem to the DC output of the AC power adapter that is provided with your cable modem. Only use the AC power adapter and power cord that is provided with your cable modem



CAUTION:

Avoid damage to your equipment. Only use the AC power adapter and power cord that is provided with your cable modem.

- 2 **ETHERNET** – RJ-45 Gigabit Ethernet port connects to the Ethernet port on your PC
- 3 **RESET** – Reset-to-Default button (Factory Reset)
Note: This button is for maintenance purposes only. Do not use unless told to do so by your service provider.
- 4 **USB** – USB 2.0 port connects to the USB port on your PC
- 5 **CABLE** – F-Connector connects to an active cable signal from your service provider

Where Is the Best Location for My Cable Modem?

The ideal location for your cable modem is where it has access to outlets and other devices. Think about the layout of your home or office, and consult with your service provider to select the best location for your cable modem. Read this user's guide thoroughly before you decide where to place your cable modem.

Consider these recommendations:

- Position your PC and cable modem so that they are located near an AC power outlet.
- Position your PC and cable modem so that they are located near an existing cable input connection to eliminate the need for an additional cable outlet. There should be plenty of room to guide the cables away from the modem and the PC without straining or crimping them.
- Airflow around the cable modem should not be restricted.
- Choose a location that protects the cable modem from accidental disturbance or harm.

What Are the System Requirements for Internet Service?

To ensure that your cable modem operates efficiently for high-speed Internet service, verify that all of the Internet devices on your system meet or exceed the following minimum hardware and software requirements.

Note: You will also need an active cable input line and an Internet connection.

Minimum System Requirements for a PC

- A PC with a Pentium MMX 133 processor or greater
- 32 MB of RAM
- Web browsing software
- CD-ROM drive

Minimum System Requirements for Macintosh

- MAC OS 7.5 or later
- 32 MB of RAM

System Requirements for an Ethernet Connection

- A PC with Microsoft Windows 95 operating system (or later) with TCP/IP protocol installed, or an Apple Macintosh computer with TCP/IP protocol installed
- An active Gigabit Ethernet or 10/100BaseT Ethernet network interface card (NIC) installed

System Requirements for a USB Connection

- A PC with Microsoft Windows 2000 or Windows XP operating system
- A master USB port installed in your PC

How Do I Set Up My High-Speed Internet Access Account?

Before you can use your cable modem, you need to have a high-speed Internet access account. If you do not have a high-speed Internet access account, you need to set up an account with your local service provider. Choose one of the two options in this section.

I Do Not Have a High-Speed Internet Access Account

If you do *not* have a high-speed Internet access account, your service provider will set up your account and become your Internet Service Provider (ISP). Internet access enables you to send and receive e-mail, access the World Wide Web, and receive other Internet services.

You will need to give your service provider the following information:

- The serial number of the modem
- The Media Access Control (MAC) address of the modem

These numbers appear on a bar code label located on the cable modem. The serial number consists of a series of alphanumeric characters preceded by **S/N**. The MAC address consists of a series of alphanumeric characters preceded by **CM MAC**. The following illustration shows a sample bar code label.



Write down these numbers in the space provided here.

Serial Number _____

MAC Address _____

I Already Have an Existing High-Speed Internet Access Account

If you have an existing high-speed Internet access account, you must give your service provider the serial number and the MAC address of the cable modem. Refer to the serial number and MAC address information listed previously in this section.

Note: You may not be able to continue to use your existing e-mail account with your cable modem. Contact your service provider for more information.

How Do I Connect My Devices to Use the Internet?

You can use your cable modem to access the Internet, and you can share that Internet connection with other Internet devices in your home or office. Sharing one connection among many devices is called networking.

Connecting and Installing Internet Devices

You must connect and install your cable modem to access the Internet. Professional installation may be available. Contact your local service provider for further assistance.

To connect devices

The following diagram illustrates one of the various networking options that are available to you.

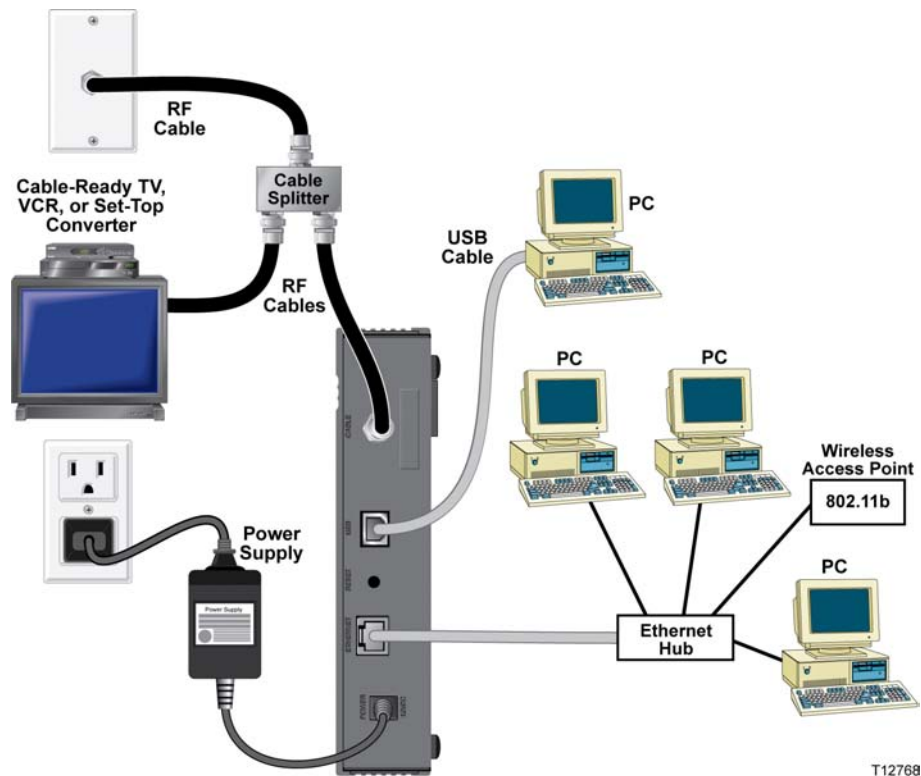

Connecting the Modem for High-Speed Data Service



WARNING:

To avoid personal injury or damage to your equipment, follow these steps in the exact order shown.

- 1 Power off your PC and unplug it from the power source.
- 2 Connect your PC to *either* the **ETHERNET** port *or* the **USB** port using the appropriate data cable. Do *not* connect your PC to *both* the Ethernet and USB ports at the same time. You can connect two separate PCs to the cable modem at the same time by connecting one PC to the Ethernet port and one PC to the USB port.
- 3 Connect the active RF coaxial cable to the **CABLE** connector. Use an optional cable signal splitter to add a TV, a DHCT or set-top converter, or a VCR.
- 4 Insert the AC power cord into the **POWER** connector on the back of the cable modem, and then plug the cord into an AC power source.
- 5 Plug in and power on your networked devices including your PC. The cable modem will then begin an automatic search to locate and sign on to the broadband data network. This process may take up to 5 minutes. The modem will be ready for use when the **ONLINE** LED status indicator on the front panel stops blinking and illuminates continuously.
- 6 The next step in setting up your cable modem is to configure your Internet devices for Internet access. Choose one of the following options:
 - If you want to use Ethernet connections, you must configure the TCP/IP protocol. To configure the TCP/IP protocol, go to *How Do I Configure TCP/IP Protocol?* (on page 18).
 - If you want to use USB connections, you must install the USB drivers. To install the USB Drivers for USB, go to *How Do I Install USB Drivers?* (on page 21).

How Do I Configure TCP/IP Protocol?

To configure TCP/IP protocol, you need to have an Ethernet Network Interface Card (NIC) with TCP/IP communications protocol installed on your system. TCP/IP is a communications protocol used to access the Internet. This section contains instructions for configuring TCP/IP on your Internet devices to operate with the cable modem in Microsoft Windows or Macintosh environments.

Configuring TCP/IP on Your Internet Devices

TCP/IP protocol in a Microsoft Windows environment is different for each operating system. Follow the appropriate instructions in this section for your operating system.

Configuring TCP/IP on Windows 95, 98, 98SE, or ME Systems

- 1 Click **Start**, select **Settings**, and choose **Control Panel**.
- 2 Double-click the **Network** icon in the Control Panel window.
- 3 Read the list of installed network components under the **Configuration** tab to verify that your PC contains the TCP/IP protocol/Ethernet adapter.
- 4 Is TCP/IP protocol listed in the installed network components list?
 - If **yes**, go to step 7.
 - If **no**, click **Add**, click **Protocol**, click **Add**, and then go to step 5.
- 5 Click **Microsoft** in the Manufacturers list.
- 6 Click **TCP/IP** in the Network Protocols list, and then click **OK**.
- 7 Click the **TCP/IP Ethernet Adapter** protocol, and then choose **Properties**.
- 8 Click the **IP Address** tab, and then select **Obtain an IP address automatically**.
- 9 Click the **Gateway** tab and verify that these fields are empty. If they are not empty, highlight and delete all information from the fields.
- 10 Click the **DNS Configuration** tab, and then select **Disable DNS**.
- 11 Click **OK**.
- 12 Click **OK** when the system finishes copying the files, and then close all networking windows.
- 13 Click **YES** to restart your computer when the System Settings Change dialog box opens. The computer restarts. The TCP/IP protocol is now configured on your PC, and your Ethernet devices are ready for use.
- 14 Try to access the Internet. If you cannot access the Internet, go to *Having Difficulty?* (on page 25). If you still cannot access the Internet, contact your service provider for further assistance.

Configuring TCP/IP on Windows 2000 Systems

- 1 Click **Start**, select **Settings**, and choose **Network and Dial-up Connections**.
- 2 Double-click the **Local Area Connection** icon in the Network and Dial-up Connections window.
- 3 Click **Properties** in the Local Area Connection Status window.
- 4 Click **Internet Protocol (TCP/IP)** in the Local Area Connection Properties window, and then click **Properties**.
- 5 Select both **Obtain an IP address automatically** and **Obtain DNS server address automatically** in the Internet Protocol (TCP/IP) Properties window, and then click **OK**.
- 6 Click **Yes** to restart your computer when the Local Network window opens. The computer restarts. The TCP/IP protocol is now configured on your PC, and your Ethernet devices are ready for use.
- 7 Try to access the Internet. If you cannot access the Internet, go to *Having Difficulty?* (on page 25). If you still cannot access the Internet, contact your service provider for further assistance.

Configuring TCP/IP on Windows XP Systems

- 1 Click **Start**, and depending on your Start menu setup, choose one of the following options:
 - If you are using the Windows XP Default Start Menu, select **Connect to**, choose **Show all connections**, and then go to step 2.
 - If you are using the Windows XP Classic Start Menu, select **Settings**, choose **Network Connections**, click **Local Area Connection**, and then go to step 3.
- 2 Double-click the **Local Area Connection** icon in the LAN or High-Speed Internet section of the Network Connections window.
- 3 Click **Properties** in the Local Area Connection Status window.
- 4 Click **Internet Protocol (TCP/IP)**, and then click **Properties** in the Local Area Connection Properties window.
- 5 Select both **Obtain an IP address automatically** and **Obtain DNS server address automatically** in the Internet Protocol (TCP/IP) Properties window, and then click **OK**.
- 6 Click **Yes** to restart your computer when the Local Network window opens. The computer restarts. The TCP/IP protocol is now configured on your PC, and your Ethernet devices are ready for use.
- 7 Try to access the Internet. If you cannot access the Internet, go to *Having Difficulty?* (on page 25). If you still cannot access the Internet, contact your service provider for further assistance.

Configuring TCP/IP on Macintosh Systems

- 1 Click the **Apple** icon in the upper-left corner of the Finder. Scroll down to **Control Panels**, and then click **TCP/IP**.
- 2 Click **Edit** on the Finder at the top of the screen. Scroll down to the bottom of the menu, and then click **User Mode**.
- 3 Click **Advanced** in the User Mode window, and then click **OK**.
- 4 Click the Up/Down selector arrows located to the right of the Connect Via section of the TCP/IP window, and then click **Using DHCP Server**.
- 5 Click **Options** in the TCP/IP window, and then click **Active** in the TCP/IP Options window.
Note: Make sure that the **Load only when needed option** is *unchecked*.
- 6 Verify that the **Use 802.3** option located in the upper-right corner of the TCP/IP window is unchecked. If there is a check mark in the option, uncheck the option, and then click **Info** in the lower-left corner.
- 7 Is there a Hardware Address listed in this window?
 - If **yes**, click **OK**. To close the TCP/IP Control Panel window, click **File**, and then scroll down to click **Close**. You have completed this procedure.
 - If **no**, you must power off your Macintosh.
- 8 With the power off, simultaneously press and hold down the **Command (Apple)**, **Option**, **P**, and **R** keys on your keyboard. Keeping those keys pressed down, power on your Macintosh but do not release these keys until you hear the Apple chime at least three times, then release the keys and let the computer restart.
- 9 When your computer fully reboots, repeat steps 1 through 7 to verify that all TCP/IP settings are correct. If your computer still does not have a Hardware Address, contact your authorized Apple dealer or Apple technical support center for further assistance.

How Do I Install USB Drivers?

To install USB drivers, your PC must be equipped with a USB network interface and a Microsoft Windows 2000 or Windows XP operating system. This section contains instructions for installing the USB drivers for the cable modem.

Note: If you are not using the USB interface, skip this section.

Installing USB Drivers

The USB driver installation procedures are different for each operating system. Follow the appropriate instructions in this section for your operating system.

Installing USB Drivers on Windows 2000 Systems

- 1 Insert the **USB Cable Modem Driver Installation Disk** into the CD-ROM drive of your PC.
- 2 Wait until the **POWER** and **ONLINE** LED status indicators on the front panel of the cable modem illuminate solid green.
- 3 Click **Next** in the Found New Hardware Wizard window.
- 4 Select **Search for a suitable driver for my device (recommended)** in the Found New Hardware Wizard window, and then click **Next**.
- 5 Select **CD-ROM drives** in the Found New Hardware Wizard window, and then click **Next**.
- 6 Click **Next** in the Found New Hardware Wizard window. The system searches for the driver file for your hardware device.
- 7 After the system finds the USB driver, the Digital Signature Not Found window opens and displays a confirmation message to continue the installation.
- 8 Click **Yes** to continue the installation. The Found New Hardware Wizard window reopens with a message that the installation is complete.
- 9 Click **Finish** to close the Found New Hardware Wizard window. The USB drivers are installed on your PC, and your USB devices are ready for use.
- 10 Try to access the Internet. If you cannot access the Internet, go to *Having Difficulty?* (on page 25). If you still cannot access the Internet, contact your service provider for further assistance.

Installing USB Drivers on Windows XP Systems

- 1 Insert the **USB Cable Modem Driver Installation Disk** into the CD-ROM drive of your PC.
- 2 Wait until the **POWER** and **ONLINE** LED status indicators on the front panel of the cable modem illuminate solid green.
- 3 Select **Install from a list or specific location (Advanced)** in the Found New Hardware Wizard window, and then click **Next**.

How Do I Install USB Drivers?

- 4 Select **Search removable media (floppy, CD-ROM)** in the Found New Hardware Wizard window, and then click **Next**.
- 5 Click **Continue Anyway** in the Hardware Installation window to continue the installation. The Found New Hardware Wizard window reopens with a message that the installation has finished.
- 6 Click **Finish** to close the Found New Hardware Wizard window. The USB drivers are installed on your PC, and your USB devices are ready for use.
- 7 Try to access the Internet. If you cannot access the Internet, go to *Having Difficulty?* (on page 25). If you still cannot access the Internet, contact your service provider for further assistance.

How Do I Mount the Cable Modem on the Wall?

Before You Begin

Before you begin, choose an appropriate mounting place. The wall can be made of cement, wood, or drywall. The mounting location should be free of obstructions on all sides, and the cables should be able to easily reach the cable modem without strain. Leave sufficient clearance between the bottom of the cable modem, and any flooring or shelving underneath, to allow access to cabling. In addition, leave enough slack in all cables so that the cable modem can be removed for any required maintenance without disconnecting the cables. Also, verify that you have the following items:

- Two wall anchors for #8 x 1 inch screws
- Two #8 x 1 inch pan head sheet metal screws
- Drill with a 3/16-in. wood or masonry bit
- A copy of the wall-mounting illustrations shown on the following pages

Mounting Instructions

You can mount the DPC2505/EPC2505 cable modem directly on a wall using two wall anchors, two screws, and the mounting slots on the bottom of the modem. The modem can be mounted vertically or horizontally.

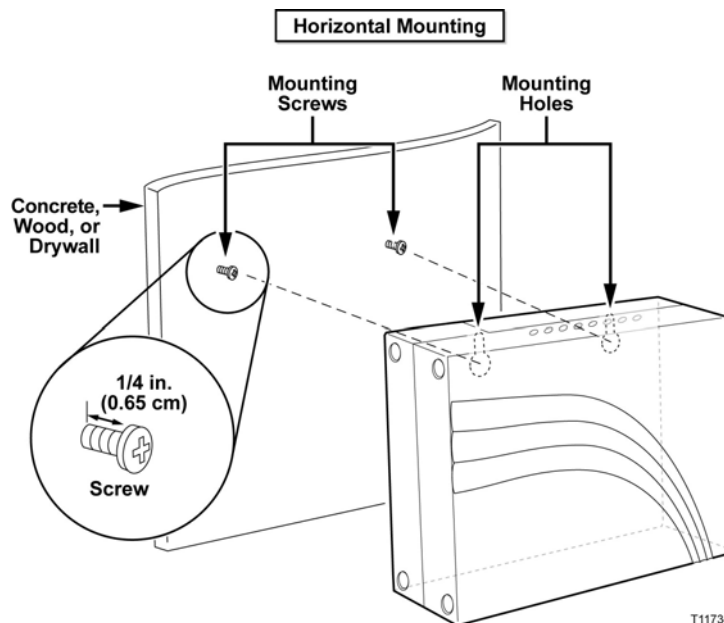

Location and Dimensions of the Wall-Mounting Slots

The following illustration shows the location and dimensions of the wall-mounting slots on the bottom of the modem. Use the information on this page as a guide for mounting your modem to the wall.

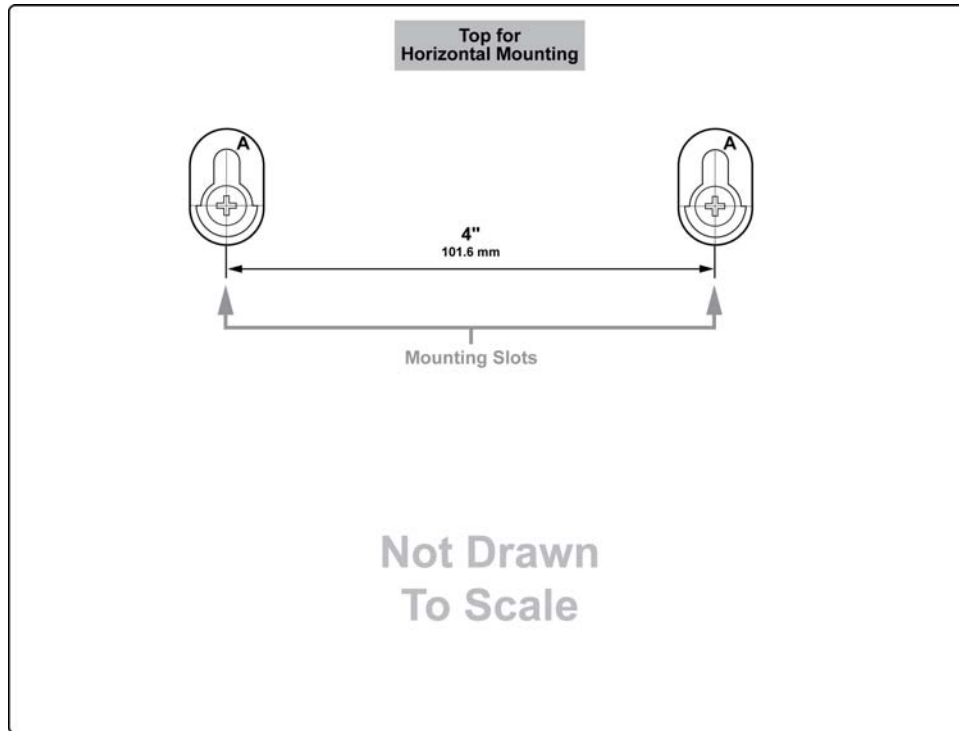

Wall Mounting Instructions

Complete these steps to mount the modem to the wall.

- 1 Using a drill with a 3/16-in bit, drill two holes at the same height and 4 inches apart.
- 2 Are you mounting the cable modem into a drywall or concrete surface where a wooden stud is not available?
 - If **yes**, drive the anchor bolts into the wall and then go to step 3.
 - If **no**, go to step 3.
- 3 Install the mounting screws into the wall or the anchor bolts, as appropriate, and leave a gap of about 1/4-in. between the screw head and the wall.
- 4 Verify that no cables or wires are connected to the cable modem.
- 5 Lift the cable modem into position. Slip the large end of both mounting slots (located on the back of the modem) over the mounting screws, and then slide the modem down until the narrow end of the keyhole slot contacts the shaft of the screw.

Important! Verify that the mounting screws securely support the modem before you release the unit.

Having Difficulty?

Frequently Asked Questions

Q. What if I don't subscribe to cable TV?

A. If cable TV is available in your area, data service may be made available with or without subscribing to cable TV service. Contact your local service provider for complete information on cable services, including high-speed Internet access.

Q. How do I arrange for installation?

A. Call your service provider to inquire about professional installation. A professional installation ensures proper cable connection to the modem and to your PC, and it ensures the proper configuration of all hardware and software settings. Contact your cable telephony service provider for more information about installation.

Q. How does the cable modem connect to my computer?

A. The cable modem connects to the USB port or to the 10/100BaseT Ethernet port on your PC. If you want to use an Ethernet interface, Ethernet cards available from your local PC or office supply retailer, or from your service provider.

Q. After my cable modem is connected, how do I access the Internet?

A. Your local service provider becomes your Internet Service Provider (ISP). They offer a wide range of services including e-mail, chat, news, and information services. Your service provider will provide the software you will need.

Q. Can I watch TV and surf the Internet at the same time?

A. Absolutely! If you subscribe to cable television service, you can watch TV and use your cable modem at the same time by connecting your TV and your cable modem to the cable network using an optional cable signal splitter.

Q. Can I run more than one device on the modem?

A. Yes. A single cable modem will theoretically support up to 253 Ethernet devices utilizing user-supplied Ethernet hubs or routers that you can purchase at your local PC or office supply retailer. Another user at your location can simultaneously connect to the USB port on the cable modem. Contact your service provider for further assistance.

Common Troubleshooting Issues

I don't understand the front panel status indicators

See *Front Panel LED Status Indicator Functions* (on page 29), for more detailed information on front panel LED status indicator operation and function.

The cable modem does not register an Ethernet connection

- Verify that your computer has an Ethernet card and that the Ethernet driver software is properly installed. If you purchase and install an Ethernet card, follow the installation instructions very carefully.
- Verify the status of the front panel status indicator lights.

The cable modem does not register an Ethernet connection after connecting to a hub

If you are connecting multiple PCs to the cable modem, you should first connect the modem to the uplink port of the hub using the correct crossover cable. The LINK LED of the hub will illuminate continuously.

The cable modem does not register a cable connection

- The modem works with a standard 75-ohm RF coaxial cable. If you are using a different cable, your cable modem will not function properly. Contact your service provider to determine whether you are using the correct cable.
- Your NIC card or USB interface may be malfunctioning. Refer to the troubleshooting information in the NIC or USB documentation.

Tips for Improved Performance

Check and Correct

If your cable modem does not perform as expected, the following tips may help. If you need further assistance, contact your service provider.

- Verify that the plug to your cable modem AC power is properly inserted into an electrical outlet.
- Verify that your cable modem AC power cord is not plugged into an electrical outlet that is controlled by a wall switch. If a wall switch controls the electrical outlet, make sure the switch is in the **ON** position.
- Verify that the **POWER** and **ONLINE** LED status indicators on the front panel of your cable modem are illuminated.
- Verify that your cable service is active and that it supports two-way service.
- Verify that all cables are properly connected, and that you are using the correct cables.
- Verify that your TCP/IP is properly installed and configured if you are using the Ethernet connection.
- Verify that you have followed the procedures in *How Do I Install USB Drivers?* (on page 21), if you are using the USB connection.
- Verify that you have called your service provider and given them the serial number and MAC address of your cable modem.
- If you are using a cable signal splitter so that you can connect the cable modem to other devices, remove the splitter and reconnect the cables so that the cable modem is connected directly to the cable input. If the cable modem now functions properly, the cable signal splitter may be defective and may need to be replaced.
- For best performance over an Ethernet connection, your PC should be equipped with a 10/100BaseT network interface card.

How Do I Renew the IP Address on My PC?

If your PC cannot access the Internet after the cable modem is online, it is possible that your PC did not renew its IP address. Follow the appropriate instructions in this section for your operating system to renew the IP address on your PC.

Renewing the IP address on Windows 95, 98, 98SE, and ME Systems

- 1 Click **Start**, and then click **Run** to open the Run window.
- 2 Type **wiipcfg** in the Open field, and click **OK** to execute the winipcfg command. The IP Configuration window opens.
- 3 Click the down arrow to the right of the top field, and select the Ethernet adapter that is installed on your PC. The IP Configuration window displays the Ethernet adapter information.
- 4 Click **Release**, and then click **Renew**. The IP Configuration window displays a new IP address.
- 5 Click **OK** to close the IP Configuration window, you have completed this procedure.

Note: If you cannot access the Internet, contact your service provider for further assistance.

Renewing the IP Address on Windows NT, 2000, or XP Systems

- 1 Click **Start**, and then click **Run**. The Run window opens.
- 2 Type **cmd** in the Open field and click **OK**. A window with a command prompt opens.
- 3 Type **ipconfig/release** at the C:/ prompt and press **Enter**. The system releases the IP address.
- 4 Type **ipconfig/renew** at the C:/ prompt and press **Enter**. The system displays a new IP address.
- 5 Click the **X** in the upper-right corner of the window to close the Command Prompt window. You have completed this procedure.

Note: If you cannot access the Internet, contact your service provider for further assistance.

Front Panel LED Status Indicator Functions

Initial Power Up, Calibration, and Registration

The following chart illustrates the sequence of steps and the corresponding appearance of the cable modem front panel LED status indicators during power-up, calibration, and registration on the network. Use this chart to troubleshoot the power up, calibration, and registration process of your cable modem.

Note: After the cable modem completes step 8 (Registration Complete), the modem proceeds immediately to step 9. See the chart in *Normal Operations* (on page 30).

Front Panel LED Status Indicators During Initial Power-Up, Calibration, and Registration									
Step		1	2	3	4	5	6	7	8
Front Panel Indicator		Power Up	Self Test	Downstream Scan	Downstream Signal Lock	Ranging	Requesting IP Address	Registering	Registration Complete
1	POWER	On	On	On	On	On	On	On	On
2	DS 1	Blinks	On 1 sec	Blinks	On	On	On	On	On
	DS 2-3	Blinks	On 1 sec	Off	Off	Off	Off	Off	<ul style="list-style-type: none"> ■ On when wideband operation is enabled on that channel ■ Off when wideband operation is not available on that channel
3	US	Blinks	On 1 sec	Off	Off	Blinks	On	On	On
4	ONLINE	Blinks	On 1 sec	Off	Off	Off	Off	Blinks	On
5	LINK	Off	On 1 sec	Off - When no devices are connected to the Ethernet or USB ports On - When devices are connected to the Ethernet or USB ports Blinks - When data activity is present					On

Normal Operations

The following chart illustrates the appearance of the cable modem front panel LED status indicators during normal operations.

Front Panel LED Status Indicators During Normal Operations		
Step	9	
Front Panel Indicator	Normal Operations	
1	POWER	On
2	DS 1	On
	DS 2-3	On - When wideband operation is enabled on that channel Off - When wideband operation is not available on that channel
3	US	On
4	ONLINE	On
5	LINK	<p>ON - When a single device is connected to either the Ethernet or USB port and no data is being sent to or from the modem</p> <p>BLINKS - When only one Ethernet or USB device is connected and data is being transferred between the consumer premise equipment (CPE) and the cable modem</p> <p>OFF - When no devices are connected to either the Ethernet or USB ports</p> <p>Notes:</p> <ul style="list-style-type: none"> ■ When both Ethernet and USB devices are connected to the modem at the same time, and data is being transferred through only one of the devices (Ethernet or USB), the LINK LED status indicator illuminates continuously. ■ Whenever data is being sent through <i>both</i> data ports (Ethernet and USB) simultaneously, the indicator blinks as described above.

Special Conditions

The following chart describes the appearance of the cable modem front panel LED status indicators during special conditions to show that you have been denied network access.

Front Panel LED Status Indicators During Special Conditions		
Front Panel Indicator		Network Access Denied
1	POWER	On
2	DS (1-3)	Blinking 2 times per second
3	US	Blinking 2 times per second
4	ONLINE	Blinking 2 times per second
5	LINK	<p>ON - When a single device is connected to either the Ethernet or USB port and no data is being sent to or from the modem</p> <p>BLINKS - When only one Ethernet or USB device is connected and data is being transferred between the consumer premise equipment (CPE) and the cable modem</p> <p>OFF - When no devices are connected to either the Ethernet or USB ports</p> <p>Notes:</p> <ul style="list-style-type: none"> ■ When both Ethernet and USB devices are connected to the modem at the same time, and data is being transferred through only one of the devices (Ethernet or USB), the LINK LED status indicator illuminates continuously. ■ Whenever data is being sent through <i>both</i> data ports (Ethernet and USB) simultaneously, the indicator blinks as described above

Notices

Trademarks

Scientific Atlanta is a registered trademark of Scientific-Atlanta, Inc.

DPC2505 and EPC2505 are trademarks of Scientific-Atlanta, Inc.

Cisco, Cisco Systems, and the Cisco Systems logo are registered trademarks of Cisco Systems, Inc. and/or its affiliates in the U.S. and certain other countries.

DOCSIS is a registered trademark of Cable Television Laboratories, Inc.

EuroDOCSIS is a trademark of Cable Television Laboratories, Inc.

Other trademarks listed herein are the property of their respective owners.

Disclaimer

Scientific-Atlanta, Inc. assumes no responsibility for errors or omissions that may appear in this guide. Scientific-Atlanta, Inc. reserves the right to change this guide at any time without notice.

Documentation Copyright Notice

© 2006 Scientific-Atlanta, Inc. All rights reserved.

Printed in the United States of America.

Information in this document is subject to change without notice. No part of this document may be reproduced in any form without the express written permission of Scientific-Atlanta, Inc.

Software Use Notice

The software described in this document is copyrighted and furnished to you under a license agreement. You may only use or copy this software in accordance with the terms of your license agreement.

Firmware Use Notice

The firmware in this equipment is copyrighted. You may only use the firmware in the equipment in which it is provided. Any reproduction or distribution of this firmware, or any portion of it, without express written consent is prohibited.



Scientific Atlanta, A Cisco Company
5030 Sugarloaf Parkway, Box 465447
Lawrenceville, GA 30042

770.236.5000
www.scientificatlanta.com

This document includes various trademarks of Scientific-Atlanta, Inc. Please see the Notices section of this document for a list of the Scientific-Atlanta, Inc. trademarks used in this document.

All other trademarks shown are trademarks of their respective owners.

Product and service availability subject to change without notice.

© 2006 Scientific-Atlanta, Inc. All rights reserved.
October 2006

Printed in United States of America
Part Number 4015259 Rev B