

User's Guide



DPR300 Series Cable Modem Gateway

Bringing the Interactive
Experience
Home™

WebSTAR DPR300 Series Cable Modem Gateway User's Guide

Introduction

Welcome to the exciting world of home and office networking. Your new DPR300 Series WebSTAR™ Cable Modem Gateway allows several users to share one high-speed broadband connection across multiple PCs, laptops, digital cameras, personal data assistants (PDAs), digital devices, and Internet devices. The cable modem gateway makes sharing files and photos with your family and friends hassle free. With the DPR300 Series Cable Modem Gateway, your Internet enjoyment and business productivity will surely soar.

This guide provides procedures and recommendations for placing, installing, configuring, operating, and troubleshooting your cable modem gateway for Internet access and for high-speed wired or wireless broadband networking for your home or office. Refer to the appropriate section in this guide for the specific information you need for your situation. Contact your cable service provider for more information about subscribing to these services.

Benefits and Features

The cable modem gateway offers the following outstanding benefits and features:

- Allows you to attach multiple devices in your home or office to the cable modem gateway for high-speed networking and sharing of files and folders without first copying them onto a CD or diskette
- Protects your equipment and system files from unauthorized access by hackers who might want to access your private information
- Allows everyone to participate in the latest multiplayer games through your home network and on the Internet
- Allows you to connect your digital camera, or other digital devices, directly to your cable modem gateway for quickly sharing photos or files
- Permits an unprecedented method for economical and efficient high-speed networking for your home or office to share files and printers
- Enables home phoneline networking (HPNA) to multiple devices in your home or office using your existing telephone lines (not available on all models)
- Facilitates high-speed wireless networking of PCs, laptops, and PDAs (not available on all models)
- Assures a broad range of interoperability through support of the Data Over Cable Service Interface Specifications (DOCSIS) 1.0 and 1.1 standards

In This Guide

IMPORTANT RULES FOR SAFE OPERATION	3
What's in the Carton?	6
Front Panel Description	7
Back Panel Description	8
Where is the Best Location for My Cable Modem Gateway?	9
What are the System Requirements for Internet Service?	10
How Do I Set Up My Internet Access Account?	11
How Do I Connect My Devices to Use the Internet?	12
How Do I Configure TCP/IP Protocol?	14
How Do I Install USB Drivers?	17
How Do I Troubleshoot My Internet Service Installation?	19
What are the Requirements for Ethernet Network Devices?	21
How Do I Select and Place Ethernet Network Devices?	22
How Do I Connect Ethernet Network Devices?	23
What are the Requirements for USB Network Devices?	25
How Do I Select and Place USB Network Devices?	26
How Do I Connect USB Network Devices?	27
What are the Requirements for Wireless Network Devices?	29
How Do I Select and Place Wireless Network Devices?	30
How Do I Install Wireless Network Devices?	31
What are the Requirements for Home Phonenumber Networking Devices?	33
How Do I Select and Place Home Phonenumber Networking Devices?	34
How Do I Connect Home Phonenumber Networking Devices?	35
How Do I Configure the Cable Modem Gateway?	37
How Do I Monitor the Cable Modem Gateway?	67
Frequently Asked Questions	72
Having Difficulty?	75
Notices	76
FCC Compliance	77
For Information	78

IMPORTANT RULES FOR SAFE OPERATION

Note to Installer

Note to CATV System Installer

This reminder is provided to call the CATV system installer's attention to Article 820-40 of the NEC (Section 54, Part I of the Canadian Electrical Code), that provides guidelines for proper grounding and, in particular, specifies that the CATV cable ground shall be connected to the grounding system of the building, as close to the point of cable entry as practical.

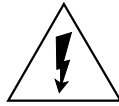

This symbol is intended to alert you that uninsulated voltage within this product may have sufficient magnitude to cause electric shock. Therefore, it is dangerous to make any kind of contact with any inside part of this product.



CAUTION: To reduce the risk of electric shock, do not remove cover (or back). No user-serviceable parts inside. Refer servicing to qualified service personnel.

WARNING

TO PREVENT FIRE OR ELECTRIC SHOCK, DO NOT EXPOSE THIS UNIT TO RAIN OR MOISTURE.



This symbol is intended to alert you of the presence of important operating and maintenance (servicing) instructions in the literature accompanying this product.

Read and Retain These Instructions

- Read all of the instructions before you operate this equipment. Give particular attention to all safety precautions. Retain the instructions for future reference.
- Comply with all warning and caution statements in the instructions. Observe all warning and caution symbols that are affixed to this equipment.
- Comply with all instructions that accompany this equipment.

Cleaning the Equipment

Before cleaning this equipment, unplug it from the electrical outlet. Use a damp cloth to clean this equipment. Do not use a liquid cleaner or an aerosol cleaner. Do not use a magnetic/static cleaning device (dust remover) to clean this equipment.

Placement

Place this equipment in a location that is close enough to an electrical outlet to accommodate the length of the power cord. Place this equipment on a stable surface. The surface must support the size and weight of this equipment. Place this equipment either horizontally or vertically.



Accessories

Do not use accessories with this equipment unless recommended by your cable service provider.

Ventilation

This equipment has openings for ventilation that protect it from overheating. To ensure the reliability of this equipment, do not obstruct the openings.

- Read all of the instructions before you operate this equipment. Give particular attention to all safety precautions. Retain the instructions for future reference.
- Do not place other equipment, lamps, books, or any other object on the top of or beside this equipment
- Do not place this equipment in any of the locations that follow:
 - On a bed, sofa, rug, or similar surface
 - Over a radiator or a heat register
- In an enclosure, such as a bookcase or equipment rack, unless the installation provides proper ventilation

Overloading

Do not overload electrical outlets, extension cords, or integral convenience receptacles, as this can result in a risk of fire or electric shock. For equipment that requires battery power or other sources to operate, refer to the operating instructions for that equipment.

Object and Liquid Entry

Never push objects of any kind into this product through openings as they may touch dangerous voltage points or short out parts that could result in a fire or electric shock. Do not expose this equipment to liquid or moisture. Do not place this equipment on a wet surface. Do not spill liquids on or near this equipment.

Lightning and Power Surges

Plug your equipment into a surge protector in order to reduce the risk of damage from lightning strikes and power surges. If you are unsure of the type of surge protector to use, contact your cable service provider.

Servicing

Do not open the cover of this equipment. If you open the cover, your warranty will be void. Refer all servicing to qualified personnel only. Contact your cable service provider for instructions.

Power Cord Protection

Arrange all power cords so that people cannot walk on the cords, place objects on the cords, or place objects against the cords, which can damage the cords. Pay particular attention to cords that are at plugs, at electrical outlets, and at the places where the cords exit the equipment.

Power Sources

A label on the AC power adapter that is supplied with this equipment indicates the correct power source for this equipment. Operate this equipment only from an electrical outlet that has the voltage and frequency that the label indicates.

If you are unsure of the type of power supply to your residence, consult Scientific-Atlanta, Inc., or your local power company.

Grounding

This equipment may be provided with a three-prong plug. Properly ground (earth) this equipment by inserting the plug into a grounded electrical, three-socket outlet. If you are unable to insert this plug fully into the outlet, contact an electrician to replace your obsolete outlet.

Damage that Requires Service

For damage that requires service, unplug this equipment from the electrical outlet. Contact your cable service provider when any of the following situations occur:

- There is damage to the power cord or plug
- Liquid enters the equipment
- A heavy object falls on the equipment
- There is exposure to rain or water
- Operation is not normal (the instructions describe the proper operation)
- If you drop this equipment, or damage the cabinet of this equipment
- If this equipment exhibits a distinct change in performance

Upon completion of any service or repairs to this equipment (cable modem), ask the service technician to perform safety checks to determine that the equipment is in proper operating condition.

What's In the Carton?

When you receive your cable modem gateway, you should check the equipment and accessories to verify that each item is in the carton and that each item is undamaged. The carton contains the following items:



One WebSTAR Cable Modem Gateway



One USB cable



One Ethernet cable (CAT-5/RJ-45)



One power adapter with power cord



One CD-ROM containing the user's guide and the USB drivers

If any of the items listed is missing or damaged, please contact SciCare™ Broadband Services at 1-800-722-2009 for assistance.

You will need an optional cable signal splitter and additional standard RF coaxial cable if you want to connect a VCR, a Digital Home Communications Terminal (DHCT) or a set-top converter, or a TV to the same cable connection as your cable modem gateway.

Additional cables and other equipment needed for wired or wireless networking must be purchased separately. Contact your cable service provider to inquire about the equipment and cables you need for telephone service.

Front Panel Description

The front panel of your cable modem gateway provides status lights that indicate how well and at what state your cable modem gateway is operating. After the cable modem gateway is successfully registered on the network, the **POWER** and **CABLE** status indicators illuminate continuously to show that the cable modem is active and fully operational. The Ethernet, USB, HPNA, and Wireless indicators blink rapidly when data is being transferred on the corresponding interface.



See the Front Panel Status Indicator table, in the **Frequently Asked Questions** section, later in this guide, for more information on front panel status indicator functions.

The following illustration describes these front panel status indicators.

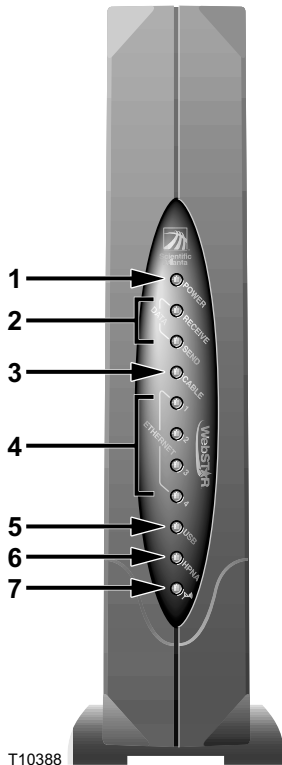

T10388

1. **POWER** – Illuminates to indicate that power is being applied to the cable modem gateway
2. **DATA (Receive/Send)** – Illuminates to indicate that data is being transferred between the cable modem gateway and the cable network
3. **CABLE** – Illuminates to indicate that the cable modem gateway is registered on the network and fully operational
4. **ETHERNET** – Illuminates to indicate that Ethernet device(s) are connected
5. **USB** – Illuminates to indicate that a USB device is connected
6. **HPNA** – Illuminates to indicate that an HPNA connection is established
7. **WIRELESS** – Illuminates when the internal wireless access point is operational (not available on all models)

Back Panel Description

The following illustration describes the back panel components of the cable modem gateway.

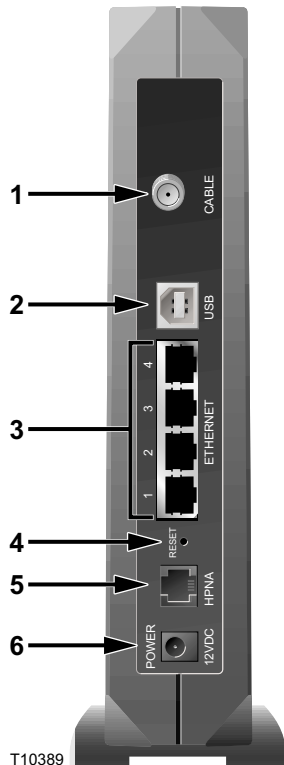

1. **CABLE** – F-Connector connects to an active cable signal from your cable service provider
2. **USB** – USB port connects to the USB port on additional networked device
3. **ETHERNET** – RJ-45 Ethernet port connects to the Ethernet ports on additional networked devices
4. **RESET** – Reset-to-Default button (Factory Reset)



This button is for maintenance purposes only. Do not use unless instructed to do so by your cable service provider

5. **HPNA** – Connects the cable modem gateway to your home telephone wiring
6. **POWER** - Connects the cable modem gateway to the DC output of the AC power adapter that is provided with your cable modem gateway



Only use the power cord and the AC power adapter that are provided with your cable modem gateway.

Where is the Best Location for My Cable Modem Gateway?

Think about the layout of your home or office, and consult with your cable service provider to select the best location for your cable modem gateway.

Consider these recommendations:

- Place your cable modem gateway near an AC power outlet.
- Position your cable modem gateway so that it is located near an existing cable input connection to eliminate the need for an additional cable outlet. There should be plenty of room to guide the cable away from the gateway without straining or crimping it.
- If you are planning to connect your cable modem gateway to your home telephone wiring for home networking to other devices, choose a location close to a telephone jack.
- If you are planning to connect Ethernet cables, USB cables, or your home telephone wiring to the cable modem gateway, you will have to run cables from the cable modem gateway to these devices. Consider the distance from the cable modem gateway to the other devices and connection points and the logistics for running the cables.
- If you are planning to use the cable modem gateway for wireless devices, consider the line-of-sight distances between the cable modem gateway and the wireless devices. The distance from the cable modem gateway to the wireless devices should not exceed 100 feet.
- Choose a location that protects the modem from accidental disturbance or harm.
- Airflow around the cable modem gateway should not be restricted.
- Read this user's guide thoroughly before you decide where to place your cable modem gateway.

What are the System Requirements for Internet Service?

To ensure that your cable modem gateway operates efficiently for high-speed Internet service, verify that all of the Internet devices on your system meet or exceed the following minimum hardware and software requirements.



You will also need an active cable input line and an Internet connection.

Minimum System Requirements for PCs

- A PC with a Pentium MMX 133 processor or greater
- 32 MB of RAM
- Web browsing software (Netscape or Internet Explorer)
- CD-ROM drive

Minimum System Requirements for Macintosh

- MAC OS 7.5
- 32 MB of RAM

System Requirements for an Ethernet Connection

- A PC with Windows 95 operating system (or later) with TCP/IP protocol installed, or an Apple Macintosh computer with TCP/IP protocol installed
- An active 10/100BaseT Ethernet network interface card (NIC) installed in your PC

System Requirements for a USB Connection

- A PC with a Windows 98SE, ME, 2000, or XP operating system
- A master USB port installed on your PC

How Do I Set Up My High-Speed Internet Access Account?

Before you can use your cable modem gateway, you need to have a high-speed Internet access account. If you do not have a high-speed Internet access account, you need to set up a high-speed Internet access account with your local cable service provider. Choose one of the following two options:

I Do Not Have a High-Speed Internet Access Account

If you do *not* have a high-speed Internet access account, your cable service provider will set up your high-speed Internet access account and become your Internet Service Provider (ISP). Internet access enables you to send and receive e-mail, access the World Wide Web, and receive other Internet services. When you contact your cable service provider, they will ask you for the serial number and Media Access Control (MAC) address of the cable modem gateway.

These numbers appear on a bar code label located on the side of the cable modem gateway. The serial number consists of a series of alphanumeric characters preceded by **S/N**. The MAC address consists of a series of alphanumeric characters preceded by **MAC**.

Write these numbers in the space provided here.

Serial Number _____

MAC Address _____

The following illustration shows a sample bar code label.

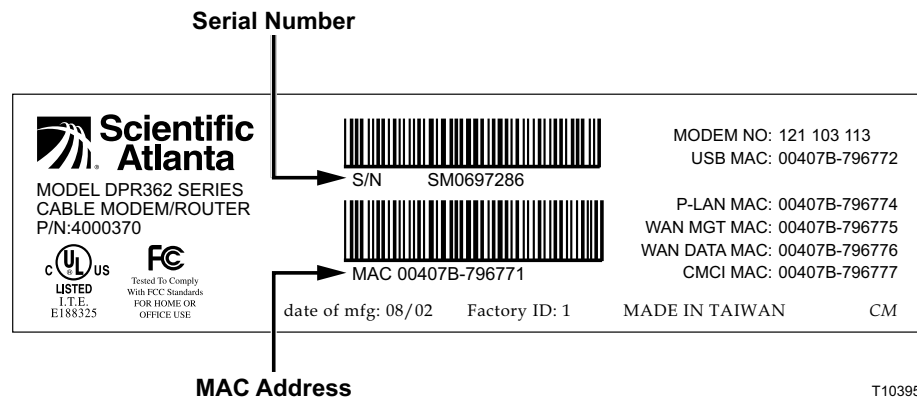

I Already Have an Existing High-Speed Internet Access Account

If you have an existing high-speed Internet access account, you must give your cable service provider the serial number and the MAC address of the cable modem gateway. Refer to the serial number and MAC address information listed previously in this section.



You may be able to continue to use your existing e-mail account with your cable modem gateway. Contact your cable service provider for more information.

How Do I Connect My Devices to Use the Internet?

You can use your cable modem gateway to access the Internet, and you can share that Internet connection with other Internet devices in your home or office. Sharing one connection among many devices is called networking.

Connecting and Installing Internet Devices

You must connect and install your cable modem gateway to access the Internet. Professional installation may be available. Contact your local cable service provider for further assistance.

To connect devices

The following diagram illustrates one of the various Internet connection options that are available to you

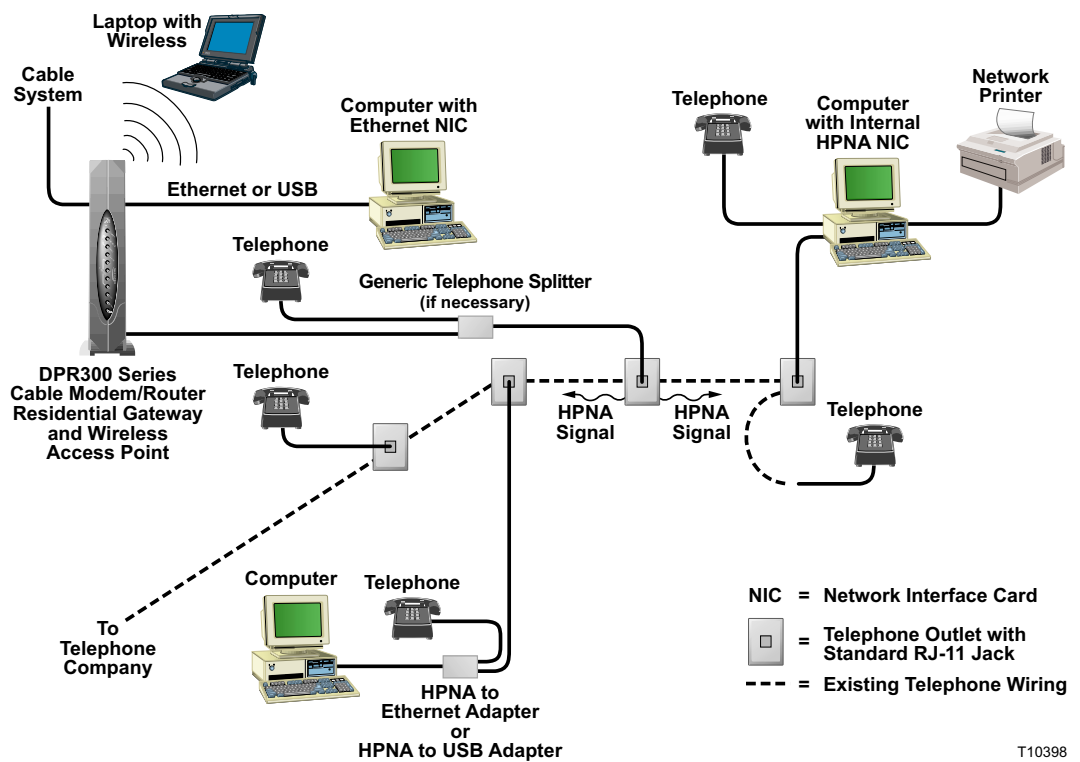

T10398

To install the cable modem gateway

 **WARNING: To avoid personal injury or damage to your equipment, follow these steps in the exact order shown.**

 **CAUTION: Do not connect the same device to more than one port.**

The following installation procedure ensures proper cable modem gateway setup and configuration. For detailed installation procedures for specific device types and services, refer to the specific section for that device or service, later in this guide. Use that diagram and the preceding diagram to assist you as you follow these instructions.

Follow these steps to install the cable modem gateway correctly.

1. Power off all devices you are connecting to the cable modem gateway and unplug them from all power sources.
2. Connect the devices you are connecting to the cable modem gateway to the correct port using the appropriate data cable(s). Use an optional cable signal splitter to add a TV, a DHCT or set-top converter, or a VCR.
 Refer to the appropriate section in this guide for installing the type of networking you desire to use.
3. Insert the AC power adapter cord into the DC power connector on the back of the cable modem gateway, and then plug the power adapter into an AC power source.
4. Connect the active RF coaxial cable to the **CABLE IN** connector. The cable modem gateway will then begin an automatic search to locate and sign on to the broadband data network. This process may take up to 5 minutes. The cable modem gateway is ready for use when the **CABLE** indicator on the front panel stops blinking and illuminates continuously.
5. Plug in and power on your networked devices.
6. The next step in setting up your cable modem gateway is to configure your Internet devices for Internet access. Choose one of the following options:
 - If you want to use Ethernet connections on your networking system, you must configure the TCP/IP protocol. Go to **How Do I Configure TCP/IP Protocol?**, next in this guide.
 - If you want to use USB connections on your networking system, you must install the USB drivers. Go to **How Do I Install USB Drivers?**, later in this guide.

How Do I Configure TCP/IP Protocol?

To configure TCP/IP protocol, you need to have an Ethernet Network Interface Card (NIC) with TCP/IP communications protocol installed on your system. TCP/IP is a communications protocol used to access the Internet. This section contains instructions for configuring TCP/IP on your Internet devices to operate with the cable modem gateway in either a Windows or Macintosh environment.

Configuring TCP/IP on Your Internet Devices

TCP/IP protocol in a Windows environment is different for each Windows version. Follow the appropriate instructions for your operating system.

To configure Windows 95/98/98SE/ME systems

1. Click **Start**, select **Settings**, and choose **Control Panel**.
2. Double-click the **Network** icon in the Control Panel window.
3. Read the list of installed network components under the **Configuration** tab to verify that your PC contains the TCP/IP protocol.
4. Is TCP/IP protocol listed in the installed network components list?
 - If **yes**, go to step 7.
 - If **no**, click **Add**, click **Protocol**, click **Add**, and then go to step 5.
5. Click **Microsoft** in the Manufacturers list.
6. Click **TCP/IP** in the Network Protocols list, and then click **OK**.
7. Click the **TCP/IP Ethernet Adapter** protocol, and then choose **Properties**.
8. Click the IP Address tab, and then select **Obtain an IP address automatically**.
9. Click the **Gateway** tab and verify that these fields are empty. If they are not empty, highlight and delete all information from the fields.
10. Click the **DNS Configuration** tab, and then select **Disable DNS**.
11. Click **OK**.
12. Click **OK** when the system finishes copying the files, and then close all networking windows.
13. Click **YES** to restart your computer when the System Settings Change dialog box opens. The computer restarts. The TCP/IP protocol is now configured on your PC and your Ethernet devices are ready for use.
14. Try to access the Internet. If you cannot access the Internet, go to **How Do I Troubleshoot My Internet Service Installation?**, later in this guide. If you still cannot access the Internet, contact your cable service provider for further assistance.

To configure Windows 2000 systems

1. Click **Start**, select **Settings**, and choose **Network and Dial-up Connections**.
2. Double-click the **Local Area Connection** icon in the Network and Dial-up Connections window.
3. Click **Properties** in the Local Area Connection Status window.
4. Click **Internet Protocol (TCP/IP)** in the Local Area Connection Properties window, and then click **Properties**.
5. Select *both* **Obtain an IP address automatically** and **Obtain DNS server address automatically** in the Internet Protocol (TCP/IP) Properties window, and then click **OK**.
6. Click **Yes** to restart your computer when the Local Network window opens. The computer restarts. The TCP/IP protocol is now configured on your PC and your Ethernet devices are ready for use.
7. Try to access the Internet. If you cannot access the Internet, go to **How Do I Troubleshoot My Internet Service Installation?**, later in this guide. If you still cannot access the Internet, contact your cable service provider for further assistance.

To configure Windows XP systems

1. Click **Start**, select **Connect to**, and choose **Show all connections**.
2. Double-click the **Local Area Connection** icon in the **LAN or High-Speed Internet** section of the Network Connections window.
3. Click **Properties** in the Local Area Connection Status window.
4. Click **Internet Protocol (TCP/IP)**, and then click **Properties** in the Local Area Connection Properties window.
5. Select *both* **Obtain an IP address automatically** and **Obtain DNS server address automatically** in the Internet Protocol (TCP/IP) Properties window, and then click **OK**.
6. Click **Yes** to restart your computer when the Local Network window opens. The computer restarts. The TCP/IP protocol is now configured on your PC and your Ethernet devices are ready for use.
7. Try to access the Internet. If you cannot access the Internet, go to **How Do I Troubleshoot My Internet Service Installation?**, later in this guide. If you still cannot access the Internet, contact your cable service provider for further assistance.

To configure Macintosh systems

1. Click the **Apple** icon in the upper left corner of the Finder. Scroll down to **Control Panels**, and then click **TCP/IP**.
2. Click **Edit** on the Finder (gray bar) at the top of the screen. Scroll down to the bottom of the menu, and then click **User Mode**.
3. Click **Advanced** in the User Mode window, and then click **OK**.
4. Click the **Up/Down** selector arrows located to the right of the Connect Via section of the TCP/IP window, and then click **Using DHCP Server**.
5. Click **Options** in the TCP/IP window, and then click **Active** in the TCP/IP Options window.
Note: In some cases, the **Load only when needed** option will not appear. If it appears, select the option. A check mark appears in the option.
6. Verify that the **Use 802.3** option located in the upper right-hand corner of the TCP/IP window is unchecked. If there is a check mark in the option, deselect the option, and then click **Info** in the lower left corner.
7. Is there a Hardware Address listed in this window?
 - If **yes**, click **OK**. To close the **TCP/IP Control Panel** window, click **File**, and then scroll down to click **Close**. You have completed this procedure.
 - If **no**, you must power off your Macintosh.
8. With the power off, simultaneously press and hold down the **Command (Apple)**, **Option**, **P**, and **R** keys on your keyboard. Keeping those keys pressed down, power on your Macintosh but do *not* release these keys until you hear the Apple chime.
9. Continue pressing these keys for up to three chimes, then release the keys and allow the computer to restart.
10. Repeat steps 1 through 7 when your computer fully reboots to verify that all TCP/IP settings are correct. If your computer *still* does not display a Hardware Address, contact your authorized Apple dealer or Apple technical support center for further assistance.

How Do I Install USB Drivers?

To install USB drivers, your PC must be equipped with a USB network interface and a Windows 98SE/ME/2000/XP operating system. This section contains instructions for installing the cable modem gateway USB drivers.



If you are not using the USB interface, skip this section.

Installing USB Drivers

The USB driver installation procedures are different for each operating system. Follow the appropriate instructions in this section for your operating system.

To install Windows 98SE and ME USB drivers

1. Insert the **USB Cable Modem Driver Installation Disk** into the CD-ROM drive of your PC.
2. Wait until the **Power** and **Cable** indicators on the cable modem illuminate solid green.
Result: The Add New Hardware Wizard window opens.
3. Click **Next** in the Add New Hardware Wizard window.
4. Select **Search for the best driver for your device (Recommended)** in the Add New Hardware Wizard window, and then click **Next**.
5. Select **CD-ROM drive** in the Add New Hardware Wizard window, and then click **Next**.
6. Select **The updated driver (Recommended)** in the Add New Hardware Wizard window, and then click **Next**.
7. Click **Next** in the Add New Hardware Wizard window. The Copying Files window opens. After 10 to 20 seconds have passed, the Add New Hardware Wizard window reopens.
8. Click **Finish**. The USB driver installation is complete.
9. Click **Yes** in the System Settings Change window to restart your computer. The computer restarts. The USB drivers are now installed on your PC and your USB devices are ready for use.
10. Try to access the Internet. If you cannot access the Internet, go to **How Do I Troubleshoot My Internet Service Installation?**, next in this guide. If you still cannot access the Internet, contact your cable service provider for further assistance.

To install Windows 2000 drivers

1. Insert the **USB Cable Modem Driver Installation Disk** into the CD-ROM drive of your PC.
2. Wait until the **Power** and **Cable** indicators on the cable modem illuminate solid green.
3. Click **Next** in the Found New Hardware Wizard window.
4. Select **Search for a suitable driver for my device (recommended)** in the Found New Hardware Wizard window, and then click **Next**.
5. Select **CD-ROM drives** in the Found New Hardware Wizard window, and then click **Next**.
6. Click **Next** in the Found New Hardware Wizard window. The system searches for the driver file for your hardware device.
7. After the system finds the USB driver, the Digital Signature Not Found window opens displaying a confirmation message to continue the installation.
8. Click **Yes** to continue the installation. The Found New Hardware Wizard window reopens with a message that the installation is complete.
9. Click **Finish** to close the Found New Hardware Wizard window. The USB drivers are installed on your PC and your USB devices are ready for use.
10. Try to access the Internet. If you cannot access the Internet, go to **How Do I Troubleshoot My Internet Service Installation?**, next in this guide. If you still cannot access the Internet, contact your cable service provider for further assistance.

To install Windows XP drivers

1. Insert the **USB Cable Modem Driver Installation Disk** into the CD-ROM drive of your PC.
2. Wait until the **Power** and **Cable** indicators on the cable modem illuminate solid green.
3. Select **Install from a list or specific location (Advanced)** in the Found New Hardware Wizard window, and then click **Next**.
4. Select **Search removable media (floppy, CD-ROM)** in the Found New Hardware Wizard window, and then click **Next**.
5. Click **Continue Anyway** in the Hardware Installation window to continue the installation. The Found New Hardware Wizard window reopens with a message that the installation has finished.
6. Click **Finish** to close the Found New Hardware Wizard window. The USB drivers are installed on your PC and your USB devices are ready for use.
7. Try to access the Internet. If you cannot access the Internet, go to **How Do I Troubleshoot My Internet Service Installation?**, next in this guide. If you still cannot access the Internet, contact your cable service provider for further assistance.

How Do I Troubleshoot My Internet Service Installation?

I cannot connect to the Internet

- Verify that the plug to your cable modem gateway AC adapter is properly inserted into an electrical outlet.
- Verify that your cable modem gateway AC adapter is not plugged into an electrical outlet that is controlled by a wall switch. If a wall switch controls the electrical outlet, make sure the switch is in the **ON** position.
- Verify that the **Power**, **Cable**, and the appropriate indicator lights for your network connection and on the front panel of your cable modem gateway are illuminated.
- Verify that all cables are properly connected, and that you are using the correct cables.
- Verify that your cable service is active and that it supports two-way service.
- Verify that TCP/IP is properly installed and configured on all devices if you are using the Ethernet connections.
- Verify that you have followed the procedure for **Installing the USB Drivers for Windows 98SE/ME/2000/XP**, earlier in this guide, if you are using the USB connection.
- Verify that you have called your cable service provider and given them the serial number and MAC address of your cable modem gateway.
- If you are using a cable signal splitter so that you can connect the cable modem gateway to other devices, remove the splitter and reconnect the cable so that the cable modem gateway is connected directly to the main cable input. If the cable modem gateway now functions properly, the cable signal splitter may be defective and may need to be replaced.

My cable modem gateway does not register an Ethernet connection

Even new devices do not always have Ethernet capabilities. Verify that your device has a 10/100BaseT Ethernet card and that the Ethernet driver software is properly installed. If you purchase and install an Ethernet card, follow the installation instructions very carefully.

My cable modem gateway does not register a cable connection

- The cable modem gateway works with a standard, 75-ohm, RF coaxial cable. If you are using a different cable, your cable modem gateway will not function properly. Contact your cable service provider to determine if you are using the correct cable.
- You may need to renew the IP address on your PC. Refer to **I need to renew the IP address on my PC**, next in this section for instructions on how to renew the IP address for your particular operating system.
- Your USB interface may be malfunctioning. Refer to the troubleshooting information in your USB documentation.

I need to renew the IP address on my PC

If your PC cannot access the Internet after the cable modem is online, it is possible that your PC did not renew its IP address. Follow the appropriate instructions in this section for your operating system to renew the IP address on your PC.

To renew the IP Address for Windows 95/98/98SE/ME systems

1. Click **Start**, and then click **Run** to open the Run window.
2. Type **winipcfg** in the Open field, and click **OK** to execute the winipcfg command. The IP Configuration window opens.
3. Click the down arrow to the right of the top field, and select the Ethernet adapter that is installed on your PC. The IP Configuration window displays the Ethernet adapter information.
4. Click **Release**, and then click **Renew**. The IP Configuration window displays a new IP address.
5. Click **OK** to close the IP Configuration window, you have completed this procedure.



If you cannot access the Internet, contact your cable service provider for further assistance.

To renew the IP Address for Windows 2000, Windows NT, or Windows XP systems

1. Open a Command Prompt (DOS) window.
2. Type **ipconfig/release** at the C:/ prompt and press **Enter**. The system releases the IP address.
3. Type **ipconfig/renew** at the C:/ prompt and press **Enter**. The system displays a new IP address.
4. Click on the **X** in the upper-right corner of the window to close the Command Prompt window. You have completed this procedure.



If you cannot access the Internet, contact your cable service provider for further assistance.

What are the Requirements for Ethernet Network Devices?

How Many Ethernet Network Devices Can I Connect?

The cable modem gateway can support several Ethernet network devices using either the 4 Ethernet ports on the back panel of the unit, or external Ethernet hubs that must be purchased separately. The theoretical maximum number of Ethernet network devices supported is by the cable modem gateway 253. However, under normal circumstances, the number of devices connected should be a much lower number. Contact your cable service provider for more information on the maximum number of Ethernet network devices to connect to the cable modem gateway in order to maintain optimal network performance.

What are the Wiring Requirements for Ethernet Networking?

Although the cable modem gateway is designed to support several Ethernet network devices, it is important to view the characteristics of the entire network and not just each individual node. The theoretical distance between two 10/100 BaseT CAT-5 Ethernet hubs is 382 feet (100 meters). Scientific-Atlanta recommends that you use CAT-5 Ethernet cables.

A number of factors can impact the practical limit of the network. Contact your cable service provider or consult the documentation for your Ethernet network devices for more information.

Do I Need to Configure the TCP/IP Protocol on My Computer?

In order for you to use Ethernet network devices on your network, you must have the TCP/IP protocol properly configured on your PC. Refer to **How Do I Configure TCP/IP Protocol?**, earlier in this guide, for detailed information on configuring the TCP/IP protocol.

How Do I Select and Place Ethernet Network Devices?

You can use a large variety of Ethernet network devices with your cable modem gateway. These include NIC cards, hubs, bridges, etc. Contact your cable service provider or consult the documentation for your Ethernet network devices for more information on configuring Ethernet network devices.

Where is the Best Location for My Ethernet Network Devices?

You should work with your cable service provider to choose the best location for your Ethernet network devices. Consider these recommendations:

- Location of two-way cable outlets
- Distance of the Ethernet network devices from the cable modem gateway
- Location of computers and other equipment from AC power outlets
- Ease of running Ethernet cable to the Ethernet network devices

Now that you have selected a location for your Ethernet network devices, the next step is to place and connect your Ethernet network devices. Go to **How Do I Connect Ethernet Network Devices?**, next in this guide.

How Do I Connect Ethernet Network Devices?

Connecting Ethernet Devices

You must connect your Ethernet devices for use with the cable modem gateway. Professional installation may be available. Contact your local cable service provider for further assistance.

The following diagram illustrates one of the various Ethernet network connection options that are available to you.

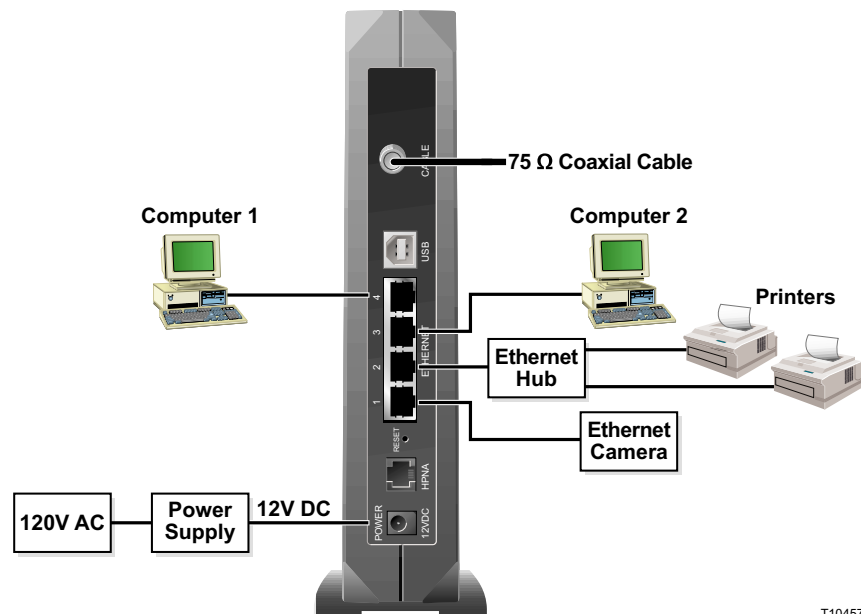

T10457

To connect Ethernet devices

Read the warnings and caution on this page. Then, follow the subsequent installation procedures to ensure proper cable modem gateway operation when connecting Ethernet network devices.



WARNING:

- **Hazardous electrical voltages can be present on any connected wiring. Ethernet wiring and connections must be properly insulated to prevent electrical shock. Disconnect power from the cable modem gateway before attempting to connect to any device.**
- **To avoid personal injury, follow these steps in the exact order shown.**



CAUTION:

To prevent possible damage to the equipment, disconnect any other service before connecting your cable modem gateway to other devices.

1. Select locations for Ethernet network devices. For more information, see **How Do I Select and Place Ethernet Network Devices?**, earlier in this guide.
2. Connect an Ethernet port on the cable modem gateway to your PC.
3. Connect additional Ethernet network devices using the other Ethernet ports on the cable modem gateway, or by connecting an Ethernet hub or router to the cable modem gateway.
4. Connect the active RF coaxial cable to the **CABLE IN** connector on the back of the cable modem gateway. Use an optional cable signal splitter to add a TV, a DHCT or set-top converter, or a VCR.
5. After all connections are complete, insert the AC power adapter cord into the DC power connector on the back of the cable modem gateway, and then plug the power adapter into an AC power source.
6. The cable modem gateway begins an automatic search to locate and sign on to the network. This process may take up to 5 minutes. The cable modem gateway is ready for use when the **CABLE** status indicator on the front panel stops blinking and illuminates continuously.
7. Verify that all Ethernet network devices are working properly.



You will not be able to check the Ethernet front panel status indicators on the cable modem gateway until after two or more Ethernet network devices are connected to the cable modem gateway.

What are the Requirements for USB Network Devices?

How Many USB Devices Can I Connect?

The cable modem gateway can support numerous USB network devices using a USB hub that must be purchased separately. Contact your cable service provider for more information on the maximum number of USB network devices to connect to the cable modem gateway in order to maintain optimal network performance.

What are the Wiring Requirements?

Several factors can impact the practical limit of the network. Use correct USB cables. Contact your cable service provider or consult the documentation for your USB network device for more information.

Do I Need to Install USB Drivers on My Computer?

To use USB network devices, you must have the correct USB drivers install on your PC. Refer to **How Do I Install USB Drivers?**, earlier in this guide, for information on installing USB drivers.

How Do I Select and Place USB Network Devices?

You can use a large variety of USB network devices with your cable modem gateway. These include desktop computers, laptop computers, devices with USB ports, USB adapters. Contact your cable service provider or consult the documentation for your USB network devices for more information on selecting USB network devices.

Where is the Best Location for My USB Network Devices?

You should work with your cable service provider to choose the best location for your USB network devices. Consider these recommendations:

- Location of two-way coaxial cable outlets
- Distance of the USB network devices from the cable modem gateway
- Location of computers and other equipment from AC power outlets
- Ease of running USB cable to the USB network devices

Now that you have selected a location for your USB network devices, the next step is to place and connect your USB network devices. Go to **How Do I Connect USB Network Devices?**, next in this guide.

How Do I Connect USB Network Devices?

Connecting USB Devices

You must connect your USB devices for use with your cable modem gateway. Professional installation may be available. Contact your local cable service provider for further assistance

The following diagram illustrates one of the various USB network connection options that are available to you.

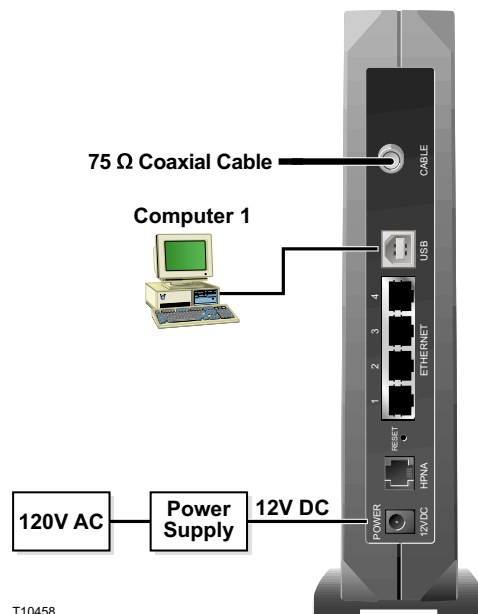

T10458

To connect USB devices

Read the warnings and caution on this page. Then, follow the subsequent installation procedures to ensure proper cable modem gateway operation when connecting USB network devices.



WARNING:

- **Hazardous electrical voltages can be present on any connected wiring. Ethernet wiring and connections must be properly insulated to prevent electrical shock. Disconnect power from the cable modem gateway before attempting to connect to any device.**
- **To avoid personal injury, follow these steps in the exact order shown.**



CAUTION:

To prevent possible damage to the equipment, disconnect any other service before connecting your cable modem gateway to other devices.



Verify that you have installed the USB drivers on your PC before continuing with these instructions. See **How Do I Install USB Drivers?**, earlier in this guide for more information on installing the USB drivers.

1. Select locations for USB network devices. For more information, see **How Do I Select and Place USB Network Devices?**, earlier in this guide.
2. Connect the USB port on the cable modem gateway to your computer.
3. Connect one or more USB network device to the cable modem gateway.



If you want to connect more than one USB network device to the cable modem gateway or to your computer, you will need to purchase and install a USB hub.

4. Connect the active RF coaxial cable to the **CABLE IN** connector on the back of the cable modem gateway. Use an optional cable signal splitter to add a TV, a DHCT or set-top converter, or a VCR.
5. After all connections are complete, insert the AC power adapter cord into the DC power connector on the back of the cable modem gateway, and then plug the power adapter into an AC power source.
6. The cable modem gateway begins an automatic search to locate and sign on to the network that provides the telephone service. This process may take up to 5 minutes. The cable modem gateway is ready for use when the **CABLE** status indicator on the front panel stops blinking and illuminates continuously.
7. Verify that all USB devices are working properly.



You will not be able to check the USB front panel status indicator on the cable modem gateway until after at least one USB network device is connected and operating on the network.

What are the Requirements for Wireless Network Devices?

How Many Wireless Devices Can I Connect?

The cable modem gateway serves as a wireless access point (WAP). The WAP on the cable modem gateway provides wireless network service to multiple wireless network devices. Contact your cable service provider for more information on the maximum number of wireless network devices to connect to the cable modem gateway in order to maintain optimal network performance.

What are the Requirements for Wireless Networking?

It is important to view the characteristics of the entire network and not just each individual node. The theoretical distance between wireless network devices is 100 feet inside of a building, and 300 feet outdoors.

A number of factors can impact the practical limit of the network. Contact your cable service provider or consult the documentation for your wireless network devices for more information.



Wireless network service is not available on all models of the cable modem gateway.

How Do I Select and Place Wireless Network Devices?

You can use a large variety of wireless network devices with your cable modem gateway. These include computers, PDAs, etc. On the wireless network, all devices impact the characteristics of the network, because each device transmits a wireless signal. Contact your cable service provider or consult the documentation for your wireless network device for more information on selecting the appropriate wireless network devices for your home or office network.

Where is the Best Location for My Wireless Network Devices?

You should work with your cable service provider to choose the best location for your wireless network devices. Consider these recommendations:

- Distance from the cable modem gateway to the wireless network devices
- Do not place the cable modem gateway near metallic surfaces that may block the wireless communications path. Wireless communication is “line-of-sight” through non-metallic walls. However, the more structures (walls) the signal must pass through, the weaker the received signal.
- Do not place wireless network devices near a microwave oven. Microwave ovens can occasionally interfere with wireless transmissions.

Now that you have selected a location for your wireless network devices, the next step is to place and install your wireless network devices. Go to **How Do I Install Wireless Network Devices?**, next in this guide.

How Do I Install Wireless Network Devices?

Installing Wireless Network Devices

You must install wireless network devices for use with your cable modem gateway. Professional installation may be available. Contact your local cable service provider for further assistance.

The following diagram illustrates one of the various wireless network connection options that are available to you.

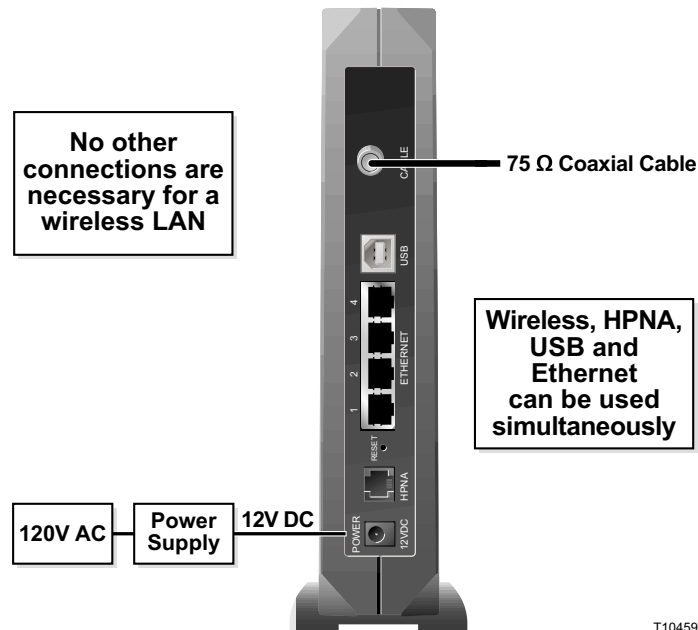

T10459

To install wireless network devices

Read the warnings and caution on this page. Then, follow the subsequent installation procedures to ensure proper cable modem gateway operation when using wireless network devices.

Follow these steps to install the cable modem gateway for accessing wireless network devices.



WARNING:

- **Hazardous electrical voltages can be present on any connected wiring. Ethernet wiring and connections must be properly insulated to prevent electrical shock. Disconnect power from the cable modem gateway before attempting to connect to any device.**
- **To avoid personal injury, follow these steps in the exact order shown.**



CAUTION:

To prevent possible damage to the equipment, disconnect any other service before connecting your cable modem gateway to other devices.

1. Select locations for wireless network devices. For more information, see **How Do I Select and Place Wireless Network Devices?**, earlier in this guide.
2. Connect and install the wireless network device(s).
3. Connect the active RF coaxial cable to the **CABLE IN** connector on the back of the cable modem gateway. Use an optional cable signal splitter to add a TV, a DHCT or set-top converter, or a VCR.
4. After all connections are complete, insert the AC power adapter cord into the DC power connector on the back of the cable modem gateway, and then plug the power adapter into an AC power source. The cable modem gateway begins an automatic search to locate and sign on to the network that provides the telephone service. This process may take up to 5 minutes. The cable modem gateway is ready for use when the **CABLE** status indicator on the front panel stops blinking and illuminates continuously.



Some cordless telephones can interfere with wireless signals. Unplug and disconnect any cordless phones until your wireless network is operating properly.

5. Verify that all wireless network devices are working properly. You will not be able to check the wireless front panel status indicator on the cable modem gateway until after one or more wireless network devices are communicating with the cable modem gateway.

What are the Requirements for Home Phoneline Networking Devices?

How Many HPNA Devices Can I Connect?

The RJ-11 telephone-style HPNA connection on the cable modem gateway can provide home networking service to multiple HPNA devices when properly connected to your telephone wiring. The theoretical maximum number of devices supported is 253. However, under normal circumstances, the number of devices connected should be a much lower number. Contact your cable service provider for more information on the maximum number of devices to connect to the cable modem gateway in order to maintain optimal network performance.

What are the Telephone Wiring Requirements?

The cable modem gateway is designed to support interior telephone wiring. It is important to view the characteristics of the entire network and not just each individual node. The maximum recommended distance between any two nodes is 1000 feet, and the maximum recommended length of the entire network is 1000 feet. The theoretical maximum number of nodes is 25. Use 26-gauge twisted-pair, or larger, telephone wiring.

A number of factors can impact the practical limit of the network. Contact your cable service provider or consult the documentation for your HPNA device for more information.



HPNA networking is not available on all models of the cable modem gateway.

How Do I Select and Place Home Phonenumber Networking Devices?

Home phonenumber networking is also known as HPNA. HPNA service allows all the components of a home network to interact over the home's existing telephone wiring without disturbing the existing voice or fax services. Home phonenumber networking (HPNA) processes, manages, transports and stores information, and enables the devices in a home network such as telephones, fax machines, desktop computers, laptops, printers, scanners and Web cameras to connect and integrate over a home's telephone wiring topology.



This section does not provide all of the information required to install specific HPNA devices, but instead provides a general overview. For specifics, please consult the documentation provided by the manufacturer of your HPNA device(s).

How Do I Select HPNA Devices?

You can use a large variety of HPNA devices with your cable modem gateway. These include NIC cards, USB adapters, routers, and bridges. On the HPNA network, all devices impact the characteristics of the network because each device requires a certain amount of bandwidth to operate. Contact your cable service provider or consult the documentation for your HPNA device for more information on selecting the appropriate HPNA devices for your home or office purposes.

Where is the Best Location for My HPNA Devices?

You should work with your cable service provider to choose the best location for your HPNA devices. Consider these recommendations:

- Not all homes are wired the same. It is very important to ensure that the wall telephone jack is wired and functioning correctly to support a HPNA-certified device. You can test your telephone wiring using a simple phone line tester available at a variety of retailers.
- All HPNA devices must be connected to a single telephone line. Some home have more than one telephone line for a fax machine or a second voice line.
- The phone line used does not have to be an "active" telephone line with a telephone number. A spare telephone wiring pair may be used, but all HPNA devices must be connected to the same telephone wiring pair.

Now that you have selected a location for your HPNA network devices, the next step is to place and connect your HPNA network devices. Go to **How Do I Connect Home Phonenumber Networking Devices?**, next in this guide.

To connect home phoneline networking devices



WARNING:

- **Hazardous electrical voltages can be present on any connected wiring. Ethernet wiring and connections must be properly insulated to prevent electrical shock. Disconnect power from the cable modem gateway before attempting to connect to any device.**
- **To avoid personal injury, follow these steps in the exact order shown.**



CAUTION:

To prevent possible damage to the equipment, disconnect any other service before connecting your cable modem gateway to other devices.

Read the warnings and caution on this page. Then, follow the subsequent installation procedures to ensure proper cable modem gateway operation when connecting HPNA devices.

1. Select locations for your HPNA devices. For more information, see **How Do I Select and Place Home Phoneline Networking Devices?**, earlier in this guide.
2. Connect the HPNA port on the cable modem gateway to your wall telephone jack.
3. Connect the HPNA device(s).



It is essential that you connect the HPNA device(s) correctly. Most HPNA devices include two RJ-11 connectors. One connection is generally intended for connection to the wall jack and the other is intended as a filtered pass-through connection to telephones, fax machines, and telephone answering machines. This pass-through connection provides a mechanism to connect multiple phone devices to a single jack. If an HPNA device and telephone appliance need to share the wall jack and your HPNA device does not include a filtered pass-through connector, you will need to use a DSL filter with your phone Y-connector or splitter. These filters, connectors, and splitters are available from a variety of retailers.



Do not connect the HPNA device(s) using the pass-through connector to the wall telephone outlet.

4. Connect the active RF coaxial cable to the **CABLE IN** connector on the back of the cable modem gateway. Use an optional cable signal splitter to add a TV, a DHCT or set-top converter, or a VCR.
5. After all connections are complete, insert the AC power adapter cord into the DC power connector on the back of the cable modem gateway, and then plug the power adapter into an AC power source. The cable modem gateway begins an automatic search to locate and sign on to the network that provides the telephone service. This process may take up to 5 minutes. The cable modem gateway is ready for use when the **CABLE** status indicator on the front panel stops blinking and illuminates continuously.
6. Verify that all HPNA devices are working properly. You will not be able to check the HPNA front panel status indicator on the cable modem gateway until after two or more HPNA devices are connected to the network.

How Do I Configure the Cable Modem Gateway?

To configure your cable modem gateway, you must access the WebWizard configuration pages. This section provides detailed instructions and procedures for configuring your cable modem gateway to operate correctly and presents an example of each WebWizard page. Use the WebWizard pages to customize your cable modem gateway to your needs rather than using the default settings.

The WebWizard pages and the examples shown in this section are for illustration purposes only. Your pages will differ from the pages shown here.



If you are not familiar with the network configuration procedures detailed in this section, contact your cable service provider before you attempt to change any of the cable modem gateway default settings.

Configuring the Cable Modem Gateway

You must access the WebWizard in order to configure the cable modem gateway. To gain access to the WebWizard, use the Web browser on the PC attached to the cable modem. Type the following IP address and then select **Go**:

<http://192.168.0.1>

The Web browser accesses the WebWizard displaying the default About Your Modem page. This page displays information about the cable modem gateway.

About Your Modem Page Example

The following illustration is an example of the About Your Modem page.

The screenshot shows a Microsoft Internet Explorer browser window titled "Scientific Atlanta DPR300 Configuration - Microsoft Internet Explorer". The address bar displays "http://192.168.0.1/". The page content includes a navigation menu with "System", "Signal", "Status", "Log", and "Setup" links, along with "WebSTAR" and "Scientific Atlanta" logos. Below the menu is the "About Your Modem" section, which states "This page provides basic information about your cable modem." and contains a table of modem details.

Name	WebSTAR DPR300 Series Cable Modem
Cable Modem Serial Number	CM081226
Cable Modem MAC Address	00:40:7b:78:67:cc
Hardware Version	1.8
Software Version	FLASH Bank 1: Software 1.1.143
Receive Power Level	8.1 dBmV
Transmit Power Level	14.28 dBmV
Cable Modem Status	up430c4M

About Your Modem Page Description

The following table provides a description of each field within the About Your Modem page.

Field Name	Description
Name	The name of the cable modem gateway
Cable Modem Serial Number	A unique sequential series of alphanumeric characters provided to every modem during manufacturing
Cable Modem MAC Address	A unique alphanumeric address for the cable modem coaxial interface, which is used to connect to the cable modem termination system (CMTS) at the headend. A media access control (MAC) address is a hardware address that uniquely identifies each node of a network
Hardware Version	Identifies the revision of the circuit board design
Software Version	Identifies the software version placed into the modem at the time of manufacturing
Receive Power Level	The input level of the downstream CMTS carrier
Transmit Power Level	Indicates the upstream power level
Cable Modem Status	Lists one of the following five possible current states of the modem: <ul style="list-style-type: none"> • notSynchronized • phySynchronized • rangingComplete • registrationComplete • operational

Setup Page Section Headings

The Setup page is divided into the following section headings:

- Basic Settings
- Advanced Settings
- Firewall
- Wireless

Click the selections listed within these sections to access the WebWizard page for that selection. A description of the selections available in each section follows next.

Basic Settings

The following table provides a description of the pages available from within the Basic Settings section of the Setup page.

Field Name	Description
Password Settings	Use this page to modify your password settings
Network Configuration	Use this page to enter or modify the basic settings for your network
IP Address Management	Use this page to configure how Internet protocol (IP) addresses are assigned and managed in your network

Advanced Settings

The following table provides a description of the pages available from within the Advanced Settings section of the Setup page.

Field Name	Description
Options	Use this page to enable or disable advanced features on your network
IP Address Filtering	Use this page to configure IP address filters. These filters prevent designated IP addresses from accessing the Internet
MAC Address Filtering	Use this page to configure MAC address filters. These filters prevent designated MAC addresses from accessing the Internet
Port Filtering	Use this page to configure transmission control protocol (TCP) and user datagram protocol (UDP) port filters. These filters prevent a range of TCP/UDP ports from accessing the Internet

Field Name	Description
Port Forwarding	Use this page to configure port forwarding for local IP addresses. Port forwarding allows you to run a server on the local area network (LAN) by specifying the mapping of TCP/UPD ports to local PCs or to the IP address of other devices. This is a static setting that holds the ports open at all times.
Port Triggers	Use this page to configure TCP/UPD port triggers. Port triggering is similar to port forwarding, but is a dynamic function. In other words, the ports are not held open, and the ports close if no outgoing data is detected on the selected ports for a period of 10 minutes.
DMZ Host (Demilitarized Zone)	Use this page to configure an IP address that is visible to the wide area network (WAN). DMZ hosting is commonly referred to as "exposed host," and allows you to specify the "default" recipient of WAN traffic that Network Address Translation (NAT) is unable to translate to a known local PC. A DMZ is used by a company that wants to host its own Internet services without sacrificing unauthorized access to its private network. DMZ allows one IP address to be unprotected while others remain protected. The DMZ is located between the Internet and an internal network's line of defense that is a combination of firewalls and bastion hosts. Typically, the DMZ contains devices accessible to Internet traffic, such as Web (HTTP) servers, FTP servers, SMTP (e-mail) servers, and domain name system (DNS) servers.

Firewall

The following table provides a description of the pages available from within the Firewall section of the Setup page.

Field Name	Description
Web Filters	Use this page to configure Web page filtering and firewall protection. This page allows you to block/allow Internet access based on keywords and/or domain names
Event Logging	Use this page to access the firewall event log and to enter your e-mail address in order to receive e-mail alerts related to firewall attacks by hackers

Wireless

The following table provides a description of the pages available from within the Wireless section of the Setup page.

Field Name	Description
Basic	Use this page to configure your wireless access point (WAP) parameters, including service set identifier (SSID) and channel number
Privacy	Use this page to configure your WAP wired equivalent privacy (WEP) encryption keys and authentication. Using encryption and authentication prevents unauthorized access to your wireless devices
Advanced	Use this page to configure your WAP data rates and wireless fidelity (WiFi) thresholds

Configuring Your Password Settings

Use the Basic Settings - Password Settings page to set up a password to restrict unauthorized persons from accessing to your cable modem gateway settings. Click **Password Settings** in the Basic Settings section of the Setup page to access the Password Settings page.



You are *not* required to set up a password for your cable modem gateway, but if you do choose to set up a password, use a password that you can easily remember. Do *not* forget your password.

Setup Basic Settings – Password Settings Page Example

The following illustration is an example of the Basic Settings – Password Settings page.

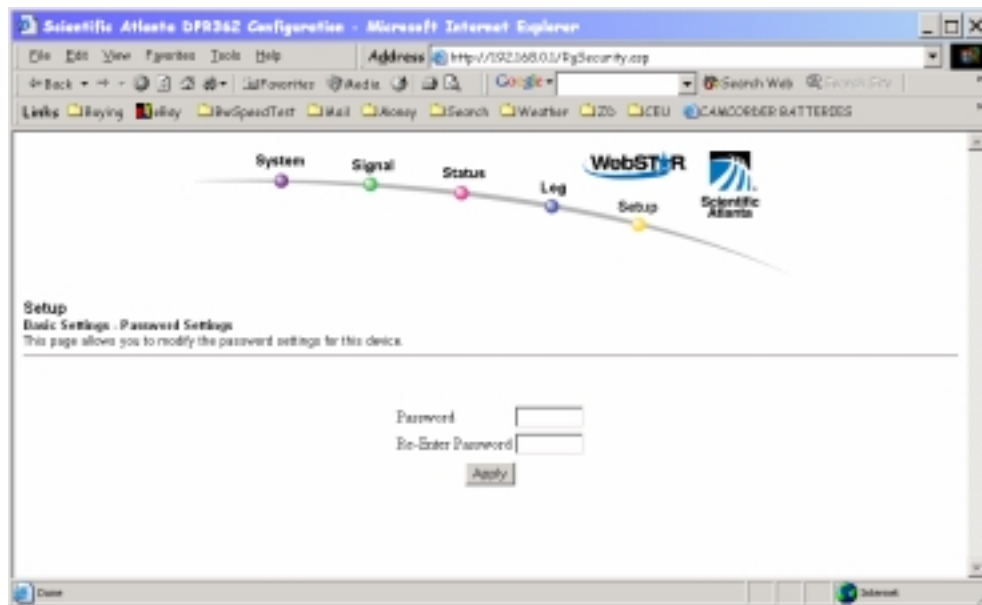

Setting Up Your Password

To set up your password, type your password in the Password field, then re-type your password in the Re-Enter Password field and then click **Apply** to save your password.



If you set a password, on subsequent access to the WebWizard pages, a screen similar to the following appears. Do *not* forget your password. Write your password and store it in a secure location known only to you.

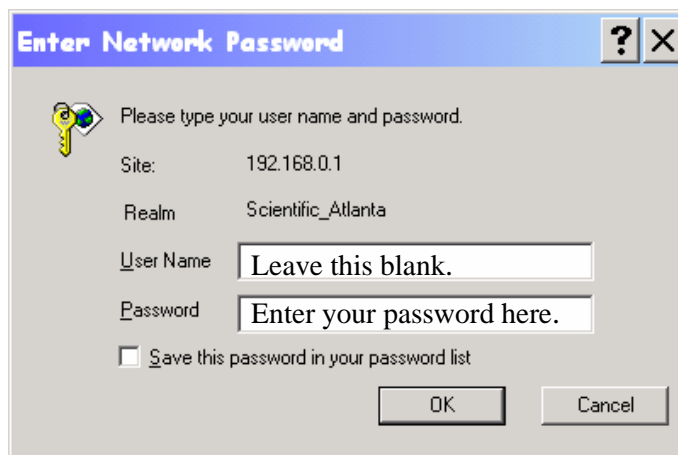

Configuring the Default Settings

You can use the default settings, or, if your system requires different settings to operate correctly, you can change the default settings using the Setup Basic Settings – Network Configuration page.



If you are not familiar with the network configuration procedures detailed in this section, contact your cable service provider before you attempt to change any of the cable modem gateway default network configuration settings.

Click **Network Configuration** in the Basic Settings section of the Setup page to access the Setup Basic Settings – Network Configuration page.

Setup Basic Settings – Network Configuration Page Example

The following illustration is an example of the Setup Basic Settings – Network Configuration page.

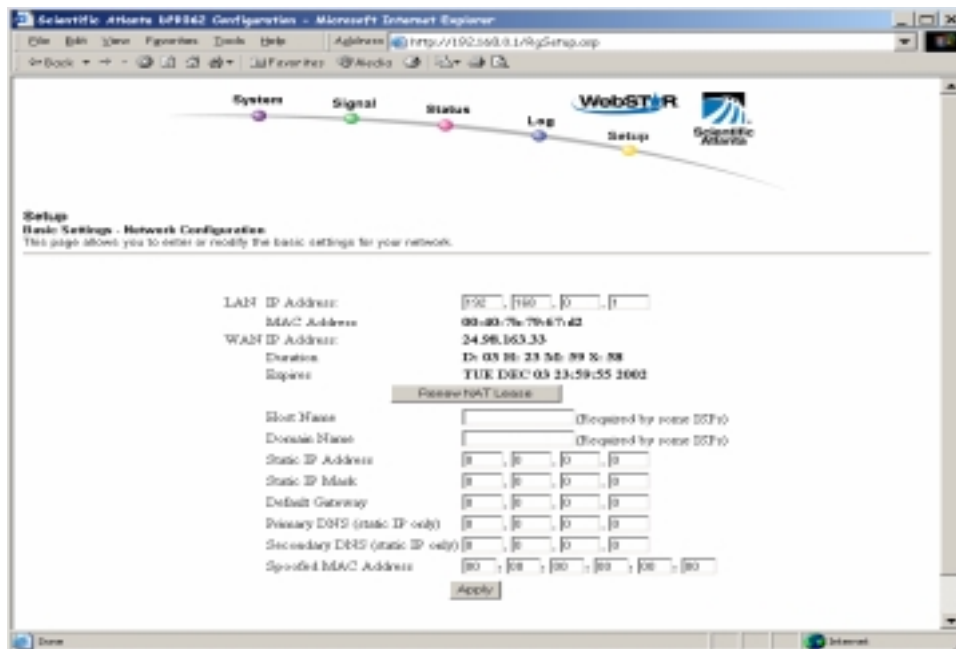

Setup Basic Settings – Network Configuration Page Description

The following table provides a description of the fields within the Setup Basic Settings – Network Configuration page.

Field Name	Description
LAN IP Address	The base IP address of the private home LAN and the WebWizard IP address. Your cable modem gateway assigns private IP addresses to your attached computers by its internal dynamic host configuration protocol (DHCP) server
MAC Address	The MAC address of the four-port switch on your private home LAN
WAN IP Address	The public IP address assigned to your cable modem by your ISP
Duration	The length of time your WAN IP address is valid. This length of time renews when this duration expires
Expires	The date and time your WAN IP address expires
Host Name	Some ISPs require this information for authentication and will supply it to you
Domain Name	Some ISPs require this information for authentication and will supply it to you
Static IP Address	Some ISPs require this information for authentication and will supply it to you
Static IP Mask	Some ISPs require this information for authentication and will supply it to you
Default Gateway	Some ISPs require this information for authentication and will supply it to you
Primary DNS	Some ISPs require this information for authentication and will supply it to you
Secondary DNS	Some ISPs require this information for authentication and will supply it to you
Spoofed MAC Address	Some ISPs require the MAC address of the network interface card (NIC) in your computer for authentication. When installing the cable modem gateway, you can enter your computer MAC address here to allow you to connect to your ISP

Function Keys

The following function keys appear on the Setup Basic Settings – Network Configuration page.

Key	Description
Renew NAT Lease	Forces a release and renewal of your WAN IP address
Apply	Saves the values you enter into the fields without closing the screen

Configuring and Managing IP Addresses

Use the Basic Settings – IP Management page to configure how your system manages and assigns IP addresses in your network.



If you are not familiar with the IP management procedures detailed in this section, contact your cable service provider before you attempt to change any of the cable modem gateway default IP management settings.

Click **IP Management** in the Basic Settings section of the Setup page to access the Setup Basic Settings – IP Management page.

Setup Basic Settings – IP Management Page Example

The following illustration is an example of the Setup Basic Settings – IP Management page.

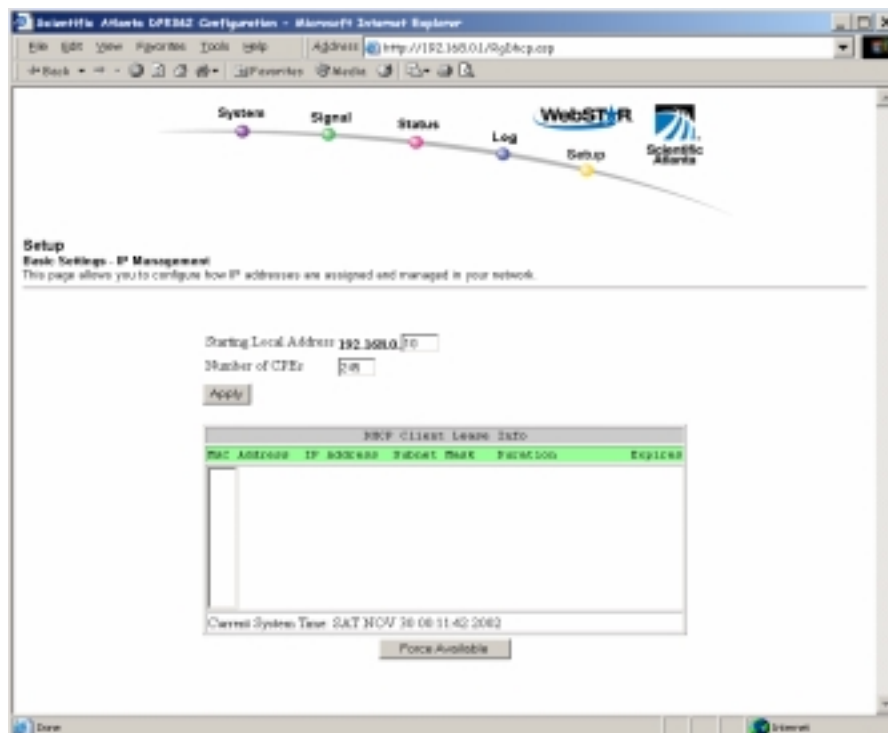

Setup Basic Settings – IP Management Page Description

The following table provides a description of the fields within the Basic Settings – IP Management page.

Field Name	Description
Starting Local Address	The starting address used by the built-in DHCP server to distribute Private LAN IP addresses. In the example shown, addresses between 2 and 9 can be used for devices on your Private LAN that require fixed IP addresses such as printer servers, Web servers, and mail servers
Number of CPEs	Enter the maximum number of devices you are allowed to connect to your Private LAN Note: The maximum number of devices is 245.
DHCP Client Lease Info	Displays the MAC address, IP Address, Subnet Mask, Duration and Expiration date of all devices issued an IP address by the built-in DHCP server. This field also displays the current system time and date

Function Keys

The following function keys appear on the Basic Settings – IP Management page.

Key	Description
Apply	Saves the values you enter into the fields without closing the screen
Force Available	Forces the release of an IP address for you to use

Enabling and Disabling Advanced Features

Use the Setup Advanced Settings – Options page to enable or disable advanced features on your network.



If you are not familiar with the advanced settings detailed in this section, contact your cable service provider before you attempt to change any of the cable modem gateway default advanced options settings.

Click **Options** in the Advanced Settings section of the Setup page to access the Setup Advanced Settings – Options page.

Setup Advanced Settings – Options Page Example

The following illustration is an example of the Setup Advanced Settings – Options page.

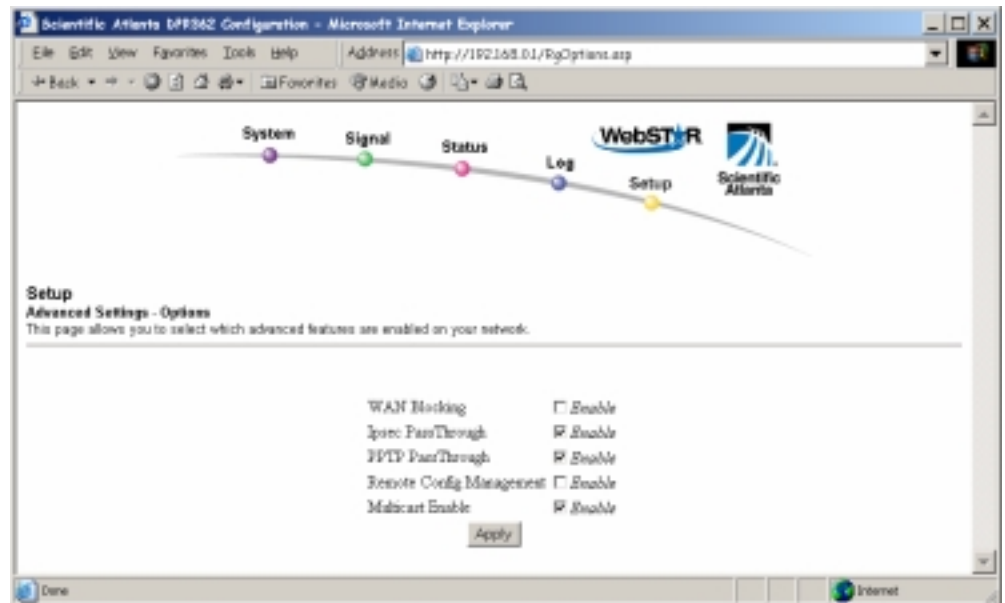

Setup Advanced Settings – Options Page Description

The following table provides a description of the fields within the Setup Advanced Settings – Options page.



If you make changes in the Setup Advanced Settings – Options page, click **Apply** to apply and save your new IP address filter settings.

Field Name	Description
WAN Blocking	Checking this box prevents the cable modem gateway or the PCs behind it from being visible to the WAN. For example, pings to the WAN IP address or the cable modem gateway or to the PCs behind it are not returned
IPSec Pass Through	Checking this box allows applications that use IPSec (IP Security) to pass through the firewall
PPTP Pass Through	Checking this box allows applications that use Point to Point Tunneling Protocol (PPTP) to pass through the firewall
Remote Configuration Management	Checking this box allows Remote Configuration Management from the WAN side of the cable modem gateway. Access is allowed by using the preset password to access the WebWizard
Multicast Enable	Checking this box allows multicasts to pass from the WAN side through to the private network

Configuring IP Address Filters

Use the Setup Advanced Settings – IP Filtering page to configure IP address filters. These filters block a range of IP addresses from accessing the Internet.



If you are not familiar with the advanced settings detailed in this section, contact your cable service provider before you attempt to change any of the cable modem gateway default advanced IP filtering settings.

Click **IP Filtering** in the Advanced Settings section of the Setup page to access the Setup Advanced Settings – IP Filtering page.

Setup Advanced Settings – IP Filtering Page Example

The following illustration is an example of the Setup Advanced Settings – IP Filtering page.

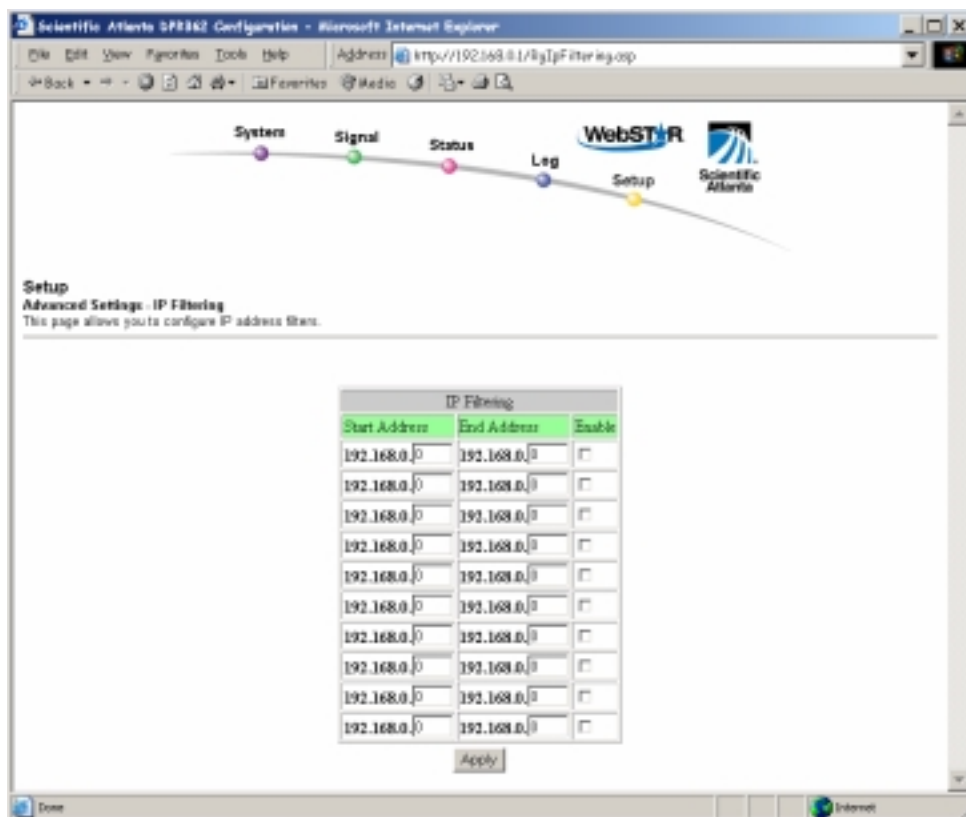

Setup Advanced Settings – IP Filtering Page Description

Use this page to specify and enable a range of IP addresses to prevent access to the Internet. Click **Apply** to apply and save your new IP address filter settings.

Configuring MAC Address Filters

Use the Setup Advanced Settings – MAC Filtering page to configure MAC address filters. These filters prevent individual MAC addresses from accessing the Internet. You can also prevent individual PCs from sending outgoing TCP/UDP traffic to the WAN using their MAC address.



If you are not familiar with the advanced settings detailed in this section, contact your cable service provider before you attempt to change any of the cable modem gateway default advanced MAC filtering settings.

Click **MAC Address Filtering** in the Advanced Settings section of the Setup page to access the Setup Advanced Settings – MAC Filtering page.

Setup Advanced Settings – MAC Filtering Page Example

The following illustration is an example of the Setup Advanced Settings – MAC Filtering page.

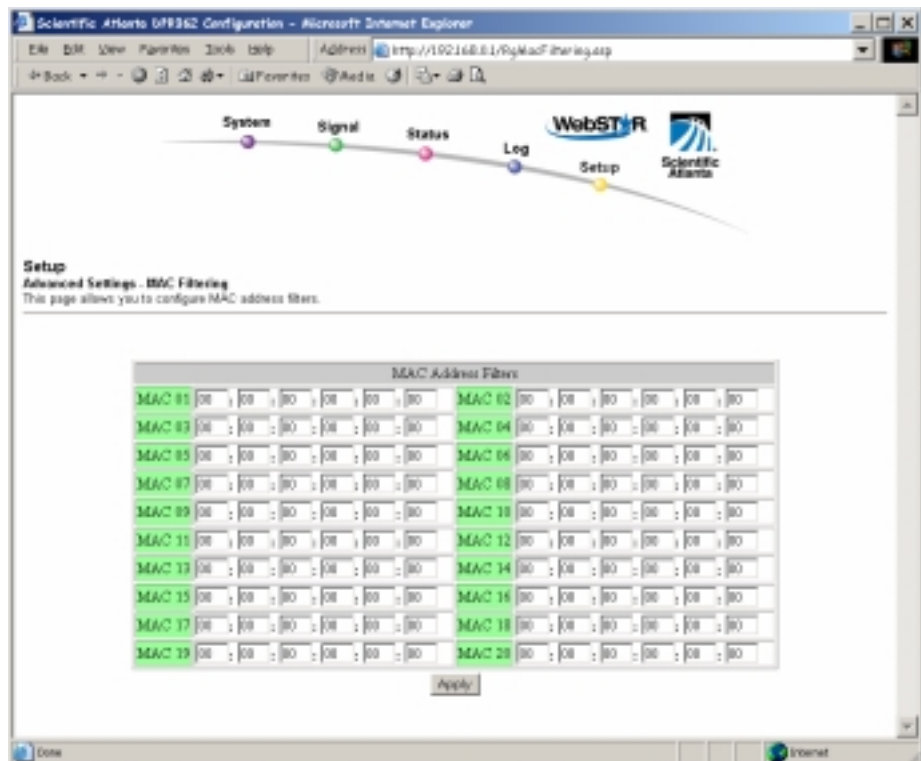

Setup Advanced Settings – MAC Filtering Page Description

Use this page to enter the MAC address or MAC addresses you want to filter into the appropriate fields, and click **Apply** to apply and save your new MAC address filter settings.

Configuring and Enabling TCP and UDP Port Filters

Use the Setup Advanced Settings – Port Filtering page to configure and enable TCP and UDP port filters. These filters prevent a range of TCP/UDP ports from accessing the Internet. You can also prevent PCs from sending outgoing TCP/UDP traffic to the WAN on specific IP port numbers. This filter is *not* IP address or MAC address-specific. The system blocks the specified port ranges for *all* PCs.



If you are not familiar with the advanced settings detailed in this section, contact your cable service provider before you attempt to change any of the cable modem gateway default advanced port filtering settings.

Click **Port Filtering** in the Advanced Settings section of the Setup page to access the Setup Advanced Settings – Port Filtering page.

Setup Advanced Settings – Port Filtering Page Example

The following illustration is an example of the Setup Advanced Settings – Port Filtering page.

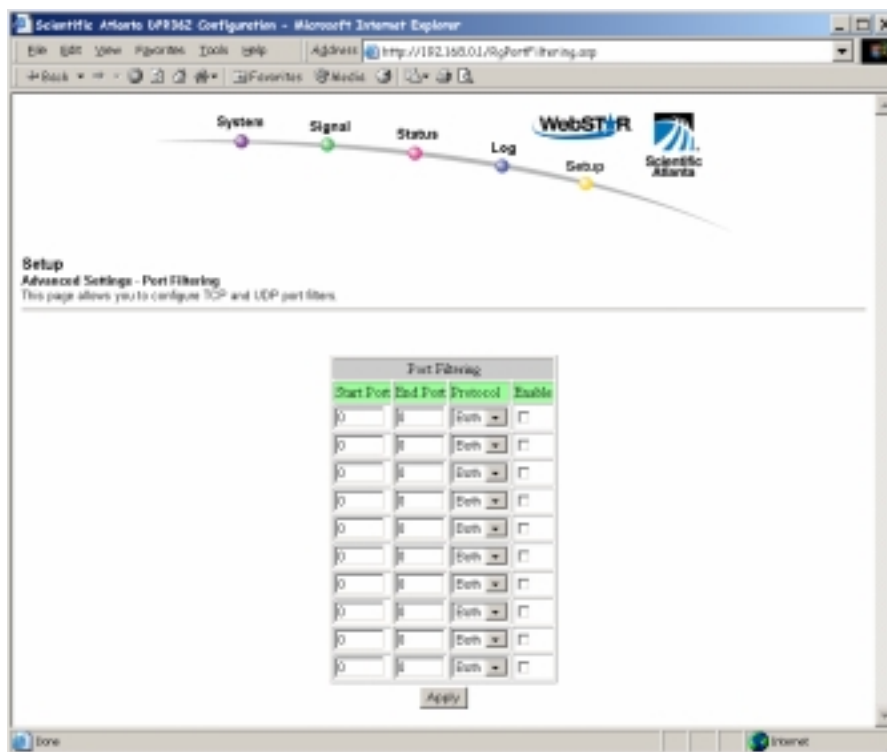

Setup Advanced Settings – Port Filtering Page Description

Use this page to enter and enable the desired port filtering ranges and protocols in the appropriate fields and then click **Apply** to apply and save your new port filtering settings.

Configuring Port Forwarding for Local IP Addresses

Use the Setup Advanced Settings – Port Forwarding page to configure port forwarding for local IP addresses. Port forwarding allows you to run a server on the LAN by specifying the mapping of TCP/UDP ports to a local PC. You must also set up a fixed private LAN IP address for the destination device.



If you are not familiar with the advanced settings detailed in this section, contact your cable service provider before you attempt to change any of the cable modem gateway default advanced port forwarding settings.

Click **Port Forwarding** in the Advanced Settings section of the Setup page to access the Setup Advanced Settings – Port Forwarding page.

Setup Advanced Settings – Port Forwarding Page Example

The following illustration is an example of the Setup Advanced Settings – Port Forwarding page.

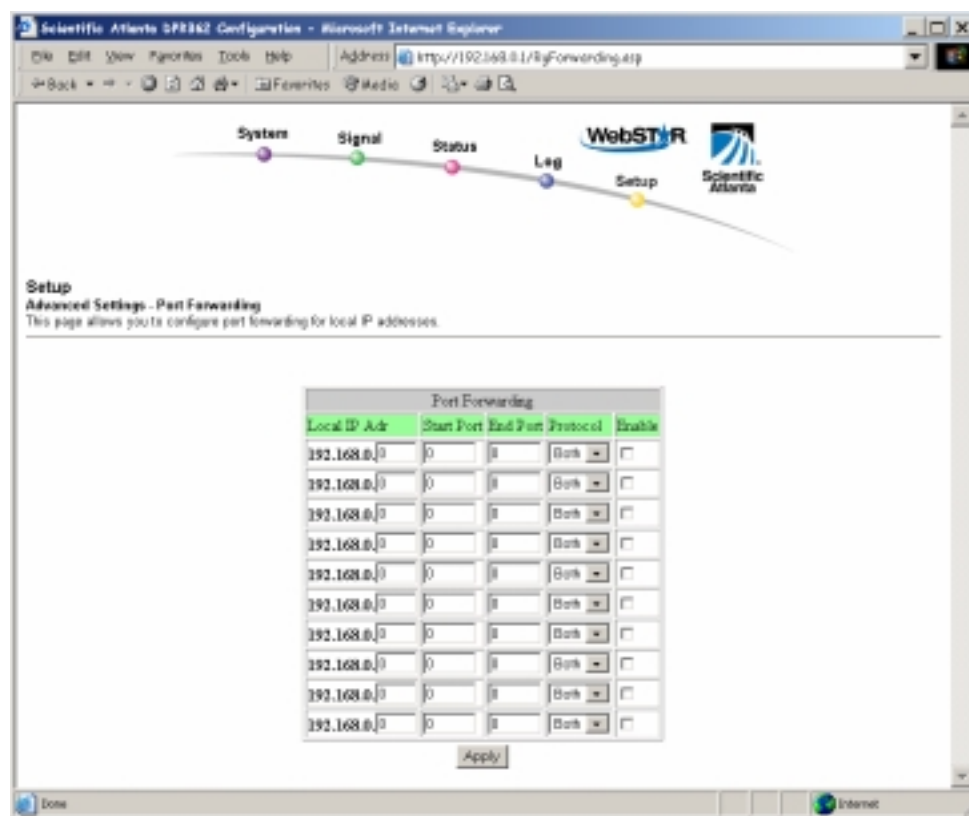

Setup Advanced Settings – Port Forwarding Page Description

The following example illustrates how to use the port forwarding feature to configure the Microsoft X-Box Online Live for Internet gaming.

1. Set the X-Box to a fixed IP address, for example, **192.168.0.5**.
2. Enter the same IP address (192.168.0.5) in the Local IP Address field as the first entry in the Port Forwarding area of the page.
3. Enter **88** in *both* the Start Port and End Port fields in the same row you used in step 2.
4. Select **UDP** from the drop-down list in the Protocol field in the same row you used in steps 2 and 3, and then select the box in the **Enable** field.
5. Enter the same IP address you entered in step 2 as the second entry in the Port Forwarding area of the page.
6. Enter **3074** in *both* the Start Port and End Port fields in the same row you used in step 5.
7. Select **Both** in the same row you used in steps 5 and 6, and then select the box in the **Enable** field.
8. Click **Apply** to apply and save your new port forwarding settings.

Configuring TCP/UDP Port Triggers

Use the Setup Advanced Settings – Port Triggers page to configure TCP/UDP port triggers. Port triggering is similar to port forwarding but is dynamic. In other words, the system does not hold the ports open indefinitely. For example, when the cable modem gateway detects outgoing data on a specific IP port number set in the “Trigger Range,” the resulting ports set in the “Target Range” open for incoming data. If the system detects no outgoing traffic on the “Trigger Range” ports for a period of 10 minutes, the “Target Range” ports close. This is a safer method for opening specific ports for special applications, such as, video conferencing programs, interactive gaming, and file transfer in chat programs. This is safe because the ports are dynamically triggered and not held open continuously, or erroneously left open by the router administrator. Therefore, these ports are not exposed and vulnerable for potential hackers to discover.



If you are not familiar with the advanced settings detailed in this section, contact your cable service provider before you attempt to change any of the cable modem gateway default advanced port triggers settings.

Click **Port Triggers** in the Advanced Settings section of the Setup page to access the Setup Advanced Settings – Port Triggers page.

Setup Advanced Settings – Port Triggers Page Example

The following illustration is an example of the Setup Advanced Settings – Port Triggers page.

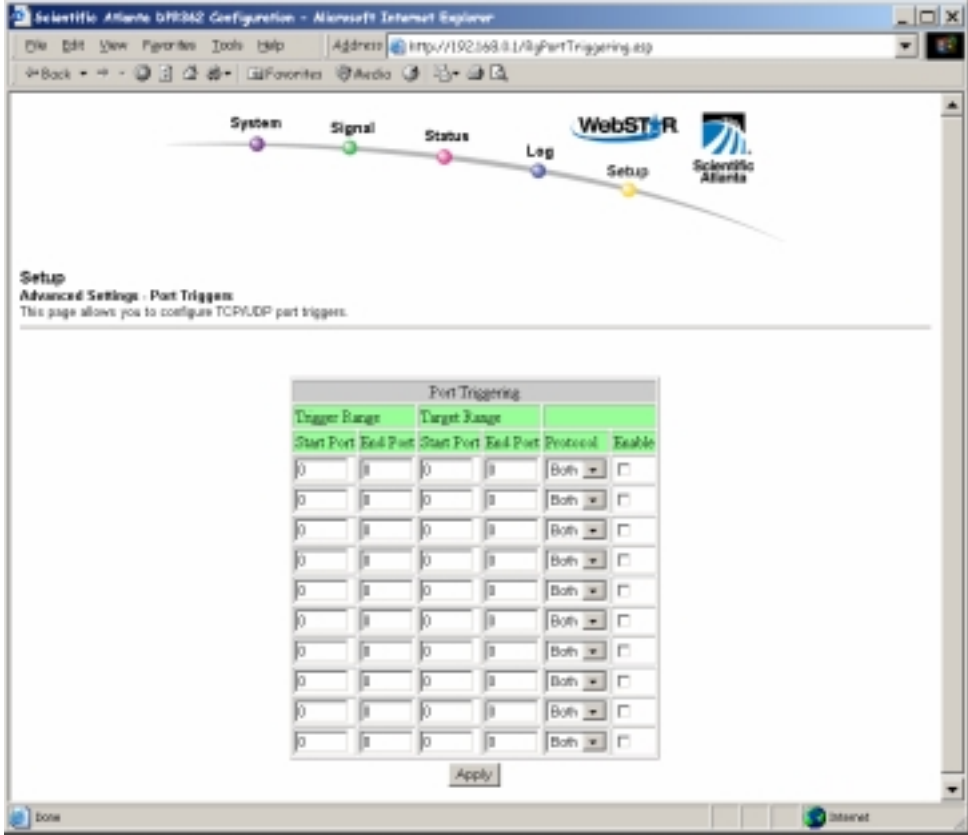

Setup Advanced Settings – Port Triggers Page Description

Use this page to enter and enable the port forwarding trigger and target range start and end ports along with protocol information in the appropriate fields. Then click **Apply** to apply and save your new port triggers settings.

Configuring the DMZ Host

Use the Setup Advanced Settings – DMZ Host page to configure an IP address that is visible to the WAN. DMZ hosting is commonly referred to as “exposed host,” and allows you to specify the “default” recipient of WAN traffic that Network Address Translation (NAT) is unable to translate to a known local PC. DMZ allows one IP address to be unprotected while others remain protected.



If you are not familiar with the advanced settings detailed in this section, contact your cable service provider before you attempt to change any of the cable modem gateway default advanced DMZ host settings.

Click **DMZ Host** in the Advanced Settings section of the Setup page to access the Setup Advanced Settings – DMZ Host page.

Setup Advanced Settings – DMZ Host Page Example

The following illustration is an example of the Setup Advanced Settings – DMZ Host page.

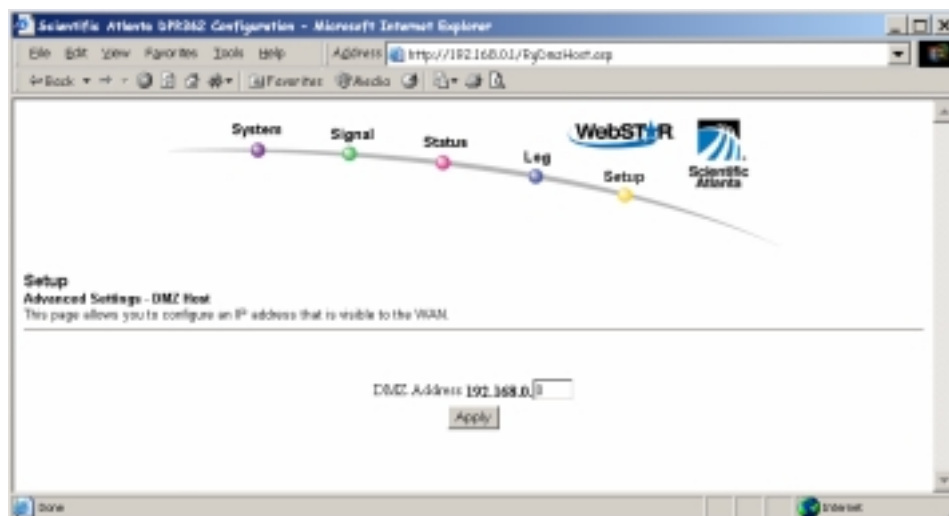

Setup Advanced Settings – DMZ Host Page Description

Use this page to place a Private LAN IP device, for example, an FTP, Mail, or Web server directly on the Internet (bypassing the firewall). You set the server with a fixed IP address as a DMZ Host by entering its IP address above. Make sure the IP address used is not in the range of addresses delivered by the built-in DHCP server. After setting up a DMZ Host, all ports on this device are open to the Internet. You may configure only one PC to be the DMZ host. This setting is generally used for PC's using “problem” applications that use random port numbers and do not function correctly with specific port triggers or port forwarding setups described earlier in this guide. After entering a DMZ Address, click **Apply** to apply and save your new DMZ Host setting.

Configuring Web Page Filtering and Firewall Protection

Use the Setup Firewall – Web Filters page to configure Web page filtering and firewall protection. This page allows you either block or allow Internet access based on keywords and/or domain names. You can also filter on the time of day and the day of the week.



If you are not familiar with the advanced settings detailed in this section, contact your cable service provider before you attempt to change any of the cable modem gateway default firewall Web filters settings.

Click **Web Filters** in the Firewall section of the Setup page to access the Setup Firewall – Web Filters page.

Setup Firewall – Web Filters Page Example

The following illustration is an example of the Setup Firewall – Web Filters page.

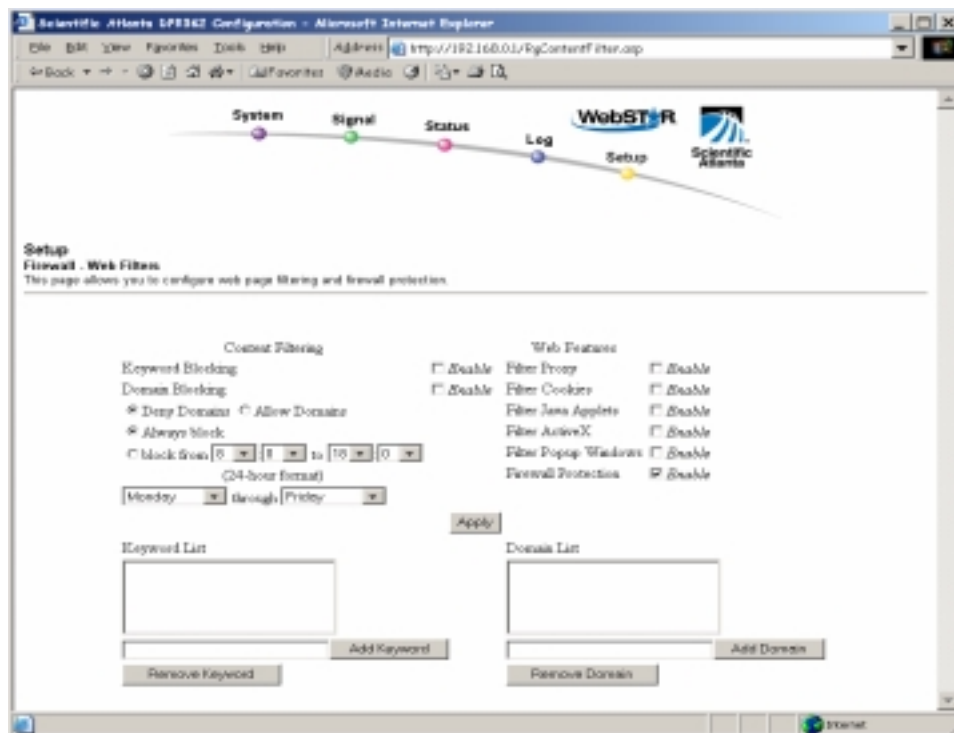

Setup Firewall – Web Filters Page Description

This section describes the section headings and fields descriptions of the Setup Firewall – Web Filters page.

Section Headings

The Setup Firewall – Web Filters page is divided into the following section headings:

- Content Filtering
- Web Features
- Keyword List
- Domain List



If you make changes in *any* of the fields in the Setup Firewall – Web Filters page, click **Apply** to apply and save your Content Filter settings.

Content Filtering

The following table provides a description of each field name within the Content Filtering section heading.

Field Name	Description
Keyword Blocking	Allows you to block or allow Internet access based on keywords
Domain Blocking	Allows you to block or allow Internet access based on domain names and on time of day and day of week

Web Features

The following table provides a description of each field name within the Web Features section heading.

Field Name	Description
Filter Proxy	Enables/disables proxy
Filter Cookies	Enables/disables cookie blocking
Filter Java Applets	Enables/disables java applets
Filter ActiveX	Enables/disables ActiveX controls
Filter Popup Windows	Enables/disables popup windows
Firewall Protection	Enables/disables the firewall

Keyword List

Use the Keyword List to permanently add keywords to the Web Filter feature by typing a word into the Keyword List field, and then clicking **Add Keyword**. To remove a keyword from the Keyword List, highlight the keyword in the Keyword List field, and then click **Remove Keyword**.

Domain List

Use the Domain List to permanently add domain names to the Web Filter by typing a domain name into the Domain List field, and then clicking **Add Domain**. To remove a domain name from the Domain List, highlight the domain name in the Domain Name list, and then click **Remove Domain**.

Configuring Firewall Event Logging and E-mail Alerts

Use the Setup Firewall – Event Logging page to access the firewall event log and allows you to enter your e-mail address in order for you to receive e-mail alerts related to firewall attacks by hackers.



If you are not familiar with the advanced settings detailed in this section, contact your cable service provider before you attempt to change any of the cable modem gateway default firewall event logging settings.

Click **Event Logging** in the Firewall section of the Setup page to access the Setup Firewall – Event Logging page.

Setup Firewall – Event Logging Page Example

The following illustration is an example of the Setup Firewall – Event Logging page.



Setup Firewall – Event Logging Page Description

The Setup Firewall – Event Logging page shows events capture by the firewall. The log shows the log shows the following items:

- Description of the event
- Number of events that have occurred
- Last occurrence of an event
- Target and source addresses

You can configure the system to e-mail log events to the administrator in order for the administrator to monitor the firewall.

This section describes the section headings and fields descriptions of the Setup Firewall – Event Logging page.

Field Name	Description
Contact Email Address	Allows you to enter the e-mail address of the person who monitors the firewall
SMTP Server Name	Allows you to enter the mail server name your outgoing mail server, or the mail server of your Internet service provider (ISP)
E-mail Alerts	Allows you to enable/disable sending e-mail alerts

Function Keys

The following function keys appear on the Setup Firewall – Event Logging page.

Key	Description
Apply	Saves the values you enter into the fields without closing the screen
E-mail Log	Allows you to force the system to send an e-mail alert even if the E-mail Alerts box is left un-checked
Clear Log	Allows you to clear all entries in the log

Configuring Your Wireless Access Point Parameters

Use the Setup Wireless – Basic page to configure your wireless access point (WAP) parameters, including SSID and channel number.



If you are not familiar with the advanced settings detailed in this section, contact your cable service provider before you attempt to change any of the cable modem gateway default wireless basic settings.

Click **Basic** in the Wireless section of the Setup page to access the Setup Wireless – Basic page.

Setup Wireless – Basic Page Example

The following illustration is an example of the Setup Wireless – Basic page.

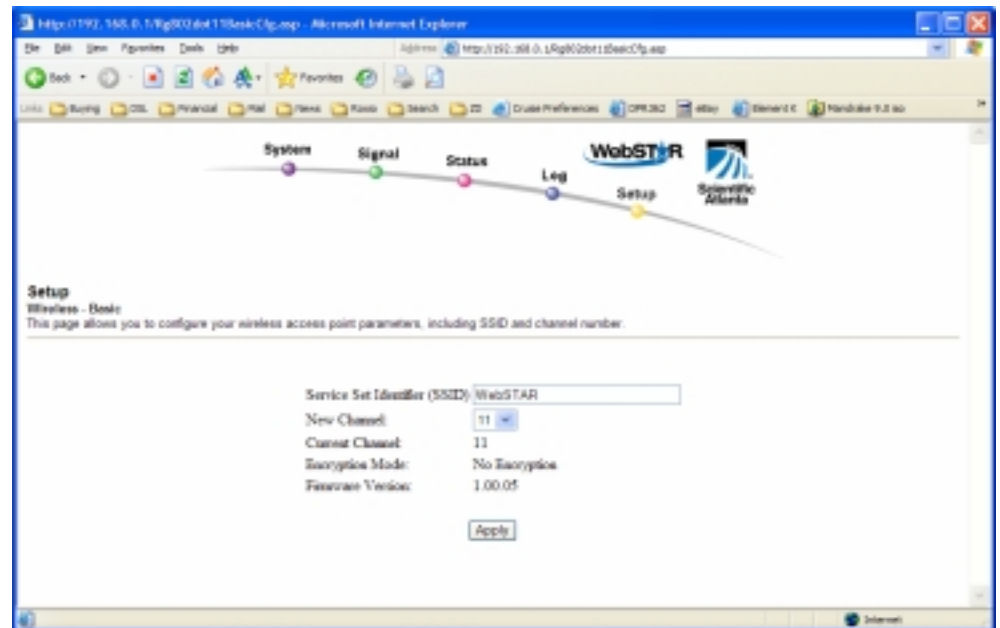



Setup Wireless – Basic Page Description

This section describes the section headings and fields descriptions of the Setup Wireless – Basic page.



If you make changes in the Setup Wireless – Basic page, click **Apply** to apply and save your wireless basic settings.

Field Name	Description
Service Set Identifier (SSID)	<p>The name assigned to your WAP area of coverage</p>  <p>The SSID field should contain the product name WebSTAR.</p>
New Channel (1-11)	<p>Allows setting a communications channel for your WAP</p>  <p>For systems with multiple WAPs, adjacently located WAPs must be set to output channels that are at least 2 channels apart.</p> <p>Example: If one WAP is set to channel 1, then the adjacent WAP should have a channel that is higher than channel 3, for example, set to channel 4.</p> <p>If your wireless network is not operating correctly, or if external devices are interfering with your signal, try selecting a different channel.</p>
Current Channel	Present channel the WAP is using
Encryption Mode	Shows current encryption mode
Firmware Version	Shows current firmware version

Configuring Your Wireless Network Privacy and Encryption Parameters

Use the Setup Wireless – Privacy page to configure your WAP wired equivalent privacy (WEP) encryption keys and authentication.



If you are not familiar with the advanced settings detailed in this section, contact your cable service provider before you attempt to change any of the cable modem gateway default wireless privacy settings.

Click **Privacy** in the Wireless section of the Setup page to access the Setup Wireless – Privacy page.

Setup Wireless – Privacy Page Example

The following illustration is an example of the Setup Wireless – Privacy page.

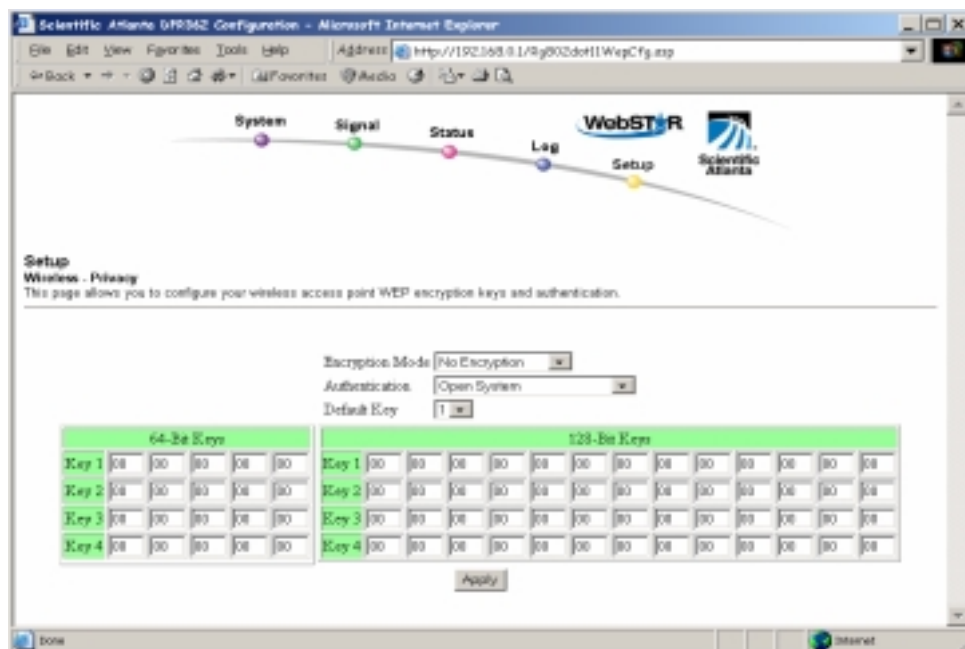

Setup Wireless – Privacy Page Description

This section describes the section headings and fields descriptions of the Setup Wireless – Privacy page.



If you make changes in the Setup Wireless – Privacy page, click **Apply** to apply and save your wireless privacy settings.

Field Name	Description
Encryption Mode	Allows setting No Encryption, 64-bit Encryption, or 128-bit encryption modes.
Authentication	<p>Allows setting one of the following authentication modes:</p> <ul style="list-style-type: none"> • Open System—Open system authentication allows any device to authenticate and then attempt to communicate with the wireless access point (WAP). Communication occurs if both devices have matching pre-configured WEP keys. • Shared Key—During shared key authentication, the WAP sends an unencrypted challenge text string to any device attempting to communicate with the WAP. The device requesting authentication encrypts the challenge text and sends it back to the WAP. If the challenge text is encrypted correctly, the access point allows the requesting device to authenticate. Both the encrypted challenge and the encrypted challenge response can be monitored, however, which leaves the WAP open to attack from intruders. Therefore, shared key authentication can be less secure than open authentication. • Open System or Shared Key—Either Open System or Shared Key can associate with the WAP
Default Key	Select which of the four 64-bit or 128-bit Keys to activate.
64 Bit Keys	<p>For use with Encryption Mode set to 64-bit encryption. Enter 5-byte values for a Key. You do not have to set all four Keys. Usually only one Key is needed for a home network. Each value is represented in hexadecimal. Use only these numbers or letters: 0, 1, 2, 3, 4, 5, 6, 7, 8, 9, A, B, C, D, E, and F.</p> <p>Use two numbers or letters in each box. Record your Key values. You will need these Key values when you set up your client (PCMCIA) wireless card. The Key values in each respective column <i>must</i> match.</p>

<p>128 Bit Keys</p>	<p>For use with Encryption Mode set to 128-bit encryption. Enter 13-byte values for a Key. You do not have to set all four Keys. Usually only one is needed for a home network. Each value is represented in hexadecimal. Use only these numbers or letters: 0, 1, 2, 3, 4, 5, 6, 7, 8, 9, A, B, C, D, E, and F.</p> <p>Use two numbers or letters in each box. Record your Key values. You will need these Key values when you set up your client (PCMCIA) wireless card. The Key values in each respective column <i>must</i> match.</p>
---------------------	--

Configuring Wireless Data Rates and WiFi Thresholds

Use the Setup Wireless – Advanced page to configure your WAP data rates and wired fidelity (WiFi) thresholds.



If you are not familiar with the advanced settings detailed in this section, contact your cable service provider before you attempt to change any of the cable modem gateway default wireless advanced settings.

Click **Advanced** in the Wireless section of the Setup page to access the Setup Wireless – Advanced page.

Setup Wireless – Advanced Page Example

The following illustration is an example of the Setup Wireless – Advanced page.



We recommend that you do *not* change the default wireless settings that are shown in the preceding illustration unless you are instructed to do so by your cable service provider.

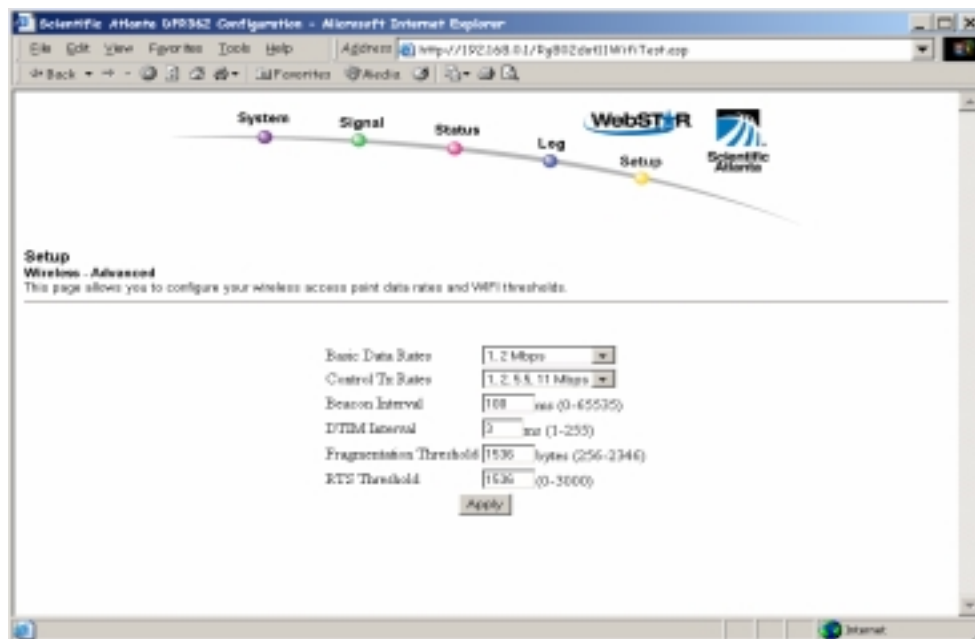

Setup Wireless – Advanced Page Description

This section describes the section headings and fields descriptions of the Setup Wireless – Advanced page.



If you make changes in the Setup Wireless – Advanced page, click **Apply** to apply and save your wireless advanced settings

Field Name	Description
Basic Data Rates	Displays the default initial data rate for associating with a WAP. For maximum client compatibility, it is recommended that the Basic Data Rates are set at 1, 2 Mbps so that older cards can easily gain access to the network. This setting specifies the minimal set of required data rates
Control Tx Rates	Displays the transmit data rates the WAP uses is a function of signal strength and signal quality. For maximum potential link speed, it is recommended that you select all control Tx rates: 1, 2 Mbps , 5.5 Mbps, and 11 Mbps
Beacon Interval	Displays the time interval that the WAP uses to announce itself to remote devices. The Beacon Interval should be left at 100ms for compliance with most client cards. The Beacon Interval specifies how often packets are sent by the Access Point (AP) to synchronize a wireless network and it's clients
DTIM Interval	Displays the time interval between Broadcasts/Multicast transmissions. The DTIM (Delivery Traffic Indication Message) Interval is a countdown informing the wireless clients of the next window for listening to broadcast and multicast messages. When the AP has buffered broadcast or multicast messages for associated clients, it sends the next DTIM with a DTIM Interval value. AP clients hear the beacons and awaken to receive the broadcast and multicast messages. The DTIM Interval should be left at 3 ms for compliance with most client cards
Fragmentation Threshold RTS Threshold	Fragmentation and ready to send (RTS) thresholds should be set equivalent to the maximum Ethernet frame size allowable on the link including overhead (1536 bytes). Lesser settings can damage data throughput as large frames could be fragmented or collisions could occur

How Do I Monitor the Cable Modem Gateway?

There are several WebWizard pages available for monitoring the performance of the cable modem gateway. These pages are the Signal page, the Status page, and the Log page. This section provides examples and descriptions of these WebWizard pages.

Viewing the Status and Quality of Network Communications

Use the Signal page to view important information about the status and quality of the communication between your cable modem gateway and the cable modem network.

Click **Signal** on the arc in the upper portion of any WebWizard page to access the Signal page.

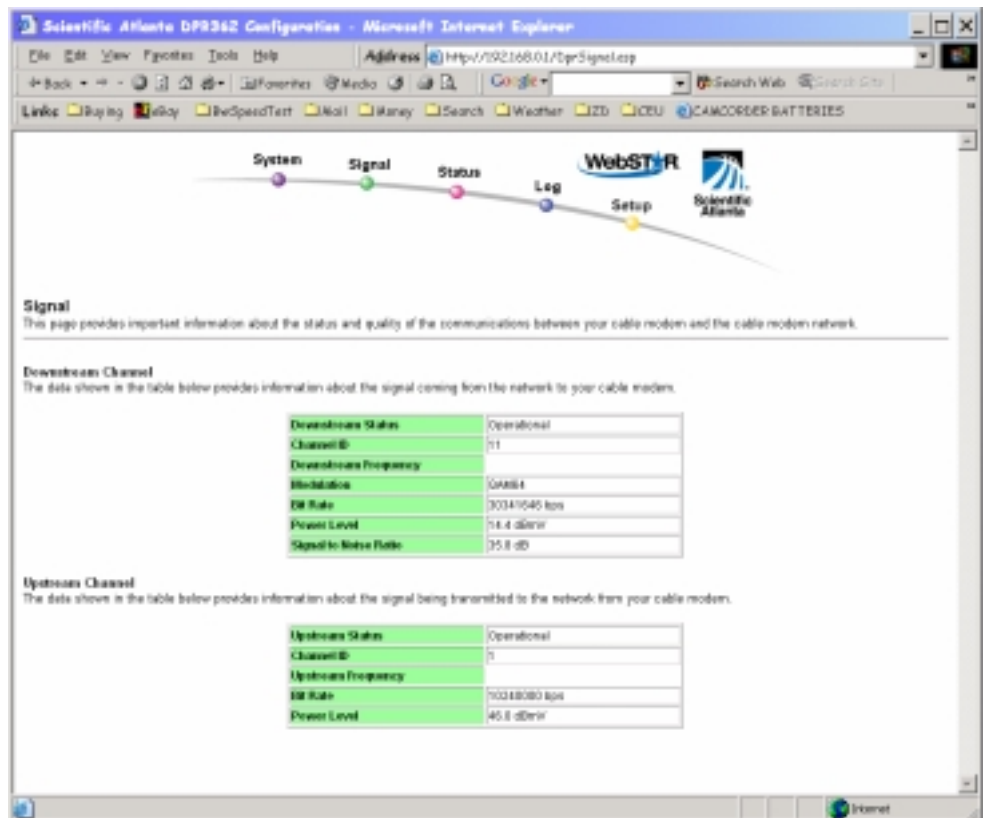

Signal Page Example

The following illustration is an example of the Signal page.



Signal Page Description

This section describes the section headings and field descriptions of the Signal page.

Field Name	Description
Downstream/ Upstream Status	Displays the current downstream/upstream status of the cable modem gateway. There are 5 possible states: <ul style="list-style-type: none"> • notSynchronized • phySynchronized • rangingComplete • registrationComplete • operational
Channel ID	Displays the downstream and upstream channel number currently being used by your cable modem
Frequency	Displays the downstream and upstream frequency currently being used by your cable modem  This frequency is not displayed because of CableHome requirements.
Bit Rate	Displays the maximum downstream and upstream data bit rate your cable modem can handle if provisioned
Downstream Power Level	Displays the actual received signal power level in dBmV
Upstream Power Level	Displays the actual transmitted signal power level in dBmV
Signal to Noise Ratio	Displays the Signal to Noise Ratio of your received signal in decibels (dB)  Any ratio over 25 dB is considered acceptable.

Accessing the Status Page

Use the Status page to view important information about the operational status of your cable modem gateway and the devices you have connected to it.

Click **Status** on the arc in the upper portion of any WebWizard page to access the Status page.

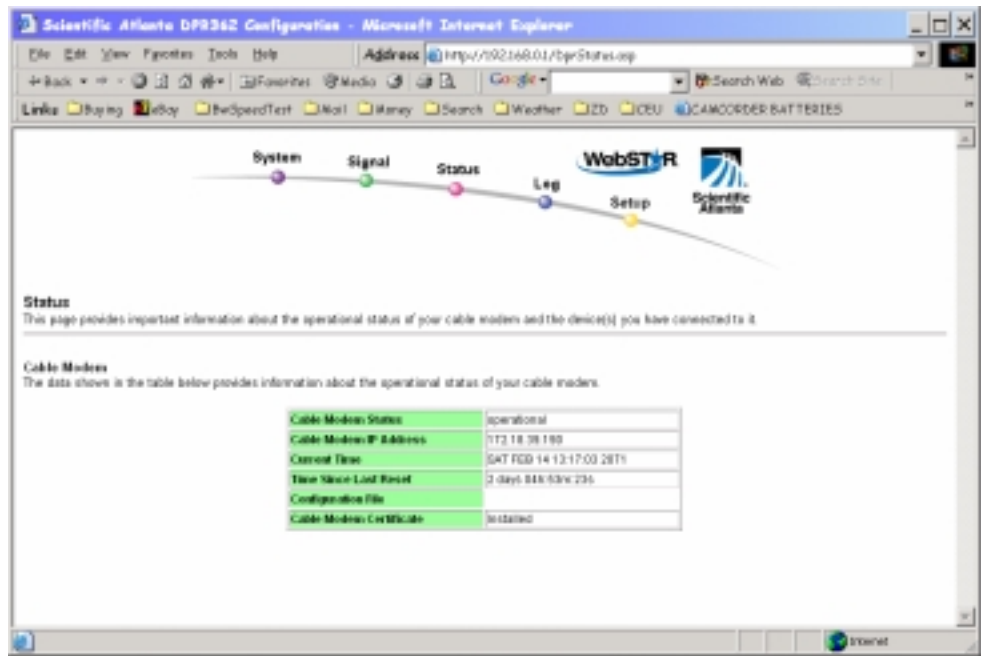

Status Page Example

The following illustration is an example of the Status page.



Status Page Description

This section describes the section headings and fields descriptions of the Status page.

Field Name	Description
Cable Modem Status	<p>Displays the current status of the cable modem gateway. There are 5 possible states:</p> <ul style="list-style-type: none"> • notSynchronized • phySynchronized • rangingComplete • registrationComplete • operational
Cable Modem IP Address	<p>Displays the IP address given to your cable modem by your Internet Service Provider(ISP)</p>
Current Time	<p>Displays the current time and date</p> <p> If your ISP is running a time of day server, then this time and date is accurate.</p>
Time Since Last Reset	<p>Displays the time since the last cable modem reset or the last time the AC power was removed and reapplied</p>
Configuration File	<p>Displays the name and revision of the last configuration file downloaded into your cable modem by your ISP</p> <p> This field is shown blank in this example because of CableHome requirements.</p>
Cable Modem Certificate	<p>Displays the installed certificate</p> <p> Each cable modem has a digitally signed certificate to allow it to function. A certificate is a file that the cable modem uses to verify and authenticate any software downloaded into the cable modem. This field shows whether the certificate is installed.</p>

Viewing Cable Modem Gateway Operational Status

Use the Log page to view important information about the operational status of your cable modem gateway that you can use to troubleshoot and resolve problems with your cable modem gateway. The Log records events as they occur.

Click **Log** on the arc in the upper portion of any WebWizard page to access the Log page. Click **Clear Log** to clear the Log.

Log Page Example

The following illustration is an example of the Log page.

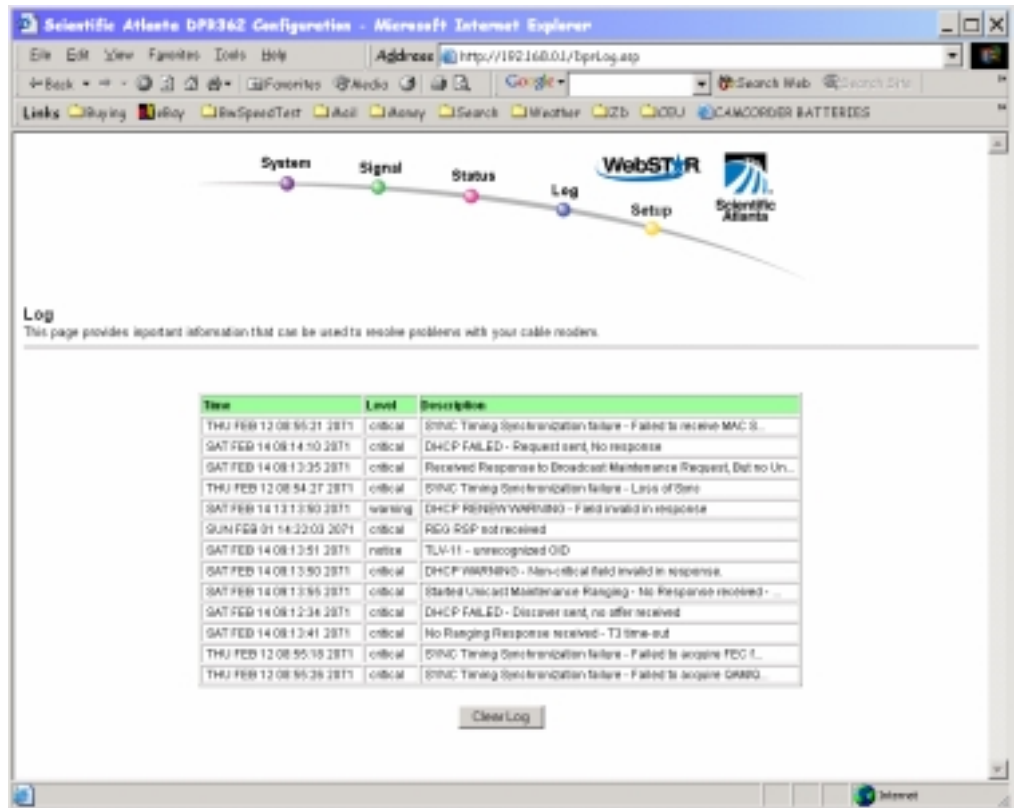

Frequently Asked Questions

Internet Installation

Q. What if I don't subscribe to cable TV?

A. If cable TV is available in your area, high-speed data service may be made available with or without subscribing to cable TV service. Contact your local cable service provider for complete information on available broadband services, including high-speed Internet access.

Q. How do I arrange for installation?

A. Professional installation from your cable service provider may be provided. Professional installation also ensures proper cable connection to the cable modem gateway and to your device(s), and ensures proper configuration of all hardware and software settings. Contact your cable service provider for more information about installation.

Q. How does the WebSTAR Cable Modem Gateway connect to my computer and other devices?

A. The cable modem gateway connects to your computer and other devices through the USB port, the 10/100BaseT Ethernet ports, an optional wireless connection, or the optional HPNA port. If your computer(s) or other devices are not equipped with the appropriate networking interfaces, contact your cable service provider. These items may often be upgraded or purchased from your local computer or office supply retailer, or from your cable service provider.

Q. Once my cable modem gateway is connected, how do I access the Internet?

A. Your local cable service provider becomes your Internet Service Provider (ISP), offering a wide range of services including e-mail, chat, news, and information services. Your cable service provider also supplies the software you will need.

Q. Can I watch TV and surf the Internet at the same time?

A. Absolutely! If you subscribe to cable television service, you can watch TV and use your cable modem gateway at the same time by connecting your TV and your cable modem gateway to the cable network using an optional cable signal splitter.

Q. How many devices can I connect to the cable modem gateway?

A. A single cable modem gateway is able to support up to 253 devices. However, under normal circumstances, the number of devices connected should be a much lower number. Contact your cable service provider for more information on the maximum number of devices to connect to the cable modem gateway in order to maintain optimal network performance.

Q. What do the front panel status indicators mean?

A. The following table illustrates the sequence of steps and the corresponding appearance of the cable modem gateway front panel status indicators during power up, calibration, and registration on the network. Use this chart to troubleshoot the power up, calibration, and registration process of your cable modem gateway. Once the cable modem gateway completes step 8 (Registration Completed), the cable modem gateway proceeds immediately to step 9, Normal Operations.

Front Panel LED Status Indicators During Initial Power Up, Calibration, and Registration										
Step →	1	2	3	4	5	6	7	8	9	10
LED	Power Up	Self Test (start)	Self Test (complete)	Downstream Scan	Downstream Lock	Ranging	Requesting IP Address	Requesting Configuration File	Registered and Operational	Normal Operation
Power	On	On	On	On	On	On	On	On	On	On
Receive	Off	Off	On	Off	Frequent Blinking	Frequent Blinking	Frequent Blinking	Frequent Blinking	Frequent Blinking	Frequent Blinking
Send	Off	Off	Off	Off	Off	Occasional Blinking	Occasional Blinking	Occasional Blinking	Occasional Blinking	Occasional Blinking
Cable	Off	Off	On	Blinking (1 blink)	Off	Off	Blinking (2 blinks at a time)	Blinking (4 blinks at a time)	On	On
Ethernet	1	On	Off if no Ethernet device is connected On if an Ethernet device is connected or Blinking when data is being transferred over that connection							
	2	On	Off if no Ethernet device is connected On if an Ethernet device is connected or Blinking when data is being transferred over that connection							
	3	On	Off if no Ethernet device is connected On if an Ethernet device is connected or Blinking when data is being transferred over that connection							
	4	On	Off if no Ethernet device is connected On if an Ethernet device is connected or Blinking when data is being transferred over that connection							
USB	Off	Off	On	Off if no Ethernet device is connected On if a USB device is connected or Blinking when data is being transferred over that connection						
HPNA	Off	Off	Off	Off if no HPNA devices are connected On if an HPNA device is connected						
Wireless	Off	Off	Off	Off if wireless is disabled On if wireless is enabled or Blinking when data is being transferred over that connection						

T10397

Wireless Networking (Optional)

Q. Why am I unable to use my wireless network devices?

A. Many factors can contribute to this situation. Verify the following configuration settings:

- Select a new channel to eliminate interference from other devices that may be nearby
- Verify that the SSIDs for the wireless network devices match
- If you selected encryption, verify that the encryption keys match

Home Phonenumber Networking (Optional)

Q. How do I arrange for installation?

A. Professional installation from your cable service provider may be provided. A professional installer can connect the HPNA port to your existing telephone wiring in your home, or install new wiring if needed. Professional installation also ensures proper cable connection to the cable modem gateway and to your home networking devices, and ensures proper configuration of all hardware and software settings. Contact your cable telephone service provider for more information about installation.

Q. Can I use my telephone, modem, fax, and answering machines with an HPNA network?

A. Yes! Standard telephones, dial up analog modems, faxes, and answering machines can be used simultaneously with HPNA because, even though they exist on the same telephone wires, they occupy different frequency bands.

Q. What is the maximum achievable distance between nodes for an HPNA network?

A. HPNA is designed to reach up to 1000 feet (300 meters) between any two adapters. If the network has more than two HPNA adapters, all of the adapters must be within 1000 feet of each other. The actual distance may be lesser or greater depending on the type of wire, noise conditions, and topology of the telephone wiring in your home.

Q. Do I automatically receive high-speed Internet service with the cable modem gateway?

A. Your cable modem gateway may be used for HPNA service, high-speed Internet service, or both services. Your cable service provider enables Internet service. Contact your cable service provider for more information if you are not currently subscribing to Internet service.

Q. Why do I hear a faint high-pitched tone on the phone line when I am using the phone?

A. Occasionally an HPNA network creates a faint high-pitched tone on the phone line. You can correct this situation by purchasing and installing a DSL filter to the phone line that goes into your telephone set.

Q. Does the phone line need to be active to create an HPNA network?

A. No! An HPNA network can be created on an inactive (no phone number) telephone line as well as an active (has a phone number) telephone line. An HPNA network can be created on spare telephone wiring or even on an available pair of a CAT-5 Ethernet cable.



The HPNA devices use the middle two conductors of the RJ-11 telephone jack.

Q. Can I surf the Internet and make telephone calls at the same time?

A. Absolutely! All HPNA devices use different frequencies. Internet surfing and other data services do not affect the quality of your telephone calls. You can make telephone calls and surf the net at the same time.

Having Difficulty?

If your cable modem gateway does not operate as expected, the following troubleshooting tips may help. If you need further assistance, contact your cable service provider.

My cable modem gateway does not register a cable connection.

- The cable modem gateway works with a standard, 75-ohm, RF coaxial cable. If you are using a different cable, your cable modem gateway will not function properly. Contact your cable service provider to determine whether you are using the correct cable.
- Verify that the plug to your cable modem gateway AC adapter is properly inserted into an electrical outlet.
- Verify that your cable modem gateway AC adapter is not plugged into an electrical outlet that is controlled by a wall switch. If a wall switch controls the electrical outlet, make sure the switch is in the **ON** position.
- Verify that the **Power** and **Cable** indicators on the front panel of your cable modem are illuminated.
- Verify that all cables are properly connected.
- Verify that your cable service is active and that it supports two-way service.
- Verify that you have called your cable service provider and given them the serial number and MAC address of your cable modem gateway.
- If you are using a cable signal splitter so that you can connect the cable modem gateway to other devices, remove the splitter and reconnect the cables so that the cable modem gateway is connected directly to the cable input. If the cable modem gateway now functions properly, the cable signal splitter may be defective and may need to be replaced.

There is no dial tone when I lift the telephone handset.

- You may be using the wrong phone cable to connect the HPNA port on the cable modem gateway to your wall telephone jack. Try a different phone cable.
- There may be a problem with your home telephone wiring. A professional may need to diagnose and repair a problem with your telephone wiring.
- There may be a problem with your telephone set. Use a different telephone set and listen to hear dial tone.

Notices

Trademarks

Scientific-Atlanta and the Scientific-Atlanta ARCs logo are registered trademarks of Scientific-Atlanta, Inc. WebSTAR and "Bringing the Interactive Experience Home" are trademarks of Scientific-Atlanta, Inc.

Other trademarks listed herein are the property of their respective owners.

Disclaimer

Scientific-Atlanta, Inc. assumes no responsibility for errors or omissions that may appear in this guide. Scientific-Atlanta reserves the right to change this guide at any time without notice.

Documentation Copyright Notice

© 2003 Scientific-Atlanta, Inc. All rights reserved.
Printed in the United States of America.

Information in this document is subject to change without notice. No part of this document may be reproduced in any form without the express written permission of Scientific-Atlanta, Inc.

Software Use Notice

The software described in this document is copyrighted and furnished to you under a license agreement. You may only use or copy this software in accordance with the terms of your license agreement.

Firmware Use Notice

The firmware in this equipment is copyrighted. You may only use the firmware in the equipment in which it is provided. Any reproduction or distribution of this firmware or any portion of it, without express written consent is prohibited.

FCC Compliance

United States FCC Compliance

This equipment has been tested and found to comply with the applicable limits of Part 15 of FCC Rules. These limits are designed to provide reasonable protection against harmful interference in a residential installation. This equipment generates, uses, and can radiate radio frequency energy and, if not installed and used in accordance with the instructions, may cause harmful interference to radio or TV reception, which can be determined by turning the equipment off and on. The user is encouraged to try to correct the interference by one or more of the following measures:

- Increase the separation between the equipment and receiver
- Connect the equipment into an outlet on a circuit different from that to which the receiver is connected
- Consult your cable company or an experienced radio/TV technician for help

Any changes or modifications not expressly approved by Scientific-Atlanta could void the user's authority to operate the equipment.

The information shown in the FCC Declaration of Conformity paragraph below is a requirement of the FCC and is intended to supply you with information regarding the FCC approval of this device. *The phone numbers listed are for FCC-related questions only and not intended for questions regarding the connection or operation for this device. Please contact your cable service provider for any questions you may have regarding the operation or installation of this device.*

FCC Declaration of Conformity

This device complies with *Part 15 of FCC Rules*. Operation is subject to the following two conditions: 1) the device may not cause harmful interference, and 2) the device must accept any interference received, including interference that may cause undesired operation.

WebSTAR Cable Modem Gateway
Model DPR362
Scientific-Atlanta, Inc.
5030 Sugarloaf Parkway
Lawrenceville, Georgia 30044 USA
Telephone: **770-236-1077**

Canada EMI Regulation

This Class B digital apparatus meets all requirements of the Canadian Interference Causing Equipment Regulations.

Cet appareil numérique de la classe B respecte toutes les exigences du Règlement sur le matériel brouilleur du Canada.

For Information

If You Need Technical Assistance

If you need technical assistance, contact your cable service provider.



Bringing the Interactive
Experience Home

Scientific-Atlanta, Inc.
770.236.5000

5030 Sugarloaf Parkway, Box 565447

Lawrenceville, GA 30042
www.scientificatlanta.com

Scientific-Atlanta and the Scientific-Atlanta logo are registered trademarks of Scientific-Atlanta, Inc.

"Bringing the Interactive Experience Home" and WebSTAR are trademarks of Scientific-Atlanta, Inc.

All other trademarks shown are trademarks of their respective owners.

Product and service availability subject to change without notice.

© 2003 Scientific-Atlanta, Inc. All rights reserved.

February 2003 Printed in USA

Part Number 4002168 Rev A