

**PCA7435FPG02
PCA7435GPG03
PCA7435SPG02**

PROM Programming Adapter for 753x and 7540 Group MCUs

User's Manual

* IC51-0362-309 and IC51-1498, AC26323, IC59-4206-G4 and IC59-3204-G4 are products of Yamaichi Electronics Co., Ltd.
* R4945 and R4945A are trademarks of Advantest Corporation.

Keep safety first in your circuit designs!

- Renesas Technology Corporation and Renesas Solutions Corporation put the maximum effort into making semiconductor products better and more reliable, but there is always the possibility that trouble may occur with them. Trouble with semiconductors may lead to personal injury, fire or property damage. Remember to give due consideration to safety when making your circuit designs, with appropriate measures such as (i) placement of substitutive, auxiliary circuits, (ii) use of nonflammable material or (iii) prevention against any malfunction or mishap.

Notes regarding these materials

- These materials are intended as a reference to assist our customers in the selection of the Renesas Technology product best suited to the customer's application; they do not convey any license under any intellectual property rights, or any other rights, belonging to Renesas Technology Corporation, Renesas Solutions Corporation or a third party.
- Renesas Technology Corporation and Renesas Solutions Corporation assume no responsibility for any damage, or infringement of any third-party's rights, originating in the use of any product data, diagrams, charts, programs, algorithms, or circuit application examples contained in these materials.
- All information contained in these materials, including product data, diagrams, charts, programs and algorithms represents information on products at the time of publication of these materials, and are subject to change by Renesas Technology Corporation and Renesas Solutions Corporation without notice due to product improvements or other reasons. It is therefore recommended that customers contact Renesas Technology Corporation, Renesas Solutions Corporation or an authorized Renesas Technology product distributor for the latest product information before purchasing a product listed herein. The information described here may contain technical inaccuracies or typographical errors. Renesas Technology Corporation and Renesas Solutions Corporation assume no responsibility for any damage, liability, or other loss rising from these inaccuracies or errors. Please also pay attention to information published by Renesas Technology Corporation and Renesas Solutions Corporation by various means, including the Renesas home page (<http://www.renesas.com>).
- When using any or all of the information contained in these materials, including product data, diagrams, charts, programs, and algorithms, please be sure to evaluate all information as a total system before making a final decision on the applicability of the information and products. Renesas Technology Corporation and Renesas Solutions Corporation assume no responsibility for any damage, liability or other loss resulting from the information contained herein.
- Renesas Technology semiconductors are not designed or manufactured for use in a device or system that is used under circumstances in which human life is potentially at stake. Please contact Renesas Technology Corporation, Renesas Solutions Corporation or an authorized Renesas Technology product distributor when considering the use of a product contained herein for any specific purposes, such as apparatus or systems for transportation, vehicular, medical, aerospace, nuclear, or undersea repeater use.
- The prior written approval of Renesas Technology Corporation and Renesas Solutions Corporation is necessary to reprint or reproduce in whole or in part these materials.
- If these products or technologies are subject to the Japanese export control restrictions, they must be exported under a license from the Japanese government and cannot be imported into a country other than the approved destination. Any diversion or reexport contrary to the export control laws and regulations of Japan and/or the country of destination is prohibited.
- Please contact Renesas Technology Corporation or Renesas Solutions Corporation for further details on these materials or the products contained therein.

Precautions to be taken when using this product

- This product is a development supporting unit for use in your program development and evaluation stages. In mass-producing your program you have finished developing, be sure to make a judgment on your own risk that it can be put to practical use by performing integration test, evaluation, or some experiment else.
- In no event shall Renesas Solutions Corporation be liable for any consequence arising from the use of this product.
- Renesas Solutions Corporation strives to renovate or provide a workaround for product malfunction at some charge or without charge. However, this does not necessarily mean that Renesas Solutions Corporation guarantees the renovation or the provision under any circumstances.
- This product has been developed by assuming its use for program development and evaluation in laboratories. Therefore, it does not fall under the application of Electrical Appliance and Material Safety Law and protection against electromagnetic interference when used in Japan.

Renesas Tools Homepage <http://www.renesas.com/en/tools>

Contents

Chapter 1. Precautions for Safety	4
1.1 Safety Symbols and Meanings	4
Chapter 2. Introduction	6
2.1 Things to Check When Unpacking	7
Chapter 3. Specifications	8
Chapter 4. How to Write the Program	9
4.1 Programming Procedure	9
4.2 Attaching the Adapter to a PROM Programmer	10
4.3 Setting the Switch	11
4.4 Mounting an MCU into the Adapter	12
4.4.1 For PCA7435FPG02/PCA7435GPG03	12
4.4.2 For PCA7435SPG02	12
4.5 Precautions When Handling the Adapter	13
4.6 Setting the Programming Area	13
Chapter 5. Recommended PROM Programmers	13
Chapter 6. Memory Maps	14
Chapter 7. Troubleshooting	15
7.1 Errors That Occur When Writing to PROM	15
7.1.1 When Newly Purchased	15
7.1.2 Previously Written Normally	15
7.2 MCUs Do Not Function Normally	16
7.3 Other Precautions	16
7.3.1 About the Recommended PROM Programmers	16
7.3.2 About Reading Out of Device Identification Code	16
7.4 How to Request for Support	16

To use the product properly

Precautions for Safety:





- Both in this User's Manual and on the product itself, several icons are used to insure proper handling of this product and also to prevent injuries to you or other persons, or damage to your properties.
- The icons' graphic images and meanings are given in "Chapter 1. Precautions for Safety" (page 4). Be sure to read this chapter before using the product.

Chapter 1. Precautions for Safety

In both the User's Manual and on the product itself, several icons are used to insure proper handling of this product and also to prevent injuries to you or other persons, or damage to your properties.

This chapter describes the precautions which should be taken in order to use this product safely and properly. Be sure to read this chapter before using this product.

1.1 Safety Symbols and Meanings

	WARNING	If the requirements shown in the "WARNING" sentences are ignored, the equipment may cause serious personal injury or death.
	CAUTION	If the requirements shown in the "CAUTION" sentences are ignored, the equipment may malfunction.
	IMPORTANT	It means important information on using this product.

In addition to the three above, the following are also used as appropriate.

△ means WARNING or CAUTION.
Example:  **CAUTION AGAINST AN ELECTRIC SHOCK**

⊘ means PROHIBITION.
Example:  **DISASSEMBLY PROHIBITED**

● means A FORCIBLE ACTION.
Example:  **UNPLUG THE POWER CABLE FROM THE RECEPTACLE.**

The following page describes the symbols "WARNING", "CAUTION", and "IMPORTANT".

WARNING

Warnings for Use Environment:

- This equipment is to be used in an environment with a maximum ambient temperature of 35°C. Care should be taken that this temperature is not exceeded.
- Select the proper programming mode of the PROM programmer.

CAUTION

Cautions to Be Taken for This Product:



- Do not disassemble or modify this product. Disassembling or modifying this product can cause damage. Disassembling and modifying the product will void your warranty.
- Use caution when handling this product. Be careful not to apply a mechanical shock such as falling.
- Do not touch the connector pins of this product.
- Be careful with the static electricity when handling this product and the MCU.

Caution for Keeping This Product:

- When not using this product for a long time:
 - (1) Attach the connector pins of this product to the conductive sponge.
 - (2) Put it into a conductive polyvinyl, and keep it in the package case shipped from the factory.
 - (3) Store it in the place where humidity and temperature are low and direct sunshine does not strike.

IMPORTANT

When Using The Product:

- Attach this product to the IC socket on the PROM programmer properly.
- Mount the MCU to the IC socket of this product properly.
- Be sure to set the programming area according to your PROM programmer.
- Do not use the PROM programmer's device identification code readout function.

Chapter 2. Introduction

This product is a PROM programming adapter for 753x and 7540 Group of 740 Family MCUs (8-bit MCU). This product is used to write programs into the internal EPROM of MCU with commercially available PROM programmer.

This manual mainly explains specifications of this product and how to operate it.

Figures 2.1 and 2.2 show the external views of the products and their constituent parts.

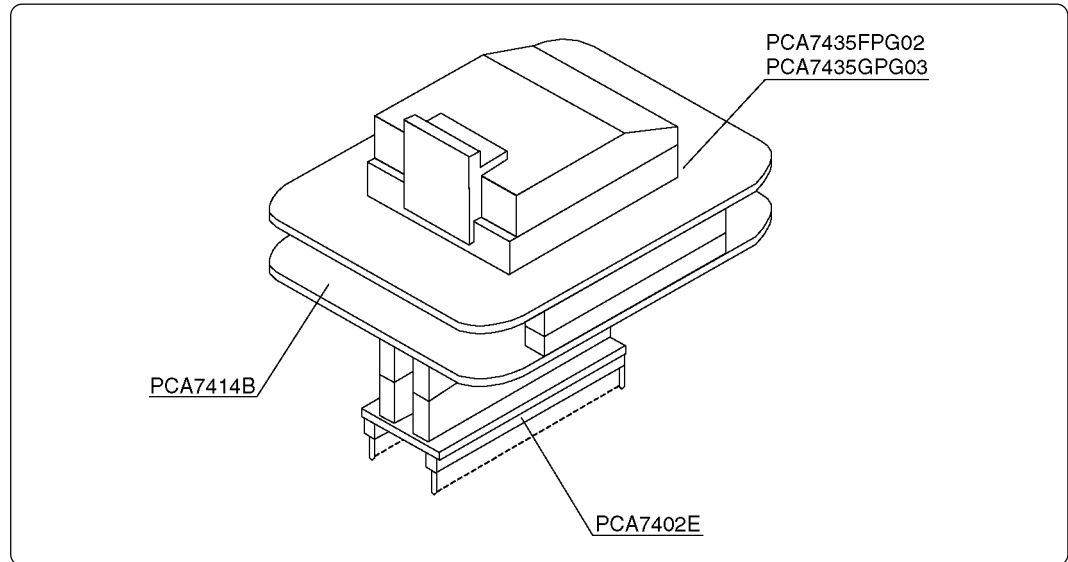

Figure 2.1 External view of the and its constituent parts (PCA7435FPG02/PCA7435GPG03)

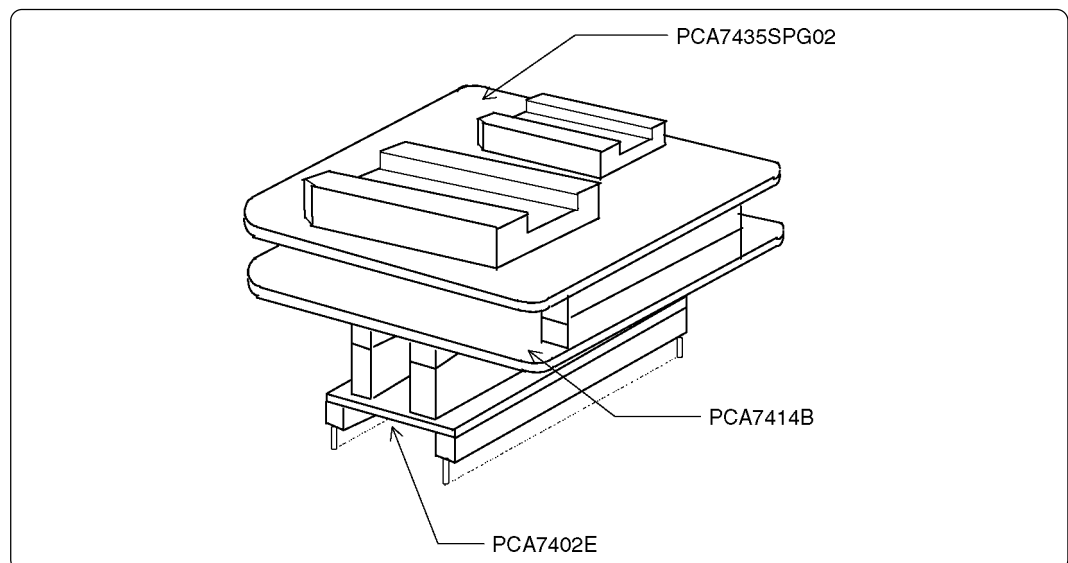

Figure 2.2 External view of the and its constituent parts (PCA7435SPG02)

2.1 Things to Check When Unpacking

This product consists of the following parts listed in Table 2.1. When unpacking, check to see that it contains all of the components shown in Table 2.1 below.

Table 2.1 Package components

Main unit	PCA7435FPG02	PCA7435GPG03	PCA7435SPG02
Interface unit	PCA7414B		
Connector	PCA7402E (32-pin)		
User's manual	This manual		

If any part is missing or there is any doubt about your product package, contact your local distributor.

Chapter 3. Specifications

Tables 3.1 and 3.2 list the specifications of the programming adapters.

Table 3.1 Common specifications of the programming adapters

Operating clock frequency		4 MHz (Supplied by the ceramic oscillator mounted on the adapter)
Power supply		Supplied from Vcc of the PROM programmer
Board configuration	PCA7435FPG02/ PCA7435GPG03/ PCA7435SPG02	Board to insert a programmable MCU (IC socket mounted on it)
	PCA7414B	Interface board (Connected by two rows of standard-pitch 18-pin connectors and two rows of standard-pitch 16-pin connectors to the upper and lower boards)
	PCA7402E	Board to connect to the PROM programmer (Standard-pitch 32-pin pin-header mounted)

Table 3.2 Specifications of each programming adapter

PCA7435FPG02	Applicable MCU	753x Group OTP version 0.8-mm-pitch 36-pin SSOP (36P2R-A package)	M37531E4/E8FP M37532E8FP M37534E8FP
		7540 Group OTP version 0.8-mm-pitch 36-pin SSOP (36P2R-A package)	M37540E2/E8FP
	IC socket	IC51-0362-309 (made by Yamaichi Electronics Co., Ltd.)	
PCA7435GPG03	Applicable MCU	7531 Group OTP version 0.8-mm-pitch 32-pin LQFP (36P6B-A, 32P6U-A package)	M37531E4GP
		7540 Group OTP version 0.8-mm-pitch 32-pin LQFP (32P6B-A, 32P6U-A package)	M37540E2/E8GP
	IC socket	IC51-1498, AC26323 (made by Yamaichi Electronics Co., Ltd.)	
PCA7435SPG02	Applicable MCU	7531 Group OTP version 1.778-mm-pitch 32-pin SDIP (32P4B package)	M37531E4/E8SP
		7540 Group OTP version 1.778-mm-pitch 32-pin SDIP (32P4B package)	M37540E2/E8SP
	IC socket	IC59-3204-G4 (made by Yamaichi Electronics Co., Ltd.)	
	Applicable MCU	7536 Group OTP version 1.778-mm-pitch 42-pin SDIP (42P4B package)	M37536E8SP
	IC socket	IC51-4206-G4 (made by Yamaichi Electronics Co., Ltd.)	

Chapter 4. How to Write the Program

This chapter describes procedures you need to follow when writing the program. For details on how to operate the PROM programmer, refer to the user's manual of the PROM programmer.

4.1 Programming Procedure

Follow these procedures (1) through (8) to write the program into the MCU.

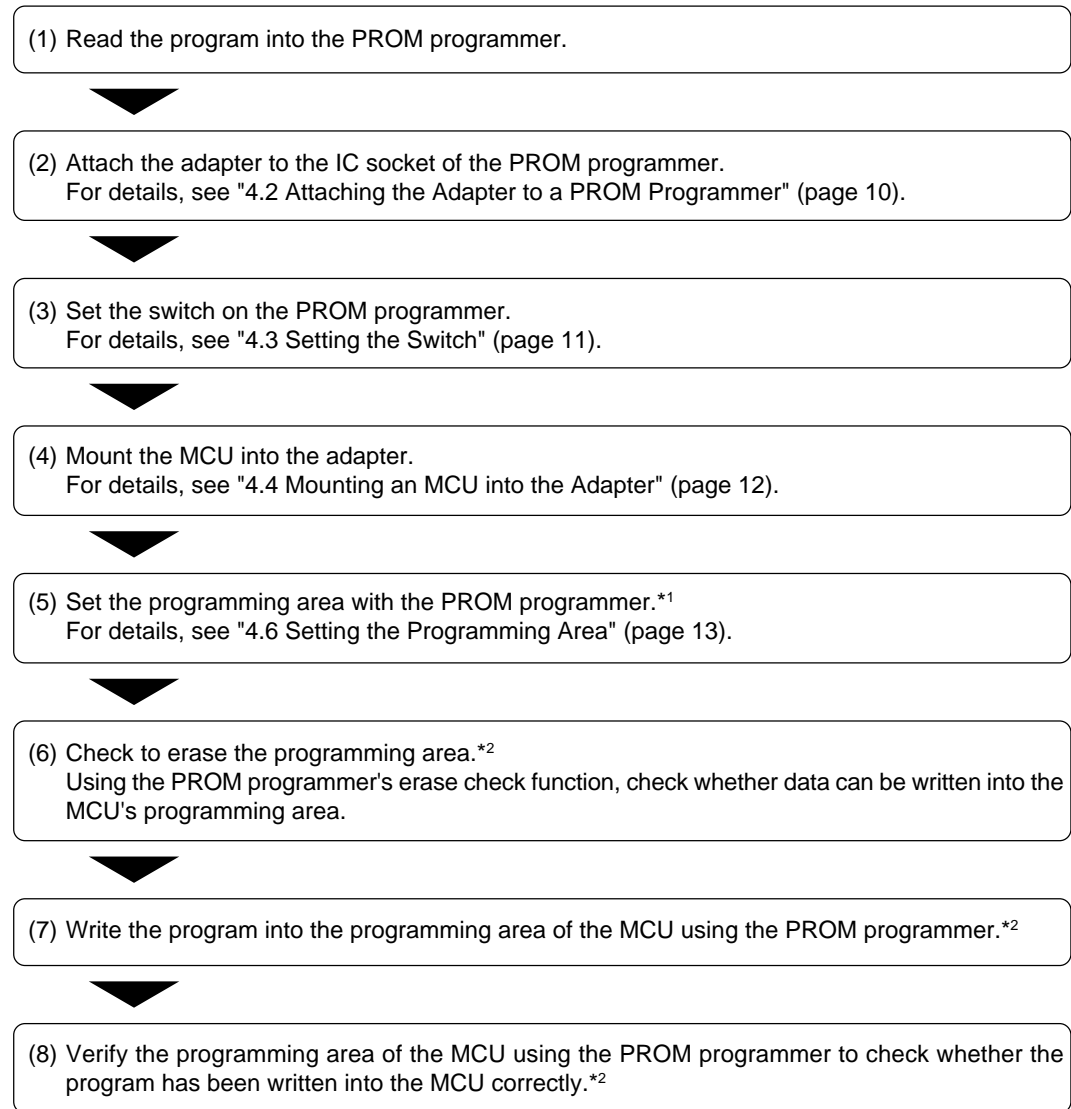

Notes

*1 Be sure to set the programming area. Otherwise the mode's shift to the programming mode may not be performed successfully. The erase check function and others may not also be performed completely.

*2 Some PROM programmers perform the steps (6) to (8) automatically.

4.2 Attaching the Adapter to a PROM Programmer

As shown in Figures 4.1 and 4.2, attach the pin No. 1 of the PCA7402E connector (standard-pitch 32-pin pin-header mounted) to the pin No. 1 of the IC socket of the PROM programmer.

Be careful when attaching the adapter because incorrect insertion can cause fatal damage to the MCU.

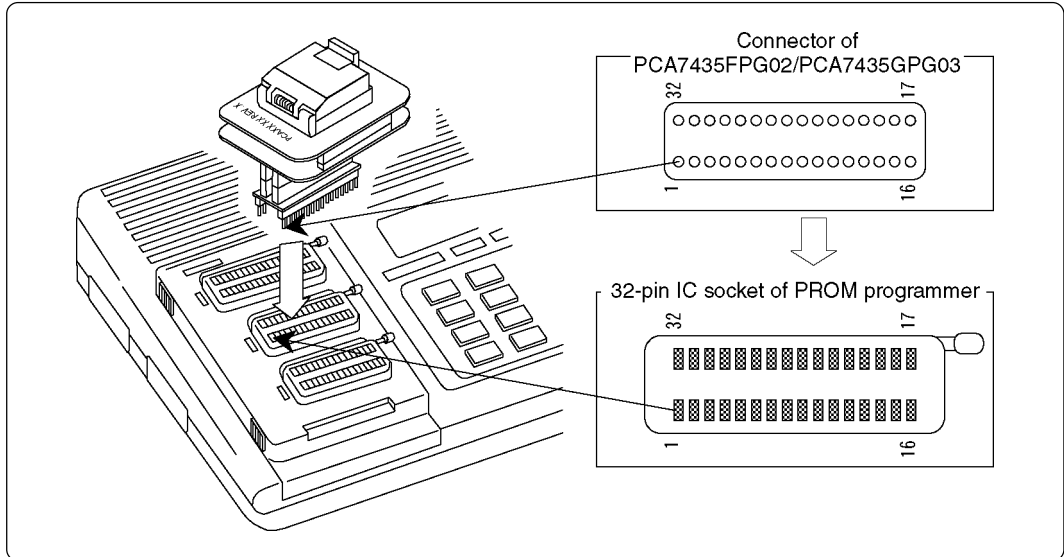

Figure 4.1 Attaching the adapter to a PROM programmer (PCA7435FPG02/PCA7435GPG03)

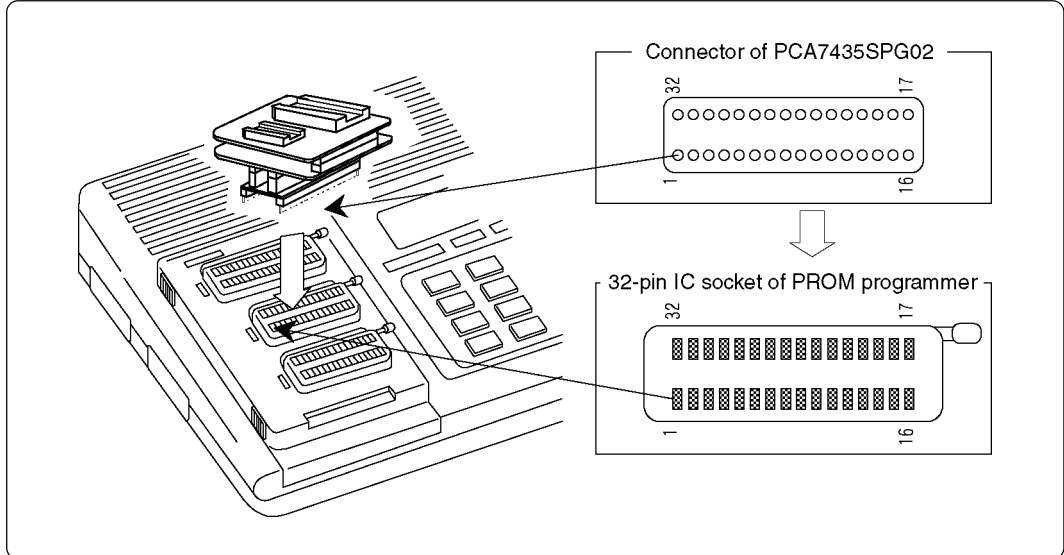



Figure 4.2 Attaching the adapter to a PROM programmer (PCA7435SPG02)

4.3 Setting the Switch

According to your MCU, set the SW1 as shown in Table 4.1.

Table 4.1 Setting the switch

MCU	Setting
753x Group	7531/7532 or 7531/7536  7540
7540 Group	7531/7532 or 7531/7536  7540

When the switch is not set properly, the program will not be read out or written in normally.

4.4 Mounting an MCU into the Adapter

Be careful when inserting the MCU because incorrect insertion can cause fatal damage to the MCU.

4.4.1 For PCA7435FPG02/PCA7435GPG03

As shown in Figure 4.3, mount the MCU into the IC socket with the No. 1 pin of the MCU matched to the No. 1 pin of the IC socket on the PCA7435FPG02 or PCA7435GPG03.

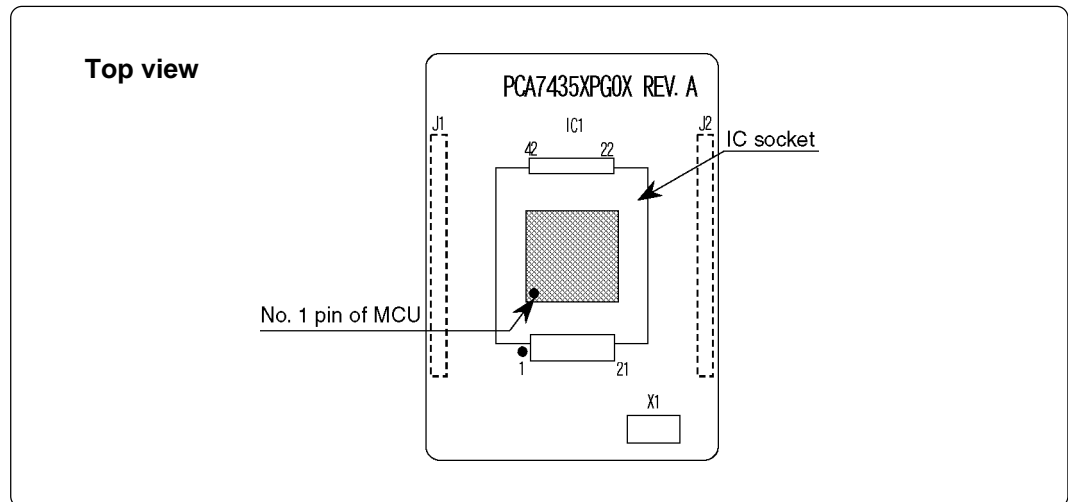

Figure 4.3 Mounting an MCU (PCA7435FPG02/PCA7435GPG03)

4.4.2 For PCA7435SPG02

As shown in Figure 4.4, mount the MCU into the IC socket with the No. 1 pin of the MCU matched to the No. 1 pin of the IC socket on the PCA7435SPG02.

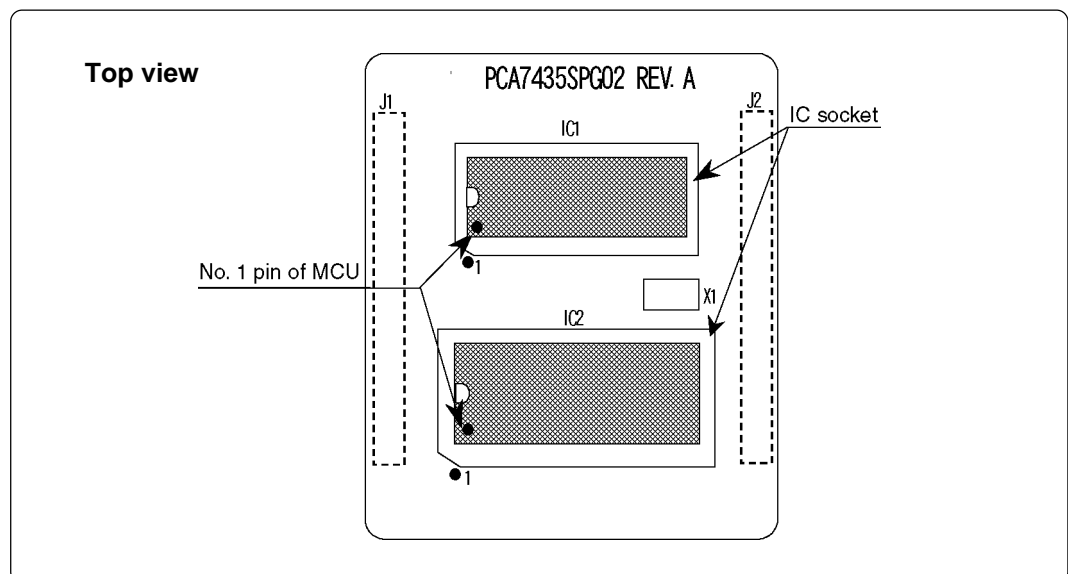

Figure 4.4 Mounting an MCU (PCA7435SPG02)

On the PCA7435SPG02 two MCUs cannot be written into at the same time.

4.5 Precautions When Handling the Adapter

Do not touch the connector in the IC socket and the pins on the PROM programmer connector because dirt may cause an electrical insulation failure.

When not using this product, attach the connector pins of this product to the conductive sponge as it was shipped from the factory.

4.6 Setting the Programming Area

When writing programs, be sure to set the programming area and device according to the ROM size of your MCU. Tables 4.2 and 4.3 list the programming area for 753x Group and 7540 Group, respectively.

Table 4.2 Programming area (753x Group)

MCU		ROM size	Setting of PROM programmer		ROM area of MCU
MCU type name	Example		Device	Programming area	
M3753xE2	Not available	4 KB	M5M27C101	F080 ₁₆ - FFFD ₁₆	F080 ₁₆ - FFFD ₁₆
M3753xE3		6 KB		E880 ₁₆ - FFFD ₁₆	E880 ₁₆ - FFFD ₁₆
M3753xE4	M37531E4	8 KB		E080 ₁₆ - FFFD ₁₆	E080 ₁₆ - FFFD ₁₆
M3753xE5	Not available	10 KB		D880 ₁₆ - FFFD ₁₆	D880 ₁₆ - FFFD ₁₆
M3753xE6		12 KB		D080 ₁₆ - FFFD ₁₆	D080 ₁₆ - FFFD ₁₆
M3753xE7		14 KB		C880 ₁₆ - FFFD ₁₆	C880 ₁₆ - FFFD ₁₆
M3753xE8	M37531E8 M37532E8 M37534E8 M37536E8	16 KB		C080 ₁₆ - FFFD ₁₆	C080 ₁₆ - FFFD ₁₆

Table 4.3 Programming area (7540 Group)

MCU		ROM size	Setting of PROM programmer		ROM area of MCU
MCU type name	Example		Device	Programming area	
M37540E2	M37540E2	8 KB	M5M27C101	E080 ₁₆ - FFFD ₁₆	E080 ₁₆ - FFFD ₁₆
M37540E3	Not available	12 KB		D080 ₁₆ - FFFD ₁₆	D080 ₁₆ - FFFD ₁₆
M37540E4		16 KB		C080 ₁₆ - FFFD ₁₆	C080 ₁₆ - FFFD ₁₆
M37540E5		20 KB		B080 ₁₆ - FFFD ₁₆	B080 ₁₆ - FFFD ₁₆
M37540E6		24 KB		A080 ₁₆ - FFFD ₁₆	A080 ₁₆ - FFFD ₁₆
M37540E7		28 KB		9080 ₁₆ - FFFD ₁₆	9080 ₁₆ - FFFD ₁₆
M37540E8	M37540E8	32 KB		8080 ₁₆ - FFFD ₁₆	8080 ₁₆ - FFFD ₁₆

Chapter 5. Recommended PROM Programmers

The PROM programmers listed in Table 5.1 are recommended for the adapter. Using the actual products, we have verified that these PROM programmers can be used to write programs without problem. Nonconformity occurring by using any other PROM programmers can not be supported. For the latest type of PROM programmers, contact the manufacturer to confirm whether it can be used for your product.

Table 5.1 Recommended PROM programmers

Manufacturer	Type name	Device	Programming voltage (V _{PP})
Advantest Corporation	R4945	M5M27C101 mode	12.5 V
	R4945A		

Chapter 6. Memory Maps

Figure 6.1 shows memory maps of the MCU and the PROM programmer.

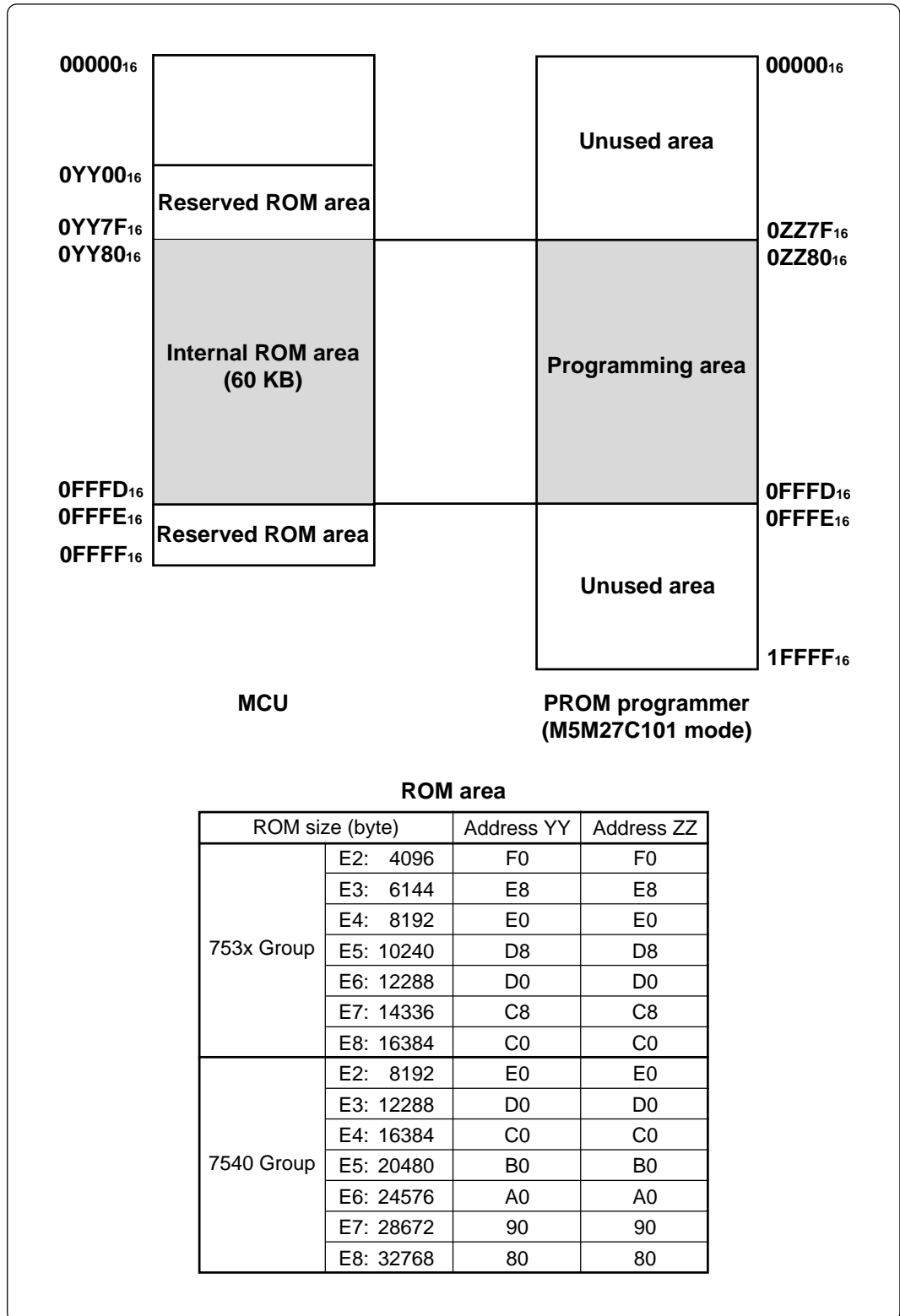

Figure 6.1 Memory maps (753x and 7540 Groups)

Chapter 7. Troubleshooting

The tables below summarize errors to be checked carefully before you determine them to be a fault.

7.1 Errors That Occur When Writing to PROM

7.1.1 When Newly Purchased

Cause	Remedy	See page
Programming adapter	Is the adapter attached to the correct position of the PROM programmer?	10
	Is the MCU attached to the correct position?	12
PROM programmer	Is the area specification set correctly?	13
	Is the correct device selected?	13
Contact failure	The IC socket of the PROM programmer may be stained. The socket needs replacing.	-

7.1.2 Previously Written Normally

Cause	Remedy	See page
Programming adapter	Is the adapter attached to the correct position of the PROM programmer?	10
	Is the MCU attached to the correct position?	12
PROM programmer	Is the area specification set correctly?	13
	Is the correct device selected?	13
Contact failure	The IC socket of the PROM programmer may be stained. The socket needs replacing.	-
	The PROM programmer connector at which the PROM programmer is contacted may be stained. Clean it with alcohol, etc.	-

7.2 MCUs Do Not Function Normally

The program operates normally on the emulator, but when the MCU that has normally been written is attached the same program does not function normally.

- (1) Is the offset address specified correctly when copying data into the PROM programmer?
- (2) In the emulator, NOPs are often inserted in the area where the program has not been read, therefore the program happens to appear functioning normally even though it may have gone wild. Check your program again.
- (3) The emulator and the actual MCU may differ in characteristics. Consult the user's manual of the emulation pod to check for differences in characteristics again.

7.3 Other Precautions

7.3.1 About the Recommended PROM Programmers

Not all PROM programmers available on the market can be checked to see if they function properly. There are several PROM programmers that we have verified to function properly. These products are listed as recommended PROM programmers in this user's manual. Other PROM programmers may also be used providing that you verified them to function properly.

Note: No matter which type of PROM programmer you use, it is necessary to verify completion of programming by executing screening, etc. that are stipulated for each MCU used.

7.3.2 About Reading Out of Device Identification Code *1

Please do not use the PROM programmer's device identification code readout function.

Using this function may break down the MCU. The device identification code is included in EPROM to indicate the manufacturer code and device code; it is not included in the MCU.

*1 Depending on PROM programmer manufacturers, this may be referred to by another name (e.g. ID code).

7.4 How to Request for Support

After checking this manual, fill in the following information and email to your local distributor.

For prompt response, please specify the following information:

(1) Contact address

- Company name
- Department
- Responsible person
- Phone number
- Fax number
- E-mail address

(2) Product information

- Name of the programming adapter
- Serial number
- Date of purchase
- Target MCU
- Symptoms (Fails blank check/Cannot write a program/Fails verification etc.)
- Detailed symptoms
- How often does the problem occur? (2 out of 10 etc.)
- When did the problem start to occur? (Since purchase/Used to work correctly)
- Type name of the PROM programmer (Advantest R4945A etc.)
- Specified device when writing to PROM (M27C101 etc.)
- Specified programming area when writing to PROM
- Switch settings of the adapter when writing to PROM

PCA7435FPG02/PCA7435GPG03/PCA7435SPG02 User's Manual

Rev.1.00
September 1, 2003
REJ10J0250-0100Z

COPYRIGHT ©2003 RENESAS TECHNOLOGY CORPORATION
AND RENESAS SOLUTIONS CORPORATION ALL RIGHTS RESERVED



RenesasTechnology Corp.

2-6-2, Ote-machi, Chiyoda-ku, Tokyo, 100-0004, Japan