

M306H7T3-RPD-E

User's Manual

Emulation Pod for M16C/6H Group M306H7

User's Manual

Rev.1.00
Sep. 01, 2005

Renesas Technology
www.renesas.com

Keep safety first in your circuit designs!

1. Renesas Technology Corp. puts the maximum effort into making semiconductor products better and more reliable, but there is always the possibility that trouble may occur with them. Trouble with semiconductors may lead to personal injury, fire or property damage. Remember to give due consideration to safety when making your circuit designs, with appropriate measures such as (i) placement of substitutive, auxiliary circuits, (ii) use of non-flammable material or (iii) prevention against any malfunction or mishap.

Notes regarding these materials

1. These materials are intended as a reference to assist our customers in the selection of the Renesas Technology Corp. product best suited to the customer's application; they do not convey any license under any intellectual property rights, or any other rights, belonging to Renesas Technology Corp. or a third party.
2. Renesas Technology Corp. assumes no responsibility for any damage, or infringement of any third-party's rights, originating in the use of any product data, diagrams, charts, programs, algorithms, or circuit application examples contained in these materials.
3. All information contained in these materials, including product data, diagrams, charts, programs and algorithms represents information on products at the time of publication of these materials, and are subject to change by Renesas Technology Corp. without notice due to product improvements or other reasons. It is therefore recommended that customers contact Renesas Technology Corp. or an authorized Renesas Technology Corp. product distributor for the latest product information before purchasing a product listed herein.
The information described here may contain technical inaccuracies or typographical errors. Renesas Technology Corp. assumes no responsibility for any damage, liability, or other loss rising from these inaccuracies or errors.
Please also pay attention to information published by Renesas Technology Corp. by various means, including the Renesas Technology Corp. Semiconductor home page (<http://www.renesas.com>).
4. When using any or all of the information contained in these materials, including product data, diagrams, charts, programs, and algorithms, please be sure to evaluate all information as a total system before making a final decision on the applicability of the information and products. Renesas Technology Corp. assumes no responsibility for any damage, liability or other loss resulting from the information contained herein.
5. Renesas Technology Corp. semiconductors are not designed or manufactured for use in a device or system that is used under circumstances in which human life is potentially at stake. Please contact Renesas Technology Corp. or an authorized Renesas Technology Corp. product distributor when considering the use of a product contained herein for any specific purposes, such as apparatus or systems for transportation, vehicular, medical, aerospace, nuclear, or undersea repeater use.
6. The prior written approval of Renesas Technology Corp. is necessary to reprint or reproduce in whole or in part these materials.
7. If these products or technologies are subject to the Japanese export control restrictions, they must be exported under a license from the Japanese government and cannot be imported into a country other than the approved destination.
Any diversion or reexport contrary to the export control laws and regulations of Japan and/ or the country of destination is prohibited.
8. Please contact Renesas Technology Corp. for further details on these materials or the products contained therein.

Preface

The M306H7T3-RPD-E is an emulation pod for the M16C/6H Group M306H7 of 16-bit MCUs. It is used with a PC4701 emulator (excluding the PC4700L and PC4701L).

This user's manual mainly describes specifications of the M306H7T3-RPD-E emulation pod and how to setup it. For details on the emulator main unit and emulator debugger, which are used with the M306H7T3-RPD-E, refer to each product's user's manual or online manual.

All the components of this product are shown in "1.1 Package components" (page 13). If there is any question or doubt about this product, contact your local distributor.

The related manuals for using this product are listed below. You can download the latest manuals from the Renesas Tools homepage (<http://www.renesas.com/en/tools>).

Related manuals

Item	Manual
Emulator main unit	PC4701U User's Manual
	PC4701M User's Manual
	PC4701HS User's Manual
Integrated development environment	High-performance Embedded Workshop User's Manual
Emulator debugger	M16C PC4701 Emulator Debugger User's Manual
	M3T-PD30 User's Manual
C compiler	C compiler package for R8C/Tiny, M16C/60, 30, 20, 10 and Tiny Series C Compiler User's Manual
Assembler	C compiler package for R8C/Tiny, M16C/60, 30, 20, 10 and Tiny Series Assembler User's Manual

Important

Before using this product, be sure to read this user's manual carefully.

Keep this user's manual, and refer to this when you have questions about this product.

Emulator:

The emulator in this document refers to the following products that are manufactured by Renesas Technology Corp.:

- (1) PC4701 main unit
- (2) Emulation pod
- (3) Package converter board for connecting the user system

The emulator herein does not include the customer's user system and host machine.

Purpose of use of the emulator:

This emulator is a device to support the development of a system that uses the M16C Family M16C/60 Series M16C/6H Group/M306H7 of Renesas 16bit single-chip MCUs. It provides support for system development in both software and hardware.

Be sure to use this emulator correctly according to said purpose of use. Please avoid using this emulator for other than its intended purpose of use.

For those who use this emulator:

This emulator can only be used by those who have carefully read the user's manual and know how to use it.

Use of this emulator requires the basic knowledge of electric circuits, logical circuits, and MCUs.

When using the emulator:

- (1) This product is a development supporting unit for use in your program development and evaluation stages. In mass-producing your program you have finished developing, be sure to make a judgment on your own risk that it can be put to practical use by performing integration test, evaluation, or some experiment else.
- (2) In no event shall Renesas Solutions Corp. be liable for any consequence arising from the use of this product.
- (3) Renesas Solutions Corp. strives to renovate or provide a workaround for product malfunction at some charge or without charge. However, this does not necessarily mean that Renesas Solutions Corp. guarantees the renovation or the provision under any circumstances.
- (4) This product has been developed by assuming its use for program development and evaluation in laboratories. Therefore, it does not fall under the application of Electrical Appliance and Material Safety Law and protection against electromagnetic interference when used in Japan.
- (5) Renesas Solutions Corp. cannot predict all possible situations or possible cases of misuse where a potential danger exists. Therefore, the warnings written in this user's manual and the warning labels attached to this emulator do not necessarily cover all of such possible situations or cases. Please be sure to use this emulator correctly and safely on your own responsibility.
- (6) This product is not qualified under UL or other safety standards and IEC or other industry standards. This fact must be taken into account when taking this product from Japan to some other country.

Usage restrictions:

This emulator has been developed as a means of supporting system development by users. Therefore, do not use it as a device used for equipment-embedded applications. Also, do not use it for developing the systems or equipment used for the following purposes either:

- (1) Transportation and vehicular
- (2) Medical (equipment where human life is concerned)
- (3) Aerospace
- (4) Nuclear power control
- (5) Undersea repeater

If you are considering the use of this emulator for one of the above purposes, please be sure to consult your local distributor.

About product changes:

We are constantly making efforts to improve the design and performance of this emulator. Therefore, the specification or design of this emulator or its user's manual may be changed without prior notice.

About the rights:

- (1) We assume no responsibility for any damage or infringement on patent rights or any other rights arising from the use of any information, products or circuits presented in this user's manual.
- (2) The information or data in this user's manual does not implicitly or otherwise grant a license for patent rights or any other rights belonging to us or third parties.
- (3) This user's manual and this emulator are copyrighted, with all rights reserved by us. This user's manual may not be copied, duplicated or reproduced, in whole or part, without prior written consent of us.

About diagrams:

The diagrams in this user's manual may not all represent exactly the actual object.

Precautions for Safety

Definitions of Signal Words

In both the user's manual and on the product itself, several icons are used to insure proper handling of this product and also to prevent injuries to you or other persons, or damage to your properties.

This chapter describes the precautions which should be taken in order to use this product safely and properly. Be sure to read this chapter before using this product.



This symbol represents a warning about safety. It is used to arouse caution about a potential danger that will possibly inflict an injury on persons. To avoid a possible injury or death, please be sure to observe the safety message that follows this symbol.



DANGER indicates an imminently dangerous situation that will cause death or heavy wound unless it is avoided. However, there are no instances of such danger for the product presented in this user's manual.



WARNING indicates a potentially dangerous situation that will cause death or heavy wound unless it is avoided.



CAUTION indicates a potentially dangerous situation that will cause a slight injury or a medium-degree injury unless it is avoided.

CAUTION

CAUTION with no safety warning symbols attached indicates a potentially dangerous situation that will cause property damage unless it is avoided.

IMPORTANT

This is used in operation procedures or explanatory descriptions to convey exceptional conditions or cautions to the user.

In addition to the five above, the following are also used as appropriate.

△ means WARNING or CAUTION.

Example:



CAUTION AGAINST AN ELECTRIC SHOCK

⊘ means PROHIBITION.

Example:



DISASSEMBLY PROHIBITED

● means A FORCIBLE ACTION.

Example:



UNPLUG THE POWER CABLE FROM THE RECEPTACLE.

⚠ WARNING

Warnings for AC Power Supply:



- If the attached AC power cable does not fit the receptacle, do not alter the AC power cable and do not plug it forcibly. Failure to comply may cause electric shock and/or fire.
- Use an AC power cable which complies with the safety standard of the country.
- Do not touch the plug of the AC power cable when your hands are wet. This may cause electric shock.
- This product is connected signal ground with frame ground. If your developing product is transformless (not having isolation transformer of AC power), this may cause electric shock. Also, this may give an unreparable damage to this product and your developing one.
While developing, connect AC power of the product to commercial power through isolation transformer in order to avoid these dangers.
- If other equipment is connected to the same branch circuit, care should be taken not to overload the circuit.



- When installing this equipment, insure that a reliable ground connection is maintained.



- If you smell a strange odor, hear an unusual sound, or see smoke coming from this product, then disconnect power immediately by unplugging the AC power cable from the outlet.
Do not use this as it is because of the danger of electric shock and/or fire. In this case, contact your local distributor.
- Before setting up this emulator and connecting it to other devices, turn off power or remove a power cable to prevent injury or product damage.

Warnings to Be Taken for This Product:



- Do not disassemble or modify this product. Personal injury due to electric shock may occur if this product is disassembled and modified. Disassembling and modifying the product will void your warranty.
- Make sure nothing falls into the cooling fan on the top panel, especially liquids, metal objects, or anything combustible.

Warning for Installation:



- Do not set this product in water or areas of high humidity. Make sure that the product does not get wet. Spilling water or some other liquid into the product may cause unreparable damage.

Warning for Use Environment:



- This equipment is to be used in an environment with a maximum ambient temperature of 35°C. Care should be taken that this temperature is not exceeded.

 **CAUTION****Cautions to Be Taken for Turning On the Power:**

- Turn ON the power of the emulator and user system as simultaneously as possible. Turn OFF the power of the emulator and user system as simultaneously as possible.
- Do not leave either the emulator or user system powered on, because of leakage current the internal circuits may be damaged.
- When turning ON the power again after shutting OFF the power, wait about 10 seconds.

Cautions to Be Taken for Handling This Product:

- Use caution when handling the main unit. Be careful not to apply a mechanical shock.
- Do not touch the connector pins of the emulator main unit and the target MCU connector pins. Static electricity may damage the internal circuits.
- Do not pull this emulator by the communications interface cable or the flexible cable for connecting the user system. And, excessive flexing or force may break conductors.
- Do not flex the flexible cable (FLX120-RPD) for connecting to the emulator main unit and the flexible cable (M3T-FLX160C) for connecting the user system excessively. The cable may cause a break.
- Do not use inch-size screws for this equipment. The screws used in this equipment are all ISO (metric-size) type screws. When replacing screws, use same type screws as equipped before.

Caution to Be Taken for System Malfunctions:

- If the emulator malfunctions because of interference like external noise, do the following to remedy the trouble.
 - (1) Press the RESET switch on the emulator front panel.
 - (2) If normal operation is not restored after step (1), shut OFF power to the emulator once and then reactivate it.

Caution to Be Taken for External Trace Input Voltage:

- Assure that the external trace input voltage of emulator main body does not exceed the TTL level (5.0 V). Otherwise, internal circuit may be damaged because of overload.

Contents

	Page
Preface.....	3
Related manuals.....	3
Important.....	4
Precautions for Safety	6
Contents.....	9
User Registration	11
Terminology.....	12
1. Outline.....	13
1.1 Package Components	13
1.2 Other Tool Products Required for Development.....	14
1.3 System Configuration	15
1.3.1 System Configuration.....	15
1.3.2 Names and Functions of the PC4701 Front Panel LEDs	16
1.4 Specifications.....	18
1.5 Operating Environment.....	19
2. Setup.....	20
2.1 Flowchart of Starting Up the Emulator.....	20
2.2 Installing the Emulator Debugger (M16C PC4701 Emulator Debugger).....	21
2.2.1 Installing the Emulator Debugger	21
2.3 Connecting the Host Machine	22
2.4 Connecting the PC4701	23
2.4.1 Connecting the Cable to the PC4701	23
2.4.2 Connecting the FLX120-RPD to the Emulation Pod.....	24
2.4.3 PC4701 and Emulation Pod Arrangement.....	25
2.5 Turning ON the Power	26
2.5.1 Checking the Connections of the Emulator System	26
2.5.2 Turning ON/OFF the Power	26
2.5.3 LED Display When the Emulator Starts Up Normally	27
2.6 Downloading Firmware.....	28
2.6.1 When It is Necessary to Download Firmware.....	28
2.6.2 Downloading Firmware in Maintenance Mode.....	28
2.7 Self-check.....	29
2.7.1 Self-check Procedure.....	29
2.7.2 If an Error is Detected in the Self-check	30
2.8 Connecting the User System.....	31
2.8.1 Connecting to a 100-pin LCC socket.....	32
2.8.2 Connecting to a 100-pin 0.65-mm-pitch Foot Pattern (Part 1).....	33
2.8.3 Connecting to a 100-pin 0.65-mm-pitch Foot Pattern (Part 2).....	34
2.8.4 Connecting to a 100-pin 0.65-mm-pitch Foot Pattern (Part 3).....	35
2.9 Changing Settings	36
2.9.1 Removing/Attaching the Upper Cover	36
2.9.2 Each Setting.....	37
2.9.3 Selecting Clock Supply	38
2.9.4 Switch Settings	42
2.9.5 Installing and Removing Network Resistors for Pullup.....	45
2.9.6 Bypass Capacitors for A/D Converter	46
2.9.7 Connection Diagram of Data Slicer	47

	Page
3. Usage (How to Use the Emulator Debugger)	48
3.1. Making an MCU File	48
3.2 Setting the Work Area.....	48
3.3 Starting Up the Emulator Debugger	49
3.3.1 Init Dialog Box.....	49
3.3.2 Checking Connections of the Emulator System	55
3.4 Downloading Program	56
3.5 Program execution	57
3.6 Hardware Break.....	60
3.7 Trace Window	64
3.8 RAM Monitor Window.....	68
4. Hardware Specifications	69
4.1 Target MCU Specifications	69
4.2 Differences between the Actual MCU and Emulator	70
4.3 Connection Diagram.....	72
4.4 External Dimensions.....	74
4.4.1 External Dimensions of the Emulation Pod	74
4.4.2 External Dimensions of the M30800T-PTC	75
4.5 Notes on Using This Product.....	76
5. Troubleshooting	80
5.1 Flowchart to Remedy the Troubles.....	80
5.2 When the Emulator Debugger Does Not Start Up Properly	81
5.3 How to Request for Support	84
6. Maintenance and Guarantee	85
6.1 User Registration.....	85
6.2 Maintenance	85
6.3 Guarantee.....	85
6.4 Repair Provisions.....	85
6.5 How to Make Request for Repair	86

User Registration

When you have purchased the emulator presented in this user's manual, please be sure to register it. As the H/W Tool Customer Registration Sheet is included with this product, fill it in and FAX it to your local distributor or email the same contents to the following address. Your registered information is used for only after-sale services, and not for any other purposes. Without user registration, you will not be able to receive maintenance services such as a notification of field changes or trouble information. So be sure to carry out the user registration.

For more information about user registration, please email to the following address.

regist_tool@renesas.com

Terminology

Some specific words used in this user's manual are defined as follows:

Emulator main unit (Hereafter PC4701)

This means a generic name for emulators for M16C, 7700, 740 Families. Take note of the fact that the M306H7T3-RPD-E (this product) does not support the PC4701L and PC4700L emulators. For details on specific models of PC4701, visit the Renesas Tools Homepage at <http://www.renesas.com/en/tools>.

Emulation pod

This means the emulation pod (this product) for the M16C/6H Group M306H7.

Emulator system

This means an emulator system built around the PC4701 emulator. The PC4701 emulator system is configured with an emulator main unit, emulation pod, host machine and integrated development environment High-performance Embedded Workshop.

Integrated development environment High-performance Embedded Workshop

This tool provides powerful support for the development of embedded applications for Renesas microcomputers. It has an emulator debugger function allowing for the emulator PC4701 and emulation pod to be controlled from the host machine via an interface. Furthermore, it permits a range of operations from editing a project to building and debugging it to be performed within the same application. What's more, it supports version management.

Emulator debugger (M16C PC4701 emulator debugger)

This means a software tool starting up from the High-performance Embedded Workshop to control the emulator and this product and enables debugging.

Firmware

Program that analyzes contents of communication with the emulator debugger and controls the emulator hardware. This program is installed in the flash memory in the emulator main unit. This program is downloadable from the emulator debugger to upgrade the firmware or to support other MCUs.

Host machine

This means a personal computer used to control the emulator main unit and emulation pod.

Software break

A software break is a function to break the program before the system executes an instruction at the specified address. The instruction at the preset address will not be executed.

Hardware break

A hardware break is a function to break the program when the system detects a write/read of data to/from memory or a leading/trailing edge of the signal entered from the external trace cable. The former break function is called address break; and the latter break function is called trigger break. While the instruction at the address where the software break is set is not executed, a hardware break is performed after the specified instruction is executed.

Target MCU

This means the MCU you are going to debug.

User system

This means a user's application system using the microcomputer to be debugged.

User program

This means the program you are going to debug.

Evaluation MCU

This means the MCU mounted on the emulation pod which is operated in the specific mode for tools.

*

In this user's manual, this symbol is used to show active Low. (e.g. RESET*: Reset signal)

1. Outline

This chapter describes the package components, the system configuration and the preparation for using this product for the first time.

1.1 Package Components

The M306H7T3-RPD-E package consists of the following items. When unpacking it, check to see if your M306H7T3-RPD-E contains all of these items.

Table 1.1 Package components

Item	Quantity
M306H7T3-RPD-E emulation pod	1
FLX120-RPD flexible cable for connecting PC4701	1
M30800T-PTC converter board for 100-pin 0.65-mm-pitch LCC	1
IC61-1004-051 100-pin 0.65-mm-pitch LCC socket made by Yamaichi Electronics Co., Ltd.	1
OSC-3 16MHz oscillator circuit board for main clock (preinstalled)	1
OSC-2 oscillator circuit board (bare board)	1
Network resistors for pulling up ports P0--P5 (51kΩ x 8)	6
H/W Tool Customer Registration Sheet (English)	1
H/W Tool Customer Registration Sheet (Japanese)	1
Repair request sheet (English)	1
Repair request sheet (Japanese)	1
M306H7T3-RPD-E User's Manual (This manual)	1
M306H7T3-RPD-E User's Manual (Japanese)	1
M306H7T3-RPD-E Supplementary Document (English)	1
M306H7T3-RPD-E Supplementary Document (Japanese)	1

* Please keep the M306H7T3-RPD-E's packing box and cushion material in your place for reuse at a later time when sending your product for repair or other purposes. Always use these packing box and cushion material when transporting this product.

* If there is any question or doubt about the packaged product, contact your local distributor.

* For purchasing the IC61-1004-051 or for technical information, contact Yamaichi Electronics Co., Ltd.

1.2 Other Tool Products Required for Development

To bring forward programs development on the M16C/6H Group M306H7, the products listed below are necessary in addition to those contained package above. Get them separately.

Table 1.2 Other tool products required for development

Product		Product name	Notes
Emulator main unit		PC4701	-
Emulator debugger		M16C PC4701 Emulator Debugger	Included with the PC4701
		M3T-PD30	
Pitch converter board	100-pin 0.65-mm-pitch QFP (PRQP0100JB-A)	M3T-100LCC-DMS +	Required according to a foot pattern of a user system
		M3T-DIRECT100S	
		M3T-100LCC-DMS +	
		M3T-DUMMY100S	
		M3T-100LCC-DMS +	
		M3T-FLX-100NRB	

* To purchase these products, contact your local distributor.

1.3 System Configuration

1.3.1 System Configuration

Figure 1.1 shows a configuration of the PC4701 system.

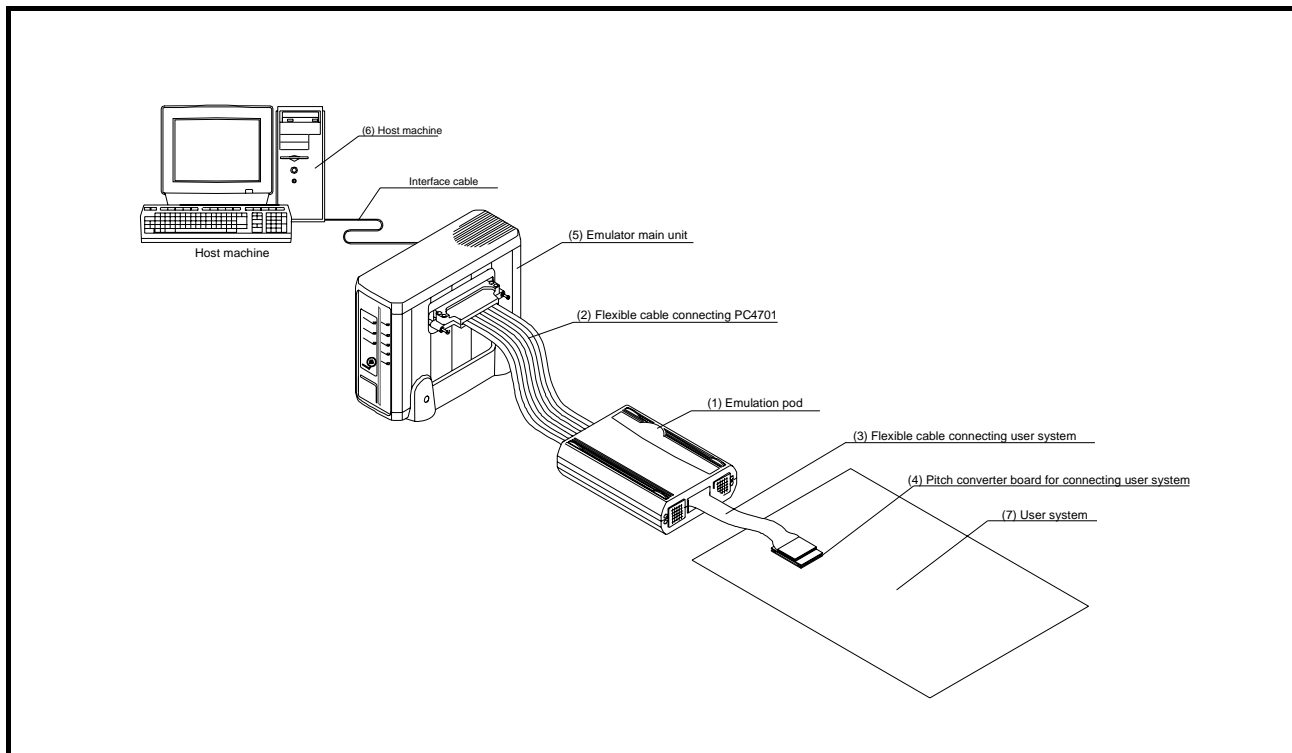

Figure 1.1 System configuration

- (1) Emulation pod M306H7T3-RPD-E (this product)
Emulation pod for the M16C/6H Group M306H7. This emulation pod contains an evaluation MCU.
- (2) Flexible cable FLX120-RPD (included)
This is a 120-conductor flexible cable for connecting the PC4701 emulator and the emulation pod.
- (3) Flexible cable M3T-FLX160C (included)
This is a 160 conductor flexible cable for connecting the emulation pod and the user system.
- (4) Converter board M30800T-PTC (included)
This is a converter board for connecting to 100-pin 0.65-mm-pitch LCC socket IC61-1004-051 on the user system. For details, refer to "2.8 Connecting the User System" (page 31).
- (5) Emulator main unit PC4701
The emulator main unit for the M16C, 7700 and 740 families to be used with this product.
- (6) Host machine
A personal computer to control the emulator.
- (7) User system
This is your application system.
This emulator cannot supply the power to the user system. Therefore design your system so that the user system is powered separately.

1.3.2 Names and Functions of the PC4701 Front Panel LEDs

Figure 1.2 shows the names of the LEDs on the front panel of the emulator.

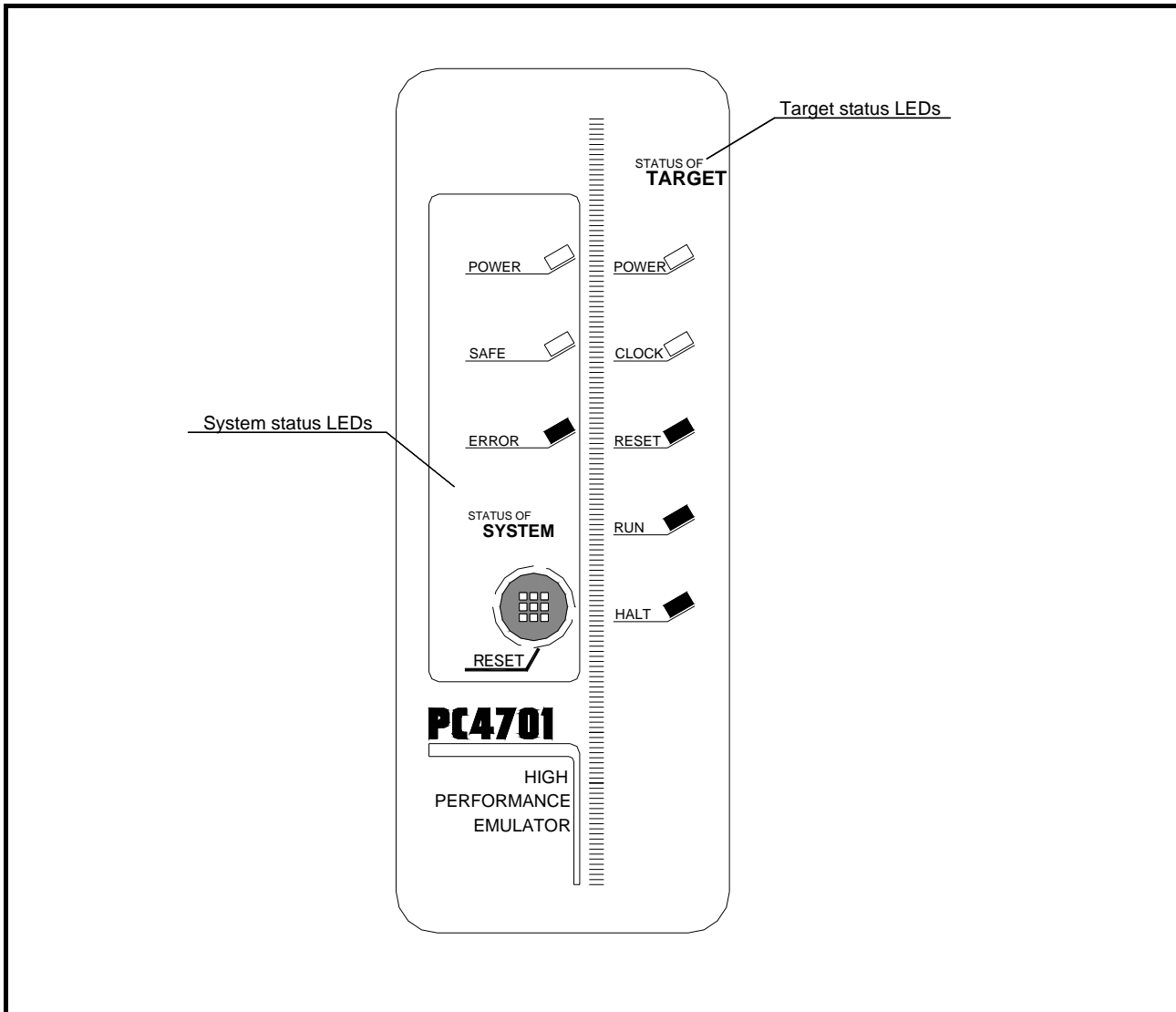

Figure 1.2 Names of the LEDs on the front panel of the PC4701

(1) System Status LEDs

The system status LEDs indicate the emulator PC4701's power supply, firmware operating status, etc. Table 1.3 lists the definition of each system status LED.

Table 1.3 Definitions of the system status LEDs

Name	Status	Meaning
POWER	ON	Emulator system power supply is turned ON.
	OFF	Emulator system power supply is turned OFF.
SAFE	ON	Emulator system is operating normally.
	Flashing	Special mode (maintenance mode) for downloading firmware. The emulator system does not operate except for downloading firmware and the self-check.
	OFF	Emulator system is not operating normally (system status error).
ERROR	ON	Emulator system is not operating normally.
	Flashing	Downloading firmware.
	ON	Emulator system is operating normally.

(2) Target Status LEDs

The target status LEDs indicate the target MCU's operating status and target board's power supply. Table 1.4 lists the definition of each target status LED.

Table 1.4 Definitions of the target status LEDs

Name	Status	Meaning
POWER	ON	Power is supplied to the user system.
	OFF	Power is not supplied to the user system.
CLOCK	ON	Target MCU clock is oscillating.
	OFF	Target MCU clock is not oscillating.
RESET	ON	Target MCU is being reset, or reset signal of the user system is held low.
	OFF	Target MCU is not being reset.
RUN	ON	User program is being executed.
	OFF	User program has been halted.
HALT	ON	CPU clock of target MCU is not oscillating.
	OFF	CPU clock of target MCU is oscillating.

IMPORTANT

Note on the Target Status POWER LED:

- If your MCU has two or more power supply terminals (Vcc), you need to supply power to all the terminals.

Note on the Target Status CLOCK LED:

- If the LED is not turned on, check the following.
 - (1) After powering on the PC4701 (before starting up the emulator debugger):
Make sure that the oscillator circuit board in the emulation pod is properly installed and it is oscillating normally.
 - (2) After the emulator debugger is started up (after the Init dialog box settings are completed):
Make sure that the oscillator selected in the Init dialog box is oscillating normally.

1.4 Specifications

Tables 1.5 and 1.6 list the specifications of the M306H7T3-RPD-E.

Table 1.5 M306H7T3-RPD-E specifications (1/2)

Item	Description
Applicable MCU	M16C/6H Group M306H7
Usable MCU mode	Single-chip mode
Emulation Memory	1MB
Applicable power supply	VCC2=4.0V--5.5V, VCC1=3.0V--VCC2 (Xin: when operating without division) VCC2=2.9V--5.5V, VCC1=2.9V--VCC2 (Xin: when operating in a divide-by-16 or 8-mode) VCC2=2.0V--5.5V, VCC1=2.0V--VCC2 (Xcin when operating) *VCC2=2.0V--2.6V operates only in low power dissipation mode.
Maximum operating frequency	16MHz
Clock supply	X _{IN} -X _{OUT} Internal oscillator circuit board (OSC-3) Switchable to external oscillator input
	X _{CIN} -X _{COU} Internal oscillator circuit (fixed 32.768kHz) Switchable to external oscillator input
Basic debugging functions	<ul style="list-style-type: none"> - Download - Software break (max. 64 points) - Program execution/stop (allows free-run execution supporting software breaks) - Memory reference/setting (reference/setting C-variables, run-time execution) - Register reference/setting - Disassemble display - C-level debugging, etc.
Real-time trace function	<ul style="list-style-type: none"> - 32K-cycle bus information recordable (Bus, external trigger, time stamp) - 5 trace modes supported (Break/Before/About/After/Full) - Can be recorded ON/OFF by events
Real-time RAM monitor function	<ul style="list-style-type: none"> - 1,024 bytes - Data/last access result
Hardware break function	6 points (Bus detection, interrupt, external trace signal)
Execution time measurement function	Time between program start and stop Maximum/minimum/average execution time and pass count of specified four zones. Count clock: Equal to MCU Clock or 16 MHz
C0 coverage	256KB
Event output	Break x1, Event x6
External trigger input	TTL level x8
Host machine interface (see "2.3 Connecting the Host Machine" on page 22)	Dedicated parallel (PC4701HS) LPT parallel (PC4701M/PC4701U) Serial (PC4701HS/PC4701M) USB (USB 1.1, full-speed)*1 LAN (PC4701HS/PC4701U)
Power supply to emulator	AC100--120V, AC200--240V (50/60Hz)
Overseas standards	US EMI standard [FCC part15 Class A] CE marking [1998 Class A, EN55024: 1998]

*1 Available to connect the host machine that supports USB 2.0. With the USB interface, not all hardware (such as host machine, USB devices, USB hub) combination will work and guaranteed.

Table 1.6 M306H7T3-RPD-E specifications (2/2)

Item	Description	
Connecting the user system (see "2.8 Connecting the User System" on page 31)	100-pin LCC socket	1 M30800T-PTC (included) + IC61-1004-051 (included)
	100-pin 0.65-mm-pitch QFP (PRQP0100JB-A)	1 M30800T-PTC (included) + M3T-100LCC-DMS (not included) + M3T- DIRECT100S (not included) 2 M30800T-PTC (included) + M3T-100LCC-DMS (not included) + M3T-DUMMY100S (not included) 3 M30800T-PTC (included) + M3T-100LCC-DMS (not included) + M3T-FLX-100NRB (not included)

1.5 Operating Environment

Be sure to use this emulator with the operating environmental of the emulator and host machine listed in Tables 1.7 and 1.8.

Table 1.7 Operating environmental conditions

Item	Description
Operating temperature	5 to 35°C (no dew)
Storage temperature	-10 to 60°C (no dew)

Table 1.8 Operating environment of the host machine

Item	Description
Host machine	IBM PC/AT compatibles
OS	Windows 98SE Windows Me Windows XP Windows 2000
CPU	Pentium III 600 MHz or more recommended
Memory	128 MB or more recommended
Pointing device such as mouse	Mouse or any other pointing device usable with the above OS that can be connected to the main body of the host machine.
CD drive	Needed to install the emulator debugger or refer to the user's manual

* Windows is trademarks of Microsoft Corporation in the United states and other countries.

2. Setup

This chapter describes the preparation for using this product, the procedure for starting up the emulator and how to change settings.

2.1 Flowchart of Starting Up the Emulator

The procedure for starting up the emulator is shown in Figure 2.1. For details, refer to each section hereafter. And, when the emulator does not start up normally, refer to “5. Troubleshooting” (page 80).

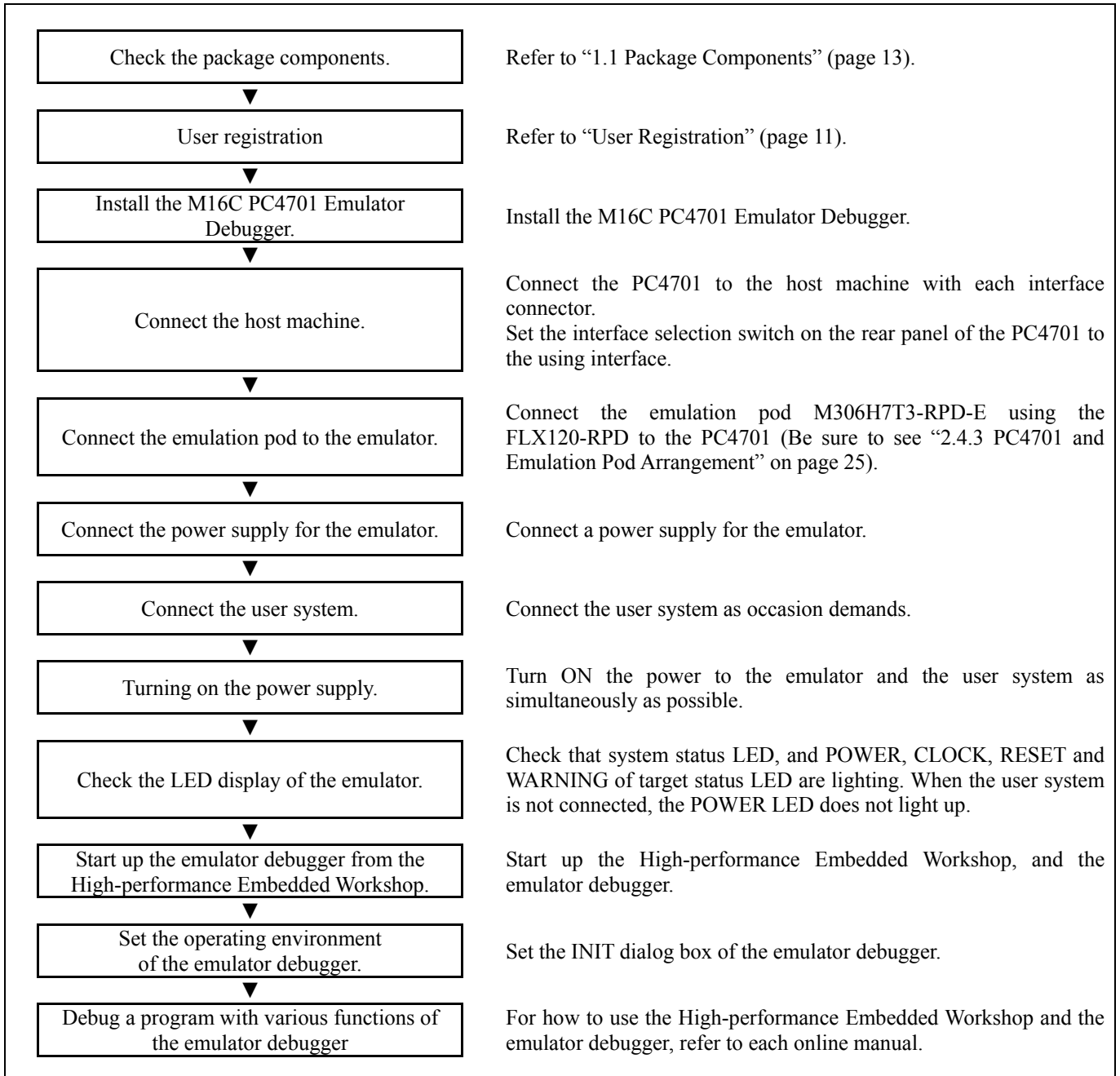

Figure 2.1 Flowchart of starting up the emulator

2.2 Installing the Emulator Debugger (M16C PC4701 Emulator Debugger)

If the OS used in your host machine is Windows XP or 2000, this installation must be executed by a user with administrator rights. Be aware that users without administrator rights cannot complete the installation.

Install the M16C PC4701 Emulator Debugger following the procedure described below.

2.2.1 Installing the Emulator Debugger

(1) Downloading the M16C PC4701 Emulator Debugger (as occasion demands)

Download the latest M16C PC4701 Emulator Debugger from the URL below (free of charge).

http://download.renesas.com/eng/mpumcu/upgrades/in_circuit_emulators/m16c/index.html

(2) Launching the installer

Start the "setup.exe" program.

(3) Entering the user information

In the "user information" dialog box, enter the user information (contractor, section, contact address, and host machine).

The supplied information will be turned into a format by which user registration will be provided by e-mail.

(4) Completing the installation

A dialog box will be displayed indicating that setup has been completed. It means that the installation you made is completed.

2.3 Connecting the Host Machine

When connecting the emulator PC4701 to a host machine, interface varies depending on the PC4701 used. Figure 2.1 shows the outline to connect each interface cable. For details on interface, refer to each PC4701 user's manual used.

Table 2.1 Operating environment of the host machine

PC4701	Interface	Remarks
PC4701HS	Dedicated parallel	The special parallel interface cable is supplied with the PC4701HS. For connection with the dedicated parallel interface, the parallel interface printed circuit board (PCA4202G02: discontinued product) is required on the host machine side.
	Serial (RS232C)	The RS232C interface cable, 25-pin female/25-pin female conversion cable and 25-pin female/9-pin female conversion cable are supplied with the PC4701HS.
	LAN (10BASE-2/5)	The LAN interface cable (10BASE-2/5) is supplied with the PC4701HS.
PC4701M	LPT parallel	The LPT parallel interface cable is supplied with the PC4701M.
	Serial (RS232C)	The RS232C interface cable and 25-pin female/9-pin male conversion cable are supplied with the PC4701M.
PC4701U	LPT parallels	The LPT parallel interface cable is supplied with the PC4701U.
	USB	The USB interface cable is supplied with the PC4701U.
	LAN (10BASE-T)	No LAN interface cable is supplied with the PC4701U; it is, therefore, necessary to arrange a LAN interface cable at your end.

2.4 Connecting the PC4701

To connect the emulation pod to the PC4701, use the FLX120-RPD 120-pin flexible cable included with this product package. Connect the PC4701 side connector of the FLX120-RPD to the cable connector of the PC4701, then secure with screws the FLX120-RPD.

2.4.1 Connecting the Cable to the PC4701

Figure 2.2 shows how to connect the PC4701 and FLX120-RPD.

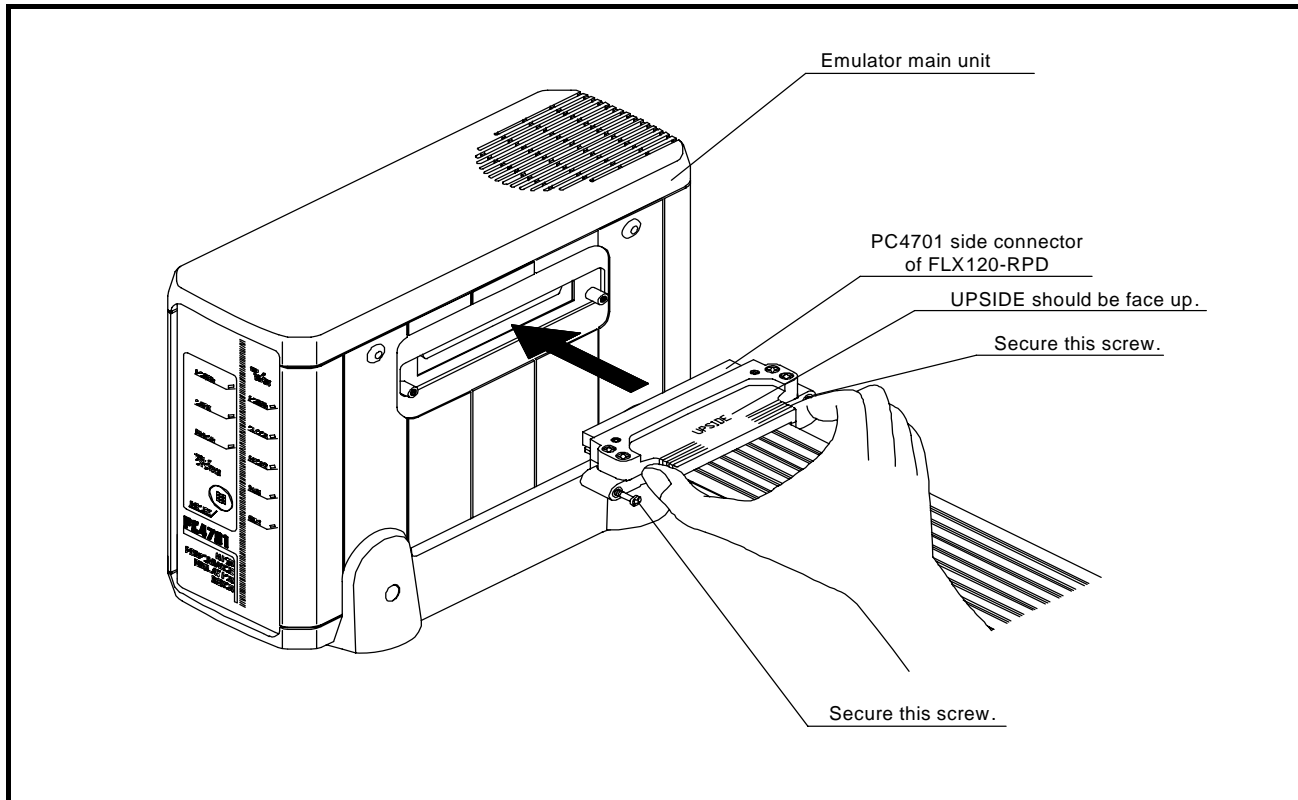

Figure 2.2 Connecting the cable to the PC4701

CAUTION

Note on Connecting the PC4701 and FLX120-RPD:



- Always shut OFF power before connecting the cable. Otherwise, the internal circuits may be damaged.

IMPORTANT

Notes on Connecting the Cable and Securing the Screws:

- To connect the FLX120-RPD, be sure to hold the both sides of the PC4701 side connector horizontally with the "UPSIDE" facing up.
- After connecting the cable to the emulator main unit PC4701, be sure to secure the screws mounted in both sides of the connector.

2.4.2 Connecting the FLX120-RPD to the Emulation Pod

Figure 2.3 shows how to connect the FLX120-RPD and the emulation pod.

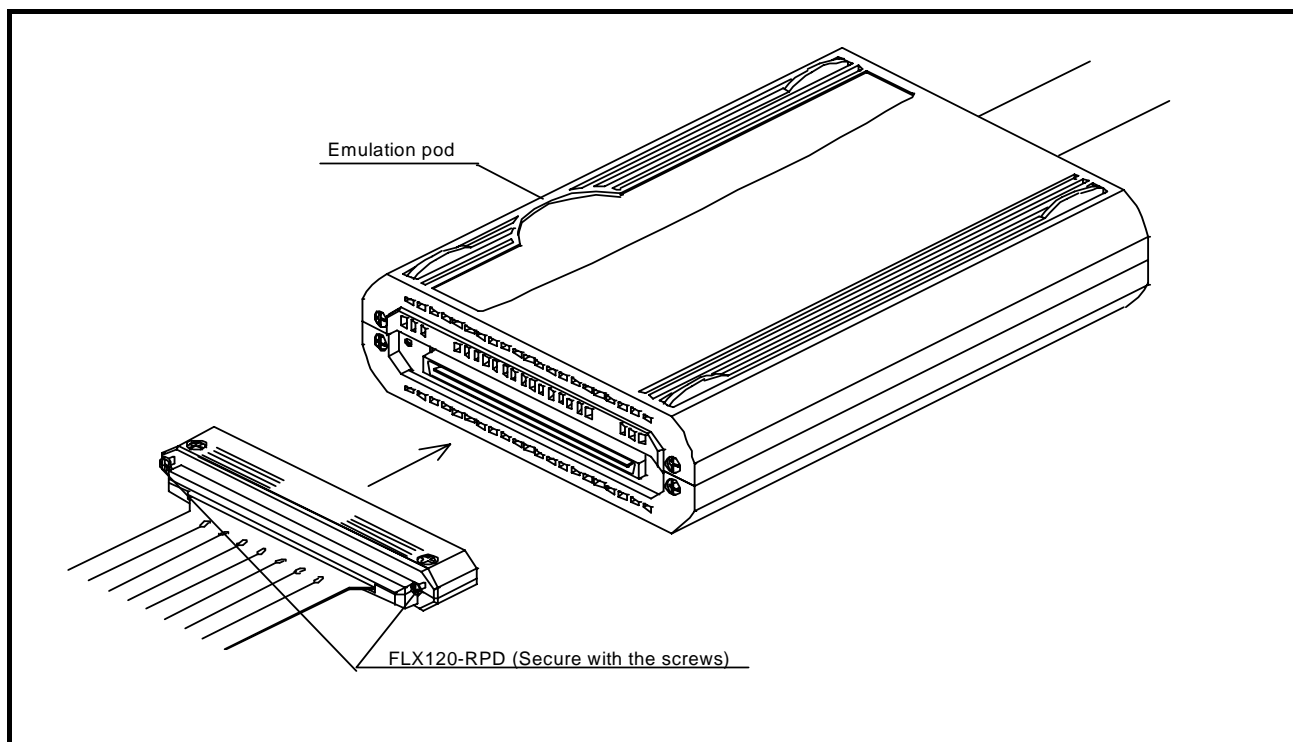

Figure 2.3 Connecting the FLX120-RPD to the emulation pod

CAUTION

Note on Connecting the Cable:



- Always shut OFF power before connecting the emulation pod and the FLX120-RPD. Otherwise, the internal circuits may be damaged.

IMPORTANT

Note on Securing the Screws:

- After connecting the emulation pod and the FLX120-RPD, be sure to secure the screws mounted in both sides of the connector cover

2.4.3 PC4701 and Emulation Pod Arrangement

The PC4701 and emulation pod should be laid out so that the FLX120-RPD becomes straight as shown in Fig. 2.4 below (indicated by circle).

Under the condition in which the FLX120-RPD has warped and there arises clearance in the slit, it is impossible to comply with the overseas applicable standards (U.S FCC and CE Marking) to be satisfied by this product.

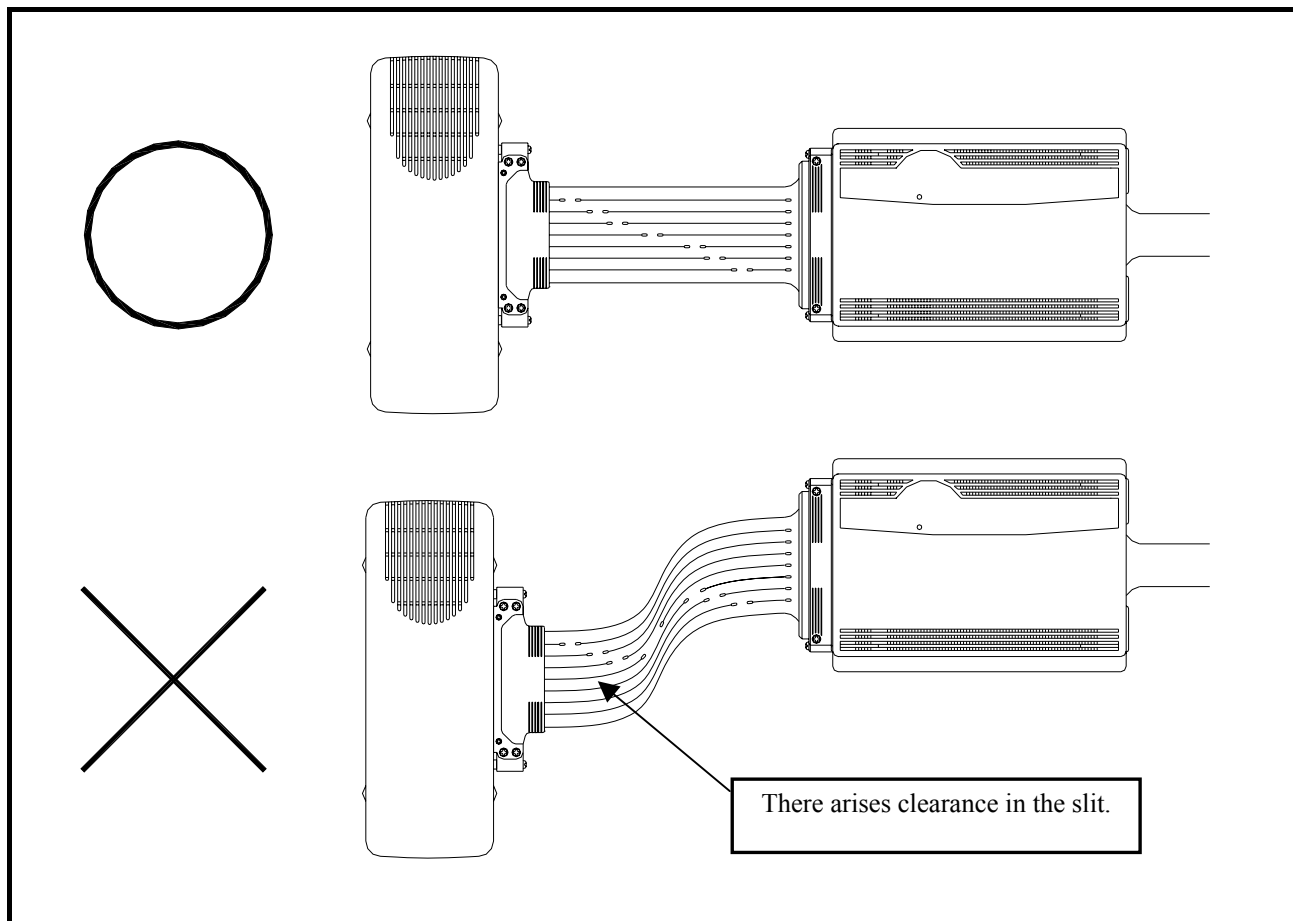

Figure 2.4 PC4701 and Emulation Pod Arrangement

⚠ CAUTION

Note on PC4701 and Emulation Pod Arrangement:



- The PC4701 and emulation pod should be laid out in accordance with the explanation herein. In case where these arrangements were carried out without following the explanation, it is impossible to keep the overseas applicable standards (U.S FCC and CE Marking) that this product must satisfy..

2.5 Turning ON the Power

2.5.1 Checking the Connections of the Emulator System

Before turning the power ON, check the connection of the interface cable with host machine, PC4701, emulation pod, and user system.

2.5.2 Turning ON/OFF the Power

- Turn ON the power of the emulator and user system as simultaneously as possible.
- Turn OFF the power of the emulator and user system as simultaneously as possible.
- Do not leave either the emulator or user system powered on, because of leakage current the internal circuits may be damaged.
- When turning ON the power again after shutting OFF the power, wait for about 10 seconds.

IMPORTANT

Notes on Power Supply:

- The emulator's pin Vcc is connected to the user system in order to monitor user system voltage. For this reason, the emulator cannot supply power to the user system. Therefore, provide the user system with a separate power supply from that of the emulator.
- Keep user system power supply voltage within the following range.
 - (1) When JP4 is set as FLX:
 $2.0\text{ V} \leq V_{cc2} \leq 5.5\text{ V}$
 $2.0\text{ V} \leq V_{cc1} < V_{cc2}$
 - (2) When JP4 is set as INT:
 $2.0\text{ V} \leq V_{cc1} = V_{cc2} \leq 5.5\text{ V}$
- Do not change user system power supply voltage after power has been activated.

2.5.3 LED Display When the Emulator Starts Up Normally

Figure 2.5 shows front panel LED lighting status when the emulator started up properly. Check it when starting up the emulator system.

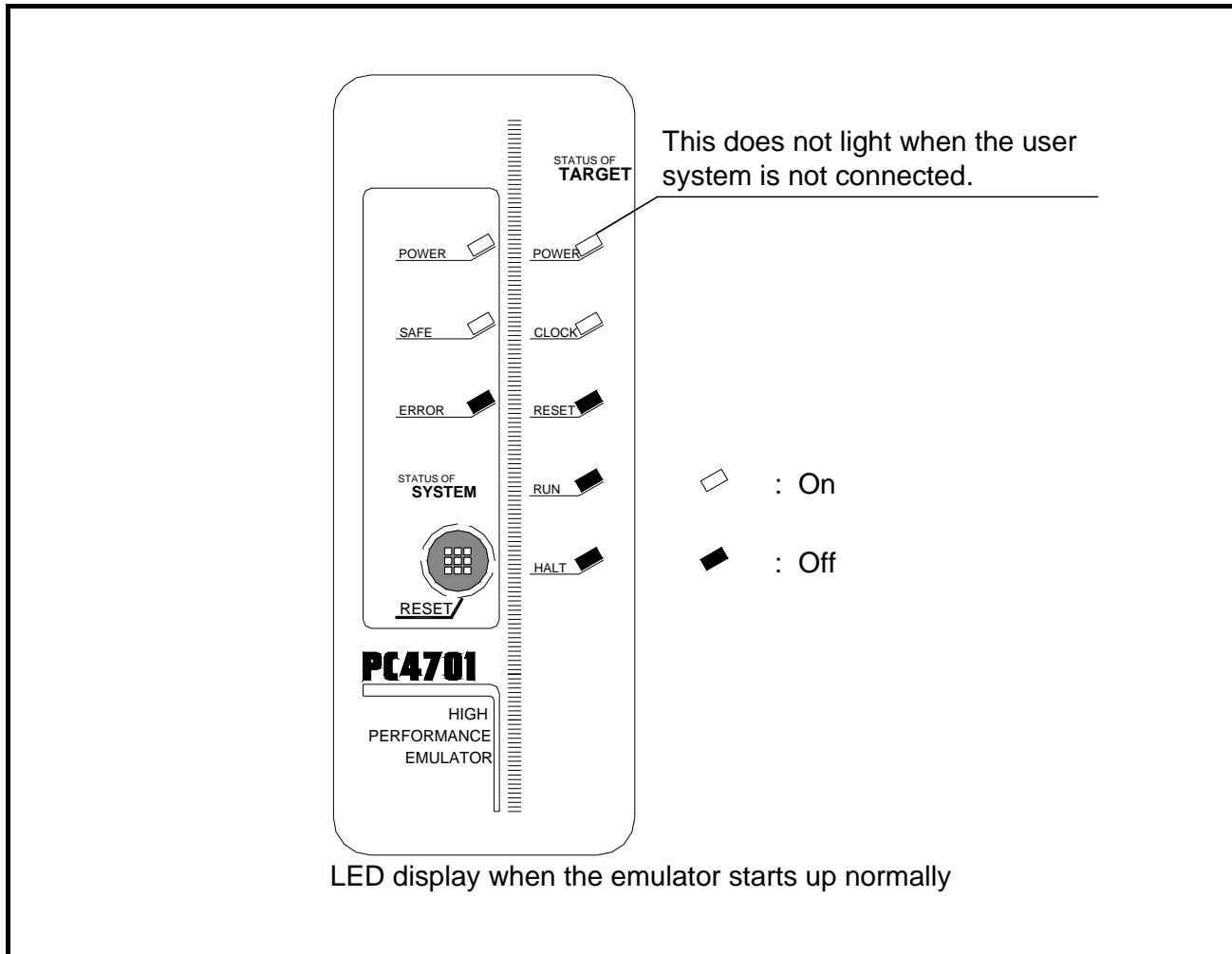

Figure 2.5 LED display when the power turned on

IMPORTANT

Note on the Target Status POWER LED:

- If the MCU has two or more Vcc terminals, the LED does not light unless power is supplied to all the terminals.

Note on the Target Status CLOCK LED:

- If the LED is not turned on, check the following.
 - (1) After powering on the PC4701 (before starting up the emulator debugger):
Make sure that the oscillator circuit board is properly installed in the PC4701 and it is oscillating normally.
 - (2) After the emulator debugger is started up (after the Init dialog box settings are complete):
Make sure that the oscillator selected in the Init dialog box is oscillating normally.

2.6 Downloading Firmware

2.6.1 When It is Necessary to Download Firmware

It is necessary to download the firmware in the cases listed below. Normally, the following are automatically detected when the emulator debugger is started up, and the firmware is downloaded.

- (1) you use this product for the first time
- (2) the firmware has been upgraded
- (3) the emulator debugger has been upgraded
- (4) you use this product with a PC4701 which was used with other emulation pod before

If downloading firmware is not completed in the cases below, redownload the firmware.

- When the power is unexpectedly shut down during a download from the emulator debugger
- When a communications interface cable is unexpectedly pulled out

2.6.2 Downloading Firmware in Maintenance Mode

Download the firmware in maintenance mode as explained here following. **The user system must not be connected when downloading the firmware.**

- (1) Set the interface select switch on the rear panel of the PC4701 to the dedicated parallel, LPT or serial interface to connect the PC4701 and the host machine. Set the interface selection switch on the rear panel of the PC4701 according to the using interface. The firmware may not be downloaded in maintenance mode correctly with the USB interface.

- (2) Within 2 seconds of activating power to the emulator, press the RESET switch on the PC4701 upper panel to switch to maintenance mode.

Switched to maintenance mode, the SAFE SYSTEM STATUS LED begins to flash.

- (3) Start up the emulator debugger. When the Init dialog box setup is complete, the dialog which urges to download the firmware will appear. Download the firmware following messages. Required time for downloading the firmware is about 60 seconds.

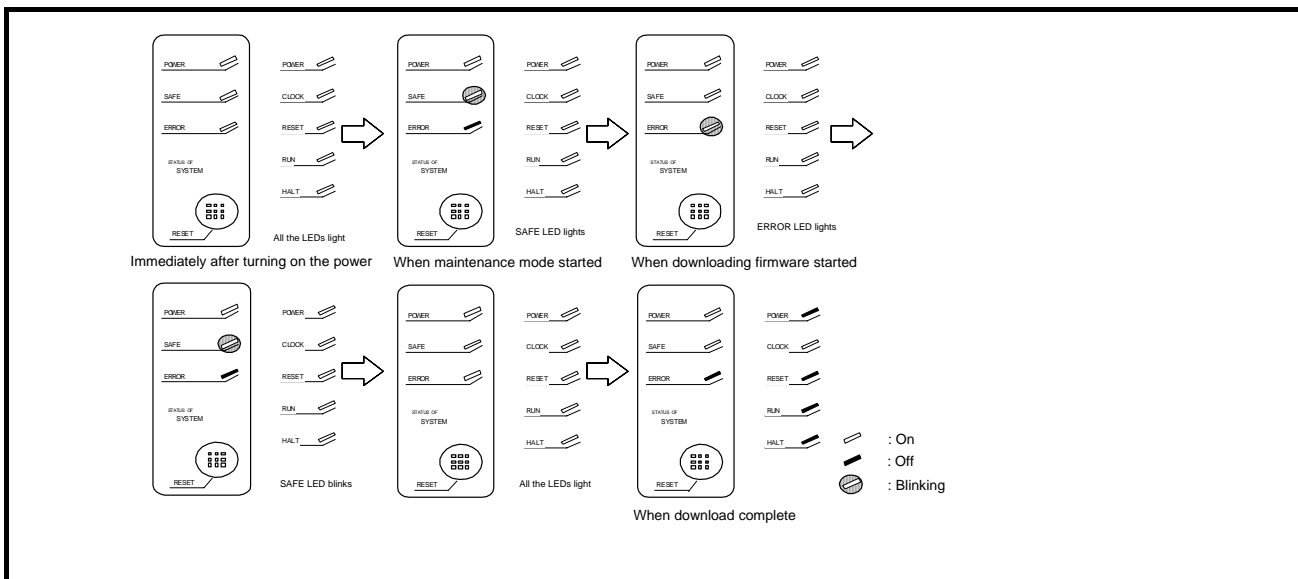

Figure 2.6 Downloading firmware in maintenance mode

IMPORTANT

Note on Downloading Firmware:

- Do not shut OFF power while the firmware is being downloaded. Doing so, the emulator will not start up properly. If power is shut OFF by mistake, redownload the firmware in maintenance mode.

2.7 Self-check

2.7.1 Self-check Procedure

To run the self-check of the emulator, do so as explained here below. While the self-check is in progress, the LEDs will change as shown in Figure 2.7.

- (1) If the user system is connected, disconnect it.
- (2) Set the switches in the emulation pod to the factory settings as shown in Figure 2.8.
- (3) Within 2 seconds of activating power to the emulator, press the system reset switch on the emulator front panel to switch the emulator to maintenance mode.
- (4) Check the SAFE LED starts blinking and then press the system reset switch again.
- (5) The self-check will start. If the normal result is displayed in about 30 seconds, the self-check has terminated normally.

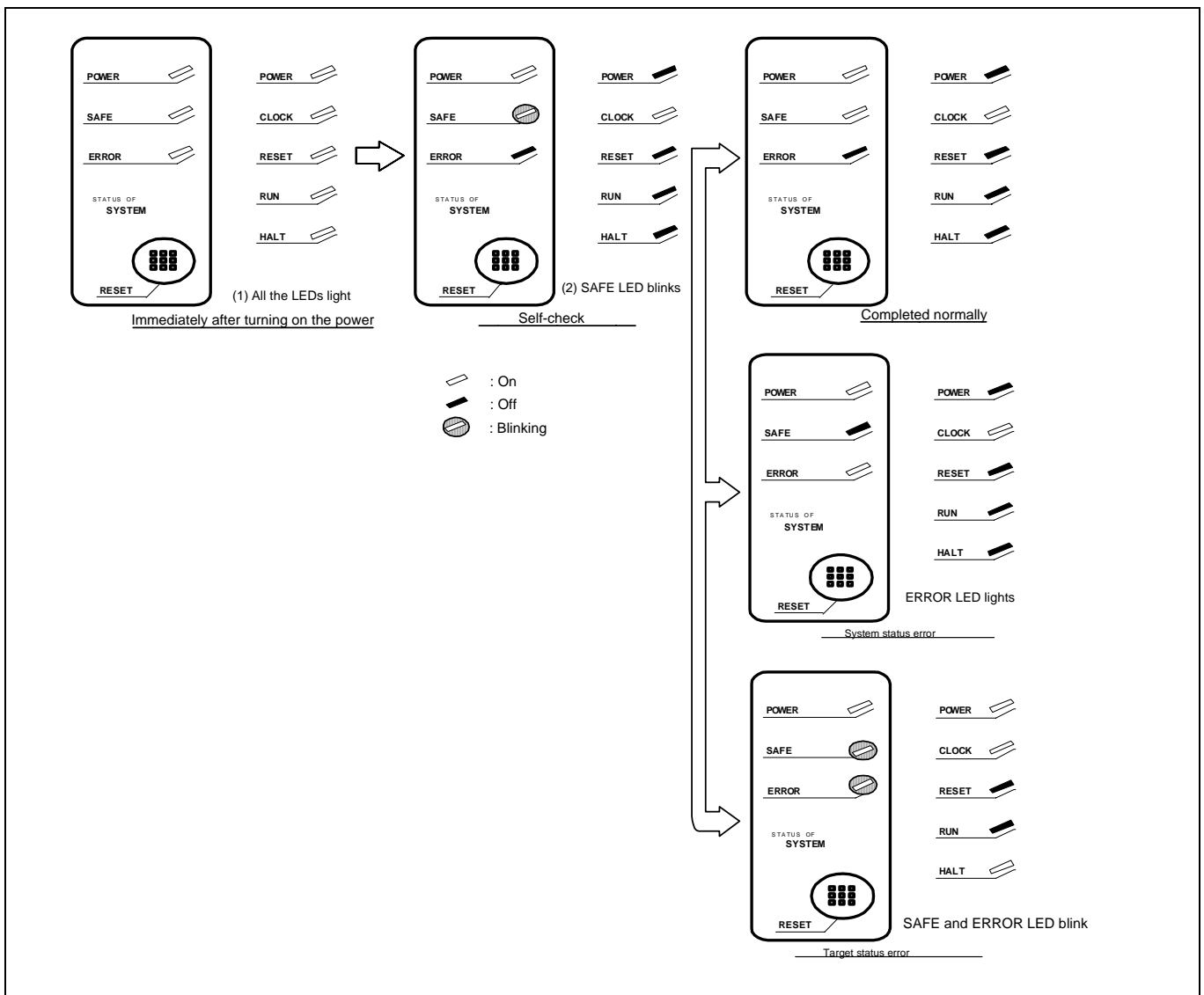

Figure 2.7 LED display in the self-check procedure

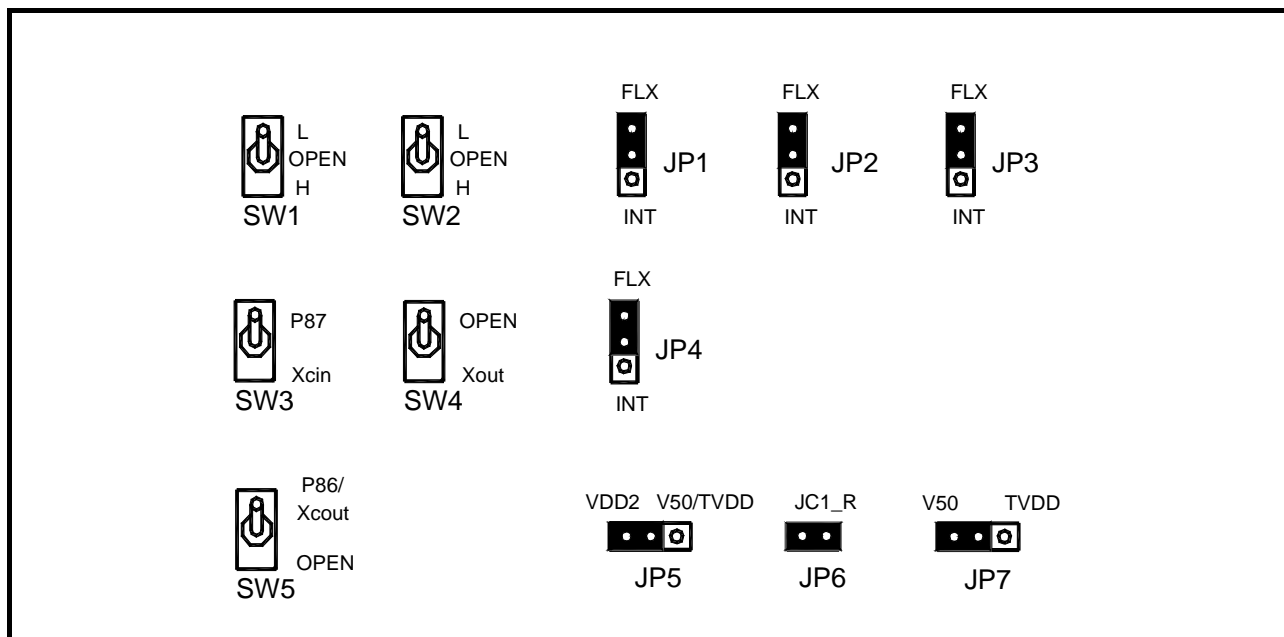

Figure 2.8 Switch settings for the self-check (factory-settings)

2.7.2 If an Error is Detected in the Self-check

If the self-check does not result normally (system status error or target status error in Figure 2.7), check the following.

- Whether the emulation pod and PC4701 are connected properly
- Whether the proper firmware has been downloaded
- Whether the switch settings of this product are the factory-settings

IMPORTANT

Notes on Self-check:

- Perform the self-check while not connecting the user system.
- If the self-check does not result normally (excluding user system error), the emulation pod may be damaged. Then contact your local distributor.

2.8 Connecting the User System

Connect the emulation pod to the user system as shown in Figure 2.9.

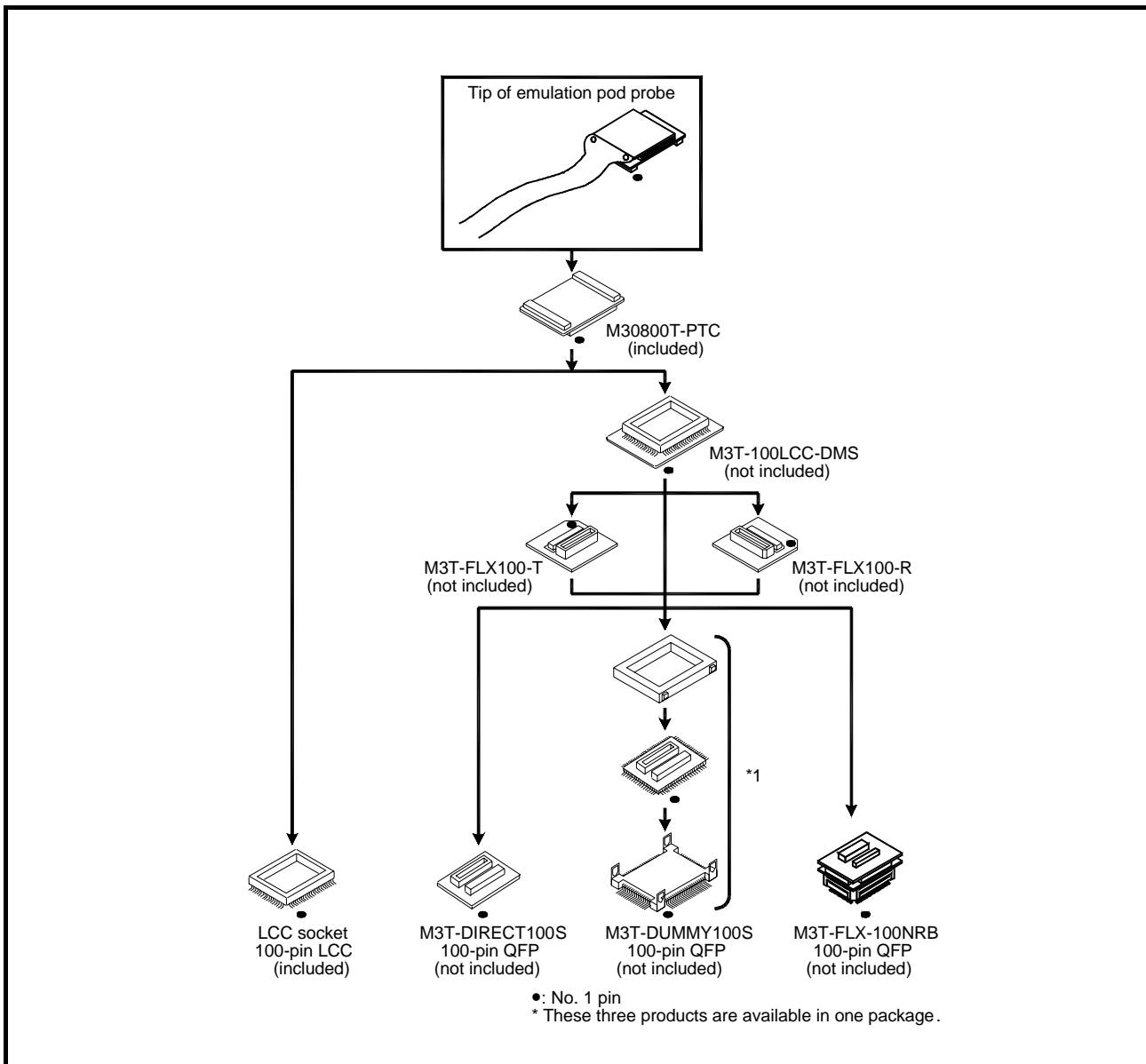

Figure 2.9 Connecting the user system

⚠ CAUTION

Note on Connecting the User System:

- Take care not to attach the converter board in a wrong direction. It may cause a fatal damage to the emulator or user system.

* NQPACK, YQPACK, YQSOCKET, YQ-GUIDE, HQPACK, TQPACK and TQSOCKET are trademarks of Tokyo Eletech Corporation.

2.8.1 Connecting to a 100-pin LCC socket

Figure 2.10 shows how to connect a 100-pin LCC socket (IC61-1004-051 of Yamaichi Electronics Co., Ltd.) on the user system to the M30800T-PTC (included).

- (1) Attach the 100-pin LCC socket to the user system.
- (2) Attach the CN2 side of the M30800T-PTC to the CN2 side of the FLX160-PRB.
- (3) Attach the M30800T-PTC to the 100-pin LCC socket.

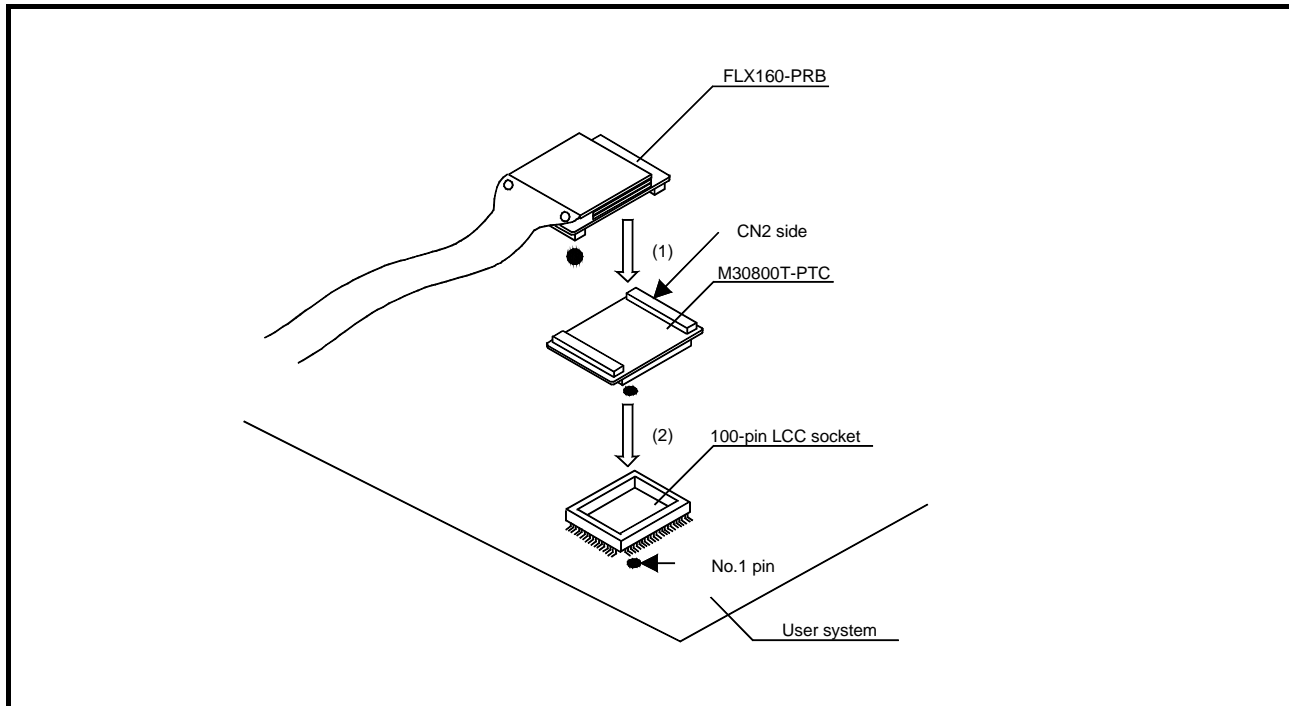

Figure 2.10 Connecting to a 100-pin LCC socket

CAUTION

Note on Connecting the User System:



- Take care not to attach the converter board in a wrong direction. It may cause a fatal damage to the emulator or user system.

IMPORTANT

Notes on Connectors of Converter Boards:

- The connectors of the M30800T-PTC are guaranteed for only 50 insertion/removal iterations.
- For purchasing the IC61-1004-051 or for technical information, contact Yamaichi Electronics Co., Ltd.

2.8.2 Connecting to a 100-pin 0.65-mm-pitch Foot Pattern (Part 1)

Figure 2.11 shows how to connect a 100-pin 0.65-mm-pitch foot pattern on the user system to the M3T-DIRECT100S (not included), and here following is its procedure.

For details on the M3T-100LCC-DMS (not included) and M3T- DIRECT100S (not included), refer to each user's manual.

- (1) Attach the M3T- DIRECT100S to the user system.
- (2) Attach the M3T-100LCC-DMS to the M3T-DIRECT100S.
- (3) Attach the CN2 side of the M30800T-PTC to the CN2 side of the FLX160-PRB.
- (4) Attach the M30800T-PTC to the M3T-100LCC-DMS

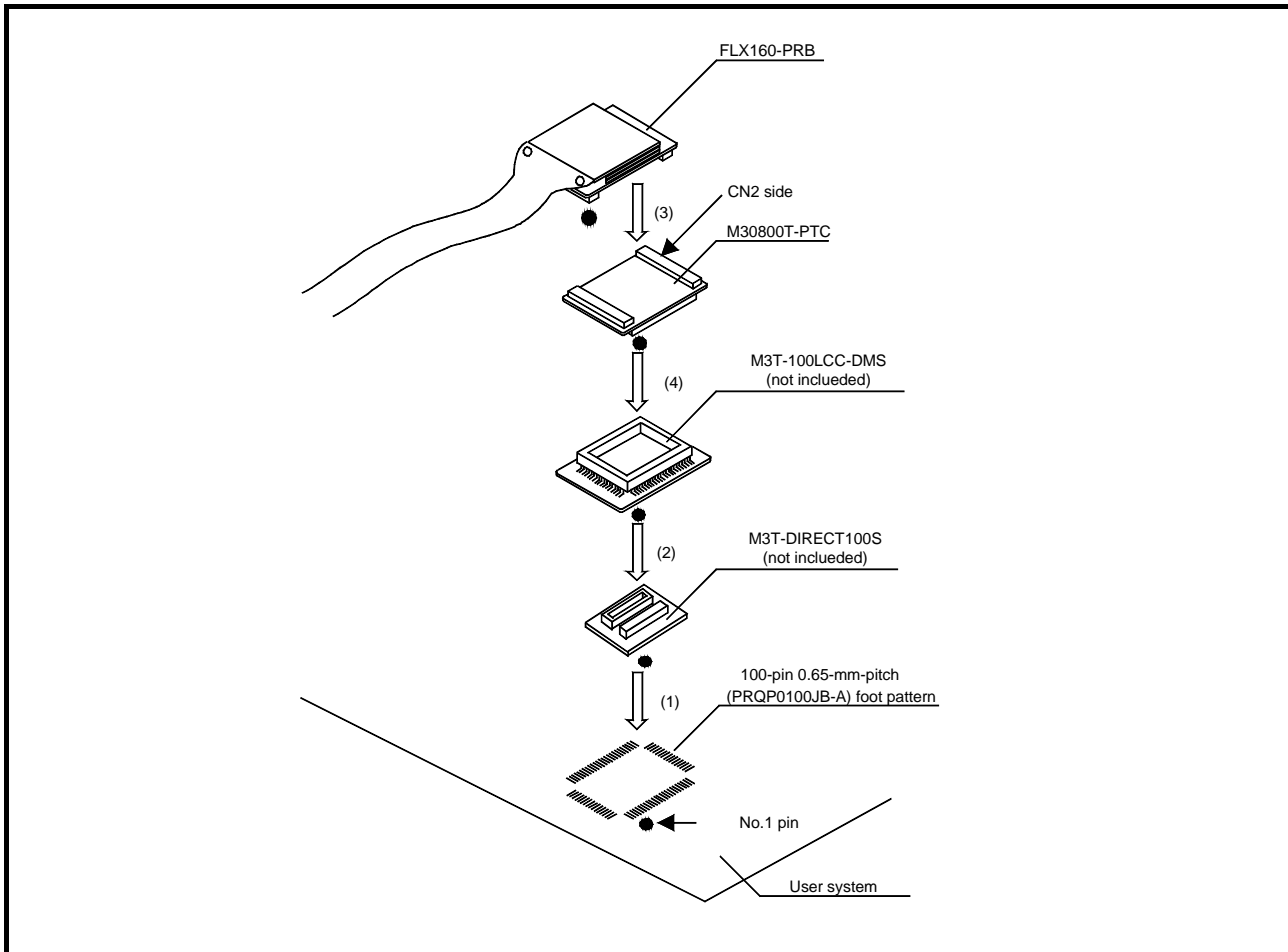

Figure 2.11 Connecting to a 100-pin 0.65-mm-pitch foot pattern (1/3)

CAUTION

Note on Connecting the User System:



- Take care not to attach the converter board in a wrong direction. It may cause a fatal damage to the emulator or user system.

IMPORTANT

Notes on Connectors of Converter Boards:

- The connectors of the M30800T-PTC are guaranteed for only 50 insertion/removal iterations.
- The connectors of the M3T-100LCC-DMS and M3T-DIRECT100S are guaranteed for only 20 insertion/removal iterations.

2.8.3 Connecting to a 100-pin 0.65-mm-pitch Foot Pattern (Part 2)

Figure 2.12 shows how to connect a 100-pin 0.65-mm-pitch foot pattern on the user system to the M3T-DUMMY100S (not included), and here following is its procedure.

For details on the M3T-100LCC-DMS (not included) and M3T-DUMMY100S (not included), refer to each user's manual.

- (1) Attach the M3T-DUMMY100S to the user system.
- (2) Attach the M3T-100LCC-DMS to the M3T-DUMMY100S.
- (3) Attach the CN2 side of the M30800T-PTC to the CN2 side of the FLX160-PRB.
- (4) Attach the M30800T-PTC to the M3T-100LCC-DMS.

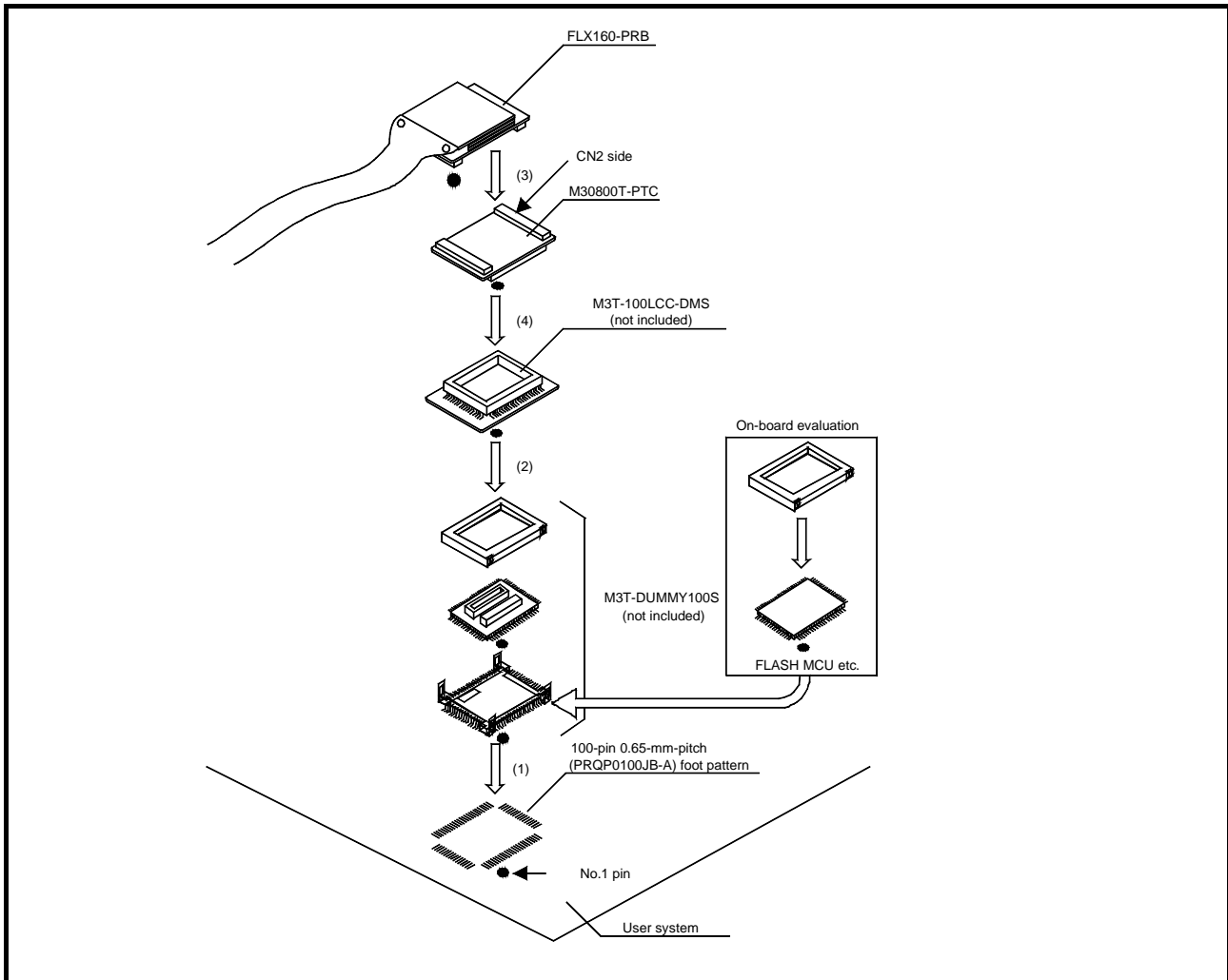

Figure 2.12 Connecting to a 100-pin 0.65-mm-pitch foot pattern (2/3)

CAUTION

Note on Connecting the User System:



- Take care not to attach the converter board in a wrong direction. It may cause a fatal damage to the emulator or user system.

IMPORTANT

Notes on Connectors of Converter Boards:

- The connectors of the M30800T-PTC are guaranteed for only 50 insertion/removal iterations.
- The connectors of the M3T-100LCC-DMS and M3T-DUMMY100S are guaranteed for only 20 insertion/removal iterations.

2.8.4 Connecting to a 100-pin 0.65-mm-pitch Foot Pattern (Part 3)

Figure 2.13 shows how to connect a 100-pin 0.65-mm-pitch foot pattern on the user system to the M3T-FLX-100NRB (not included), and here following is its procedure.

For details on the M3T-100LCC-DMS (not included) and M3T-FLX-100NRB (not included), refer to each user's manual.

- (1) Attach the NQPACK100RB included with the M3T-FLX-100NRB to the user system.
- (2) Attach the YQPACK100RB included with M3T-FLX-100NRB to the NQPACK100RB and secure it with the YQ-GUIDE's.
- (3) Attach the M3T-FLX-100NRB to the YQPACK100RB.
- (4) Attach the M3T-100LCC-DMS to the M3T-FLX-100NRB
- (5) Attach the CN2 side of the M30800T-PTC to the CN2 side of the FLX160-PRB.
- (6) Attach the M30800T-PTC to the M3T-100LCC-DMS.

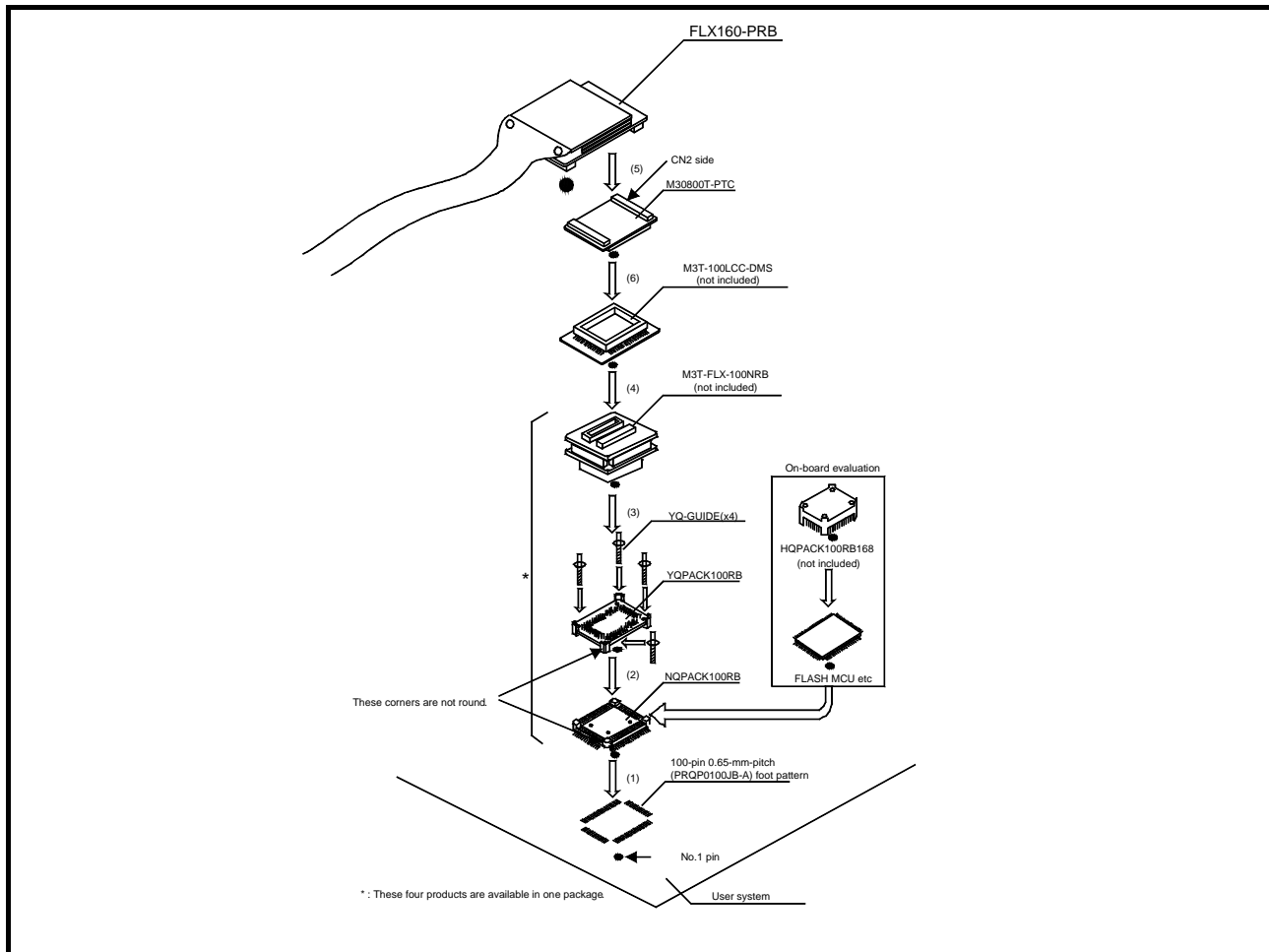

Figure 2.13 Connecting to a 100-pin 0.65-mm-pitch foot pattern (3/3)

CAUTION

Note on Connecting the User System:



- Take care not to attach the converter board in a wrong direction. It may cause a fatal damage to the emulator or user system.

IMPORTANT

Notes on Connectors of Converter Boards:

- The connectors of the M30800T-PTC are guaranteed for only 50 insertion/removal iterations.
- The connectors of the M3T-100LCC-DMS and M3T-FLX-100NRB are guaranteed for only 20 insertion/removal iterations.

2.9 Changing Settings

This chapter describes how to set the inside of the emulator.

2.9.1 Removing/Attaching the Upper Cover

(1) Removing the upper cover

To open the upper cover, remove the four screws of both sides of this product and lift off the upper cover (see Figure 2.14)

(2) Attaching the upper cover

To close the upper cover, attach the upper cover and secure the four screws of both sides of this product.

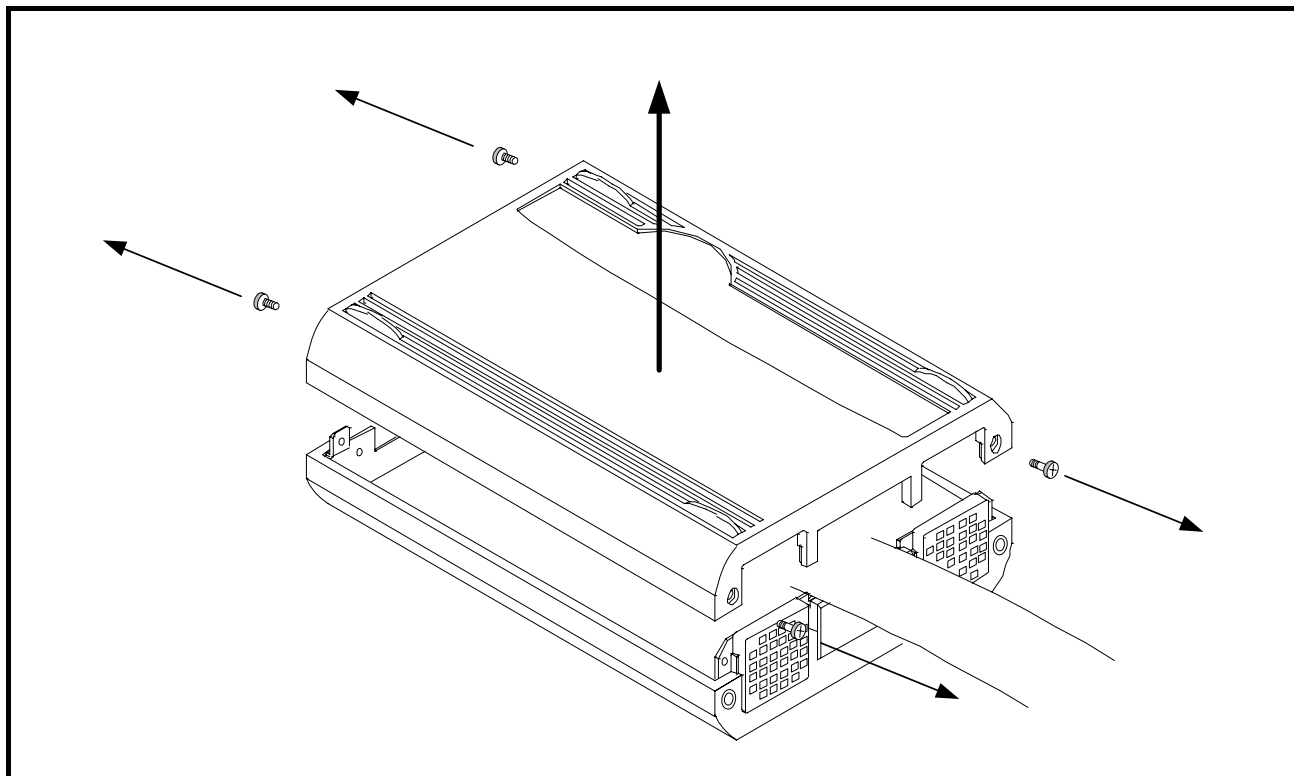

Figure 2.14 Removing the upper cover

CAUTION

Note on Removing and Attaching the Upper Cover:



- Always shut OFF power when removing/attaching the upper cover or changing the switch settings. Otherwise the internal circuit may be damaged.

2.9.2 Each Setting

Figure 2.15 shows the positions of each part of this product.

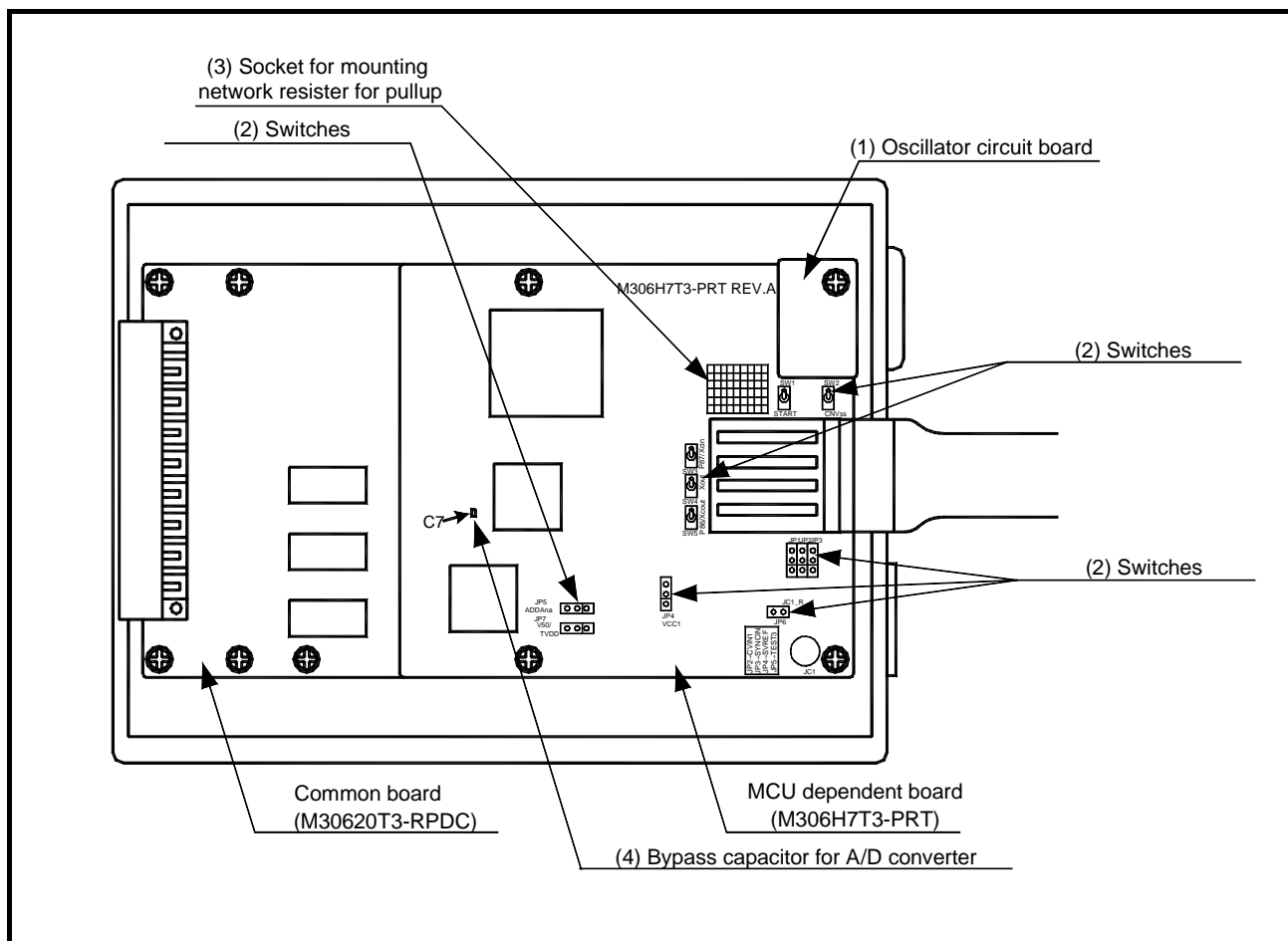

Figure 2.15 Positions of each part

2.9.3 Selecting Clock Supply

(1) Clock Supply to the MCU

You can choose a clock supplied to the evaluation MCU by the Emulator tab in the Init dialog box of the emulator debugger. Table 2.2 lists the factory-settings of each clock supply when you install the emulator debugger.

Table 2.2 Clock Supply to the MCU

Clock	Display of emulator debugger	Description	Default setting
Main (X _{IN} -X _{OUT})	Internal	Internal oscillator circuit of emulation pod (OSC-3: 16.0 MHz or OSC-2)	Yes
	External	User system	-
Sub (X _{CIN} -X _{COU} T)	Internal	Internal oscillator circuit of emulation pod (32.768 kHz)	-
	External	User system	Yes

IMPORTANT

Note on Changing the Clock Supply:

- The clock supply can be set in the Init dialog box when starting up the emulator debugger or inputting CLK command on the script window.
- For pins X_{CIN}-X_{COU}T, it is necessary to set the switches in the emulation pod. For details, refer to "2.9.4 Switch Settings" (page 42)

(2) Using the Internal Oscillator Circuit Board

An oscillator circuit board for 16.0 MHz (OSC-3) is mounted on this product. Also the oscillator circuit board (OSC-2) is attached to change the oscillation frequency. When you use an internal oscillator circuit as a main clock, "Internal" can be set by the emulator debugger.

(3) Replacing Oscillator Circuit Boards

Figure 2.16 shows how to replace the oscillator circuit boards. For the position of the oscillator circuit board, see Figure 2.15.

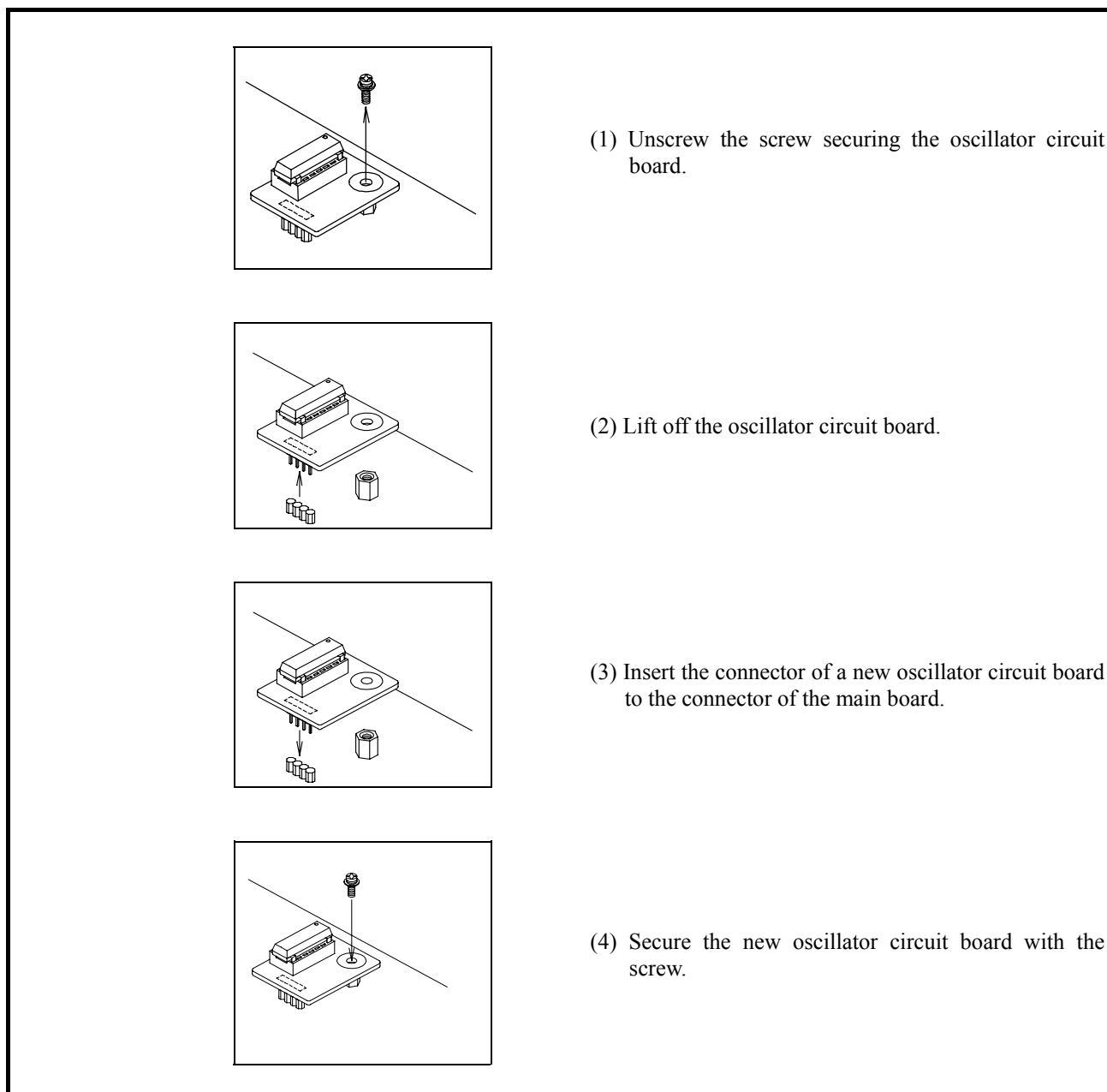

Figure 2.16 Replacing oscillator circuit boards

⚠ CAUTION

Note on Replacing the Oscillator Circuit Board:



- Always shut OFF power when removing the upper cover or replacing oscillator circuit board. Otherwise, internal circuits may be damaged.

(4) Changing the Internal Oscillator Circuit of the Emulation Pod

To use the emulation pod at a desired frequency, build the desired oscillator circuit on the included OSC-2 oscillator circuit board (bare board). Figure 2.17 shows an external view of the OSC-2 oscillator circuit board (bare board) and where connector pins are located. Figure 2.18 shows the circuitry of the OSC-2 oscillator circuit board (bare board). Use the number of oscillator circuits recommended by the oscillator manufacturer.

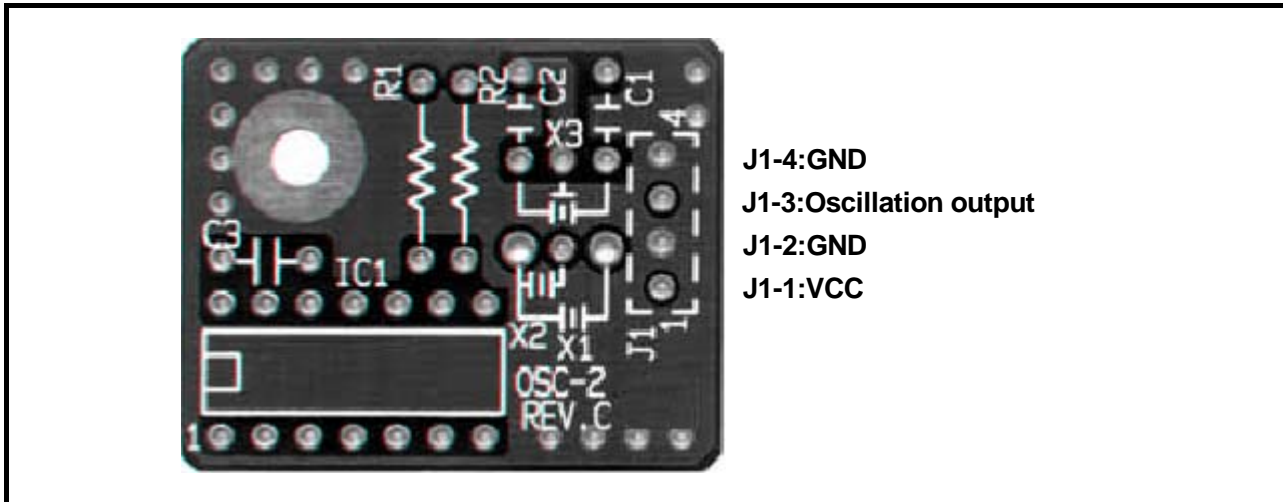

J1-4:GND
 J1-3:Oscillation output
 J1-2:GND
 J1-1:VCC

Figure 2.17 External view of the OSC-2 oscillator circuit board and its connector pin positions

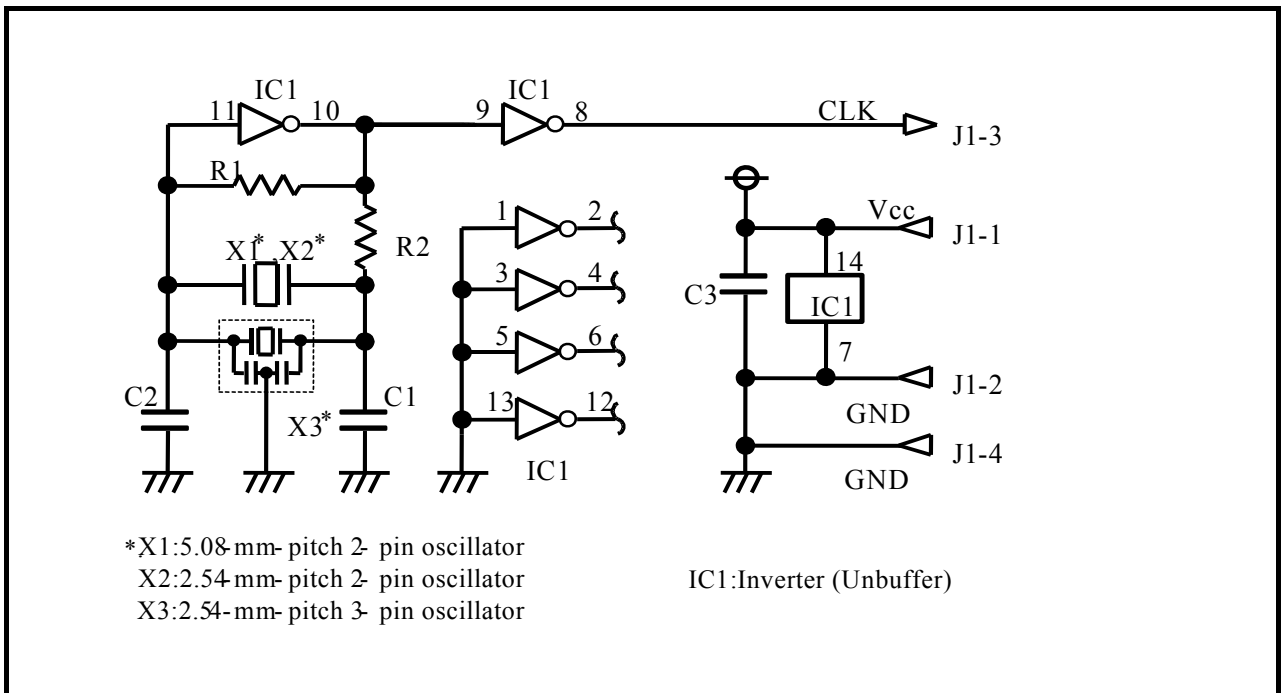

Figure 2.18 Circuits of the OSC-2 oscillator circuit bare board

(5) Using the Oscillator Circuit on the User System

To operate this product with an external clock, construct the oscillator circuit as shown in Figure 2.19 in the user system and input the oscillator output at 50% duty (within the operating range of the evaluation MCU) into pin X_{IN} . And pin X_{OUT} should be open. Choose "External" in the emulator debugger to use this clock.

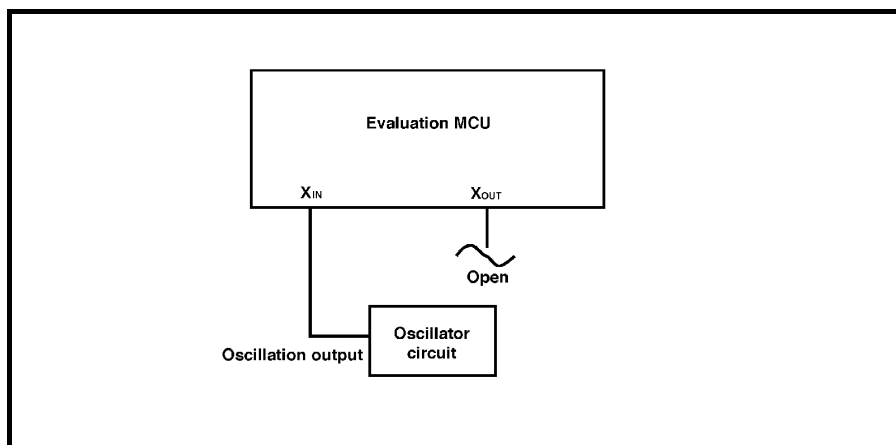

Figure 2.19 External oscillator circuit

Make note that in the oscillator circuit shown in Figure 2.20 where a resonator is connected between pins X_{IN} and X_{OUT} , oscillation does not occur because a flexible cable, buffer IC and other devices are used between the evaluation MCU and the user system. It is same for sub-clock oscillator circuits (X_{CIN} and X_{COUT}).

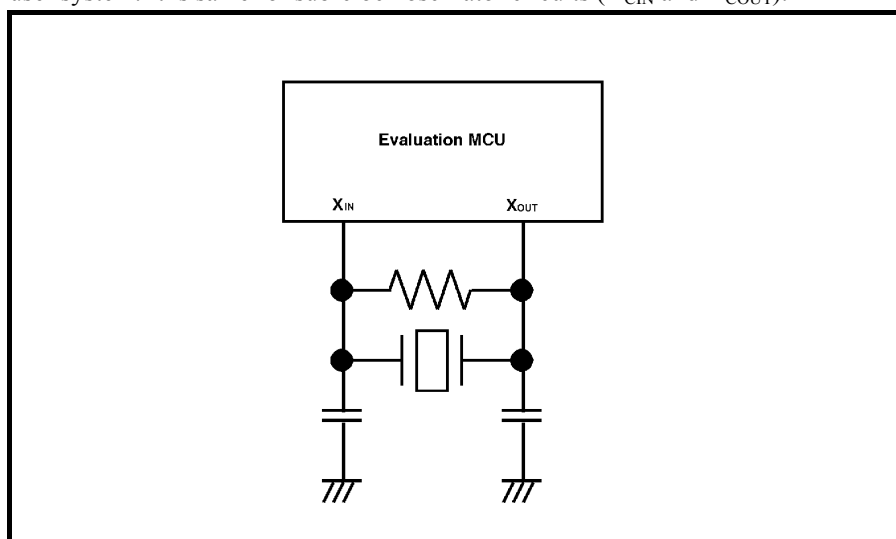

Figure 2.20 Circuit in which oscillation does not occur

2.9.4 Switch Settings

Here follows explanations of the switches of the emulation pod. Set the switches according to the user system.

Tables 2.3 and 2.4 list how to set toggle switches SW1 to SW5 of the M306H7T3-PRT board (MCU-dependent). Tables 2.5 and 2.6 list how to set jumper switches JP1 to JP7 on the M306H7T3-PRT (MCU-dependent board). For the positions of the switches, see Figure 2.15.

(1) Toggle Switches SW1 to SW5 on the M306H7T3-PRT Board (MCU-dependent)

Table 2.3 Switch settings of the M306H7T3- PRT (1)







Signal	Switch	Setting	Description
START	SW1	 L OPEN H	Xin-Xout is selected as an operation clock after releasing reset. (Factory-setting)
		 H OPEN L	Does not pull up/down pin START of the MCU. Be sure to use this setting when the user system is connected.
		 H OPEN L	Xcin-Xcout is selected as an operation clock after releasing reset.
CNVSS	SW2	 L OPEN H (Factory-setting)	Pulls down pin CNVSS of the MCU with a resistance of 1 kΩ. Be sure to use this setting when the user system is not connected. (Factory-setting)
		 L OPEN H	Does not pull up/down pin CNVSS of the MCU. Be sure to use this setting when the user system is connected.
		 L OPEN H	Do not use this setting.
P87/Xcin	SW3	 P87 Xcin (Factory-setting)	When using the P87/Xcin of the MCU as a port P87 function (Factory-setting)
		 P87 Xcin	When using the P87/Xcin of the MCU as a port Xcin function
Xout	SW4	 OPEN Xout	Does not connect pin Xout of the MCU to the user system.
		 OPEN Xout	Connects pin Xout of the MCU to the user system. (Factory-setting)

Table 2.4 Switch settings of the M306H7T3- PRT (2)

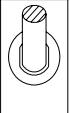
Signal	Switch	Setting		Description
P86/Xcout	SW5		P87 Xcout Xcin	Connects pin P86/Xcout of the MCU to the user system. (Factory-setting)
			P87 Xcin	Does not connect pin P86/Xcout of the MCU to the user system.

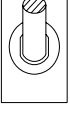
⚠ CAUTION

Note on Switch Settings:

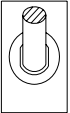
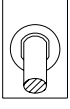
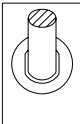
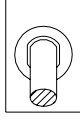

- Always shut OFF power before changing switch setting. Otherwise, internal circuit board may be damaged.

IMPORTANT

Note on START and CNVSS Switch Settings:

- Switch settings of the START and CNVSS are for debugging without the user system connected.

(2) Jumper Switches JP1 to JP7 on the M306H7T3-PRT Board (MCU-dependent)

Table 2.5 Switch settings of the M306H7T3- PRT (3)









Signal	Switch	Setting of jumper switches	
SYNCIN	JP1	FLX  INT Connects pin SYNCIN to internal circuit of the M306H7T3-PRT.	FLX  INT Connects pin SYNCIN to the user system via the M3T-FLX160C. (Factory-setting)
CVIN	JP2	FLX  INT Connects pin CVIN to the user system via the M3T-FLX160C.	FLX  INT Connects pin CVIN to the user system via the M3T-FLX160C. (Factory-setting)
VCCOFF	JP3	FLX  INT Pin VCCOFF is to fixed to high..	FLX  INT Connects pin VCCOFF to the user system via the M3T-FLX160C. (Factory-setting)

Table 2.6 Switch settings of the M306H7T3- PRT (4)

Signal	Switch	Setting of jumper switches	
VCC1	JP4	 <p>Connects pin VCC1 of the MCU to the internal power supply of pod (equipotential of VCC2).</p>	 <p>Connects pin VCC1 of the MCU to the user system. Be sure to use this setting when the potentials of VCC1 and VCC2 are different. (Factory-setting)</p>
VDDA _{na}	JP5	 <p>Do not use this setting.</p>	 <p>Be sure to use this setting. (Factory-setting)</p>
JC1_R	JP6	 <p>Does not pull down video input signal (RCA connector).</p>	 <p>Pulls down video input signal (RCA connector) with a resistance of 75 Ω (Factory-setting)</p>
TVDD	JP7	 <p>Do not use this setting.</p>	 <p>Be sure to use this setting. (Factory-setting)</p>

⚠ CAUTION

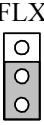
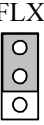
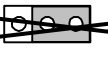
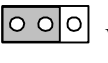
Note on Switch Settings:

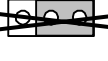
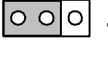

- Always shut OFF power before changing switch setting. Otherwise, internal circuit board may be damaged.

2.9.5 Installing and Removing Network Resistors for Pullup

In this product, you cannot control pullup for ports P0 to P5 by pullup control registers (pullup control register read/write are possible).

A socket for installing the network resistor for pullup is mounted in this product. Mount the 51 k Ω network resistor supplied with this product to the port for which pullup control is required. For the mounting location, refer to Figure 2.21 below. And for the positions of each part, refer to Figure 2.15.

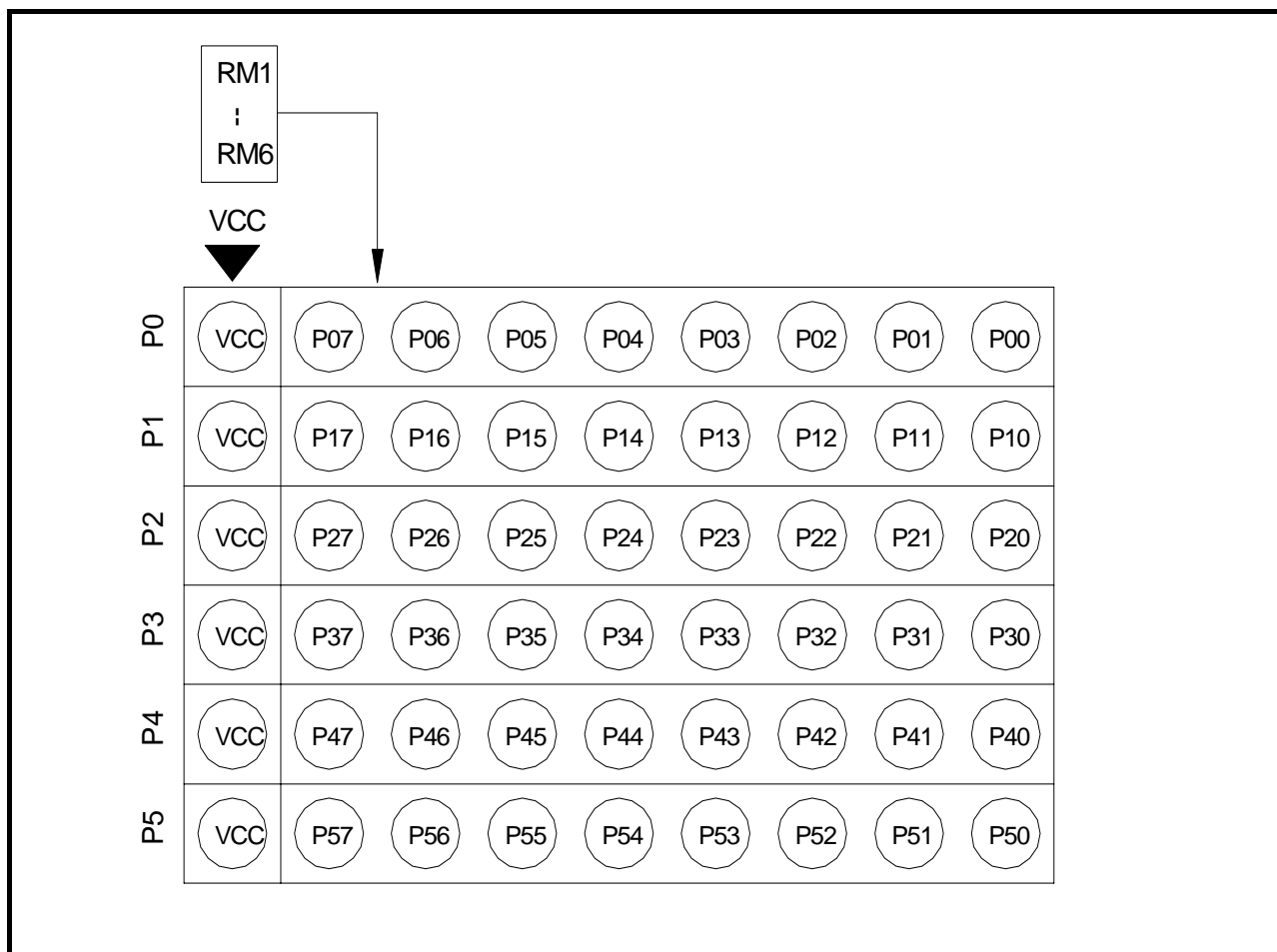

Figure 2.21 Position for mounting network resistors for pullup

CAUTION

Note on Installing and Removing Network Resistors for Pullup:



- Always shut OFF power before installing or removing network resistors for pullup. Also install network resistors for pullup properly. Otherwise, internal circuit board may be damaged.

2.9.6 Bypass Capacitors for A/D Converter

The M306H7T3-RPD-E has the M306H7T3-PRT board which has a foot pattern for installing bypass capacitors for A/D converter near the MCU and premounted 0.1 μ F capacitors. Mount suitable bypass capacitors as occasion demands. Figure 2.15 shows where they are installed and Figure 2.22 shows their connection.

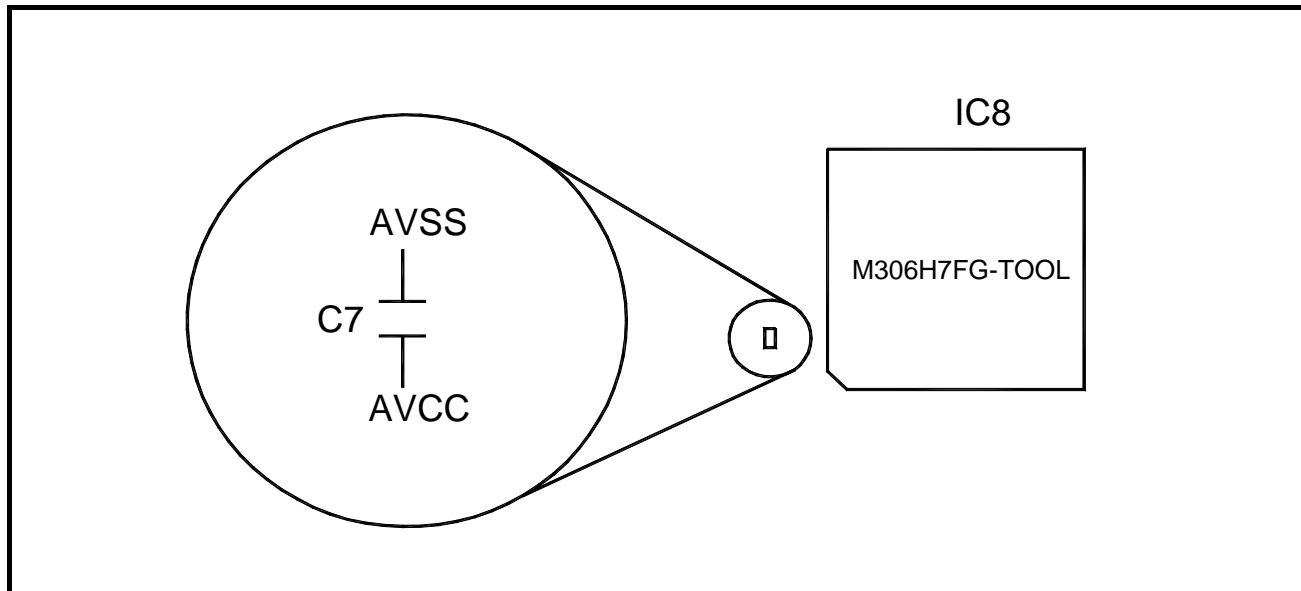

Figure 2.22 Foot patterns of bypass capacitors for A/D converter

IMPORTANT

Note on the A/D Converter Function:

- Because a flexible cable and other devices are used between the evaluation MCU and the user system, the A/D converter operates differently from that of the actual MCU. Make the final evaluation of the A/D converter with the actual MCU.

2.9.7 Connection Diagram of Data Slicer

This product has on-board sockets to change parts used for circuits connected to a data slicer. The circuit and the arrangement of the parts used for each circuit are shown in Figure 2.23 and Figure 2.24, respectively.

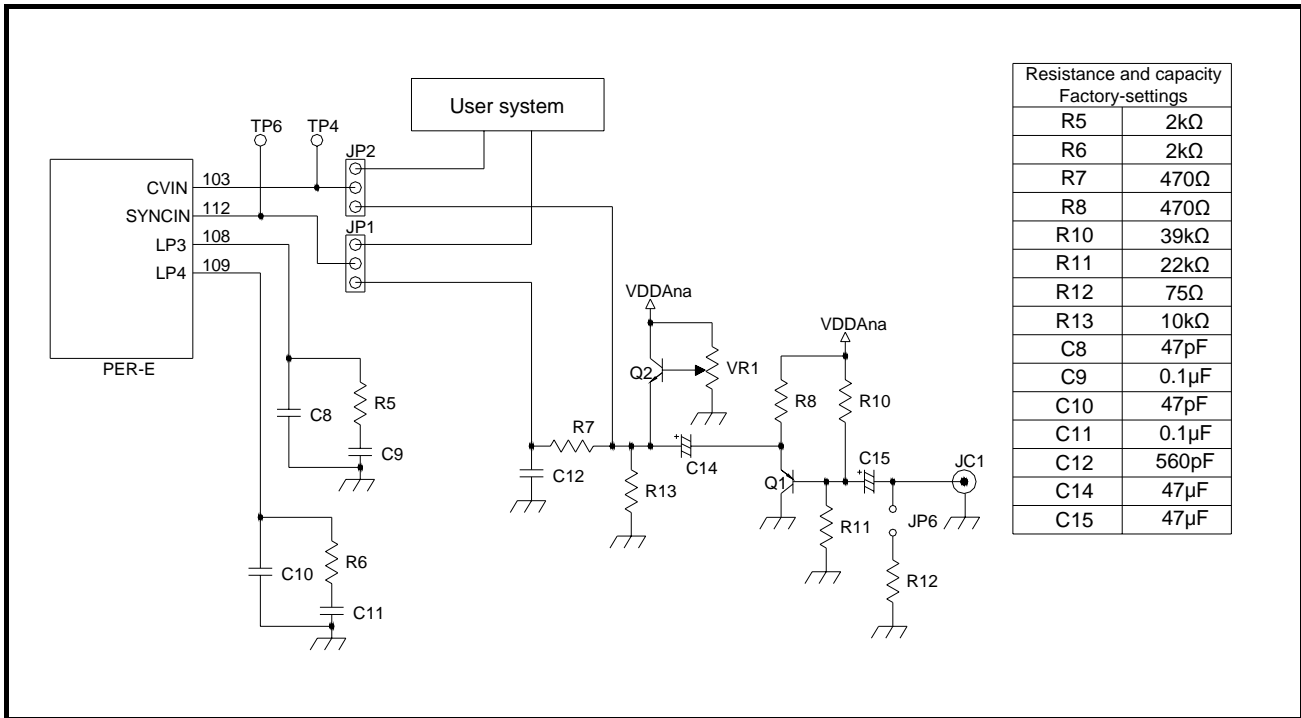

Figure 2.23 Connection diagram of circuits connected to the data slicer

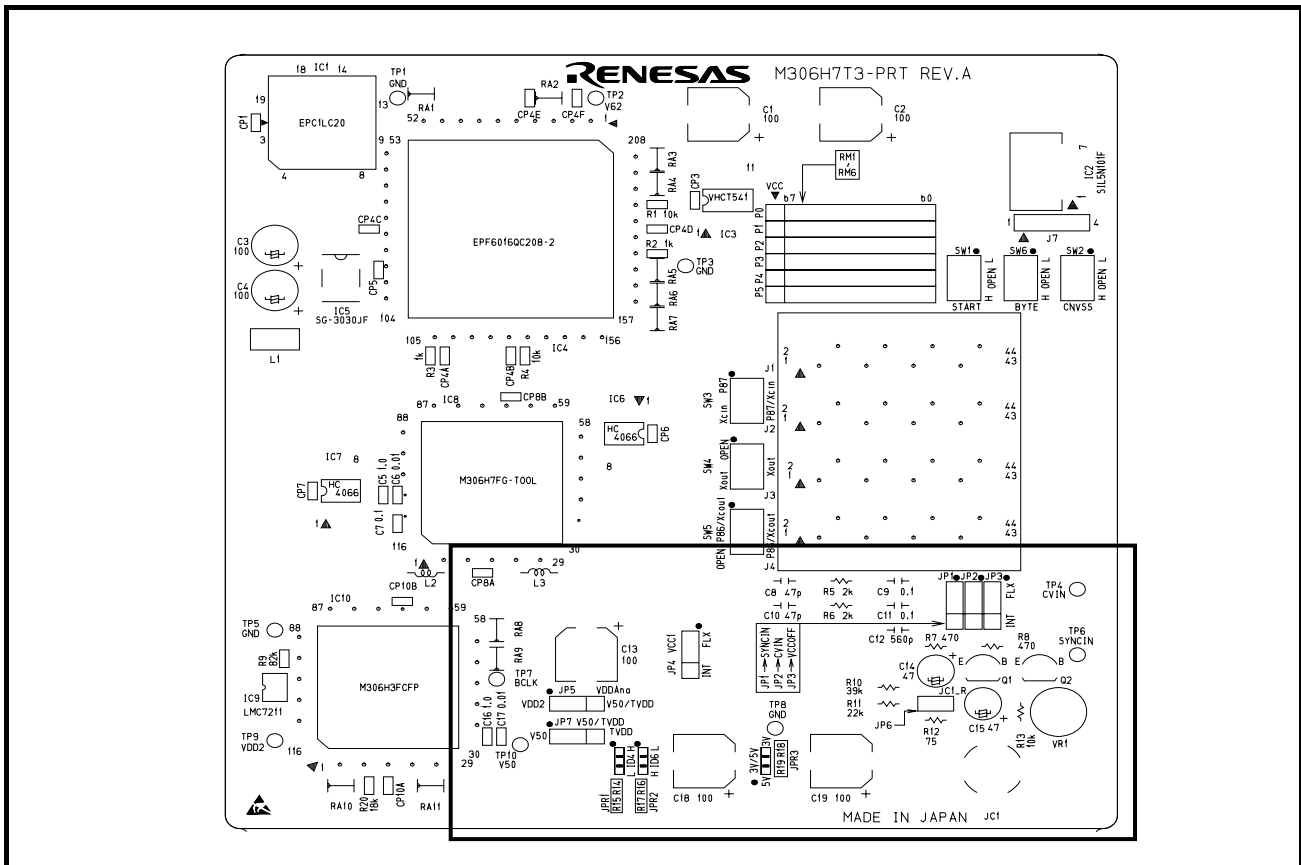

Figure 2.24 Arrangement of the parts used for each circuit

3. Usage (How to Use the Emulator Debugger)

This chapter describes how to start up the M16C PC4701 emulator debugger from the High-performance Embedded Workshop and how to use the main windows.

3.1. Making an MCU File

It is necessary to make an MCU file to use this product with the emulator debugger. According to the MCU you use, change the contents of the MCU file. Make the MCU file named "M306H7T3.MCU" etc. following the description below using a text editor and store it in the "mcufiles" folder in the directory where the emulator debugger is installed.

The emulator debugger has been installed in the following directory by default.

- When using the M16C PC4701 emulator debugger on the High-performance Embedded Workshop
C:\Program Files\Renesas\Hew\Tools\Renesas\DebugComp\Platform\PDTarget\PD30\McuFiles
- When using the M3T-PD30
C:\mtool\PD30\McuFiles

The MCU file contains information such as, SFR area, internal RAM area, internal ROM area, firmware file name. The contents of the MCU file when using the M306H7FGFP (8KB RAM, 256KB ROM) are as follows:

0	:	SFR area	Start address
3FF	:		End address
400	:	Internal RAM	Start address
23FF	:		End address
C0000	:	Internal ROM	Start address
FFFFFF	:		End address
M30620P	:	Name of firmware	(Do not change.)
0	:	Expansion No.	(Do not change.)

3.2 Setting the Work Area

With this product, the emulator uses 54 bytes as a work area in emulation memory. With this product, set the work area address at 10000h.

The area used as a work area (54 bytes) is specified in the Work Area tab of the INIT dialog box of the emulator debugger. And be sure to set the MAP setting of the specified work area (54 bytes of 10000h to 10036h) as MAP=INT.

3.3 Starting Up the Emulator Debugger

When debugging the completed programs, switch the session. The session can be changed by the drop down list of the tool bar shown below.



You will have as many sessions created as the number of targets you selected when creating a project, so select the session that corresponds to the target to be connected from the drop-down list. Select "SessionM16C_PC4701_Emulator"

3.3.1 Init Dialog Box

After specifying the session, an Init dialog box to connect the target is displayed.

The Init dialog box is used to set the items that need to be set when the emulator debugger starts up. The contents set in this dialog box remain effective the next time you start the debugger.

(1) MCU tab

1) Specifying the MCU file

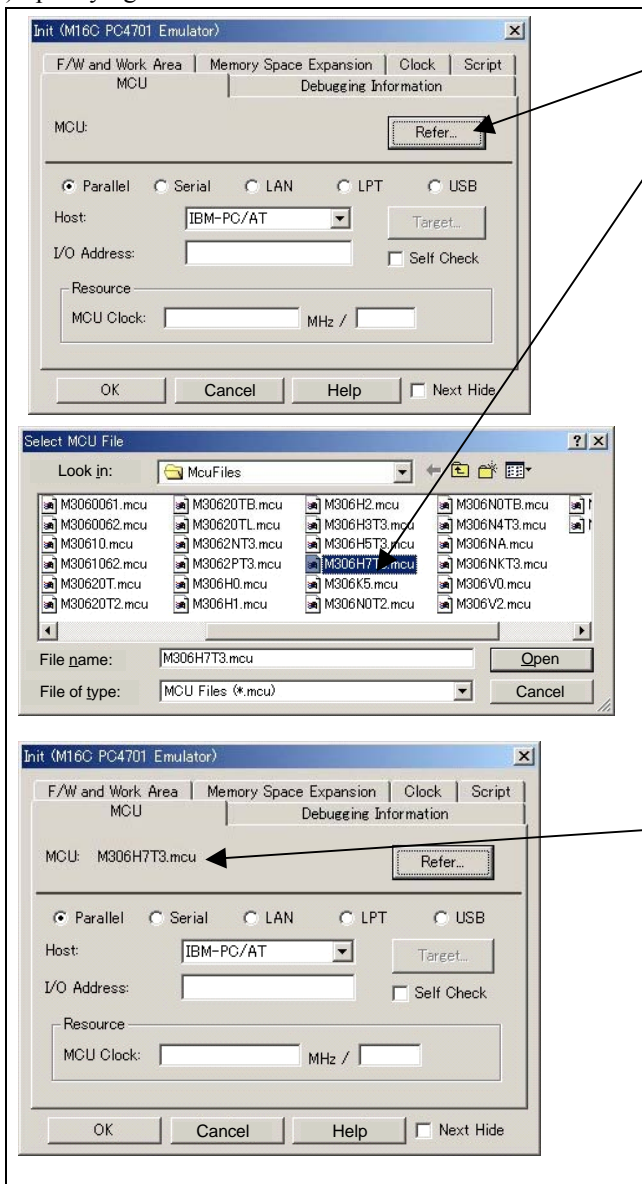

Specifying the MCU file
Specify the MCU file for the target MCU.

- (1) Click the "Refer..." Button".
- (2) "Select MCU File" dialog box will be displayed. Specify the MCU file for the target MCU.

- The MCU file contains the information specific to the target MCU.

- The specified MCU file is displayed at the MCU area field of MCU tab.

2) Specifying the communication interface

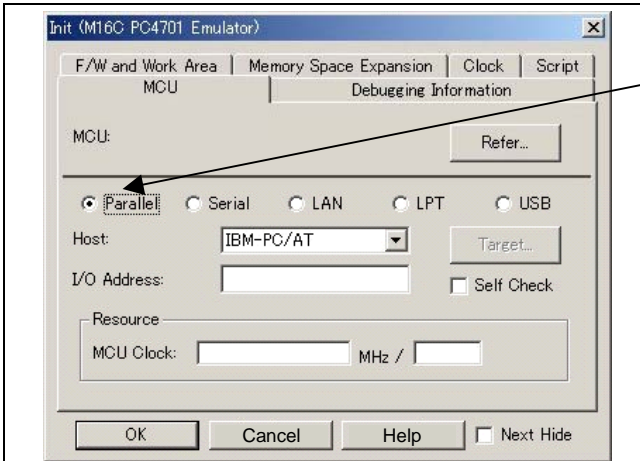

Specifying the communication interface (Parallel communication)

- In case where the parallel communication is set up, click the radio button “Parallel” of MCU tab.
- For the host area, only IBM-PC/AT can be designated.
- Set the I/O address value that was set up with the special interface board PCA4202G02 to the I/O address area.
- Input the I/O address in hexadecimal
- For I/O address setting of PCA4202G02, refer to the “PCA4202G02 Instruction Manual”.

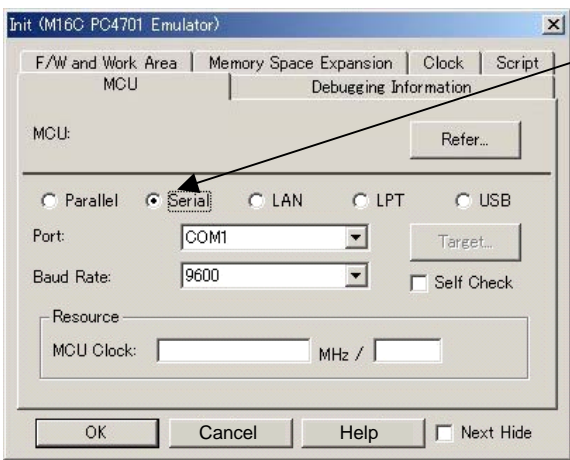

Specifying the communication interface (Serial communication)

- For connection with serial communication, click the radio button “Serial” of MCU tab.
- Specify the communication port of serial interface used to the port area and the baud rate to the baud rate area.

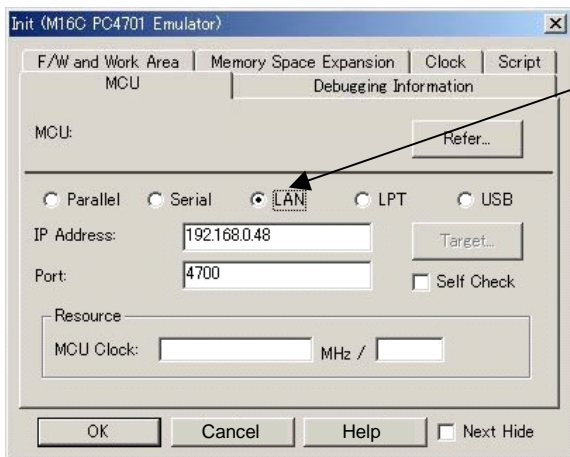

Specifying the communication interface (LAN communication)

- For selecting the LAN communication, click the radio button “LAN” of the MCU tab.
- Specify the IP address of the emulator to the IP address area.
- Specify the IP address of the emulator at the IP address area. Specify the IP address by one byte of decimal number separating each four bytes with a period.
- Specify the port number at the Port area.

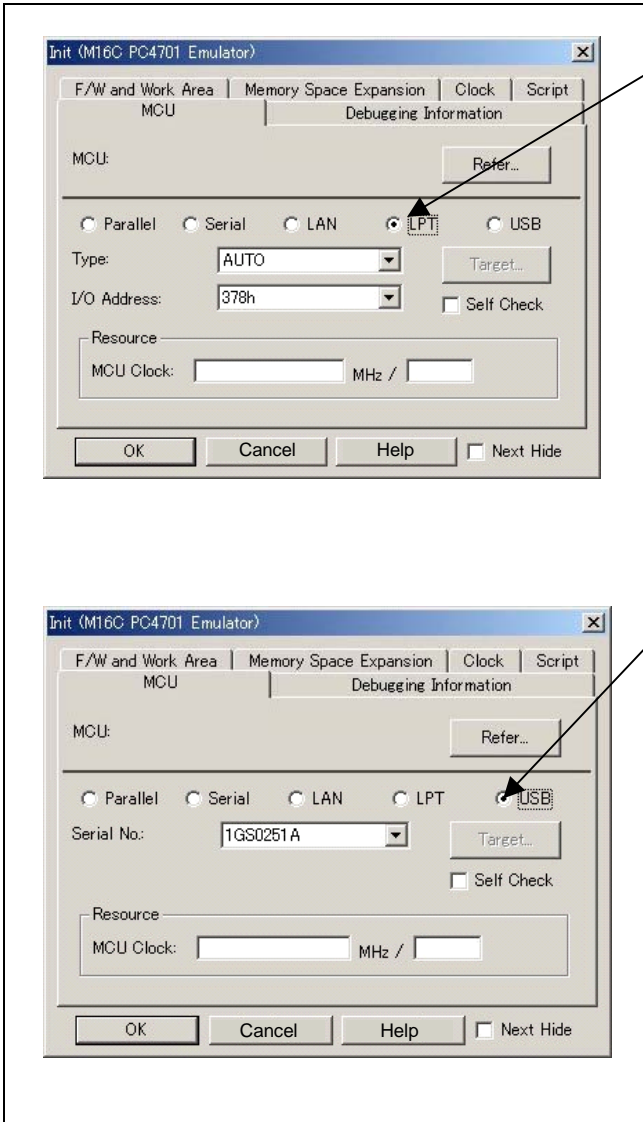

Specifying the communication interface (LPT communication)

- For selecting the LPT communication, click the radio button “LPT” of the MCU tab.
- For the Type area, specify the LPT interface communication mode to be used.
- Specify the I/O address of the parallel port at the I/O address area.
- For BIOS setup, the following addresses are available.
 - 378h
 - 278h

Specifying the communication interface (USB communication)

- For selecting the USB communication, click the radio button “USB” of the MCU tab
- The emulators connected by USB cable are shown at Serial No. area. Select the serial No. of the emulator you are going to connect.
- Select the serial No. of the emulator you are going to connect.

3) Executing the self-check

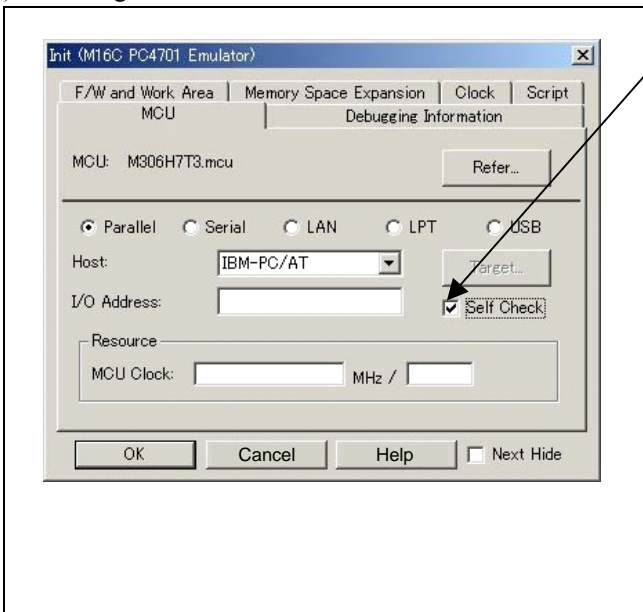

Executing the self-check

Enable this function when you want the emulator to be self-checked at startup. Be sure to select the check box only when you want the emulator to be self-checked at startup.

Note:

In case where self-checking was normally completed, terminate the emulator debugger once, then start operation with no self-checking carried out again (with leaving the check box unchecked).

This function may be enabled in the following cases:

- When you are using the emulator you have just purchased, and fail to download the firmware.
- When you successfully download the firmware, but fail to start up the emulator
- When you want to confirm whether the emulator is operating normally because, for example, the MCU runs out of control or something is wrong with the trace results

This function can be enabled only when you are starting up the emulator debugger.

4) Specifying the clock frequency

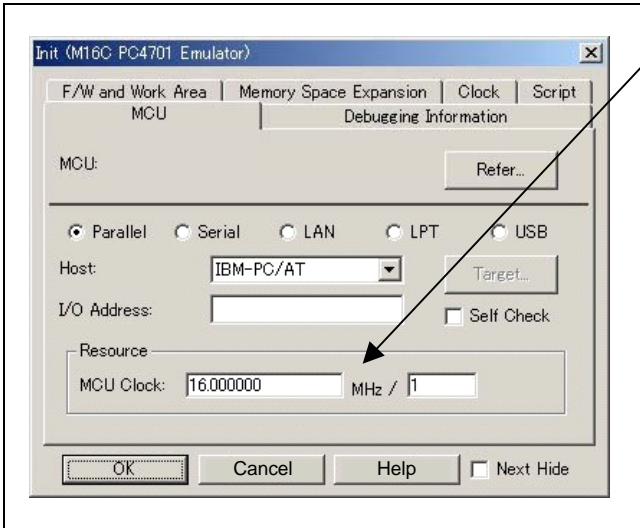

Specifying the clock frequency
 Specify the target MCU operation clock and clock dividing ratio.

- Specify the operation clock and clock dividing ratio.
- In case where no value was set up in the area in which the operation clock is Specified, the unit operates with the reference clock (16 MHz) inside the emulator (PC4701) as time measurement resource.
- In case where no value was set up in the area in which the dividing ratio is Specified, the unit operates as "No dividing". (Same as when "1" was Specified.)

(2) Debugging Information tab

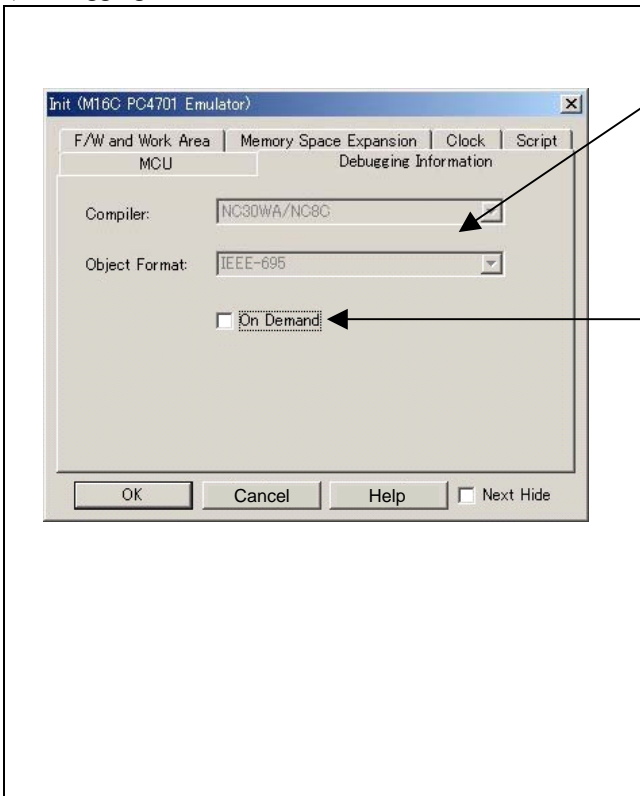

Referencing the compiler used and the object format
 Reference the compiler you are using and the format of the object file output by the compiler.
 To make this setting, use the dialog box that is brought up by selecting [Debug] and then [Debug Settings...] from the menu.

Specifying the method for storing debug information
 There are two methods for storing debug information: on memory method and an on demand method.
 Select the compiler you are using.
 (By default, the on memory is selected)
 When selecting the on demand method, check the [On Demand] check box.

- On Memory
 The debug information is stored in the memory of your computer. This method is suitable when the size of the load module (user program) is small.
- On Demand
 The debug information is saved to a reusable temporary file. When you download the same load module for a second time on, the saved debug information will be reused and the load module can therefore be downloaded fast. This method is suitable when the size of the load module (user program) is large.

(3) Work area tab

1) Specifying the firmware

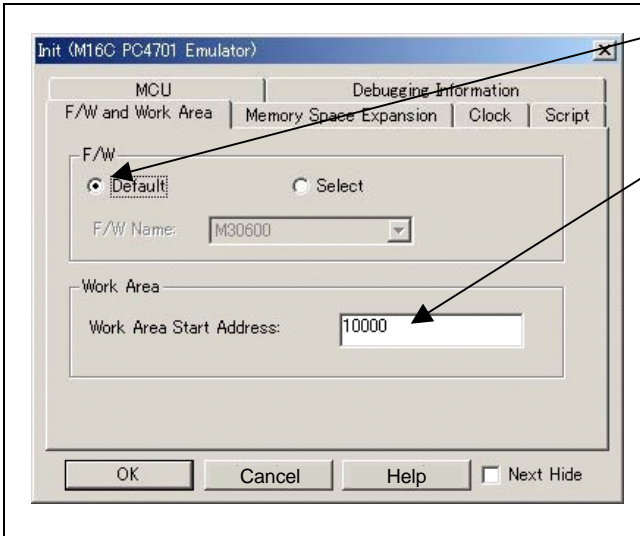

Specifying the firmware file
For the radio button of the firmware group box, be sure to click “Default”.

Specifying the work area
Specifies the top address which is used as a work area at the start address area of the work area group box.
- With the M306H7T3-RPD-E, set the work area address at 10000h.
- The top address of the work area is set to 2C00h by default.

(4) Memory space expansion tab

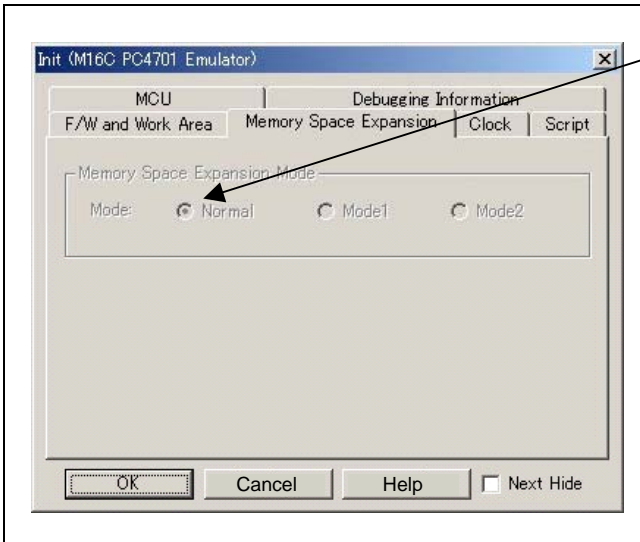

Specifying the memory space expansion mode
Because the M306H7T3-RPD-E supports single-chip mode, only the radio button “Normal” can be selected.

(5) Clock tab

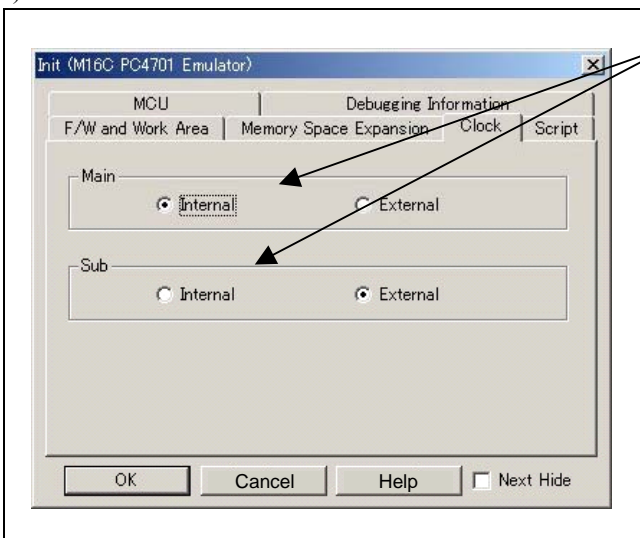

Specifying the target clock
Specify the clock sources supplied to the MCU (main clock and sub clock). Select the appropriate clock sources according to the clock used by your target MCU.
● Internal
Emulator's internal clock
● External
User system clock

(6) Script tab

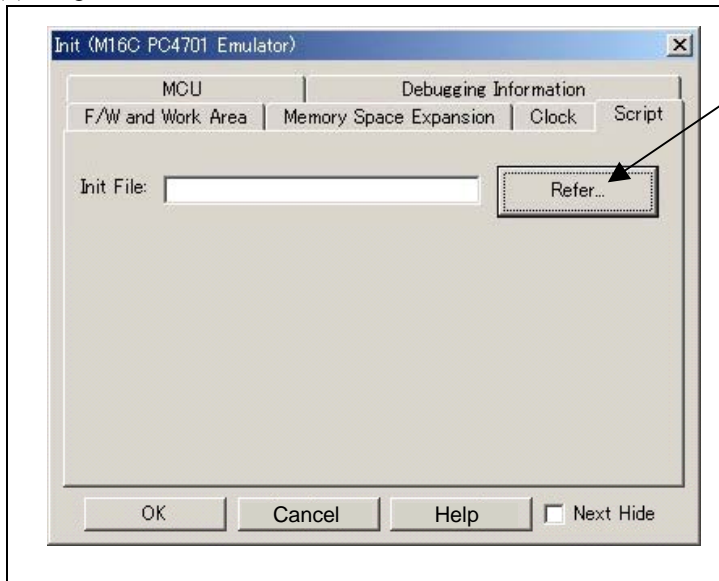
**Automatically executing a script command**

To automatically execute a script command when starting up the debugger, click the “Refer...” button and specify the script file to be executed.

Clicking the “Refer...” button brings up a file selection dialog box. The script file you have selected is displayed in the Init File: section of the dialog box shown here. If you do not want to automatically execute a script command, delete the character string displayed in the Init File: section of the dialog box.

What you specify here is reflected at only startup. If you specify back again in the Init dialog box after startup, whatever you specified has no effect (restart the emulator debugger).

When the tab settings (1) to (6) above are completed, click OK button.

3.3.2 Checking Connections of the Emulator System

Check to see that the emulator debugger has been connected correctly to the emulator.

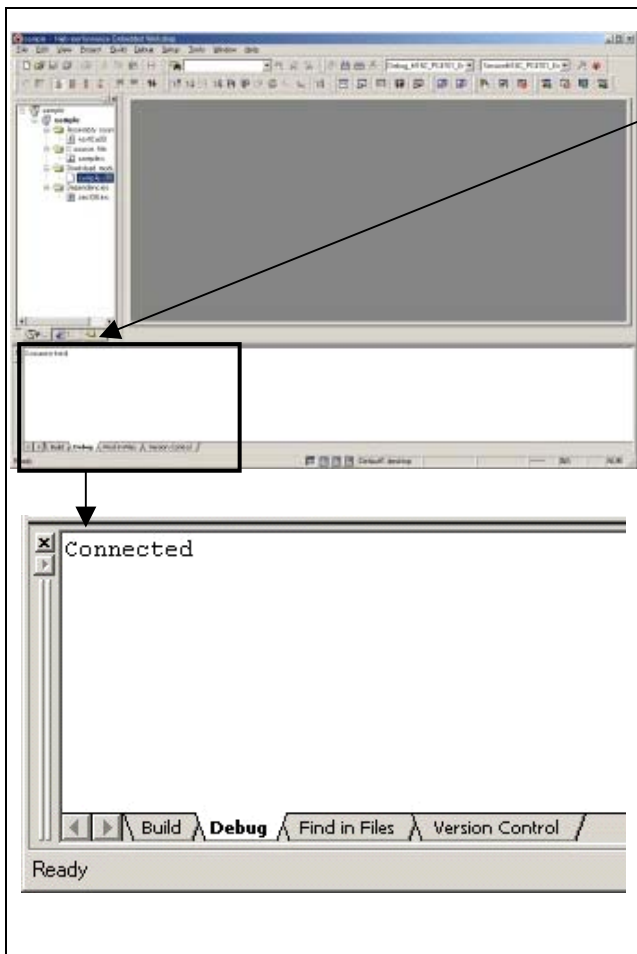

Checking connections of the emulator system

When the emulator debugger is connected correctly to the emulator after you have finished setting up the Init dialog box and the MCU Setting dialog box, you will see a message "Connected" displayed on the "Debug" tab of the Output window.

3.4 Downloading Program

Download the user program to be debugged.

1) Downloading from the work space window

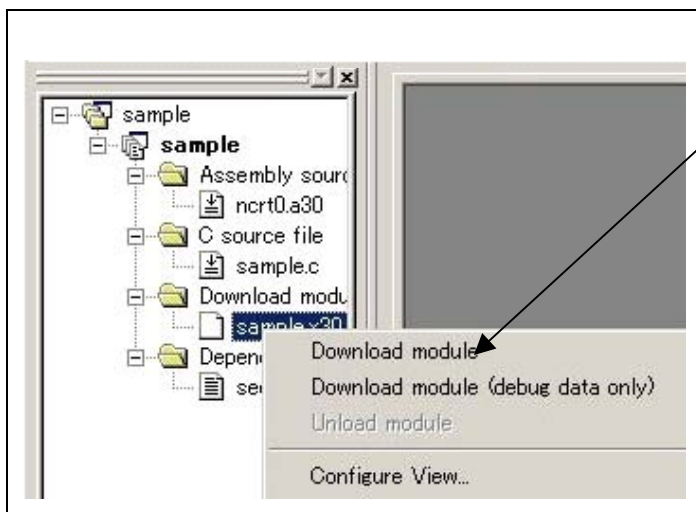

Downloading the program

Download the object program you want to debug.

Select Download from “xxx.x30” of “Download module”.

Or you can select “Download” from the “Debug” menu for the same effect.

2) Showing the source program

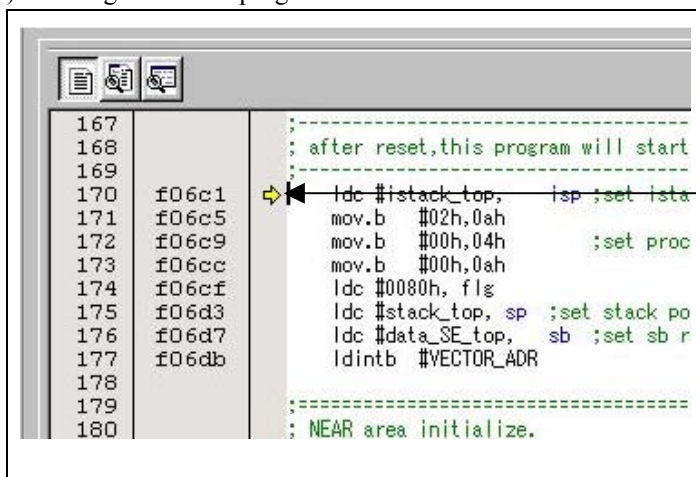

Editor (Source) window

The editor (source) window is a window that always shows the content of the source file corresponding to the current position of the program counter (hereafter, PC).

The position of the PC at which the user program has stopped is marked by a yellow arrow.

The operation up to the cursor position can be executed, and the software break point can be set up and reset, etc.

3.5 Program execution

(1) Program execution

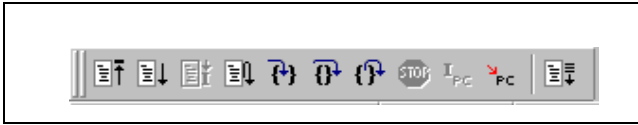

CPU reset

Resets the target MCU.

Go

Runs the program beginning with the current PC position.

Reset Go

Runs the program after resetting the target MCU.

Step In

Single-steps the program executing each statement (including those in functions).

Step Over

Single-steps the program executing each function call as one step.

Step Out

Exists a function and stops at a statement in the program next to the one that called the function.

STOP

Stops the program.

Go Free

Runs the program beginning with the current PC position. The software and hardware breaks set in it are temporarily ignored.

(2) Software break

1) Setting the software break point

```

167      ;
168      ; after reset, this program will start
169      ;
170  f06c1  ldc #istack_top,  isp ;set isp
171  f06c5  mov.b #02h,0ah
172  f06c9  mov.b #00h,04h      ;set pi
173  f06cc  mov.b #00h,0ah
174  f06cf  ldc #0080h, flg
175  f06d3  ldc #stack_top, sp ;set stack
176  f06d7  ldc #data_SE_top, sb ;set sb
177  f06db  ldintb #VECTOR_ADR
178
179      ;
180      ; NEAR area initialize.
181      ;

```

Execution setup procedure with software break:

(1) By double-clicking the break point setting line on the software break point setting column in the editor (source) window, the break point can be set up and released. (In this case, the red circle is displayed on the setting line as shown in the window on the left.)

(2)  Click the execution button.

2) Execution completed with software break

```

167      ;
168      ; after reset, this program will start
169      ;
170  f06c1  ldc #istack_top,  isp ;set isp
171  f06c5  mov.b #02h,0ah
172  f06c9  mov.b #00h,04h      ;set pi
173  f06cc  mov.b #00h,0ah
174  f06cf  ldc #0080h, flg
175  f06d3  ldc #stack_top, sp ;set stack
176  f06d7  ldc #data_SE_top, sb ;set sb
177  f06db  ldintb #VECTOR_ADR
178
179      ;
180      ; NEAR area initialize.
181      ;

```

The cursor stops in the position where the software break was set up.
The statement in which the software break was set up is not executed.

(3) Executing up to the cursor position (Come command)

1) Specifying the Come command

```

60      ;-----;
61      ; Initialize Macro declaration
62      ;-----;
63      N_BZERO .macro TOP_,SECT_
64      f0039      mov.b    #00H, R0L
65      f003a      mov.w    #(TOP_ & 0FFFFH), A1
66      f003d      mov.w    #sizeof SECT_ , R3
67      f0041      sstr.b
68      .endm
69
70      N_BCOPY .macro FROM_,TO_,SECT_
71      f0061      mov.w    #(FROM_ & 0FFFFH),A0
72      f0064      mov.b    #(FROM_ >>16),R1H
73      f0067      mov.w    #TO_ ,A1
74      f006a      mov.w    #sizeof SECT_ , R3
75      f006e      smovf.b
76      .endm
77
    
```

Setup procedure for executing COME command

- (1) Click the line in the editor (source) window at which you want the program to execute.
- (2)  Click the Come button.

2) After the Come command has finished

```

60      ;-----;
61      ; Initialize Macro declaration
62      ;-----;
63      N_BZERO .macro TOP_,SECT_
64      f0039      mov.b    #00H, R0L
65      f003a      mov.w    #(TOP_ & 0FFFFH), A1
66      f003d      mov.w    #sizeof SECT_ , R3
67      f0041      sstr.b
68      .endm
69
70      N_BCOPY .macro FROM_,TO_,SECT_
71      f0061      mov.w    #(FROM_ & 0FFFFH),A0
72      f0064      mov.b    #(FROM_ >>16),R1H
73      f0067      mov.w    #TO_ ,A1
74      f006a      mov.w    #sizeof SECT_ , R3
75      f006e      smovf.b
76      .endm
77
    
```

The cursor stops in the position where the come command was executed.
 The statement specified with the come command is not executed.

3.6 Hardware Break

Hardware break is set by event condition such as FETCH or DATA ACCESS, etc. The program stops after executing the instruction at the set breakpoint (after several cycles).

(1) Break event setup dialog box

1) Opening the hardware break point setup dialog box

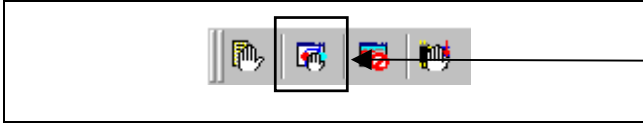

Hardware Break Point
Clicking this button opens the hardware break point setup dialog box.

2) Hardware Break Point Setting Window in initial state

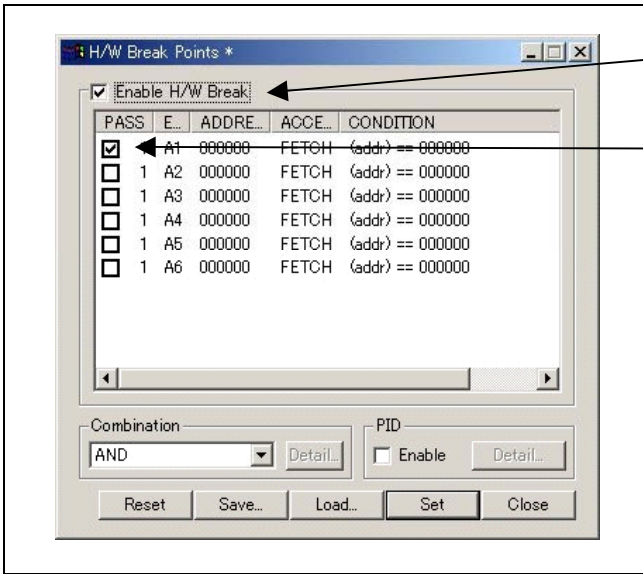

Hardware break point Setting Window in initial state
Select the "Enable H/W Break" check box, and this break function will be enabled, allowing you to set hardware break points.

Setting Break Event
Click the event line at which you want set a break event.

3) Break event setting dialog box

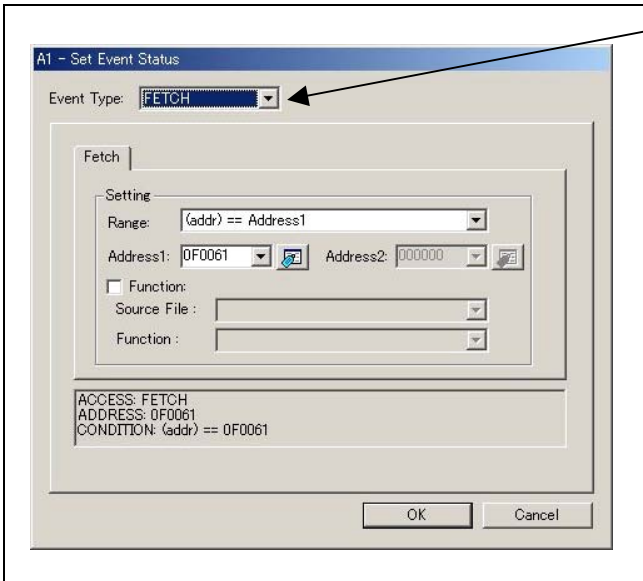

Specifying the event type
Click to select the event type you want to set.

- FETCH
Detects an instruction prefetch.
- DATA ACCESS
Detects a memory access.
- BIT ACCESS
Detects a bit access.
- INTERRUPT
Detects an occurrence of interruption or interrupt completion.
- TRIGGER
Detects a signal from the external trace signal input cable.

(2) When FETCH is selected

1) Window for setting addresses

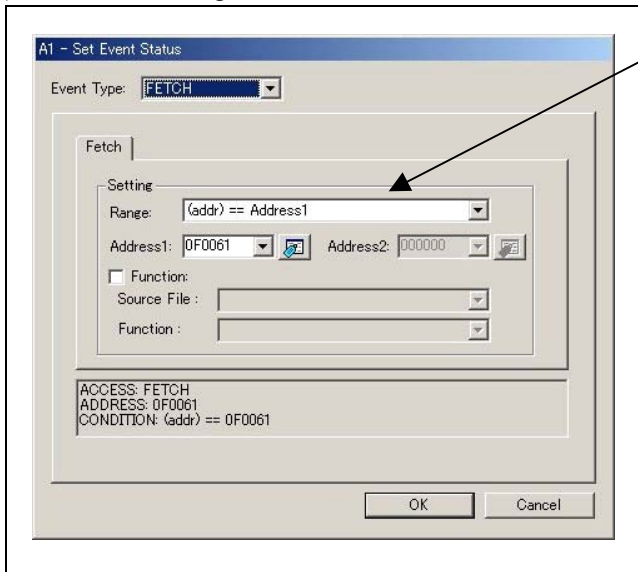

Setting the address

You can set eight conditions, e.g., a specified address, a specified address range, etc. When you have finished setting the address, click OK.

(3) When DATA ACCESS is selected

1) Window for setting the address

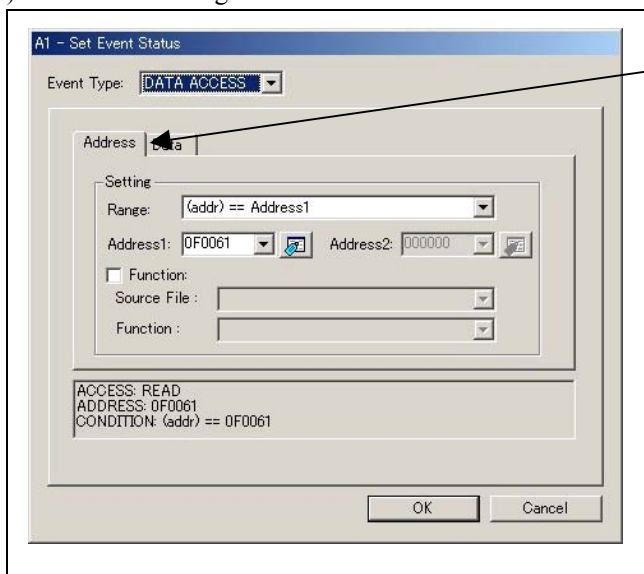

Setting the address

Sets the address by “Address” tab.
 You can set eight conditions, e.g., a specified address, a specified address range, etc.

2) Window for setting data

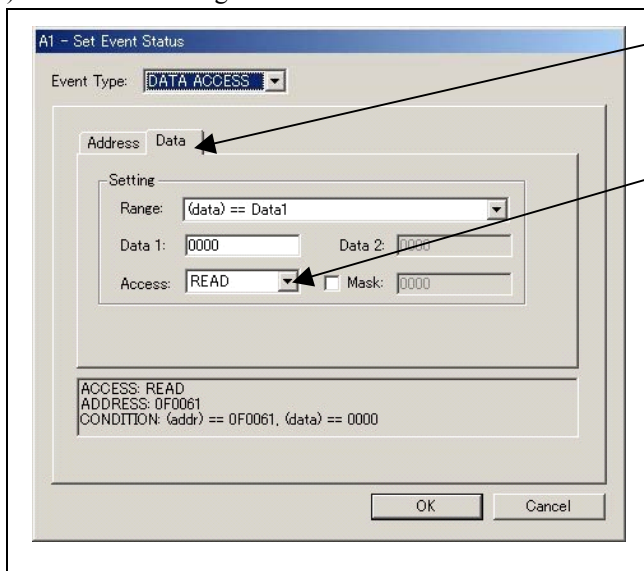

Setting data

Sets the address by “Data” tab.
 You can set eight conditions, e.g., specified data, specified data range, etc.

Setting the access condition

You can set three conditions, e.g., read, write, and read/write. When you have finished setting the data and access condition, click OK.

3) Example Data Settings

Setting events for wordwise accesses to the even-addresses

STE.W A0,20E8h(A0=5423h)

Cycle	Label	Address	Data	BUS	BHE	BIU	R/W	RWT	CPU
-00023		0020E8	5423 16b	0	DW	W	0	CW	

High-order and low-order data effective

Setting events for wordwise accesses to the odd-addresses

STE.W A0,20E5h(A0=AB79h)

Cycle	Label	Address	Data	BUS	BHE	BIU	R/W	RWT	CPU
-00021		0020E5	79AB 16b	0	DW	W	0	CB	
-00020		0020E6	79AB 16b	1	DW	W	0	CB	

Odd-address high-order data effective

Even-address high-order data effective

Setting events for wordwise accesses to the even-addresses

STE.B ROL,[A1A0](ROL=E5h,A1=0000h,A0=20E2h)

Cycle	Label	Address	Data	BUS	BHE	BIU	R/W	RWT	CPU
-00022		0020E2	00E5 16b	1	DB	W	0	CB	

Low-order data effective

Setting events for wordwise accesses to the odd-addresses

STE.B ROL,[A1A0](ROL=E6h,A1=0000h,A0=20E3h)

Cycle	Label	Address	Data	BUS	BHE	BIU	R/W	RWT	CPU
-00022		0020E3	E600 16b	0	DB	W	0	CB	

High-order data effective

Setting a break event.

A1
 Address 1 :0020E8
 Data 1 :5423
 MASK :FFFF
 Access :WRITE

Setting a break event (using 2 events)

A1 A2
 Address 1 :0020E5 Address 1 :0020E6
 Data 1 :7900 Data 1 :00AB
 MASK :FF00 MASK :00FF
 Access :WRITE Access :WRITE
 Set the combinatorial events to AND.

Setting a break event

A1
 Address 1 :0020E2
 Data 1 :00E5
 MASK :00FF
 Access :WRITE

Setting a break event

A1
 Address 1 :0020E3
 Data 1 :E600
 MASK :FF00
 Access :WRITE

(4) Setting the combinatorial event condition for the hardware break point

1) Window for setting the combinatorial event condition

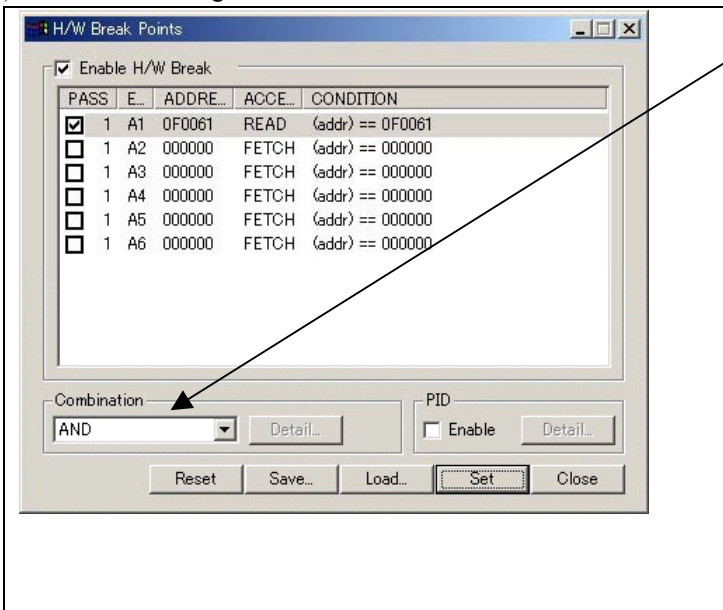

Setting the combinatorial event condition

There are following four conditions that you can choose for the combinatorial events.

- AND
The program breaks when all of the specified events occur.
- AND (Same Time)
The program breaks when the specified events occur at the same time.
- OR
The program breaks when one of the specified events occurs.
- STATE TRANSITION
The program breaks when the state transition diagram goes into the break state.

For each event, a pass count (number of passing) is specifiable (1-255). When "AND" (same time) is specified for Combination, you can not specify the pass count (fixed to one).
 When you have finished setting the combinatorial event condition, click the "Set" button.

3.7 Trace Window

The trace window is used to show the results of real-time trace measurements.

(1) Trace window

1) Opening the hardware break point setup dialog box



Trace window
Clicking this button opens the trace window.

2) Trace window

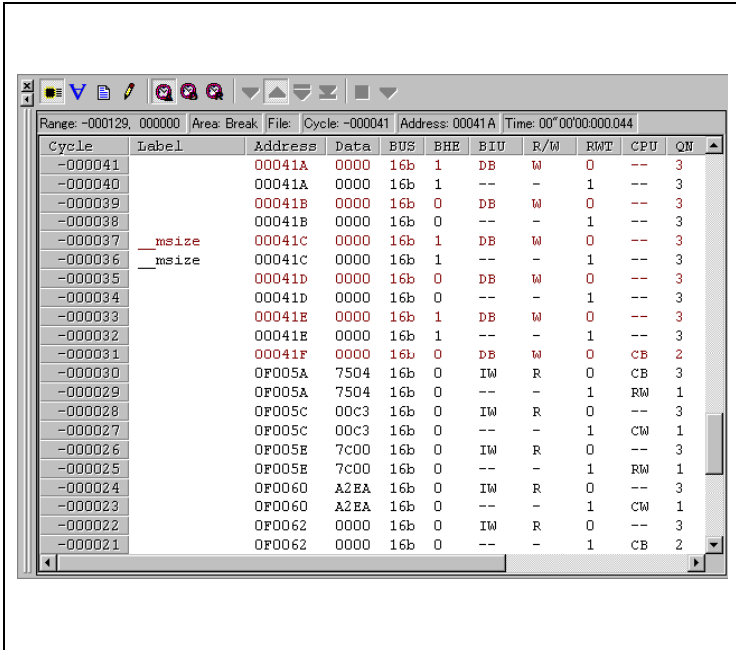

Trace window
The trace window is used to show the results of real-time trace measurements. It has the following four display modes:

- Bus mode
Bus information per cycle can be inspected. The contents are displayed in order of execution paths.
- Disassemble mode
The execution paths of the executed instructions can be inspected. The contents are displayed in order of execution paths.
- Data access mode
Data read/write cycles can be inspected
- Source mode
The execution paths of the source program can be inspected.

The trace window shows the measurement result when a real-time trace measurement has finished. The trace window remains blank until the real-time trace measurement in progress finishes.

3) Trace Window (Bus mode display)

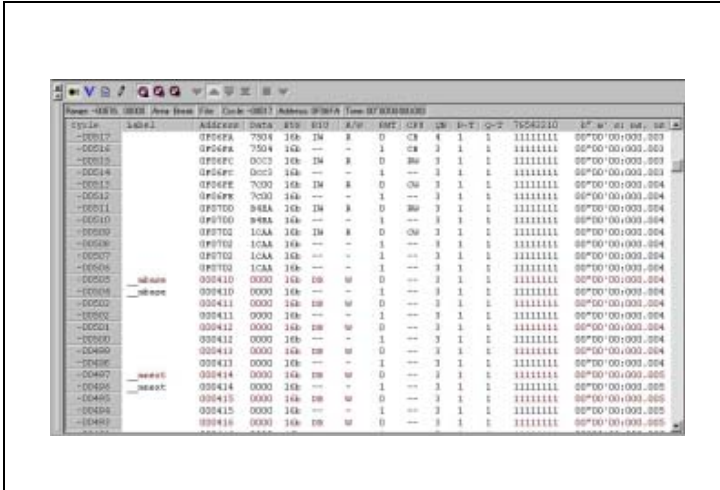

4) Trace Window (Disassemble mode display)

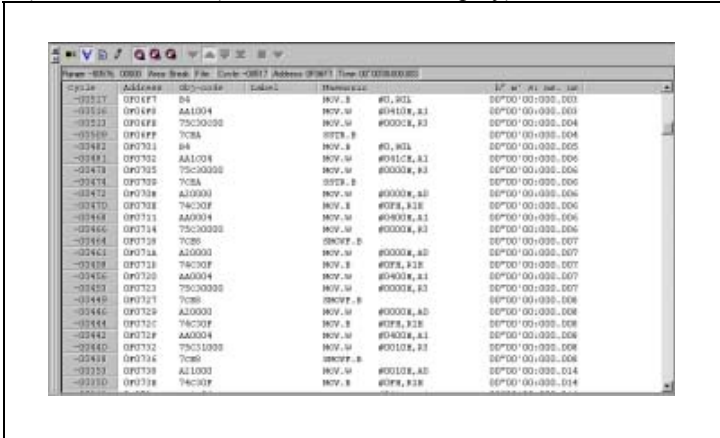

5) Trace Window (Source mode display)

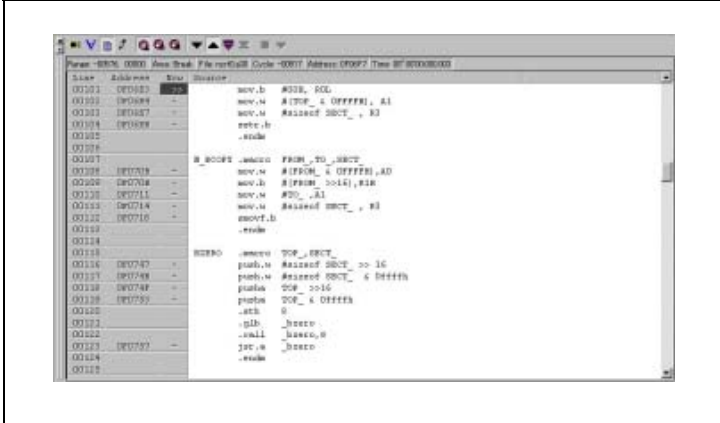

6) Trace Window (Data access mode display)

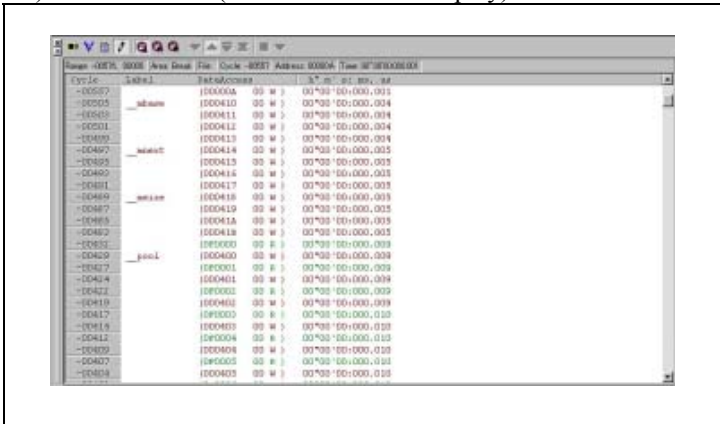

Explanation of the trace window (bus display)

Shows the status of the address bus.

- Address

Shows the status of the address bus.

- Data

Shows the status of the data bus.

- BUS

Shows the width of the external data bus. In the present emulator, only "16b" for 16 bits wide bus is displayed.

- BHE*

Shows the status (0 or 1) of the BHE (Byte High Enable) signal. If this signal = 0, the odd-address data is valid.

- BIU

Shows the status between the BIU (Bus Interface Unit) and memory or I/O.

Symbol Status

- : No change (non-active)

DMA : Data access except for CPU

INT : Interrupt acknowledge cycle

IB : Instruction code read (bytes) by CPU

DB : Data access (bytes) by CPU

IW : Instruction code read (words) by CPU

DW : Data access (words) by CPU

- R/W

Shows the status of the data bus. Displayed as "R" for Read, "W" for Write, and "-" for no access.

- RWT

This is the signal to indicate a valid bus cycle. When valid, RWT = 0. The Address, Data, and the BIU signals are effective when this signal is 0.

- CPU

Shows the status between the CPU and BIU (Bus Interface Unit).

Symbol Status

CB : Op-code read (bytes)

RB : Operand read (bytes)

QC : Clears instruction queue buffer

CW : Op-code read (words)

RW : Operand read (words)

- QN

Shows the byte count stored in the instruction queue buffer. The display range is 0 to 4.

- 76543210

Shows the level of external trace signal input cable EXTIN0 to EXTIN7.

- h" m" s: ms. us

Shows the elapsed time after starting the user program.

(2) Suspending and resuming trace measurement

1) Suspending trace measurement

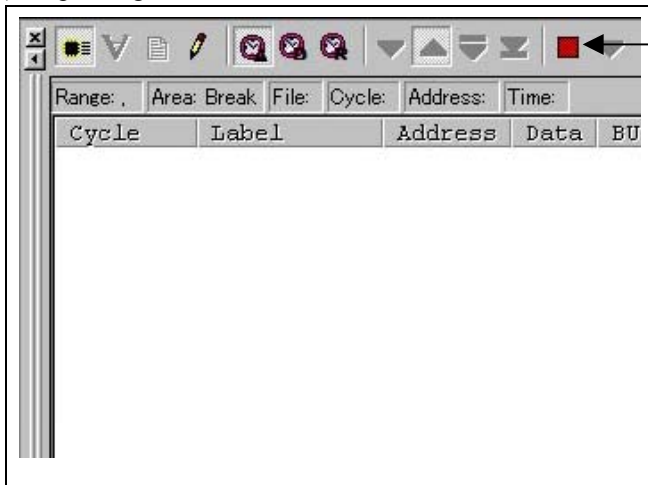

Suspend
Click this toolbar button to suspend the trace measurement in progress.

2) Resuming trace measurement

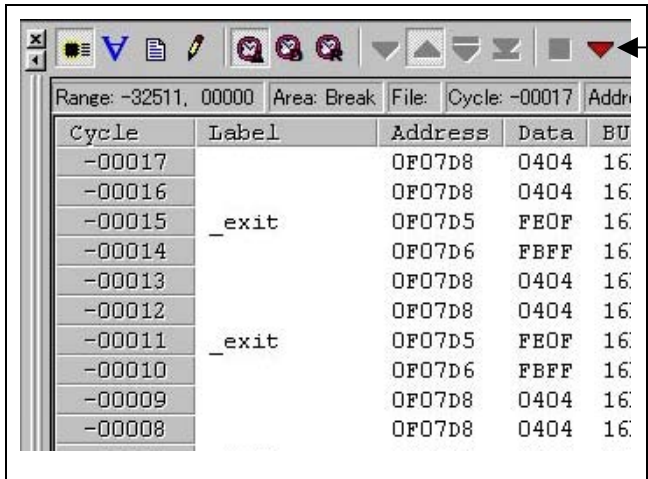

Re-Start
Click this toolbar button to resume the trace measurement in progress.

(3) Trace point setup window

1) Trace point setup window

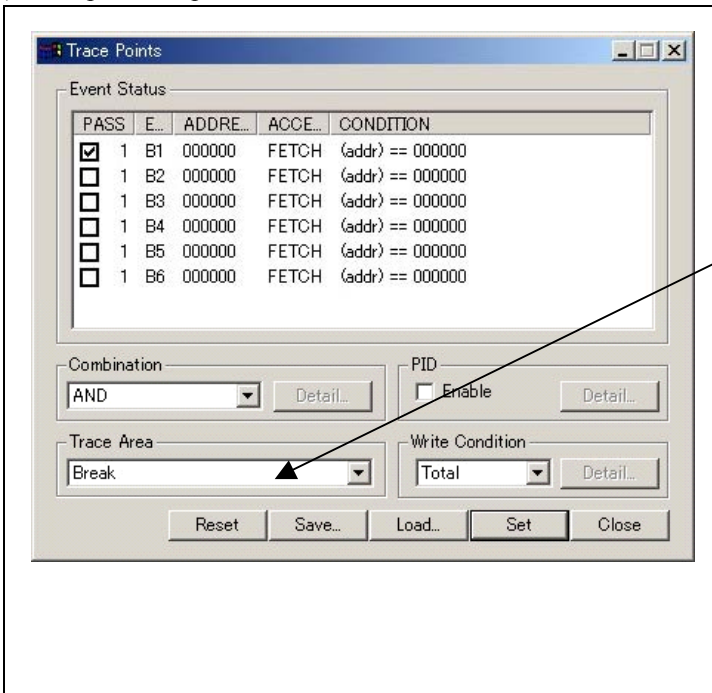

Trace Point Setting Window in initial state

 Clicking this toolbar button opens the trace point setting window.

You can set events in the same way as for the hardware breakpoints.

Specifying a trace range

You can specify a trace range for the trace event.

- Break
32K cycles of instruction execution before the user program stopped is recorded.
- Before
32K cycles of instruction execution before a trace point condition was met is recorded.
- About
16K cycles of instruction execution before and after a trace point condition was met is recorded.
- After
32K cycles of instruction execution after a trace point condition was met is recorded.
- Full
32K cycles of instruction execution after a trace began is recorded.

2) Setting the trace write condition

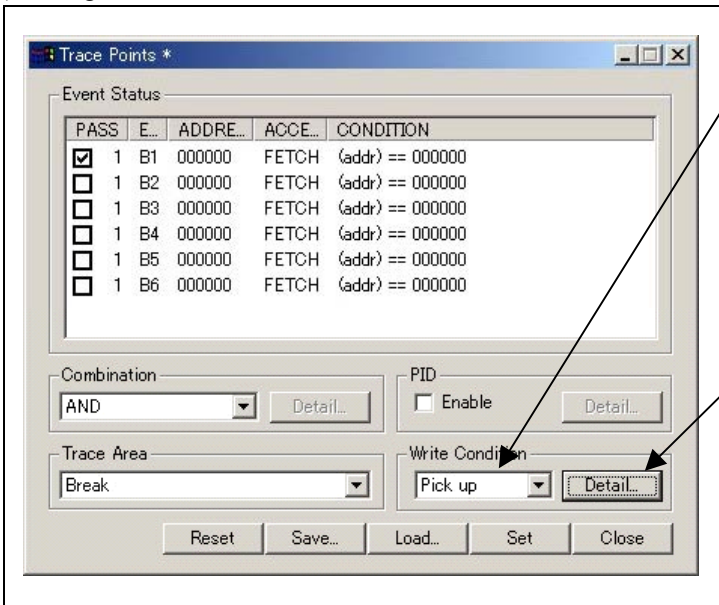

Setting the trace write condition

You can specify a condition for the cycles to be written into the trace memory.

- Total
All cycles are written into memory.
- Pick up
Only the cycles in which the specified condition was met are written into memory.
- Exclude
Only the cycles in which the specified condition was not met are written into memory.

When you have finished setting the trace write condition, click this button. The Realtime-trace Write Condition dialog box shown below will appear.

3) Realtime trace Write Condition dialog box

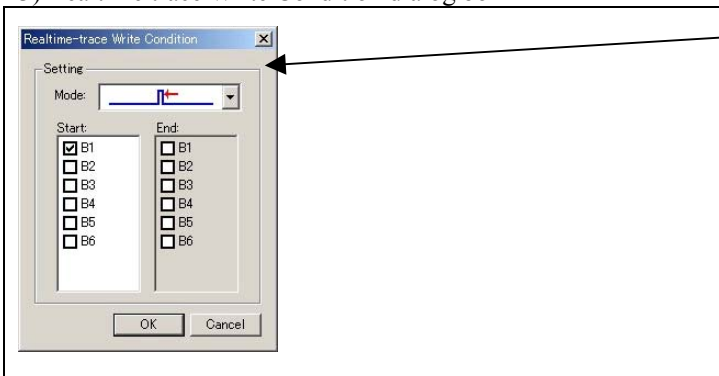

Write mode

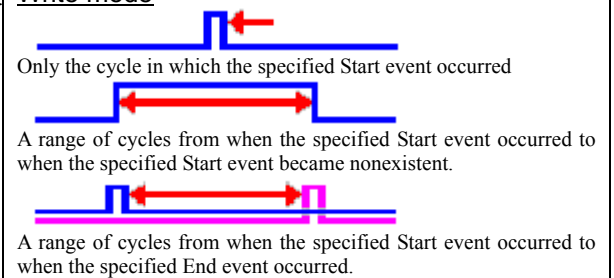

3.8 RAM Monitor Window

This function makes it possible to make reference to the changes in memory contents without impairing the real-time performance for target program execution. The emulator PC4701 system is provided with the 1K-byte RAM monitoring area, which can be arranged in the 1K-byte space from any continuous address.

(1) RAM monitor window

1) RAM monitor window



RAM monitor
Clicking this button opens the RAM monitor window.

2) RAM monitor display area

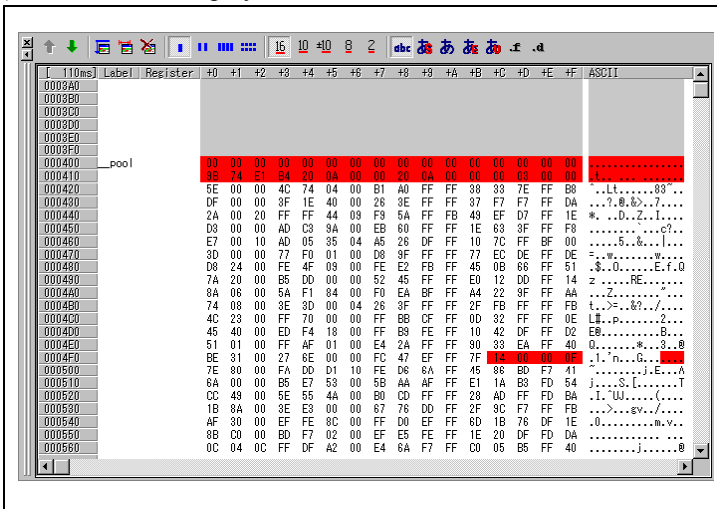

Changing the RAM monitor display area
This window shows changes of memory contents while the user program is executed. This is accomplished by using the real-time RAM monitor function, and the memory contents corresponding to the RAM monitor area are displayed in dump form. The memory contents displayed here are updated at given intervals (by default, every 100 ms) during user program execution.

The background colors of the data display and the code display sections change with the access attribute as described below.

- Green : Addresses accessed for read
- Red : Addresses accessed for write
- White : Addresses not accessed

The background colors can be changed as necessary.

3) RAM monitor area setting dialog box

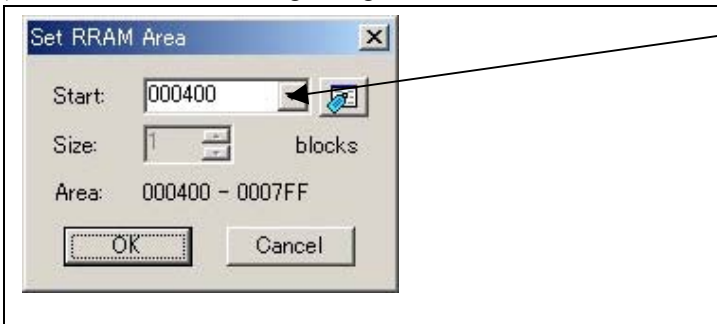

RAM monitor area setting window
You can set the start address of the RAM area to be monitored. The 1 KB of the arbitrary continuous space from the specified start address can be displayed.

4. Hardware Specifications

This chapter describes specifications of this product.

4.1 Target MCU Specifications

Table 4.1 lists the specifications of target MCUs which can be debugged with this product.

Table 4.1 Specifications of target MCUs for the M306H7T3-RPD-E

Item	Description
Applicable MCU	M16C/6H Group M306H7
Evaluation MCU	M306H3FCFP, M306H7FG-TOOL
Applicable MCU mode	Single-chip mode
Emulation Memory	1 MB
Operating voltage	VCC2=4.0--5.5 V, VCC1=3.0V--VCC2 (Xin: when operating without division) VCC2=2.9--5.5 V, VCC1=2.9V--VCC2 (Xin: when operating in a divide-by-16 or 8-mode) VCC2=2.0--5.5 V, VCC1=2.0V--VCC2 (Xcin when operating) *VCC2=2.0V--2.6V operates only in low power dissipation mode.
Max. operating frequency	16MHz (VCC2=4.0--5.5 V, VCC1=3.0V--VCC2)

4.2 Differences between the Actual MCU and Emulator

Differences between the actual MCU and emulator are shown below. When debugging the MCU using this product, be careful about the following precautions.

IMPORTANT

Notes on Differences between the Actual MCU and Emulator:

- Operations of the emulator system differ from those of actual MCUs as listed below.
- Reset condition
 - Set the time for starting up (0.2 Vcc to 0.8 Vcc) 1 μ s or less.
- Initial values of internal resource data of an MCU at power-on
- Internal memories (ROM and RAM) capacities etc.
 - With this emulator system, regardless of ROM and RAM of the MCU you use, all the areas other than the SFR area and a reserved area (addresses 27000h--27FFFh) can be read and written into.
- Oscillator circuit
 - In the oscillator circuit where an oscillator is connected between pins XIN and XOUT, oscillation does not occur because a converter board is used between the evaluation MCU and the user system. It is same for pins XCIN and XCOUT. For notes on when using the oscillator circuit on the user system, refer to "2.9.3 (5) Using the Oscillator Circuit on the User System" (page 41).
- A/D converter function
 - Because a converter board, flexible cable and other devices are used between the evaluation MCU and the user system, the A/D converter operates differently from that of the actual MCU.
- Characteristics of ports P0 to P5
 - This product emulates some I/O ports (P0 to P5). Therefore, the electrical characteristics of these ports differ from those of an actual MCU.
- DBC, single-step and BRK instruction interrupt vector table addresses
 - As the emulator uses the DBC, single-step and BRK instruction interrupt vector table addresses, when reading these addresses, the downloaded data cannot be read (see Table 4.2).

Table 4.2 Vector table addresses for the emulator

Factor of interruption	Vector table addresses	Data read
DBC*1	FFFF4h--FFFF7h	Indefinite
Single-step*1	FFFECh--FFFEFh	Indefinite
BRK instruction	FFFE4h--FFFE7h	Indefinite

*1 Interruption for the emulator only

- Pins P57/CLKout
 - When pins P57/CLKout are used for CLKout function and Fc is selected by Clock output selection in stop mode, CLKout output does not stop.

Note on RESET* Input:

- A low input from the user system to pin RESET* is accepted only while a user program is being executed (only while the RUN status LED on the PC4701's front panel is lit).

Note on NMI* Input:

- A low input from the user system to pin NMI* is accepted only while a user program is being executed (only while the RUN status LED on the PC4701's front panel is lit).

IMPORTANT

Notes on Maskable Interrupts:

- Even if a user program is not being executed (including when run-time debugging is being performed), the evaluation MCU keeps running so as to control the emulation pod. If a maskable interrupt is requested when the user program is not being executed (including when run-time debugging is being performed), the maskable interrupt request cannot be accepted, because the emulator disables interrupts. The interrupt request is accepted immediately after the user program execution is started.
- Take note that when the user program is not being executed (including when run-time debugging is being performed), a peripheral I/O interruption is not accepted.

Note on DMA Transfer:

- With this product, the program is stopped with a loop program to a specific address. Therefore, if a DMA request is generated while the program is stopped, a DMA transfer is executed, but it may not be performed correctly. Also note that the below registers have been changed to generate a DMA transfer as explained here even when the program is stopped.

DMA0 transfer counter registers : TCR0

DMA1 transfer counter registers : TCR1

Note on Pullup Control:

- With this product, ports P0 to P5 are not pulled up by the pullup control register. To pull up the ports P0 to P5, mount the included network resistor (51 kΩ) to the inside of the emulator as occasion demands. How to mount it, refer to "2.9.5 Installing and Removing Network Resistors for Pullup" (page 45).

*Note: Ports P6 to P9 are pulled up by the pullup control registers.

*Note: Pullup control registers themselves can be read and written into properly.

Note on Setting "1" to Protect Bit 2 (PCR2) with Sub Clock:

- When the CPU clock is set to the sub-clock (low-speed mode or low power dissipation mode), even if you enable the PRC2 bit, writing to the register protected by the PRC2 bit (PD9, S3C and S4C registers) cannot be done properly. When you enable the PRC2 bit and write to the register protected by the PRC2 (PD9, S3C and S4C registers), do not set the CPU clock to the sub-clock.

Notes on Setting "1" to Protect Bit 2 (PRC2) in Division by 2 Mode:

- Under the following conditions, even if you enable the PRC2 bit, writing to the register protected by the PRC2 bit (PD9, S3C and S4C registers) cannot be done properly.
 - (1) Between when stop mode is released and when a hardware reset is executed
 - (2) Between when low power dissipation mode is enabled and when a hardware reset is executed
- Therefore, if the condition (1) or (2) applies, when you enable the PRC2 bit and write to the register protected by the PRC2 (PD9, S3C and S4C registers), set the CPU clock neither to the main clock in division by 2 mode nor to the on-chip oscillator clock in division by 2 mode.

Note on the Input Thresholds for the Pins P1_5/INT3, P1_6/INT4 and P1_7/INT5

- With this product, regarding pins P1_5/INT3, P1_6/INT4 and P1_7/INT5, a device which port or data bus inputs to and a device which INT interrupt inputs to are different as follows:
 - Device which port or data bus inputs to: Port emulation FPGA (input level: TTL)
 - Device which INT interrupt inputs to: Evaluation MCU for emulating peripheral functions (input level: CMOS Schmidt)
- Therefore, the port input level can be read as "H" immediately after an INT interrupt (falling), and the port input level can be read as "H" immediately before an INT interrupt (rising).

Note on Final Evaluation:

- Be sure to evaluate your system with an evaluation MCU. Before starting mask production, evaluate your system and make final confirmation with a CS (Commercial Sample) version MCU.

4.3 Connection Diagram

Figure 4.1 shows a connection diagram of the M306H7T3-RPD-E. This connection diagram mainly shows the interface section. The circuits not connected to the user system such as the emulator's control system are omitted. The signals not shown in Figure 4.1 connect the evaluation MCU and the user system directly.

Tables 4.3 to 4.4 show IC electric characteristics of this product for reference purposes.

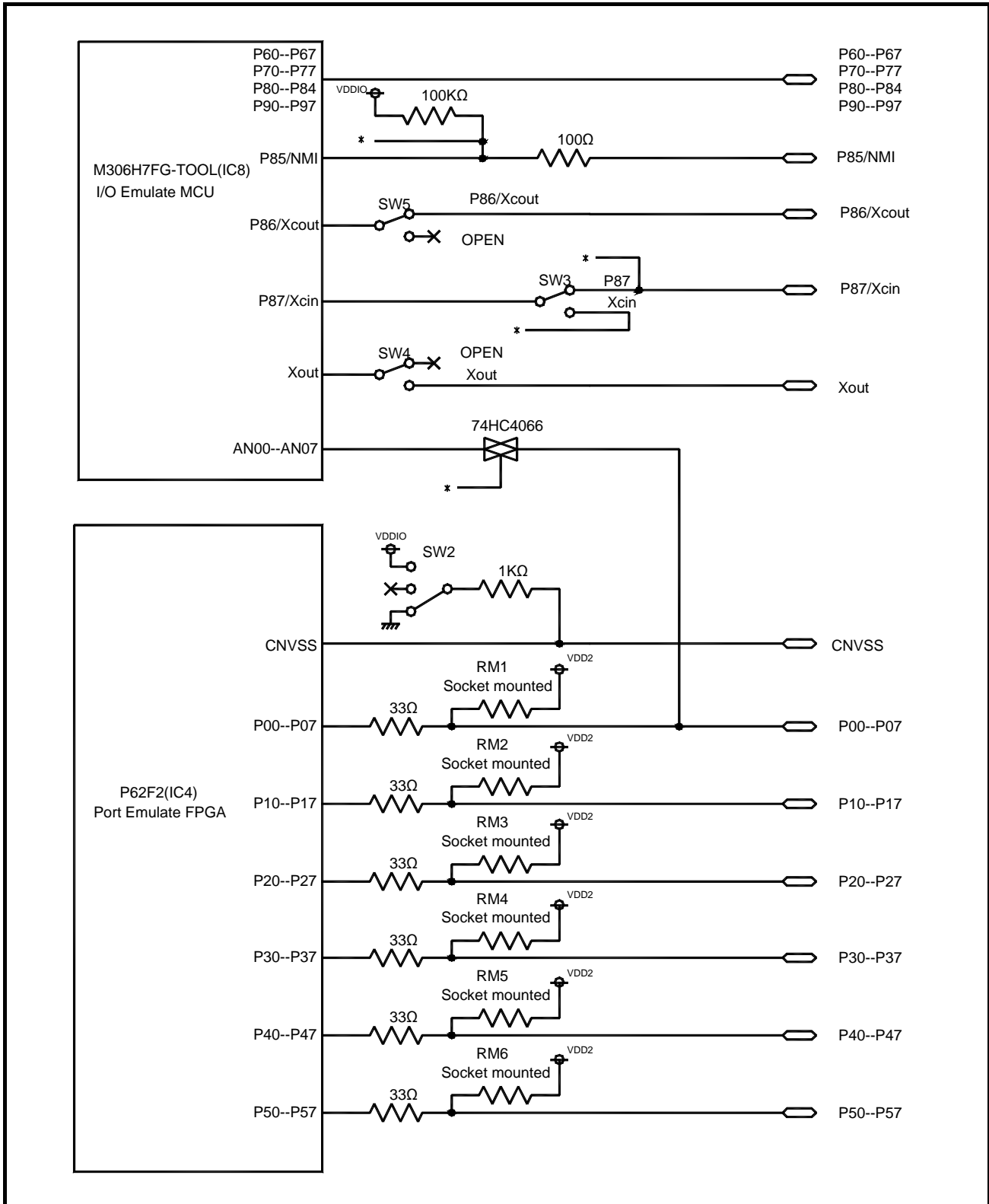

Figure 4.1 Part of the connection diagram of the M306H7T3-RPD-E

Table 4.3 Electrical characteristics of the 74HC4066

Symbol	Item	Condition	Standard values			Unit
			Min.	Standard	Max.	
R _{ON}	ON resistor	V _{CC} =4.5V	-	96	170	Ω
ΔR _{ON}	ON resistor difference	V _{CC} =4.5V	-	10	-	
I _{OFF}	Leak current (Off)	V _{CC} =12.0V	-	-	±100	nA
I _Z	Leak current (On, output: open)	V _{CC} =12.0V	-	-	±100	

Table 4.4 Electrical characteristics of the Port Emulation FPGA

Symbol	Item	Condition	Standard values			Unit
			Min.	Standard	Max.	
V _{IH}	High level input voltage		2.0	-	5.5	V
V _{IL}	Low level input voltage		-0.5	-	0.8	
V _{OH}	High level output voltage	I _{OH} =-8mA DC, V _{CC} =4.75V	2.4	-	-	
		I _{OH} =-8mA DC, V _{CC} =3.00V	2.4	-	-	
V _{OL}	Low level output voltage	I _{OL} =8mA DC, V _{CC} =4.75V	-	-	0.45	
		I _{OL} =8mA DC, V _{CC} =3.00V	-	-	0.45	
I _I	Input leak current	V _I =V _{CC} or GND	-10	-	10	μA
I _{OZ}	Leak current (Tristate)	V _O =V _{CC} or GND	-40	-	40	μA
C _{IN}	I/O pin input capacitance	V _{IN} =0V, f=1.0MHz	-	-	8	pF

4.4 External Dimensions

4.4.1 External Dimensions of the Emulation Pod

Figure 4.2 shows external dimensions of the M306H7T3-RPD-E.

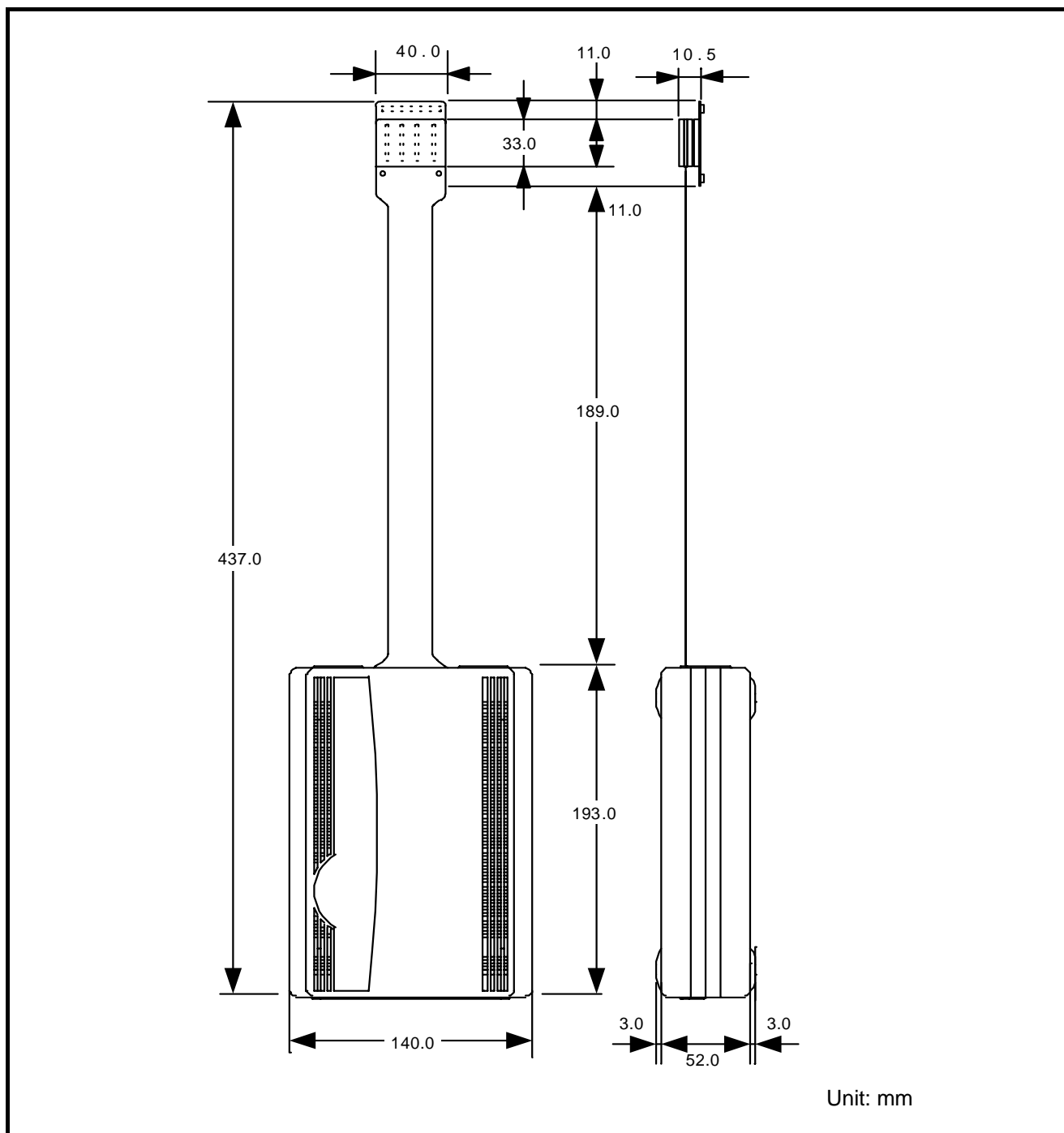

Figure 4.2 External dimensions of the emulation pod

4.4.2 External Dimensions of the M30800T-PTC

Figure 4.3 shows external dimensions of the converter board M30800T-PTC for a 100-pin LCC (included with the M306H7T3-RPD-E).

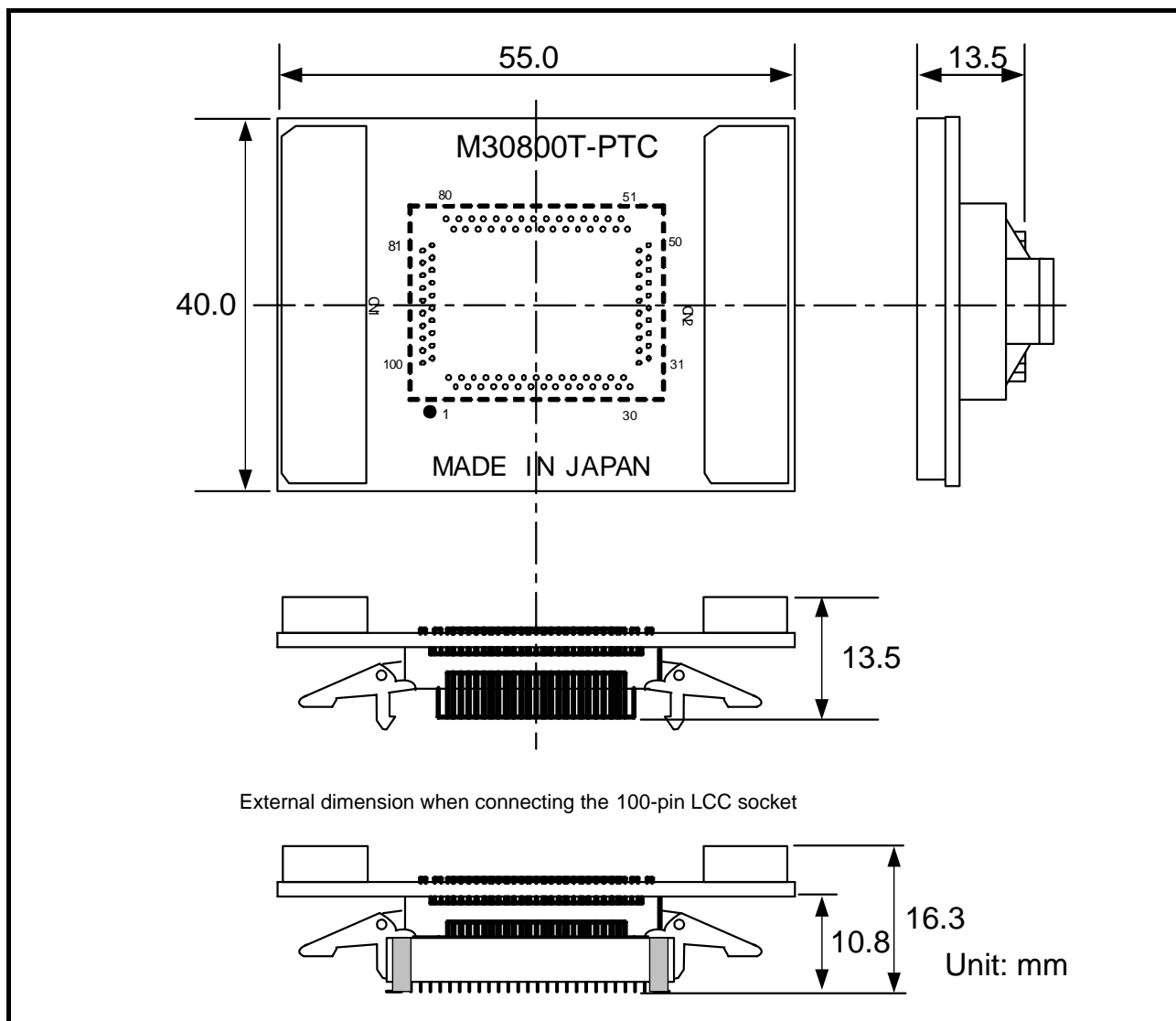

Figure 4.3 External dimensions of the M30800T-PTC

4.5 Notes on Using This Product

Notes on using this product are listed below. When debugging the MCU using the emulator, be careful about the following precautions.

IMPORTANT

Note on the Version of the Emulator Debugger:

- Be sure to use this product with one of the following emulator debuggers.
 1. M16C PC4701 Emulator Debugger
 2. M3T-PD30 V8.20 Release 1 or later

Note on Selecting the MCU File:

- It is necessary to make an MCU file which contains information such as, SFR area, internal RAM area and internal ROM area, etc. to use this product. For creating an MCU file, see "3.1 Making an MCU File" on page 48. For each memory map of MCU, refer to its data sheet.

Note on Malfunctions in the PC4701 System

- If the emulator malfunctions because of interference like external noise, do the following to remedy the trouble
 - (1) Press the RESET switch on the emulator upper panel.
 - (2) If normal operation is not restored after step (1), shut OFF power to the emulator once and then reactivate it.

Notes on Downloading Firmware:

- Before using this product for the first time, it is necessary to download the dedicated firmware (control software built into the PC4701). Please note that, to do this, it is necessary to start up the emulator main unit in maintenance mode. For firmware download procedures, see "2.6.2 Downloading Firmware in Maintenance Mode" (page 28). Once the firmware has been downloaded, the product can be used by simply turning on the power.
- Do not shut off the power while downloading the firmware. If this happens, the product will not start up properly. If power is shut off unexpectedly, redownload the firmware in maintenance mode.
- Be sure to disconnect the user system before downloading the firmware.

Notes on the Self-check:

- If the self-check does not result normally (excluding target status error), the emulation pod may be damaged. Then contact your local distributor.
- Be sure to disconnect the user system before executing the self-check

Note on Quitting the Emulator Debugger:

- To restart the emulator debugger after it ends, always shut power to the emulator off once and wait about 10 seconds, then turn the power on again.

IMPORTANT

Note on Clock Supply to the MCU:

- A clock supplied to the evaluation MCU is selected by the Clock tab in the Init dialog box of the emulator debugger.
 - (1) When Internal is selected:

A clock generated by the oscillation circuit in the emulation pod is supplied to the evaluation MCU. The clock is continually supplied to the evaluation MCU regardless of "user system clock status" and "user program execution status"
 - (2) When External is selected:

Clock supply to the evaluation MCU depends on oscillation status (oscillate/off) of the user system.

Note on Setting the Work Area When Starting Up the Emulator Debugger:

- With this product, the emulator uses 54 bytes as a work area in emulation memory. Set the work area address at 10000h. For more details, see "3.2 Setting the Work Area" (page 48).

Note on Stack Area:

- With this product, a maximum 7 bytes of the user stack is consumed. Therefore, ensure the +7 bytes maximum capacity used by the user program as the user stack area. If the user stack does not have enough area, do not use areas which cannot be used as stack (SFR area, RAM area which stores data, or ROM area) as a work area. Using areas like this is a cause of user program crashes and destabilized emulator control.

Notes on MAP References and Settings:

- For details on referencing and setting MAP information, see the emulator debugger user's manual. Make settings as follows:
 - (1) MAP = INT

The emulation memory inside this product becomes effective.
Set this at MCU internal ROM debugging.
 - (2) MAP = EXT

The emulation memory inside this product is not used.
Set this where the MCU internal resource (SFR) or resources on the user system are used.
- Be sure to set the work area as MAP = INT.

Note on Operation When Not Executing the User Program:

- With this product, bit 7 of processor mode register 1 (wait bit PM17) is forcibly set to "1" (with wait) when the user program is not executed (e.g. when the program is stopped or when run-time debugging is being performed). Therefore, if the external area set to 0 wait is accessed by other than the user program (such as debugging operation), one wait is inserted. However, when wait bit PM17 is referenced by the dump window etc. the value set during user program execution is displayed.

Note on Stop and Wait Modes:

- Do not single step an instruction shifting to stop or wait mode. It may cause communication errors..

Note on Watchdog Function:

- The MCU's watchdog timer can be used only while programs are being executed. To use it otherwise, disable the watchdog timer.

IMPORTANT

Note on M1 (Mode Selection Input) Pin:

- As the evaluation MCU in this product and the M1 pin of the user system are not connected, this product is not affected by the status ("H", "L" or "OPEN") of the M1 pin of the user system. Be sure to check the status of the M1 pin when evaluating with an actual MCU.

Note on Reading Internal Resources of the MCU:

- When the registers listed in Table 4.5 are read with an emulator, those results will be the following (the data in the MCU are not effected).
 - (1) Results of real-time trace
The data values of the cycles read are not displayed correctly.
 - (2) Real-time RAM monitor
The data values read are not displayed correctly.

Table 4.5 Registers and symbols not displayed normally

Register	Symbol
DMA source pointers 0, 1	SAR0, SAR1
DMA destination pointers 0, 1	DAR0, DAR1
DMA transfer counters 0, 1	TCR0, TCR1
DMA control registers 0, 1	DM0CON, DM1CON

Note on Protect Register:

- The protect is not canceled when bit 2 of protect register PRCR (PRC2), which enables writing into the port P9 direction register and the SI/Oi control register, is changed with the below procedure.
 - (1) Step execution of the "instruction for setting ("1") PRC2"
 - (2) Execution from the instruction setting "1" to PRC2 where a software breakpoint is set
 - (3) Setting the break point from the "instruction for setting ("1") PRC2" to when the "setting the port P9 direction register and the SI/Oi control register"
 - (4) Setting ("1") PRC2 from the Memory Window or Script Window

Note on Breaks:

- The area displaying break points in the program window of the emulator debugger shows the following breaks.
 - (1) Software break
This is a debugging function which generates a BRK interruption by changing an instruction at a specified address to a BRK instruction (00h) to break a program immediately before the system executes an instruction at a specified address. The instruction at the preset address will not be executed.
 - (2) Hardware break
This is a debugging function which breaks a program by setting the detection of an execution of an instruction at a specified address as a break event. The program will break after the instruction at the specified address is executed.

Notes on Software Breaks:

- Software breaks change the instruction at a specified address to a BRK (00h). Therefore, take note that when you reference the result of a trace in bus mode, "00h" is displayed.
- The BRK instruction can be used for the emulator only. You cannot use it in a user program.
- It is not possible to use a software break and a hardware break at the same time. If doing so, it may not operate normally.
- In the area where the MAP setting is EXTERNAL, software breaks cannot be used.

IMPORTANT

Note on Power Supply to the User System:

- Pins Vcc1 and Vcc2 are connected to the user system to observe the voltage. Therefore, the power is not supplied to the user system from the emulator, design your system so that the user system is powered separately.
 - (1) The voltage of the user system should be within the operating range of the evaluation MCU.
 - (2) Do not change the voltage of the user system after turning on the power.

Notes on Address-Match Interrupts:

- To debug address-match interrupts, set a software break or hardware break at the top address of the address-match interrupt process. If you set a software break or hardware break at an address where an address-match interrupt occurs, the program may run out of control.
- When an address at which an address-match interrupt occurs is executed in single-step mode, the program stops after executing the first instruction after returning from the address-match interrupt processing.

Note on Accessing Addresses 00000h and 00001h:

- With the M16C/60 Series MCUs, when a maskable interrupt is generated, the interrupt data (interrupt number and interrupt request level) stored in addresses 00000h and 00001h are read out. Also, the interrupt request bit is cleared when address 00000h or 00001h is read out. Consequently, when the address 00000h readout instruction is executed or when address 00000h or 00001h is read out in the cause of a program runaway, a malfunction occurs in that the interrupt is not executed despite the interrupt request, because the request bit of the highest priority interrupt factor enabled is cleared. For this malfunction, when the reading out to the address 00000h or 00001h is generated excluding the interrupt, the LED (yellow) lights up to alarm. When this LED lights, there is a possibility of wrong access, therefore check the program. This LED is turned off by the system reset switch of the emulator main unit.

Note on Debugging Operations After Releasing a Reset from the Target:

- Do not execute debugging operations such as setting a software or hardware break, runtime debugging after releasing a reset from the user system until an interrupt stack pointer (ISP) is set in the user program.

5. Troubleshooting

This chapter describes how to troubleshoot when this product does not work properly.

5.1 Flowchart to Remedy the Troubles

Figure 5.1 shows the flowchart to remedy troubles from when power to the emulator is activated until the emulator debugger starts up. Check this while the user system is not connected. For the latest FAQs visit the Renesas Tools Homepage.

<http://www.renesas.com/en/tools>

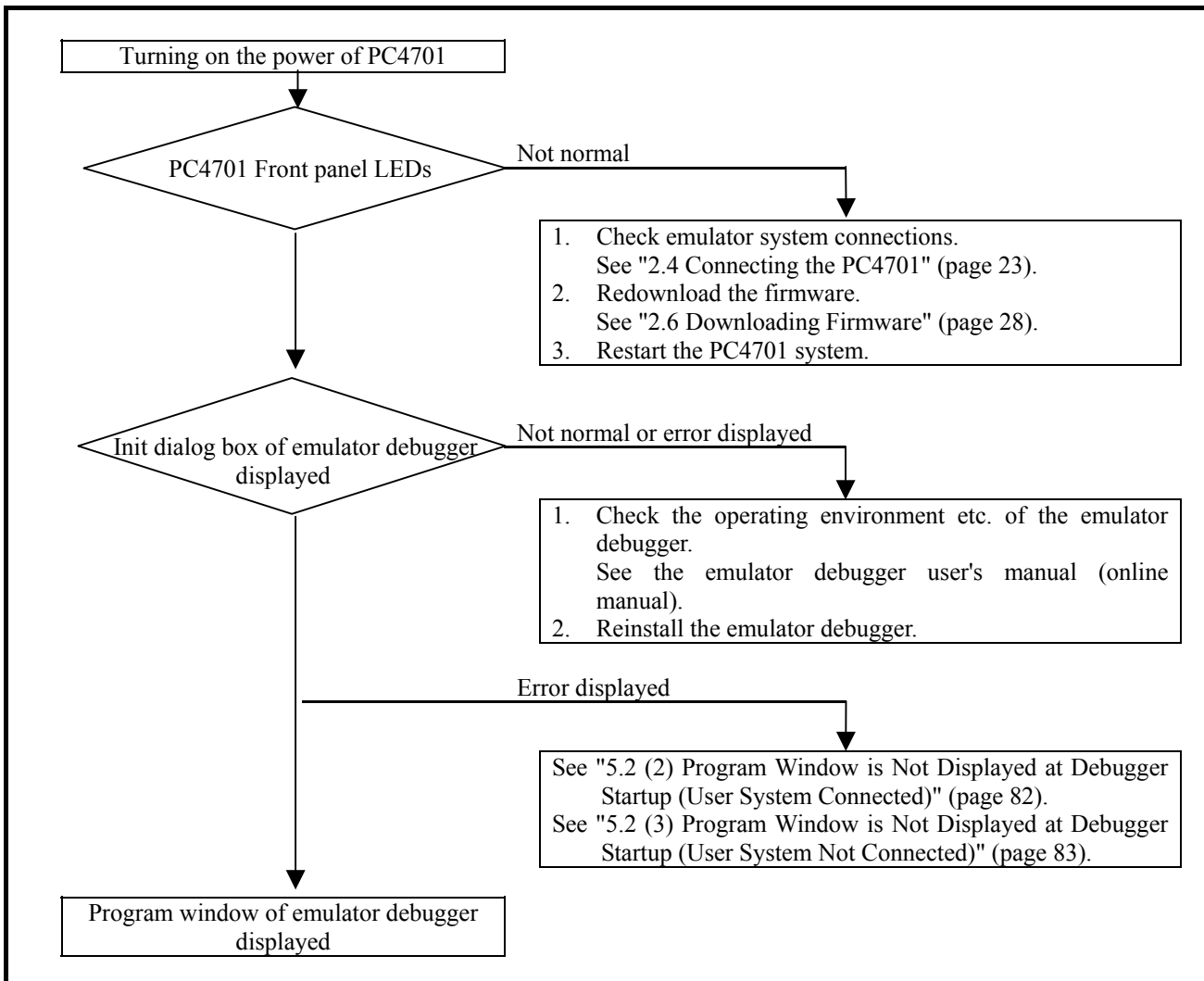

Figure 5.1 Flowchart to remedy troubles

5.2 When the Emulator Debugger Does Not Start Up Properly

(1) When the LED Display of the PC4701 is Abnormal

Table 5.1 LED's abnormal display and its checkpoints

Error	Connection to the user system	Checkpoint
LEDs do not light up.	-	Check that the power cable is connected to the PC4701. <i>See the PC4701 user's manual.</i>
All LEDs remain lit.	-	Check the connection between the PC4701 and this product. <i>See "2.4 Connecting the PC4701" (page 23).</i>
The "POWER" LED of "STATUS OF TARGET" does not light up.	Connected	Check that power (Vcc and GND) is properly supplied to the user system.
The "CLOCK" LED of "STATUS OF TARGET" does not light up.	Disconnected	(1) Check that both the main/sub clocks are not set to "External" in the emulator debugger. <i>See the CLK command of the emulator debugger.</i> (2) Check the oscillator circuit board is mounted on this product and it is oscillating properly. <i>See "2.9.3 Selecting Clock Supply" (page 38).</i>
	Connected	(1) When the clock supply is set to "External", check that the oscillation circuit on the user system is oscillating correctly. (2) Check the switches in the emulation pod are correctly set. <i>See "2.9.4 Switch settings" (page 42)</i>
The "RESET" LED of "STATUS OF TARGET" does not go out.	Connected	Check that the reset pin of the user system is at "H" level.

(2) Program Window is Not Displayed at Debugger Startup (User System Connected)

Table 5.2 Checkpoints of errors when starting up the emulator debugger (user system connected)

Error	Checkpoint
ERROR 16005: Can't connect with the target.	<ol style="list-style-type: none"> (1) Check the connection between the PC4701 and host machine. <i>See the PC4701 User's Manual.</i> (2) Check that the PC4701 is powered on. <i>See the PC4701 User's Manual.</i> (3) Check that all switch settings on the rear of the PC4701 and interface cable settings of the emulator debugger match. <i>See the PC4701 User's Manual and the emulator debugger user's manual (online manual).</i>
ERROR 16211: The version of the emulator and the firmware on the target are not same.	<ol style="list-style-type: none"> (1) Check the connection between the PC4701 and this product. <i>See "2.4 Connecting the PC4701" (page 23)</i> (2) Download the proper firmware. <i>See "2.6 Downloading Firmware" (page 28).</i> (3) Choose the proper MCU file in the Init dialog box. <i>See the emulator debugger user's manual (online manual).</i> (4) Check that the descriptions in the MCU file are correct. <i>See "3.1 Making an MCU File" (page 48).</i>
ERROR 16215: Cannot communicate with the debugging monitor. Execute the RESET command.	<ol style="list-style-type: none"> (1) Check the connection between the PC4701 and this product. <i>See "2.4 Connecting the PC4701" (page 23)</i> (2) Check that the reset pin of the user system is at "H" level. <i>See the MCU specifications.</i> (3) Check that CNVSS is held low. <i>See the MCU specifications.</i> (4) Check that the oscillator circuit of the emulation pod is oscillating properly. <i>See "2.9.3 Selecting Clock Supply" (page 38)</i>
ERROR 16014: Communication ERROR. Can't accept data.	<ol style="list-style-type: none"> (1) Check that the oscillator circuit of the user system is oscillating properly. <i>See "2.9.3 Selecting Clock Supply" (page 38).</i> (2) Check that the PC4701 LEDs at startup show normal operation. <i>See "2.5.3 LED Display When the Emulator Starts Up Normally" (page 27).</i>
ERROR 16231: There was sent undefined data from the emulator.	<p>Check that the emulator debugger has not been started up without shutting down the PC4701. <i>See "4.5 IMPORTANT: Note on Quitting the Emulator Debugger" (page 76).</i></p>

(3) Program Window is Not Displayed at Debugger Startup (User System Not Connected)

Table 5.3 Checkpoints of errors when starting up the emulator debugger (user system not connected)

Error	Checkpoint
ERROR 16005: Can't connect with the target.	<ul style="list-style-type: none"> (1) Check the connection between the PC4701 and host machine. <i>See the PC4701 User's Manual.</i> (2) Check that the PC4701 is powered on. <i>See the PC4701 User's Manual.</i> (3) Check that all switch settings on the rear of the PC4701 and interface cable settings of the emulator debugger match. <i>See the PC4701 User's Manual and the emulator debugger user's manual (online manual).</i>
ERROR 16211: The version of the emulator and the firmware on the target are not same.	<ul style="list-style-type: none"> (1) Check the connection between the PC4701 and this product. <i>See "2.4 Connecting the PC4701" (page 23).</i> (2) Download the proper firmware. <i>See "2.6 Downloading Firmware" (page 28).</i> (3) Choose the proper MCU file in the Init dialog box. <i>See the emulator debugger user's manual (online manual).</i> (4) Check that the descriptions in the MCU file are correct. <i>See "3.1 Making an MCU File" (page 48).</i>
ERROR 16215: Cannot communicate with the debugging monitor. Execute the RESET command	<ul style="list-style-type: none"> (1) Check that switch settings in the emulation pod are correct. <i>See "2.9.4 Switch Settings" (page 42).</i> (2) Check that the oscillator circuit of the emulation pod is oscillating properly. <i>See "2.9.3 Selecting Clock Supply" (page 38).</i>
ERROR 16014: Communication ERROR. Can't accept data.	Check that the PC4701 LEDs at startup show normal operation. <i>See "2.5.3 LED Display When the Emulator Starts Up Normally" (page 27).</i>
ERROR 16231: There was sent undefined data from the emulator.	Check that the emulator debugger has not been started up without shutting down the PC4701. <i>See "4.5 IMPORTANT: Note on Quitting the Emulator Debugger" (page 76).</i>

5.3 How to Request for Support

After checking the items in "5 Troubleshooting", fill in the text file which is downloaded from the following URL, then send the information to your local distributor.

<http://tool-support.renesas.com/eng/toolnews/registration/support.txt>

For prompt response, please specify the following information:

(1) Operating environment

- Operating voltage: _____ [V]
- Operating frequency: _____ [MHz]
- Operating mode: Single-chip, memory expansion, or microprocessor mode
- Clock supply to the MCU: Internal oscillator/External oscillator

(2) Condition

- The emulator debugger starts up/does not start up
- The error is detected/not detected in the self-check
- Frequency of errors: always/frequency (_____)

(3) Problem

6. Maintenance and Guarantee

This chapter describes how to maintenance, repair provisions and how to request for repair.

6.1 User Registration

When you purchase our product, be sure register as a user. For user registration, refer to "User registration" (page 11) of this user's manual.

6.2 Maintenance

- (1) If dust or dirt collects on any equipment of your emulation system, wipe it off with a dry soft cloth. Do not use thinner or other solvents because these chemicals can cause the equipment's surface coating to separate.
- (2) When you do not use this product for a long period, for safety purposes, disconnect the power cable from the power supply.

6.3 Guarantee

If your product becomes faulty within one year after its purchase while being used under good conditions by observing "IMPORTANT" and "Precautions for Safety" described in this user's manual, we will repair or replace your faulty product free of charge. Note, however, that if your product's fault is raised by any one of the following causes, we will repair it or replace it with new one with extra-charge:

- Misuse, abuse, or use under extraordinary conditions
- Unauthorized repair, remodeling, maintenance, and so on
- Inadequate user's system or misuse of it
- Fires, earthquakes, and other unexpected disasters

In the above cases, contact your local distributor. If your product is being leased, consult the leasing company or the owner.

6.4 Repair Provisions

(1) Repair with extra-charge

The products elapsed more than one year after purchase can be repaired with extra-charge.

(2) Replacement with extra-charge

If your product's fault falls in any of the following categories, the fault will be corrected by replacing the entire product instead of repair, or you will be advised to purchase new one, depending on the severity of the fault.

- Faulty or broken mechanical portions
- Flaw, separation, or rust in coated or plated portions
- Flaw or cracks in plastic portions
- Faults or breakage caused by improper use or unauthorized repair or modification
- Heavily damaged electric circuits due to overvoltage, overcurrent or shorting of power supply
- Cracks in the printed circuit board or burnt-down patterns
- Wide range of faults that makes replacement less expensive than repair
- Unlocatable or unidentified faults

(3) Expiration of the repair period

When a period of one year elapses after the model was dropped from production, repairing products of the model may become impossible.

(4) Transportation fees at sending your product for repair

Please send your product to us for repair at your expense.

6.5 How to Make Request for Repair

If your product is found faulty, follow the procedure below to send your product for repair.

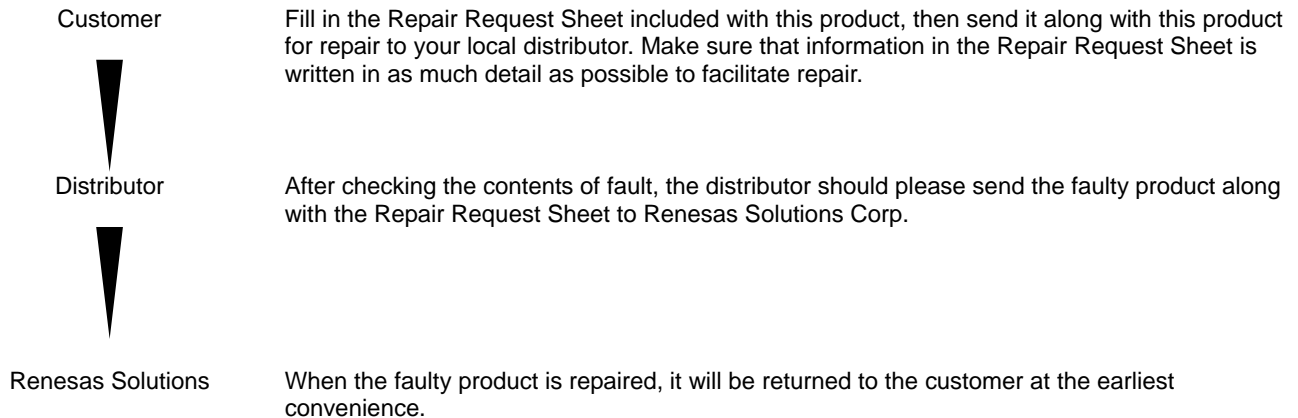

CAUTION

Note on Transporting the Product:



- When sending your product for repair, use the packing box and cushion material supplied with this product when delivered to you and specify handling caution for it to be handled as precision equipment. If packing of your product is not complete, it may be damaged during transportation. When you pack your product in a bag, make sure to use conductive polyvinyl supplied with this product (usually a blue bag). When you use other bags, they may cause a trouble on your product because of static electricity.

Emulation Pod M306H7 for M16C/6H Group
M306H7T3-RPD-E User's Manual

Publication Date: Sep. 01, 2005 Rev.1.00

Published by: Sales Strategic Planning Div.
 Renesas Technology Corp.

Edited by: Microcomputer Tool Development Department
 Renesas Solutions Corp.

M306H7T3-RPD-E
User's Manual

